

# Foreword

This manual was prepared to help you understand the operation and maintenance of your vehicle so that you may enjoy many kilometers (miles) of driving pleasure. Please read through this manual before operating your vehicle.

A separate Warranty Information & Maintenance Booklet explains details about the warranties covering your vehicle.

Your NISSAN dealer knows your vehicle best. When you require any service or have any questions, we will be glad to assist you with the extensive resources available for you.

## IMPORTANT SAFETY INFORMATION

### Reminders for safety!

Follow these important driving rules to help ensure a safe and complete trip for you and your passengers!

- **NEVER drive under the influence of alcohol or drugs.**
- **ALWAYS observe posted speed limits and never drive too fast for conditions.**
- **ALWAYS use your seat belts and appropriate child restraint systems. Preteen children should be seated in the rear seat.**
- **ALWAYS provide information about the proper use of vehicle safety features to all occupants of the vehicle.**
- **ALWAYS review this Owner's Manual for important safety information.**

### When reading the manual

This manual includes information for all options available on this model. Therefore, you may find some information that does not apply to your vehicle.

Throughout this manual, some illustrations may only show the layout for Left-Hand Drive (LHD) models. For Right-Hand Drive (RHD) models, the illustrated shape and location of some components may differ.

All information, specifications and illustrations in this manual are those in effect at the time of printing. NISSAN reserves the right to change specifications or designs without notice and without obligation.

### MODIFICATION OF YOUR VEHICLE

This vehicle should not be modified. Modification could affect its performance, safety or durability, and may even violate governmental regulations. In addition, damage or performance problems resulting from modifications may not be covered under NISSAN warranties.

### Read first — then drive safely

Before driving your vehicle, read this Owner's Manual carefully. This will ensure familiarity with controls and maintenance requirements, assisting you in the safe operation of your vehicle.

Throughout this manual we have used the symbol  followed by the word **WARNING**. This is used to indicate the presence of a hazard that could cause death or serious personal injury. To avoid or reduce the risk, the procedures must be followed precisely.

The symbol  followed by the word **CAUTION** is also used throughout this manual to indicate the presence of a hazard that could

cause minor or moderate personal injury or damages to your vehicle. To avoid or reduce the risk, the procedures must be followed carefully.

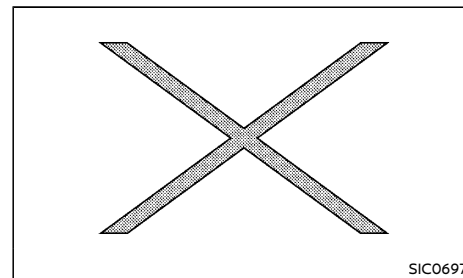

If you see this symbol, it means **“Do not do this”** or **“Do not let this happen”**.

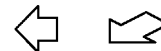

If you see a symbol similar to these in an illustration, it means the arrow points to the front of the vehicle.



Arrows in an illustration that are similar to these indicate movement or action.



Arrows in an illustration that are similar to these call attention to an item in the illustration.

**Air bag warning labels:**



"NEVER use a rearward facing child restraint on a seat protected by an ACTIVE AIRBAG in front of it, DEATH or SERIOUS INJURY to the CHILD can occur."

Be sure to read "Air bag warning labels" (P.1-32).

**ON-PAVEMENT AND OFF-ROAD DRIVING**

This vehicle will handle and maneuver differently from an ordinary passenger car, because it has a higher center of gravity. As with other vehicles with features of this type, failure to operate this vehicle correctly may result in loss of control or an accident.

Be sure to read "On-pavement and off-road driving precautions" (P.5-8).

Bluetooth® is a trademark owned by Bluetooth SIG, Inc., and licensed to Visteon Corporation.



© 2021 NISSAN MOTOR CO., LTD.

# Table of Contents

<b>Illustrated table of contents</b>	<b>0</b>
<b>Safety – seats, seat belts and supplemental restraint system</b>	<b>1</b>
<b>Instruments and controls</b>	<b>2</b>
<b>Pre-driving checks and adjustments</b>	<b>3</b>
<b>Monitor, Heater and air conditioner, and audio system</b>	<b>4</b>
<b>Starting and driving</b>	<b>5</b>
<b>In case of emergency</b>	<b>6</b>
<b>Appearance and care</b>	<b>7</b>
<b>Maintenance and do-it-yourself</b>	<b>8</b>
<b>Technical information</b>	<b>9</b>
<b>Index</b>	<b>10</b>



# 0 Illustrated table of contents

Seats, seat belts and Supplemental Restraint System (SRS) .....	0-2	Instrument panel .....	0-8
Exterior front .....	0-3	Left-Hand Drive (LHD) model .....	0-8
Exterior rear .....	0-4	Right-Hand Drive (RHD) model .....	0-9
Passenger compartment .....	0-5	Meters and gauges .....	0-10
Cockpit .....	0-6	Engine compartment .....	0-12
Left-Hand Drive (LHD) model .....	0-6	YD25DDTi engine .....	0-12
Right-Hand Drive (RHD) model .....	0-7	YS23DDTT engine .....	0-13
		QR25DE engine .....	0-14

## SEATS, SEAT BELTS AND SUPPLEMENTAL RESTRAINT SYSTEM (SRS)

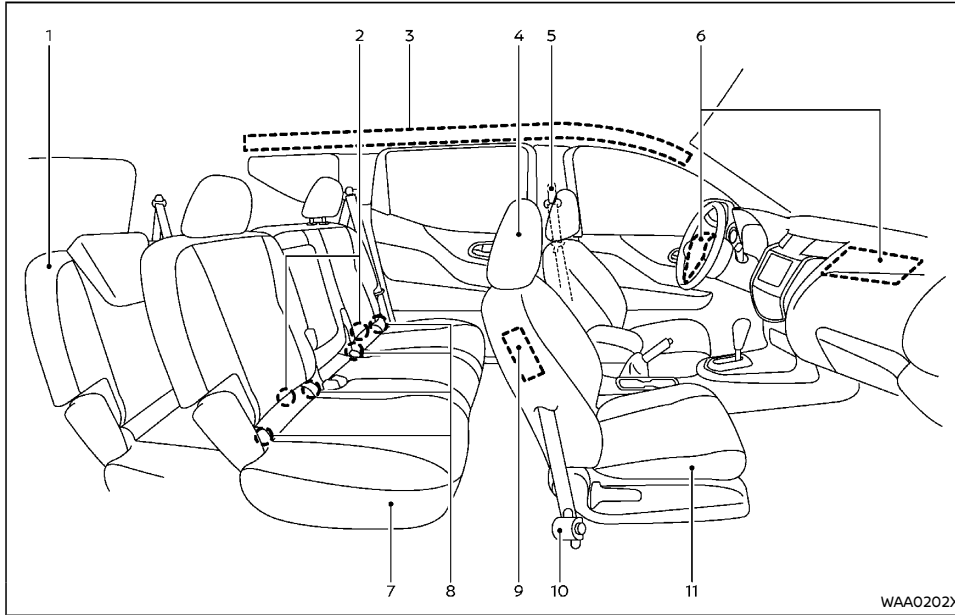

- 1. Third row seats (P.1-6)
  - 2. Child restraint anchor point (for top tether strap child restraint) (P.1-23)
  - 3. Supplemental curtain side-impact air bags\* (P.1-29)
  - 4. Head restraints (P.1-9)
  - 5. Seat belts (P.1-11)
  - 6. Supplemental front-impact air bags (P.1-29)
  - 7. Second row seats (P.1-5)
    - Child restraints (P.1-16)
  - 8. ISOFIX child restraint system (for second row seats) (P.1-22)
  - 9. Supplemental side-impact air bags\* (P.1-29)
  - 10. Pre-tensioner seat belt system (P.1-37)
  - 11. Front seats (P.1-2)
- \*: if equipped

## EXTERIOR FRONT

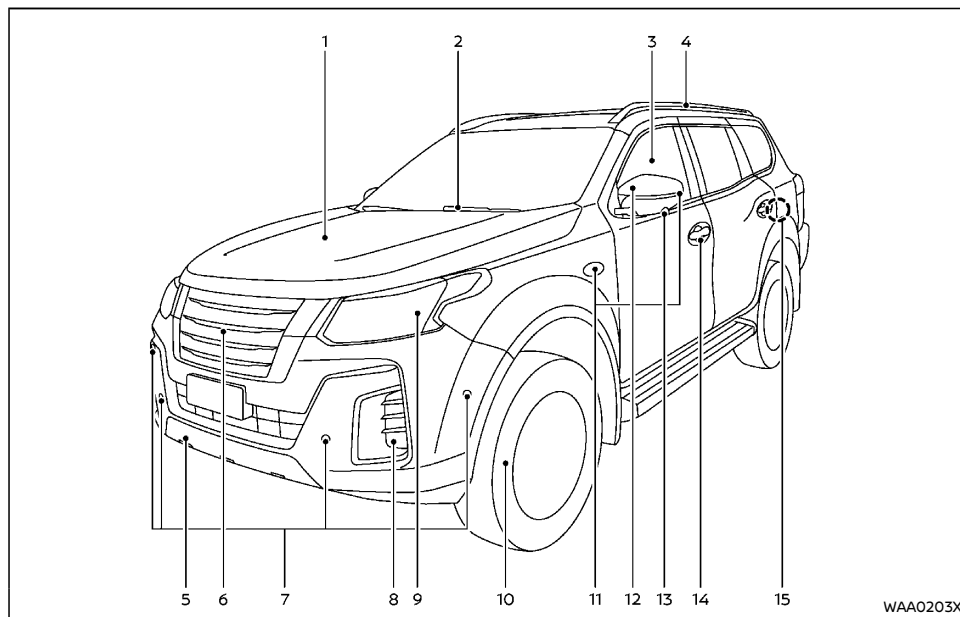

- |  |   |
|--|---|
| <ol style="list-style-type: none"> <li>1. Hood (P.3-18)</li> <li>2. Windshield wipers and washers             <ul style="list-style-type: none"> <li>– Switch operation (P.2-40)</li> <li>– Wiper blade replacement (P.8-20)</li> <li>– Window washer fluid (P.8-21)</li> </ul> </li> <li>3. Windows (P.2-43)</li> <li>4. Roof rack (P.2-49)</li> <li>5. Towing hook*1 (P.6-14)</li> <li>6. Front view camera*2 (P.4-9)</li> </ol> | <ol style="list-style-type: none"> <li>7. Parking (sonar) sensors*2             <ul style="list-style-type: none"> <li>– Camera aiding parking sensor (sonar) function*2 (P.4-17)</li> <li>– Parking (sonar) sensor system*2 (P.5-79)</li> </ul> </li> <li>8. Front fog lights*2 (P.2-39)</li> <li>9. Headlights and turn signal lights (P.2-36)</li> <li>10. Tires             <ul style="list-style-type: none"> <li>– Tire Pressure Monitoring System*2 (P.2-15, P.5-5)</li> <li>– Tires and wheels (P.8-32, P.9-8)</li> </ul> </li> </ol> |
|--|---|

- Flat tire (P.6-2)
11. Side turn signal lights (fender or outside rearview mirror) (P.2-38)
  12. Outside rearview mirrors (P.3-27)
  13. Side view camera\*2 (P.4-9)
  14. Doors
    - Keys (P.3-2)
    - Door locks (P.3-4)
    - Intelligent Key system\*2 (P.3-7)
    - Remote keyless entry system\*2 (P.3-6)
    - Security system (P.3-15)
  15. Child safety rear door locks (P.3-5)
- \*1: The layout illustrated is for the Left-Hand Drive (LHD) model. On the Right-Hand Drive (RHD) model, the towing hook is located on the opposite side.
- \*2: if equipped

## EXTERIOR REAR

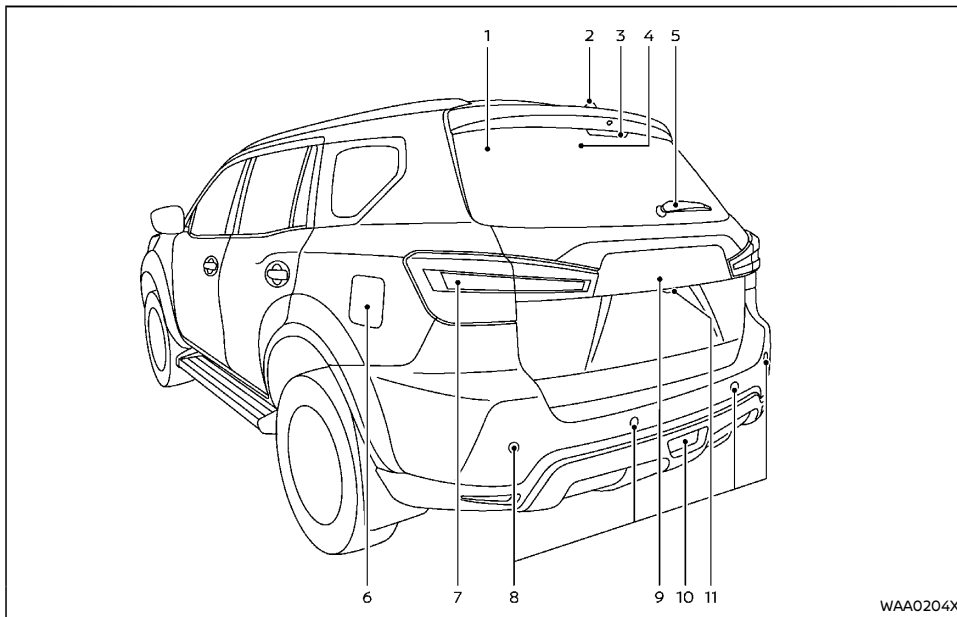

11. Rear view camera\* (P.4-3, P.4-9)

\*: if equipped

- |  |  |
|--|--|
| 1. Rear window defogger (P.2-42)   | 7. Rear combination lights (P.8-29)  |
| 2. Antenna (P.4-46)  | 8. Parking (sonar) sensors*  |
| 3. High-mounted stop light (P.8-29)  | — Camera aiding parking sensor (sonar) function* (P.4-17)  |
| 4. Intelligent Rear View Mirror camera* (P.3-22)   | — Parking (sonar) sensor system* (P.5-79)  |
| 5. Rear window wiper and washer<br>— Switch operation (P.2-41)<br>— Window washer fluid (P.8-21) | 9. Back door (P.3-19)<br>— Intelligent Key system* (P.3-7)<br>— Remote keyless entry system* (P.3-6) |
| 6. Fuel-filler lid (P.3-21)  | 10. Rear fog light* (P.2-39)   |



## PASSENGER COMPARTMENT

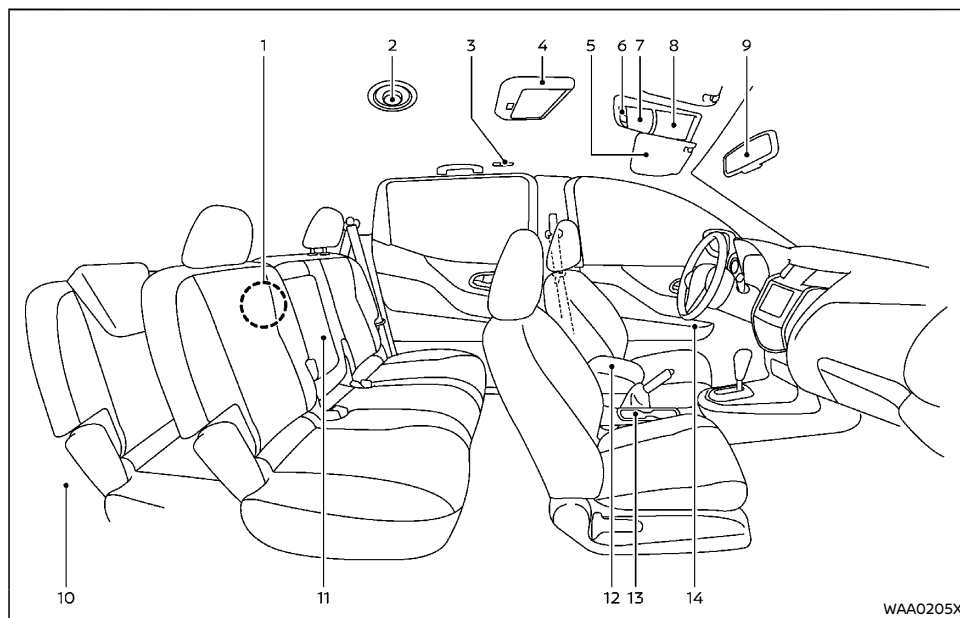

1. Soft bottle holder (third row seats) (P.2-48)
  - HDMI port (left side)\* (P.4-42)
  - USB charging connector (left side)\* (P.2-45)
2. Rear fan speed control dial (P.4-26)
3. Rear personal light (P.2-51)
4. Rear Entertainment System (RES)\* (P.4-40)
5. Sun visors (P.2-50)

6. Map lights (P.2-50)
  - Microphone\* (P.4-47 or \*\*)
7. eCall switch\* (P.1-38)
8. Sunglasses holder (P.2-47)
9. Inside rearview mirror (P.3-22)
  - Intelligent Rear View Mirror\* (P.3-22)
  - Rear view monitor\* (P.4-3)
  - Intelligent Around View Monitor\* (P.4-9)
10. Cargo area
  - Storage (P.2-47)

- Luggage hooks (P.2-49)
  - Power outlet (P.2-44)
11. Rear armrest (second row seats) (P.1-8)
    - Rear cup holders (P.2-48)
  12. Console box (P.2-47)
    - Power outlet (P.2-44)
    - USB charging connector\* (P.2-45)
  13. Cup holders (P.2-48)
  14. Door armrest
    - Power window controls (P.2-43)
    - Power door lock switch (driver's door) (P.3-4)
    - Outside rearview mirror remote control switch (driver's door)\* (P.3-27)
- \*: if equipped  
 \*\*: See the separate NissanConnect Owner's Manual (if equipped).

## COCKPIT

### LEFT-HAND DRIVE (LHD) MODEL

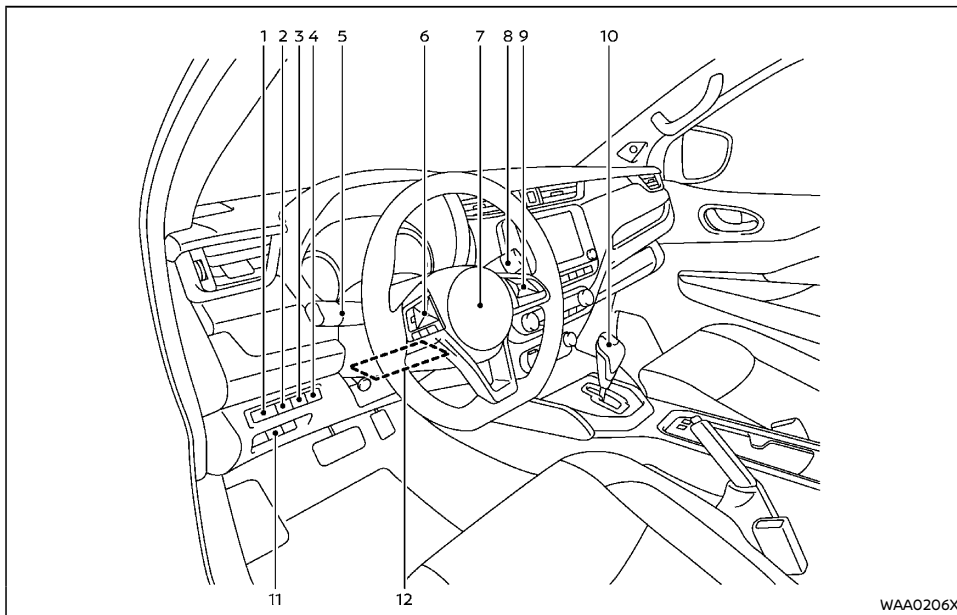

- |   |   |
|---|---|
| 1. Instrument brightness control switch (models with color display) (P.2-11)    | 6. Steering-wheel-mounted controls* (left side)<br>– Audio control (P.4-27 or **) |
| 2. Fuel-filler lid opener switch (P.3-21)                                       | – Vehicle information display control* (P.2-21)                                   |
| 3. TRIP/RESET switch for twin trip odometer (models with color display) (P.2-9) | – Bluetooth® Hands-Free Phone System* (P.4-47 or **)                              |
| 4. Parking sensor (sonar) system switch* (P.5-81)                               | 7. Steering wheel<br>– Horn (P.2-43)  |
| 5. Headlight and turn signal switch (P.2-36)/ Fog light switch* (P.2-39)        |   |

- Driver's supplemental front-impact air bag (P.1-29)
  - 8. Wiper and washer switch (P.2-40)
  - 9. Steering-wheel-mounted controls\* (right side)
    - Cruise control system switches\* (P.5-45)
    - Intelligent Cruise Control (ICC) system switches\* (P.5-47)
    - Bluetooth® Hands-Free Phone System\* (P.4-47 or \*\*)
    - Voice recognition system\*\*
  - 10. Shift lever
    - Automatic Transmission (AT) (P.5-15)
    - Manual Transmission (MT) (P.5-18)
  - 11. Vehicle Dynamic Control (VDC) OFF switch\* (P.5-27)
  - 12. Tilting steering wheel lock lever (P.3-21)
- \*: if equipped  
\*\*: See the separate NissanConnect Owner's Manual (if equipped).

## RIGHT-HAND DRIVE (RHD) MODEL

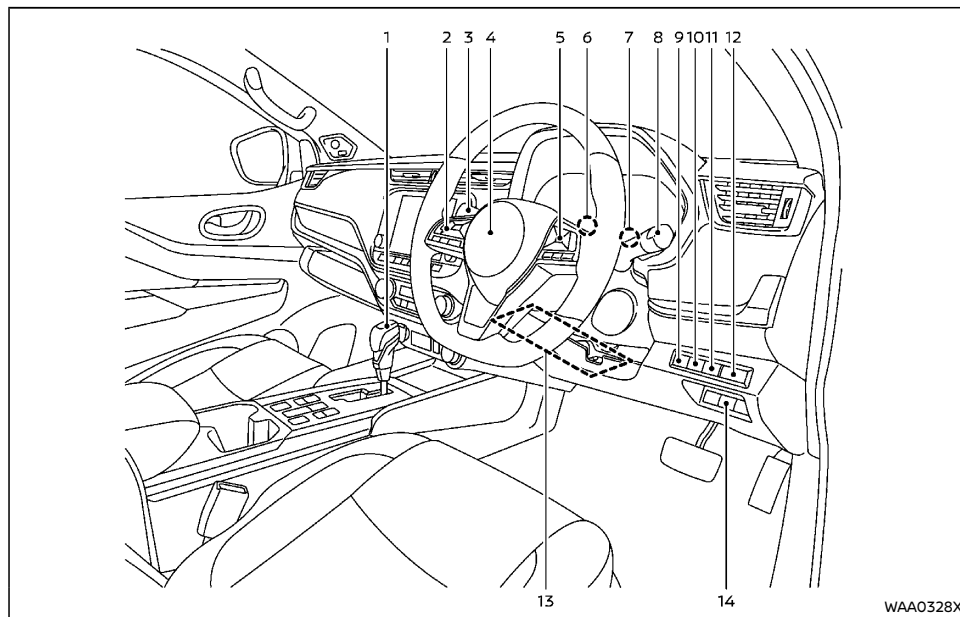

- |  |  |
|--|--|
| <p>1. Shift lever</p> <ul style="list-style-type: none"> <li>– Automatic Transmission (AT) (P.5-15)</li> <li>– Manual Transmission (MT) (P.5-18)</li> </ul> <p>2. Steering-wheel-mounted controls* (left side)</p> <ul style="list-style-type: none"> <li>– Audio control (P.4-27 or **)</li> <li>– Vehicle information display control (P.2-21)</li> <li>– Bluetooth® Hands-Free Phone System*</li> </ul> | <p>(P.4-47 or **)</p> <p>3. Wiper and washer switch (P.2-40)</p> <p>4. Steering wheel</p> <ul style="list-style-type: none"> <li>– Horn (P.2-43)</li> <li>– Driver's supplemental front-impact air bag (P.1-29)</li> </ul> <p>5. Steering-wheel-mounted controls* (right side)</p> <ul style="list-style-type: none"> <li>– Cruise control system switches*</li> </ul> |
|--|--|

(P.5-45)

– Bluetooth® Hands-Free Phone System\* (P.4-47 or \*\*)

– Voice recognition system\*\*

6. Instrument brightness control switch (P.2-11)/Trip computer mode switch (models without color display) (P.2-20)
7. TRIP/RESET switch for twin trip odometer (P.2-9)/Trip computer mode switch (models without color display) (P.2-20)
8. Headlight and turn signal switch (P.2-36)/Fog light switch\* (P.2-39)
9. Parking sensor (sonar) system switch\* (P.5-81)
10. TRIP/RESET switch for twin trip odometer (models with color display) (P.2-9)
11. Fuel-filler lid opener switch (P.3-21)
12. Instrument brightness control switch (models with color display) (P.2-11)
13. Tilting steering wheel lock lever (P.3-21)
14. Vehicle Dynamic Control (VDC) OFF switch\* (P.5-27)

\*: if equipped

\*\* : See the separate NissanConnect Owner's Manual (if equipped).

# INSTRUMENT PANEL

## LEFT-HAND DRIVE (LHD) MODEL

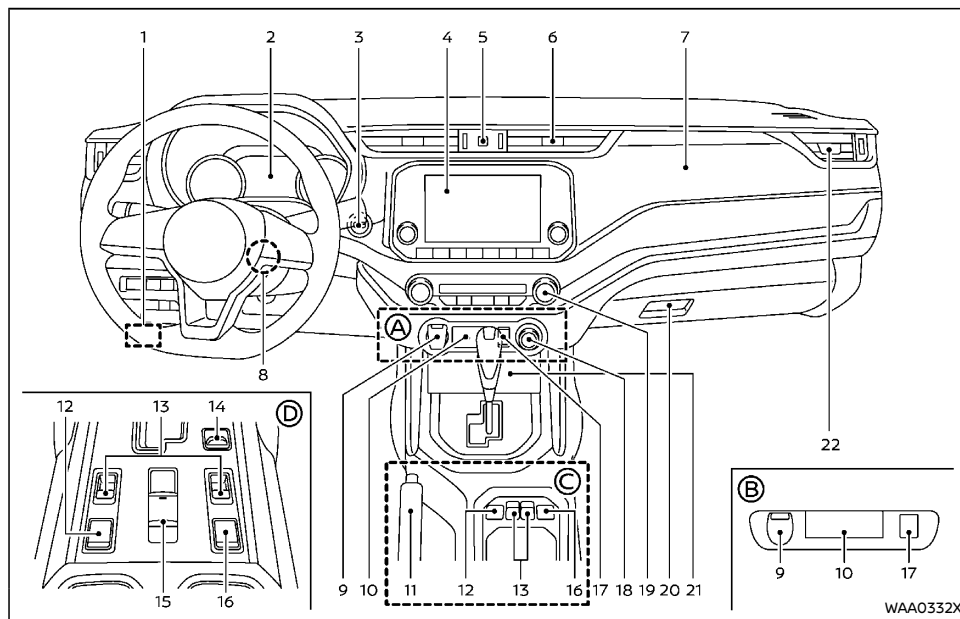

- |  |   |
|--|---|
| <ol style="list-style-type: none"> <li>1. Hood lock release handle (P.3-18)</li> <li>2. Meters and gauges (P.2-7)<br/>— Vehicle information display (P.2-20, P.2-21)</li> <li>3. Push-button ignition switch (models with Intelligent Key system) (P.5-11)</li> <li>4. Audio system* (P.4-27 or **) or Navigation System**<br/>— Rear view monitor* (P.4-3)</li> </ol> | <ol style="list-style-type: none"> <li>5. Hazard indicator flasher switch (P.6-2)</li> <li>6. Center ventilator (P.4-21)</li> <li>7. Front passenger's supplemental front-impact air bag (P.1-29)</li> <li>8. Ignition switch (models without Intelligent Key system) (P.5-10)</li> <li>9. Power outlet (P.2-44)</li> </ol> |
|--|---|

10. Auxiliary (AUX) input jack\* (P.4-39) and USB (Universal Serial Bus) connection port (P.4-38 or \*\*)
  11. Parking brake (lever type)\* (P.3-28)
  12. Differential lock mode switch\* (P.5-26)
  13. Seat tumbling switch\* (P.1-5)
  14. Drive Mode Selector switch\* (P.5-25)
  15. Parking brake (switch type)\* (P.3-28)
  16. Hill descent control switch\* (P.5-28)
  17. Rear cooler switch (P.4-26)
  18. Four-Wheel Drive (4WD) mode switch\* (P.5-19)
  19. Heater and air conditioner control (P.4-22)
  20. Glove box (P.2-47)  
— Fuse box (P.8-27)
  21. Wireless charger\* (P.2-46)
  22. Side ventilator (P.4-21)
- A: 4WD models  
 B: 2WD models  
 C: Models not equipped with electronic parking brake system  
 D: Models equipped with electronic parking brake system  
 \*: If equipped  
 \*\*: See the separate NissanConnect Owner's Manual (if equipped).

## RIGHT-HAND DRIVE (RHD) MODEL

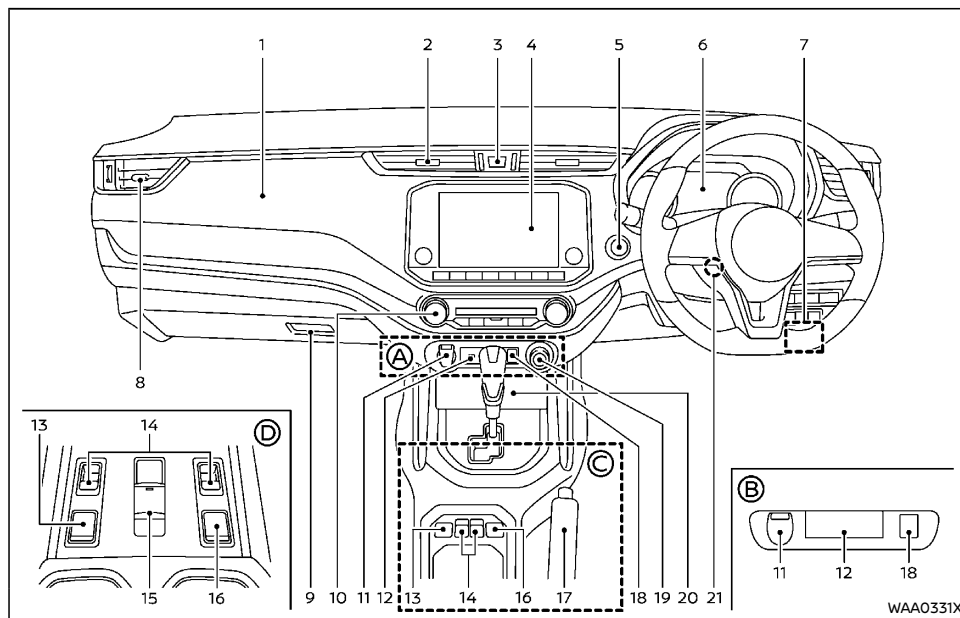

- |  |  |
|--|--|
| <ol style="list-style-type: none"> <li>1. Front passenger's supplemental front-impact air bag (P.1-29)</li> <li>2. Center ventilator (P.4-21)</li> <li>3. Hazard indicator flasher switch (P.6-2)</li> <li>4. Audio system* (P.4-27 or **) or Navigation System**             <ul style="list-style-type: none"> <li>– Rear view monitor* (P.4-3)</li> <li>– Intelligent Around View Monitor* (P.4-9)</li> </ul> </li> </ol> | <ol style="list-style-type: none"> <li>5. Push-button ignition switch (models with Intelligent Key system) (P.5-11)</li> <li>6. Meters and gauges (P.2-7)             <ul style="list-style-type: none"> <li>– Vehicle information display (P.2-20, P.2-21)</li> </ul> </li> <li>7. Hood release handle (P.3-18)</li> <li>8. Side ventilator (P.4-21)</li> <li>9. Glove box (P.2-47)             <ul style="list-style-type: none"> <li>– Fuse box (P.8-27)</li> </ul> </li> </ol> |
|--|--|

10. Heater and air conditioner control (P.4-22)
  11. Power outlet (P.2-44)
  12. USB (Universal Serial Bus) connection port (P.4-38) and Auxiliary (AUX) input jack (P.4-39)
  13. Differential lock mode switch\* (P.5-26)
  14. Seat tumbling switch\* (P.1-5)
  15. Parking brake (switch type)\* (P.3-28)
  16. Hill descent control switch\* (P.5-28)
  17. Parking brake (lever type)\* (P.3-28)
  18. Rear cooler switch (P.4-26)
  19. Four-Wheel Drive (4WD) mode switch\* (P.5-19)
  20. Wireless charger\* (P.2-46)
  21. Ignition switch (models without Intelligent Key system) (P.5-10)
- Ⓐ: 4WD models  
 Ⓑ: 2WD models  
 Ⓒ: Models not equipped with electronic parking brake system  
 Ⓓ: Models equipped with electronic parking brake system
- \*: If equipped  
 \*\*: See the separate NissanConnect Owner's Manual (if equipped).

## METERS AND GAUGES

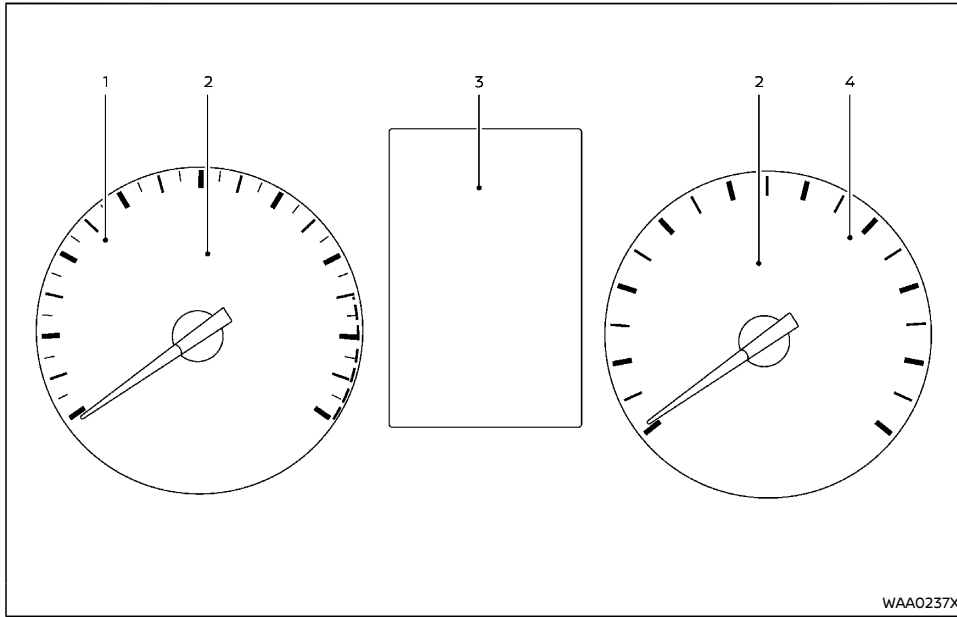

Type A

WAA0237X

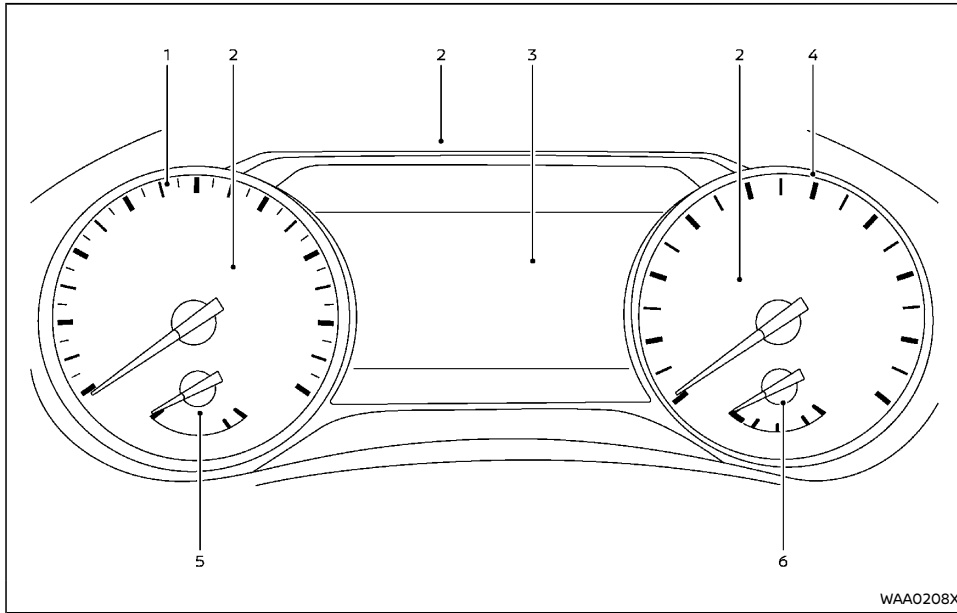

WAA0208X

**Type B**

- |  |   |
|--|---|
| <ul style="list-style-type: none"> <li>1. Tachometer (P.2-9)</li> <li>2. Warning/Indicator lights (P.2-12)</li> <li>3. Vehicle information display (P.2-20, P.2-21)           <ul style="list-style-type: none"> <li>– Engine coolant temperature gauge (models without color display) (P.2-10)</li> <li>– Fuel gauge (models without color display) (P.2-10)</li> <li>– Four-Wheel Drive (4WD) mode indicator* (P.5-19)</li> <li>– Oil control system* (P.2-35)</li> <li>– Odometer/twin trip odometer (P.2-9)</li> </ul> </li> </ul> | <ul style="list-style-type: none"> <li>– Trip computer (P.2-33, P.2-20)</li> <li>– Instrument brightness control (P.2-11)</li> <li>– Automatic Transmission (AT) position indicator (AT model) (P.2-20, P.2-30, P.5-15)</li> <li>4. Speedometer (P.2-9)</li> <li>5. Engine coolant temperature gauge (models with color display) (P.2-9)</li> <li>6. Fuel gauge (models with color display) (P.2-10)</li> </ul> <p>*: if equipped</p> |
|--|---|

## ENGINE COMPARTMENT

### YD25DDTi ENGINE

reservoir is located on the opposite side.

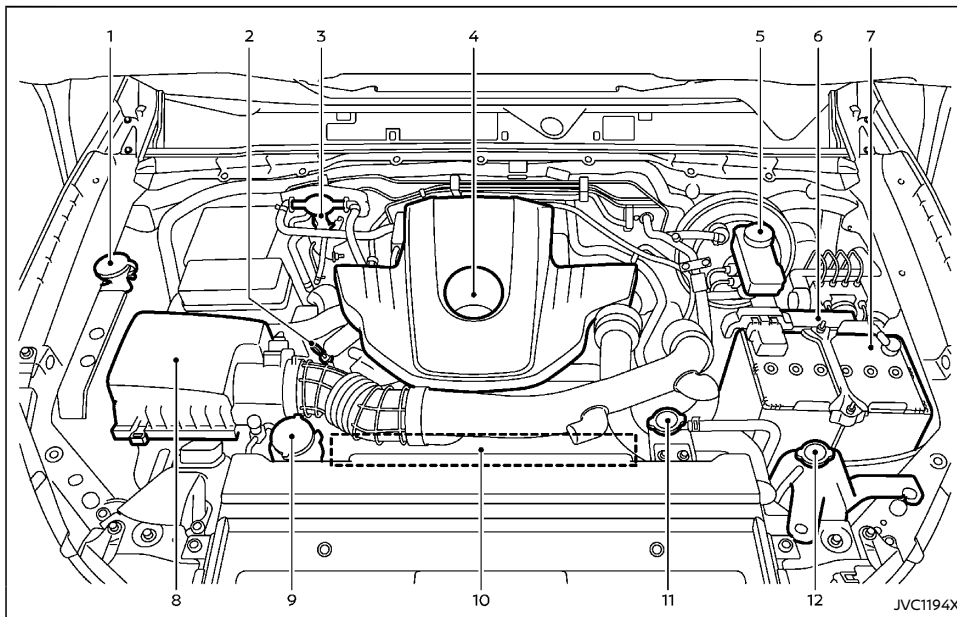

- |  |  |
|--|--|
| 1. Window washer fluid reservoir (P.8-21)        | 8. Air cleaner (P.8-19)  |
| 2. Engine oil dipstick (P.8-10)                  | 9. Power steering fluid reservoir (P.8-19)   |
| 3. Priming valve (P.8-14)                        | 10. Engine drive belt location (P.8-15)  |
| 4. Engine oil filler cap (P.8-10)                | 11. Radiator filler cap (P.8-8)  |
| 5. Brake and clutch*1 fluid reservoir*2 (P.8-17) | 12. Engine coolant reservoir (P.8-8)   |
| 6. Fuse/fusible link holder (P.8-26)             | *1: For Manual Transmission (MT) model   |
| 7. Battery (P.8-22)                              | *2: The layout illustrated is for the Left-Hand Drive (LHD) model. On the Right-Hand Drive (RHD) model, brake (and clutch) fluid |



## YS23DDTT ENGINE

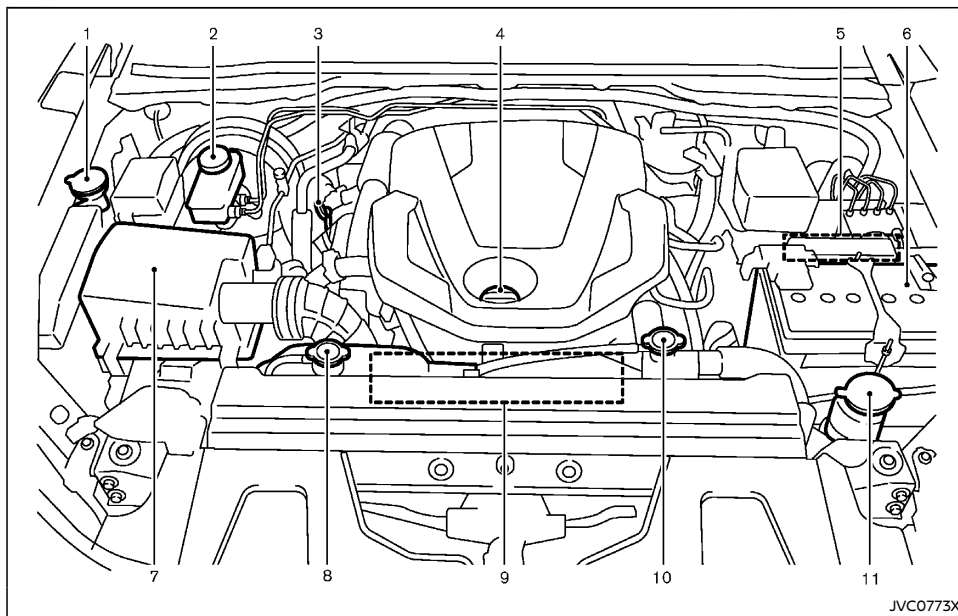

- |   |   |
|---|---|
| 1. Window washer fluid reservoir (P.8-21) | 9. Engine drive belt location (P.8-15)      |
| 2. Brake fluid reservoir (P.8-17)         | 10. Radiator filler cap (P.8-8)             |
| 3. Engine oil dipstick (P.8-10)           | 11. Power steering fluid reservoir (P.8-19) |
| 4. Engine oil filler cap (P.8-10)         |   |
| 5. Fuse/fusible link holder (P.8-26)      |   |
| 6. Battery (P.8-22)                       |   |
| 7. Air cleaner (P.8-19)                   |   |
| 8. Engine coolant reservoir (P.8-8)       |   |

## QR25DE ENGINE

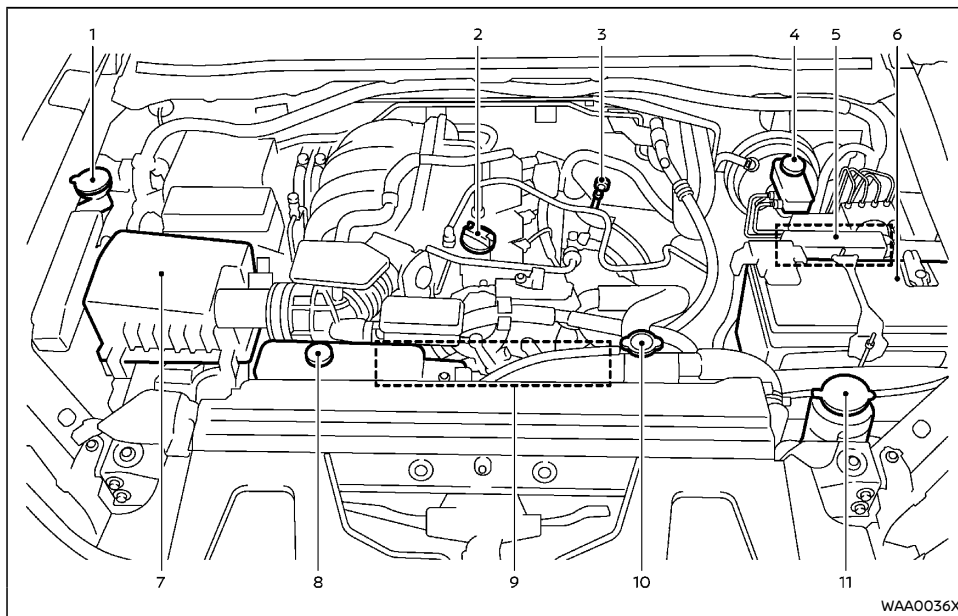

1. Window washer fluid reservoir (P.8-21)
2. Engine oil filler cap (P.8-10)
3. Engine oil dipstick (P.8-10)
4. Brake and clutch\*1 fluid reservoir\*2 (P.8-17, P.8-18)
5. Fuse/fusible link holder (P.8-26)
6. Battery (P.8-22)
7. Air cleaner (P.8-19)

8. Engine coolant reservoir (P.8-8)
  9. Engine drive belt location (P.8-15)
  10. Radiator filler cap (P.8-8)
  11. Power steering fluid reservoir (P.8-19)
- \*1: For Manual Transmission (MT) model
- \*2: The layout illustrated is for the Left-Hand Drive (LHD) model. On the Right-Hand Drive (RHD) model, brake (and clutch) fluid reservoir is located on the opposite side.

# 1 Safety — seats, seat belts and supplemental restraint system

Seats .....	1-2	Universal child restraints for front seat and rear seats .....	1-18
Front seats .....	1-2	ISOFIX child restraint system (for second row seats) .....	1-22
Second row seats .....	1-5	Child restraint anchorage (for second row seats) .....	1-23
Third row seats .....	1-6	Child restraint installation using ISOFIX (for second row seats) .....	1-23
Armrest (second row seats) .....	1-8	Child restraint installation using three-point type seat belt .....	1-25
Flexible seating .....	1-8	Child restraint installation using two-point type seat belt (if equipped) .....	1-28
Head restraints .....	1-9	Supplemental Restraint System (SRS) .....	1-29
Adjustable head restraint components .....	1-9	Precautions on Supplemental Restraint System (SRS) .....	1-29
Non-adjustable head restraint components .....	1-9	Supplemental air bag systems .....	1-33
Remove .....	1-10	SRS air bag deployment conditions .....	1-34
Install .....	1-10	Pre-tensioner seat belt system .....	1-37
Adjust .....	1-10	Repair and replacement procedure .....	1-37
Seat belts .....	1-11	Emergency services call eCall/SOS system (if equipped) .....	1-38
Precautions on seat belt usage .....	1-11	Automatic emergency call .....	1-38
Child safety .....	1-13	Making an emergency call manually .....	1-39
Pregnant women .....	1-13	Indicator lights .....	1-40
Injured persons .....	1-14	Modalities for exercising data subject's rights .....	1-40
Center mark on seat belts .....	1-14		
Three-point type seat belts .....	1-14		
Two-point type seat belt (if equipped) .....	1-15		
Seat belt maintenance .....	1-16		
Child restraints .....	1-16		
Precautions on child restraint usage .....	1-16		

## SEATS

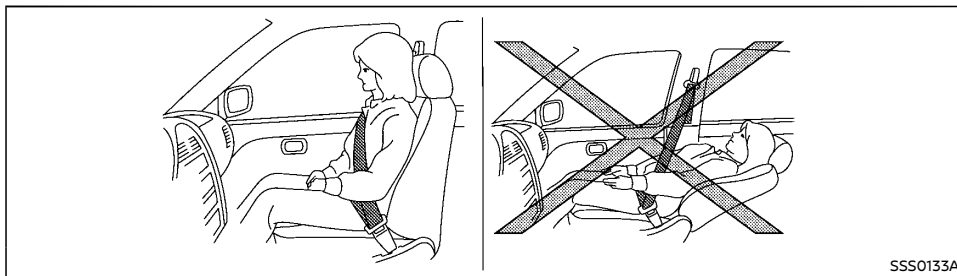

Manual seat adjustment (if equipped)



### WARNING:

After adjusting a seat, gently shake the seat to confirm that the seat is locked securely. If the seat is not locked securely, it may move suddenly and could cause the loss of control of the vehicle.



### WARNING:

- Do not drive and/or ride in the vehicle with the seatback reclined. This can be dangerous. The shoulder belt will not be properly against the body. In an accident, you and your passengers could be thrown into the shoulder belt and receive neck or other serious injuries. You and your passengers could also slide under the lap belt and receive serious injuries.
- For the most effective protection while the vehicle is in motion, the seatback should be upright. Always sit well back and upright in the seat and adjust the seat properly. (See "Seat belts" (P.1-11).)
- Do not leave children unattended inside the vehicle. They could unknowingly activate switches or controls. Unattended children could become involved in serious accidents.
- To help avoid risk of injury or death through unintended operation of the vehicle and/or its systems, do not leave children, people who require the assistance of others or pets unattended in

your vehicle. Additionally, the temperature inside a closed vehicle on a warm day can quickly become high enough to cause a significant risk of injury or death to people and pets.



### CAUTION:

When adjusting the seat positions, be sure not to contact any moving parts to avoid possible injuries and/or damages.

## FRONT SEATS



### WARNING:

Do not adjust the driver's seat while driving so that full attention may be given to vehicle operation.

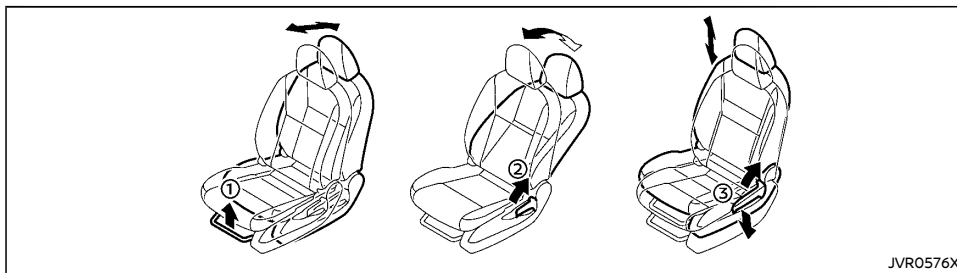

#### Forward and backward:

1. Pull up the adjusting lever ①.
2. Slide the seat to the desired position.
3. Release the adjusting lever to lock the seat in position.

#### Reclining:

1. Pull up the adjusting lever ②.
2. Tilt the seatback to the desired position.
3. Release the adjusting lever to lock the seatback in position.

The reclining feature allows the adjustment of the seatback for occupants of different sizes to help obtain the proper seat belt fit. (See "Seat belts" (P.1-11).)

The seatback may be reclined to allow occupants to rest when the vehicle is parked.



#### WARNING:

- **The seatback should not be reclined any more than needed for comfort. Seat belts are most effective when the passenger sits well back and straight up in the seat. If the seatback is reclined, the risk of sliding under the lap belt and being**

**injured is increased.**

- **After adjusting a seat, gently shake the seat to confirm that the seat is locked securely. If the seat is not locked securely, it may move suddenly and could cause the loss of control of the vehicle.**

#### Seat lifter (if equipped):

Pull up or push down the adjusting lever ③ to adjust the seat height until the desired position is achieved.

## Power seat adjustment (if equipped)

### Operating tips:

- The power seat motor has an auto-reset overload protection circuit. If the motor stops during the seat adjustment, wait 30 seconds, then reactivate the switch.
- To avoid discharge of the battery, do not operate the power seats for a long period of time when the engine is not running.

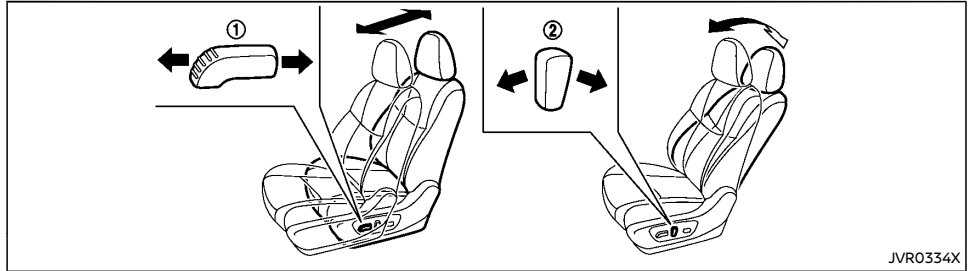

### Forward and backward:

Move forward or backward the adjusting switch ① to the desired position.

### Reclining:

Move forward or backward the adjusting switch ② to the desired position.

The reclining feature allows the adjustment of the seatback for occupants of different sizes to help obtain the proper seat belt fit. (See "Seat belts" (P.1-11).)

The seatback may be reclined to allow occupants to rest when the vehicle is parked.



### WARNING:

**The seatback should not be reclined any more than needed for comfort. Seat belts are most effective when the passenger sits well back and straight up in the seat. If the seatback is reclined, the risk of sliding under the lap belt and being injured is increased.**

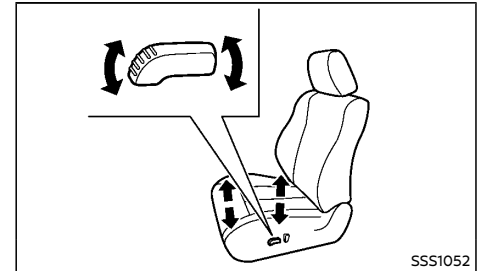

### Seat lifter:

1. Pull up or push down the adjusting switch to adjust the seat height until the desired position is achieved.
2. Tilt up or down the adjusting switch to adjust the front angle of the seat until the desired position is achieved.

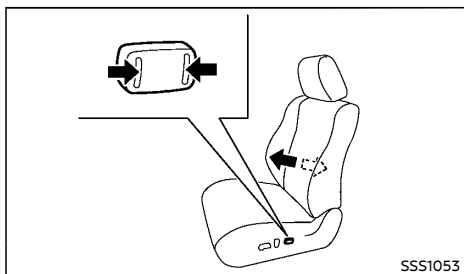

### Lumbar support:

The lumbar support feature provides lower back support to the driver.

Push each side of the adjusting switch to adjust the seat lumbar area until the desired position is achieved.

## SECOND ROW SEATS

### Adjustment

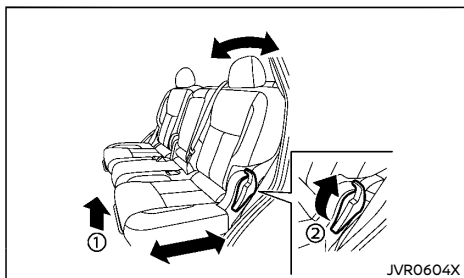

### Forward and backward:

1. Pull up the adjusting lever ①.
2. Slide the seat to the desired position.
3. Release the adjusting lever ① to lock the seat in position.

### Reclining:

1. Pull the adjusting lever ②.
2. Tilt the seatback to the desired position.
3. Release the adjusting lever ② to lock the seatback in position.

The reclining feature allows the adjustment of the seatback for occupants of different sizes to help obtain the proper seat belt fit. (See "Seat belts" (P.1-11).)

The seatback may be reclined to allow occupants to rest when the vehicle is parked.

### WARNING:

After adjusting a seat, gently shake the seat to confirm that the seat is locked securely. If the seat is not locked securely, it may move suddenly and could cause a serious injury.

### Entry to third row seat

### WARNING:

- Do not fold down the second row seat when occupants are in the second row seat area or any luggage is on the seats. The occupants may be pushed out of the seat and fall down, suffering an injury.
- Do not fold down the second row seat while the vehicle is moving.
- Do not drive with the second row seat tipped up.

- Be careful not to allow the second row seat to pinch, hit any part of your body or other people when operating the second row seat. Make sure the seat path is clear of all objects before moving the seat.

The second row seat can be tipped forward for easy entry to or exit from the third row seat.

### Using the lever:

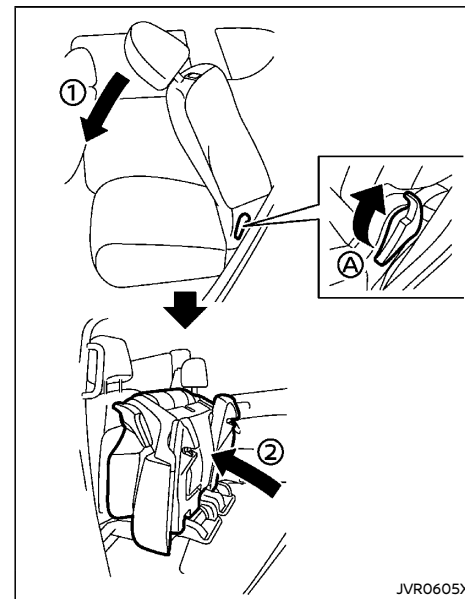

To enter the third row seat, pull the lever (A) located on the second row seat and fold the seatback forward (1) at an angle over the seat base. The seat base will lift up and the second

row seat will tip forward ② **automatically**. This will release the back of the seat so it may be tipped forward.

To exit the third row seat, pull the lever ① and fold the seatback forward onto the seat base. The seat base will lift up and tip forward **automatically**.

#### Using the remote switch (if equipped):

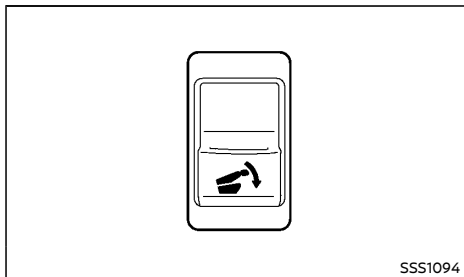

Push and hold the seat tumbling switch located on the center console. The seatback will fold down.

The lower corner of the seat base will lift and the second row seat will tip forward.

#### Returning the second row seat:



When returning the second row seat to its original position, push the seat backward. Tilt the seatback up and then secure it in place.



#### WARNING:

- When returning the second row seat to the original position, never allow the third row seat passengers to place their feet on the second row seat base area. Serious injury can occur if the feet get caught.
- When returning the second row seat to the original position, be certain the seat is completely secured in the latched position. If the seat is not completely secured, passengers may be injured in an accident or sudden stop.
- After returning the second row seat, gently shake the seat to confirm that the seat is locked securely. If the seat or seatback is not locked securely, it may move suddenly and could cause a serious injury.

- When returning the seatbacks to the upright position, be certain they are completely secured in the latched position. If they are not completely secured, passengers may be injured in an accident or sudden stop.
- Be careful not to allow the second row seat to pinch, hit any part of your body or other people when operating the second row seat. Make sure the seat path is clear of all objects before moving the seat.
- When the seat is returned to the normal seating position, the head restraints must be returned to the upright position to properly protect vehicle occupants.

#### THIRD ROW SEATS

##### Reclining

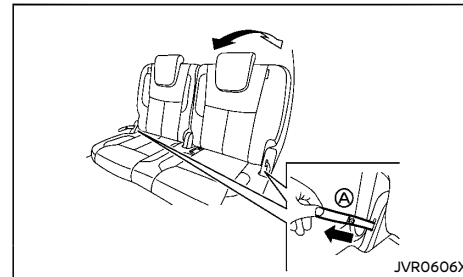

Pull the strap ① and position the seatback at the desired angle. Release the strap after positioning the seat at the desired angle.

The reclining feature allows adjustment of the seatback for occupants of different sizes to help obtain proper seat belt fit. (See "Precautions on seat belt usage" (P.1-11).) The seatback may also be reclined to allow occupants to rest



when the vehicle is parked.



**WARNING:**

- Do not ride in a moving vehicle when the seatback is reclined. This can be dangerous. The shoulder belt will not be against your body. In an accident, you could be thrown into it and receive neck or other serious injuries. You could also slide under the lap belt and receive serious internal injuries.
- For the most effective protection when the vehicle is in motion, the seat should be upright. Always sit well back and upright in the seat with both feet on the floor and adjust the seat belt properly. See "Precautions on seat belt usage" (P.1-11).
- After adjustment, gently rock in the seat to make sure it is securely locked. If the seat is not locked securely, it may move suddenly and could cause a serious injury.

Folding



**WARNING:**

- Never allow anyone to ride in the cargo area or on the third row seat when it is in the fold-down position. Use of these areas by passengers without proper restraints could result in serious injury in an accident or sudden stop.
- Properly secure all cargo with ropes or straps to help prevent it from sliding or shifting. Do not place cargo higher than the seatbacks. In a sudden stop or collision, unsecured cargo could cause personal injury.

- When returning the seatbacks to the upright position, be certain they are completely secured in the latched position. If they are not completely secured, passengers may be injured in an accident or sudden stop.
- When the seat is returned to the normal seating position, the head restraints must be returned to the upright position to properly protect vehicle occupants.
- Properly secure all cargo to help prevent it from sliding or shifting. Do not place cargo higher than the seatbacks. In a sudden stop or collision, unsecured cargo could cause personal injury.



**CAUTION:**

- Do not fold down the third row seat when occupants are in the seat area or any luggage is on the seats.
- Be careful not to allow the third row seat to pinch, hit any part of your body or other people when operating the third row seat. Make sure the seat path is clear of all objects before operating the seat.

Using front strap:

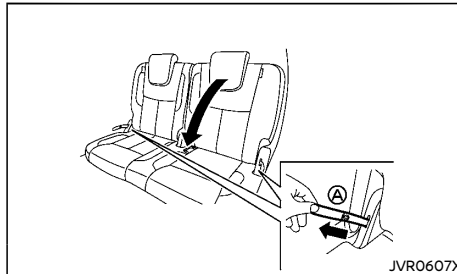

1. Make sure the head restraints are all the way down.
2. Pull the strap Ⓐ and fold the seatback.

When returning the third row seat to a seating position, return the seatback until it securely locks in position.

Using rear strap:

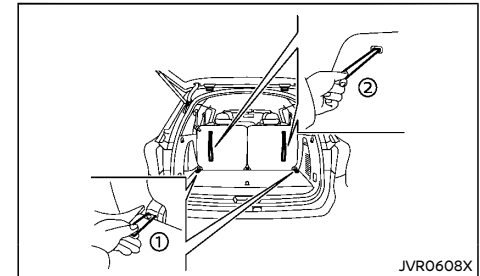

To fold the third row seats flat for maximum cargo capacity:

1. Make sure the head restraints are all the way down.
2. Pull the strap ① and fold the seatback.

To return the third row seats to a seating position:

Use the pull straps ② to raise each seatback. Pull back until the seatback latches into position. Make sure to properly raise each seatback to an upright and secured position.

## ARMREST (second row seats)

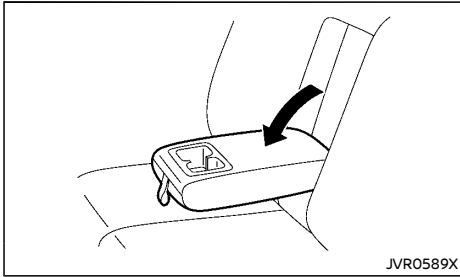

Pull the armrest forward until it is horizontal.

## FLEXIBLE SEATING



### WARNING:

- Never allow anyone to ride in the cargo area or on the rear seats when they are in the fold-down position. In a collision, people riding in these areas without proper restraints are more likely to be seriously injured or killed.
- Do not allow people to ride in any area of your vehicle that is not equipped with seats and seat belts. Be sure everyone in your vehicle is in a seat and using a seat belt properly.
- Do not fold down the rear seats when occupants are in the rear seat area or any cargo is on the rear seats.
- Head restraints should be adjusted properly as they may provide significant protection against injury in an accident. Always replace and adjust them properly if they have been removed for any reason.

- If the head restraints are removed for any reason, they should be securely stored to prevent them from causing injury to passengers or damage to the vehicle in case of sudden braking or an accident.
- When returning the seatbacks to the upright position, be certain they are completely secured in the latched position. If they are not completely secured, passengers may be injured in an accident or sudden stop.
- Properly secure all cargo to help prevent it from sliding or shifting. Do not place cargo higher than the seatbacks. In a sudden stop or collision, unsecured cargo could cause personal injury.
- When folding the seatback down for maximum storage, make sure the seat base is in the latched position by rocking the seat base. If the seat base is not properly secured, cargo stored on top of a folded seatback may become a projectile causing personal injury or vehicle damage.



### CAUTION:

- When folding the second row seat for maximum cargo hauling, be sure that cargo does not contact the center console to avoid possible damage to the console.
- When folding or returning the seat(s) to the upright position, to avoid injury to yourself and others:
  - Make sure that the seat path is clear before moving the seat.
  - Be careful not to allow hands or feet to get caught or pinched in the seat.

## Stowing second and third row seats

To stow second and third row seats for maximum cargo capacity:

Manual operation:

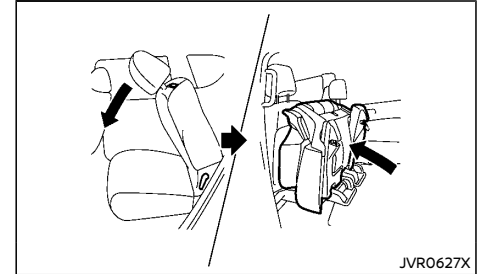

1. Pull the lever located on the second row seat. The seatback folds down and the seat base will tip forward. See "Entry to third row seat" (P.1-5).

Switch operation:

1. Push and hold the corresponding switch located on the center console. The seatback will fold down and tip forward. See "Entry to third row seat" (P.1-5).

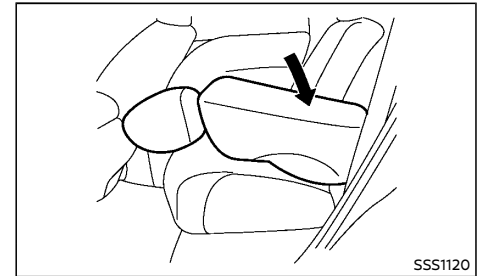

## HEAD RESTRAINTS

2. Push the folded seat down until it locks in position.

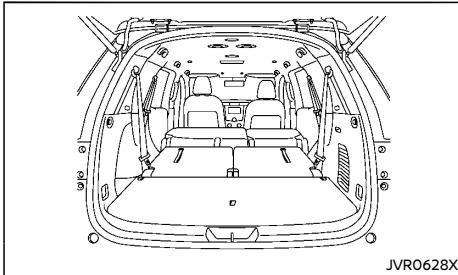

3. Fold the third row seat flat using the straps in the seat. See "Folding" (P.1-7).
4. Return the third row seats to seating positions by raising the third row seatbacks to an upright position. Make sure the seatback is locked in position. See "Folding" (P.1-7).
5. Return the second row seat to a seating position by raising the second row seatbacks to an upright position. Make sure the seatback is locked in position.



### CAUTION:

When folding the second row seat for maximum cargo hauling, be sure that cargo does not contact the center console to avoid possible damage to the console.



### WARNING:

Head restraints supplement the other vehicle safety systems. They may provide additional protection against injury in certain rear end collisions. Adjustable head restraints must be adjusted properly, as specified in this section. Check the adjustment after someone else uses the seat. Do not attach anything to the head restraint stalks or remove the head restraint. Do not use the seat if the head restraint has been removed. If the head restraint was removed, reinstall and properly adjust the head restraint before an occupant uses the seating position. Failure to follow these instructions can reduce the effectiveness of the head restraint. This may increase the risk of serious injury or death in a collision.

- Your vehicle is equipped with a head restraint that may be integrated, adjustable or non-adjustable.
- Adjustable head restraints have multiple notches along the stalk to lock them in a desired adjustment position.
- The non-adjustable head restraints have a single locking notch to secure them to the seat frame.
- Proper Adjustment:
  - For the adjustable type, align the head restraint so the center of your ear is approximately level with the center of the head restraint.
  - If your ear position is still higher than the recommended alignment, place the head restraint at the highest position.
- If the head restraint has been removed, ensure that it is reinstalled and locked in place before riding in that designated

seating position.

## ADJUSTABLE HEAD RESTRAINT COMPONENTS

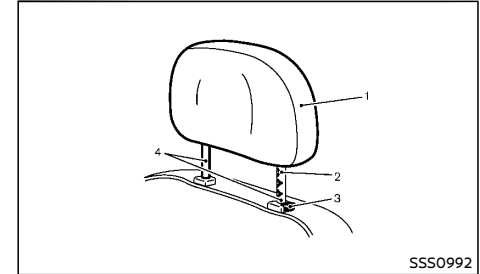

1. Removable head restraint
2. Multiple notches
3. Lock knob
4. Stalks

## NON-ADJUSTABLE HEAD RESTRAINT COMPONENTS

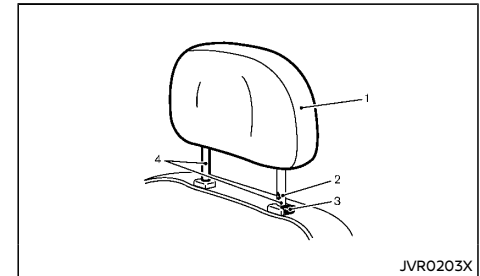

1. Removable head restraint

2. Single notch
3. Lock knob
4. Stalks

## REMOVE

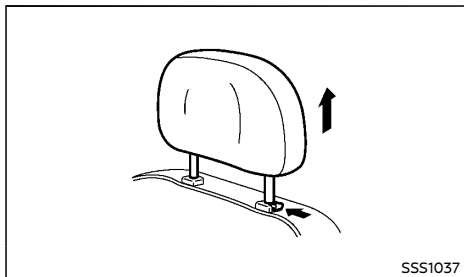

Use the following procedure to remove the head restraint.

1. Pull the head restraint up to the highest position.
2. Push and hold the lock knob.
3. Remove the head restraint from the seat.
4. Store the head restraint properly in a secure place so it is not loose in the vehicle.
5. Reinstall and properly adjust the head restraint before an occupant uses the seating position.

## INSTALL

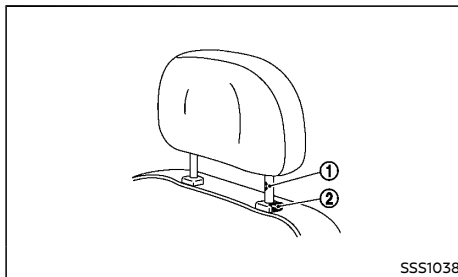

1. Align the head restraint stalks with the holes in the seat. Make sure that the head restraint is facing the correct direction. The stalk with the notch ① must be installed in the hole with the lock knob ②.
2. Push and hold the lock knob and push the head restraint down.
3. Properly adjust the head restraint before an occupant uses the seating position.

## ADJUST

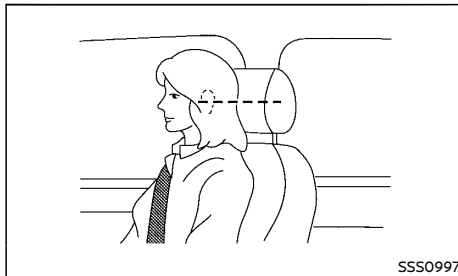

## For adjustable head restraint

Adjust the head restraint so the center is level with the center of your ears. If your ear position is still higher than the recommended alignment, place the head restraint at the highest position.

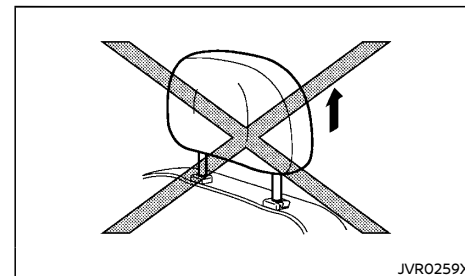

## For non-adjustable head restraint

Make sure the head restraint is positioned from the stored position or any non-latch position so the lock knob is engaged in the notch before riding in that designated seating position.

## Raise

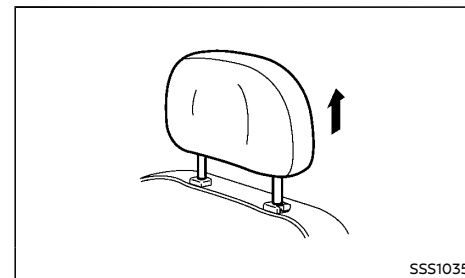

To raise the head restraint, pull it up.

## SEAT BELTS

Make sure the head restraint is positioned from the stored position or any non-latch position so the lock knob is engaged in the notch before riding in that designated seating position.

### Lower

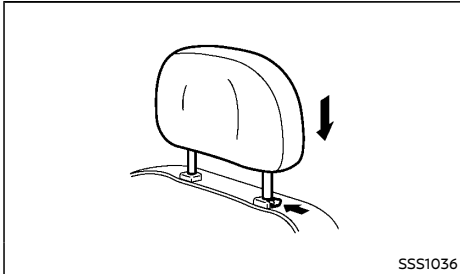

To lower, push and hold the lock knob and push the head restraint down.

Make sure the head restraint is positioned so the lock knob is engaged in the notch before riding in that designated seating position.

### PRECAUTIONS ON SEAT BELT USAGE

If you are wearing the seat belt properly adjusted and sitting upright and well back in the seat, chances of being injured or killed in an accident and/or the severity of injury may be greatly reduced. NISSAN strongly encourages you and all of your passengers to buckle up every time you drive, even if your seating position includes the supplemental air bag systems.

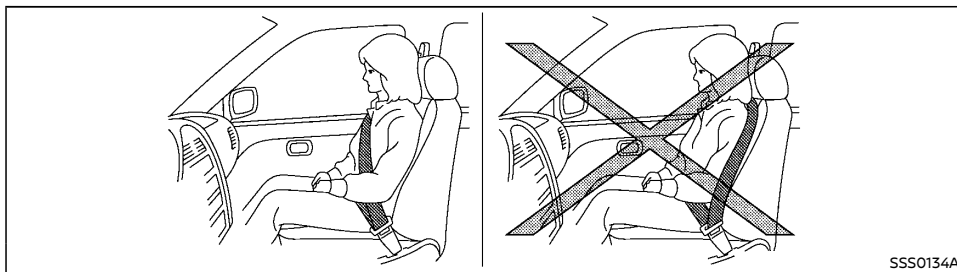

SSS0134A

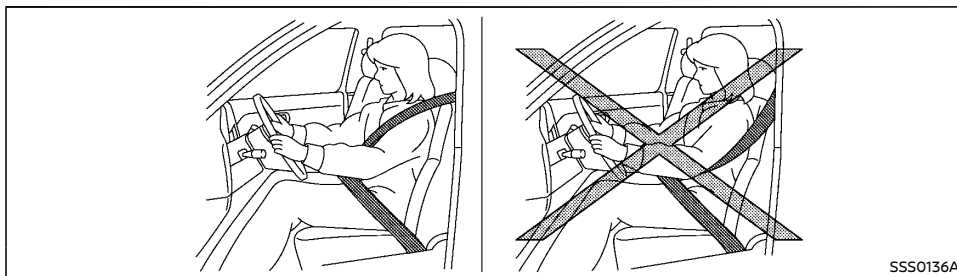

SSS0136A

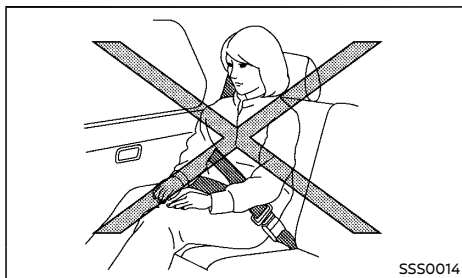

SSS0014

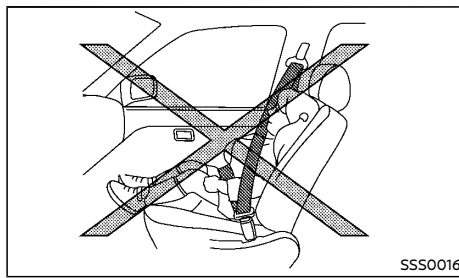

SSS0016

**⚠ WARNING:**

- Seatbelts are designed to bear upon the bony structure of the body, and should be worn low across the front of the pelvis or the pelvis, chest and shoulders, as applicable; wearing the lap section of the belt across the abdominal area must be avoided. Serious injury may occur if a seat belt is not worn properly.
- Position the lap belt as low and snug as possible around the hips, not the waist. A lap belt worn too high could increase the risk of internal injuries in an accident.
- Do not allow more than one person to use the same seat belt. Each belt assembly must only be used by one occupant; it is dangerous to put a belt around a child being carried on the occupant's lap.
- Never carry more people in the vehicle than there are seat belts.
- Never wear seat belts inside out. Belts should not be worn with straps twisted. Doing so may reduce their effectiveness.
- Seatbelts should be adjusted as firmly as possible, consistent with comfort, to provide the protection for which they have been designed. A slack belt will greatly reduce the protection afforded to the wearer.
- Every person who drives or rides in this vehicle should use a seat belt at all times. Children should be properly restrained in the rear seat and, if appropriate, in a child restraint system.
- Do not put the belt behind your back or under your arm. Always route the shoulder belt over your shoulder and across your chest. The belt should be

away from your face and neck, but not falling off your shoulder. Serious injury may occur if a seat belt is not worn properly.

- No modifications or additions should be made by the user which will either prevent the seat belt adjusting devices from operating to remove slack, or prevent the seat belt assembly from being adjusted to remove slack.
- Care should be taken to avoid contamination of the webbing with polishes, oils and chemicals, and particularly battery acid. Cleaning may safely be carried out using mild soap and water. The belt should be replaced if webbing becomes frayed, contaminated or damaged.
- It is essential to replace the entire assembly after it has been worn in a severe impact even if damage to the assembly is not obvious.
- All seat belt assemblies including retractors and attaching hardware should be inspected after any collision by a NISSAN dealer. NISSAN recommends that all seat belt assemblies in use during a collision be replaced unless the collision was minor and the belts show no damage and continue to operate properly. Seat belt assemblies not in use during a collision should also be inspected and, when necessary, replaced if either damage or improper operation is noted.
- Once the pre-tensioner seat belt has activated, it cannot be reused. It must be replaced together with the retractor. Contact a NISSAN dealer.
- Removal and installation of the pre-tensioner seat belt system components

should be done by a NISSAN dealer.

## CHILD SAFETY



### WARNING:

- Infants and children need special protection. The vehicle's seat belts may not fit them properly. The shoulder belt may come too close to the face or neck. The lap belt may not fit over their small hipbones. In an accident, an improperly fitted seat belt could cause serious or fatal injury.
- Always use an appropriate child restraint system.

Children need adults to help protect them. They need to be properly restrained. The proper restraint depends on the child's size.

### Infants and small children

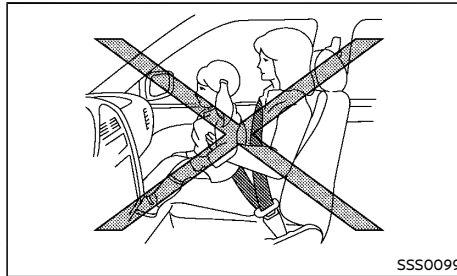

NISSAN recommends that infants and small children be seated in a child restraint system. You should choose a child restraint system that fits your vehicle and the child, and always follow the manufacturer's instructions for installation and use.

## Large children



### WARNING:

- Never allow children to stand or kneel on any seats.
- Never allow children in the luggage areas while the vehicle is moving. A child could be seriously injured in an accident or sudden stop.

Children who are too large for a child restraint system should be seated and restrained by the seat belts that are provided.

If the child's seating position has a shoulder belt that fits close to the face or neck, the use of a booster seat (commercially available) may help overcome this. The booster seat should raise the child so that the shoulder belt is properly positioned across the top, middle portion of the shoulder and the lap belt is low on the hips. The booster seat should also fit the vehicle seat. Once the child has grown so that the shoulder belt is no longer on or near the face or neck of the child, use the shoulder belt without the booster seat. In addition, there are many types of child restraint systems available for larger children that should be used for maximum protection.

### PREGNANT WOMEN

NISSAN recommends that pregnant women use seat belts. The seat belt should be worn snug, and always position the lap belt as low as possible around the hips, not the waist. Place the shoulder belt over your shoulder and across your chest. Never run the lap/shoulder belt over your abdominal area. Contact your doctor for specific recommendations.

## INJURED PERSONS

NISSAN recommends that injured persons use seat belts. Contact your doctor for specific recommendations.

## CENTER MARK ON SEAT BELTS

### Selecting correct set of seat belts

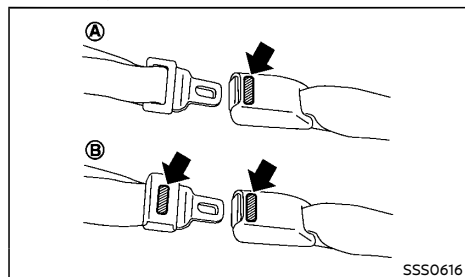

The center seat belt buckle (A) or both the buckle and the tongue (B) are identified by the CENTER mark. The center seat belt tongue can be fastened only into the center seat belt buckle.

## THREE-POINT TYPE SEAT BELTS

### Fastening seat belts

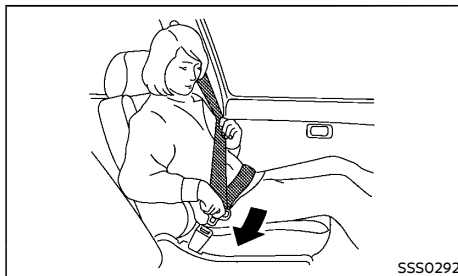

#### WARNING:

The seatback should not be in a reclined position any more than needed for comfort. Seat belts are most effective when the passenger sits well back and straight up in the seat.

1. Adjust the seat. (See "Seats" (P.1-2).)
2. Slowly pull the seat belt out of the retractor and insert the tongue into the buckle until you hear and feel the latch engage.
  - The retractor is designed to lock during a sudden stop or on impact. A slow pulling motion permits the seat belt to move, and allows you some freedom of movement in the seat.
  - If the seat belt cannot be pulled from its fully retracted position, firmly pull the belt and release it. Then smoothly pull the belt out of the retractor.

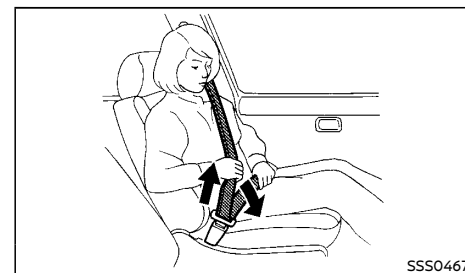

3. Position the lap belt portion low and snug on the hips as shown.
4. Pull the shoulder belt portion toward the retractor to take up extra slack. Be sure the shoulder belt is routed over your shoulder and is snug across your chest.

### Shoulder belt height adjustment (for front seats)

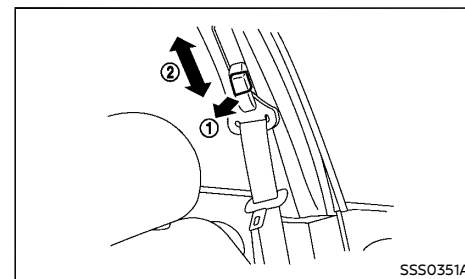

#### WARNING:

- The shoulder belt anchor height should be adjusted to the position best for you. Failure to do so may reduce the effectiveness of the entire restraint system



and increase the chance or severity of injury in an accident.

- The shoulder belt should rest on the middle of the shoulder. It must not rest against the neck.
- Be sure that the seat belt is not twisted in any way.
- Be sure that the shoulder belt anchor is secured by trying to move the shoulder belt anchor up and down after adjustment.

To adjust, pull in the release button ① and move the shoulder belt anchor to the proper position ②, so that the belt passes over the center of the shoulder. The belt should be away from your face and neck, but not falling off your shoulder. Release the button to lock the shoulder belt anchor into position.

### Unfastening seat belts

Push the button on the buckle. The seat belt automatically retracts.

### Belt hook (for rear outer seats)

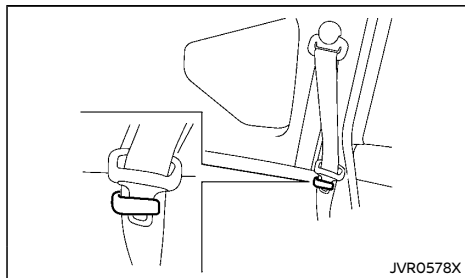

Hook the seat belt on the belt hook when folding down the rear seat.

### Checking seat belt operation

Seat belt retractors are designed to lock seat belt movement:

- When the seat belt is pulled quickly from the retractor.
- When the vehicle slows down rapidly.

To increase your confidence in the seat belts, check the operation by grasping the shoulder belt and pulling forward quickly. The retractor should lock and restrict further belt movement. If the retractor does not lock during this check, contact a NISSAN dealer immediately.

### TWO-POINT TYPE SEAT BELT (if equipped)

#### Taking out seat belt

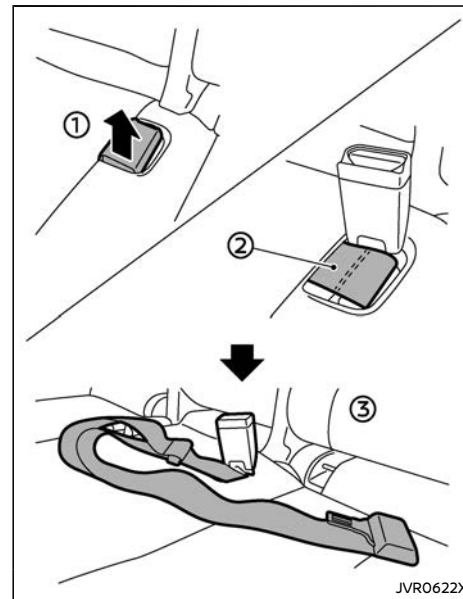

1. Pull up the buckle ①. The seat belt is stowed under the buckle ②.
2. Unfold the seat belts ③.

When the two-point type seat belt is not in use, fold and stow the seat belt under the buckle.

## Fastening seat belts



### WARNING:

Every person who drives or rides in this vehicle should use a seat belt at all times.

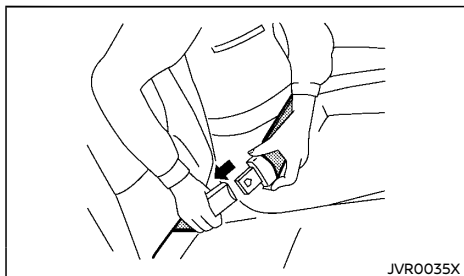

1. Insert the tongue into the buckle marked CENTER until you hear and feel the latch engage.

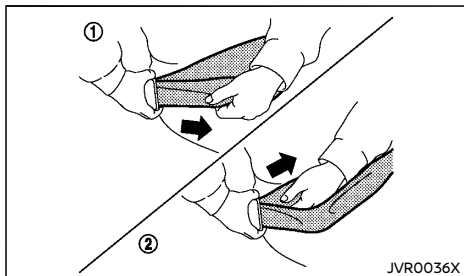

2. Adjust the seat belt length. To shorten, hold the tongue and pull the upper belt as illustrated ①. To lengthen, hold the tongue and pull the under belt as illustrated ②.

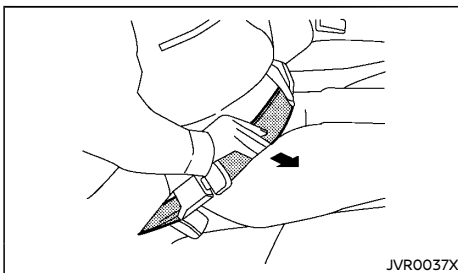

3. Position the lap belt portion low and snug on the hips as shown.

## Unfastening seat belts

Push the button on the buckle.

## SEAT BELT MAINTENANCE

Periodically check that the seat belt and all the metal components, such as buckles, tongues, retractors, flexible wires and anchors, work properly. If loose parts, deterioration, cuts or other damage on the seat belt webbing is found, the entire seat belt assembly should be replaced.

If dirt builds up in the shoulder belt guide of the seat belt anchors, the seat belts may retract slowly. Wipe the shoulder belt guide with a clean, dry cloth.

To clean the seat belt webbing, apply a mild soap solution or any solution recommended for cleaning upholstery or carpet. Then wipe with a cloth and allow the seat belts to dry in the shade. Do not allow the seat belts to retract until they are completely dry.

## CHILD RESTRAINTS

### PRECAUTIONS ON CHILD RESTRAINT USAGE

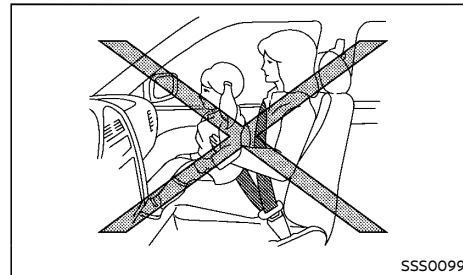

### WARNING:

- Infants and small children should never be carried on your lap. It is not possible for even the strongest adult to resist the forces of a severe accident. The child could be crushed between the adult and parts of the vehicle. Also, do not put the same seat belt around both your child and yourself.
- Infants and children need special protection. The vehicle's seat belts may not fit them properly. The shoulder belt may come too close to the face or neck. The lap belt may not fit over their small hip bones. In an accident, an improperly fitting seat belt could cause serious or fatal injury.
- Infants and small children should always be placed in an appropriate child restraint while riding in the vehicle. Failure to use a child restraint can result in serious injury or death.

- Child restraint systems specially designed for infants and small children are available from several manufacturers. When selecting any child restraint systems, place your child in the child restraint system and check the various adjustments to be sure that the child restraint system is compatible with your child. Always follow the manufacturer's instructions for installation and use.
- NISSAN recommends that the child restraints be installed in the rear seat. According to accident statistics, children are safer when properly restrained in the rear seat than in the front seat.
- Follow all of the child restraint manufacturer's instructions for installation and use. When purchasing a child restraint, be sure to select one which will fit your child and vehicle. It may not be possible to properly install some types of child restraint in your vehicle.
- The direction of the child restraint, either front-facing or rear-facing, depends on the type of the child restraint and the size of the child. Refer to the child restraint manufacturer's instructions for details.
- For a front-facing child restraint system, check to make sure the shoulder belt does not fit close to child's face or neck. If it does, put the shoulder belt behind the child restraint system. If you must install a front-facing child restraint system in the front seat, see "Installation on front passenger's seat" (P.1-27).
- Never install a rear-facing child restraint on the front passenger's seat when the front passenger's air bag is available. Supplemental front-impact air bags inflate with great force. A rear-facing child

restraint could be struck by the supplemental front-impact air bags in an accident and could seriously injure or kill your child.

- Adjustable seatbacks should be positioned to ensure full contact between child restraint and seatback.
- If the seat belt in the position where a child restraint is installed requires a locking device and if it is not used, injuries could result from a child restraint system tipping over during normal vehicle braking or cornering.
- After attaching a child restraint, test it before you place the child in it. Push it from side to side and tug it forward to make sure that it is held securely in place. The child restraint system should not move more than 25 mm (1 in). If the restraint is not secure, tighten the belt as necessary, or install the restraint in another seat and test it again.
- Check the child restraint system in your vehicle to be sure that it is compatible with the vehicle's seat belt system.
- If a child restraint system is not anchored properly, the risk of a child being injured in a collision or a sudden stop greatly increases.
- Improper use or improper installation of a child restraint can increase the risk or severity of injury for both the child and other occupants of the vehicle and can lead to serious injury or death in an accident.
- Always use an appropriate child restraint system. An improperly installed child restraint system could lead to serious injury or death in an accident.

- When the child restraint is not in use, keep it secured with the ISOFIX child restraint system or a seat belt to prevent it from being thrown around in case of a sudden stop or accident.

NISSAN recommends that infants and small children be seated in a child restraint system. You should choose a child restraint system that fits your vehicle and always follow the manufacturer's instructions for installation and use. In addition, there are many types of child restraint systems available for larger children that should be used for maximum protection.



#### **CAUTION:**

**Remember that a child restraint system left in a closed vehicle can become very hot. Check the seating surface and buckles before placing your child in a child restraint system.**

## UNIVERSAL CHILD RESTRAINTS FOR FRONT SEAT AND REAR SEATS



### WARNING:

In vehicles equipped with a side air bag system, do not let any infants or small children sit in the front passenger's seat as the air bag may cause serious injury in case of deployment during a collision.

### NOTE:

Universal child restraints approved to UN Regulation NO.44 (UN R44) or UN Regulation NO.129 (UN R129) are clearly marked "Universal".

When selecting any child restraint, keep the following points in mind:

- Choose a child restraint that complies with UN R44 or UN R129.
- Place your child in the child restraint and check the various adjustments to be sure the child restraint is compatible with your child. Always follow all of the recommended procedures.
- Check the child restraint in your vehicle to be sure it is compatible with vehicle's seat belt system.
- Refer to the tables later in this section for a list of the recommended fitment positions and the approved child restraints for your vehicle.

## Mass group of child seat

Mass group	Child's weight
Group 0	up to 10 kg
Group 0+	up to 13 kg
Group I	9 to 18 kg
Group II	15 to 25 kg
Group III	22 to 36 kg

### Kind of child seats (example):

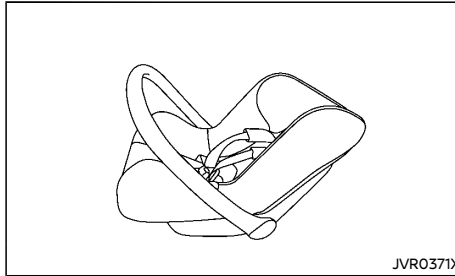

Child safety seat categories 0 and 0+

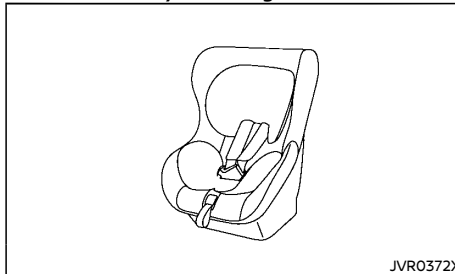

Child safety seat categories 0+ and I

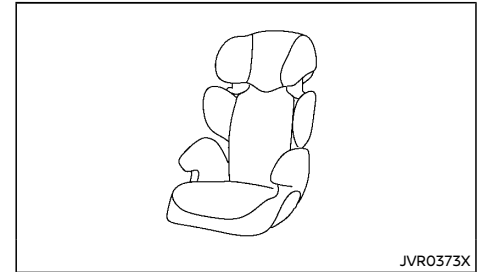

Child safety seat categories II and III

## Approved child restraint positions (without ISOFIX)

The following restriction is applied when using child restraints varying by infants weight and installation position.

Mass group		Seating position			
		Front passenger seat	Second row outer seat	Second row center seat	Third row seat
0	<10 kg	X	X	X	X
0+	<13 kg	X	L	X	X
I	9 - 18 kg	L	L	X	L
II	15 - 25 kg	L	L	X	L
III	22 - 36 kg	L	L	X	L

X: Not suitable for child restraint system.

U: Suitable for "universal" category child restraint system approved for this weight group.

L: Suitable for particular child restraint systems.

## Approved child restraint positions (with ISOFIX)

Mass group			Seating position			
			Front passenger seat	Second row outer seat	Second row center seat	Third row seat
Carry-cot	F	ISO/L1	X	X	X	X
	G	ISO/L2	X	X	X	X
0 (<10 kg)	E	ISO/R1	X	IL	X	X
0+ (<13 kg)	E	ISO/R1	X	IL	X	X
	D	ISO/R2	X	IL	X	X
	C	ISO/R3	X	IL	X	X
I (9 - 18 kg)	D	ISO/R2	X	IL	X	X
	C	ISO/R3	X	IL	X	X
	B	ISO/F2	X	IUF	X	X
	B1	ISO/F2X	X	IUF	X	X
	A	ISO/F3	X	IUF	X	X
II (15 - 25 kg)	—	—	X	IL	X	X
III (22 - 36 kg)	—	—	X	IL	X	X

X: Position not suitable for installation of ISOFIX child restraint systems (CRS) in these seating positions.

IUF: Suitable for universal category forward facing child restraint system approved for this weight group.

IL: Suitable for ISOFIX CRS in semi-universal category or particular ISOFIX CRS.

### Approved child restraint positions (with i-Size)

The following restriction is applied when using child restraints varying by installation position

	Front passenger seat	Second row outer seat	Second row center seat	Third row seat
i-Size child restraints	X	i-U	X	X

i-U: Suitable for i-Size "universal" Child Restraint Systems forward and rearward facing.

i-UF: Suitable for forward-facing i-Size "universal" Child Restraint Systems only.

X: Seating position not suitable for i-Size Child Restraint Systems.

## List of child seats recommended by NISSAN, secured using i-Size

Please carefully read installation manual of your child restraint.

Weight class	Name of CRS	Fixture of CRS
67-105 cm ≤18.5 kg	Maxi Cosi 2way pearl & 2way fix	ISOFIX & Support leg Rearward Facing
67-105 cm ≤18.5 kg >15 months	Maxi Cosi 2way pearl & 2way fix	ISOFIX & Support leg Rearward Facing
		ISOFIX & Support leg Forward Facing

In some countries or regions, the CRS listed in the table may not be available.

### ISOFIX CHILD RESTRAINT SYSTEM (for second row seats)

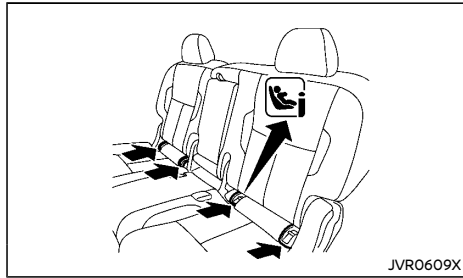

#### ISOFIX lower anchor location

Your vehicle is equipped with special anchor points that are used with ISOFIX child restraint systems.

### ISOFIX lower anchor point locations

The ISOFIX anchor points are provided to install child restraints in the second seat outboard seating positions only. **Do not attempt to install a child restraint in the second row seat center position using the ISOFIX anchors.**

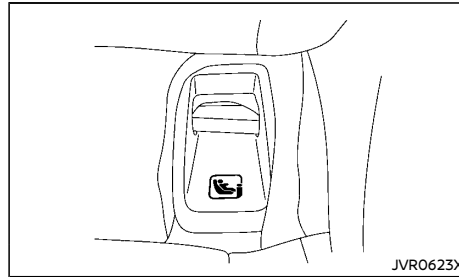

The ISOFIX anchors are located at the bottom of the seatback.

### ISOFIX child restraint anchor attachments

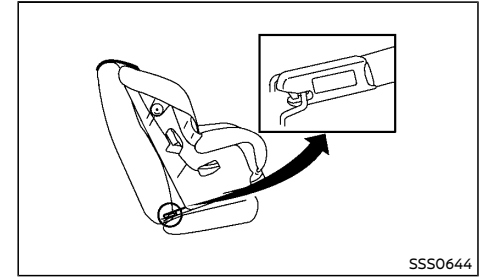

#### Anchor attachment

ISOFIX child restraints include two rigid attachments that can be connected to two anchors located in the seat. With this system, you do not have to use a vehicle seat belt to secure the child restraint. Check your child restraint for a label stating that it is compatible with the ISOFIX child restraints. This information may also be in the instructions provided by the child restraint manufacturer.

ISOFIX child restraints generally require the use of a top tether strap or other anti-rotation devices such as support legs. When installing ISOFIX child restraints, carefully read and follow the instructions in this manual and those supplied with the child restraints. See "Child restraint installation using ISOFIX (for second row seats)" (P.1-23).



## CHILD RESTRAINT ANCHORAGE (for second row seats)

Your vehicle is designed to accommodate a child restraint system on the second row seat. When installing a child restraint system, carefully read and follow the instructions in this manual and those supplied with the child restraint system.

### WARNING:

- Child restraint anchorages are designed to withstand only those loads imposed by correctly fitted child restraints. Under no circumstances are they to be used for adult seat belts, harnesses or for attaching other items or equipment to the vehicle. Doing so could damage the child restraint anchorages. The child restraint will not be properly installed using the damaged anchorage, and a child could be seriously injured or killed in a collision.
- The child restraint top tether strap may be damaged by contact with items in the luggage area. Secure any luggage. Your child could be seriously injured or killed in a collision if the top tether strap is damaged.

## Anchorage location

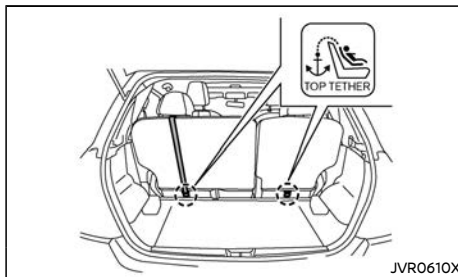

Second row seats

Anchorages are located as illustrated.

Position the top tether strap over the top of the seatback and secure it to the tether anchorage that provides the straightest installation. Tighten the tether strap according to the manufacturer's instruction to remove any slack.

## CHILD RESTRAINT INSTALLATION USING ISOFIX (for second row seats)

### WARNING:

- Attach ISOFIX child restraints only at the specified locations. For the ISOFIX lower anchor locations, see "ISOFIX child restraint system (for second row seats)" (P.1-22). If a child restraint is not secured properly, your child could be seriously injured or killed in an accident.
- Do not install child restraints that require the use of a top tether strap to seating positions that do not have a top tether anchor.
- Do not secure a child restraint in the second row center seating position using the ISOFIX lower anchors. The child re-

straint will not be secured properly.

- Inspect the lower anchors by inserting your fingers into the lower anchor area and feeling to make sure there are no obstructions over the ISOFIX anchors, such as seat belt webbing or seat cushion material. The child restraint will not be secured properly if the ISOFIX anchors are obstructed.
- Child restraint anchorages are designed to withstand only those loads imposed by correctly fitted child restraints. Under no circumstances are they to be used for adult seat belts, harnesses or for attaching other items or equipment to the vehicle. Doing so could damage the child restraint anchorages. The child restraint will not be properly installed using the damaged anchorage, and a child could be seriously injured or killed in a collision.
- Slide the seat to the rearmost position before installing a child restraint system.

Installation on second row outboard seats

### Front-facing:

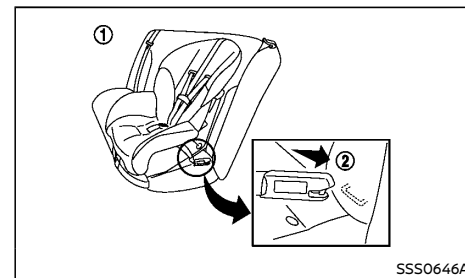

Front-facing: Steps 1 and 2

Be sure to follow the manufacturer's instruc-

tions for the proper use of your child restraint. Follow these steps to install a front-facing child restraint on the second row outboard seats using ISOFIX:

1. Position the child restraint on the seat ①.
2. Secure the child restraint anchor attachments to the ISOFIX lower anchors ②.
3. The back of the child restraint should be secured against the vehicle seatback. Remove the head restraint to obtain the correct child restraint fit. (See "Head restraints" (P.1-9).) Store the removed head restraint in a secure place. Be sure to install the head restraint when the child restraint is removed. If the seating position does not have an adjustable head restraint and it is interfering with the proper child restraint fit, try another seating position or a different child restraint.

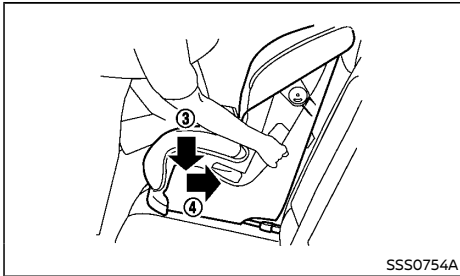

**Front-facing: Step 4**

4. Shorten the rigid attachment to have the child restraint firmly tightened; press downward ③ and rearward ④ firmly in the center of the child restraint with your knee to compress the vehicle seat cushion and seatback.



**WARNING:**

**Adjustable seatbacks should be positioned to ensure full contact between child restraint and seatback.**

5. If the child restraint is equipped with a top tether strap, route the top tether strap and secure the tether strap to the tether anchor point. (See "Child restraint anchorage (for second row seats)" (P.1-23).)
6. If the child restraint is equipped with other anti-rotation devices such as support legs, use them instead of the top tether strap following the child restraint manufacturer's instructions.

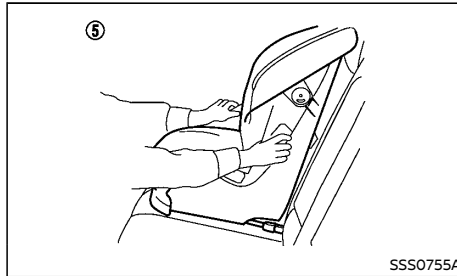

**Front-facing: Step 7**

7. Test the child restraint before you place the child in it ⑤. Push the child restraint from side to side and tug it forward to make sure that it is held securely in place.
8. Check to make sure that the child restraint is properly secured prior to each use. If the child restraint is loose, repeat steps 3 through 7.

**Rear-facing:**

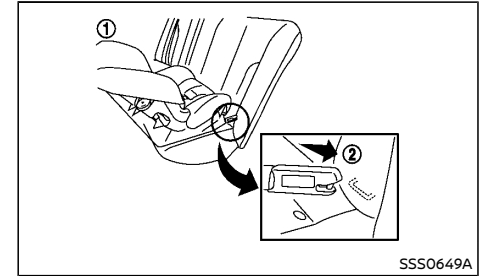

**Rear-facing: Steps 1 and 2**

Be sure to follow the manufacturer's instructions for the proper use of your child restraint. Follow these steps to install a rear-facing child restraint on the second row outboard seats using ISOFIX:

1. Position the child restraint on the seat ①.
2. Secure the child restraint anchor attachments to the ISOFIX lower anchors ②.

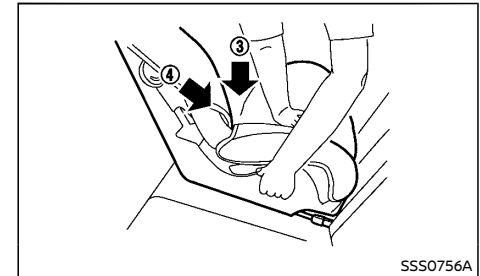

**Rear-facing: Step 3**

3. Shorten the rigid attachment to have the child restraint firmly tightened; press downward ③ and rearward ④ firmly in the center of the child restraint with your hand to

compress the vehicle seat cushion and seatback.

4. If the child restraint is equipped with a top tether strap, route the top tether strap and secure the tether strap to the tether anchor point. (See "Child restraint anchorage (for second row seats)" (P.1-23).)
5. If the child restraint is equipped with other anti-rotation devices such as support legs, use them instead of the top tether strap following the child restraint manufacturer's instructions.

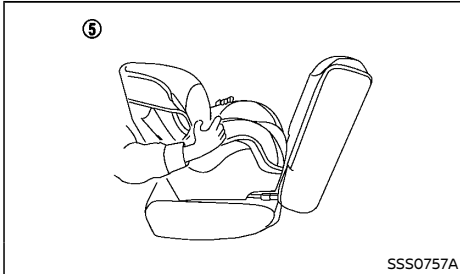

**Rear-facing: Step 6**

6. Test the child restraint before you place the child in it ⑤. Push the child restraint from side to side and tug it forward to make sure that it is held securely in place.
7. Check to make sure that the child restraint is properly secured prior to each use. If the child restraint is loose, repeat steps 3 through 6.

## CHILD RESTRAINT INSTALLATION USING THREE-POINT TYPE SEAT BELT

Installation on second and third row seats



### WARNING:

- Do not attempt to install a child restraint system in the second row center seat.
- The second row center seat is not suitable for installing a child restraint system. Installing a child restraint to the second row center seat may result in a serious injury or death.
- If you install a child restraint system in the second row outer seat, slide the seat to the rearmost position before installing a child restraint system.

### Front-facing:

Be sure to follow the manufacturer's instructions for the proper use of your child restraint. Follow these steps to install a front-facing child restraint on the second or third row seats using three-point type seat belt:

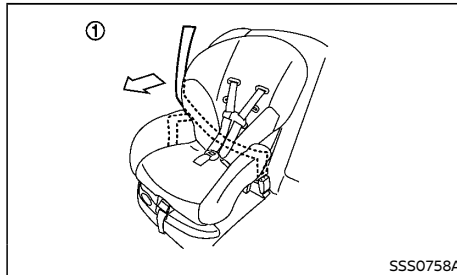

**Front-facing: Step 1**

1. Position the child restraint on the seat ①. If any contact occurs between the child restraint and the front seat, slide the front seat forward until contact no longer occurs. Remove the head restraint to obtain the correct child restraint fit. Once removed, store the head restraint in a secure location.

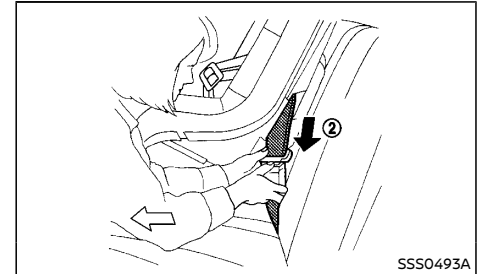

**Front-facing: Step 2**

2. Route the seat belt tongue through the child restraint and insert it into the buckle ② until you hear and feel the latch engage.
3. To prevent slack in the seat belt webbing, it is necessary to secure the seat belt in place with locking devices attached to the child restraint.

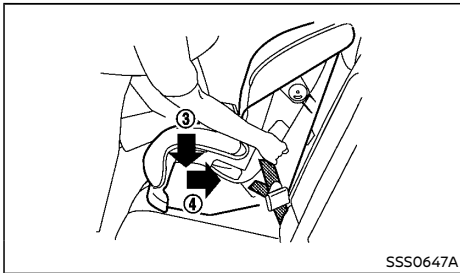

**Front-facing: Step 4**

- Remove any additional slack from the seat belt; press downward ③ and rearward ④ firmly in the center of the child restraint with your knee to compress the vehicle seat cushion and seatback while pulling up on the seat belt. Adjustable seatbacks should be positioned to ensure full contact between child restraint and seatback.

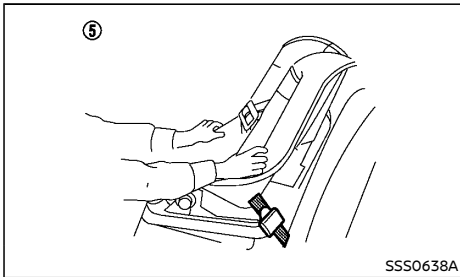

**Front-facing: Step 5**

- Test the child restraint before you place the child in it ⑤. Push the child restraint from side to side and tug it forward to make sure that it is held securely in place.

- Check to make sure that the child restraint is properly secured prior to each use. If the child restraint is loose, repeat steps 3 through 5.

**Rear-facing:**

Be sure to follow the manufacturer's instructions for the proper use of your child restraint. Follow these steps to install a rear-facing child restraint on the second or third row seats using three-point type seat belt:

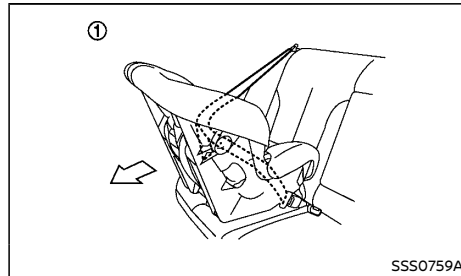

**Rear-facing: Step 1**

- Position the child restraint on the seat ①.

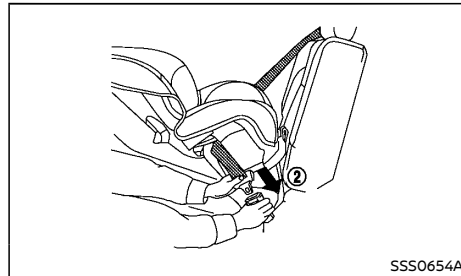

**Rear-facing: Step 2**

- Route the seat belt tongue through the child restraint and insert it into the buckle ② until you hear and feel the latch engage.
- To prevent slack in the seat belt webbing, it is necessary to secure the seat belt in place with locking devices attached to the child restraint.

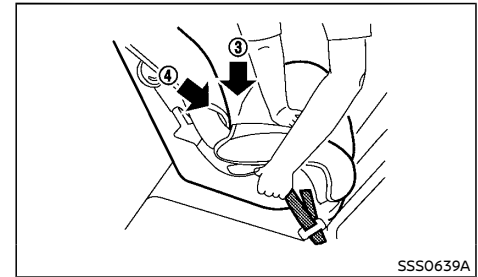

**Rear-facing: Step 4**

- Remove any additional slack from the seat belt; press downward ③ and rearward ④ firmly in the center of the child restraint with your hand to compress the vehicle seat cushion and seatback while pulling up on the seat belt.

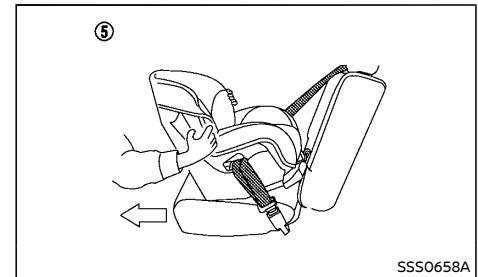

**Rear-facing: Step 5**

5. Test the child restraint before you place the child in it ⑤. Push the child restraint from side to side and tug it forward to make sure that it is held securely in place.
6. Check to make sure that the child restraint is properly secured prior to each use. If the child restraint is loose, repeat steps 3 through 5.

### Installation on front passenger's seat

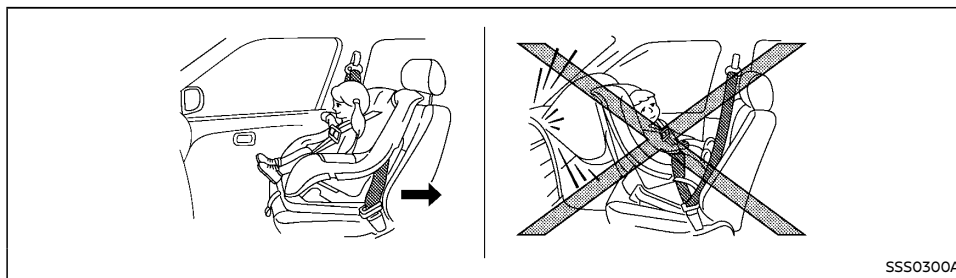

#### WARNING:

- **Never install a rear-facing child restraint system on the front seat. Supplemental front-impact air bags inflate with great force. A rear-facing child restraint system could be struck by the supplemental front-impact air bags in an accident and could seriously injure or kill your child.**
- **NISSAN recommends that a child restraint be installed on the rear seat. However, if you must install a front facing child restraint system on the front passenger's seat, move the passenger's seat to the rearmost position.**
- **Never install a child restraint system with a top tether strap on the front seat.**
- **Child restraint system for infants must be used in the rear-facing direction and therefore must not be used on the front seat.**
- **Failure to use the seat belts will result in the child restraint system not being properly secured. It could tip over or otherwise be unsecured and cause injury**

**to the child in a sudden stop or collision.**

#### Front-facing:

Be sure to follow the manufacturer's instructions for the proper use of your child restraint. Follow these steps to install a front-facing child restraint on the front passenger's seat using three-point type seat belt without automatic locking mode:

1. Move the seat to the rearmost position ①.

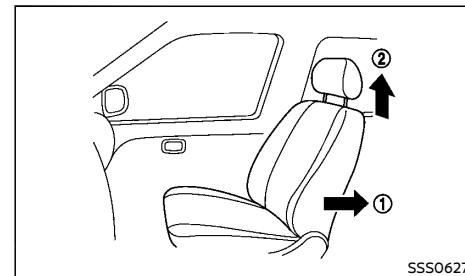

Front-facing: Steps 1 and 2

- Adjust or remove the head restraint ②.
- Position the child restraint in the seat.

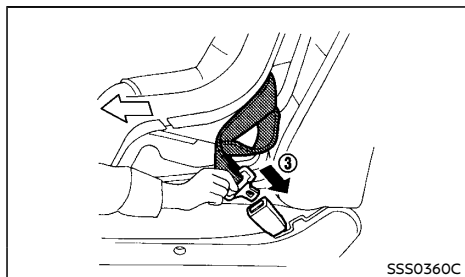

Front-facing: Step 4

- Route the seat belt tongue through the child restraint and insert it into the buckle ③ until you hear and feel the latch engage.
- To prevent slack in the seat belt webbing, it is necessary to secure the seat belt in place with locking devices attached to the child restraint.

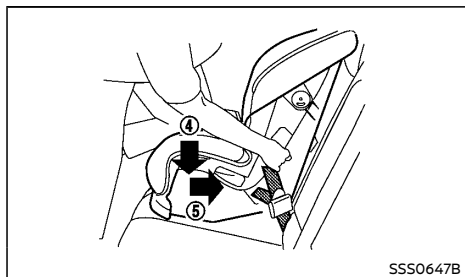

Front-facing: Step 6

- Remove any additional slack from the seat belt; press downward ④ and rearward ⑤ firmly in the center of the child restraint with your knee to compress the vehicle

seat cushion and seatback while pulling up on the seat belt.

**⚠ WARNING:**

**Adjustable seatbacks should be positioned to ensure full contact between child restraint and seatback.**

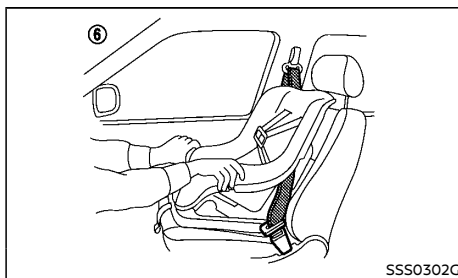

Front-facing: Step 7

- Test the child restraint before you place the child in it ⑥. Push the child restraint from side to side and tug it forward to make sure that it is held securely in place.
- Check to make sure that the child restraint is properly secured prior to each use. If the child restraint is loose, repeat steps 5 through 7.

**CHILD RESTRAINT INSTALLATION USING TWO-POINT TYPE SEAT BELT (if equipped)**

**⚠ WARNING:**

- Do not attempt to install a child restraint system using the two-point type seat belt.
- The seat position with two-point type seat belt is not suitable for installing a child restraint system. Installing a child restraint using the two-point type seat belt may result in a serious injury or death.

## SUPPLEMENTAL RESTRAINT SYSTEM (SRS)

### PRECAUTIONS ON SUPPLEMENTAL RESTRAINT SYSTEM (SRS)

This Supplemental Restraint System (SRS) section contains important information concerning the driver's and passenger's supplemental front-impact air bags, supplemental side-impact air bags (if equipped), supplemental curtain side-impact air bags (if equipped) and pretensioner seat belts.

#### Supplemental front-impact air bag system

This system can help cushion the impact force to the head and chest area of the driver and/or front passenger in certain frontal collisions. The supplemental front-impact air bag is designed to inflate on the front where the vehicle is impacted.

#### Supplemental side-impact air bag system (if equipped)

This system can help cushion the impact force to the chest and pelvis area of the driver and front passenger in certain side-impact collisions. The supplemental side-impact air bag is designed to inflate on the side where the vehicle is impacted.

#### Supplemental curtain side-impact air bag system (if equipped)

This system can help cushion the impact force to the head of the driver and passengers in front seating positions and rear (second and third) outboard seating positions in certain side-impact collisions. The supplemental curtain side-impact air bag is designed to inflate on the side where the vehicle is impacted.

The SRS is designed to **supplement** the accident protection provided by the driver's and passenger's seat belts and **is not** designed to

**substitute** for them. The SRS can help save lives and reduce serious injuries. However, inflating air bags may cause abrasions or other injuries. Air bags do not provide protection to the lower body. Seat belts should always be correctly worn and the occupants should always be seated a suitable distance away from the steering wheel, instrument panel and door finishers. (See "Seat belts" (P.1-11).) The air bags inflate quickly in order to help protect the occupants. The force of the air bags inflating can increase the risk of injury if the occupants are too close to, or are against, the air bag modules during inflation. The air bags will deflate quickly after deployment.

**The SRS operates only when the ignition switch is in the "ON" position.**

**When the ignition switch is in the "ON" position, the SRS air bag warning light illuminates for about 7 seconds and then turns off. This indicates that the SRS is operational. (See "Warning lights, indicator lights and audible reminders" (P.2-12).)**

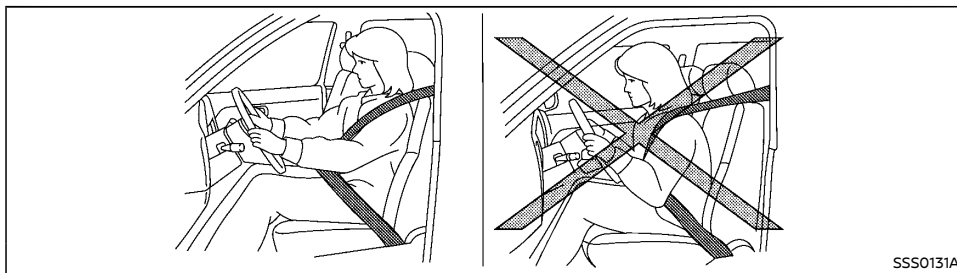

SSS0131A

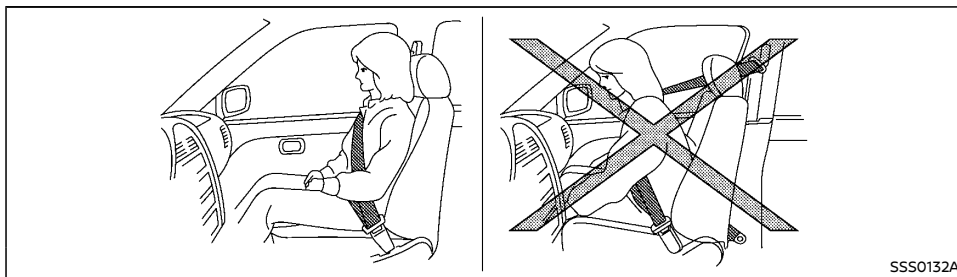

SSS0132A

if the supplemental front air bag inflates.

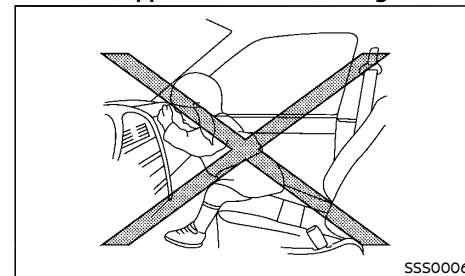

SSS0006

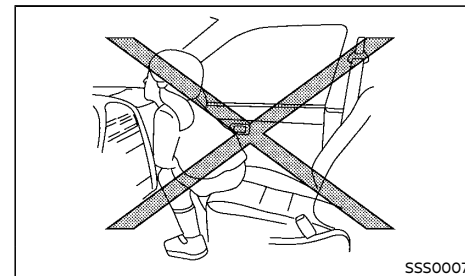

SSS0007

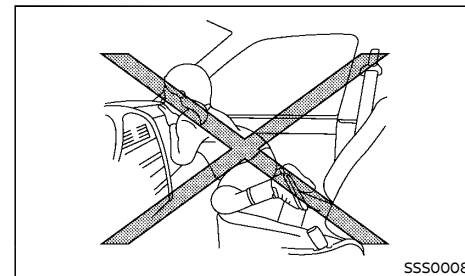

SSS0008

**WARNING:**

- The supplemental front air bags ordinarily will not inflate in the event of a side impact, rear impact, rollover, or lower severity frontal collision. Always wear your seat belts to help reduce the risk or severity of injury in various kinds of accidents.
- The seat belts and the supplemental front-impact air bags are most effective when you are sitting well back and upright in the seat. The front-impact air bags inflate with great force. If you and your passengers are unrestrained, lean-

ing forward, sitting sideways, or out of position in any way, you and your passengers are at greater risk of injury or death in an accident. You and your passengers may also receive serious or fatal injuries from the supplemental front-impact air bag if you are up against it when it inflates. Always sit back against the seatback and as far away as practical from the steering wheel or instrument panel. Always use the seat belts.

- Keep hands on the outside of the steering wheel. Placing them inside the steering wheel rim could increase the risk of injury



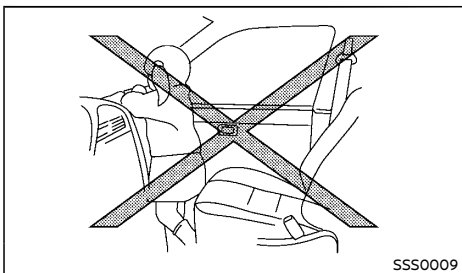

**⚠ WARNING:**

- Never let children ride unrestrained or extend their hands or face out of the window. Do not attempt to hold them in your lap or arms. Some examples of dangerous riding positions are shown in the illustrations.
- Children may be severely injured or killed when the air bags inflate if they are not properly restrained.
- Never install a rear-facing child restraint system in the front seat. An inflating supplemental front-impact air bag could seriously injure or kill your child. (See "Child restraints" (P.1-16).)

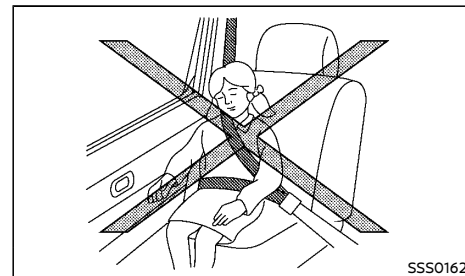
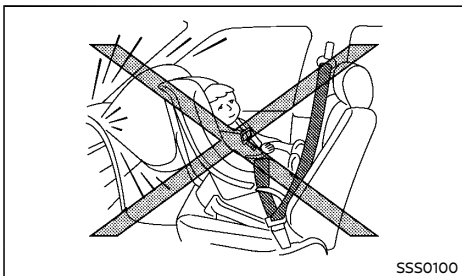
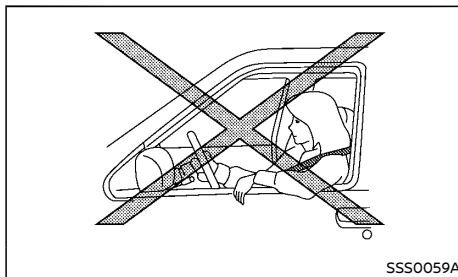
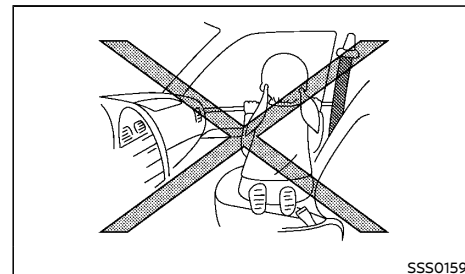
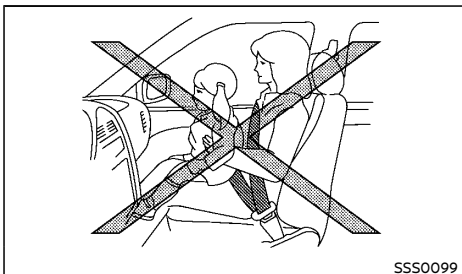
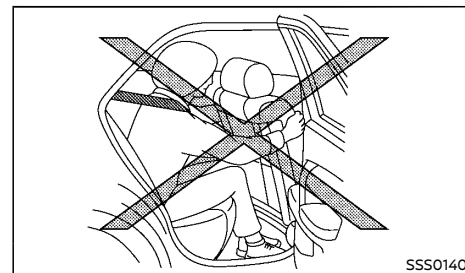

**WARNING:**

- The supplemental side-impact air bags (if equipped) and supplemental curtain side-impact air bags (if equipped) ordinarily will not inflate in the event of a front impact, rear impact, rollover, or lower severity side collision. Always wear the seat belts to help reduce the risk or severity of injury in accidents.
- The seat belts and the supplemental side-impact air bags and supplemental curtain side-impact air bags are most effective when you are sitting well back and upright in the seat. The supplemental side-impact air bags and supplemental curtain side-impact air bags inflate with great force. If you and your passengers are unrestrained, leaning forward, sitting sideways, or out of position in any way, you and your passengers are at greater risk of injury or death in an accident.
- Do not allow anyone to place their hands, legs or face near the supplemental side-impact air bags and supplemental curtain side-impact air bags located on the sides of the seatback of the front seats or near the side roof rails. Do not allow anyone sitting in the front seats or rear outboard seats to extend their hands out of the windows or lean against the doors. Some examples of dangerous riding positions are shown in the illustrations.
- When sitting in the rear seats, do not hold onto the seatback of the front seats. If the supplemental side-impact air bags and supplemental curtain side-impact air bags inflate, you may be seriously injured. Be especially careful with children, who should always be properly re-

strained.

- Do not use seat covers on the front seatbacks. They may interfere with the supplemental side-impact air bag inflations.

### Pre-tensioner seat belt system

The pre-tensioner seat belt system may activate with the supplemental air bag system in certain types of collisions. Working with the seat belt retractor and anchor, it helps tighten the seat belt the instant the vehicle becomes involved in certain types of collisions, helping to restrain occupants. (See "Pre-tensioner seat belt system" (P.1-37).)

### Air bag warning labels

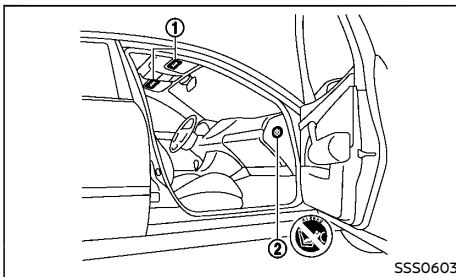

Label location

Warning labels about the supplemental front-impact air bag system are placed in the vehicle as shown in the illustration.

The warning label ① is located on the surface of the driver's and/or passenger's sun visor.

The warning label ② (if equipped) is located on the side of the passenger's side instrument panel.

The label(s) warn you not to fit a rear-facing

child restraint system on the front passenger seat as such a restraint system used in this position could cause serious injury to the infant in case of air bag deployment during a collision.



① Air bag warning label

The label ① warns:

"NEVER use a rearward facing child restraint on a seat protected by an ACTIVE AIRBAG in front of it, DEATH or SERIOUS INJURY to the CHILD can occur."

In vehicles equipped with a front-impact passenger air bag system, use a rear-facing child restraint system only on the rear seats.

When installing a child restraint system in your vehicle, always follow the child restraint system manufacturer's instructions for installation. For additional information, see "Child restraints" (P.1-16).

## SRS air bag warning light



The SRS air bag warning light, displaying  in the instrument panel, monitors the circuits for the air bag systems, pre-tensioner seat belt systems and all related wiring.

When the ignition switch is in the "ON" position, the SRS air bag warning light illuminates for about 7 seconds and then turns off. This indicates that the SRS air bag systems are operational.

If any of the following conditions occur, the air bag and/or pre-tensioner seat belt system need servicing:

- The SRS air bag warning light remains on after approximately 7 seconds.
- The SRS air bag warning light does not illuminate at all.

Under these conditions, the air bag and/or pre-tensioner seat belt system may not operate properly. They must be checked and repaired. Contact a NISSAN dealer immediately.

## SUPPLEMENTAL AIR BAG SYSTEMS

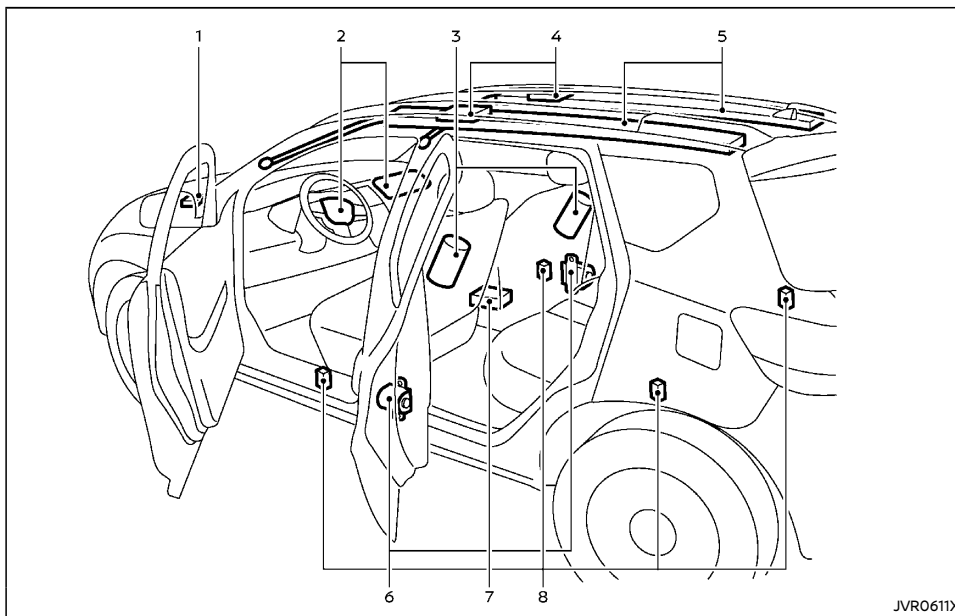

1. Crash zone sensor
2. Supplemental front-impact air bag modules
3. Supplemental side-impact air bag modules (if equipped)
4. Supplemental curtain side-impact air bag inflators (if equipped)
5. Supplemental curtain side-impact air bag modules (if equipped)
6. Pre-tensioner seat belt retractors
7. Air bag Control Unit (ACU)
8. Satellite sensors (if equipped)



### WARNING:

- **Do not place any objects on the steering wheel pad, on the instrument panel, under the steering column and near the front door finishers and the front seats. Do not place any objects between any**

occupants and the steering wheel pad, on the instrument panel, and near the front door finishers and the front seats. Such objects may become dangerous projectiles and cause injury if a supplemental air bag inflates.

- Immediately after inflation, several supplemental air bag system components will be hot. Do not touch them: you may severely burn yourself.
- No unauthorized changes should be made to any components or wiring of the supplemental air bag systems. This is to prevent accidental inflation of the supplemental air bags or damage to the supplemental air bag systems.
- Do not make unauthorized changes to your vehicle's electrical system, suspension system, front end structure, and side panels. This could affect proper operation of the supplemental air bag systems.
- Tampering with the supplemental air bag systems may result in serious personal injury. Tampering includes changes to the steering wheel and the instrument panel by placing materials over the steering wheel pad and above, around or on the instrument panel or by installing additional trim materials around the supplemental air bag systems.
- Work on and around the supplemental air bag systems should be done by a NISSAN dealer. The SRS wiring should not be modified or disconnected. Unauthorized electrical test equipment and probing devices should not be used on the supplemental air bag systems.
- The SRS wiring harness connectors are yellow for easy identification.

When the air bags inflate, a fairly loud noise

may be heard, followed by the release of smoke. This smoke is not harmful and does not indicate a fire. Care should be taken not to inhale it, as it may cause irritation and choking. Those with a history of a breathing condition should get fresh air promptly.

#### Supplemental front-impact air bag system

The driver's supplemental front-impact air bag is located at the center of the steering wheel. The passenger's supplemental front-impact air bag is located at the instrument panel above the glove box.

The supplemental front-impact air bag system is designed to inflate in higher severity frontal collisions, although it may inflate if the forces in another type of collision are similar to those of a higher severity frontal impact. It may not inflate in certain frontal collisions. Vehicle damage (or lack of it) is not always an indication of proper supplemental front-impact air bag system operation.

#### Supplemental side-impact air bag system (if equipped)

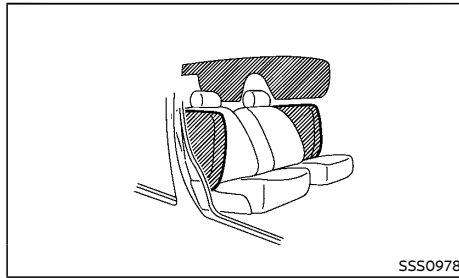

The supplemental side-impact air bag is located at the outside of the front seats' seat-

backs.

The supplemental side-impact air bag system is designed to inflate in higher severity side collisions, although it may inflate if the forces in another type of collision are similar to those of a higher severity side impact. It may not inflate in certain side collisions. Vehicle damage (or lack of it) is not always an indication of proper supplemental side-impact air bag system operation.

#### Supplemental curtain side-impact air bag system (if equipped)

The supplemental curtain side-impact air bag is located at the roof rails.

The supplemental curtain side-impact air bag system is designed to inflate in higher severity side collisions, although it may inflate if the forces in another type of collision are similar to those of a higher severity side impact. It may not inflate in certain side collisions. Vehicle damage (or lack of it) is not always an indication of proper supplemental curtain side-impact air bag system operation.

#### SRS AIR BAG DEPLOYMENT CONDITIONS

The SRS air bags activate in the event of a front or side impact in which the vehicle occupants may be severely injured even if they are wearing the seat belts properly.

They may not activate when the crash energy is absorbed and/or distributed by the vehicle body. Vehicle damage (or lack of it) is not always an indication of proper SRS air bag system operation.

When the SRS air bag will deploy

**Supplemental front-impact air bags:**

The supplemental front-impact air bag system is designed to inflate in higher severity frontal collisions. Some examples are shown in the following illustrations.

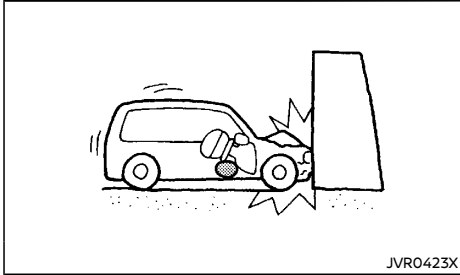

The supplemental front-impact air bag system will deploy in the event of an impact which exceeds a 25 km/h (16 MPH) frontal collision with a solid wall that does not move or deform.

The supplemental front-impact air bag system may also deploy when the vehicle receives severe damage to the undercarriage.

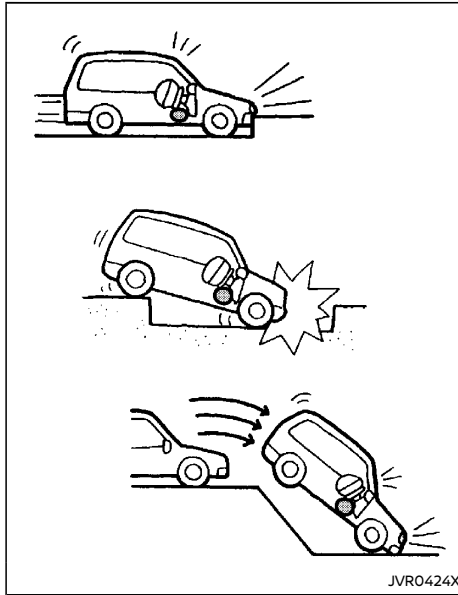

- Hitting a curb, pavement edge or hard surface at high speed
- Falling into a deep hole or ditch
- Landing hard on the ground after jumping

**Supplemental side-impact and curtain side-impact air bags (if equipped):**

The supplemental side-impact and curtain side-impact air bag systems are designed to inflate in higher severity side collisions. Some examples are shown in the following illustrations.

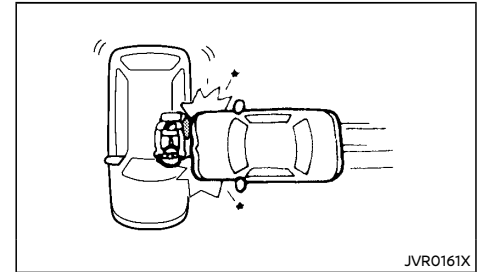

(supplemental side-impact air bag system)

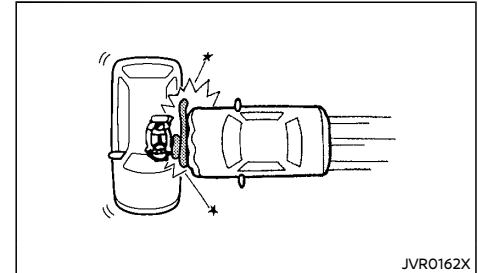

(supplemental curtain side-impact air bag system)

- The supplemental side-impact and curtain side-impact air bags will deploy in the event of a side impact with a normal passenger vehicle that exceeds at a speed of 25 km/h (16 MPH).

When the SRS air bag is unlikely to deploy

The SRS air bags may not deploy in cases where the impact is not forceful enough to inflate the SRS air bags.

For example, if the vehicle strikes an object, such as a parked vehicle or sign pole, which can move or deform on impact, the SRS air bags are unlikely to deploy.

### Supplemental front-impact air bags:

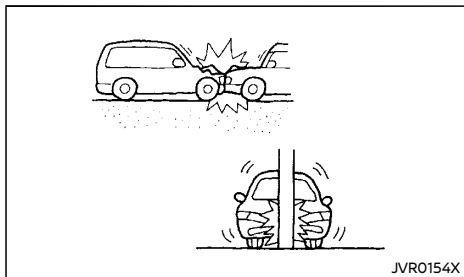

- Striking a vehicle of the same class that is parked
- Crashing into a solid utility pole

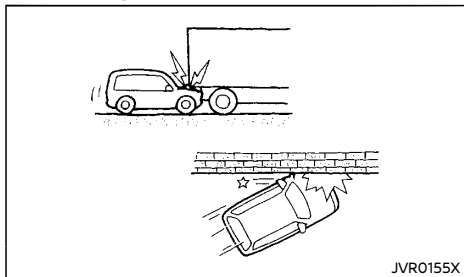

- Running under the tailgate of a truck
- A frontal offset impact to the guard rails

### Supplemental side-impact and curtain side-impact air bags (if equipped):

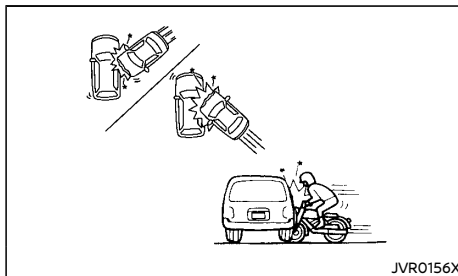

- A collision from the side at an angle
- A side impact with a two-wheeled vehicle

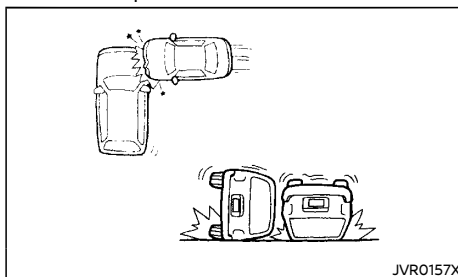

- A collision from the side impacting the vehicle engine room (cargo area)
- Vehicle rollover

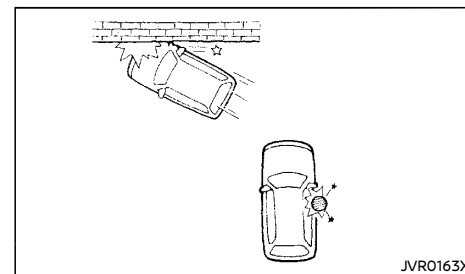

- A frontal offset impact to the guard rails
- A collision with a pole

### When the SRS air bag will not deploy

Once the SRS air bag has inflated, the air bag module will not function again if your vehicle collides with another vehicle or an object.

Other examples where the SRS air bag will not deploy are shown in the following illustrations.

### Supplemental front-impact air bags:

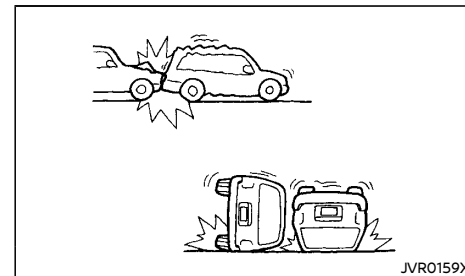

- A collision from the side or rear
- Vehicle rollover

### Supplemental side-impact and curtain side-impact air bags (if equipped):

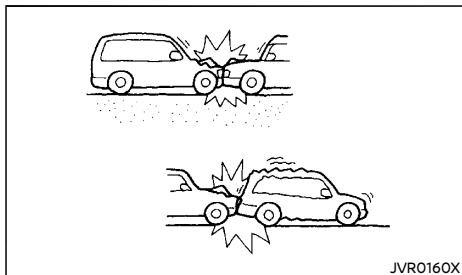

- A frontal collision with a parked or moving vehicle
- A rear collision

### PRE-TENSIONER SEAT BELT SYSTEM

#### **WARNING:**

- **The pre-tensioner seat belt cannot be reused after activation. It must be replaced together with the retractor and buckle as a unit.**
- **If the vehicle becomes involved in a collision but the pre-tensioner is not activated, be sure to have the pre-tensioner system checked and, if necessary, replaced by a NISSAN dealer.**
- **No unauthorized changes should be made to any components or wiring of the pre-tensioner seat belt system. This is to prevent accidental activation of the pre-tensioner seat belt or damage to the pre-tensioner seat belt system.**

- **Work around or on the pre-tensioner seat belt system should be done by a NISSAN dealer. The SRS wiring should not be modified or disconnected. Unauthorized electrical test equipment and probing devices should not be used on the pre-tensioner seat belt system.**
- **If you need to dispose of the pre-tensioner seat belt system, or scrap the vehicle, contact a NISSAN dealer. Correct pre-tensioner disposal procedures are set forth in the appropriate NISSAN Service Manual. Incorrect disposal procedures could cause personal injury.**

The pre-tensioner seat belt system may activate with the supplemental air bag system in certain types of collisions. Working with the seat belt retractor and anchor, it helps tighten the seat belt the instant the vehicle becomes involved in certain types of collisions, helping to restrain occupants.

The pre-tensioner is encased with the front seat belt's retractor and anchor. These seat belts are used the same as conventional seat belts.

When the pre-tensioner seat belt activates, a fairly loud noise may be heard, followed by the release of smoke. This smoke is not harmful and does not indicate a fire. Care should be taken not to inhale it, as it may cause irritation and choking. Those with a history of a breathing condition should get fresh air promptly.

### REPAIR AND REPLACEMENT PROCEDURE

#### **WARNING:**

- **Once the air bags have been inflated, the air bag modules will not function and must be replaced. The air bag modules must be replaced by a NISSAN dealer. The inflated air bag modules cannot be repaired.**
- **The air bag systems should be inspected by a NISSAN dealer if there is any damage to the vehicle.**
- **If you need to dispose of the SRS or scrap the vehicle, contact a NISSAN dealer. Correct disposal procedures are set forth in the appropriate NISSAN Service Manual. Incorrect disposal procedures could cause personal injury.**

The air bags and pre-tensioner seat belts are designed to activate on a one-time-only basis. As a reminder, unless the SRS air bag warning light is damaged, the SRS air bag warning light remains illuminated after inflation has occurred. The repair and replacement of the SRS should be done only by a NISSAN dealer.

When maintenance work is required on the vehicle, information about the air bags, pre-tensioner seat belts and related parts should be pointed out to the person performing the maintenance. The ignition switch should always be in the "LOCK" position when working under the hood or inside the vehicle.

## EMERGENCY SERVICES CALL ECALL/SOS SYSTEM (if equipped)

Your vehicle is equipped with the 999-based in-vehicle emergency services call system (eCall). In the event of a serious road accident emergency, an automatic call can be made to the emergency services operator. The system can also be used manually to call the emergency services operator. The 999-based eCall service is a public service of general interest and is accessible free of charge. NISSAN is responsible only for the emergency communication system technical performance in the event of an accident within the warranty period. The 999-based eCall service can be used only in countries which have emergency services operator.



### WARNING:

- **Radio waves could adversely affect electric medical equipment. Individuals who use a pacemaker should contact the device manufacturer regarding any possible effects before using the system.**
- **The TCU (Telematics Control Unit) antenna is installed inside the upper central part of the instrument panel. An occupant should not get any closer to the antenna than specified by the pacemaker manufacturer. The radio waves from the TCU (Telematics Control Unit) antenna may adversely affect the operation of the pacemaker.**
- **Inappropriate use of the service may be a violation of local laws and result in a criminal penalty.**

## AUTOMATIC EMERGENCY CALL

If the air bag control unit detects a frontal collision, side collision or rear collision (if equipped) the system automatically places an emergency call to the emergency call center. At the same time, the vehicle information is also transferred. Once an emergency call is received by the emergency call center, the operator tries to talk to the vehicle's occupant.

### NOTE:

- **During the emergency call, the volume of the voice of the operator cannot be adjusted.**
- **During the emergency call, the volume of the vehicle audio will be muted.**

The eCall system is always enabled by default. It is activated automatically by means of in-vehicle sensors in the event of a severe accident.

The eCall system is not traceable and is not subject to any constant tracking in its normal operational status. Data in the internal memory of the system is not available outside the in-vehicle system to any entities before the eCall is triggered.

Any processing of personal data through the 999-based eCall in-vehicle system shall comply with the personal data protection rules provided for in Directives 95/46/EC and 2002/58/EC of the European Parliament and of the Council, and in particular, shall be based on the necessity to protect the vital interests of the individuals in accordance with Article 7(d) of Directive 95/46/EC.

Processing of such data is strictly limited to the purpose of handling the emergency eCall to emergency number 999. Recipients of data processed by the 999-based eCall in-vehicle

system are the relevant public safety answering points designated by the respective public authorities of the country on which territory they are located, to first receive and handle eCalls to the emergency number 999.

The following information will be sent to the emergency call center by the vehicle emergency call system if a collision occurs:

- Vehicle Identification Number (VIN)
- Vehicle type
- Fuel type
- Activation type (Automatic/Manual)
- Call type (Test/Emergency)
- Position (Trusted/Low confidence)
- Time stamp (when the collision or event occurred)
- Last three vehicle locations, and vehicle direction
- Number of passengers (if equipped)

The 999-based eCall in-vehicle system is designed in such a way as to ensure that data in the system internal memory is automatically and continuously removed.

The vehicle location data is constantly overwritten in the internal memory of the system so as always to keep maximum of the last three up-to-date locations of the vehicle necessary for the normal functioning of the system.

The log of activity data in the 999-based eCall in-vehicle system is kept for no longer than necessary for attaining the purpose of handling the emergency eCall and in any case not beyond 13 hours from the moment an emergency eCall was initiated.



**CAUTION:**

- The automatic emergency call will only be triggered if the vehicle air bag system is activated during the collision.
- If the automatic emergency call has been triggered, bring your vehicle to a NISSAN dealer. This is necessary because the automatic emergency call system needs to be reset to avoid any unintended eCall being made.
- The mobile network provider that manages the connection from the vehicle to the emergency call center is specified and controlled outside of the vehicle emergency call system.
- Within the first minute of any emergency call the operator will determine if the call is genuine. Should the operator determine it is a nongenuine call they will stop the call, making no further attempts to call the vehicle back. This action does not prevent the occupant(s) of the vehicle from making a further manual emergency call.

The emergency call function cannot be used in the following conditions:

- The vehicle is outside the area where mobile network service is receivable.
- The vehicle is in a location with poor signal reception such as tunnels, underground parking garages, between buildings or in mountainous areas.
- The TCU (Telematics Control Unit) or other systems of your vehicle are not working properly.
- The available mobile network provider at the location of the vehicle is not specified

for emergency call usage.

- The communication line of the emergency call center is busy.

### MAKING AN EMERGENCY CALL MANUALLY

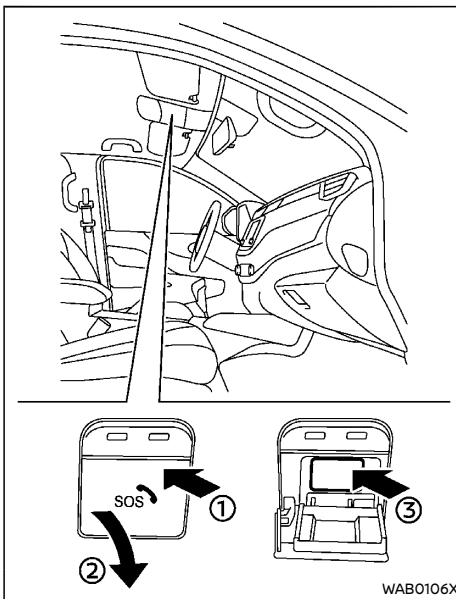

The manual emergency call can be performed with the ignition switch placed in the "ON" position, by pushing the SOS call switch ③ located on the overhead control panel.

After the ignition switch is placed in the "OFF" position, if an emergency call was not made,

the eCall system is turned off.

**CAUTION:**

- Park the vehicle in a safe location and apply the parking brake before operating the SOS call switch.
  - Use this service only in case of an emergency. There may be a penalty for inappropriate use of the service.
1. Place the ignition switch in the "ON" position.
  2. Push ① and open the cover ②.
  3. Push the SOS call switch ③. An emergency call is sent to the emergency call center. At the same time, the vehicle information is also transferred.
  4. When the call is connected, speak to the emergency support staff.

If you want to cancel the emergency call, push and hold the SOS call switch for a few seconds. The call cannot be cancelled after connection.

**NOTE:**

- During the emergency call, the volume of the voice of the operator cannot be adjusted.
- During the emergency call, the volume of the vehicle audio will be muted.
- After the SOS call switch is pushed, it may take some time until the system initiates connection, depending on the technical environment and whether the TCU is being used by other services.
- To avoid disconnecting the call, do not turn the engine off.
- During the emergency call, Bluetooth® Hands-Free Phone connection will be disabled and phone operation will only

be available by mobile phone. Upon connection to the emergency call staff, the phone connection will be switched automatically from the Hands-Free Phone to the mobile phone. This is to avoid connections with the emergency support staff being interrupted by incoming calls.

- If the emergency call is disconnected for some reason, the emergency call center may call back. This action does not prevent the occupant(s) of the vehicle from making another manual emergency call.

#### INDICATOR LIGHTS

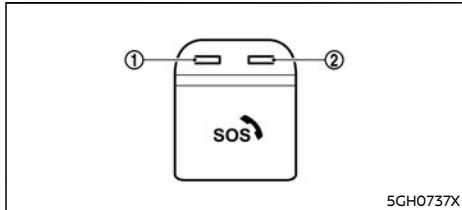

- ① Red indicator
- ② Green indicator

When the green indicator light ② is illuminated, the emergency call is available and working.

The red indicator light ① indicates the status of the vehicle emergency call system. If the indicator light is illuminated red or no light is illuminated the emergency call may not connect to the emergency call center when the SOS call switch is pressed. Also an automatic emergency call may not be sent when a collision occurs.

- During vehicle start up, the system operates self diagnostics and the red indicator light is illuminated for up to 15 seconds.
- At any other time if the red indicator light ① is illuminated contact a NISSAN dealer for assistance. In the event of a critical system failure that would disable the 999-based eCall in-vehicle system, the red indicator light is illuminated as a warning.

#### NOTE:

If the indicator light ① is illuminated red or no light is illuminated, emergency services (such as the police or other agencies) should be contacted using other normal communication devices (for example a phone) in the event of an accident.

#### MODALITIES FOR EXERCISING DATA SUBJECT'S RIGHTS

The data subject (the vehicle's owner) has a right of access to data and as appropriate to request the rectification, erasure or blocking of data, concerning him or her, the processing of which does not comply with the provisions of Directive 95/46/EC. Any third parties to whom the data have been disclosed have to be notified of such rectification, erasure or blocking carried out in compliance with this Directive, unless it proves impossible or involves a disproportionate effort.

The data subject has a right to complain to the competent data protection authority if he or she considers that his or her rights have been infringed as a result of the processing of his or her personal data.

# 2 Instruments and controls

Cockpit .....	2-3	Oil control system (YS23DDTT engine models) .....	2-35
Left-Hand Drive (LHD) model .....	2-3	Clock and outside air temperature .....	2-36
Right-Hand Drive (RHD) model .....	2-4	Headlight and turn signal switch .....	2-36
Instrument panel .....	2-5	Headlight switch .....	2-36
Left-Hand Drive (LHD) model .....	2-5	Automatic aiming control (if equipped) .....	2-38
Right-Hand Drive (RHD) model .....	2-6	Battery saver system .....	2-38
Meters and gauges .....	2-7	Turn signal switch .....	2-38
Speedometer and odometer .....	2-9	Fog light switch (if equipped) .....	2-39
Tachometer .....	2-9	Front fog lights (if equipped) .....	2-39
Engine coolant temperature gauge .....	2-9	Rear fog light (if equipped) .....	2-39
Fuel gauge .....	2-10	Wiper and washer switch .....	2-40
Instrument brightness control .....	2-11	Windshield wiper and washer switch .....	2-40
Automatic Transmission (AT) position indicator (if equipped) .....	2-11	Rain-sensing auto wiper system (if equipped) .....	2-41
Warning lights, indicator lights and audible reminders .....	2-12	Rear window wiper and washer switch .....	2-41
Checking lights .....	2-13	Defogger switch .....	2-42
Warning lights .....	2-13	Horn .....	2-43
Indicator lights .....	2-18	Windows .....	2-43
Audible reminders .....	2-19	Power windows .....	2-43
Vehicle information display (models without color display) .....	2-20	Power outlets .....	2-44
Outside air temperature .....	2-20	USB (Universal Serial Bus) charging connector (if equipped) .....	2-45
Trip computer .....	2-20	Wireless charger (if equipped) .....	2-46
Vehicle information display (models with color display) .....	2-21	Storage .....	2-47
How to use the vehicle information display .....	2-21	Glove box .....	2-47
Startup display .....	2-22	Console box .....	2-47
Settings .....	2-22	Sunglasses holder .....	2-47
Vehicle information display warnings and indicators .....	2-27	Cup holders .....	2-48
Trip computer .....	2-33	Roof rack .....	2-49
		Luggage hooks .....	2-49
		Luggage floor box (if equipped) .....	2-49
		Card holder (if equipped) .....	2-49
		Sun visors .....	2-50

Interior lights .....	2-50
Interior light switch .....	2-50
Console light .....	2-50
Map lights .....	2-51

Rear personal light .....	2-51
Vanity mirror lights (if equipped) .....	2-51
Cargo light .....	2-51
Battery saver system .....	2-51

## COCKPIT

### LEFT-HAND DRIVE (LHD) MODEL

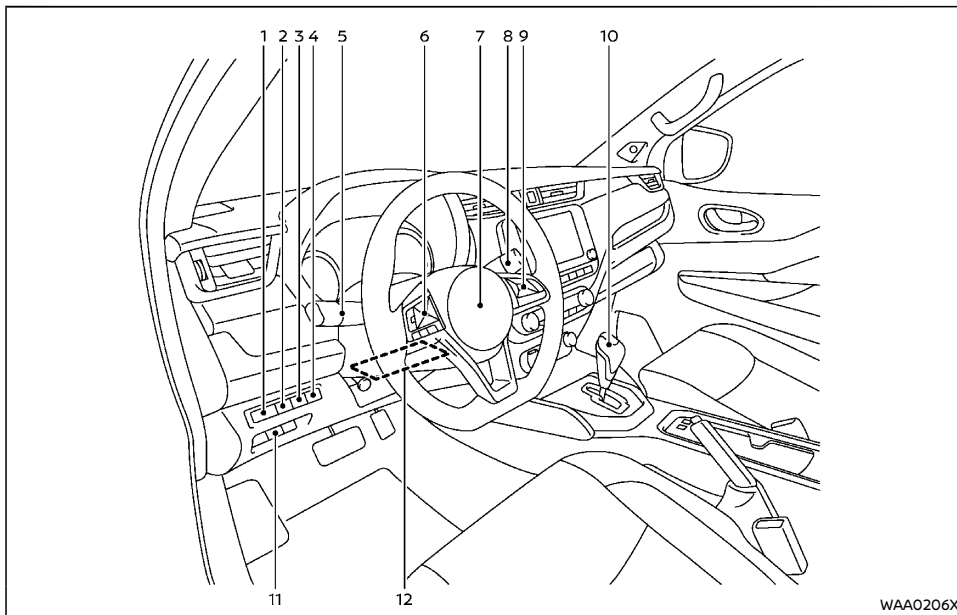

1. Instrument brightness control switch (models with color display)
2. Fuel-filler lid opener switch
3. TRIP/RESET switch for twin trip odometer (models with color display)
4. Parking sensor (sonar) system switch\*
5. Headlight and turn signal switch/Fog light switch\*
6. Steering-wheel-mounted controls\* (left side)
  - Audio control
  - Vehicle information display control\*
  - Bluetooth® Hands-Free Phone System\*
7. Steering wheel
  - Horn
  - Driver's supplemental front-impact air bag

8. Wiper and washer switch
  9. Steering-wheel-mounted controls\* (right side)
    - Cruise control system switches\*
    - Intelligent Cruise Control (ICC) system switches\*
    - Bluetooth® Hands-Free Phone System\*
    - Voice recognition system\*
  10. Shift lever
    - Automatic Transmission (AT)
    - Manual Transmission (MT)
  11. Vehicle Dynamic Control (VDC) OFF switch\*
  12. Tilting steering wheel lock lever
- \*: if equipped

## RIGHT-HAND DRIVE (RHD) MODEL

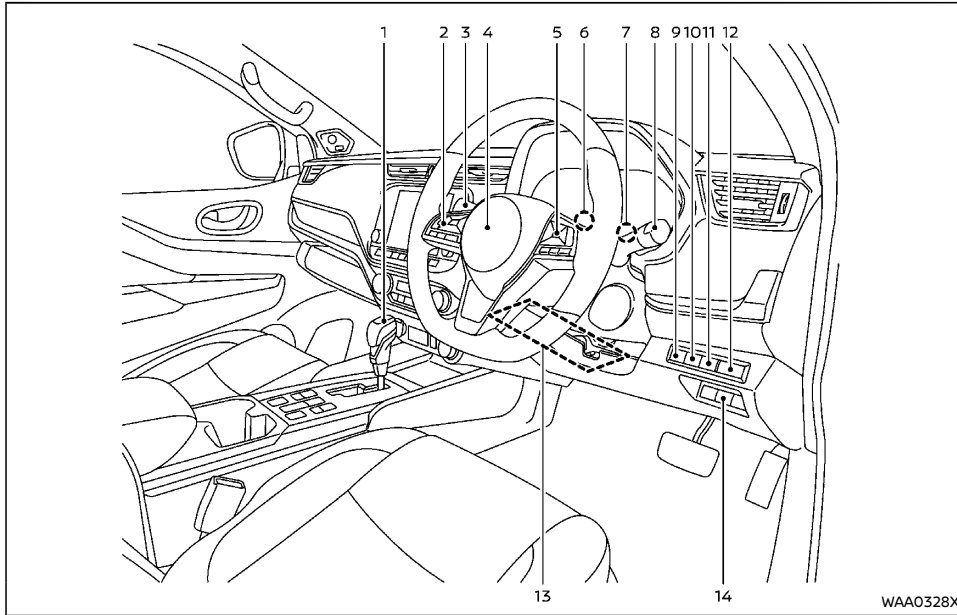

1. Shift lever
  - Automatic Transmission (AT)
  - Manual Transmission (MT)
2. Steering-wheel-mounted controls\* (left side)
  - Audio control
  - Vehicle information display control
  - Bluetooth® Hands-Free Phone System\*
3. Wiper and washer switch
4. Steering wheel
  - Horn
  - Driver's supplemental front-impact air bag
5. Steering-wheel-mounted controls\* (right side)
  - Cruise control system switches\*
  - Bluetooth® Hands-Free Phone System\*

- Voice recognition system\*
6. Instrument brightness control switch/  
Trip computer mode switch (models without color display)
  7. TRIP/RESET switch for twin trip odometer/Trip computer mode switch (models without color display)
  8. Headlight and turn signal switch/Fog light switch\*
  9. Parking sensor (sonar) system switch\*
  10. TRIP/RESET switch for twin trip odometer (models with color display)
  11. Fuel-filler lid opener switch
  12. Instrument brightness control switch (models with color display)
  13. Tilting steering wheel lock lever
  14. Vehicle Dynamic Control (VDC) OFF switch\*
- \*: if equipped

## INSTRUMENT PANEL

### LEFT-HAND DRIVE (LHD) MODEL

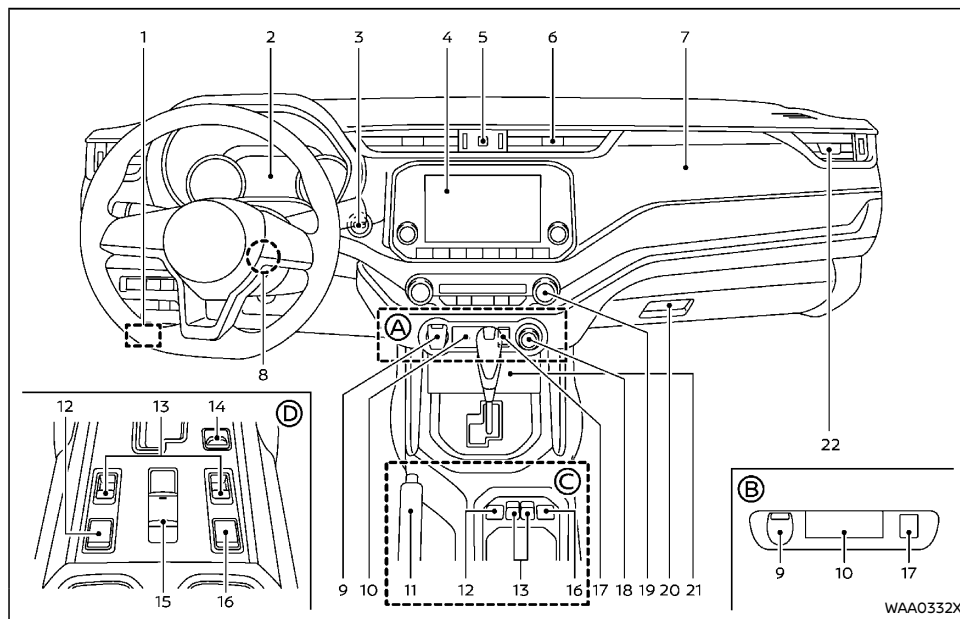

- |   |  |
|---|--|
| <ol style="list-style-type: none"> <li>1. Hood lock release handle</li> <li>2. Meters and gauges             <ul style="list-style-type: none"> <li>– Vehicle information display</li> </ul> </li> <li>3. Push-button ignition switch (models with Intelligent Key system)</li> <li>4. Audio system* or Navigation System*             <ul style="list-style-type: none"> <li>– Rear view monitor*</li> <li>– Intelligent Around View Monitor*</li> </ul> </li> </ol> | <ol style="list-style-type: none"> <li>5. Hazard indicator flasher switch</li> <li>6. Center ventilator</li> <li>7. Front passenger's supplemental front-impact air bag</li> <li>8. Ignition switch (models without Intelligent Key system)</li> <li>9. Power outlet</li> <li>10. Auxiliary (AUX) input jack* and USB (Universal Serial Bus) connection port*</li> </ol> |
|---|--|

11. Parking brake (lever type)\*
  12. Differential lock mode switch\*
  13. Seat tumbling switch\*
  14. Drive Mode Selector switch\*
  15. Parking brake (switch type)\*
  16. Hill descent control switch\*
  17. Rear cooler switch
  18. Four-Wheel Drive (4WD) mode switch\*
  19. Heater and air conditioner control
  20. Glove box
    - Fuse box
  21. Wireless charger\*
  22. Side ventilator
- Ⓐ: 4WD models  
 Ⓑ: 2WD models  
 Ⓒ: Models not equipped with electronic parking brake system  
 Ⓓ: Models equipped with electronic parking brake system  
 \*: If equipped

WAA0332X

## RIGHT-HAND DRIVE (RHD) MODEL

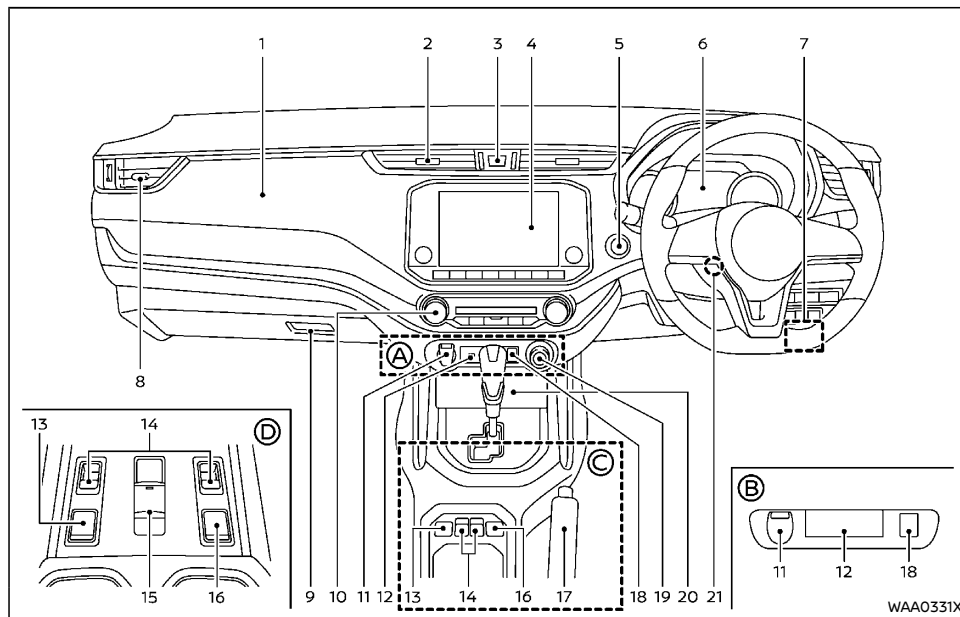

- |  |   |
|--|---|
| 1. Front passenger's supplemental front-impact air bag   | 6. Meters and gauges<br>— Vehicle information display |
| 2. Center ventilator   | 7. Hood release handle                                |
| 3. Hazard indicator flasher switch   | 8. Side ventilator                                    |
| 4. Audio system* or Navigation System*<br>— Rear view monitor*<br>— Intelligent Around View Monitor* | 9. Glove box<br>— Fuse box                            |
| 5. Push-button ignition switch (models with Intelligent Key system)                                  | 10. Heater and air conditioner control                |
|  | 11. Power outlet                                      |

- |   |
|---|
| 12. USB (Universal Serial Bus) connection port and Auxiliary (AUX) input jack |
| 13. Differential lock mode switch*  |
| 14. Seat tumbling switch*   |
| 15. Parking brake (switch type)*  |
| 16. Hill descent control switch*  |
| 17. Parking brake (lever type)*   |
| 18. Rear cooler switch  |
| 19. Four-Wheel Drive (4WD) mode switch*                                       |
| 20. Wireless charger*   |
| 21. Ignition switch (models without Intelligent Key system)                   |
| Ⓐ: 4WD models   |
| Ⓑ: 2WD models   |
| Ⓒ: Models not equipped with electronic parking brake system                   |
| Ⓓ: Models equipped with electronic parking brake system                       |
| *: If equipped  |



## METERS AND GAUGES

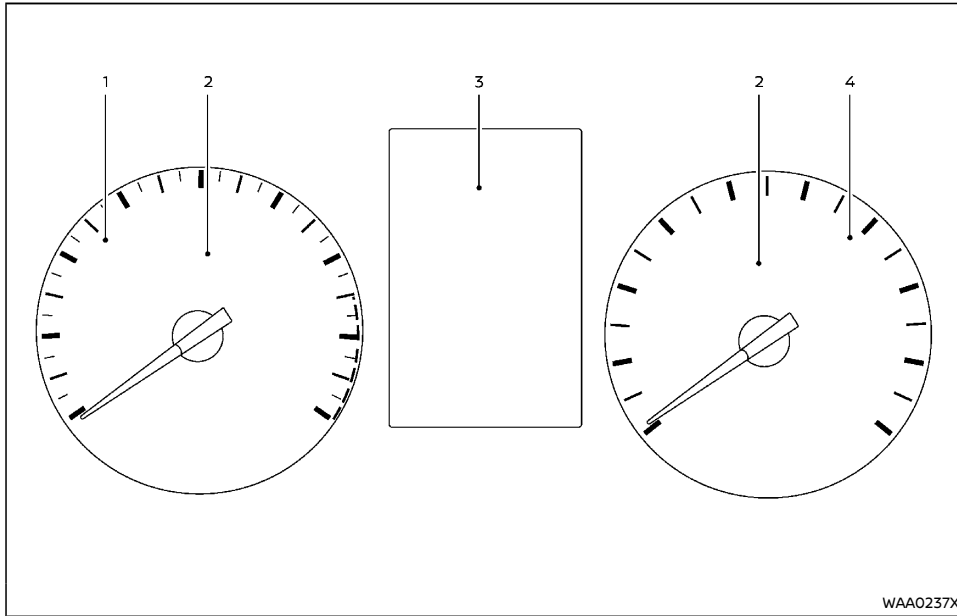

Type A

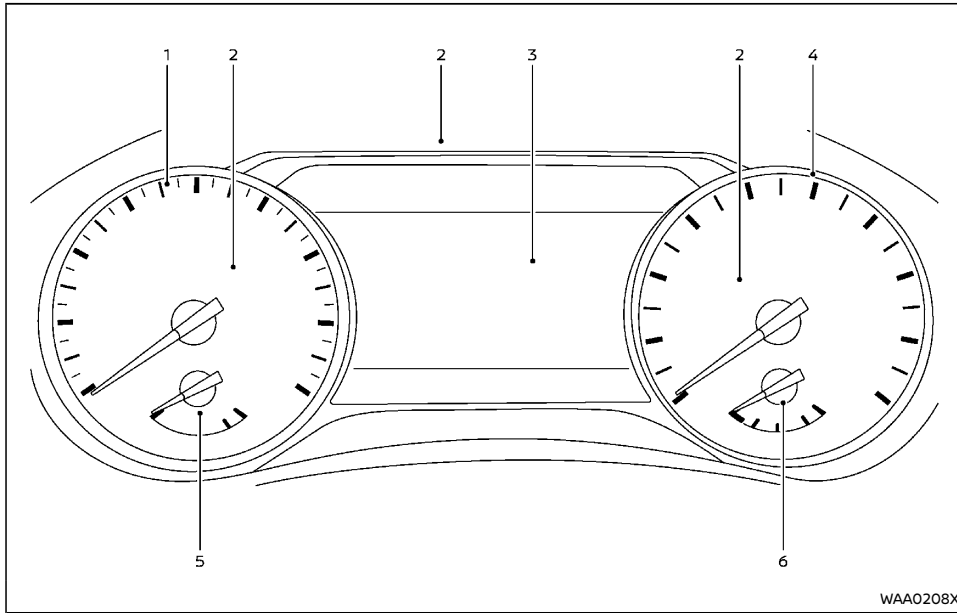

WAA0208X

**Type B**

- |  |   |
|--|---|
| <ol style="list-style-type: none"> <li>1. Tachometer</li> <li>2. Warning/Indicator lights</li> <li>3. Vehicle information display             <ul style="list-style-type: none"> <li>– Engine coolant temperature gauge (models without color display)</li> <li>– Fuel gauge (models without color display)</li> <li>– Four-Wheel Drive (4WD) mode indicator*</li> <li>– Oil control system*</li> <li>– Odometer/twin trip odometer</li> </ul> </li> </ol> | <ul style="list-style-type: none"> <li>– Trip computer</li> <li>– Instrument brightness control</li> <li>– Automatic Transmission (AT) position indicator (AT model)</li> <li>4. Speedometer</li> <li>5. Engine coolant temperature gauge (models with color display)</li> <li>6. Fuel gauge (models with color display)</li> </ul> <p>*: If equipped</p> |
|--|---|

The needle indicators may move slightly after the ignition switch is placed in the "OFF" position. This is not a malfunction.

## SPEEDOMETER AND ODOMETER

### Speedometer

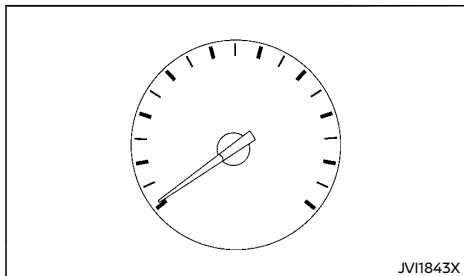

The speedometer indicates the vehicle speed.

### Odometer (models with color display)

#### Odometer/Twin trip odometer:

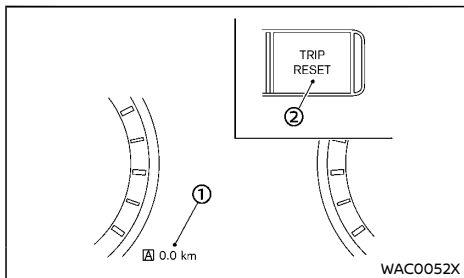

The odometer and twin trip odometer ① are displayed below the vehicle information display when the ignition switch is in the "ON" position.

The odometer records the total distance the vehicle has been driven.

The twin trip odometer records the distance of

individual trips.

#### Changing display:

Push the TRIP RESET switch ② (located on the instrument panel) to change the display as follows:

TRIP A → TRIP B → ODO → TRIP A

#### Resetting twin trip odometer:

Push the TRIP RESET switch ② for more than 1 second to reset the trip odometer to zero.

### Odometer (models without color display)

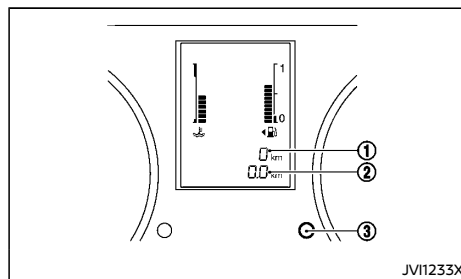

#### Odometer/twin trip odometer:

The odometer/twin trip odometer is displayed when the ignition switch is in the "ON" position.

The odometer ① displays the total distance the vehicle has been driven.

The twin trip odometer ② displays the distance of individual trips.

#### Changing trip odometer display:

Push the trip odometer reset switch ③ to change the display as follows:

TRIP A → TRIP B → Trip computer mode → TRIP A

For trip computer information, see "Trip com-

puter" (P.2-20).

#### Resetting trip odometer:

Push the trip odometer reset switch ③ for approximately 1 second to reset the trip odometer to zero.

## TACHOMETER

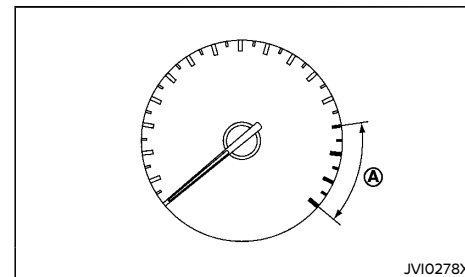

The tachometer indicates the engine speed in revolutions per minute (rpm). **Do not rev the engine into the red zone ④.**

The red zone varies with models.

## ENGINE COOLANT TEMPERATURE GAUGE



#### CAUTION:

- If the gauge indicates the engine coolant temperature is near the hot (H) end of the normal range, reduce vehicle speed to decrease the temperature.
- If the gauge is over the normal range, stop the vehicle as soon as safely possible and let the engine idle.
- If the engine is overheated, continued operation of the vehicle may seriously

damage the engine. (See "If your vehicle overheats" (P.6-11) for immediate action required.)

### Models with color display

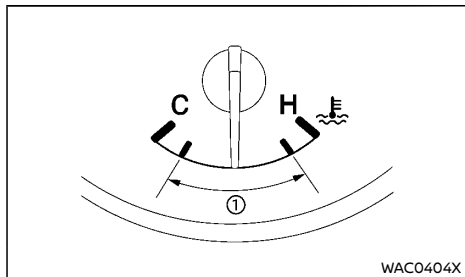

WAC0404X

Type A

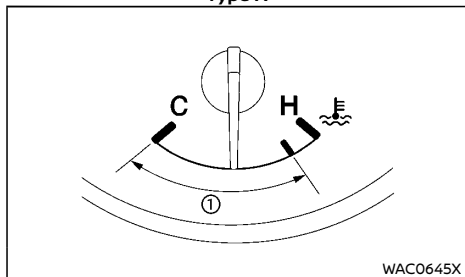

WAC0645X

Type B

The engine coolant temperature gauge indicates the engine coolant temperature.

The engine coolant temperature is normal when the gauge needle points within the zone ① shown in the illustration.

The engine coolant temperature will vary with the outside air temperature and driving conditions.

### Models without color display

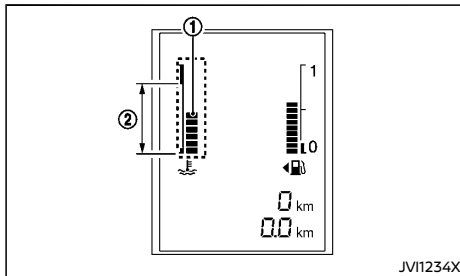

JV11234X

The engine coolant temperature gauge ① indicates the engine coolant temperature.

The engine coolant temperature is normal when the gauge is within the zone ② shown in the illustration.

The engine coolant temperature will vary with the outside air temperature and driving conditions.

### FUEL GAUGE

#### Models with color display

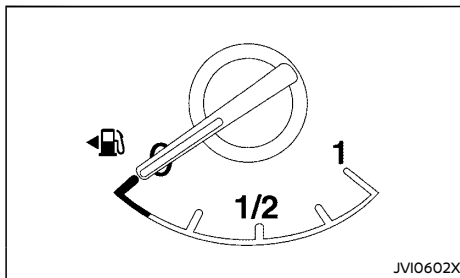

JV10602X

The fuel gauge indicates the approximate fuel

level in the tank when the ignition switch is in the "ON" position.

The gauge may move slightly during braking, turning, accelerating, or going up and down hills due to movement of fuel in the tank.

The low fuel warning appears on the vehicle information display when the fuel level in the tank is getting low. Refuel as soon as it is convenient, preferably before the gauge reads the empty (0) position.

The arrow, , indicates that the fuel-filler lid is located on the left side of the vehicle.



### CAUTION:

**Refuel before the gauge reads the empty (0) position.**

There is a small reserve of fuel in the tank when the fuel gauge reads the empty (0) position.

#### Models without color display

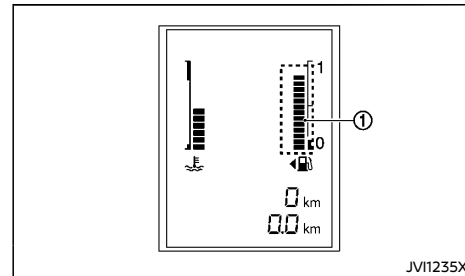

JV11235X

The fuel gauge ① indicates the approximate fuel level in the tank when the ignition switch is in the "ON" position.

The gauge may move slightly during braking, turning, accelerating, or going up and down

hills due to movement of fuel in the tank.

The low fuel warning light illuminates when the fuel level in the tank is getting low. Refuel as soon as it is convenient, preferably before the gauge reads 0.

The arrow, , indicates that the fuel-filler lid is located on the left side of the vehicle.



### CAUTION:

**Refuel before the gauge reads 0 (empty).**

There is a small reserve of fuel in the tank when the fuel gauge reads 0 (empty).

## INSTRUMENT BRIGHTNESS CONTROL

### Models with color display

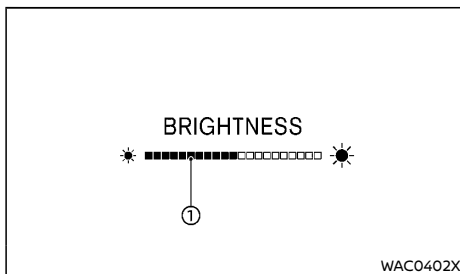
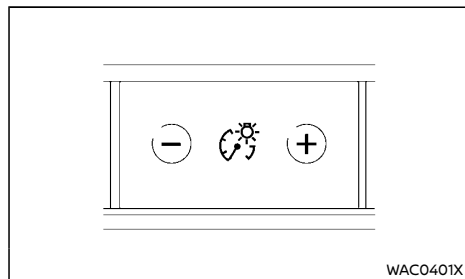

### Example

The instrument brightness control switch can be operated when the ignition switch is in the "ON" position. When the switch is operated, the vehicle information display switches to the brightness adjustment mode.

Push the + side of the switch to brighten the meter panel lights. The bar ① moves to the right side.

Push the - side of the switch to dim the lights. The bar ① moves to the left side.

The vehicle information display returns to the normal display when the instrument brightness control switch is not operated for more than 5 seconds.

When the brightness level reaches the maximum or minimum, a beep will sound.

### Models without color display

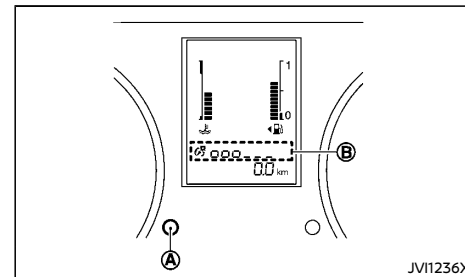

The instrument brightness control operates when the ignition switch is in the "ON" position and the headlight switch is in either the  $\text{ON}$  or  $\text{OFF}$  position.

































Turn the instrument brightness control switch **A** to adjust the brightness of the meter. The brightness indicator **B** will be shown briefly in the vehicle information display when the control is turned.

When the brightness level reaches the maximum or minimum, a beep will sound.





### AUTOMATIC TRANSMISSION (AT) POSITION INDICATOR (if equipped)

The Automatic Transmission (AT) position indicator indicates the shift lever position when the ignition switch is in the "ON" position. (See "Vehicle information display (models without color display)" (P.2-20), "24. Automatic Transmission (AT) position indicator (AT model)" (P.2-30) and "Driving with Automatic Transmission (AT)" (P.5-15).)









## WARNING LIGHTS, INDICATOR LIGHTS AND AUDIBLE REMINDERS

	Anti-lock Braking System (ABS) warning light		Low fuel warning light*		Glow plug indicator light*
	Automatic Transmission (AT) check warning light (AT model)		Low tire pressure warning light*		High beam indicator light
	Automatic Transmission (AT) oil temperature warning light (AT model)		Malfunction warning light (red)*		Hill descent control system on indicator light*
	Automatic Transmission (AT) park warning light*		Master warning light*		Malfunction Indicator Light (MIL)
	Brake warning light (red)		Seat belt warning light		Rear fog light indicator light*
	Charge warning light		Speed [120 km/h (75 MPH)] warning light*		Security indicator light
	Door open warning light*		Supplemental Restraint System (SRS) air bag warning light		Small light indicator light*
	Electronic parking brake system warning light (yellow)*		Vehicle Dynamic Control (VDC) warning light*		Turn signals/hazard indicator lights
	Engine oil pressure warning light		Water-in-fuel-filter warning light*		Vehicle Dynamic Control (VDC) off indicator light*
	Four-Wheel Drive (4WD) warning light (4WD model)		Differential lock indicator light*	*: if equipped	
	Headlight warning light*		Electronic parking brake indicator light*		
	Intelligent Emergency Braking system warning light*		Front fog light indicator light*		

## CHECKING LIGHTS

With all doors closed, apply the parking brake, fasten the seat belts and place the ignition switch in the "ON" position without starting the engine. The following lights (if equipped) will come on: (P), (R)\*1, , , , , .

\*1: models not equipped with electronic parking brake system

The following lights (if equipped) will come on briefly and then go off: (R)\*2, (P), ,  (YD25DDTi engine model),  (YD25DDTi engine model),  **ATP**, ,  **OFF**, , , .

\*2: models equipped with electronic parking brake system

If any light does not come on or operates in a way other than described, it may indicate a burned-out bulb and/or a system malfunction. Have the system checked, and if necessary repaired, by a NISSAN dealer promptly.

### Models with color display:

Some indicators and warnings are also displayed on the vehicle information display between the speedometer and tachometer. (See "Vehicle information display (models with color display)" (P.2-21).)

## WARNING LIGHTS

 Anti-lock Braking System (ABS) warning light

When the ignition switch is in the "ON" position, the Anti-lock Braking System (ABS) warning light illuminates and then turns off. This indicates the ABS is operational.

If the ABS warning light illuminates while the

engine is running, or while driving, it may indicate the ABS is not functioning properly. Have the system checked by a NISSAN dealer promptly.

If an ABS malfunction occurs, the anti-lock function is turned off. The brake system then operates normally, but without anti-lock assistance. (See "Anti-lock Braking System (ABS)" (P.5-84).)

**While the differential lock (if equipped) is engaged, the ABS warning light illuminates. This indicates that the anti-lock function is not fully operating.** (See "Rear differential locking system" (P.5-26) for the rear differential lock function.)

 Automatic Transmission (AT) check warning light (AT model)

When the ignition switch is in the "ON" position, the Automatic Transmission (AT) check warning light illuminates and then turns off. This indicates that the AT is operational.

If the AT check warning light illuminates while the engine is running, or while driving, it may indicate that the AT is not functioning properly and may need servicing. Have the system checked, and if necessary repaired, by a NISSAN dealer promptly.

 Automatic Transmission (AT) oil temperature warning light (AT model)

This light illuminates when the Automatic Transmission (AT) oil temperature is too high. If the light illuminates while driving, reduce the vehicle speed as soon as safely possible until the light turns off.



### CAUTION:

**Continued vehicle operation when the AT oil temperature warning light is on may damage the AT.**

 Automatic Transmission (AT) park warning light (if equipped)

If the ATP light is on, this indicates that the automatic transmission P (Park) position will not function and the transfer case is in neutral.

This light indicates that the Automatic Transmission (AT) parking function is not engaged. If the transfer control is not secured in any driving position while the AT shift lever is in the "P" (Park) position, the transmission will disengage and the wheels will not lock.

**If the ATP warning light illuminates with the shift lever in the "P" (Park) position, shift the Four-Wheel Drive (4WD) mode switch to the 2WD, 4H or 4LO position again with the shift lever in the N (Neutral) position.** (See "Four-Wheel Drive (4WD)" (P.5-19).)



### WARNING:

**If the 4WD mode indicator (see "4WD mode indicator" (P.5-23)) is "OFF" or the ATP warning light is "ON", this indicates that the automatic transmission P (Park) position will not function and could result in the vehicle moving unexpectedly, causing serious personal injury or property damage. Always set the parking brake.**

## Brake warning light (red)



### **WARNING:**

- **If the brake fluid level is below the minimum mark on the brake fluid reservoir, do not drive the vehicle until the brake system has been checked by a NISSAN dealer.**
- **Even if you judge it to be safe, have your vehicle towed because driving it could be dangerous.**
- **Depressing the brake pedal without the engine running and/or with a low brake fluid level could increase the stopping distance and require greater pedal travel distance and effort.**

The brake warning light (red) indicates the parking brake system operation (models not equipped with electronic parking brake system), a low brake fluid level of the brake system and an Anti-lock Braking System (ABS) malfunction.

### **Parking brake warning indicator (models not equipped with electronic parking brake system):**

When the ignition switch is placed in the "ON" position, the brake warning light (red) illuminates. When the engine is started and the parking brake is released, the brake warning light (red) turns off.

If the parking brake is not fully released, the brake warning light (red) remains on. Be sure that the brake warning light (red) has turned off before driving. (See "Parking brake" (P.3-28).)

### **Low brake fluid warning indicator:**

When the ignition switch is placed in the "ON" position, the brake warning light (red) illuminates, and then turns off (models equipped with electronic parking brake system).

If the brake warning light (red) illuminates while the engine is running, or while driving, and the parking brake is released, it may indicate the brake fluid level is low.

When the brake warning light (red) illuminates while driving, stop the vehicle safely as soon as possible. Stop the engine and check the brake fluid level. If the brake fluid level is at the minimum mark, add brake fluid as necessary. (See "Brake fluid" (P.8-17).)

If the brake fluid level is sufficient, have the brake system checked by a NISSAN dealer promptly.

### **Anti-lock Braking System (ABS) warning indicator:**

When the parking brake is released and the brake fluid level is sufficient, if both the brake warning light (red) and the Anti-lock Braking System (ABS) warning light illuminate, it may indicate the ABS is not functioning properly. Have the brake system checked, and if necessary repaired, by a NISSAN dealer promptly. (See "Anti-lock Braking System (ABS) warning light" (P.2-13).)



### **Charge warning light**

When the ignition switch is in the "ON" position, the charge warning light illuminates. After starting the engine, the charge warning light turns off. This indicates that the charging system is operational.

If the charge warning light illuminates while the engine is running, or while driving, it may

indicate that the charging system is not functioning properly and may need servicing.

When the charge warning light illuminates while driving, stop the vehicle safely as soon as possible. Stop the engine and check the alternator belt. If the alternator belt is loose, broken or missing, the charging system needs repair. (See "Drive belt" (P.8-15).)

If the alternator belt appears to be functioning correctly but the charge warning light remains illuminated, have the charging system checked by a NISSAN dealer promptly.



### **CAUTION:**

**Do not continue driving if the alternator belt is loose, broken or missing.**



### **Door open warning light (if equipped)**

When the ignition switch is in the "ON" position, the door open warning light illuminates if any of the doors or the back door is open or not closed securely.



### **Electronic parking brake system warning light (yellow) (if equipped)**

The electronic parking brake system warning light functions for the electronic parking brake system. If the warning light illuminates, it may indicate that the electronic parking brake system is not functioning properly. Have the parking brake system checked, and if necessary repaired, by a NISSAN dealer promptly.





### Engine oil pressure warning light

When the ignition switch is in the “ON” position, the engine oil pressure warning light illuminates. After starting the engine, the engine oil pressure warning light turns off. This indicates that the oil pressure sensors in the engine are operational.

If the engine oil pressure warning light illuminates or blinks while the engine is running, it may indicate that the engine oil pressure is low. Stop the vehicle safely as soon as possible. Stop the engine immediately and call a NISSAN dealer.



#### CAUTION:

- **Running the engine with the engine oil pressure warning light illuminated could cause serious damage to the engine.**
- **The engine oil pressure warning light is not designed to indicate a low oil level. The oil level should be checked using the dipstick. (See “Engine oil” (P.8-10).)**



### 4WD Four-Wheel Drive (4WD) warning light (4WD model)

When the ignition switch is in the “ON” position, the Four-Wheel Drive (4WD) warning light illuminates. After starting the engine, the 4WD warning light turns off.

If the 4WD system malfunctions or the revolution or radius of the front and the rear wheel differs, the warning light will either remain illuminated or blink. (See “Four-Wheel Drive (4WD)” (P.5-19).)



#### CAUTION:

- **If the 4WD warning light illuminates or blinks while driving, reduce the vehicle speed and have your vehicle checked by a NISSAN dealer as soon as possible.**
- **Do not drive on dry and hard surface roads in the 4H or 4LO position. If the 4WD warning light turns on when you are driving on dry hard surface roads:**
  - **in the 4H position, shift the 4WD mode switch to 2WD.**
  - **in the 4LO position, stop the vehicle and shift the transmission lever to the “N” (Neutral) position with the brake pedal depressed and shift the 4WD mode switch to 2WD.**

If the warning light is still on after the above operations, have your vehicle checked by a NISSAN dealer as soon as possible.



### Headlight warning light (if equipped)

The headlight warning light illuminates if the LED headlights are malfunctioning. Contact a NISSAN dealer.



### Intelligent Emergency Braking system warning light (if equipped)

When the ignition switch is in the “ON” position, the Intelligent Emergency Braking system warning light illuminates. After starting the engine, the warning light turns off.

This light illuminates when the Intelligent Emergency Braking system is set to OFF on the vehicle information display.

If the light illuminates when the Intelligent

Emergency Braking system is ON, it may indicate that the system is unavailable. See “Intelligent Emergency Braking” (P.5-61).



### Low fuel warning light (if equipped)

The low fuel warning light illuminates when the fuel level in the tank is getting low. Refuel as soon as it is convenient, preferably before the fuel gauge reaches the empty (0) position.

**There will be a small reserve of fuel remaining in the tank when the fuel gauge reaches the empty (0) position.**



### Low tire pressure warning light (if equipped)

When the ignition switch is in the “ON” position, the low tire pressure warning light illuminates and then turns off. This indicates that the low tire pressure warning system is operational.

This light illuminates if there is low tire pressure or a tire pressure warning system malfunction.

The Tire Pressure Monitoring System (TPMS) monitors the tire pressure of all tires except the spare.

#### Low tire pressure warning:

If the vehicle is being driven with low tire pressure, the low tire pressure warning light will illuminate.

When the low tire pressure warning light illuminates, you should stop and adjust the tire pressure to the recommended COLD tire pressure shown on the tire placard. Use a tire pressure gauge to check the tire pressure. The low tire pressure warning light may not automatically turn off when the tire pressure is adjusted. After the tire is inflated to the recommended pressure, reset the tire pres-

tures registered in your vehicle (model with TPMS reset function) and then drive the vehicle at speeds above 25 km/h (16 MPH). These operations are required to activate the TPMS and turn off the low tire pressure warning light.

#### **Model with TPMS reset function:**

TPMS resetting must be also performed after a tire or a wheel is replaced, or the tires are rotated.

Depending on a change in the outside temperature, the low tire pressure warning light may illuminate even if the tire pressure has been adjusted properly. Adjust the tire pressure to the recommended COLD tire pressure again when the tires are cold, and reset the TPMS.

If the low tire pressure warning light still continues to illuminate after the resetting operation, it may indicate that the TPMS is not functioning properly. Have the system checked by a NISSAN dealer.

For additional information, see "Tire Pressure Monitoring System (TPMS)" (P.5-5) and "Tire Pressure Monitoring System (TPMS)" (P.6-2).

#### **TPMS malfunction:**

If the TPMS is not functioning properly, the low tire pressure warning light will flash for approximately 1 minute when the ignition switch is placed in the "ON" position. The light will remain on after the 1 minute. Have the system checked by a NISSAN dealer.

For additional information, see "Tire Pressure Monitoring System (TPMS)" (P.5-5).



#### **WARNING:**

- **If the light does not illuminate with the ignition switch placed in the "ON" position, have the vehicle checked by a NISSAN dealer as soon as possible.**

- **If the light illuminates while driving, avoid sudden steering maneuvers or abrupt braking, reduce vehicle speed, pull off the road to a safe location and stop the vehicle as soon as possible. Driving with under-inflated tires may permanently damage the tires and increase the likelihood of tire failure. Serious vehicle damage could occur and may lead to an accident and could result in serious personal injury. Check the tire pressure for all four tires. Adjust the tire pressure to the recommended COLD tire pressure shown on the tire placard to turn the low tire pressure warning light off. If the light still illuminates while driving after adjusting the tire pressure, a tire may be flat or the TPMS may be malfunctioning. If you have a flat tire, replace it with a spare tire as soon as possible. If no tire is flat and all tires are properly inflated, have the vehicle checked by a NISSAN dealer.**
- **After adjusting the tire pressure, be sure to reset the TPMS. Otherwise, the TPMS will not warn of low tire pressure (model with TPMS reset function).**
- **Since the spare tire is not equipped with the TPMS, when a spare tire is mounted or a wheel is replaced, the TPMS will not function and the low tire pressure warning light will flash for approximately 1 minute. The light will remain on after the 1 minute. Contact your NISSAN dealer as soon as possible for tire replacement and/or system resetting.**
- **Replacing tires with those not originally specified by NISSAN could affect the proper operation of the TPMS.**



#### **CAUTION:**

- **The TPMS is not a substitute for the regular tire pressure check. Be sure to check the tire pressure regularly.**
- **If the vehicle is being driven at speeds of less than 25 km/h (16 MPH), the TPMS may not operate correctly.**
- **Be sure to install the specified size of tires to all four wheels correctly.**



Malfunction warning light (red) (if equipped)

When the ignition switch is placed in the "ON" position, the malfunction warning light illuminates in red. This means that the system is operational. After starting the engine, the warning light turns off.

For the orange Malfunction Indicator Light (MIL), see "Malfunction Indicator Light (MIL)" (P.2-18) for details.

If the malfunction warning light (red) illuminates continuously while the engine is running, it may indicate an engine control system malfunction. Have your vehicle inspected by a NISSAN dealer. You do not need to have your vehicle towed to the dealer.



#### **CAUTION:**

**Continuing vehicle operation without proper servicing of the engine control system could lead to poor driveability, reduced fuel economy, and damage to the engine control system, which may affect the vehicle's warranty coverage.**

### Master warning light (if equipped)

When the ignition switch is in the "ON" position, the master warning light illuminates if any of the following are displayed on the vehicle information display.

- No Key Detected warning
- Shift to Park warning (if equipped)
- Key ID Incorrect warning
- Release Parking Brake warning
- Low fuel warning
- Door open warning
- Key System Fault warning
- Low Oil Pressure warning (if equipped)
- 4WD system fault (if equipped)
- Shipping Mode On Push Storage Fuse warning (if equipped)
- Headlight system fault warning
- Automatic Transmission (AT) system fault warning (if equipped)
- Parking sensor system fault (if equipped)
- Other warning

See "Vehicle information display (models with color display)" (P.2-21).

### Seat belt warning light

When the ignition switch is in the "ON" position, the seat belt warning light illuminates. The light will continue to illuminate until the driver's and/or front passenger's (if equipped) seat belts are fastened.

When the vehicle speed exceeds 15 km/h (10 MPH), the light will blink and the chime will sound unless the driver's and/or front passenger's (if equipped) seat belts are securely fastened. The chime will continue to sound for about 90 or 95 seconds until the seat belts are

fastened.

For precautions on seat belt usage, see "Seat belts" (P.1-11).

### Speed [120 km/h (75 MPH)] warning light (if equipped)

This light blinks when the vehicle speed goes over approximately 120 km/h (75 MPH). Be sure to observe the speed limit in the area where you are driving.

### Supplemental Restraint System (SRS) air bag warning light

When the ignition switch is in the "ON" position, the Supplemental Restraint System (SRS) air bag warning light illuminates for about 7 seconds and then turns off. This indicates the SRS air bag system is operational.

If any of the following conditions occur, the SRS air bag system and/or pre-tensioner seat belt need servicing. Have the system checked, and if necessary repaired, by a NISSAN dealer promptly.

- The SRS air bag warning light remains illuminated after about 7 seconds.
- The SRS air bag warning light does not come on at all.

Unless checked and repaired, the SRS air bag system and/or pre-tensioner seat belt may not function properly. (See "Supplemental Restraint System (SRS)" (P.1-29).)

### Vehicle Dynamic Control (VDC) warning light (if equipped)

When the ignition switch is in the "ON" position, the Vehicle Dynamic Control (VDC) warning light illuminates and then turns off.

The warning light blinks when the VDC system is operating.

When the warning light blinks while driving, the driving condition is slippery and the vehicle's traction limit is about to be exceeded.

If the VDC warning light illuminates while the engine is running or while driving, it may indicate that the VDC system is not functioning properly and may need servicing. Have the system checked, and if necessary repaired, by a NISSAN dealer promptly. If a malfunction occurs, the VDC function is turned off, but the vehicle is still drivable. (See "Vehicle Dynamic Control (VDC) system" (P.5-27).)

### Water-in-fuel-filter warning light (if equipped)

#### **YD25DDTi engine model:**

If the water-in-fuel-filter warning light illuminates while the engine is running, drain the water from the fuel filter promptly. (See "Fuel filter (YD25DDTi engine model)" (P.8-14).)

#### **YS23DDTT engine model:**

If the water-in-fuel-filter warning light illuminates while the engine is running, contact a NISSAN dealer as soon as possible.



### CAUTION:

**Continuing vehicle operation without properly draining could cause serious damage to the engine.**

## INDICATOR LIGHTS



Differential lock indicator light (if equipped)

When the ignition switch is in the "ON" position, the differential lock indicator light illuminates and then turns off.

When the differential lock mode switch is in the "ON" position, the differential lock indicator light will blink and then stay on after the differential gear is completely locked.

See "Rear differential locking system" (P.5-26).



Electronic parking brake indicator light (if equipped)

The electronic parking brake indicator light indicates that the electronic parking brake system is operating.

When the ignition switch is placed in the "ON" position, the electronic parking brake indicator light illuminates. When the engine is started and the parking brake is released, the indicator light turns off.

If the parking brake is not fully released, the electronic parking brake indicator light remains on. Be sure that the electronic parking brake indicator light has turned off before driving. (See "Parking brake" (P.3-28).)

If the electronic parking brake indicator light illuminates or flashes while the electronic parking brake system warning light  (yellow) illuminates, it may indicate that the

electronic parking brake system is not functioning properly. Have the brake system checked, and if necessary repaired, by a NISSAN dealer promptly.



Front fog light indicator light (if equipped)

The front fog light indicator light illuminates when the front fog lights are on. (See "Fog light switch" (P.2-39).)



Glow plug indicator light (if equipped)

### YD25DDTi engine model:

When the ignition switch is in the "ON" position, the glow plug indicator light illuminates and turns off after the glow plugs have warmed up.

If the glow plugs have already warmed up, the glow plug indicator flashes briefly and then turns off.

### YS23DDTT engine model:

When starting the engine by pushing the ignition switch while depressing the brake pedal, the glow plug indicator light illuminates and turns off after the glow plugs have warmed up. If the engine is already warmed up, the glow plug indicator light may not illuminate when the engine is started.



High beam indicator light

The high beam indicator light illuminates when the headlight high beam is on. The indicator turns off when the low beam is selected. (See "Headlight and turn signal switch" (P.2-36).)



Hill descent control system ON indicator light (if equipped)

When the ignition switch is in the "ON" position the hill descent control system on indicator light illuminates briefly and then turns off. This indicates that the hill descent control system is operational.

The light illuminates when the hill descent control system is activated.

If the hill descent control switch is on and the indicator light blinks, the system is not engaged.

If the indicator light does not illuminate or blink when the hill descent control switch is on, the system may not be functioning properly. Have the system checked by a NISSAN dealer.

For additional information, see "Hill descent control system" (P.5-28).



Malfunction Indicator Light (MIL)



### CAUTION:

- **Continuing vehicle operation without proper servicing of the engine control system could lead to poor driveability, reduced fuel economy, and damage to the engine control system, which may affect the vehicle's warranty coverage.**
- **Incorrect setting of the engine control system may lead to non-compliance of local and national emission laws and regulations.**

When the ignition switch is in the "ON" position, the Malfunction Indicator Light (MIL) illuminates. After starting the engine, the MIL turns off. This indicates that the engine control

system is operational.

If the MIL illuminates or blinks while the engine is running, it may indicate that the engine control system is not functioning properly and may need servicing. Have the system checked, and if necessary repaired, by a NISSAN dealer promptly.

#### Precautions:

To reduce or avoid possible damage to the engine control system when the MIL blinks:

- Avoid driving at speeds above 70 km/h (43 MPH).
- Avoid sudden acceleration or deceleration.
- Avoid going up steep uphill grades.
- Avoid carrying or towing unnecessary loads.

#### Rear fog light indicator light (if equipped)

The rear fog light indicator light illuminates when the rear fog light turns on. (See "Fog light switch" (P.2-39).)

#### Security indicator light

The security indicator light blinks when the ignition switch is in the "ACC", "OFF" or "LOCK" position. This function indicates that the security system equipped on the vehicle is operational.

If the security system is malfunctioning, this light will remain on while the ignition switch is in the "ON" position. (See "Security system" (P.3-15) for additional information.)

#### Small light indicator light (if equipped)

The light illuminates when the headlight switch is turned to the  position.

#### Turn signal/hazard indicator lights

The turn signal/hazard indicator lights blink when the turn signal switch lever or hazard indicator flasher switch is on. (See "Headlight and turn signal switch" (P.2-36) or "Hazard indicator flasher switch" (P.6-2).)

#### Vehicle Dynamic Control (VDC) off indicator light (if equipped)

When the ignition switch is in the "ON" position, the Vehicle Dynamic Control (VDC) off indicator light illuminates and then turns off.

The VDC off indicator light illuminates when the VDC OFF switch is pushed to the "OFF" position.

When the VDC OFF switch is pushed to the "OFF" position, the VDC system is turned off.

When the rear differential lock (if equipped) is engaged with the differential lock mode switch or the 4LO position is selected with the Four-Wheel Drive (4WD) mode switch, the VDC system is disabled and the VDC off indicator light illuminates. (See "Vehicle Dynamic Control (VDC) system" (P.5-27) and "Rear differential locking system" (P.5-26).)

## AUDIBLE REMINDERS

### Brake pad wear warning

The disc brake pads have audible wear warnings. When a brake pad requires replacement, it will make a high pitched scraping sound when the vehicle is in motion. This scraping sound will first occur only when the brake pedal is depressed. After more wear of the brake pad, the sound will always be heard even if the brake pedal is not depressed. Have the brakes checked as soon as possible if the wear warning sound is heard.

Have the system checked, and if necessary repaired, by a NISSAN dealer promptly. (See "Brakes" (P.8-16).)

### Door lock warning chime



#### Models with Intelligent Key system:

When the chime sounds, be sure to check both the vehicle and the Intelligent Key. (See "Troubleshooting guide" (P.3-11).)

#### Models without Intelligent Key system:

The chime sounds if the driver's side door is opened while the key is left in the ignition switch and the ignition switch is in the "ACC", "OFF" or "LOCK" position. Remove the key and take it with you when leaving the vehicle.

### Light reminder chime

The light reminder chime will sound if the driver's side door is opened and the headlight switch is in either the  or  position, and the ignition switch is in the "ACC", "OFF" or "LOCK" position.

Be sure to turn the headlight switch to the "OFF" or "AUTO" position when you leave the vehicle.

## VEHICLE INFORMATION DISPLAY (models without color display)

### Parking brake reminder chime

The chime will sound if the vehicle is driven at more than 7 km/h (4 MPH) (models not equipped with electronic parking brake) or 3 km/h (2 MPH) (models equipped with electronic parking brake) with the parking brake applied. Stop the vehicle and release the parking brake.

### Seat belt warning chime

When the vehicle speed exceeds 15 km/h (10 MPH), the seat belt warning light will blink and the chime will sound unless the driver's and/or front passenger's (if equipped) seat belts are securely fastened. The chime will continue to sound for about 90 or 95 seconds until the seat belts are fastened.

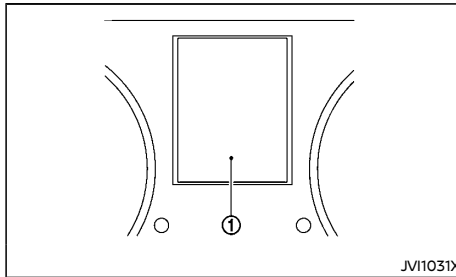

When the ignition switch is placed in the "ON" position, the vehicle information display ① shows the following information:

- Automatic Transmission (AT) position indicator (AT model)
  - "Driving with Automatic Transmission (AT)" (P.5-15)
- Engine coolant temperature gauge
  - "Engine coolant temperature gauge" (P.2-9)
- Fuel gauge
  - "Fuel gauge" (P.2-10)
- Odometer
  - "Odometer (models without color display)" (P.2-9)
- Outside air temperature
  - "Outside air temperature" (P.2-20)
- Trip computer
  - "Trip computer" (P.2-20)

### OUTSIDE AIR TEMPERATURE

The outside air temperature is displayed in °C.

### TRIP COMPUTER

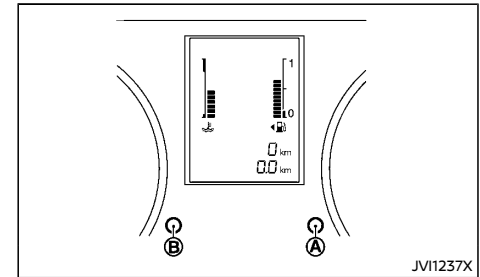

The switch for the trip computer is located on the meter panel.

When the ignition switch is placed in the "ON" position, modes of the trip computer can be selected by pushing the trip computer mode switch ②.

Each time the trip computer mode switch ② is pushed, the display will change as follows:

(TRIP A → TRIP B) → Current fuel consumption → Average fuel consumption → Distance to empty (dte) → (TRIP A)

### Current fuel consumption

The current fuel consumption mode shows the current fuel consumption.

Push the trip computer mode switch ③ to toggle the fuel consumption display between l/100 km and km/l.

## VEHICLE INFORMATION DISPLAY (models with color display)

### Average fuel consumption (l/100 km or km/l)

The average fuel consumption mode shows the average fuel consumption since the last reset. Resetting is done by pushing the trip computer mode switch **A** for longer than 1 second.

The display is updated every 30 seconds. At about the first 500 m (1/3 miles) after a reset, the display shows "----".

Push the trip computer mode switch **B** to toggle the fuel consumption display between l/100 km and km/l.

### Distance to empty (dte - km)

The distance to empty (dte) mode provides you with an estimation of the distance that can be driven before refueling. The dte is constantly being calculated, based on the amount of fuel in the fuel tank and the actual fuel consumption.

The display is updated every 30 seconds.

The dte mode includes a low range warning feature: when the fuel level is low, the dte mode is automatically selected and the digits and the low fuel warning light  blink in order to draw the driver's attention. Push the trip computer mode switch **A** to return to the mode that was selected before the warning occurred.

When the fuel level drops even lower, the dte display will change to "----".

- **If the amount of fuel added is small, the display just before the ignition switch is turned off may continue to be displayed.**
- **When driving uphill or rounding curves, the fuel in the tank shifts, which may momentarily change the display.**

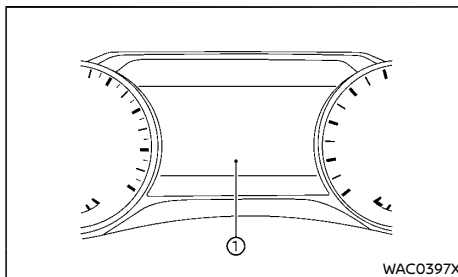

The vehicle information display **1** is located between the tachometer and the speedometer, and it displays the warnings and information. The following items are also displayed if the vehicle is equipped with them:



- Automatic Transmission (AT)
  - "Driving with Automatic Transmission (AT)" (P.5-15)
- Four-Wheel Drive (4WD)
  - "Four-Wheel Drive (4WD)" (P.5-19)
- Clock and outside air temperature
  - "Clock and outside air temperature" (P.2-36)
- Trip computer
  - "Trip computer" (P.2-33)
- Cruise control
  - "Cruise control" (P.5-45)
- Intelligent Cruise Control (ICC)
  - "Intelligent Cruise Control (ICC)" (P.5-47)
- Intelligent Key system
  - "Intelligent Key system" (P.3-7)
- Oil control system
  - "Oil control system (YS23DDTT engine models)" (P.2-35)

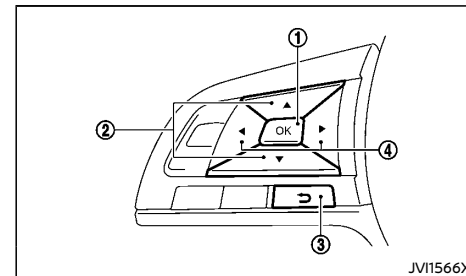

- Other information

The displayed icons/messages in the vehicle information display may differ depending on the model.

### HOW TO USE THE VEHICLE INFORMATION DISPLAY



The vehicle information display can be changed using the buttons OK **1**,  **2**,  **3**, and  **4** located on the left side of the steering wheel.

- 1** OK - change or select an item in the vehicle information display
- 2**  - navigate through the items in vehicle information display
- 3**  - go back to the previous menu
- 4**  - change from one display screen to the next (i.e. trip, Fuel economy)

## STARTUP DISPLAY



When the ignition switch is placed in the "ON" position, the screens that appear in the vehicle information display include:

- Trip computer
- Warnings

Warnings will only display if there are any present. For more information on warnings and indicators, see "Vehicle information display warnings and indicators" (P.2-27).

## SETTINGS

### Settings cannot be made while driving.

The , ,  and OK buttons are used in the setting mode.

Use the  button to select a menu.

Push OK to decide a menu.

### Driver Assistance

The following submenus are displayed under the Driver Assistance menu.

#### Emergency Brake (if equipped):

Select this submenu to enable/disable the Intelligent Emergency Braking system.

For additional information, see "Intelligent Emergency Braking" (P.5-61).

#### Lane (if equipped):

The following submenu is displayed under the Lane menu.

- Warning (LDW)  
Select this submenu to enable/disable the Lane Departure Warning system.

For additional information, see "Lane Departure Warning (LDW)" (P.5-30).

#### Blind Spot (if equipped):

The following submenu is displayed under the Blind Spot menu.

- Warning (BSW)  
Select this submenu to enable/disable the Blind Spot Warning system.

For additional information, see "Blind Spot Warning (BSW)" (P.5-34).

#### Parking Aids (if equipped):

The following submenus are displayed under the Parking Aids menu.

- Moving Object (if equipped)  
Select this submenu to enable/disable the Moving Object Detection (MOD).

For additional information, see "Moving Object Detection (MOD)" (P.4-19).

- Sensor  
Select this submenu to enable/disable the parking sensor (sonar) system.
- Volume  
Select this submenu to change the parking sensor (sonar) buzzer volume.
- Distance  
Select this submenu to change the parking sensor (sonar) detection range.

For additional information, see "Parking sensor (sonar) system" (P.5-79).

#### Cross Traffic Alert (if equipped):

Select this submenu to enable/disable the Rear Cross Traffic Alert (RCTA) system.

For additional information, see "Rear Cross Traffic Alert (RCTA)" (P.5-40).

#### Driver Attention Alert (if equipped):

Select this submenu to enable/disable the Intelligent Driver Alertness system.



For additional information, see "Intelligent Driver Alertness" (P.5-74).

#### Timer Alert:

Select this submenu to set an alert to notify the driver that the set time has been reached.

The following submenus are displayed under the Timer Alert menu.

- ---min / ---min
- Reset

To change the timer amount, use the  button  and push the OK button  to save the selected time amount.

#### Low Temp. Alert (if equipped):

Select this submenu to enable/disable the Low Temperature Alert.

For additional information, see "Outside air temperature (°C or °F)" (P.2-36).

#### ECO Mode Setting

The following submenus are displayed under the ECO Mode Setting menu.

#### ECO Drive Report:

Select this submenu to enable/disable the ECO Drive Report in the vehicle information display.

#### View History:

Select this submenu to reset the past history of the fuel economy and the best fuel economy. See "ECO drive report" (P.5-76).





### TPMS Setting (if equipped)

The settings in the "TPMS Setting" menu are all related to the Tire Pressure Monitoring System (TPMS). (See "Tire Pressure Monitoring System (TPMS)" (P.5-5).)

- Target front (if equipped)
- Target rear (if equipped)
- Tire/Tyre Pressure Unit
- TPMS Reset (if equipped)



#### Target front (if equipped):

The "Target front" tire pressure is the pressure specified for the front tires on the tire placard. (See "Tire placard" (P.9-10) and "Tire Pressure Monitoring System (TPMS)" (P.5-5).)

Use the   and the OK  buttons to select and change the value for the "Target Front" tire pressure.

#### Target rear (if equipped):



The "Target rear" tire pressure is the pressure specified for the rear tires on the tire placard. (See "Tire placard" (P.9-10) and "Tire Pressure Monitoring System (TPMS)" (P.5-5).)

Use the   and the OK  buttons to select and change the value for the "Target rear" tire pressure.

#### Tire/Tyre Pressure Unit:

The unit for tire pressure that is shown in the vehicle information display can be changed to:

- kPa
- psi
- bar
- kgf/cm<sup>2</sup>



Use the   and the OK  buttons to select and change the unit.

### TPMS Reset (if equipped):

This setting allows the customer to reset the TPMS.

The tire pressure is affected by the temperature of the tire; the tire temperature increases when the car is driven. To be able to accurately monitor the tire air leakage and to prevent false TPMS warnings due to changes in temperature, the TPMS system uses temperature sensors in the tires to perform temperature compensation calculations.

On rare occasions it may be necessary to recalibrate the TPMS system reference temperature. This operation should only be performed when the actual tire pressure has been adjusted, while the current ambient temperature is significantly different to the current calibration temperature. (See "Tire Pressure Monitoring System (TPMS)" (P.5-5).)

Use the   and the OK  buttons to select and reset the TPMS. (See "TPMS resetting (model with TPMS reset function)" (P.5-7).)

### Clock

#### Clock Mode (if equipped):

The adjustment settings can be selected from "Auto", "Manual" and "Time Zone".

- Auto
- Manual
- Time Zone (if equipped)

#### Clock Format:

The time setting can be selected from 12 hour and 24 hour formats.



### Summer Time (if equipped):

Turns the Summer Time on or off.

### Time Zone (if equipped):

Select the applicable time zone from the list.

### Set Clock Manually:

The clock setting can be changed using the   and the OK  buttons.

### Vehicle Settings

The following submenus are displayed under the Vehicle Settings menu.

#### Lighting:

The following submenus are displayed.

- Auto Room Lamp  
Select this submenu to enable/disable the auto room lamp feature.  
The interior lights will be ON if any door is unlocked when the auto room lamp is enabled.
- Auto headlight/Light Sensitivity  
The light sensitivity can be set to illuminate earlier or later based on the brightness outside the vehicle.
- Light Off Delay (if equipped)  
The duration of the automatic headlights can be changed from 0 to 180 seconds. Use the OK button  to change the duration.

#### Turn indicator:

Select this submenu to enable/disable the "3 flashes" lane change signal feature.

### Locking:

The following submenu is displayed.

- Ext. Door Switch  
Select this submenu to activate/deactivate the request switch on the door.

### Wipers (if equipped):

The following submenu is displayed.

- Speed Dependent  
Select this submenu to activate/deactivate the speed dependent wiper speed feature.

### Mirrors (if equipped):

The following submenus are displayed.

- Auto Fold Off  
When this item is turned on, the auto fold feature for the outside rearview mirrors is disabled. Use the OK button ① to select this function.
- Unfold at Ignition  
When this item is turned on, the outside rearview mirrors automatically fold when the doors are locked, and unfold when the ignition switch is placed in the "ACC" or "ON" position. Use the OK button ① to select this function.

### Maintenance

The following submenus are displayed under the Maintenance menu.

#### Oil Control System (YS23DDTT engine models):

Select this submenu to reset the distance for replacing the engine oil.

To reset the oil replacement indicator, select "Oil Control System", push OK ① (for more than 1 second but less than 3 seconds) and select "Yes".

The distance to oil change interval cannot be adjusted manually. The interval is set automatically.

For more details, see "Oil control system (YS23DDTT engine models)" (P.2-35).

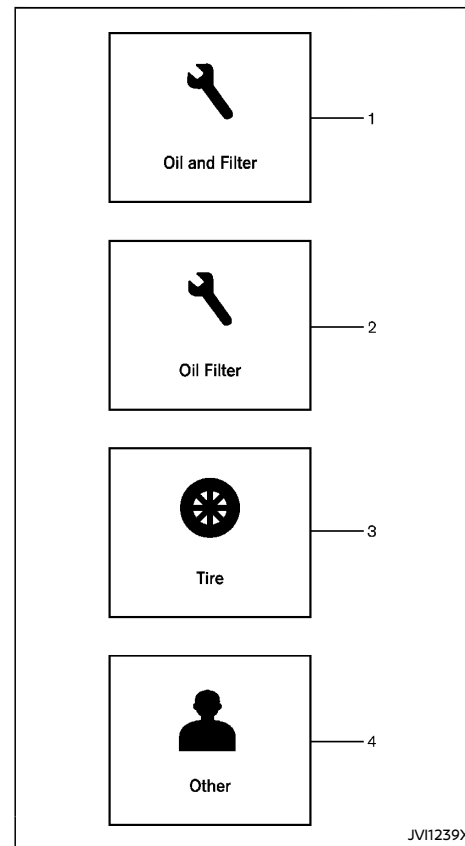

### 1. Oil and Filter (except for YS23DDTT engine models):

Select this submenu to set or reset the distance for replacing the engine oil and oil filter.

#### NOTE:

**Be sure to reset the distance for replacing the engine oil and oil filter after replacing. Otherwise, the oil and filter replacement indicator will continue to be displayed.**

### 2. Oil Filter (YS23DDTT engine models):

Select this submenu to set or reset the distance for replacing the oil filter.

### 3. Tire/Tyre:

Select this submenu to set or reset the distance for replacing tires.



#### WARNING:



**The tire replacement indicator is not a substitute for regular tire checks, including tire pressure checks. See "Changing tires and wheels" (P.8-34). Many factors including tire inflation, alignment, driving habits and road conditions affect tire wear and when tires should be replaced. Setting the tire replacement indicator for a certain driving distance does not mean your tires will last that long. Use the tire replacement indicator as a guide only and always perform regular tire checks. Failure to perform regular tire checks, including tire pressure checks could result in tire failure. Serious vehicle damage could occur and may lead to a collision, which could result in serious personal injury or death.**

### 4. Other:

Select this submenu to set or reset the distance for replacing items other than the engine oil, oil filter and tires.

#### Customize Display

The display settings allows you to choose from the various meter selections.

The display settings can be changed using the  button  and the OK  buttons.

#### Main Menu Selection:

Displays available screens that can be shown in the vehicle information display.

#### Route Guidance (if equipped):

- Alerts

The "Alerts" allows you to turn the auto turn notification alerts on or off.

#### Welcome Effect:



The "Welcome Effect" displays the available welcome effect settings.

- Gauges
- Animation

#### Unit/Language

The units that are shown in the vehicle information display can be changed:



- Mileage/Fuel
- Tire/Tyre Pressures (if equipped)
- Temperature
- Language

Use the   and the OK  buttons to select and change the units of the vehicle information display.

#### Mileage/Fuel:

The unit for the mileage that displays in the vehicle information display can be changed.

- km, km/l
- km, l/100km
- miles, MPG(UK)
- miles, MPG(US)

Use the   and the OK  buttons to select and change the unit.

### Tire/Tyre Pressures (if equipped):

The unit for tire pressure that displays in the vehicle information display can be changed to:

- kPa
- psi
- bar
- kgf/cm<sup>2</sup>

Use the  ② and the OK ① buttons to select and change the unit.

If necessary, refer to the following table to convert between units.

kPa	200	210	220	230	240	250	260	270	280	290	300	310	320	330	340
psi	29	30	32	33	35	36	38	39	41	42	44	45	46	48	49
bar	2.0	2.1	2.2	2.3	2.4	2.5	2.6	2.7	2.8	2.9	3.0	3.1	3.2	3.3	3.4
kgf/cm <sup>2</sup>	2.0	2.1	2.2	2.3	2.4	2.5	2.6	2.7	2.8	2.9	3.0	3.1	3.2	3.3	3.4

JVI0938X

### Temperature:

The temperature that displays in the vehicle information display can be changed from:

- °C
- °F

Use the OK ① button to toggle choices.

### Language:

The language of the vehicle information display can be changed.

Use the  ② and the OK ① buttons to select and change the language of the vehicle information display.

### Factory Reset

The settings in the vehicle information display can be reset back to the factory default. To reset the vehicle information display:

1. Select "Factory Reset" using the  button ② and press the OK button ①.
2. Select "YES" to return all settings back to default by pressing the OK button ①.

## VEHICLE INFORMATION DISPLAY WARNINGS AND INDICATORS

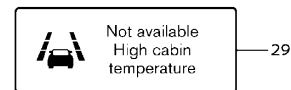
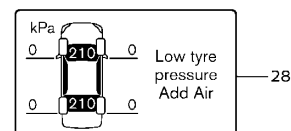
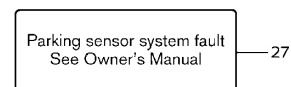
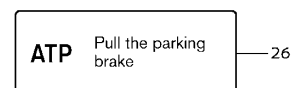
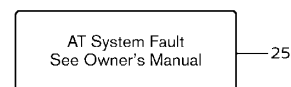
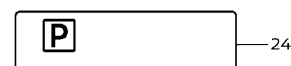
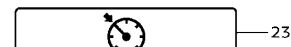
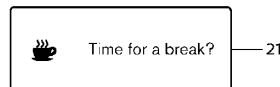
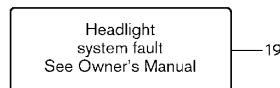
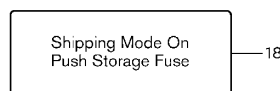
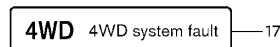
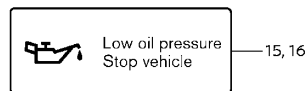
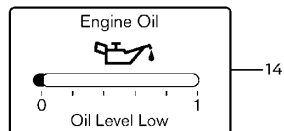
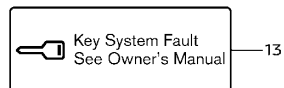
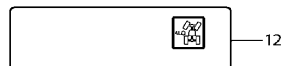
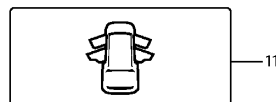
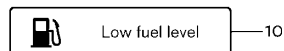
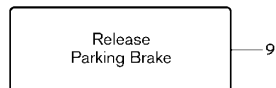
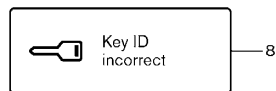
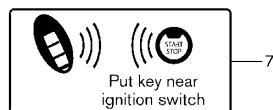
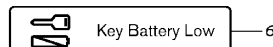
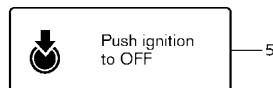
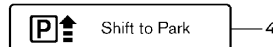
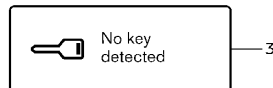
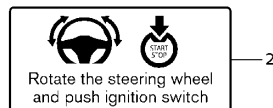
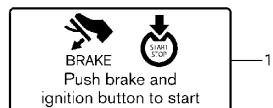



WAC0739X

 Not available  
Side radar  
obstructed — 30

 Not available  
Side radar  
obstructed — 31

 Not Available  
Front Radar Blocked — 32

 Not Available,  
System Malfunction — 33

 Not Available,  
System Malfunction — 34

 Not Available,  
System Malfunction — 35

 System fault — 36

 System fault — 37

 System fault — 38

Power will turn off  
to save the battery — 39

Power turned off  
to save the battery — 40

Press brake pedal — 41

 — 42

Not Available  
Poor Road Conditions — 43

 Currently not available — 44

### 1. Engine start operation indicator

This indicator appears when the shift lever is in the "P" (Park) position.

This indicator means that the engine will start by pushing the ignition switch with the brake pedal depressed. You can start the engine directly in any position of the ignition switch.

### 2. Steering lock release malfunction indicator

This indicator appears when the steering wheel cannot be released from the "LOCK" position.

If this indicator appears, push the ignition switch while lightly turning the steering wheel right and left.

See "Steering lock" (P.5-12).

### 3. No Key Detected warning

This warning appears when the door is closed with the Intelligent Key left outside the vehicle and the ignition switch in the "ON" position. Make sure that the Intelligent Key is inside the vehicle.

See "Intelligent Key system" (P.3-7) for more details.

### 4. Shift to Park warning

This warning appears when the ignition switch is pushed to stop the engine with the shift lever in any position except the "P" (Park) position.

If this warning appears, move the shift lever to the "P" (Park) position or push the ignition switch to the "ON" position.

An inside warning chime will also sound. (See "Intelligent Key system" (P.3-7).)

### 5. "PUSH" warning

This warning appears when the shift lever is moved to the "P" (Park) position with the ignition switch in the "ACC" position after the Shift to Park warning appears.

To push the ignition switch to the "OFF" position, perform the following procedure:

**Shift to Park warning** → (Move the shift lever to "P") → **PUSH warning** → (Push the ignition switch → ignition switch position is turned to "ON") → **PUSH warning** → (Push the ignition switch → ignition switch position is turned to "OFF")

### 6. Key Battery low warning

This warning appears when the Intelligent Key battery is running out of power.

If this warning appears, replace the battery with a new one. (See "Intelligent Key battery" (P.8-25).)

### 7. Engine start operation for Intelligent Key system indicator

This indicator appears when the Intelligent Key battery is running out of power and when the Intelligent Key system and vehicle are not normally communicated.

If this indicator appears, touch the ignition switch with the Intelligent Key while depressing the brake pedal. (See "Intelligent Key battery discharge" (P.5-13).)

### 8. Key ID Incorrect warning

This warning appears when the ignition switch is placed from the "LOCK" position and the Intelligent Key cannot be recognized by the system. You cannot start the engine with an unregistered key. Use the registered Intelligent Key.

See "Intelligent Key system" (P.3-7).

### 9. Release Parking Brake warning

This warning appears when the vehicle speed is above 7 km/h (4 MPH) (models not equipped with electronic parking brake) or 3 km/h (2 MPH) (models equipped with electronic parking brake) and the parking brake is applied. Stop the vehicle and release the parking brake.

### 10. Low fuel warning

This warning appears when the fuel level in the tank is getting low. Refuel as soon as it is convenient, preferably before the fuel gauge reaches the empty (0) position.

**There will be a small reserve of fuel remaining in the tank when the fuel gauge reaches the empty (0) position.**

### 11. Door/back door open warning

This warning appears if any of the doors and/or the back door are open or not closed securely. The vehicle icon indicates which door or the back door is open on the display.

## 12. 4WD mode indicator (if equipped)

This indicator shows the drive mode of the 4WD system.

See "Four-Wheel Drive (4WD)" (P.5-19) for details.

## 13. Key System Fault warning

This warning appears if there is a malfunction in the Intelligent Key system.

If this warning appears while the engine is stopped, the engine cannot be started. If this warning appears while the engine is running, the vehicle can be driven. However, contact a NISSAN dealer for repair as soon as possible.

## 14. Oil Level Low indicator (if equipped)

If the low level indicator is displayed, the engine oil level is low. If the low level indicator is displayed, check the level using the engine oil dipstick. (See "Engine oil" (P.8-10).)



### CAUTION:

**The oil level should be checked regularly using the engine oil dipstick. Operating with an insufficient amount of oil can damage the engine and such damage is not covered by the warranty.**

## 15. Oil level sensor warning (if equipped)

If the oil level sensor warning is displayed, the engine oil level sensor may be malfunctioning. Contact a NISSAN dealer immediately.

## 16. Low Oil Pressure Stop vehicle warning (if equipped)

This warning appears if low engine oil pressure is detected. If the warning appears during normal driving, pull off the road in a safe area, stop the engine immediately and call a NISSAN dealer.

The low oil pressure warning is not designed to indicate a low oil level. Use the dipstick to check the oil level. (See "Engine oil" (P.8-10).)



### CAUTION:

**Running the engine with the engine oil pressure warning displayed could cause serious damage to the engine.**

## 17. 4WD system fault warning (if equipped)

This warning appears when the four wheel drive (4WD) system is not functioning properly while the engine is running. Reduce vehicle speed and have your vehicle checked by a NISSAN dealer. See "4WD warning" (P.5-23).

## 18. Shipping Mode On Push Storage Fuse warning (if equipped)

This warning may appear if the extended storage fuse switch is not pushed in (switched on). When this warning appears, push in (switch on) the extended storage fuse switch to turn off the warning. For more information, see "Extended storage fuse switch" (P.8-28).

## 19. Headlight system fault warning

This warning appears if the LED headlights are malfunctioning. Have the system checked by a NISSAN dealer.

## 20. Reminder Turn OFF Headlights warning

This warning appears when the driver side door is opened with the headlight switch is left ON and the ignition switch is placed in the "OFF", "ACC" or "LOCK" position. Place the headlight switch in "OFF" or "AUTO" position. For additional information, see "Headlight and turn signal switch" (P.2-36).

## 21. Time for a break? indicator

This indicator appears when the set "Timer Alert" alarm activates. You can set the time for up to 6 hours. (See "Settings" (P.2-22).)

## 22. Take a break? indicator (if equipped)

This indicator appears when the system has detected that the driver may be displaying fatigue or a lack of attention. (See "Intelligent Driver Alertness" (P.5-74).)

## 23. Cruise control indicator

This indicator shows the cruise control system status. The status is shown by the color.

See "Cruise control" (P.5-45) for details.

## 24. Automatic Transmission (AT) position indicator (AT model)

This indicator shows the automatic shift position.

In the manual shift mode, when the transmission does not shift to the selected gear due to a transmission protection mode, the AT position indicator will blink and a chime will sound.

For further details, see "Driving with Automatic



Transmission (AT)" (P.5-15).

## 25. Automatic Transmission (AT) system fault warning (AT model)

If the Automatic Transmission (AT) system fault warning appears while the engine is running, or while driving, it may indicate that the AT is not functioning properly and may need servicing. Have the system checked, and if necessary repaired, by a NISSAN dealer promptly.

## 26. Automatic Transmission (AT) park warning (AT model)

This warning indicates that the Automatic Transmission (AT) parking function is not engaged. If the transfer control is not secured in any driving position while the AT shift lever is in the "P" (Park) position, the transmission will disengage and the wheels will not lock.

**For 4WD model: If the ATP warning appears with the shift lever in the "P" (Park) position, shift the Four-Wheel Drive (4WD) mode switch to the 2WD, 4H or 4LO position again with the shift lever in the N (Neutral) position.** (See "Four-Wheel Drive (4WD)" (P.5-19).)



### **WARNING:**

**If the 4WD mode indicator (see "4WD mode indicator" (P.5-23)) is "OFF" or the ATP warning light is "ON", this indicates that the automatic transmission P (Park) position will not function and could result in the vehicle moving unexpectedly, causing serious personal injury or property damage. Always set the parking brake.**

## 27. Parking sensor system fault warning (if equipped)

This warning appears when the parking sensor (sonar) system is not functioning properly. If the warning appears, have the system checked by a NISSAN dealer.

## 28. Low Tire Pressure warning (if equipped)

This warning appears when the low tire pressure warning light in the meter illuminates and low tire pressure is detected. The warning appears each time the ignition switch is placed in the "ON" position as long as the low tire pressure warning light remains illuminated. If this warning appears, stop the vehicle and adjust the pressure to the recommended COLD tire pressure shown on the tire placard. (See "Low tire pressure warning light" (P.2-15) and "Tire Pressure Monitoring System (TPMS)" (P.5-5).)

## 29. Not available High cabin temperature warning (if equipped)

This warning appears if the interior temperature of the vehicle has reached such a high temperature that the sensor for the Lane Departure Warning (LDW) can no longer function reliably. Once the interior temperature has reached normal levels, the warning should disappear.

If the warning continues to appear, have the system checked by a NISSAN dealer. For more details, see "Lane Departure Warning (LDW)" (P.5-30).

## 30-31. Not available Side radar obstructed warning (if equipped)

This warning is displayed if the area near the radar units used by the Blind Spot Warning (BSW)/Rear Cross Traffic Alert (RCTA) system is dirty or covered with snow or rain. If the warning appears, park the vehicle in a safe place, turn off the engine, and clean the area. Then restart the engine.

The system is not available until the conditions no longer exist. See "Blind Spot Warning (BSW)" (P.5-34) or "Rear Cross Traffic Alert (RCTA)" (P.5-40).

## 32. Not Available Front Radar Blocked warning (if equipped)

This message appears when the front radar sensor may be obstructed due to:

- mud, dirt, snow, ice, etc.
- inclement weather (rain, fog, snow, etc).

All forward driving aids are temporarily disabled until the system detects that the front radar sensor is no longer obstructed. For additional information, see "Intelligent Cruise Control (ICC)" (P.5-47), "Intelligent Emergency Braking" (P.5-61) or "Intelligent Forward Collision Warning system" (P.5-68).

## 33-35. Not Available, System Malfunction warning (if equipped)

This warning appears when there is a malfunction with the following system(s):

- Lane Departure Warning (LDW) system
- Blind Spot Warning (BSW) system
- Intelligent Cruise Control (ICC) system

If this warning appears, stop the vehicle in a safe location, turn off and restart the engine. If the warning continues to appear, have the

system(s) checked by a NISSAN dealer.

For more details, see "Lane Departure Warning (LDW)" (P.5-30), "Blind Spot Warning (BSW)" (P.5-34) or "Intelligent Cruise Control (ICC)" (P.5-47).

### 36-38. System fault warning (if equipped)

This warning appears when the following system(s) are not functioning properly if the vehicle is equipped with them.

- Intelligent Driver Alertness system
- Rear Cross Traffic Alert (RCTA) system
- Intelligent Emergency Braking system
- Intelligent Forward Collision Warning system

For more details, see "Intelligent Driver Alertness" (P.5-74), "Rear Cross Traffic Alert (RCTA)" (P.5-40), "Intelligent Emergency Braking" (P.5-61) or "Intelligent Forward Collision Warning system" (P.5-68).

### 39. Power will turn off to save the battery warning

This warning appears after a period of time if the shift lever has not moved from the "P" (Park) position.

### 40. Power turned off to save the battery warning

This warning appears after the ignition switch is automatically turned OFF to save the battery.

### 41. Press brake pedal (for electronic parking brake equipped models)

This warning appears in the following situations:

- The driver tries to release the electronic parking brake manually without depressing the brake pedal.
- The vehicle is stopped on a steep hill and there is a possibility of moving backward, even if the electronic parking brake is

applied.

### 42. Intelligent Cruise Control (ICC) system ON indicator (if equipped)

This indicator shows the Intelligent Cruise Control (ICC) system status. The status is shown by the color. (See "Intelligent Cruise Control (ICC)" (P.5-47).)

### 43. Not Available Poor Road Conditions warning (if equipped)

This warning appears when the Intelligent Cruise Control (ICC) system is temporarily not available when the system detects that road conditions may not be suitable for the system. The ICC system will also turn off. For more details, see "Intelligent Cruise Control (ICC)" (P.5-47).

### 44. Currently not available warning (if equipped)

This message may appear when the Intelligent Cruise Control (ICC) is engaged.

Under the following conditions, the Intelligent Cruise Control (ICC) is automatically canceled:

- When the VDC system is turned off
- When the 4WD mode switch is in the 4H or 4LO position (4WD model)

The above system cannot be used in some situations (VDC operates, wheel slip and VDC system is off).

For more details, "Intelligent Cruise Control (ICC)" (P.5-47).

## TRIP COMPUTER

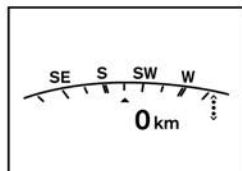

1

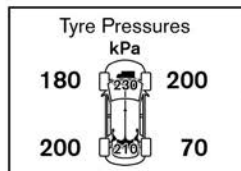

5

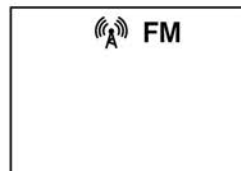

9

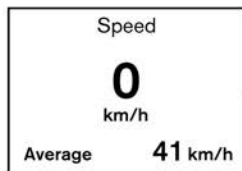

2

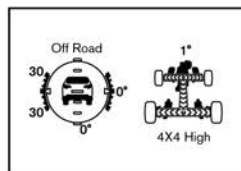

6

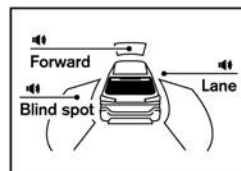

10

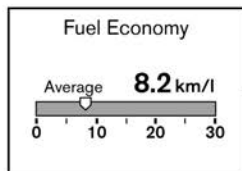

3

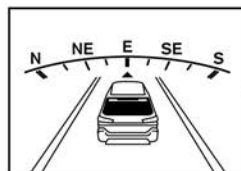

7

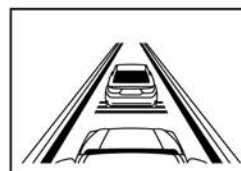

11



4



8

WAC0700X

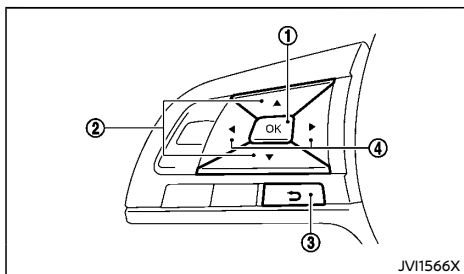

The vehicle information display can be changed using the buttons OK ①,  $\blacktriangleup$  ②,  $\blacktriangleright$  ③, and  $\blacktriangleleft$   $\blacktriangleright$  ④ located on the left side of the steering wheel.

- ① OK - change or select an item in the vehicle information display
- ②  $\blacktriangleup$  - navigate through the items in vehicle information display
- ③  $\blacktriangleright$  - go back to the previous menu
- ④  $\blacktriangleleft$   $\blacktriangleright$  - change from one display screen to the next (i.e. trip, Fuel economy)

## 1. Home

The home mode shows the following information.

- Vehicle speed
- Compass (if equipped)
- Audio

## 2. Vehicle speed (km/h)

The vehicle speed mode shows the current vehicle speed and the average vehicle speed since the last reset.

### Average vehicle speed:

The average vehicle speed display is updated every 30 seconds. The first 30 seconds after a reset, the display shows "—".

To reset the average speed, push the OK button ① for longer than 1 second.

To reset the fuel economy and average speed, push the OK button ① for longer than 3 seconds or more.

## 3. Fuel economy (km/l (liter) or l (liter)/100 km)

The average fuel consumption mode shows the average fuel consumption since the last reset.

The display is updated every 30 seconds. For about the first 500 m (1/3 mile) after a reset, the display shows "—".

To reset the fuel economy, push the OK button ① for longer than 1 second.

To reset the fuel economy and average speed, push the OK button ① for longer than 3 seconds or more.

## 4. Elapsed time and trip odometer (km)

### Elapsed time:

The elapsed time mode shows the time since the last reset. The displayed time can be reset by pushing the OK button ① for longer than 1 second. (The trip odometer is also reset at the same time.)

### Trip odometer:

The trip odometer mode shows the total distance the vehicle has been driven since the last reset. Resetting is done by pushing the OK button ① for longer than 1 second. (The elapsed time is also reset at the same time.)

## 5. Tyre Pressure/Tire Pressure

The tire pressure mode shows the pressure of all four tires while the vehicle is driven.

When the Low Tire Pressure warning appears, the display can be switched to the tire pressure mode by pushing the OK button ① to reveal additional details on the displayed warning.

## 6. Off-road meter and 4WD status indicators (if equipped)

### Off-road meter:

The off-road meter displays the various slopes of the vehicle.

The off-road meter indicates the angle of the vehicle position up or down and left or right. The value will be displayed below the gauge while the vehicle graphic will rotate to indicate condition pointed up or down and left or right.

### 4WD status indicators:

These indicators show which 4WD mode is selected. For additional information, refer to "Four-Wheel Drive (4WD)" (P.5-19).

The tire angle (center) indicates the angle of the tires based on turning of the steering wheel. The graphic image will show the actual vehicle tire position while the angle is to be displayed below as reference.

## 7. Compass (if equipped)

The compass mode shows the heading direction of the vehicle.

## 8. Navigation (if equipped)

When the route guidance is set in the navigation system, this item shows the navigation route information.

For more details, see the separate NissanConnect Owner's Manual.

## 9. Audio (if equipped)

The audio mode shows the status of audio information.

## 10. Driving Aids (if equipped)

The Driving Aids mode shows the operating condition for the following systems.

- Lane Departure Warning (LDW)
- Blind Spot Warning (BSW)
- Intelligent Emergency Braking system
- Intelligent Forward Collision Warning system

For more details, see "Lane Departure Warning (LDW)" (P.5-30), "Blind Spot Warning (BSW)" (P.5-34), "Intelligent Emergency Braking" (P.5-61) and "Intelligent Forward Collision Warning system" (P.5-68).

## 11. Intelligent Cruise Control (ICC) (if equipped)

This display indicates the operation condition of the Intelligent Cruise Control (ICC) system.

See "Intelligent Cruise Control (ICC)" (P.5-47) for more details.

## OIL CONTROL SYSTEM (YS23DDTT engine models)

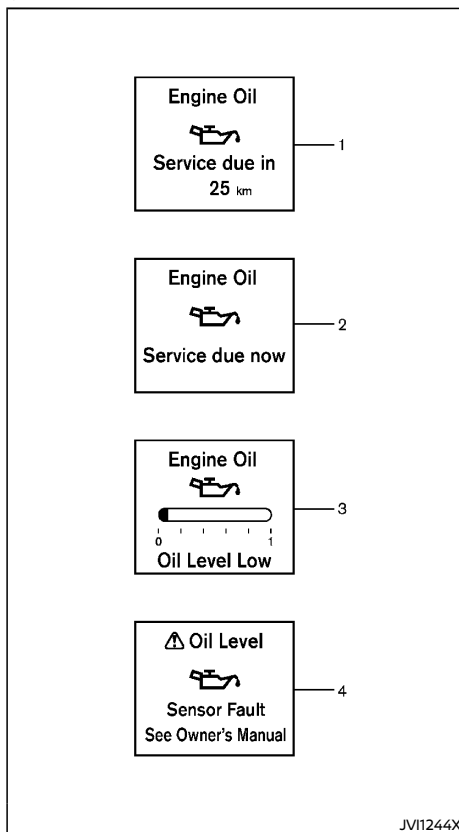

When the ignition switch is in the "ON" position, engine oil information is displayed.

Engine oil information informs the distance to oil change, oil level indication and malfunction of oil level sensor.

### 1. Distance to oil change

The distance to oil change is displayed if the distance to oil change is less than 1,500 km (930 miles).

### 2. Oil replacement indicator

When the set mileage approaches, the engine oil replacement indicator will appear on the display. After the oil is changed, reset the distance to oil change. The oil replacement indicator will not be reset automatically. To reset this indicator, see "Settings" (P.2-22).

The distance to oil change interval cannot be adjusted manually. The distance to oil change interval is set automatically.



### CAUTION:

- If the oil replacement indicator is displayed, change the engine oil as soon as possible. Operating your vehicle with deteriorated oil can damage the engine.
- Never perform reset if the engine oil was not changed. Always visit a NISSAN dealer to perform the engine oil change including an oil filter change and the reset.

### NOTE:

- It is not possible to undo the reset.
- Resetting the oil change distance is only possible when:
  - The distance to oil change is displayed in the vehicle information display.

# HEADLIGHT AND TURN SIGNAL SWITCH

## HEADLIGHT SWITCH

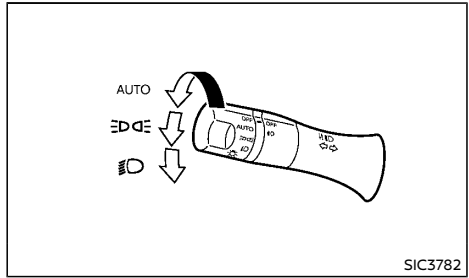

Type A

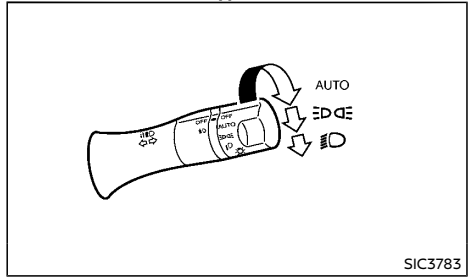

Type B

The headlight switch varies depending on the model.

NISSAN recommends that you consult the local regulations concerning the use of lights.

## CLOCK AND OUTSIDE AIR TEMPERATURE

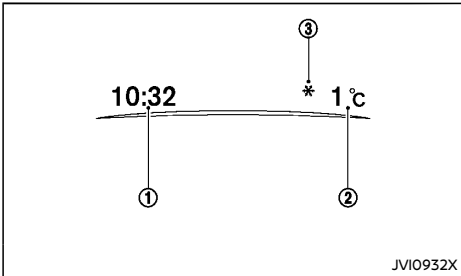

The clock ① and outside air temperature ② are displayed on the upper side of the vehicle information display.

### Clock

For clock adjustment, see "Clock" (P.2-23) or the separate NissanConnect Owner's Manual (if equipped).

### Outside air temperature (°C or °F)

The outside air temperature is displayed in °C or °F in the range of -40 to 60°C (-40 to 140°F).

The outside air temperature mode includes a low temperature warning feature. If the outside air temperature is below 3°C (37°F), the warning ③ is displayed on the screen (if equipped).

The outside temperature sensor is located in front of the radiator. The sensor may be affected by road or engine heat, wind directions and other driving conditions. The display may differ from the actual outside temperature or the temperature displayed on various signs or billboards.

– The oil replacement indicator is displayed in the vehicle information display.

- The engine oil should be changed before the distance to oil change reaches 0 km (0 miles). Continued driving after the distance to oil change reaches 0 km (0 miles) may result in reduced engine performance.
- The oil change interval will reduce faster with certain types of driving, especially at low speeds in urban conditions.

### 3. Low level reminder

If the low level indicator is displayed, the engine oil level is low. If the low level reminder is displayed, check the level using the engine oil dipstick. (See "Engine oil" (P.8-10).)



#### CAUTION:

The oil level should be checked regularly using the engine oil dipstick. Operating with an insufficient amount of oil can damage the engine and such damage is not covered by the warranty.

### 4. Oil level sensor warning

If the oil sensor warning is displayed, the engine oil level sensor may be malfunctioning. Contact a NISSAN dealer immediately.

## AUTO position

When the ignition switch is in the "ON" position and the headlight switch is in the "AUTO" position, the headlights, front clearance lights, instrument panel lights, rear combination lights and other lights turn on automatically depending on the brightness of the surroundings.

The headlights will turn on automatically at twilight or in rainy weather (when the windshield wiper is operated continuously).

When the ignition switch is placed in the "OFF" position, the lights will turn off automatically.

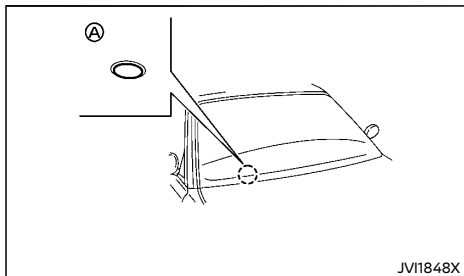

### CAUTION:

**Do not place any objects on top of the sensor ①. The sensor senses the brightness level and controls the Intelligent Auto Headlight function. If the sensor is covered, it reacts as if it is dark, and the headlights will illuminate.**

### Automatic headlights off delay (if equipped):

You can keep the headlights on for up to 180 seconds after you place the ignition switch in the "OFF" position and open any door then close all the doors.

You can adjust the period of the automatic

headlights off delay from 0 seconds (OFF) to 180 seconds. The factory default setting is 45 seconds.

For automatic headlights off delay setting, see "Vehicle Settings" (P.2-23).

### EDGE position

The  position turns on the front clearance, instrument panel, tail and license plate lights.

### HEAD position

The  position turns on the headlights in addition to the other lights.

## Headlight beam

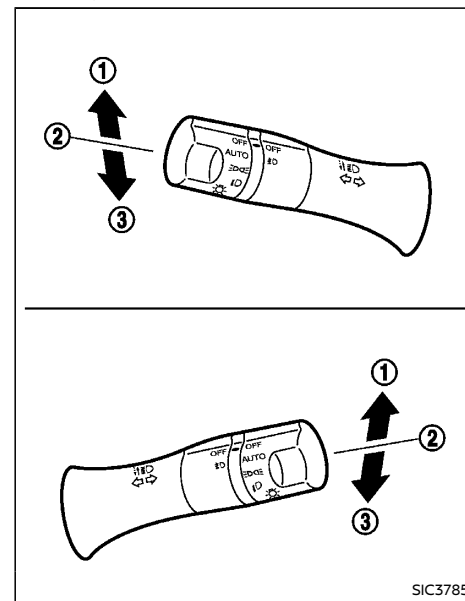

To turn on the high beam, push the lever towards the front position ①.

To turn off the high beam, return the lever to the neutral position ②.

To flash the headlights, pull the lever towards the rearmost position ③. The headlights can be flashed even when the headlights are not on.

If equipped, when the lever is pulled towards the rearmost position ③ after the ignition switch is placed in the "OFF" or "LOCK" position, the headlight will turn on and stay on for 30

seconds. The lever can be pulled 4 times for up to 2 minutes.

#### Daytime running light system (if equipped)

Even if the headlight switch is in the "OFF" position, the daytime running lights will come on after starting the engine.

When the light switch is turned to the  $\text{DRL}$  or  $\text{DRL}$  position, the daytime running light will turn off.

#### AUTOMATIC AIMING CONTROL (if equipped)

The headlights are equipped with the automatic leveling system. Headlight axis is controlled automatically.

#### BATTERY SAVER SYSTEM

The light reminder chime will sound if the headlight switch is in either the  $\text{DRL}$  or  $\text{DRL}$  position and when the driver's door is opened with the ignition switch in the "ACC", "OFF" or "LOCK" position.

If the ignition switch is in the "OFF" or "LOCK" position and the doors are closed and locked while the headlight switch is in either the  $\text{DRL}$  or  $\text{DRL}$  position, the battery saver function will turn off the lights to prevent the battery from being discharged. The lights will turn on when the ignition switch is placed in the "ON" position.



#### CAUTION:

Do not leave the lights on when the engine is not running for extended periods of time to prevent the battery from being discharged.

#### TURN SIGNAL SWITCH

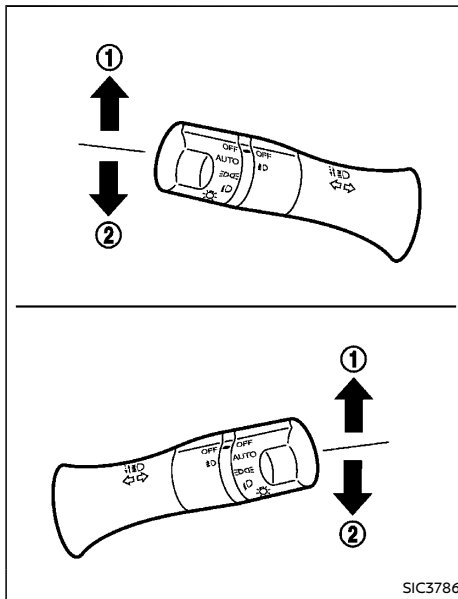

#### CAUTION:

The turn signal switch will not be canceled automatically if the steering wheel turning angle does not exceed the preset amount. After the turn or lane change, make sure that the turn signal switch is returned to its original position.

#### Turn signal

To turn on the turn signals, move the lever up ① or down ② to the point where the lever latches. When the turn is completed, the turn signal cancels automatically.

#### Lane change signal

To turn on the lane change signals, move the lever up ① or down ② to the point where the light begins to flash.

If the lever is moved back to its original position right after moving up or down, the light will flash 3 times.

To cancel the flashing, move the lever to the opposite direction.



## FOG LIGHT SWITCH (if equipped)

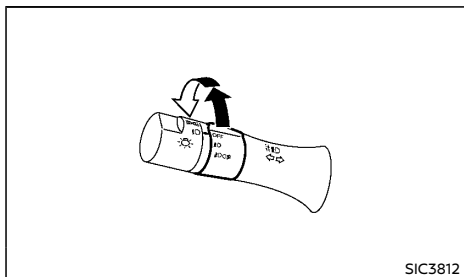

Type A (front and rear fog lights)

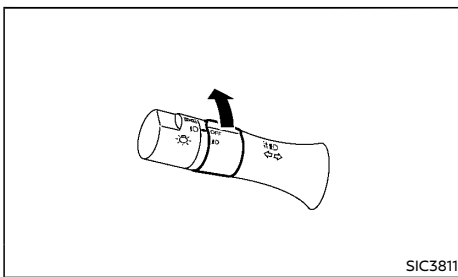

Type C (front fog light)

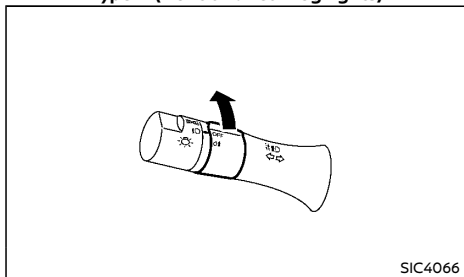

Type B (rear fog light)

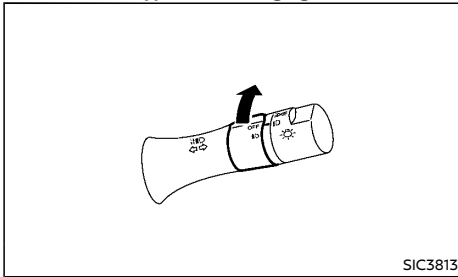

Type D (front fog light)

### FRONT FOG LIGHTS (if equipped)

To turn on the front fog lights, turn the fog light switch to the **F** position with the headlight switch in the **ON** or **AUTO** position.

To turn off the fog lights, turn the fog light switch to the "OFF" position.

### REAR FOG LIGHT (if equipped)

The rear fog light should be used only when visibility is seriously reduced. [Generally, to less than 100 m (328 ft)]

#### Type A

To turn on the rear fog light, turn the fog light switch to the **R** position with the headlight switch in the **ON** or **AUTO** position with front fog lights on. The switch returns to the **OFF** position automatically, and the rear fog light will illuminate with the front fog lights. Make sure the **R** indicator light on the instrument panel illuminates.

To turn off the rear fog light, turn the fog light switch to the **OFF** position again. Make sure the **R** indicator light on the instrument panel turns off.

To turn off both the front and rear fog lights, turn the fog light switch to the "OFF" position.

#### Type B

To turn on the rear fog light, turn the headlight switch to the **ON** position, then turn the fog light switch to the **R** position.

The switch returns to the "OFF" position automatically, and the rear fog light will illuminate. Make sure the **R** indicator light on the instrument panel illuminates.

To turn off the rear fog light, turn the fog light switch to the **OFF** position again. Make sure the **R** indicator light on the instrument panel turns off.

#### NOTE:

**If the headlight switch is turned to the "OFF" position, the front fog lights (if equipped) and rear fog light will turn off automatically.**

## WIPER AND WASHER SWITCH

### WARNING:

In freezing temperatures, the washer fluid may freeze on the windshield and obscure your vision. Warm the windshield with the defogger before you wash the windshield.

### CAUTION:

- Do not operate the washer continuously for longer than 30 seconds.
- Do not operate the washer if the window washer fluid reservoir is empty.
- If the wiper operation is interrupted by snow or ice, the wiper may stop moving to protect its motor. If this occurs, turn the wiper switch to the "OFF" position and remove the snow or ice on and around the wiper arms. In approximately 1 minute, turn the switch on again to operate the wiper.

## WINDSHIELD WIPER AND WASHER SWITCH

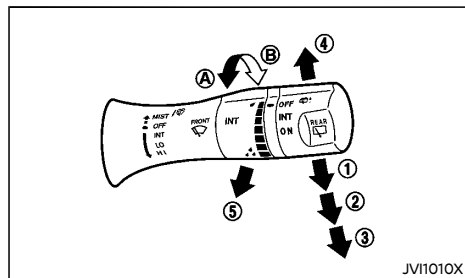

Type A

JV11010X

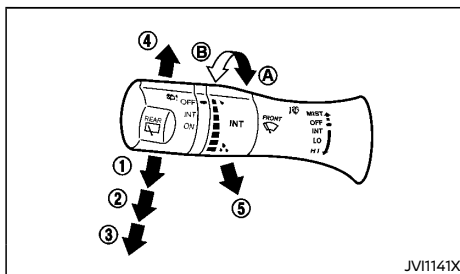

Type B

JV11141X

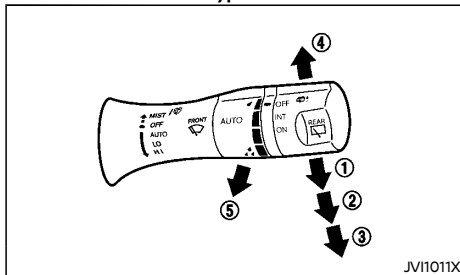

Type C

JV11011X

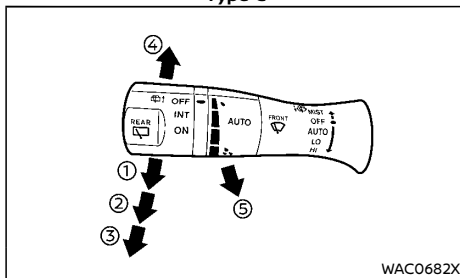

Type D

WAC0682X

The windshield wiper and washer operate

when the ignition switch is in the "ON" position.

### Wiper operation

The lever position "AUTO" (Type C/Type D) ① operates the rain-sensing auto wiper system (if equipped). (See "Rain-sensing auto wiper system" (P.2-41).)

The lever position "INT" (Type A/Type B) ② operates the wiper intermittently.

- The intermittent operation can be adjusted by turning the adjustment control knob, (longer) A or (shorter) B.
- The speed of the intermittent operation varies depending on the vehicle speed. This function can be turned on or off (if equipped). See "Settings" (P.2-22).

The lever position "LO" ② operates the wiper at low speed.

The lever position "HI" ③ operates the wiper at high speed.

To stop the wiper operation, move the lever up to the "OFF" position.

The lever position "MIST" ④ operates the wiper one sweep. The lever automatically returns to its original position.

### Washer operation

To operate the washer, pull the lever toward the back of the vehicle ⑤ until the desired amount of washer fluid is spread on the windshield. The wiper will automatically operate several times.

## RAIN-SENSING AUTO WIPER SYSTEM (if equipped)

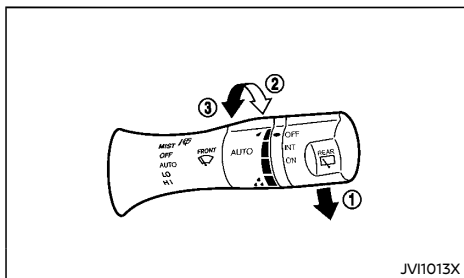

Type A

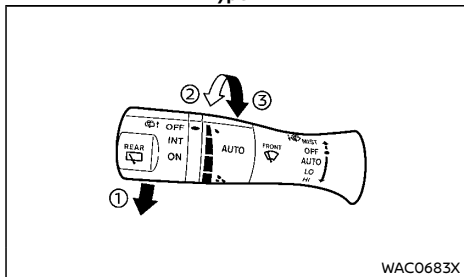

Type B

The rain-sensing auto wiper system can automatically turn on the wipers and adjust the wiper speed depending on the rainfall and the vehicle speed by using the rain sensor located on the upper part of the windshield.

To set the rain-sensing auto wiper system, push the lever down to the "AUTO" position ①. The wiper will sweep once while the ignition switch is in the "ON" position.

The rain sensor sensitivity level can be adjusted by turning the knob toward ② (High) or toward

③ (Low).

- High — High sensitive operation
- Low — Low sensitive operation

To turn the rain-sensing auto wiper system off, push up the lever to the "OFF" position, or pull down the lever to the "LO" or "HI" position.

### ⚠ CAUTION:

- Do not touch the rain sensor and around it when the wiper switch is in the "AUTO" position and the ignition switch is in the "ON" position. The wipers may operate unexpectedly and cause an injury or may damage a wiper.
- The rain-sensing auto wipers are intended for use during rain. If the switch is left in the "AUTO" position, the wipers may operate unexpectedly when dirt, fingerprints, oil film or insects are stuck on or around the sensor. The wipers may also operate when exhaust gas or moisture affect the rain sensor.
- When the windshield glass is coated with water repellent, the speed of the rain-sensing auto wipers may be higher even though the amount of the rainfall is small.
- Be sure to turn off the rain-sensing auto wiper system when you use a car wash.
- The rain-sensing auto wipers may not operate if rain does not hit the rain sensor even if it is raining.
- Using genuine wiper blades is recommended for proper operation of the rain-sensing auto wiper system. (See "Wiper blades" (P.8-20) for wiper blade replacement.)

## REAR WINDOW WIPER AND WASHER SWITCH

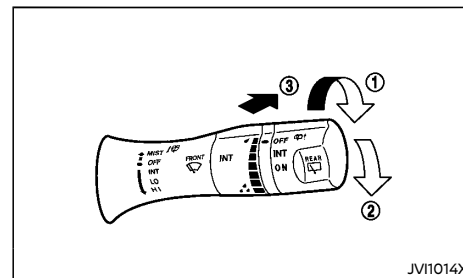

Type A

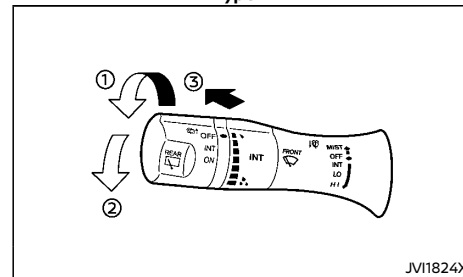

Type B

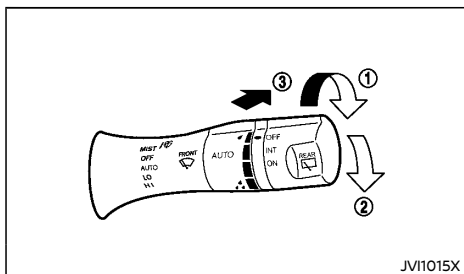

Type C

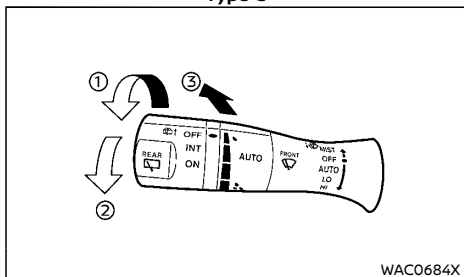

Type D

The rear window wiper and washer operates when the ignition switch is in the "ON" position.

### Wiper operation

The switch position "INT" ① operates the wiper intermittently.

The switch position "ON" ② operates the wiper at low speed.

If the rear window wiper operation is interrupted by snow or ice, the wiper may stop moving to protect its motor. If this occurs, turn the wiper switch to the "OFF" position and remove the snow or ice on and around the wiper arms. In approximately 1 minute,

turn the switch on again to operate the wiper.

### Washer operation

To operate the washer, push the lever toward the front of the vehicle ③ until the desired amount of washer fluid is spread on the windshield. The wiper will automatically operate several times.

## DEFOGGER SWITCH

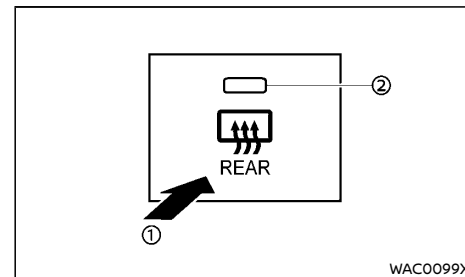

Example

The rear window defogger switch operates when the ignition switch is in the "ON" position.

The defogger is used to reduce the moisture, fog or frost on the rear window surfaces to improve the rear view.

When the defogger switch ① is pushed, the indicator light ② illuminates and the defogger operates for approximately 15 minutes. After the preset time has passed, the defogger will turn off automatically.

To turn off manually, push the defogger switch again.



### CAUTION:

- When operating the defogger continuously, be sure to start the engine. Otherwise, it may cause the battery to discharge.
- When cleaning the inner side of the window, be careful not to scratch or damage the electrical conductors on the surface of the window.

## HORN

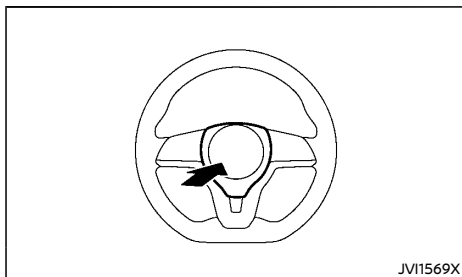

The horn switch operates regardless of the ignition switch position except when the battery is discharged.

When the horn switch is pushed and held, the horn will sound. Releasing the horn switch will cease the horn sound.

## WINDOWS

### POWER WINDOWS



#### WARNING:

- **Make sure that all passengers have their hands, etc. inside the vehicle before operating the power windows.**
- **To help avoid risk of injury or death through unintended operation of the vehicle and or its systems, including entrapment in windows or inadvertent door lock activation, do not leave children, people who require the assistance of others or pets unattended in your vehicle. Additionally, the temperature inside a closed vehicle on a warm day can quickly become high enough to cause a significant risk of injury or death to people and pets.**

The power windows operate when the ignition switch is in the "ON" position.

To open a window, push down the power window switch.

To close a window, pull up the power window switch.

### Driver's window switch

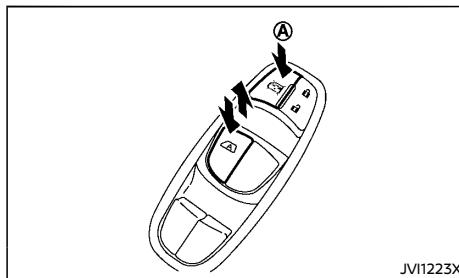

The driver's switch, the main switch, can control all windows.

### Locking passenger's windows:

When the lock button (A) is pushed in, the passenger's windows cannot be operated.

To cancel the passenger's windows lock, push the lock button (A) again.

### Passenger's window switch

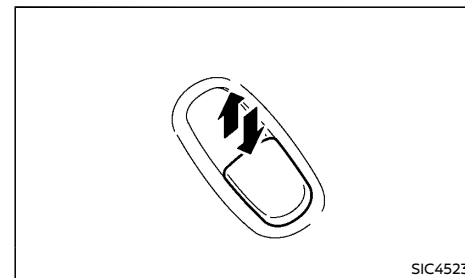

The passenger's switch can control its corresponding window.

When the passenger's windows lock button on the driver's switch is pushed in, the passenger's switch cannot be operated.

## Automatic function

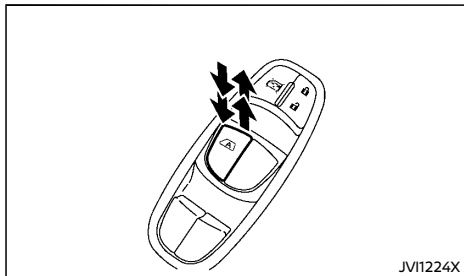

The automatic function is available for the switch that has an **A** mark on its surface.

The automatic function enables a window to fully open or close without holding the switch down or up.

To fully open the window, push the power window switch down to the second detent and release the switch. To fully close the window, pull the power window switch up to the second detent and release the switch. The switch does not have to be held during window operation.

To stop the window open/close operation during the automatic function, push down or pull up the switch in opposite directions.

### Auto-reverse function:



#### WARNING:

**There is a small distance just before the closed position which cannot be detected. Make sure that all passengers have their hands, etc. inside the vehicle before closing the windows.**

The auto-reverse function enables a window to automatically reverse when something is

caught in the window as it is closing by the automatic function. When the control unit detects an obstacle, the window will be lowered immediately.

Depending on the environment or driving conditions, the auto-reverse function may activate if an impact or load similar to something being caught in the window occurs.

### If the window does not close automatically

If the power window automatic function (closing only) does not operate properly, perform the following procedure to initialize the power window system.

1. Start the engine.
2. Close the door.
3. Open the window completely by operating the power window switch.
4. Pull the power window switch and hold it to close the window, and then hold the switch more than 3 seconds after the window is closed completely.
5. Release the power window switch. Operate the window by the automatic function to confirm the initialization is complete.

If the power window automatic function does not operate properly after performing the procedure above, have your vehicle checked by a NISSAN dealer.

## POWER OUTLETS

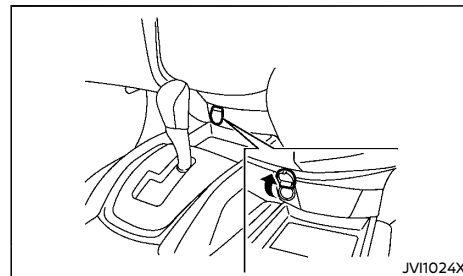

Instrument panel (lower)

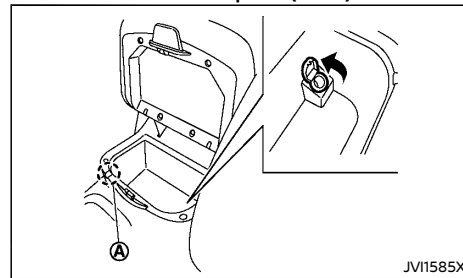

Console box (Type A)

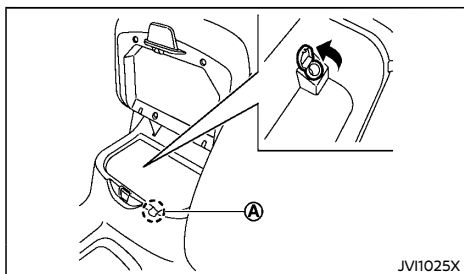

Console box (Type B)

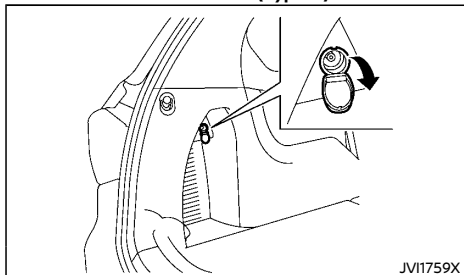

Cargo area

The power outlet is used for powering electrical accessories.

Use the cutout **A** between the lid and the console box to use a powering cable with the console box lid closed.



**CAUTION:**

- Do not leave a power cable on the instrument panel in direct sunlight. The surface of the instrument panel may become very hot resulting in damage to the power cable.

- Do not put a liquid container near the power outlet. Spilled contents may get into the power outlet and can result in a malfunction.
- The outlet and plug may be hot during or immediately after use.
- This power outlet is not designed for use with a cigarette lighter unit.
- Do not use accessories that exceed a combined power draw of 12 volt, 120W (10A). Do not use double adapters or more than one electrical accessory.
- Use this power outlet with the engine running to avoid discharging the vehicle battery.
- Avoid using when the air conditioner, headlights or rear window defogger is on.
- Push the plug in as far as it will go. If good contact is not made, the plug may overheat or the internal temperature fuse may blow.
- Before inserting or disconnecting a plug, be sure that the electrical accessory being used is turned OFF.
- When not in use, be sure to close the cap. Do not allow water or any liquid to contact the outlet.

**USB (Universal Serial Bus) CHARGING CONNECTOR (if equipped)**

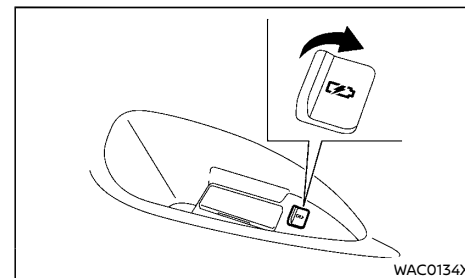

Third row seat soft bottle holder (left side)

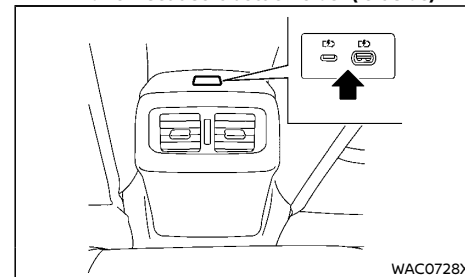

Behind the console box

The USB charging connector can be used only for charging an external device.

Pull the cover as illustrated (if equipped) and then connect a USB device into the connector. Charging will start automatically (maximum output up to 5 volt, 12 W, 2.4 A (USB Type-A), 5 volt, 15 W, 3 A (USB Type-C)).

The external device will be charged continuously while the ignition switch is in the "ACC" or "ON" position.

Some mobile devices cannot be charged de-

pending on their specifications.

**CAUTION:**

- Do not force a USB device into the connector. Inserting the USB device tilted or up-side-down (USB Type-A) into the connector may damage the connector. Make sure that the USB device is connected correctly into the connector.
- Do not use a reversible USB cable. Using the reversible USB cable may damage the connector.

### WIRELESS CHARGER (if equipped)

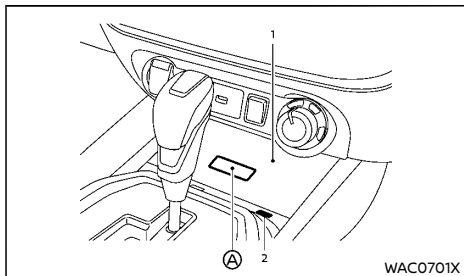

1. Charging pad
2. Indicator

The wireless charger is located on the front of the center console. Lay the smartphone on the pad of the wireless charger. Charging will start automatically. The smartphone will be charged continuously while the ignition switch is in the ON position.

**WARNING:**

- Never put metallic materials between the wireless charger and a smartphone.
- Those who use a pacemaker or other medical equipment should contact the electric medical equipment manufacturer for the possible influences before use.
- Never put cloth over the smartphone during charging process.
- Never charge a smartphone when it is wet.
- Never put metallic materials or small goods such as a cigarette lighter, Intelligent Key or memory drive.

**CAUTION:**

- Do not put an RFID/NFC/credit card between the wireless charger and a smartphone. This could cause data corruption in the card.
- Do not use the wireless charger with dust accumulated or dirt on the pad.
- Do not hit the surface of the wireless charger.
- Do not spill liquid (water, drinks, etc.) on the charging pad.
- Do not use grease, oil or alcohol for cleaning charging pad.

### Wireless charger Indicator

The indicator (Q) will illuminate in orange when the charging process is started.

When the charging has completed, the indicator illuminates in green.

If a malfunction occurs or the charging process has stopped, the indicator will blink in orange for 8 seconds then turn off.

### Operation of the wireless charger

To use the wireless charger, it is necessary to seat the smartphone well within the charging pad. To maximize charging performance, ensure the smartphone is fully seated on the center of the charging pad over the "Qi" logo (A). Because the location of the power receiver may vary depending on the smartphone, you will need to try and find the area that suits your smartphone.

Because some smartphone cases or accessories may adversely affect charging, remove them before wireless charging.

Turn off the vibration function of the smartphone before wireless charging.

**NOTE:**

- Only a Qi compatible smartphone can be used.
- The smartphone may be warmed during charging process and the charging may stop by the protection function of the wireless charger. This is not a malfunction. If this occurs, restart charging after the smartphone cooled down. The indicator will blink in orange then turn off.
- The wireless charging process may be stopped by the status of the smartphone (battery temperature, etc.).



## STORAGE

- If a radio noise interference occurs during charging process, put the smartphone onto the center ("Qi" logo) position of the wireless charger.
- The wireless charging process will stop during process of searching the Intelligent Key.
- The wireless charging process will not be started when a USB (Universal Serial Bus) cable is connected to the smartphone. The indicator may illuminate in orange or blink if the smartphone is put on the wireless charger with a USB cable connected. However, charging is not performed.
- Depending on the model and software of the smartphone, the indicator may remain illuminated in orange and may not turn green even when the charging process has been completed.



### WARNING:

- The storages should not be used while driving so that the full attention may be given to vehicle operation.
- Keep the storage lids closed while driving to help prevent injury in an accident or a sudden stop.

## GLOVE BOX

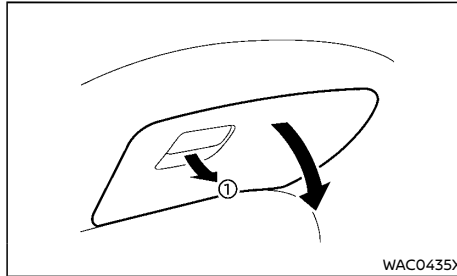

To open the glove box, pull the handle ①.

To close, push the lid in until the lock latches.

## CONSOLE BOX

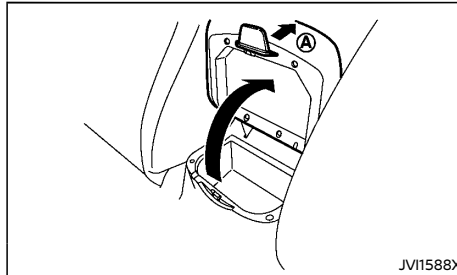

To open the console box lid, push up the knob ① and pull up the lid.

To close, push the lid down until the lock latches.

## SUNGLASSES HOLDER

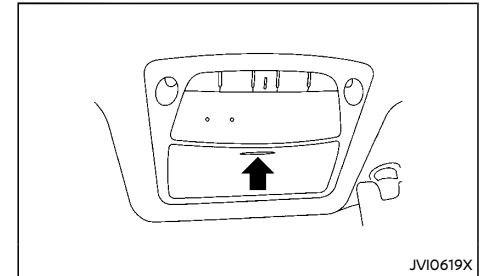

To open the sunglasses holder, push and release. Only store one pair of sunglasses in the holder.



### WARNING:

Keep the sunglasses holder closed while driving to avoid obstructing the driver's view and to help prevent an accident.



### CAUTION:

- Do not use for anything other than sunglasses.
- Do not leave sunglasses in the sunglasses holder while parking in direct sunlight. The heat may damage the sunglasses.

## CUP HOLDERS

### **WARNING:**

The driver must not remove or insert cups into the cup holder while driving so that full attention may be given to vehicle operation.

### **CAUTION:**

- Avoid abrupt starting and braking especially when the cup holder is being used to prevent spilling the contents. If the contents are hot, they could scald you or your passengers.
- Use only soft cups in the cup holder. Hard objects can injure you in an accident.

## Center console

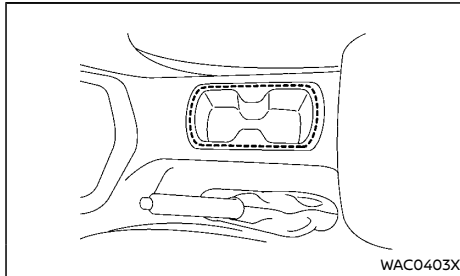

Type A

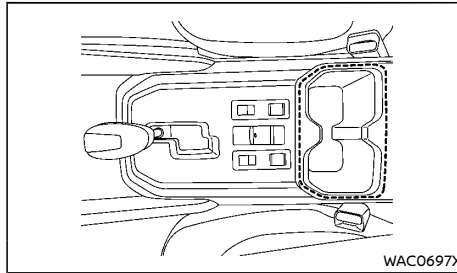

Type B

## Second row seats

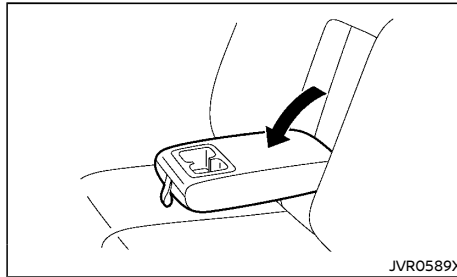

## Soft bottle holders

### **CAUTION:**

- Do not use bottle holder for any other objects that could be thrown about in the vehicle and possibly injure people during sudden braking or an accident.
- Do not use bottle holder for open liquid containers.

## Front seat and second row seat:

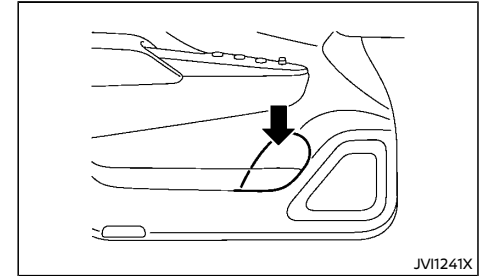

The front and second row seat soft bottle holders are located on the doors.

## Third row seat:

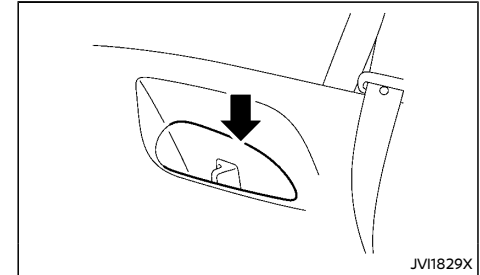

The soft bottle holders are located on the left and right side of the third row seats.

## ROOF RACK

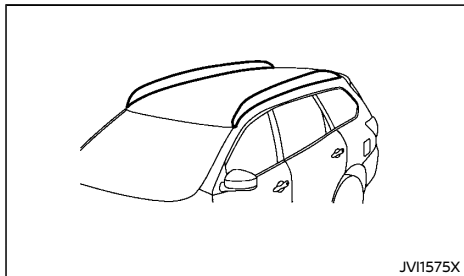

Do not apply any load directly to the roof side rails. Cross bars must be installed before applying load/cargo/luggage to the roof of the vehicle. Genuine NISSAN accessory cross bars are available through a NISSAN dealer. Contact a NISSAN dealer for additional information.

The service load capacity for the roof side rails is not more than 55 kg (121 lb), however do not exceed the accessory cross bars load capacity.

### **WARNING:**

- Always install the cross bars onto the roof side rails before loading cargo of any kind. Loading cargo directly onto the roof side rails or the vehicle's roof may cause vehicle damage.
- Drive extra carefully when the vehicle is loaded at or near the cargo carrying capacity, especially if the significant portion of that load is carried on the roof rack.
- Heavy loading of the roof rack has the potential to affect the vehicle stability and handling during sudden or unusual

handling maneuvers.

- Roof rack load should be evenly distributed.
- Do not exceed maximum roof rack load weight capacity.
- Properly secure all cargo with ropes or straps to help prevent it from sliding or shifting. In a sudden stop or collision, unsecured cargo could cause personal injury.

## LUGGAGE HOOKS

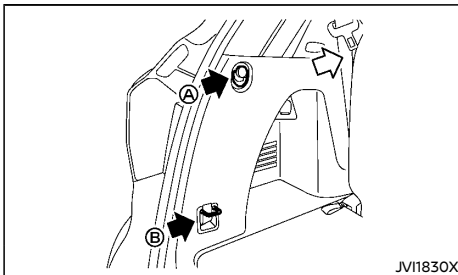

The hooks are located in the luggage area.

### **CAUTION:**

- Always make sure that the luggage is properly secured. Use the suitable ropes and hooks.
- Unsecured luggage can become dangerous in an accident or sudden stop.
- Do not apply a total load of more than 3 kg (7 lb) **A** or 10 kg (22 lb) **B** to a single hook.

## LUGGAGE FLOOR BOX (if equipped)

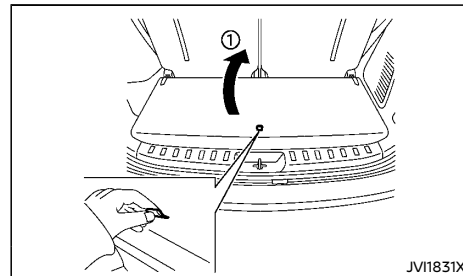

To access the luggage floor box, pull off the board **1** (if equipped).

## CARD HOLDER (if equipped)

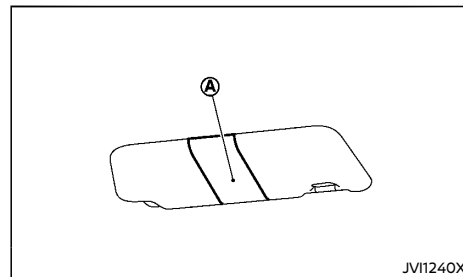

Slide a card in the card holder **A**.

## SUN VISORS

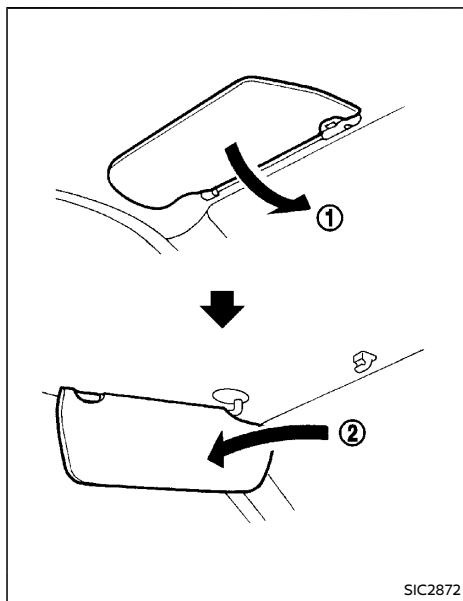

1. To block out glare from the front, swing down the sun visor ①.
2. To block glare from the side, remove the sun visor from the center mount and swing it to the side ②.

## INTERIOR LIGHTS



### CAUTION:

- Turn off the lights when you leave the vehicle.
- Do not use the lights for extended periods of time with the engine stopped. This could result in a discharged battery.

### INTERIOR LIGHT SWITCH

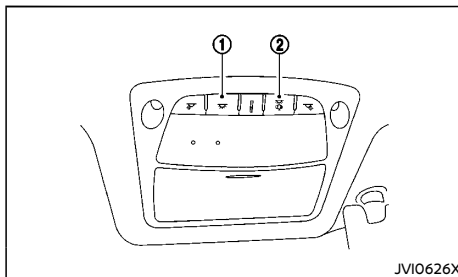

#### ① ON switch

When the ON switch ① is pushed on, the map lights and rear personal lights will illuminate.

#### ② DOOR OFF switch

When the switch ② is not pushed on, the map lights and rear personal lights will illuminate for a period of time under the following conditions:

- when the ignition switch is placed in the "OFF" position. (model with Intelligent Key system)
- when the key is removed from the ignition switch with the driver's door closed. (model without Intelligent Key system)
- when doors are unlocked by pushing the "UNLOCK"  button on the Intelligent Key or door handle request switch with the

ignition switch in the "LOCK" position. (model with Intelligent Key system)

- when doors are unlocked by pushing the "UNLOCK"  button on the remote controller with the ignition switch in the "LOCK" position. (model without Intelligent Key system)
- when any door is opened and then closed with the ignition switch in the "OFF" position. (model with Intelligent Key system)
- when any door is opened with the ignition switch in the "ACC" or "ON" position.
  - The lights will remain on while the door is opened. When the door is closed, the lights will turn off.

When the switch ② is pushed in, the map lights and rear personal lights will not illuminate under the above condition.

### CONSOLE LIGHT

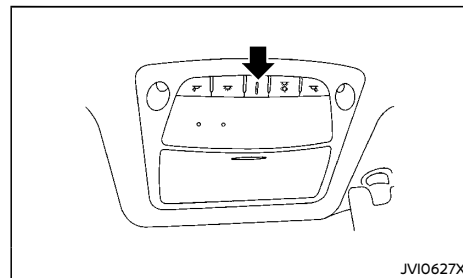

The console light will turn on whenever the clearance lights or headlights are illuminated.

## MAP LIGHTS

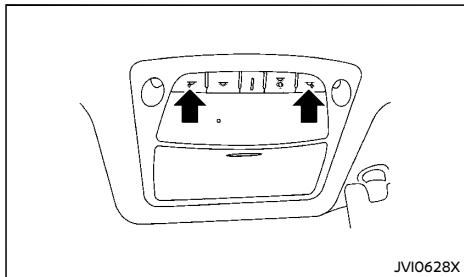

Push the button as illustrated to turn the light on or off.

## REAR PERSONAL LIGHT

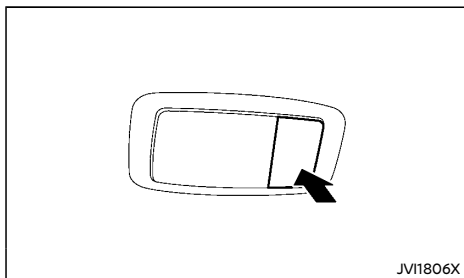

Push the button as illustrated to turn the light on or off.

## VANITY MIRROR LIGHTS (if equipped)

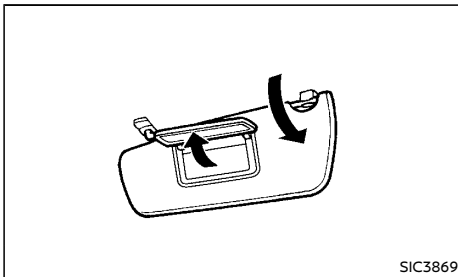

To access the vanity mirror, pull the sun visor down and flip open the mirror cover.

The vanity mirror light illuminates when the vanity mirror cover is opened. When the cover is closed, the light will turn off.

## CARGO LIGHT

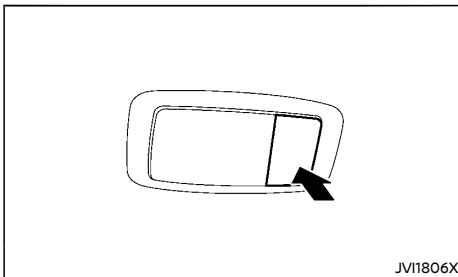

Push the button as illustrated to turn the light on or off.

The cargo light illuminates when the back door is opened. When the back door is closed, the light will turn off.

## BATTERY SAVER SYSTEM

The lights will turn off after a period of time when the lights remain illuminated to prevent the battery from becoming discharged.

**MEMO**

# 3 Pre-driving checks and adjustments

Keys .....	3-2	Remote engine start (if equipped) .....	3-16
NISSAN Anti-Theft System (NATS) key (if equipped) .....	3-2	Remote engine start operating range .....	3-17
Intelligent Key (if equipped) .....	3-2	Remote starting the engine .....	3-17
Doors .....	3-4	Extending engine run time .....	3-17
Locking with key .....	3-4	Canceling a remote engine start .....	3-17
Locking with inside lock knob .....	3-4	Conditions the remote engine start will not work .....	3-17
Locking with power door lock switch .....	3-4	Hood .....	3-18
Vehicle speed sensing door lock mechanism .....	3-5	Opening hood .....	3-19
Auto door lock releasing mechanism .....	3-5	Closing hood .....	3-19
Impact sensing door lock releasing mechanism .....	3-5	Back door .....	3-19
Child safety rear door locks .....	3-5	Opening back door .....	3-20
Remote keyless entry system (if equipped) .....	3-6	Closing back door .....	3-20
Using remote keyless entry system .....	3-6	Back door release lever .....	3-20
Intelligent Key system (if equipped) .....	3-7	Fuel-filler lid .....	3-21
Intelligent Key operating range .....	3-8	Opening fuel-filler lid .....	3-21
Using Intelligent Key system .....	3-8	Fuel-filler cap .....	3-21
Battery saver system .....	3-10	Steering wheel .....	3-21
Warning and audible reminders .....	3-10	Steering wheel adjustment .....	3-21
Troubleshooting guide .....	3-11	Mirrors .....	3-22
Using remote keyless entry system .....	3-13	Inside rearview mirror .....	3-22
Hazard indicator and horn operation .....	3-14	Outside rearview mirrors .....	3-27
Security system .....	3-15	Vanity mirror (if equipped) .....	3-27
Theft warning system (if equipped) .....	3-15	Parking brake .....	3-28
NISSAN Anti-Theft System (NATS) (if equipped) .....	3-15	Lever type .....	3-28
		Switch type (models with electronic parking brake system) .....	3-28

## KEYS

A key number plate is supplied with your key. Record the key number on the key number plate/metal tag and keep it in a safe place (such as your wallet), NOT IN THE VEHICLE. NISSAN does not record key numbers so it is very important to keep track of your key number plate.

A key number is only necessary when you have lost all keys and do not have one to duplicate from. If you still have a key, this key can be duplicated by a NISSAN dealer.

### NISSAN ANTI-THEFT SYSTEM (NATS\*) KEY (if equipped)

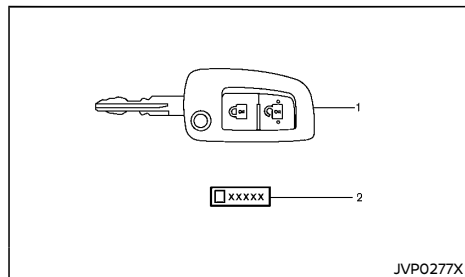

1. NATS key (2)
2. Key number plate (1)

Your vehicle can only be driven with the NATS keys, which are registered to your vehicle's NATS components. As many as 5 NATS keys can be registered and used with one vehicle. The new keys must be registered by a NISSAN dealer prior to use with the NATS of your vehicle. Since the registration process requires erasing all memory in the NATS components when registering new keys, be sure to take all NATS keys that you have to the NISSAN dealer.

\*: Immobilizer

### 3-2 Pre-driving checks and adjustments

### CAUTION:

**Do not allow the NATS key, which contains an electrical transponder, to come into contact with water or salt water. This could affect the system function.**

#### Mechanical key

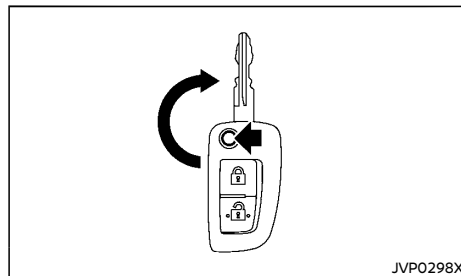

To unfold the key from the fob, press the release button.

When storing the key press the release button and push key to fold the key back into fob slot.

#### INTELLIGENT KEY (if equipped)

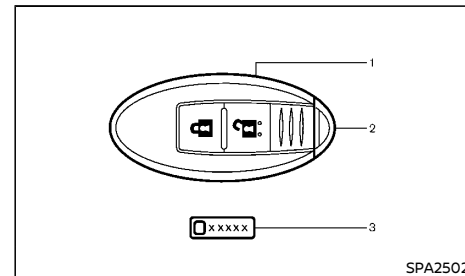

#### Type A

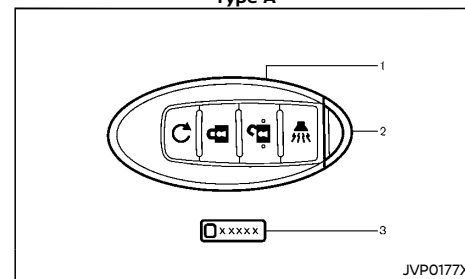

#### Type B

1. Intelligent Key (2)
2. Mechanical key (inside Intelligent Key) (2)
3. Key number plate (1)

### WARNING:

- The Intelligent Key transmits radio waves that can adversely affect medical electric equipment.
- If you have a pacemaker, you should contact the medical equipment manufacturer to ask if it will be affected by the



### Intelligent Key signal.

Your vehicle can only be driven with the Intelligent Keys, which are registered to your vehicle's Intelligent Key system components and NISSAN Anti-Theft System (NATS\*) components. As many as 4 Intelligent Keys can be registered and used with one vehicle. The new keys must be registered by a NISSAN dealer prior to use with the Intelligent Key system and NATS of your vehicle. Since the registration process requires erasing all memory in the Intelligent Key system components when registering new keys, be sure to take all Intelligent Keys that you have to a NISSAN dealer.

\*: Immobilizer



### CAUTION:

- Be sure to carry the Intelligent Key with you. Do not leave the vehicle with the Intelligent Key inside.
- Be sure to carry the Intelligent Key with you when driving. The Intelligent Key is a precision device with a built-in transmitter. To avoid damaging it, please note the following.
  - The Intelligent Key is water resistant; however, wetting may damage the Intelligent Key. If the Intelligent Key gets wet, immediately wipe until it is completely dry.
  - Do not bend, drop or strike it against another object.
  - If the outside temperature is below  $-10^{\circ}\text{C}$  ( $14^{\circ}\text{F}$ ), the battery of the Intelligent Key may not function properly.
  - Do not place the Intelligent Key for an extended period in a place where temperatures exceed  $60^{\circ}\text{C}$  ( $140^{\circ}\text{F}$ ).

- Do not change or modify the Intelligent Key.
- Do not use a magnet key holder.
- Do not place the Intelligent Key near equipment that produces a magnetic field such as a TV, audio equipment and personal computers.
- Do not allow the Intelligent Key to come into contact with water or salt water, and do not wash it in a washing machine. This could affect the system function.
- If an Intelligent Key is lost or stolen, NISSAN recommends erasing the ID code of that Intelligent Key. This will prevent the Intelligent Key from unauthorized use to unlock the vehicle. For information regarding the erasing procedure, please contact a NISSAN dealer.

Use the mechanical key to lock or unlock the doors. (See "Doors" (P.3-4).)

### Mechanical key

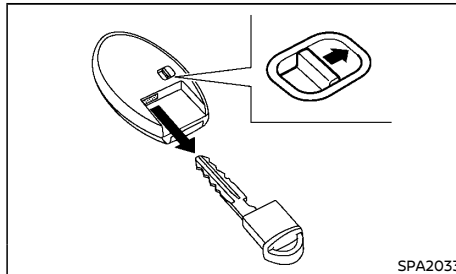

To remove the mechanical key, release the lock knob at the back of the Intelligent Key.

To install the mechanical key, firmly insert it into the Intelligent Key until the lock knob returns to the lock position.

## DOORS

### WARNING:

- Always look before opening any doors, to avoid an accident with oncoming traffic.
- To help avoid risk of injury or death through unintended operation of the vehicle and or its systems, including entrapment in windows or inadvertent door lock activation, do not leave children, people who require the assistance of others or pets unattended in your vehicle. Additionally, the temperature inside a closed vehicle on a warm day can quickly become high enough to cause a significant risk of injury or death to people and pets.

### LOCKING WITH KEY

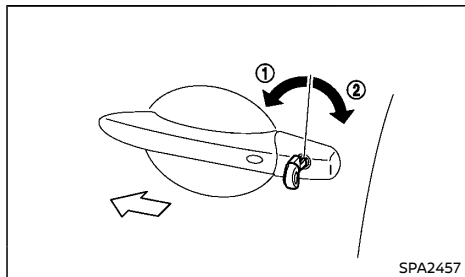

To lock the driver's door, insert the key to the door key cylinder and turn the key to the front side of the vehicle ①.

All doors including the back door will lock.

To unlock the door insert the key to the door key cylinder and turn the key to the rear side of the vehicle ②.

All doors including the back door will unlock.

## 3-4 Pre-driving checks and adjustments

### LOCKING WITH INSIDE LOCK KNOB

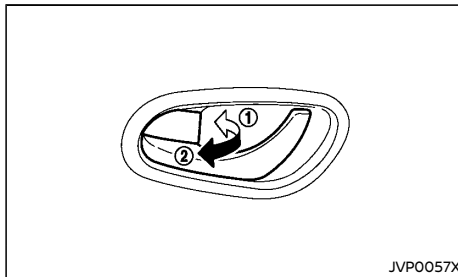

### CAUTION:

**When locking the doors using the inside lock knob, be sure not to leave the key in the vehicle.**

To lock the front doors, push the inside lock knob to the lock position ①, and then close the door while pulling the outside door handle.

To lock the rear doors, push the inside lock knob to the lock position ① and then close the door.

To unlock, pull the inside lock knob to the unlock position ②.

When the driver's door is locked, you do not need to operate the inside lock knob. Just pull the inside door handle to open the driver's door (if equipped).

### LOCKING WITH POWER DOOR LOCK SWITCH

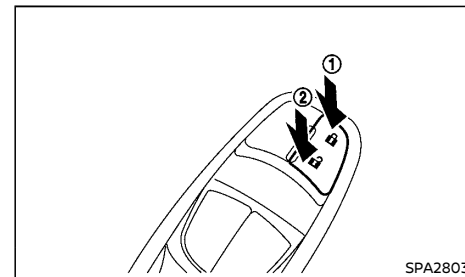

Operating the power door lock switch (located on the driver's door) will lock or unlock all the doors.

To lock the doors, push the power door lock switch to the lock position ① with the driver's door open, then close the door while pulling the outside door handle. All doors will lock.

### CAUTION:

- **When locking the doors using the power door lock switch, be sure not to leave the key in the vehicle.**
- **When the Intelligent Key (if equipped) is left in the vehicle, and you try to lock the door using the power door lock switch after getting out of the vehicle, all the doors will unlock automatically after the door is closed.**

To unlock, push the power door lock switch to the unlock position ②.

## VEHICLE SPEED SENSING DOOR LOCK MECHANISM

All doors will be locked automatically when the vehicle speed reaches 10 km/h (6 MPH). Once the lock has been unlocked, while driving, the vehicle speed sensing door lock mechanism will not lock the door again unless one of the following is performed.

- Opening any doors.
- Placing the ignition switch in the "LOCK" position.

### To activate or deactivate vehicle speed sensing door lock mechanism (if equipped)

To activate or deactivate the vehicle speed sensing door lock mechanism, perform the following procedures.

1. Place the ignition switch in the "ON" position.
2. Within 20 seconds, push and hold the power door lock switch to the "LOCK" position for 5 seconds.
3. The hazard indicator light will flash as follows if the switching operation is successful:
  - Twice - activated
  - Once - deactivated

## AUTO DOOR LOCK RELEASING MECHANISM

All doors will be unlocked automatically when the following conditions are met:

- When the ignition switch is pushed from "ON" to "OFF" position (Model with Intelligent Key system).
- When the key is removed from the ignition switch (Model without Intelligent Key system).

### To activate or deactivate auto door lock releasing mechanism (if equipped)

To activate or deactivate the auto door lock releasing mechanism, perform the following procedures.

1. Place the ignition switch in the "ON" position.
2. Within 20 seconds, push and hold the power door lock switch to the "UNLOCK" position for 5 seconds.
3. The hazard indicator light will flash as follows if the switching operation is successful:
  - Twice - activated
  - Once - deactivated

## IMPACT SENSING DOOR LOCK RELEASING MECHANISM

All doors will be unlocked automatically when the impact sensors sense an impact while the ignition switch is in the "ON" position.

## CHILD SAFETY REAR DOOR LOCKS

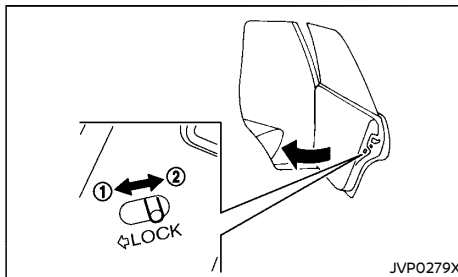

The child safety rear door locks help prevent rear doors from being opened accidentally, especially when small children are in the

vehicle.

When the levers are in the lock position ①, the child safety rear door locks engage and the rear doors can only be opened by the outside door handles.

To disengage, move the levers to the unlock position ②.

## REMOTE KEYLESS ENTRY SYSTEM (if equipped)

The remote keyless entry system can operate all door locks using the remote controller. The remote controller can operate at a distance of approximately 1 m (3.3 ft) away from the vehicle. The operating distance depends upon the conditions around the vehicle.

As many as 5 remote controllers can be used with one vehicle. For information about the purchase and use of additional remote controllers, contact a NISSAN dealer.

The remote controller will not function under the following conditions:

- When the distance between the remote controller and vehicle is more than approximately 1 m (3.3 ft).
- When the remote controller battery is discharged.
- When the key is in the ignition switch.

### CAUTION:

- **When locking the doors using the remote controller, be sure not to leave the key in the vehicle.**
- **Do not allow the remote controller, which contains electrical components, to come into contact with water or salt water. This could affect the system function.**
- **Do not drop the remote controller.**
- **Do not strike the remote controller sharply against another object.**
- **Do not place the remote controller for an extended period in an area where temperatures exceed 60°C (140°F).**



If a remote controller is lost or stolen, NISSAN recommends erasing the ID code of that remote controller from the vehicle. This may prevent the unauthorized use of the remote

controller to unlock the vehicle. For information regarding the erasing procedure, contact a NISSAN dealer.

For information regarding the replacement of a battery, see "Battery" (P.8-22).

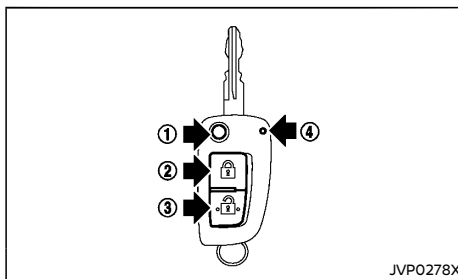
## USING REMOTE KEYLESS ENTRY SYSTEM



- ① Jackknife type key release button
- ② LOCK button 
- ③ UNLOCK button 
- ④ Battery indicator light

### Locking doors

1. Remove the ignition key.
2. Close all doors.
3. Push the "LOCK"  button ② on the remote controller.
4. All doors will be locked.
5. Operate door handles to confirm that the doors have been securely locked.

### CAUTION:

**After locking the doors using the remote controller, be sure that the doors have been securely locked by operating the door handles.**

### Unlocking doors

1. Push the "UNLOCK"  button ③ on the remote controller.
2. All doors will be unlocked.

All doors will be locked automatically unless one of the following operations is performed within 30 seconds after pushing the "UNLOCK"  button ③.

- Opening any doors.
- Inserting the key into the ignition switch.

### Battery indicator light

The battery indicator light ④ illuminates when you push any button. If the light does not illuminate, the battery is weak or needs replacement. For information regarding replacement of a battery, see "Battery" (P.8-22).

### Hazard indicator operation

When you lock or unlock the doors, the hazard indicator will flash as a confirmation.

- "LOCK": The hazard indicator flashes once.
- "UNLOCK": The hazard indicator flashes twice.

## INTELLIGENT KEY SYSTEM (if equipped)



### WARNING:

- **Radio waves could adversely affect electric medical equipment. Those who use a pacemaker should contact the electric medical equipment manufacturer for the possible influences before use.**
- **The Intelligent Key transmits radio waves when the buttons are pushed. The radio waves may affect aircraft navigation and communication systems. Do not operate the Intelligent Key while on an airplane. Make sure the buttons are not operated unintentionally when the unit is stored during a flight.**

The Intelligent Key system can operate all the doors and the back door using the remote controller function or pushing the request switch on the vehicle without taking the key out from a pocket or purse. The operating environment and/or conditions may affect the Intelligent Key system operation.

Be sure to read the following before using the Intelligent Key system.



### CAUTION:

- **Be sure to carry the Intelligent Key with you when operating the vehicle.**
- **Never leave the Intelligent Key in the vehicle when you leave the vehicle.**

The Intelligent Key is always communicating with the vehicle as it receives radio waves. The Intelligent Key system transmits weak radio waves. Environmental conditions may interfere with the operation of the Intelligent Key system under the following operating conditions.

- When operating near a location where strong radio waves are transmitted, such as a TV tower, power station and broadcasting station.
- When in possession of wireless equipment, such as a cellular telephone, transceiver, and CB radio.
- When the Intelligent Key is in contact with or covered by metallic materials.
- When any type of radio wave remote control is used nearby.
- When the Intelligent Key is placed near an electric appliance such as a personal computer.

In such cases, correct the operating conditions before using the Intelligent Key function or use the mechanical key.

Although the life of the battery varies depending on the operating conditions, the battery's life is approximately 2 years. If the battery is discharged, replace it with a new one.

For information regarding replacement of a battery, see "Intelligent Key battery" (P.8-25).

Since the Intelligent Key is continuously receiving radio waves, if the key is left near equipment which transmits strong radio waves, such as signals from a TV and personal computer, the battery life may become shorter.

Because the steering wheel is locked electrically, unlocking the steering wheel with the ignition switch in the "LOCK" position is impossible when the vehicle battery is completely discharged. Pay special attention that the vehicle battery is not completely discharged.

As many as 4 Intelligent Keys can be registered and used with one vehicle. For information about the purchase and use of additional Intelligent Keys, contact a NISSAN dealer.



### CAUTION:

- **Do not allow the Intelligent Key, which contains electrical components, to come into contact with water or salt water. This could affect the system function.**
- **Do not drop the Intelligent Key.**
- **Do not strike the Intelligent Key sharply against another object.**
- **Do not change or modify the Intelligent Key.**
- **Wetting may damage the Intelligent Key. If the Intelligent Key gets wet, immediately wipe until it is completely dry.**
- **If the outside temperature is below -10°C (14°F), the battery of the Intelligent Key may not function properly.**
- **Do not place the Intelligent Key for an extended period in an area where temperatures exceed 60°C (140°F).**
- **Do not attach the Intelligent Key with a key holder that contains a magnet.**
- **Do not place the Intelligent Key near equipment that produces a magnetic field, such as a TV, audio equipment, personal computers, cellular phone or wireless charger.**

If an Intelligent Key is lost or stolen, NISSAN recommends erasing the ID code of that Intelligent Key from the vehicle. This may prevent the unauthorized use of the Intelligent Key to operate the vehicle. For information regarding the erasing procedure, contact a NISSAN dealer.

The Intelligent Key function can be disabled. For information about disabling the Intelligent Key function, contact a NISSAN dealer.

## INTELLIGENT KEY OPERATING RANGE

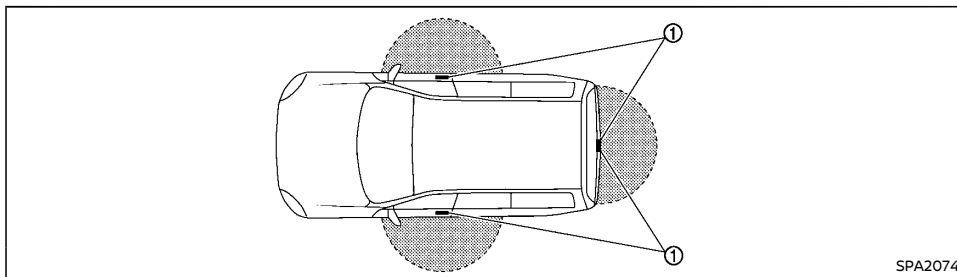

The Intelligent Key functions can only be used when the Intelligent Key is within the specified operating range from the request switch ①.

When the Intelligent Key battery is discharged or strong radio waves are present near the operating location, the Intelligent Key system's operating range becomes narrower, and the Intelligent Key may not function properly.

The operating range is within 80 cm (31.50 in) from each request switch ①.

If the Intelligent Key is too close to the door glass or door handle, the request switches may not function.

When the Intelligent Key is within the operating range, it is possible for anyone, even someone who does not carry the Intelligent Key, to push the request switch to lock/unlock the doors.

## USING INTELLIGENT KEY SYSTEM

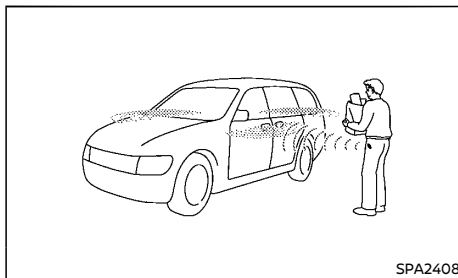

The request switch will not function under the following conditions:

- When another Intelligent Key is left inside the vehicle
- When the Intelligent Key is not within the operational range
- When any door is open or not closed securely
- When the Intelligent Key battery is discharged

- When the ignition switch is in the "ACC" or "ON" position

The Intelligent Key system (opening/closing doors with the door handle request switch) can be set to remain inactive. (See "Settings" (P.2-22).)

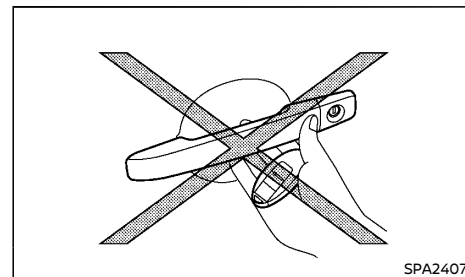

- Do not push the door handle request switch with the Intelligent Key held in your hand as illustrated. The close distance to the door handle will cause the Intelligent Key system to have difficulty recognizing that the Intelligent Key is outside the vehicle.
- After locking the doors using the door handle request switch, make sure that the doors have been securely locked by operating the door handles.
- When locking the doors using the door handle request switch, make sure to have the Intelligent Key in your possession before operating the door handle request switch to prevent the Intelligent Key from being left in the vehicle.
- The door handle request switch is operational only when the Intelligent Key has been detected by the Intelligent Key system.

- Do not pull the door handle before pushing the door handle request switch. The door will be unlocked but will not open. Release the door handle once and pull it again to open the door.

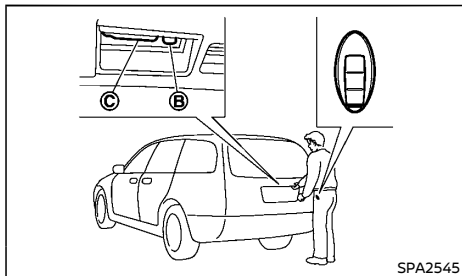
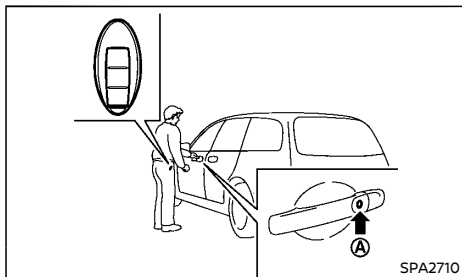

When you carry the Intelligent Key with you, you can lock or unlock all doors by pushing the door handle request switch (driver's or front passenger's) **A** or back door request switch **B** within the range of operation.

When you lock or unlock the doors or open the back door, the hazard indicator will flash and the outside chime will sound as a confirmation. For details, see "Hazard indicator and horn operation" (P.3-14).

### Welcome light and farewell light function

When you lock or unlock the doors, the clearance lights, tail lights and the license plate lights will illuminate for a period of time.

### Locking doors

- Push the ignition switch to the "OFF" position.
- Carry the Intelligent Key with you.
- Close all doors.
- Push the door handle request switch **A** (driver's or front passenger's door) or the back door request switch **B**.
- All doors will be locked.
- Operate door handles to confirm that the doors have been securely locked.

### Lockout protection:

To prevent the Intelligent Key from being accidentally locked in the vehicle, lockout protection is equipped with the Intelligent Key system.

- When the Intelligent Key is left in the vehicle while the driver's door is opened and you try to lock the door using the power door lock switch after getting out of the vehicle, all the doors will unlock automatically after the power door lock switch is operated.



### CAUTION:

**The lockout protection may not function under the following conditions:**

- When the Intelligent Key is placed on top of the instrument panel.
- When the Intelligent Key is placed inside of the glove box.

- When the Intelligent Key is placed inside of the door pockets.
- When the Intelligent Key is placed inside or near metallic materials.

**The lockout protection may function when the Intelligent Key is outside the vehicle but is too close to the vehicle.**

### Unlocking doors

- Carry the Intelligent Key with you.
- Push the door handle request switch **A** or the back door request switch **B**.
- All doors will be unlocked.

If a door handle is pulled while unlocking the doors, that door may not be unlocked. Returning the door handle to its original position will unlock the door. If the door does not unlock, after returning the door handle, push the door handle request switch to unlock the door.

### Automatic relock:

All doors will be locked automatically unless one of the following operations is performed within 30 seconds after pushing the request switch while the doors are locked.

- Opening any doors.
- Pushing the ignition switch.

If during the preset time period the "UNLOCK"  button on the Intelligent Key is pushed, all doors will be locked automatically after the next preset time.

## Opening back door

1. Carry the Intelligent Key with you.
2. Push the back door opener switch .
3. The back door will unlock and open. (All the other doors are unlocked.)

## BATTERY SAVER SYSTEM

When all the following conditions are met for a period of time, the battery saver system will cut off the power supply to prevent battery discharge.

- The ignition switch is in the "ACC" or "ON" position, and
- All doors are closed, and
- The shift lever is in the "P" (Park) position (Automatic Transmission model).

## WARNING AND AUDIBLE REMINDERS

The Intelligent Key system is equipped with a function that is designed to minimize improper operations of the Intelligent Key and to help prevent the vehicle from being stolen. A chime or beep sounds inside and outside the vehicle and a warning message appears in the vehicle information display.

See the troubleshooting guide on the next page and "Vehicle information display (models with color display)" (P.2-21).



### **CAUTION:**

**When the chime or beep sounds or the warning message appears, be sure to check both the vehicle and the Intelligent Key.**



## TROUBLESHOOTING GUIDE

Symptom		Possible cause	Action to take
When pushing the ignition switch to stop the engine	The Shift to Park warning appears in the vehicle information display and the inside warning chime sounds continuously or for a few seconds. (Automatic Transmission models)	The shift lever is not in the "P" (Park) position.	Shift the shift lever to the "P" (Park) position.
When shifting the shift lever to the P (Park) position	The inside warning chime sounds continuously. (Automatic Transmission models)	The ignition switch is in the "ACC" or "ON" position.	Push the ignition switch to the "OFF" position.
When opening the driver's door to get out of the vehicle	The inside warning chime sounds continuously.	The ignition switch is in the "ACC" position.	Push the ignition switch to the "OFF" position.
When closing the door after getting out of the vehicle	The No Key Detected warning appears on the display, the outside chime sounds 3 times and the inside warning chime sounds for a few seconds.	The ignition switch is in the "ACC" or "ON" position.	Push the ignition switch to the "OFF" position.
	The Shift to Park warning appears in the vehicle information display and the outside chime sounds continuously. (Automatic Transmission models)	The ignition switch is in the "ACC" or "OFF" position and the shift lever is not in the "P" (Park) position.	Move the shift lever to the "P" (Park) position and push the ignition switch to the "OFF" position.
When pushing the request switch or the "LOCK"  button on the Intelligent Key to lock the door	The outside chime sounds for a few seconds and all the doors unlock.	The Intelligent Key is inside the vehicle.	Carry the Intelligent Key with you.
When closing the door with the inside lock knob turned to "LOCK"	The outside chime sounds for a few seconds and all the doors unlock.	The Intelligent Key is inside the vehicle.	Carry the Intelligent Key with you.
When pushing the door handle request switch to lock the door	The outside chime sounds for a few seconds.	The Intelligent Key is inside the vehicle.	Carry the Intelligent Key with you.
		A door is not closed securely.	Close the door securely.
		The door handle request switch is pushed before the door is closed.	Push the door handle request switch after the door is closed.

Symptom		Possible cause	Action to take
When pushing the ignition switch to start the engine	The Key Battery low warning appears in the vehicle information display.	The battery charge is low.	Replace the battery with a new one. (See "Battery" (P.8-22).)
	The No Key Detected warning appears in the display and the inside warning chime sounds for a few seconds.	The Intelligent Key is not in the vehicle.	Carry the Intelligent Key with you.
When pushing the ignition switch	The Key System Fault warning appears in the vehicle information display.	It warns of a malfunction with the electrical steering lock system or the Intelligent Key system.	Contact a NISSAN dealer.

## USING REMOTE KEYLESS ENTRY SYSTEM

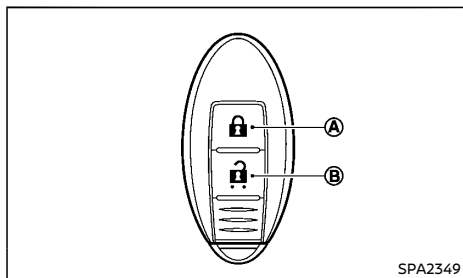

Type A

SPA2349

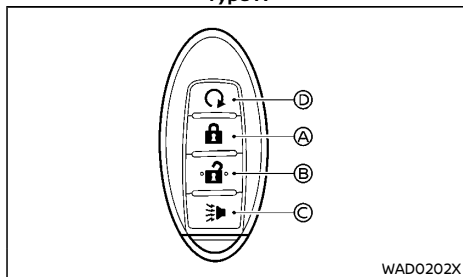

Type B

WAD0202X

- Ⓐ LOCK button
- Ⓑ UNLOCK button
- Ⓒ PANIC button (if equipped)
- Ⓓ Remote engine start button (if equipped)

## Operating range

The remote keyless entry system allows you to lock/unlock all doors including the back door. The operating distance depends upon the conditions around the vehicle. To securely operate the lock and unlock buttons, approach the vehicle to about 1 m (3.3 ft) from the door.

The remote keyless entry system will not function under the following conditions:

- When the Intelligent Key is not within the operational range.
- When the Intelligent Key battery is discharged.

For information regarding the replacement of a battery, see "Intelligent Key battery" (P.8-25).

## Locking doors

1. Place the ignition switch in the "OFF" position.
2. Carry the Intelligent Key with you.
3. Close all doors (including the back door).
4. Push the "LOCK"  button Ⓐ on the Intelligent Key.
5. All doors will be locked.
6. Operate the door handles to confirm that the doors have been securely locked.



### CAUTION:

- **After locking the doors using the Intelligent Key, be sure that the doors have been securely locked by operating the door handles.**
- **When locking the doors using the Intelligent Key, be sure not to leave the key in the vehicle.**

## Using panic alarm (if equipped)

If you are near your vehicle and feel threatened, you may activate the alarm to call attention as follows:

1. Push the "PANIC"  button Ⓒ on the Intelligent Key for **more than 1 second**.
2. The theft warning alarm and headlights (if equipped) will stay on for 25 seconds.
3. The panic alarm stops when:
  - It has run for 25 seconds, or
  - Any of the buttons on the Intelligent Key are pushed. (Note: Panic button should be pushed for more than 1 second.)



## Remote engine start (if equipped)

The remote engine start button Ⓓ is on the Intelligent Key if the vehicle has remote engine start function. This function allows the engine to start from outside the vehicle. See "Remote engine start" (P.3-16) for more details.

## Unlocking doors

1. Push the "UNLOCK"  button Ⓑ on the Intelligent Key.
2. All doors (including the back door) will be unlocked.

### Automatic relock:

All doors will be locked automatically unless one of the following operations is performed within 30 seconds after pushing the "UNLOCK"  button Ⓑ on the Intelligent Key while the doors are locked. If during this 30-second time period, the "UNLOCK"  button Ⓑ on the Intelligent Key is pushed, all doors will be locked automatically after another 30 seconds.



- Opening any door or back door.

- Pushing the ignition switch.

## HAZARD INDICATOR AND HORN OPERATION

When you lock or unlock the doors or the back door with the request switch or the remote keyless entry function, the hazard indicator will flash and the outside chime will sound as a confirmation.

The following descriptions show how the hazard indicator and outside chime will activate when locking or unlocking the doors.

Operation	DOOR LOCK	DOOR UNLOCK
<b>Intelligent Key system (using door handle or back door request switch)</b>	HAZARD - <b>once</b> OUTSIDE CHIME - <b>once</b>	HAZARD - <b>twice</b> OUTSIDE CHIME - <b>twice</b>
<b>Remote keyless entry system (using  or  button)</b>	HAZARD - <b>once</b> OUTSIDE CHIME - <b>once</b>	HAZARD - <b>twice</b> OUTSIDE CHIME - <b>twice</b>

## SECURITY SYSTEM

Your vehicle has either or both of the following security systems:

- Theft warning system (if equipped)
- NISSAN Anti-Theft System (NATS\*) (if equipped)

\*: Immobilizer

The security condition will be shown by the security indicator light.

### THEFT WARNING SYSTEM (if equipped)

The theft warning system provides visual and audio alarm signals if parts of the vehicle are disturbed.

### Security indicator light

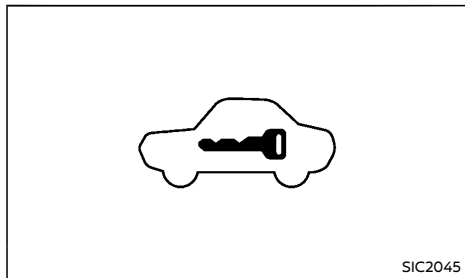

The security indicator light, located on the meter panel, operates whenever the ignition switch is in the "LOCK", "OFF" or "ACC" position. This is normal.

### How to activate system

1. Close all windows.  
**The system can be armed even if the windows are open.**
2. Place the ignition switch in the "OFF" position.
3. Carry the remote controller or the Intelligent Key with you and get out of the vehicle.
4. Close and lock all doors and back door. The doors can be locked with the remote controller, the Intelligent Key or door handle request switch (if equipped).
5. Confirm that the security indicator light comes on. The security indicator light blinks rapidly for approximately 20 seconds and then blinks slowly. The system is now activated. If, during this 20 second time period, the door is unlocked or the ignition switch is placed in the "ACC" or "ON" position, the system will not activate.

**Even when the driver and/or passengers are in the vehicle, the system will activate with all doors locked and the ignition switch in the "LOCK" position. When placing the ignition switch in the "ACC" or "ON" position, the system will be released.**

### Theft warning system operation

The vehicle security system will give the following alarm:

- The hazard indicator blinks and the horn sounds intermittently.
- The alarm automatically turns off after approximately 30 seconds. However, the alarm reactivates if the vehicle is tampered with again.

The alarm is activated by:

- Opening the door or the back door without using the remote controller, the Intelligent Key, the door handle request switch (if equipped) or the mechanical key. (Even if the door is opened by releasing the door inside lock knob, the alarm will activate.)
- Opening the hood.
- When the vehicle receives vibration or knocks. (model with shock sensor system)



### CAUTION:

**If your vehicle is installed with additional accessories such as audio dampening plate on the vehicle body, then the installed shock sensor system (if equipped) will be reduced in sensitivity.**

### How to stop alarm

- The alarm will stop by unlocking a door by pushing the "UNLOCK" button on the remote controller or the Intelligent Key.
- The alarm will stop if the ignition switch is placed in the "ACC" or "ON" position.

### NISSAN ANTI-THEFT SYSTEM (NATS) (if equipped)

The NISSAN Anti-Theft System (NATS) will not allow the engine to start without the use of the registered NATS key.

If the engine does not start using the registered NATS key, it may be due to interference caused by:

- Another NATS key.
- Automated toll road device.
- Automated payment device.
- Other devices that transmit similar signals.

Start the engine using the following procedure:

1. Remove any items that may be causing the interference away from the NATS key.
2. Leave the ignition switch in the "ON" position for approximately 5 seconds.
3. Place the ignition switch in the "OFF" or "LOCK" position, and wait approximately 10 seconds.
4. Repeat steps 2 and 3 again.
5. Start the engine.
6. Repeat the steps above until all possible interferences are eliminated.

If this procedure allows the engine to start, NISSAN recommends placing the registered NATS key separate from other devices to avoid interference.

### Security indicator light

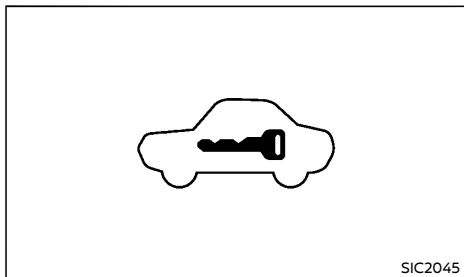

The security indicator light is located in the meter panel. It indicates the status of NATS.

The light operates whenever the ignition switch is in the "LOCK", "ACC" or "OFF" position. The security indicator light indicates that the security systems on the vehicle are operational.

If NATS is malfunctioning, this light will remain on while the ignition switch is in the "ON" position.

position.

**If the light remains on and/or the engine does not start, contact a NISSAN dealer for NATS service as soon as possible. Be sure to bring all NATS keys that you have when visiting a NISSAN dealer for service.**

## REMOTE ENGINE START (if equipped)

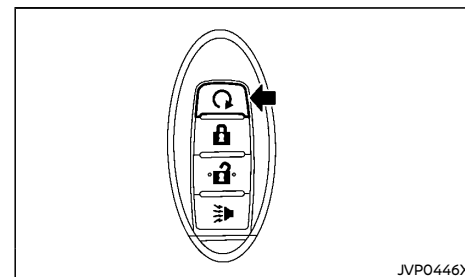

The remote engine start  button is on the Intelligent Key if the vehicle has remote engine start function. This function allows the engine to start from outside the vehicle.

Some systems, such as the air conditioner system, will turn on during a remote engine start, if the system was on the last time the ignition switch was turned off.

Laws in some local communities may restrict the use of remote engine starters. For example, some laws require a person using remote engine start to have the vehicle in view. Check local regulations for any requirements.

Other conditions may affect the remote engine start function. See "Conditions the remote engine start will not work" (P.3-17).

Other conditions can affect the performance of the Intelligent Key transmitter. See "Intelligent Key system" (P.3-7) for additional information.

## REMOTE ENGINE START OPERATING RANGE



### WARNING:

To help avoid risk of injury or death through unintended operation of the vehicle and/or its systems, do not leave children, people who require the assistance of others or pets unattended in your vehicle. Additionally, the temperature inside a closed vehicle on a warm day can quickly become high enough to cause a significant risk of injury or death to people and pets.



The remote engine start function can only be used when the Intelligent Key is within the specified operating range from the vehicle.

When the Intelligent Key battery is discharged or other strong radio wave sources are present near the operating location, the Intelligent Key operating range becomes narrower, and the Intelligent Key may not function properly.

The remote engine start operating range is approximately 60 m (197 ft) from the vehicle.

## REMOTE STARTING THE ENGINE

To use the remote engine start function to start the engine, perform the following:

1. Aim the Intelligent Key at the vehicle.
2. Push the "LOCK"  button to lock all doors.
3. Within 5 seconds push and hold the remote engine start  button until the turn signal lights flash and the tail lights illuminate. If the vehicle is not within view, push and hold the remote engine start  button for at least 2 seconds.

The following events will occur when the

engine starts:

- The front clearance lights will turn on and remain on as long as the engine is running.
- The doors will be locked and the air conditioner system may turn on.
- The engine will continue to run for about 10 minutes. Repeat the steps to extend the time for an additional 10 minutes. See "Extending engine run time" (P.3-17).

Depress and hold the brake pedal, then place the ignition switch in the "ON" position before driving. For further instructions, see "Driving vehicle" (P.5-15).

## EXTENDING ENGINE RUN TIME

The remote engine start function can be extended one time by performing the steps listed in "Remote starting the engine" (P.3-17). Run time will be calculated as follows:

- The first 10 minute run time will start when the remote engine start function is performed.
- The second 10 minutes will start immediately when the remote engine start function is performed. For example, if the engine has been running for 5 minutes, and 10 minutes are added, the engine will run for a total of 15 minutes.
- Extending engine run time will count towards the two remote engine start limit.

A maximum of two remote engine starts, or a single start with an extension, are allowed between ignition cycles.

The ignition switch must be cycled to the "ON" position and then back to the "OFF" position before the remote engine start procedure can be used again.

## CANCELING A REMOTE ENGINE START

To cancel a remote engine start, perform one of the following:

- Aim the Intelligent Key at the vehicle and push and hold the remote engine start  button until the front clearance lights turn off.
- Turn on the hazard indicator flashers.
- Cycle the ignition switch "ON" and then "OFF".
- The extended engine run time has expired.
- The first 10 minute timer has expired.
- The engine hood has been opened.
- The vehicle is shifted out of "P" (Park).
- The theft alarm sounds due to illegal entry into the vehicle.
- The ignition switch is pushed without an Intelligent Key in the vehicle.
- The ignition switch is pushed with an Intelligent Key in the vehicle but the brake pedal is not depressed.

## CONDITIONS THE REMOTE ENGINE START WILL NOT WORK

The remote engine start will not operate if any of the following conditions are present:

- The ignition switch is placed in the "ON" position.
- The hood is not securely closed.
- The hazard indicator flashers are on.
- The engine is still running. The engine must be completely stopped. Wait at least 6 seconds if the engine goes from running to off. This is not applicable when extending engine run time.
- The remote engine start  button is not pushed and held for at least 2 seconds.

## HOOD

- The remote engine start  button is not pushed and held within 5 seconds of pushing the "LOCK" button.
- The brake pedal is depressed.
- The doors are not closed and locked.
- The back door is open.
- The Intelligent Key warning message is displayed in the vehicle information display.
- An Intelligent Key is left inside the vehicle.
- The theft alarm sounds due to illegal entry into the vehicle.
- Two remote engine starts, or a single remote engine start with an extension, have already been used.
- The vehicle is not in the "P" (Park) position.

The remote engine start may display a warning or indicator in the vehicle information display. For an explanation of the warning or indicator, see "Vehicle information display warnings and indicators" (P.2-27).



### WARNING:

- **The hood must be closed and latched securely before driving. Failure to do so could cause the hood to fly open and result in an accident.**
- **Never open the hood if steam or smoke is coming from the engine compartment to avoid injury.**



## OPENING HOOD

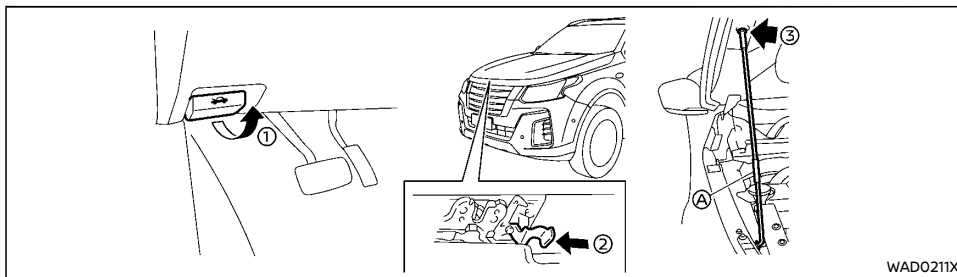

1. Pull the hood lock release handle ① located below the instrument panel until the hood springs up.
2. Locate the lever ② in between the hood and grille and push the lever with your fingertips.
3. Raise the hood.
4. Remove the support rod and insert it into the slot ③.

**Hold the coated parts ④ when removing or resetting the support rod. Avoid direct contact with the metal parts, as they may be hot immediately after the engine has been stopped.**

## CLOSING HOOD

1. While supporting the hood, return the support rod to its original position.
2. Slowly lower the hood to about 20 to 30 cm (8 to 12 in) above the hood lock, then let it drop.
3. Make sure it is securely latched.

## BACK DOOR

### WARNING:

- Make sure the back door has been closed securely to prevent it from opening while driving.
- Do not drive with the back door open. This could allow dangerous exhaust gases to be drawn into the vehicle.

### CAUTION:

- Before opening the back door, be sure to clear away snow, ice or dust that may be stuck to the back door. If the back door is opened while materials are still stuck to it, it may suddenly close again due to the weight of these materials.
- Always be sure to fully open the back door. If it is not fully opened, it may suddenly shut.
- Be especially careful when opening the back door in strong wind. The door could be caught by a gust of wind and may close suddenly.

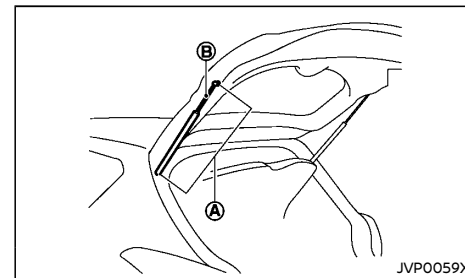

**⚠ CAUTION:**

- The back door gas stays **A** are installed in order to support the weight of the back door. In order to prevent the gas stays being damaged or not operating properly, be sure to observe the following points.
  - Do not insert hands or cords into the gas stays **A** or apply any force to them laterally.
  - Do not attach any adhesive foreign materials such as pieces of plastic or stickers to the rod **B** portion.
- Do not close the back door while holding the gas stays or hang anything on them. Doing so may lead to hands or arms becoming trapped in the back door and could result in an injury.

**OPENING BACK DOOR**

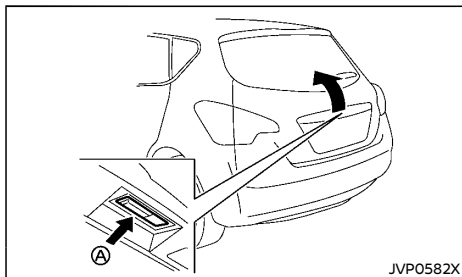

To open the back door, unlock it and push the back door opener switch **A**. Pull up the back door to open.

The back door can be unlocked by:

- Push the back door request switch (if equipped). (See "Intelligent Key system" (P.3-7).)
- Push the "UNLOCK" button on the Intelligent Key (if equipped). (See "Intelligent Key system" (P.3-7).)
- Push the "UNLOCK" button on the remote controller (if equipped). (See "Remote keyless entry system" (P.3-6).)
- Push the power door lock switch to the "UNLOCK" position.

**CLOSING BACK DOOR**

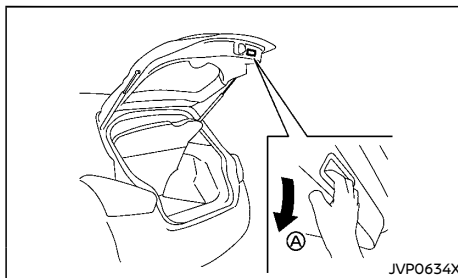

**⚠ WARNING:**

- Do not shut the back door with one hand and the other hand remaining on the back door or vehicle body. Doing so may lead to your hand becoming trapped and could result in an injury.
- When closing the back door, do not place your hands near the edge of the back door. Always be sure to close the back door from the outside.
- After closing the back door, be sure to check that it has been closed securely. If

**the back door opens while the vehicle is being driven, this could result in a serious accident.**

To close the back door, hold the grip **A** to pull down the back door and then push it down securely.

**BACK DOOR RELEASE LEVER**

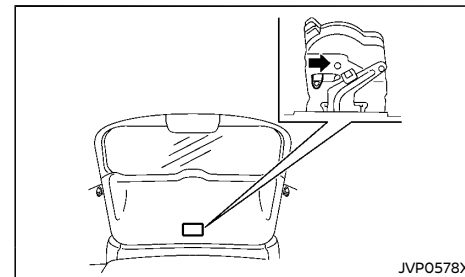

If the back door cannot be unlocked due to a discharged battery, follow these steps.

1. Fold the third row seats down. (See "Third row seats" (P.1-6).)
2. Remove the cap from the back door trim using a suitable tool.
3. Move the release lever to the right as illustrated to open the back door.

Contact a NISSAN dealer as soon as possible for repair.

## FUEL-FILLER LID

### **WARNING:**

- Fuel is extremely flammable and highly explosive under certain conditions. You could be burned or seriously injured if it is misused or mishandled. Always stop the engine and do not smoke or allow open flames or sparks near the vehicle when refueling.
- Fuel may be under pressure. Turn the cap a half of a turn, and wait for any “hissing” sound to stop to prevent fuel from spraying out and possibly causing personal injury. Then remove the cap.
- Use only an original equipment type fuel-filler cap as a replacement. It has a built-in safety valve needed for proper operation of the fuel system and emission control system. An incorrect cap can result in a serious malfunction and possible injury.

## OPENING FUEL-FILLER LID

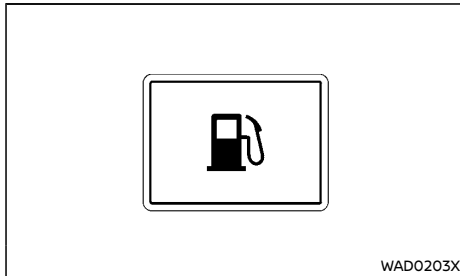

To open the fuel-filler lid, push the fuel-filler lid opener switch located on the lower side of the instrument panel.

To lock the fuel-filler lid, close the lid until it securely locks.

## FUEL-FILLER CAP

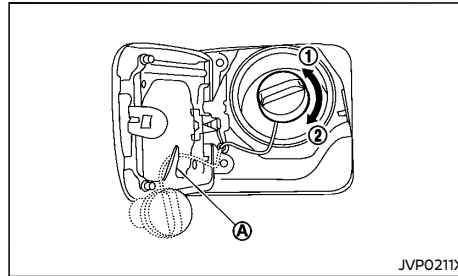

The fuel-filler cap is a ratcheting type. Turn the cap counterclockwise ① to remove. Tighten the cap clockwise ② until ratchet clicks, more than twice, after refueling.

Put the fuel-filler cap on the cap holder ① while refueling.

### **CAUTION:**

If fuel is spilled on the vehicle body, flush it away with water to avoid paint damage.

## STEERING WHEEL

### STEERING WHEEL ADJUSTMENT

### **WARNING:**

Never adjust the steering wheel while driving so that full attention may be given to vehicle operation.

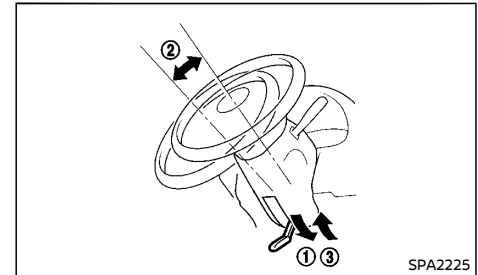

Pull the lock lever down ① and adjust the steering wheel up or down ② until the desired position is achieved.

Push the lock lever back ③ firmly to lock the steering wheel in place.

## MIRRORS



### WARNING:

Adjust the position of all mirrors before driving. Do not adjust the mirror positions while driving so that full attention may be given to vehicle operation.

### INSIDE REARVIEW MIRROR

While holding the inside rearview mirror, adjust the mirror angles until the desired position is achieved.

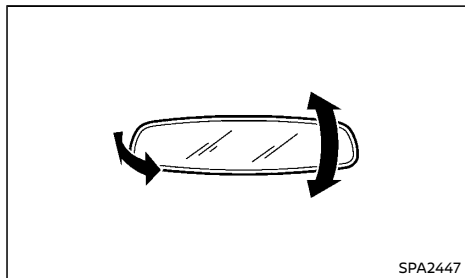

### Manual anti-glare type

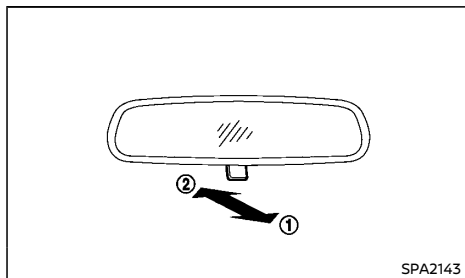

Pull the adjusting lever ① when the glare from

the headlights of the vehicle behind you obstructs your vision at night.

Push the adjusting lever ② during the day for the best rearward visibility.

### Automatic anti-glare type

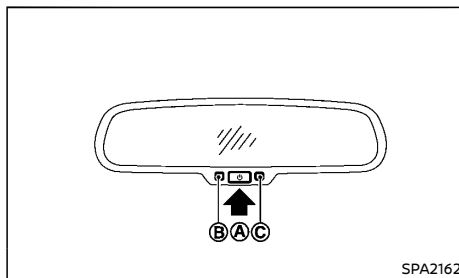

Type A

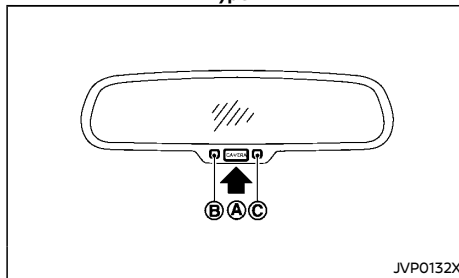

Type B

The inside rearview mirror is designed so that it automatically changes reflection according to the intensity of the headlights of the vehicle following you.

The anti-glare system will be automatically turned on when you push the ignition switch to the "ON" position.

When the system is turned on, the indicator light ⑥ will illuminate and excessive glare from the headlights of the vehicle behind you will be reduced.

Push the switch ④ (Type A) or push and hold the switch ④ for 3 seconds (Type B) to make the inside rearview mirror operate normally and the indicator light will turn off. Push the switch again (Type A) or push and hold the switch again for 3 seconds (Type B) to turn the system on.

**Do not hang any objects on the mirror or apply glass cleaner. Doing so will reduce the sensitivity of the sensor ③, resulting in improper operation.**

For the Intelligent Around View Monitor display operation (if equipped), see "Intelligent Around View Monitor" (P.4-9).

For the rear view monitor display operation (if equipped), see "Rear view monitor" (P.4-3).

### Intelligent Rear View Mirror (if equipped)



### WARNING:

Failure to follow the warnings and instructions for proper use of the Intelligent Rear View Mirror could result in serious injury or death.

- The Intelligent Rear View Mirror is a convenience feature but it is not a substitute for proper vehicle operation. The system has areas where objects cannot be viewed. Check the blind spot of the Intelligent Rear View Mirror before vehicle operation. The driver is always responsible for safe driving.
- Do not disassemble or modify the Intelligent Rear View Mirror, the camera unit or wirings. If you do, it may result in

accidents or fire. In case you notice smoke or smell coming from the Intelligent Rear View Mirror, stop using the system immediately. See a NISSAN dealer for servicing.

- Do not operate the Intelligent Rear View Mirror while driving. Doing so can be a distraction and it could lose control of your vehicle and cause an accident or serious injury.
- Do not gaze into the Intelligent Rear View Mirror display during driving. It may cause a distraction and it could lose control of your vehicle and cause an accident or serious injury. Gazing into the display screen during driving also can be a cause of carsick for passengers.
- Do not put a cigarette or flames to the Intelligent Rear View Mirror, the camera unit or wirings. It may cause a fire.
- Be sure to adjust the Intelligent Rear View Mirror before driving. Switch the system to the conventional rearview mirror mode and be properly seated on the driver's seat. Then adjust the rearview mirror so as to see the rear window properly. Driving without adjusting the rearview mirror may cause difficulty in watching the display at Intelligent Rear View Mirror mode (camera view mode) due to the reflection from the surface of the mirror.
- If the Intelligent Rear View Mirror malfunctions, immediately switch the system to the conventional rearview mirror mode. Have the system checked by a NISSAN dealer.
- When strong light (for example, sunlight or high beams from following vehicles) enters the camera, a light beam or a glaring light may appear on the display

screen of the Intelligent Rear View Mirror. In that case, switch the system to the conventional rearview mirror mode appropriately.

- If dirt, rain or snow accumulates on the exterior glass surface covering the camera, the Intelligent Rear View Mirror may not display objects clearly. Use of the rear window wiper/washer may improve visibility, but if not, switch the Intelligent Rear View Mirror to the conventional rearview mirror mode until a time the glass covering the camera can be cleaned.

#### Components:

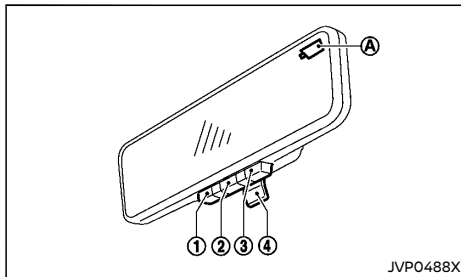

- ① MENU button
- ② Left button
- ③ Right button
- ④ Mode select lever

Intelligent Rear View Mirror provides a clear rearview from a camera located on the rear of the vehicle. Intelligent Rear View Mirror has two modes: conventional rearview mirror mode and Intelligent Rear View Mirror mode (camera view mode). You can switch these two modes by the mode select lever ④.

When the Intelligent Rear View Mirror mode is selected, the indicator Ⓐ is displayed. (If a malfunction occurs in the Intelligent Rear View Mirror, the indicator Ⓐ will turn off or not appear when the Intelligent Rear View Mirror mode is selected.)

#### How to change the mode:

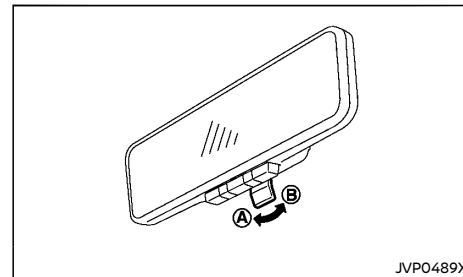

The mode can be switched when the ignition switch is in the "ON" position.

- Pull the mode select lever Ⓐ to switch to the Intelligent Rear View Mirror mode (camera view mode).
- Push the mode select lever Ⓑ to switch to the conventional rearview mirror mode.

#### How to change night mode setting of Intelligent Rear View Mirror on initial screen:

Once the headlights are turned on, the display screen will automatically enter night mode. In the night mode, the brightness of the display screen is decreased to reduce dazzling. This setting can be changed on the initial screen.

### Constant daytime mode

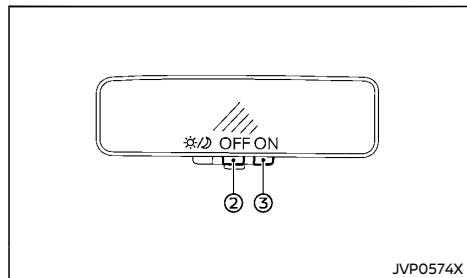

The constant daytime mode can be turned on or off while the display is in night mode and the PLS mode is turned off. Once the headlights are turned on, the display will automatically enter night mode. In night mode, the brightness of the display screen is decreased to reduce dazzling. If it is not desirable to shift the display to night mode when turning on the headlights, such as during daytime or twilight, turn the constant daytime mode on.

- Push the left button ② to turn off the constant daytime mode.
- Push the right button ③ to turn on the constant daytime mode.

The constant daytime mode will automatically return to night mode when the ignition switch is placed in the "OFF" position.

### How to make settings of Intelligent Rear View Mirror (MENU button operation):

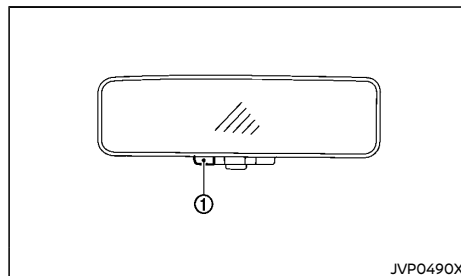

You can choose display settings of the Intelligent Rear View Mirror such as brightness, camera angle and textual indication ON or OFF. When the Intelligent Rear View Mirror mode is on, setting menu can be selected by pushing the MENU button ①. Each time the MENU button ① is pushed, the setting menu will change as follows.

MENU (initial screen) → Constant daytime mode → BRIGHTNESS → DOWN/UP → LEFT/RIGHT → ROTATION → INDICATION → LANGUAGE (if equipped) → PLS → MENU (initial screen)

#### NOTE:

**To switch the image quality adjustment items with the MENU button ①, push the button within 5 seconds after completing the adjustment of the previous item. If 5 seconds or more pass, the display will return to MENU (initial screen).**

### BRIGHTNESS

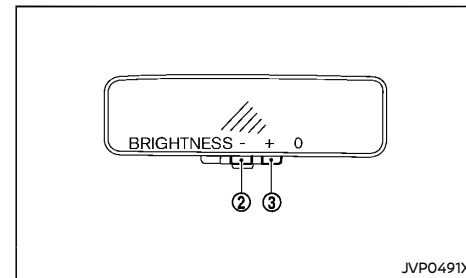

The brightness of the display screen can be adjusted.

- Push the left button ② to dim the screen.
- Push the right button ③ to brighten the screen.

### DOWN/UP

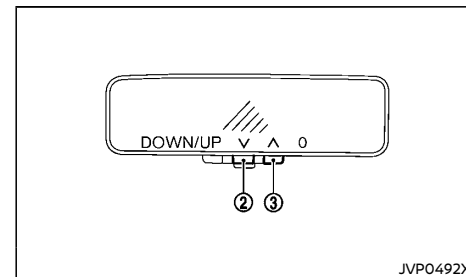

The vertical camera angle of the display screen can be adjusted.

- Push the left button ② to down the camera angle.

- Push the right button ③ to up the camera angle.

#### LEFT/RIGHT

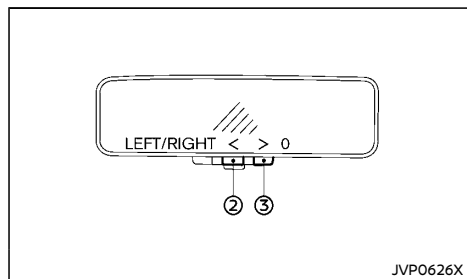

The horizontal camera angle of the display screen can be adjusted.

- Push the left button ② to move the camera angle to the left.
- Push the right button ③ to move the camera angle to the right.

#### ROTATION

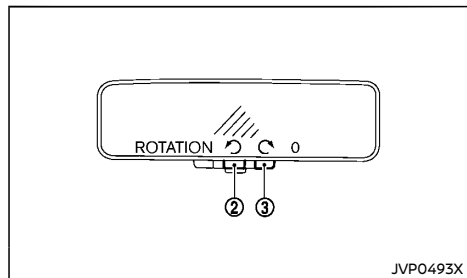

The camera angle of the display screen can be rotated.

- Push the left button ② to rotate the camera angle to the left.
- Push the right button ③ to rotate the camera angle to the right.

#### INDICATION

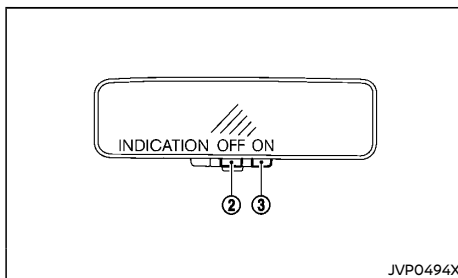

The textual indication can be turned on or off on the Intelligent Rear View Mirror display screen.

- Push the left button ② to disable the textual indication on the display screen.
- Push the right button ③ to enable the textual indication on the display screen.

#### LANGUAGE (if equipped)

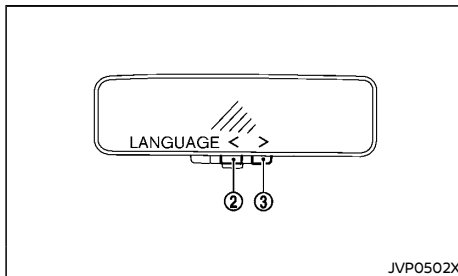

You can select the language of the textual indication on the Intelligent Rear View Mirror display screen.

The Intelligent Rear View Mirror display screen returns to the initial screen if no user input is detected for 5 seconds.

Select the language by using the ② or ③ button. The language selection may vary depending on models. The language setting will be retained even if the engine is restarted.

#### PLS

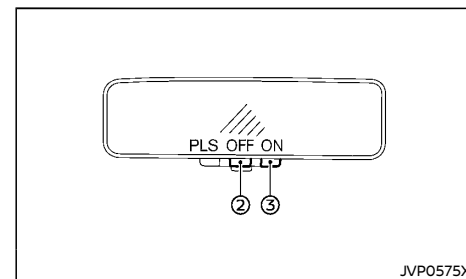

The PLS (Point Light Source) mode can be turned on or off. When this mode is on, a high resolution image is displayed, which helps recognize the headlights of the vehicle behind in the distance, for example.

- Push the left button ② to turn off the PLS mode.
- Push the right button ③ to turn on the PLS mode. ("PLS" appears in the upper right corner.)

The PLS mode will automatically be turned off when the ignition switch is placed in the "OFF" position.

**Intelligent Rear View Mirror system precautions:**

**NOTE:**

- Long-term use of this system in stopping engine may cause battery to be discharged.
- Do not attach an antenna of wireless device near the Intelligent Rear View Mirror. Electric wave from wireless device may cause disturbed image in the Intelligent Rear View Mirror.
- Do not push the buttons excessively or operating the lever roughly may cause a system failure or the Intelligent Rear View Mirror itself to drop.
- Never turn the body of Intelligent Rear View Mirror by 90° or more. It may damage the Intelligent Rear View Mirror.
- Do not apply strong shocks to the body of Intelligent Rear View Mirror. It may cause a system failure.
- Do not apply heavy load to the camera and camera-cover on the rear of the vehicle. It may cause the camera to be removed or may cause a system failure.
- If it is difficult to see the Intelligent Rear View Mirror display screen because of a strong external light, switch the mode to the conventional rearview mirror mode for better use.
- When LED headlights are viewed on the Intelligent Rear View Mirror display, the images may flicker. This is normal.
- Due to diffused reflection from external environment, images on the screen may flicker. This is not a malfunction.
- A quick movement of a thing may not be able to display on the camera view screen. This is not a malfunction.

- Turn on the headlights at twilight or in a tunnel, etc. When headlights are turned on, the display and the camera systems automatically switched to the night mode, which can prevent dazzling.
- The Intelligent Rear View Mirror mode (camera view mode) display is different from the conventional rearview mirror. Objects in the display may differ from actual distance. Do not solely rely on the Intelligent Rear View Mirror. Always rely on your own operation to avoid accidents.
- Immediately after the Intelligent Rear View Mirror is switched from one mode to another, you may have difficulty in focusing on the image in the mirror/display screen with your eyes. Be cautious using the Intelligent Rear View Mirror until your eyes get accustomed to the selected mode. If it is necessary to correct eye focusing, the use of multifocal glasses, etc. is recommended.
- If the brightness of the camera view display is adjusted to excessive bright level, it may cause an eyestrain in the driving. Adjust the brightness properly.
- Use the rear window wiper when it rains. If the camera view image is still unclear when the rear window wiper is in operation, check the deterioration of the rear window wiper blade.
- When using the rear window wiper, images on the screen may flicker. This is not a malfunction.
- Defog the rear window with defogger when rear window is fogged. Use the conventional rearview mirror mode until the rear window is fully defogged.

- The display of the Intelligent Rear View Mirror may become hot. This is not a malfunction.
- The color of an object in the distance or in the dark may be difficult to be recognized. This is not a malfunction.

**System maintenance (Intelligent Rear View Mirror):**

- Always keep the mirror and camera area of the rear window clean.
- Clean the mirror and the camera lens with a dry soft cloth.
- When cleaning the camera area of the rear window, use a soft cloth dampened with water and a few neutral detergent. And after that, dry it up with dry soft cloth.
- If the image on the Intelligent Rear View Mirror display screen is still unclear even after cleaning the camera area of the rear window, an oil film may be adhering to the rear window glass. Clean the rear window glass with an oil film remover.
- Never use alcohol, benzine, thinner, or any similar material to clean the mirror or camera lens. It will cause a discoloration, deterioration or a system malfunction.
- Do not attach a sticker (including transparent material) on the camera area of the rear window.



## OUTSIDE REARVIEW MIRRORS

### WARNING:

- Never touch the outside rearview mirrors while they are in motion. Doing so may pinch your fingers or damage the mirror.
- Never drive the vehicle with the outside rearview mirrors folded. This reduces rear view visibility and may lead to an accident.
- Objects viewed in the outside mirror are closer than they appear (if equipped).
- The picture dimensions and distance in the outside mirrors are not real.

### Adjusting

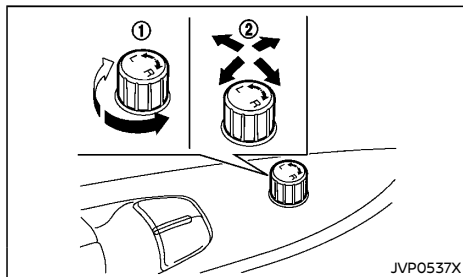

The outside rearview mirror remote control operates when the ignition switch is in the "ACC" or "ON" position.

1. Turn the switch to select the left (L) or right (R) mirror ①.
2. Adjust each mirror by pushing the switch until the desired position is achieved ②.

### Folding

#### Manual type:

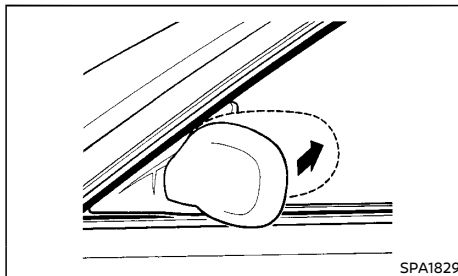

Fold the outside rearview mirror by pushing it toward the rear of the vehicle.

#### Remote control type:

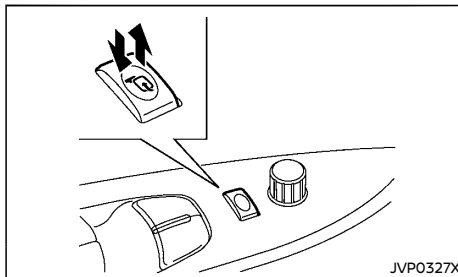

The outside rearview mirror remote control operates when the ignition switch is in the "ACC" or "ON" position.

The outside rearview mirrors automatically fold when the outside rearview mirror folding switch is pushed in. To unfold, push to the switch again.

### CAUTION:

Continuously performing the fold/unfold operation of the outside rearview mirror may cause the switch to stop the operation.

#### Automatic fold (if equipped):

The outside rearview mirrors automatically fold when the doors are locked, and unfold when the ignition switch is placed in the "ACC" or "ON" position. For information about disabling the automatic fold function, see "Vehicle Settings" (P.2-23).

#### VANITY MIRROR (if equipped)

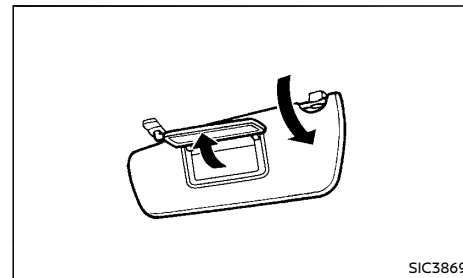

To use the front vanity mirror, pull down the sun visor and pull up the cover.

## PARKING BRAKE



### WARNING:

- Never drive the vehicle with the parking brake applied. The brake will overheat and fail to operate and will lead to an accident.
- Never release the parking brake from outside the vehicle. If the vehicle moves, it will be impossible to push the brake pedal and will lead to an accident.
- Never use the shift lever in place of the parking brake. When parking, be sure the parking brake is fully applied.
- To help avoid risk of injury or death through unintended operation of the vehicle and/or its systems, do not leave children, people who require the assistance of others or pets unattended in your vehicle. Additionally, the temperature inside a closed vehicle on a warm day can quickly become high enough to cause a significant risk of injury or death to people and pets.

### LEVER TYPE

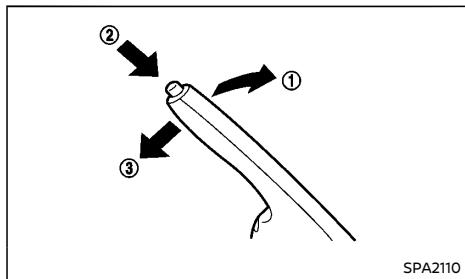

To apply the parking brake, pull the parking brake lever up ①.

To release the parking brake, depress and hold the foot brake pedal. Pull up the parking brake lever slightly, push the button ② and lower the lever completely ③.

Before driving, be sure that the brake warning light (red) has turned off.

### SWITCH TYPE (models with electronic parking brake system)

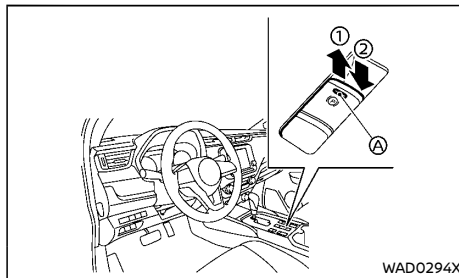

Ⓐ Indicator light

The electronic parking brake can be applied or released by operating the parking brake switch.

**To apply:** Pull the switch up ①. The indicator light Ⓐ will illuminate.

**To release:** With the ignition switch in the "ON" position, depress the brake pedal and push the switch down ②. The indicator light Ⓐ will turn off.

Before driving, check that the electronic parking brake indicator light (Ⓒ) turns off. For additional information, see "Warning lights, indicator lights and audible reminders" (P.2-12).

### NOTE:

- A buzzer will sound if the vehicle is driven without releasing the parking brake. See "Audible reminders" (P.2-19).
- While the electronic parking brake is applied or released, an operating sound is heard from the lower side of the rear seat. This is normal and does not indicate a malfunction.
- When the electronic parking brake is frequently applied and released in a short period of time, the parking brake may not operate in order to prevent the parking brake system from overheating. If this occurs, operate the electronic parking brake switch again after waiting approximately 1 minute.
- If the electronic parking brake must be applied while driving in an emergency, pull up and hold the parking brake switch. When you release the parking brake switch, the parking brake will be released.
- While pulling up the electronic parking brake switch during driving, the parking brake is applied and a chime sounds. The electronic parking brake indicator light in the meter and in the parking brake switch illuminate. This does not indicate a malfunction. The electronic parking brake indicator light in the meter and in the parking brake switch turn off when the parking brake is released.
- When pulling the electronic parking brake switch up with the ignition switch in the "OFF" or "ACC" position, the parking brake switch indicator light will continue to illuminate for a short period of time.

# 4 Monitor, Heater and air conditioner, and audio system

NissanConnect Owner's Manual (if equipped) .....	4-3	Moving Object Detection (MOD) (if equipped) .....	4-19
Safety precautions .....	4-3	MOD system operation .....	4-19
Rear view monitor (if equipped) .....	4-3	Turning MOD system on and off .....	4-20
Rear view monitor system operation .....	4-4	MOD system limitations .....	4-20
How to read the displayed lines .....	4-4	System maintenance .....	4-20
Difference between predictive and actual distances .....	4-4	Ventilators .....	4-21
How to park with predictive course lines (if equipped) .....	4-6	Center ventilators .....	4-21
Adjusting the screen .....	4-7	Side ventilators .....	4-21
Rear view monitor system limitations .....	4-7	Rear ventilators .....	4-21
System maintenance .....	4-8	Rear seat roof ventilators .....	4-21
Intelligent Around View Monitor (if equipped) .....	4-9	Heater and air conditioner .....	4-22
Intelligent Around View Monitor system operation .....	4-10	Operating tips (models with automatic air conditioner) .....	4-22
Off-road monitor (if equipped) .....	4-12	Manual air conditioner and heater .....	4-23
Difference between predicted and actual distances .....	4-12	Automatic air conditioner .....	4-25
How to park with predictive course lines .....	4-14	Rear cooler .....	4-26
How to switch the display .....	4-15	Servicing air conditioner .....	4-27
Adjusting the screen (if equipped) .....	4-15	Audio system (if equipped) .....	4-27
Intelligent Around View Monitor system limitations .....	4-15	Audio operation precautions .....	4-27
System maintenance .....	4-16	FM-AM radio with Compact Disc (CD) player .....	4-33
Camera aiding parking sensor (sonar) function (models with Intelligent Around View Monitor) .....	4-17	USB (Universal Serial Bus) connection port .....	4-38
Parking sensor (sonar) system operation .....	4-17	AUX (auxiliary) input jack .....	4-39
Turning on and off the parking sensor (sonar) function .....	4-18	CD/USB memory care and cleaning .....	4-39
Parking sensor (sonar) system limitations .....	4-18	Audio control steering switch (if equipped) .....	4-40
System maintenance .....	4-18	Rear Entertainment System (RES) (if equipped) .....	4-40
		Technical information .....	4-41
		System components .....	4-41
		Sound setting .....	4-43
		Display settings .....	4-44
		Troubleshooting guide .....	4-45

Antenna .....	4-46
Rod antenna (if equipped) .....	4-46
Shark fin antenna (if equipped) .....	4-46
Car phone and CB radio .....	4-46
Bluetooth® Hands-Free Phone System (if equipped) .....	4-47
Regulatory information .....	4-47

Control buttons and microphone .....	4-47
Bluetooth® settings .....	4-48
Using the system .....	4-49
General settings .....	4-52

## NISSANCONNECT OWNER'S MANUAL (if equipped)

For models with NissanConnect System, refer to the NissanConnect Owner's Manual that includes the following information.

Available functions may vary depending on the models and specifications.

- Audio
- Hands-free phone
- Apple CarPlay
- Android Auto
- Navigation
- Voice recognition
- Information and settings viewable on NissanConnect

## SAFETY PRECAUTIONS



### WARNING:

- Do not adjust the heater and air conditioner controls or audio controls while driving so that full attention may be given to vehicle operation.
- If you noticed any foreign objects entering the system hardware, spilled liquid on the system, or noticed smoke or fumes coming out from the system, or any other unusual operation is observed, stop using the system immediately and contact the nearest NISSAN dealer. Ignoring such conditions may lead to an accident, fire or electric shock.
- Do not disassemble or modify this system. If you do, it may lead to an accident, fire, or electric shock.



### CAUTION:

Do not use the system when the engine is not running for extended periods of time to prevent battery discharge.

## REAR VIEW MONITOR (if equipped)

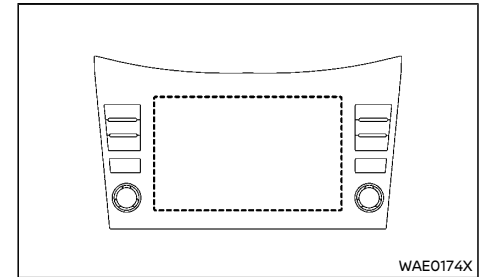

Type A

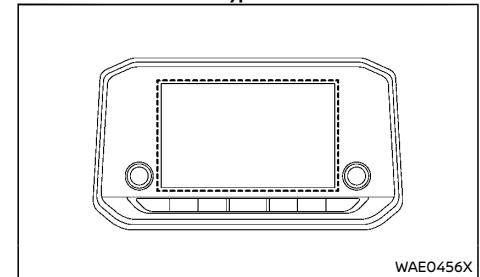

Type B



### WARNING:

Failure to follow the warnings and instructions for proper use of the rear view monitor could result in serious injury or death.

- The rear view monitor is a convenience but it is not a substitute for proper backing. Always turn and look out the windows, and check mirrors to be sure that it is safe to move before operating the vehicle. Always back up slowly.

- The system is designed as an aid to the driver in showing large stationary objects directly behind the vehicle, to help avoid damaging the vehicle.
- The distance guide line and the vehicle width line should be used as a reference only when the vehicle is on a level paved surface. The distance viewed on the monitor is for reference only and may be different than the actual distance between the vehicle and displayed objects.



**CAUTION:**

Do not scratch the camera lens when cleaning dirt or snow from the front of the camera.

The rear view monitor system automatically shows a rear view of the vehicle in the camera window on the touch screen display when the shift lever is shifted into the "R" (Reverse) position.

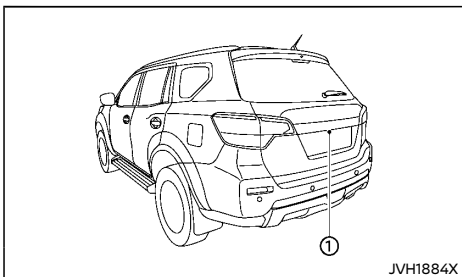

To display the rear view, the rear view monitor system uses a camera ① located just above the vehicle's license plate.

**REAR VIEW MONITOR SYSTEM OPERATION**

With the ignition switch in the "ON" position, move the shift lever to the "R" (Reverse) position to operate the rear view monitor.

**HOW TO READ THE DISPLAYED LINES**

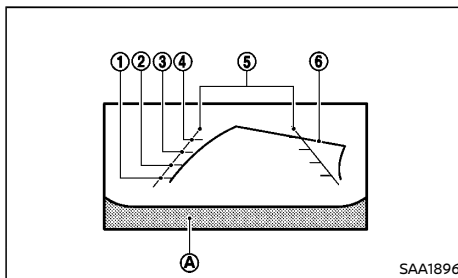

Guiding lines which indicate the vehicle width and distances to objects with reference to the bumper line ① are displayed on the monitor.

**Distance guide lines:**

Indicate distances from the vehicle body.

- Red line ①: approx. 0.5 m (1.5 ft)
- Yellow line ②: approx. 1 m (3 ft)
- Green line ③: approx. 2 m (7 ft)
- Green line ④: approx. 3 m (10 ft)

**Vehicle width guide lines ⑤:**

Indicates the approximate vehicle width.

**Predictive course lines ⑥ (if equipped):**

Indicate the predictive course when backing up. The predictive course lines will be displayed on the monitor when the shift lever is in the "R" (Reverse) position and the steering wheel is turned. The predictive course lines will move depending on how much the steering wheel is

turned and will not be displayed while the steering wheel is in the neutral position.

The vehicle width guide lines and the width of the predictive course lines are wider than the actual width and course.

**DIFFERENCE BETWEEN PREDICTIVE AND ACTUAL DISTANCES**

The displayed guide lines and their locations on the ground are for approximate reference only. Objects on uphill or downhill surfaces or projecting objects will be actually located at distances different from those displayed in the monitor relative to the guide lines (refer to illustrations). When in doubt, turn around and view the objects as you are backing up, or park and exit the vehicle to view the positioning of objects behind the vehicle.

### Backing up on a steep uphill

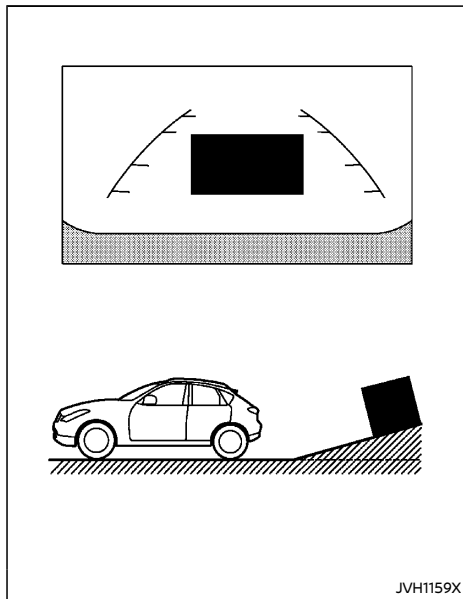

When backing up the vehicle up a hill, the distance guide lines and the vehicle width guide lines are shown closer than the actual distance. Note that any object on the hill is farther than it appears on the monitor.

### Backing up on a steep downhill

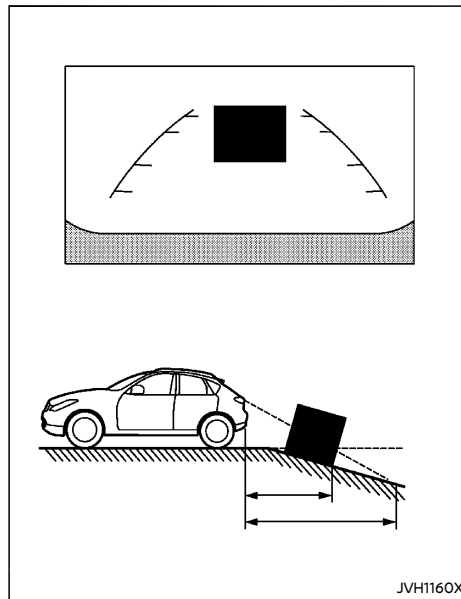

When backing up the vehicle down a hill, the distance guide lines and the vehicle width guide lines are shown farther than the actual distance. Note that any object on the hill is closer than it appears on the monitor.

### Backing up near a projecting object

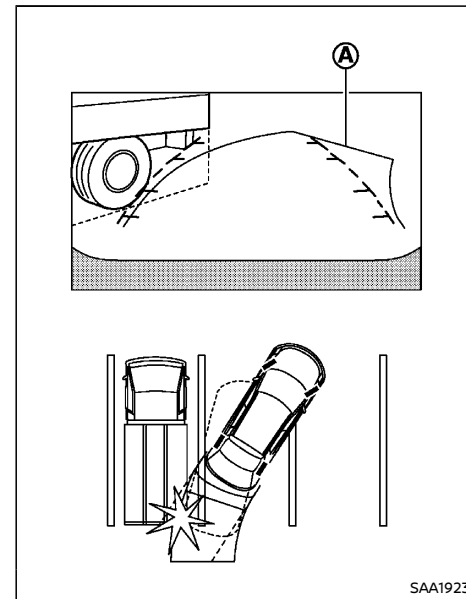

The predictive course lines Ⓐ (if equipped) do not touch the object in the display. However, the vehicle may hit the object if it projects over the actual backing up course.

## Backing up behind a projecting object

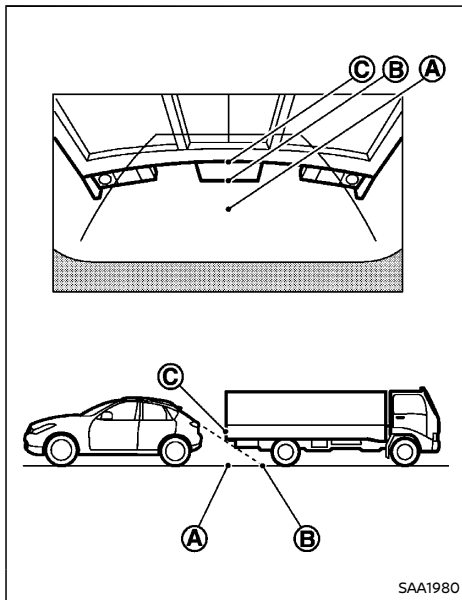

The position © is shown farther than the position Ⓐ in the display. However, the position © is actually at the same distance as the position Ⓐ. The vehicle may hit the object when backing up to the position Ⓐ if the object projects over the actual backing up course.

## HOW TO PARK WITH PREDICTIVE COURSE LINES (if equipped)

### **WARNING:**

- If the tires are replaced with different sized tires, the predictive course lines may not be displayed correctly.
- On a snow-covered or slippery road, there may be a difference between the predictive course lines and the actual course line.
- If the battery is disconnected or becomes discharged, the predictive course lines may not be displayed correctly. If this occurs, perform the following procedures.
  - Turn the steering wheel from lock to lock while the engine is running.
  - Drive the vehicle on a straight road for more than 5 minutes.
- When the steering wheel is turned with the ignition switch in the "ACC" position, the predictive course lines may be displayed incorrectly.

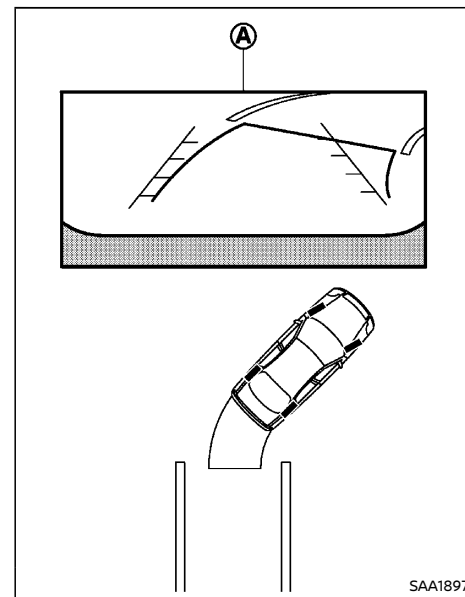

1. Visually check that the parking space is safe before parking your vehicle.
2. The rear view of the vehicle is displayed on the screen Ⓐ as illustrated when the shift lever is moved to the "R" (Reverse) position.



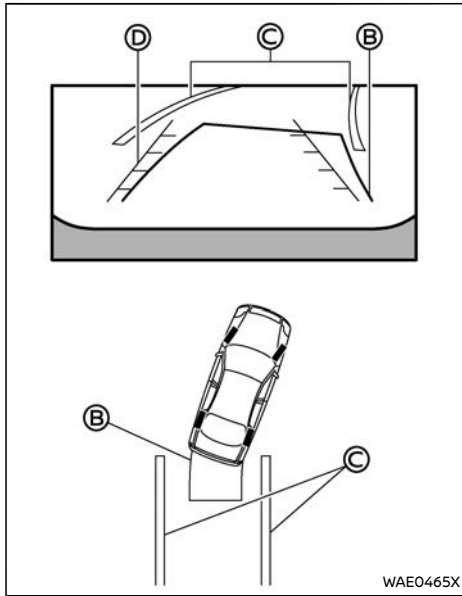

WAE0465X

3. Slowly back up the vehicle adjusting the steering wheel so that the predictive course lines (B) enter the parking space (C).
4. Maneuver the steering wheel to make the vehicle width guide lines (B) parallel to the parking space (C) while referring to the predictive course lines (B).
5. When the vehicle is parked in the space completely, move the shift lever to the "P" (Park) position and apply the parking brake.

## ADJUSTING THE SCREEN

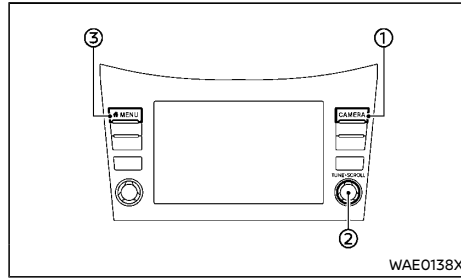

WAE0138X

Type A

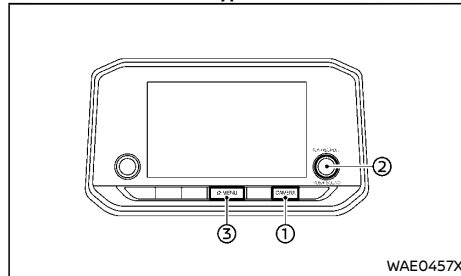

WAE0457X

Type B

1. Push the CAMERA button (1).
2. Touch the "Display Settings" key.
3. Select the setting items you wish to adjust by touching or by turning and pushing the TUNE-SCROLL dial (2).

### Available setting items:

- Brightness
- Contrast
- Tint

- Colour/Color
- Black Level

The "Display Settings" key can also be shown by pushing the MENU button (3), touching the "Settings" key and then touching the "Camera" key.

### How to turn on and off predictive course lines (if equipped)

1. Push the CAMERA button (1).
2. Touch the "Predictive Course Lines" key to turn on and off the predictive course lines.

The "Predictive Course Lines" key can also be shown by pushing the MENU button (3), touching the "Settings" key and then touching the "Camera" key.

### REAR VIEW MONITOR SYSTEM LIMITATIONS



#### WARNING:

Listed below are the system limitations for the rear view monitor. Failure to operate the vehicle in accordance with these system limitations could result in serious injury or death.

- The system cannot completely eliminate blind spots and may not show every object.
- Underneath the bumper and the corner areas of the bumper cannot be viewed on the rear view monitor because of its monitoring range limitation. The system will not show small objects below the bumper, and may not show objects close to the bumper or on the ground.

- **Objects viewed in the rear view monitor differ from actual distance because a wide-angle lens is used.**
- **Objects in the rear view monitor will appear visually opposite compared to when viewed in the rearview and outside mirrors.**
- **Use the displayed lines as a reference. The lines are highly affected by the number of occupants, fuel level, vehicle position, road conditions and road grade.**
- **Make sure that the back door is securely closed when backing up.**
- **Do not put anything on the rear view camera. The rear view camera is installed above the license plate.**
- **When washing the vehicle with high-pressure water, be sure not to spray it around the camera. Otherwise, water may enter the camera unit causing water condensation on the lens, a malfunction, fire or an electric shock.**
- **Do not strike the camera. It is a precision instrument. Otherwise, it may malfunction or cause damage resulting in a fire or an electric shock.**

The following are operating limitations and do not represent a system malfunction:

- When the temperature is extremely high or low, the screen may not clearly display objects.
- When strong light is directly coming on the camera, objects may not be displayed clearly.
- Vertical lines may be seen in objects on the screen. This is due to strong reflected light from the bumper.

- The screen may flicker under fluorescent light.
- The colors of objects on the rear view monitor may differ somewhat from the actual color of objects.
- Objects on the monitor may not be clear in a dark environment.
- There may be a delay when switching to the rear view monitor.
- If dirt, rain or snow accumulates on the camera, the rear view monitor may not display object clearly. Clean the camera.
- Do not use wax on the camera lens. Wipe off any wax with a clean cloth dampened with a diluted mild cleaning agent, then wipe with a dry cloth.

①, the rear view monitor may not display objects clearly. Clean the camera by wiping it with a cloth dampened with a diluted mild cleaning agent and then wiping it with a dry cloth.

## SYSTEM MAINTENANCE

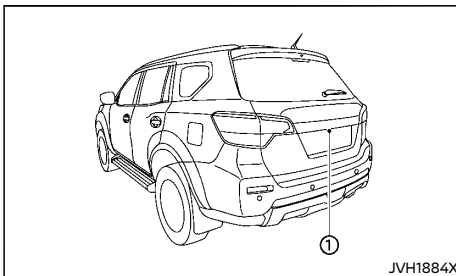

### CAUTION:

- **Do not use alcohol, benzine or thinner to clean the camera. This will cause discoloration.**
- **Do not damage the camera as the monitor screen may be adversely affected.**

If dirt, rain or snow accumulates on the camera

## INTELLIGENT AROUND VIEW MONITOR (if equipped)

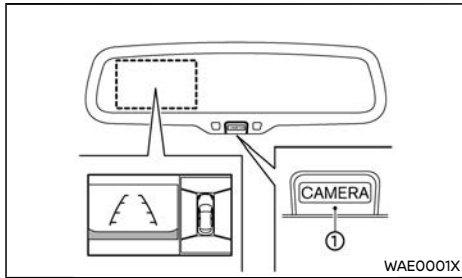

Type A

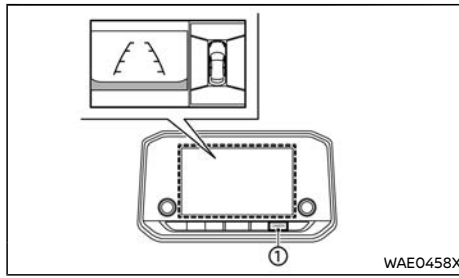

Type C

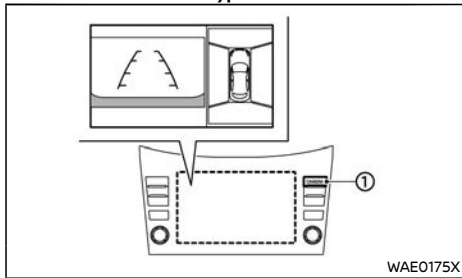

Type B

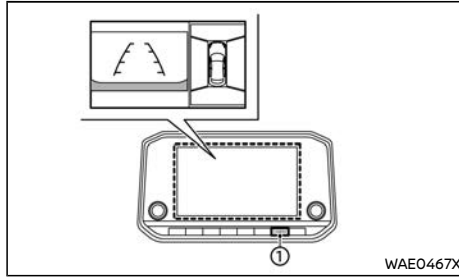

Type D

1. CAMERA button

### WARNING:

- Failure to follow the warnings and instructions for the proper use of the Intelligent Around View Monitor system could result in serious injury or death.
- The Intelligent Around View Monitor is a convenient feature but it is not a substitute for proper vehicle operation because it has areas where objects cannot be viewed. The four corners of the vehicle in particular, are areas where objects do

not always appear in the bird's-eye, front, or rear views. Always check your surroundings to be sure that it is safe to move before operating the vehicle. Always operate the vehicle slowly. Always look out the windows and check mirrors to be sure that it is safe to move.

- The driver is always responsible for safety during parking and other maneuvers.



### CAUTION:

Do not scratch the lens when cleaning dirt or snow from the front of the camera.

The Intelligent Around View Monitor system is designed as an aid to the driver in situations such as slot parking or parallel parking.

The monitor displays various views of the position of the vehicle in a split screen format. Not all views are available at all times.

### Available views:

- Front View  
An approximately 150-degree view of the front of the vehicle.
- Rear View  
An approximately 150-degree view of the rear of the vehicle.
- Bird's-eye View  
The surrounding views of the vehicle from above.
- Front-side View  
The view around and ahead of the front passenger's side wheel.

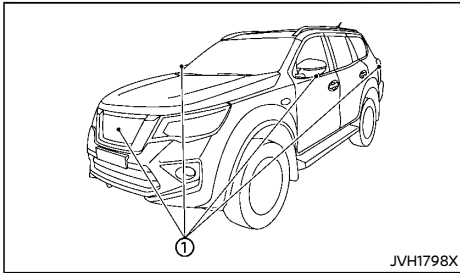

To display the multiple views, the Intelligent Around View Monitor system uses cameras ① located in the front grill, on the vehicle's outside mirrors and one just above the vehicle's license plate.

### INTELLIGENT AROUND VIEW MONITOR SYSTEM OPERATION

The Intelligent Around View Monitor is displayed on the inside rearview mirror (Type A)/ touch screen display (Type B, C and D).

With the ignition switch in the "ON" position, move the shift lever to the "R" (Reverse) position or push the CAMERA button to operate the Intelligent Around View Monitor.

When the camera is first activated with the bird's-eye view in the display, a red icon will flash on the screen. This indicates that the parking sensor (sonar) system is activated. The gray icon will flash when the parking sensor (sonar) system is turned off. For additional information on the parking sensor (sonar) system, refer to "Camera aiding parking sensor (sonar) function (models with Intelligent Around View Monitor)" (P.4-17).

The screen displayed on the Intelligent Around View Monitor will automatically turn off 3

minutes after the CAMERA button has been pushed with the shift lever in a position other than the "R" (Reverse) position.

### Available views

#### WARNING:

- The distance guide line and the vehicle width line should be used as a reference only when the vehicle is on a paved, level surface. The distance viewed on the monitor is for reference only and may be different than the actual distance between the vehicle and displayed objects.
- Use the displayed lines and the bird's-eye view as a reference. The lines and the bird's-eye view are greatly affected by the number of occupants, fuel level, vehicle position, road condition and road grade.
- If the tires are replaced with different sized tires, the predictive course line and the bird's-eye view may be displayed incorrectly.
- When driving the vehicle up a hill, objects viewed in the monitor are further than they appear. When driving the vehicle down a hill, objects viewed in the monitor are closer than they appear.
- Objects in the rear view will appear visually opposite compared to when viewed in the rear view and outside mirrors.
- Use the mirrors or actually look to properly judge distances to other objects.
- The distance between objects viewed in the rear view differs from actual distance because a wide-angle lens is used.

- On a snow-covered or slippery road, there may be a difference between the predictive course line and the actual course line.
- The vehicle width and predictive course lines are wider than the actual width and course.
- The displayed lines on the rear view will appear slightly off to the right because the rear view camera is not installed in the rear center of the vehicle.

### Front and rear view:

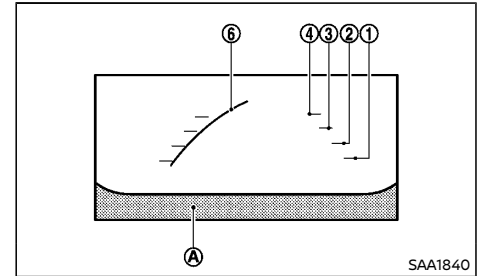

Front view

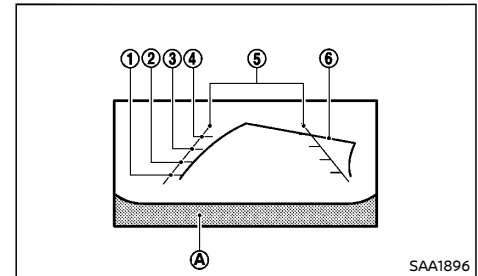

Rear view

Guiding lines that indicate the approximate

vehicle width and distances to objects with reference to the vehicle body line ④, are displayed on the monitor.

#### Distance guide lines:

Indicate distances from the vehicle body.

- Red line ①: approximately 0.5 m (1.5 ft)
- Yellow line ②: approximately 1 m (3 ft)
- Green line ③: approximately 2 m (7 ft)
- Green line ④: approximately 3 m (10 ft)

#### Vehicle width guide lines ⑤:

Indicate the approximate vehicle width.

#### Predictive course lines ⑥:

Indicate the predicted course when operating the vehicle. The predictive course lines will move depending on how much the steering wheel is turned.

The front view will not be displayed when the vehicle speed is above 10 km/h (6 MPH).

#### NOTE:

**When the monitor displays the front view and the steering wheel turns about 90 degrees or less from the straight-ahead position, both the right and left predictive course lines ⑥ are displayed. When the steering wheel turns about 90 degrees or more, a line is displayed only on the opposite side of the turn.**

#### Bird's-eye view:

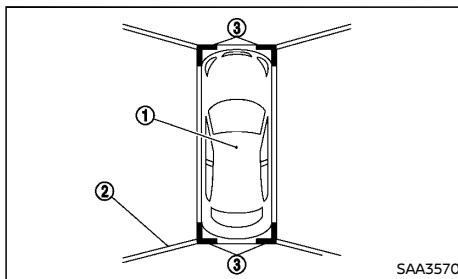

The bird's-eye view shows the overhead view of the vehicle which helps confirm the vehicle position.

The vehicle icon ① shows the position of the vehicle. Note that the apparent distance between objects viewed in the bird's-eye view may differ somewhat from the actual distance to the vehicle.

The areas that the cameras cannot cover ② are indicated in black.

The non-viewable areas ② are highlighted in yellow for several seconds after the bird's-eye view is displayed. It will be shown only the first time after the ignition switch is placed in the "ON" position.

When the parking sensor (sonar) is deactivated, the non-viewable corners ③ are displayed in red to remind the driver to be cautious.

After the ignition switch is placed in the "ON" position, the non-viewable corners ③ will blink for 3 seconds after the bird's-eye view is displayed.



#### WARNING:

- Objects in the bird's-eye view will appear farther than the actual distance.
- Tall objects, such as a curb or vehicle, may be misaligned or not displayed at the seam of the views.
- Objects that are above the camera cannot be displayed.
- The view for the bird's-eye view may be misaligned when the camera position alters.
- A line on the ground may be misaligned and is not seen as being straight at the seam of the views. The misalignment will increase as the line proceeds away from the vehicle.

#### Front-side view:

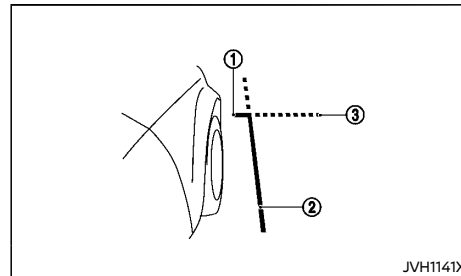

#### Guiding lines:

Guiding lines that indicate the approximate width and the front end of the vehicle are displayed on the monitor.

The front-of-vehicle line ① shows the front part of the vehicle.

The side-of-vehicle line ② shows the approx-

imate vehicle width including the outside mirrors.

The extensions ③ of both the front ① and side ② lines are shown with a green dotted line.

### OFF-ROAD MONITOR (if equipped)

When the shift lever is out of the "R"(Reverse) position and the vehicle speed is 10 km/h (6 MPH) or below, selecting the 4LO position using the 4WD mode switch affects the Intelligent Around View Monitor display as follows:

- Selecting the 4LO position will activate the Intelligent Around View Monitor. The front view/front-side view split screen will be displayed.
- When the ignition switch is placed in the "ON" position with the 4LO position selected, the front view/front-side view split screen will be displayed.
- When the vehicle is shifted to the 4LO position with the bird's-eye view displayed, the passenger side of the display will change to the front-side view.

For details about the 4WD mode switch, see "Four-Wheel Drive (4WD)" (P.5-19).

When the off-road monitor is active, the screen displayed on the Intelligent Around View Monitor will return to the previous screen only when 3 minutes have passed after the vehicle was shifted out of the 4LO position or vehicle speed is above 10 km/h (6 MPH).

After automatically returning to the previous screen due to the vehicle speed exceeding 10 km/h (6 MPH) with the 4WD mode switch in the 4LO position, decreasing the vehicle speed to 8 km/h (5 MPH) or below will again display the Intelligent Around View Monitor (front view/front-side view screen).

### DIFFERENCE BETWEEN PREDICTED AND ACTUAL DISTANCES

The displayed guide lines and their locations on the ground are for approximate reference only. Objects on uphill or downhill surfaces or projecting objects will be actually located at distances different from those displayed in the monitor relative to the guide lines (refer to illustrations). When in doubt, turn around and view the objects as you are backing up, or park and exit the vehicle to view the positioning of objects behind the vehicle.

### Backing up on a steep uphill

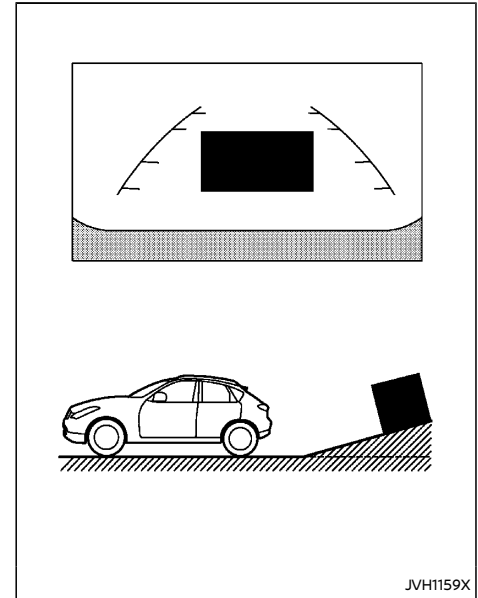

When backing up the vehicle up a hill, the distance guide lines and the vehicle width guide lines are shown closer than the actual distance. Note that any object on the hill is farther than it appears on the monitor.

### Backing up on a steep downhill

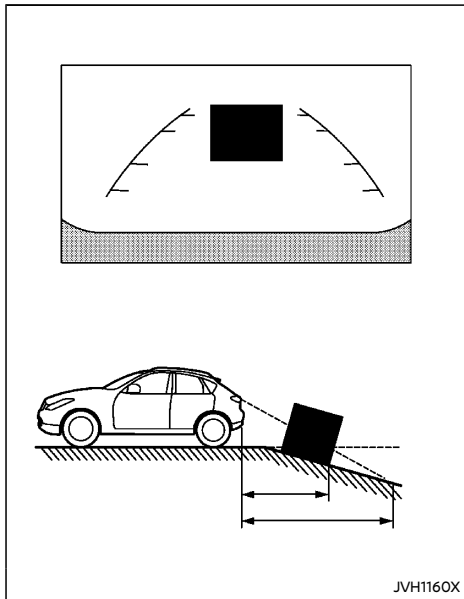

When backing up the vehicle down a hill, the distance guide lines and the vehicle width guide lines are shown farther than the actual distance. Note that any object on the hill is closer than it appears on the monitor.

### Backing up near a projecting object

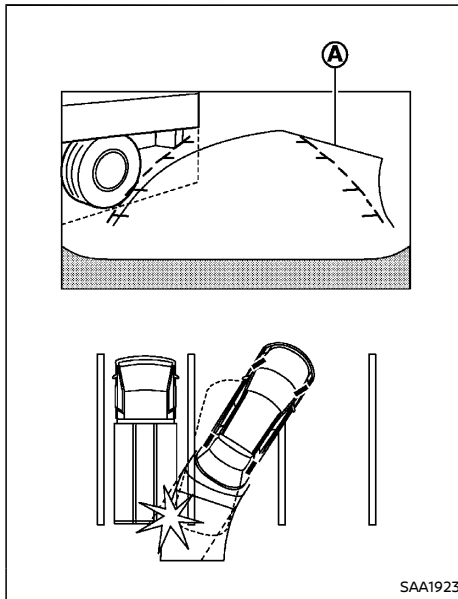

The predictive course lines **A** do not touch the object in the display. However, the vehicle may hit the object if it projects over the actual backing up course.

### Backing up behind a projecting object

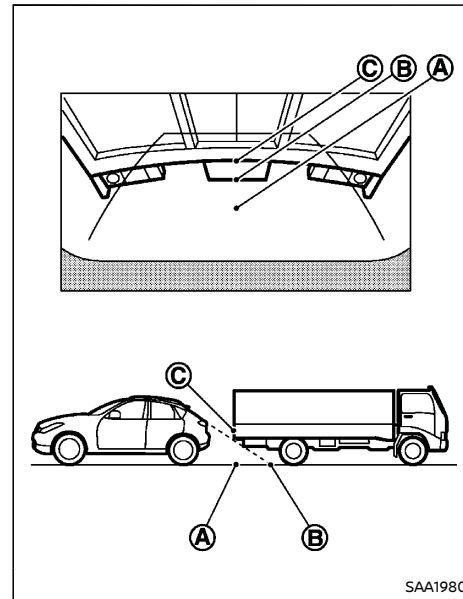

The position **C** is shown farther than the position **B** in the display. However, the position **C** is actually at the same distance as the position **A**. The vehicle may hit the object when backing up to the position **A** if the object projects over the actual backing up course.

## HOW TO PARK WITH PREDICTIVE COURSE LINES



### WARNING:

- If the tires are replaced with different sized tires, the predictive course lines may be displayed incorrectly.
- On a snow-covered or slippery road, there may be a difference between the predictive course line and the actual course line.
- If the battery is disconnected or becomes discharged, the predictive course lines may be displayed incorrectly. If this occurs, please perform the following procedures:
  - Turn the steering wheel from lock to lock while the engine is running.
  - Drive the vehicle on a straight road for more than 5 minutes.
- When the steering wheel is turned with the ignition switch in the "ACC" position, the predictive course lines may be displayed incorrectly.

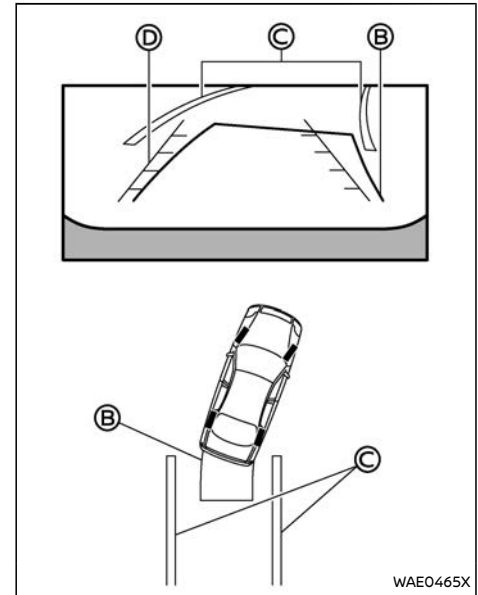
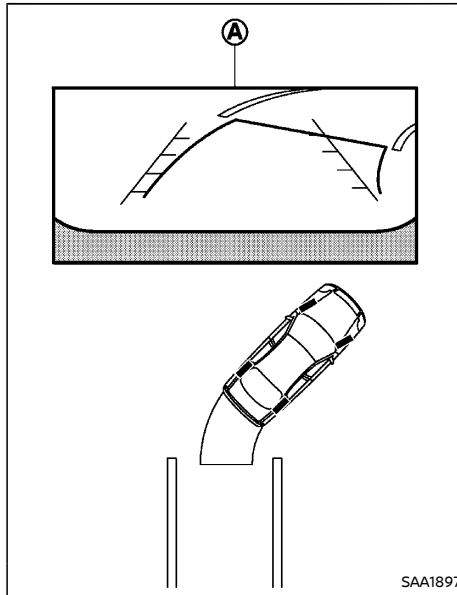

1. Visually check that the parking space is safe before parking your vehicle.
2. The rear view of the vehicle is displayed on the screen (A) when the shift lever is moved to the "R" (Reverse) position.

3. Slowly back up the vehicle adjusting the steering wheel so that the predictive course lines (B) enter the parking space (C).
4. Maneuver the steering wheel to make the vehicle width guide lines (D) parallel to the parking space (C) while referring to the predictive course lines.
5. When the vehicle is parked in the space completely, move the shift lever to the "P" (Park) position and apply the parking brake.



## HOW TO SWITCH THE DISPLAY

With the ignition switch in the "ON" position, push the CAMERA button or move the shift lever to the "R" (Reverse) position to operate the Intelligent Around View Monitor.

Push the CAMERA button to switch the available views.

If the shift lever is not in the "R" (Reverse) position, the available views are:

- Front view/bird's-eye view split screen
- Front view/front-side view split screen

If the shift lever is in the "R" (Reverse) position, the available views are:

- Rear view/bird's-eye view split screen
- Rear view/front-side view split screen
- Rear view

The Intelligent Around View Monitor screen will turn off when:

- The shift lever is in the "D" (Drive) position and the vehicle speed increases above approximately 10 km/h (6 MPH).

## ADJUSTING THE SCREEN (if equipped)

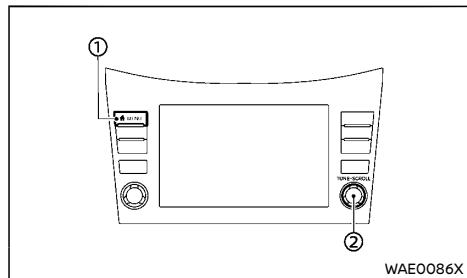

Type B

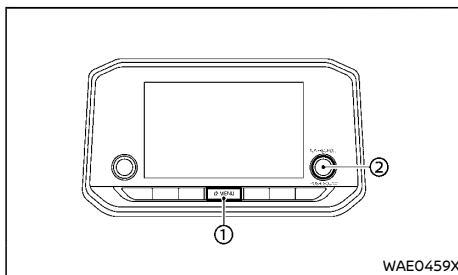

Type C

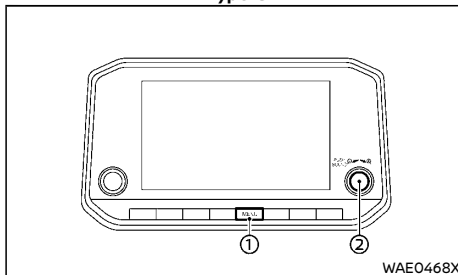

Type D

1. Push the MENU button ①.
2. Touch the "Settings" key.
3. Touch the "Camera" key.
4. Touch the "Display Settings" key.
5. Select the setting items you wish to adjust by touching or by turning and pushing the Scroll dial ②.

### Available setting items:

- Brightness
- Contrast

- Tint
- Colour/Color
- Black Level

## INTELLIGENT AROUND VIEW MONITOR SYSTEM LIMITATIONS



### WARNING:

Listed below are the system limitations for Intelligent Around View Monitor. Failure to operate the vehicle in accordance with these system limitations could result in serious injury or death.

- Do not use the Intelligent Around View Monitor with the outside mirrors in the stored position, and make sure that the back door is securely closed when operating the vehicle using the Intelligent Around View Monitor.
- The apparent distance between objects viewed on the Intelligent Around View Monitor differs from the actual distance.
- The cameras are installed on the front grille, the outside mirrors and above the rear license plate. Do not put anything on the vehicle that covers the cameras.
- When washing the vehicle with high pressure water, be sure not to spray it around the cameras. Otherwise, water may enter the camera unit causing water condensation on the lens, a malfunction, fire or an electric shock.
- Do not strike the cameras. They are precision instruments. Doing so could cause a malfunction or cause damage resulting in a fire or an electric shock.

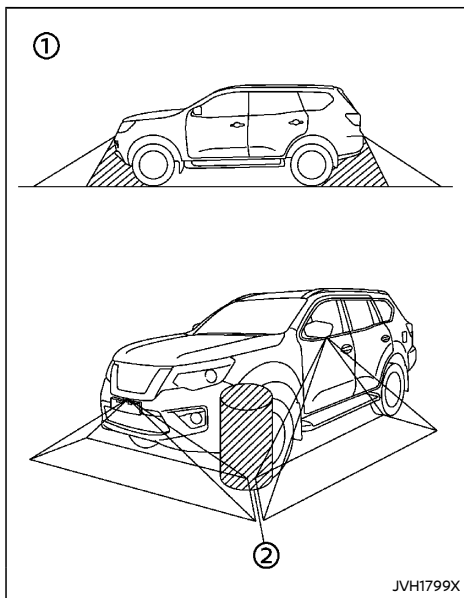

There are some areas where the system will not show objects and the system does not warn of moving objects. When in the front or rear view display, an object below the bumper or on the ground may not be viewed ①. When in the bird's-eye view, a tall object near the seam ② of the camera viewing areas will not appear in the monitor.

The following are operating limitations and do not represent a system malfunction:

- There may be a delay when switching between views.

- When the temperature is extremely high or low, the screen may not display objects clearly.
- When strong light directly shines on the camera, objects may not be displayed clearly.
- The screen may flicker under fluorescent light.
- The colors of objects on the Intelligent Around View Monitor may differ somewhat from the actual color of objects.
- Objects on the Intelligent Around View Monitor may not be clear and the color of the object may differ in a dark environment.
- There may be differences in sharpness between each camera view of the bird's-eye view.
- Do not use wax on the camera lens. Wipe off any wax with a clean cloth that has been dampened with a diluted mild cleaning agent, then wipe with a dry cloth.

### System temporarily unavailable

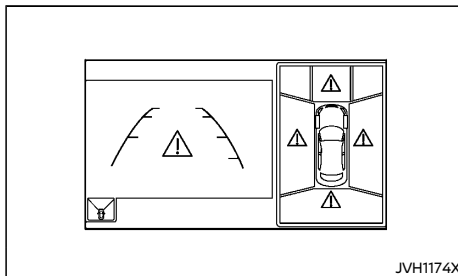

When the "⚠" icon is displayed on the screen, there are abnormal conditions in the Intelligent Around View Monitor. This will not hinder normal driving operation but the system

should be inspected by a NISSAN dealer.

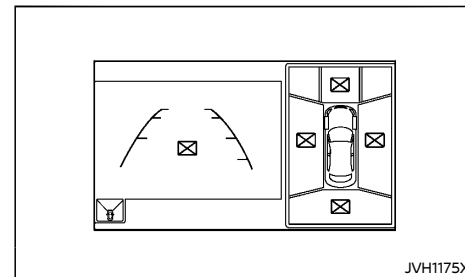

When the "⊠" icon is displayed on the screen, the camera image may be receiving temporary electronic disturbances from surrounding devices. This will not hinder normal driving operation but the system should be inspected by a NISSAN dealer if it occurs frequently.

### SYSTEM MAINTENANCE

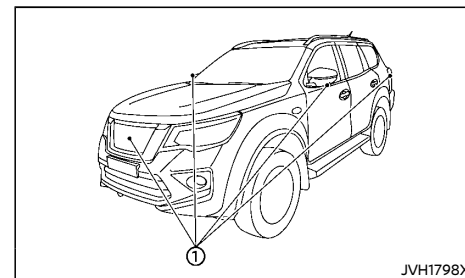

### CAUTION:

- **Do not use alcohol, benzene or thinner to clean the camera. This will cause discoloration.**

## CAMERA AIDING PARKING SENSOR (sonar) FUNCTION (models with Intelligent Around View Monitor)

- Do not damage the camera as the monitor screen may be adversely affected.

If dirt, rain or snow accumulates on any of the cameras ①, the Intelligent Around View Monitor may not display objects clearly. Clean the camera by wiping with a cloth dampened with a diluted mild cleaning agent and then wiping with a dry cloth.

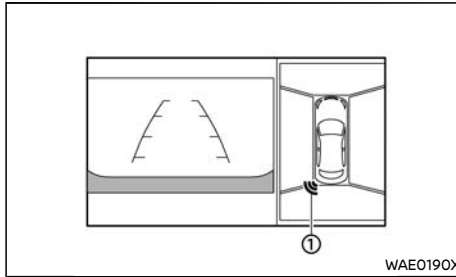

1. Parking sensor (sonar) indicator



### WARNING:

Failure to follow the warnings and instructions for proper use of the parking sensor (sonar) function as outlined in this section could result in serious injury or death.

- The parking sensor (sonar) is a convenience feature. It is not a substitute for proper parking.
- This function is designed as an aid to the driver in detecting large stationary objects to help avoid damaging the vehicle.
- The driver is always responsible for safety during parking and other maneuvers.
- Always look around and check that it is safe to move before parking.
- Read and understand the limitations of the parking sensor (sonar) as contained in this section.



### CAUTION:

- Keep the interior of the vehicle as quiet as possible to hear the tone clearly.
- The front and rear parking sensors (sonar) detect the distance between the vehicle and the obstacle by detecting the sound wave reflected from the surface of the obstacle. When there is a sound source such as horn, or an ultrasonic source (such as parking sensors of other vehicles) around the vehicle, the sensor (sonar) may not detect objects properly.

The parking sensor (sonar) function helps to inform the driver of large stationary objects around the vehicle when parking by issuing an audible and visual alert.

### PARKING SENSOR (sonar) SYSTEM OPERATION

When the camera is first activated with the bird's-eye view in the display, a red icon will flash on the Intelligent Around View Monitor screen. This indicates that the parking sensor (sonar) system is activated.

The system gives the tone for rear objects when the shift lever is in the "R" (Reverse) position.

When the camera image is shown on the inside rearview mirror (models without NissanConnect System)/touch screen display (models with NissanConnect System), the system shows the parking sensor (sonar) indicator regardless of the shift lever position.

The system is deactivated at speeds above 10 km/h (6 MPH). It is reactivated at lower speeds.

The colors of the parking sensor (sonar) indicators and the distance guide lines in the rear views indicate different distances to the

object.

When the objects are detected, the indicator (green) appears and blinks and the tone sounds intermittently. When the vehicle moves closer to the object, the color of the indicator turns yellow and the rate of the blinking and the rate of the tone increase. When the vehicle is very close to the object, the indicator stops blinking and turns red, and the tone sounds continuously.

The intermittent tone will stop after 3 seconds when an object is detected by only the corner sensor and the distance does not change.

The tone will stop when the object is no longer near the vehicle.

#### TURNING ON AND OFF THE PARKING SENSOR (sonar) FUNCTION

To deactivate the parking sensor (sonar) system temporarily, see "Parking sensor (sonar) system switch" (P.5-81).

To set up the parking sensor (sonar) function to your preferred settings, see "Driver Assistance" (P.2-22).

#### PARKING SENSOR (sonar) SYSTEM LIMITATIONS



##### **WARNING:**

**Listed below are the system limitations for the parking sensor (sonar) function. Failure to operate the vehicle in accordance with these system limitations could result in serious injury or death.**

- **Inclement weather or ultrasonic sources such as an automatic car wash, a truck's compressed-air brakes or a pneumatic drill may affect the function of the sys-**

**tem, including reduced performance or a false activation.**

- **The system is not designed to prevent contact with small or moving objects.**
- **The system will not detect small objects below the bumper, and may not detect objects close to the bumper or on the ground.**
- **The system may not detect the following objects:**
  - **Fluffy objects such as snow, cloth, cotton, grass or wool.**
  - **Thin objects such as rope, wire or chain.**
  - **Wedge-shaped objects.**
- **If your vehicle sustains damage to the bumper fascia, leaving it misaligned or bent, the sensing zone may be altered causing inaccurate measurement of objects or false alarms.**



##### **CAUTION:**

**Excessive noise (such as audio system volume or an open vehicle window) will interfere with the tone and it may not be heard.**

#### System temporarily unavailable

When the amber markers are displayed at the corners of the vehicle icon and the function cannot be activated from the "Driver Assistance" settings (the setting items are grayed out), the parking sensor (sonar) system may be malfunctioning.

#### SYSTEM MAINTENANCE



##### **CAUTION:**

**Keep the surface of the parking sensors (sonar) (located on the front bumper (if equipped) and rear bumper fascia) free from accumulations of snow, ice and dirt. Do not scratch the surface of the parking sensors (sonar) when cleaning. If the parking sensors (sonar) are covered, the accuracy of the parking sensor (sonar) function will be diminished.**

## MOVING OBJECT DETECTION (MOD) (if equipped)



### WARNING:

Failure to follow the warnings and instructions for proper use of the Moving Object Detection (MOD) system could result in serious injury or death.

- The MOD system is not a substitute for proper vehicle operation and is not designed to prevent contact with the objects surrounding the vehicle. When maneuvering, always use the outside mirror and rearview mirror and turn and check the surrounding to ensure it is safe to maneuver.
- The system is deactivated at speeds above 8 km/h (5 MPH). It is reactivated at lower speeds.
- The MOD system is not designed to detect the surrounding stationary objects.

The Moving Object Detection (MOD) system can inform the driver of the moving objects surrounding the vehicle when driving out of garages, maneuvering into parking lots and in other such instances.

The MOD system detects moving objects by using image processing technology on the image shown on the display.

### MOD SYSTEM OPERATION

The MOD system will turn on automatically under the following conditions:

- When the shift lever is in the "R" (Reverse) position.
- When vehicle speed decreases below approximately 8 km/h (5 MPH) and the camera screen is displayed.

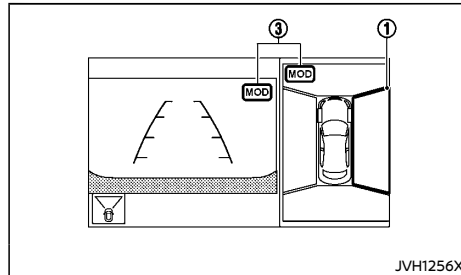

Front and bird's-eye views

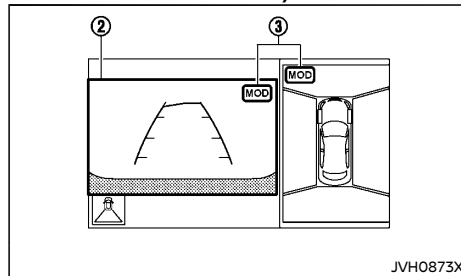

Rear and bird's-eye views

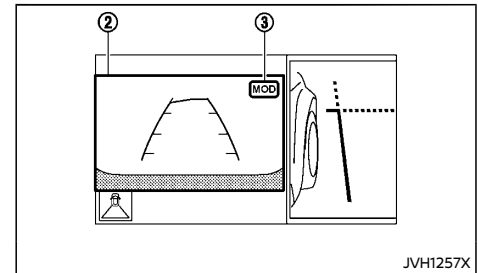

Rear and front-side views

The MOD system operates in the following conditions when the camera view is displayed:

- When the shift lever is in the "P" (Park) or "N" (Neutral) position and the vehicle is stopped, the MOD system detects moving objects in the bird's-eye view. The MOD system will not operate if the outside mirrors are moving in or out, in the stowed position, or if either front door is opened.
- When the shift lever is in the "D" (Drive) position and the vehicle speed is below approximately 8 km/h (5 MPH), the MOD system detects moving objects in the front view.
- When the shift lever is in the "R" (Reverse) position and the vehicle speed is below approximately 8 km/h (5 MPH), the MOD system detects moving objects in the rear view.

The MOD system will not operate if the back door is open.

The MOD system does not detect moving objects in the front-side view. The MOD icon is not displayed on the screen when in this view.

When the MOD system detects moving objects near the vehicle, a chime will be heard and a yellow frame will be displayed on the view

where the objects are detected. While the MOD system continues to detect moving objects, the yellow frame continues to be displayed.

In the bird's-eye view, the yellow frame ① is displayed on each camera image (front, rear, right, left) depending on where moving objects are detected.

The yellow frame ② is displayed on each view in the front view and rear view modes.

A blue MOD icon ③ is displayed in the view where the MOD system is operative. A white MOD icon ③ is displayed in the view where the MOD system is not operative.

#### TURNING MOD SYSTEM ON AND OFF

The MOD system can be turned on and off. See "Driver Assistance" (P.2-22) for details.

#### MOD SYSTEM LIMITATIONS

##### **WARNING:**

Listed below are the system limitations for MOD. Failure to operate the vehicle in accordance with these system limitations could result in serious injury or death.

- Excessive noise (for example, audio system volume or open vehicle window) will interfere with the chime sound, and it may not be heard.
- The MOD system performance will be limited according to environmental conditions and surrounding objects such as:
  - When there is low contrast between background and the moving objects.
  - When there is blinking source of light.
  - When strong light such as another vehicle's headlight or sunlight is present.

– When camera orientation is not in its usual position, such as when mirror is folded.

– When there is dirt, water drops or snow on the camera lens.

– When the position of the moving objects in the display is not changed.

- The MOD system might detect flowing water droplets on the camera lens, white smoke from the muffler, moving shadows, etc.
- The MOD system may not function properly depending on the speed, direction, distance or shape of the moving objects.
- If your vehicle sustains damage to the parts where the camera is installed, leaving it misaligned or bent, the sensing zone may be altered and the MOD system may not detect objects properly.
- When the temperature is extremely high or low, the screen may not display objects clearly. This is not a malfunction.

##### **NOTE:**

The blue MOD icon will change to orange if one of the following has occurred.

- When the system is malfunctioning.
- When the component temperature reaches a high level (icon will blink).
- When the rear view camera has detected a blockage (icon will blink).

If the icon light continues to illuminate in orange, have the MOD system checked. It is recommended that you visit a NISSAN dealer for this service.

#### SYSTEM MAINTENANCE

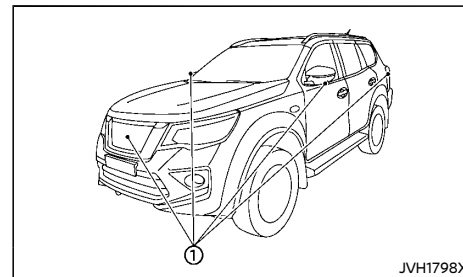

##### **CAUTION:**

- Do not use alcohol, benzine or thinner to clean the camera. This will cause discoloration.
- Do not damage the camera as the monitor screen may be adversely affected.

If dirt, rain or snow accumulates on any of the cameras ①, the MOD system may not operate properly. Clean the camera by wiping with a cloth dampened with a diluted mild cleaning agent and then wiping with a dry cloth.

## VENTILATORS

### CENTER VENTILATORS

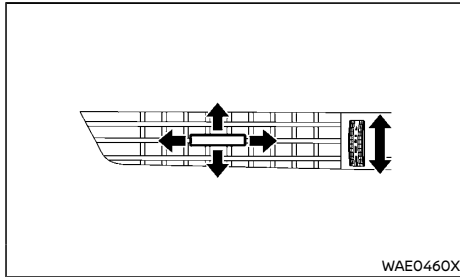

**Left side**

Open/close the ventilators by moving the control to either direction.

Adjust the air flow direction of the ventilators by moving the center knob (up/down, left/right) until the desired position is achieved.

### SIDE VENTILATORS

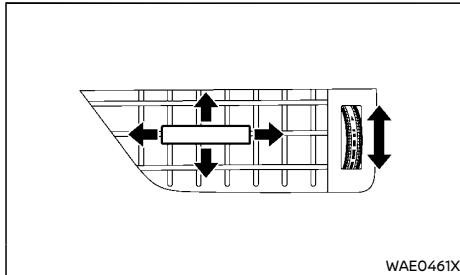

**Right side**

Open/close the ventilators by moving the control to either direction.

Adjust the air flow direction of the ventilators by moving the center knob (up/down, left/right) until the desired position is achieved.

right) until the desired position is achieved.

### REAR VENTILATORS

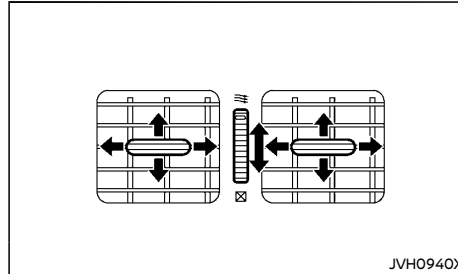

Open/close the ventilators by moving the control to either direction.

- ≡ : This symbol indicates that the ventilators are open. Moving the control to this direction will open the ventilators.
- ☒ : This symbol indicates that the ventilators are closed. Moving the control to this direction will close the ventilators.

Adjust the air flow direction of the ventilators by moving the center knob (up/down, left/right) until the desired position is achieved.

### REAR SEAT ROOF VENTILATORS

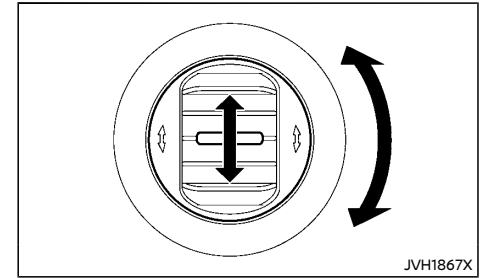

Adjust the air flow direction of the ventilators by moving the center knob (up/down) or by rotating the ventilators until the desired position is achieved.

## HEATER AND AIR CONDITIONER



### WARNING:

- The heater and air conditioner operate only when the engine is running.
- Never leave children or adults who would normally require the support of others alone in the vehicle. Pets should not be left alone either. They could unknowingly activate switches or controls and inadvertently become involved in a serious accident and injure themselves. On hot, sunny days, temperatures in a closed vehicle could quickly become high enough to cause severe or possibly fatal injuries to people or animals.
- Do not use the recirculation mode for long periods as it may cause the interior air to become stale and the windows to fog up.
- Do not adjust the heating and air conditioning controls while driving so that full attention may be given to vehicle operation.

The heater and air conditioner operate when the engine is running. The air blower will operate even if the engine is turned off and the ignition switch is placed in the "ON" position.

### NOTE:

- Odors from inside and outside the vehicle can build up in the air conditioner unit. Odor can enter the passenger compartment through the ventilators.
- When parking, set the heater and air conditioner controls to turn off air recirculation to allow fresh air into the passenger compartment. This should help reduce odors inside the vehicle.

When the remote engine start feature (if equipped) is used, an automatic air conditioner will adjust the passenger compartment automatically to set the appropriate temperature.

### OPERATING TIPS (models with automatic air conditioner)

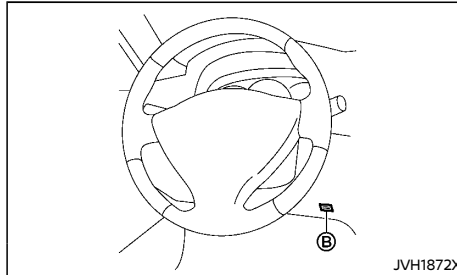
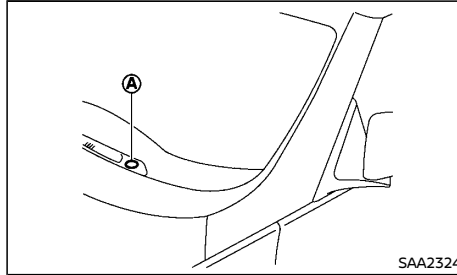

### Left-Hand Drive (LHD) model (example)

When the engine coolant temperature and outside air temperature are low, the air flow from the foot outlets may not operate. However, this is not a malfunction. After the coolant temperature warms up, the air flow from the foot outlets will operate normally.

The sensors A and B\*, located on the instru-

ment panel, help maintain a constant temperature. Do not put anything on or around the sensors.

\*:The layout illustrated is for Left-Hand Drive (LHD) models. On the Right-Hand Drive (RHD) models, the sensor B is located on the opposite side.



## MANUAL AIR CONDITIONER AND HEATER

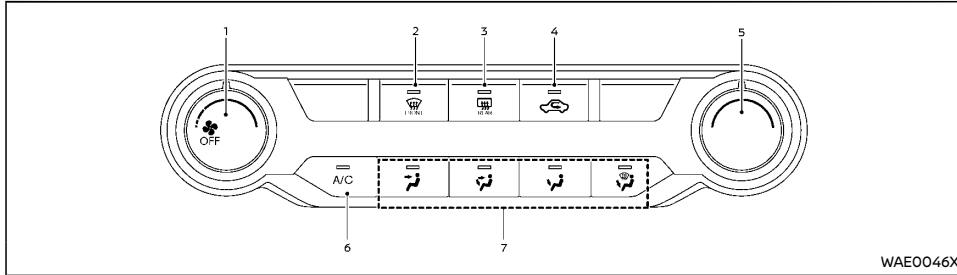

1. (fan speed control) dial
2. (front defogger) button
3. (rear window defogger) button (See "Defogger switch" (P.2-42).)
4. (air recirculation) button
5. Temperature control dial
6. A/C (air conditioner) button
7. Air flow control buttons

### Controls

#### Turning system on/off:

To turn on the system, turn the dial out of the OFF position. Turn the dial counterclockwise to the OFF position to turn off the system.

#### Fan speed control:

Turn the dial clockwise to increase the fan speed.

Turn the dial counterclockwise to decrease the fan speed.

#### Temperature control:

Turn the temperature control dial to set the desired temperature. Turn the dial between the middle and the right position to select the hot temperature. Turn the dial between the middle and the left position to select the cool temperature.

#### Air flow control:

Push one of the air flow control buttons to select the air flow outlets.

- Air flows mainly from center and side ventilators.
- Air flows mainly from center and side ventilators and foot outlets.
- Air flows mainly from the foot outlet.
- Air flows mainly from the defogger and foot outlets.

#### Air intake control:

The air intake control mode will change each time the button is pushed.

- When the indicator light on the button is turned on, the air recirculates inside the vehicle.
- When the indicator light on the button is turned off, the air flow is drawn from outside the vehicle.

#### A/C (Air Conditioner) operation:

Push the A/C button to turn on or off the air conditioner. When the air conditioner is on, the A/C indicator light on the button illuminates.

### Heater operation

#### Heating:

This mode is used to direct heated air from the foot outlets.

1. Push the button for normal heating. (The indicator light will turn off.)
2. Push the button. (The indicator light will turn on.)
3. Turn the dial to the desired position.
4. Turn the temperature control dial to the desired position between the middle and the hot (right) position.

#### Ventilation:





This mode directs outside air from the side and center ventilators.

1. Push the button. (The indicator light will turn off.)
2. Push the button. (The indicator light will turn on.)
3. Turn the dial to the desired position.

4. Turn the temperature control dial to the desired position between the middle and the hot (right) position.

#### **Defrosting or defogging:**



This mode directs the air to the defogger outlets to defrost/defog the windows.

1. Turn the  dial to the desired position.
2. Push the  button. (The indicator lights on the  button and the A/C button will turn on. The indicator light on the  button automatically turns off, allowing outside air to be drawn into the passenger compartment to further improve the defogging performance.)
3. Turn the temperature control dial to the desired position between the middle and the hot (right) position.

To remove frost from the windshield quickly, turn the temperature control dial to the maximum hot (right) position and the  dial to the maximum position.



#### **Bi-level heating:**

This mode directs cool air from the side/center ventilators and warm air from the foot outlets. (When the temperature control dial is turned to the maximum hot (right) or cool (left) position, the temperatures from the side/center ventilators and the foot outlets will be the same.)

1. Push the  button. (The indicator light will turn off.)
2. Push the  button. (The indicator light will turn on.)
3. Turn the  dial to the desired position.
4. Turn the temperature control dial to the desired position between the middle and the hot (right) position.

#### **Heating and defogging:**

This mode heats the interior and defogs the windows.



1. Push the  button. (The indicator light will turn on.)
2. Turn the  dial to the desired position.
3. Turn the temperature control dial to the desired position between the middle and the hot (right) position.

#### **Air conditioner operation**

The air conditioner system should be operated for approximately 10 minutes at least once a month. This helps prevent damage to the air conditioner system due to the lack of lubrication.

#### **Cooling:**



This mode is used to cool and dehumidify the air.

1. Push the  button. (The indicator light will turn on.)
2. Turn the  dial to the desired position.
3. Push the A/C button. (The indicator light will turn on.)
4. Turn the temperature control dial to the desired position between the middle and the cool (left) position.

A visible mist may be seen coming from the ventilators in hot, humid conditions as the air is cooled rapidly. This does not indicate a malfunction.



#### **Dehumidified heating:**

This mode is used to heat and dehumidify the air.

1. Push the  button. (The indicator light will turn off.)
2. Push the  button. (The indicator light will turn on.)
3. Turn the  dial to the desired position.
4. Push the A/C button. (The indicator light will turn on.)
5. Turn the temperature control dial to the desired position between the middle and the hot (right) position.





#### **Dehumidified defogging:**

This mode is used to defog the windows and dehumidify the air.

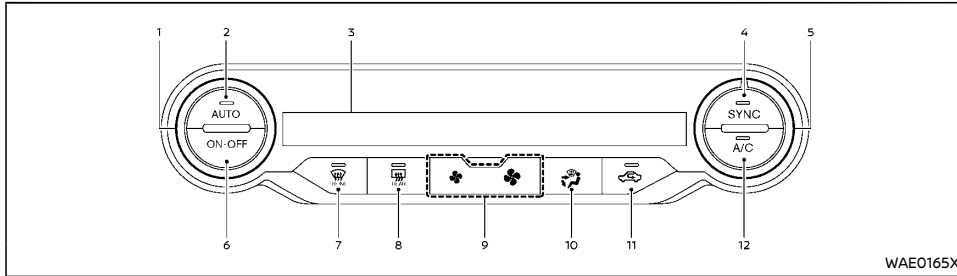
1. Push the  button. (The indicator lights on the  button and the A/C button will turn on.)
2. Turn the  dial to the desired position.
3. Turn the temperature control dial to the desired position.

## AUTOMATIC AIR CONDITIONER



1. Temperature control dial (driver's side)
2. AUTO (automatic) button
3. Display screen
4. SYNC (synchronize) button
5. Temperature control dial (front passenger's side)
6. ON-OFF button
7.  (front defogger) button
8.  (rear window defogger) button  
(See "Defogger switch" (P.2-42).)
9.  (fan speed control) buttons
10.  (air flow control) button
11.  (air recirculation) button
12. A/C (air conditioner) button

### Automatic operation

#### Cooling and/or dehumidified heating (AUTO):

This mode may be used all year round as the system automatically works to keep a constant temperature. Air flow distribution and fan speed are also controlled automatically.

1. Push the AUTO button. (The indicator light on the button will illuminate.)
2. Turn the temperature control dial on the corresponding side to set the desired temperature.
  - You can individually set temperatures for the driver's side and front passenger's side when the indicator light on the SYNC button is turned off.

A visible mist may be seen coming from the ventilators in hot, humid conditions as the air is cooled rapidly. This does not indicate a malfunction.

### Heating (A/C OFF):



The air conditioner does not activate in this mode. Use this mode when you only need to heat.

1. Push the AUTO button. (The indicator light on the button will illuminate.)
2. Push the A/C button. (The indicator light on the button will turn off.)
3. Turn the temperature control dial on the corresponding side to set the desired temperature.
  - You can individually set temperatures for the driver's side and front passenger's side when the indicator light on the SYNC button is turned off.
  - The temperature of the passenger compartment will be maintained automatically. Air flow distribution and fan speed are also controlled automatically.

#### NOTE:

- **Do not set the temperature lower than the outside air temperature or the system may not work properly.**
- **Not recommended if windows fog up.**

#### Dehumidified defrosting or defogging:

1. Push the  button on. (The indicator light on the button will illuminate.)
2. Turn the temperature control dial on the driver's side to set the desired temperature.
  - To quickly remove ice from the outside of the windows, use the  button to set the fan speed to maximum.
  - As soon as possible after the windshield is clean, push the AUTO button to return to the automatic mode.

- When the  button is pushed, the air conditioner will automatically be turned on at outside temperatures above 2°C (35°F). The air recirculation mode automatically turns off, allowing outside air to be drawn into the passenger compartment to further improve the defogging performance.

## Manual operation

### Fan speed control:

Push the  buttons to manually control the fan speed.





### Air intake control:

The air intake control mode will change each time the  button is pushed.

- When the indicator light is turned on, the air recirculates inside the vehicle.
- When the indicator light is turned off, the air flow is drawn from outside the vehicle.
- To switch to the automatic control mode, push and hold the  button for about 2 seconds. The indicator light will flash twice, and then the air intake will be controlled automatically.

### Air flow control:

Pushing the  button manually controls air flow and selects the air outlet:

-  — Air flows mainly from center and side ventilators.
-  — Air flows mainly from center and side ventilators and foot outlets.
-  — Air flows mainly from the foot outlet and partly from the defogger.
-  — Air flows mainly from the defogger and foot outlets.

### Synchronize climate settings:

Push the SYNC button to synchronize the driver's and front passenger's side temperature settings. (The indicator light on the button will illuminate.)

When the SYNC mode is active, the driver's side temperature control dial will control the driver's and front passenger's side temperatures.

To exit the SYNC mode, turn the front passenger's side temperature control dial or push the SYNC button. (The indicator light on the button will turn off.)

### To turn the system off

Push the ON-OFF button.

## REAR COOLER

To turn on the rear cooler, push the ON side of the rear cooler switch and turn the rear fan speed control dial out of the "0" position.

To turn off the rear cooler, push the OFF side of the rear cooler switch or turn the rear fan speed control dial to the "0" position.

See "Operation with front controllers" (P.4-26) or "Operation with rear fan speed control dial" (P.4-27).

The front air conditioning system must be activated to operate the rear cooler.

## Operation with front controllers

### Operation with front controllers:

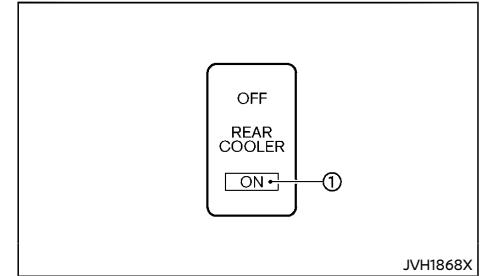

**Rear cooler switch**

To activate the rear cooler with the front controllers:

1. Turn on the front air conditioning system. (See "Manual air conditioner and heater" (P.4-23) or "Automatic air conditioner" (P.4-25).)
2. Push the ON side of the rear cooler switch (located on the instrument panel). The indicator light ① will turn on when the rear cooler is activated.

To turn off the rear cooler, push the OFF side of the rear cooler switch. The indicator light ① will turn off.

To turn off the front air conditioning system and the rear cooler simultaneously, turn off the front air conditioning system. (See "Manual air conditioner and heater" (P.4-23) or "Automatic air conditioner" (P.4-25).)

### A/C (Air Conditioner) operation:

Push the "A/C" button to turn on or off the air conditioner. (See "Manual air conditioner and heater" (P.4-23) or "Automatic air conditioner" (P.4-25).)

Operation with rear fan speed control dial

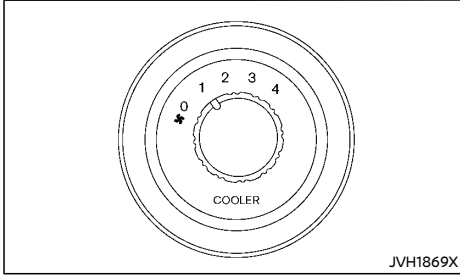

**Rear fan speed control dial**

Rear fan speed control dial is located on the rear ceiling.

### Turning rear cooler on/off:

To turn on the system, turn the rear fan speed control dial out of the "0" position.

Turn the dial to the "0" position to turn off the system.

### Fan speed control:

To adjust the fan speed, turn the rear fan speed control dial to the desired position ("1" to "4").

### SERVICING AIR CONDITIONER



#### WARNING:

**The air conditioner system contains refrigerant under high pressure. To avoid personal injury, any air conditioner service should be done only by an experienced technician with the proper equipment.**

The air conditioner system in your vehicle is charged with a refrigerant designed with the environment in mind.

**This refrigerant will not harm the earth's ozone layer.** However, it may contribute in a small part to global warming.

Special charging equipment and lubricant are required when servicing your vehicle's air conditioner. Using improper refrigerants or lubricants will cause severe damage to the air conditioner system. (See "Air conditioner system refrigerant and lubricant" (P.9-5).)

A NISSAN dealer will be able to service your environmentally friendly air conditioner system.

### Air conditioner filter

The air conditioner system is equipped with an air conditioner filter which collects dust. To make sure that the air conditioner heats, defogs and ventilates efficiently, replace the filter in accordance with the specified maintenance intervals listed in the separate maintenance booklet. To replace the filter, contact a NISSAN dealer.

The filter should be replaced if the air flow decreases significantly or if windows fog up easily when operating the heater or air conditioner.

### AUDIO SYSTEM (if equipped)

For models with NissanConnect System:

Refer to the NissanConnect Owner's Manual for the audio system operations.

### AUDIO OPERATION PRECAUTIONS



#### WARNING:

**Do not adjust the audio system while driving so that full attention may be given to vehicle operation.**

### Radio

- Radio reception is affected by station signal strength, distance from radio transmitter, buildings, bridges, mountains and other external influences. Intermittent changes in reception quality normally are caused by these external influences.
- Using a cellular phone in or near the vehicle may influence radio reception quality.

## Compact Disc (CD) player

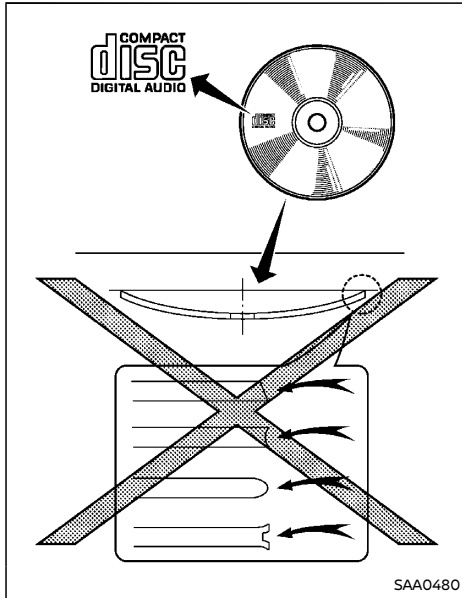

- During cold weather or rainy days, the player may malfunction due to the humidity. If this occurs, remove the CD from CD player and dehumidify or ventilate the player completely.
- The player may skip while driving on rough roads.
- The CD player sometimes may not function when the passenger compartment temperature is extremely high. Lower the temperature before use.

- Do not expose the CD to direct sunlight.
- CDs that are of poor quality, or are dirty, scratched, covered with fingerprints, or that have pin holes may not work properly.
- The following CDs may not work properly.
  - Copy control compact discs (CCCD)
  - Recordable compact discs (CD-R)
  - Rewritable compact discs (CD-RW)
- Do not use the following CDs as they may cause the CD player to malfunction.
  - 8 cm (3.1 in) discs
  - CDs that are not round
  - CDs with a paper label
  - CDs that are warped, scratched or have unusual edges.
- This audio system can only play pre-recorded CDs. It has no capabilities to record or burn CDs.

## USB (Universal Serial Bus) connection port



### WARNING:

**Do not connect, disconnect or operate the USB device while driving. Doing so can be a distraction. If distracted you could lose control of your vehicle and cause an accident or serious injury.**



### CAUTION:

- **Do not force the USB device into the USB connection port. Inserting the USB device tilted or up-side-down into the port may damage the port. Make sure that the USB device is connected correctly into the USB connection port.**
- **Do not leave the USB cable in a place where it can be pulled unintentionally.**

### Pulling the cable may damage the port.

The vehicle is not equipped with a USB device. USB devices should be purchased separately as necessary.

This system cannot be used to format USB devices. To format a USB device, use a personal computer.

In some states/area, the USB device for the front seats plays only sound without images for regulatory reasons, even when the vehicle is parked.

This system supports various USB memory devices, USB hard drives and iPod players. Some USB devices may not be supported by this system.

- Partitioned USB devices may not be played correctly.
- Some characters used in other languages (Chinese, Japanese, etc.) may not appear properly in the display. Using English language characters with a USB device is recommended.

### General notes for USB use:

Refer to your device manufacturer's owner information regarding the proper use and care of the device.

### Notes for iPod use:

"Made for iPod", "Made for iPhone", and "Made for iPad" mean that an electronic accessory has been designed to connect specifically to iPod, iPhone, or iPad, respectively, and has been certified by the developer to meet Apple performance standards.

Apple is not responsible for the operation of this device or its compliance with safety and regulatory standards.

Please note that the use of this accessory with iPod, iPhone, or iPad may affect wireless

performance.

iPad, iPhone, iPod, iPod classic, iPod nano, iPod shuffle, and iPod touch are trademarks of Apple Inc., registered in the U.S. and other countries. Lightning is a trademark of Apple Inc.

- Improperly plugging in the iPod may cause a checkmark to be displayed on and off (flickering). Always make sure that the iPod is connected properly.
- An iPod nano (1st Generation) may remain in fast forward or rewind mode if it is connected during a seek operation. In this case, please manually reset the iPod.
- An iPod nano (2nd Generation) will continue to fast-forward or rewind if it is disconnected during a seek operation.
- An incorrect song title may appear when the Play Mode is changed while using an iPod nano (2nd Generation).
- Audiobooks may not play in the same order as they appear on an iPod.
- Large video files cause slow responses in an iPod. The vehicle center display may momentarily black out, but will soon recover.
- If an iPod automatically selects large video files while in the shuffle mode, the vehicle center display may momentarily black out, but will soon recover.

### Bluetooth® audio player (if equipped)

- Some Bluetooth® audio devices may not be used with this system. For detailed information about Bluetooth® audio devices that are available for use with this system, contact a NISSAN dealer.
- Before using a Bluetooth® audio system, the initial registration process for the audio device is necessary.

- Operation of the Bluetooth® audio system may vary depending on the audio device that is connected. Confirm the operation procedure before use.
- The playback of Bluetooth® audio will be paused under the following conditions. The playback will be resumed after the following conditions are completed.
  - while using a hands-free phone
  - while checking a connection with a cell phone
- The in-vehicle antenna for Bluetooth® communication is built in the system. Do not place the Bluetooth® audio device in an area surrounded by metal, far away from the system or in a narrow space where the device closely contacts the body or the seat. Otherwise, sound degradation or connection interference may occur.
- While a Bluetooth® audio device is connected through the Bluetooth® wireless connection, the battery power of the device may discharge quicker than usual.
- This system is compatible with the Bluetooth® AV profile (A2DP and AVRCP).



Bluetooth® is a trademark owned by Bluetooth SIG, Inc., and licensed to Visteon Corporation.

### Compact Disc (CD)/USB device with MP3/WMA/AAC

#### Terms:

- MP3 — MP3 is short for Moving Pictures Experts Group Audio Layer 3. MP3 is the most well known compressed digital audio file format. This format allows for near “CD quality” sound, but at a fraction of the size of normal audio files. MP3 conversion of an

audio track from CD can reduce the file size by approximately 10:1 ratio (Sampling: 44.1 kHz, Bit rate: 128 kbps) with virtually no perceptible loss in quality. MP3 compression removes the redundant and irrelevant parts of a sound signal that the human ear doesn't hear.

- WMA — Windows Media Audio (WMA) is a compressed audio format created by Microsoft as an alternative to MP3. The WMA codec offers greater file compression than the MP3 codec, enabling storage of more digital audio tracks in the same amount of space when compared to MP3s at the same level of quality.

This product is protected by certain intellectual property rights of Microsoft Corporation and third parties. Use or distribution of such technology outside of this product is prohibited without a license from Microsoft or an authorized Microsoft subsidiary and third parties.
- AAC — Advanced Audio Coding (AAC) is a compressed audio format. AAC offers greater file compression than MP3 and enables music file creation and storage at the same quality as MP3.
- Bit rate — Bit rate denotes the number of bits per second used by a digital music files. The size and quality of a compressed digital audio file is determined by the bit rate used when encoding the file.
- Sampling frequency — Sampling frequency is the rate at which the samples of a signal are converted from analog to digital (A/D conversion) per second.
- Multisession — Multisession is one of the methods for writing data to media. Writing data once to the media is called a single session, and writing more than once is called a multisession.

- ID3/WMA Tag — The ID3/WMA tag is the part of the encoded MP3 or WMA file that contains information about the digital music file such as song title, artist, album title, encoding bit rate, track time duration, etc. ID3 tag information is displayed on the Album/Artist/Track title line on the display.

\* Windows® and Windows Media® are registered trademarks and/or trademarks of Microsoft Corporation in the United States of America and/or other countries.

**Playback order:**

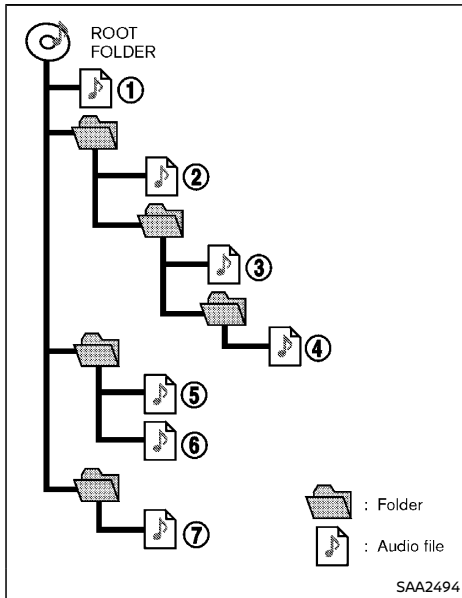

Music playback order of the CD with MP3/

WMA/AAC is as illustrated above.

- The folder names of folders not containing MP3/WMA files are not shown in the display.
- If there is a file in the top level of the disc, "Root Folder" is displayed.
- The playback order is the order in which the files were written by the writing software, so the files might not play in the desired order.



**Specification chart:**

Supported media		CD, CD-R, CD-RW, USB2.0	
Supported file systems		ISO9660 LEVEL1, ISO9660 LEVEL2, Romeo, Joliet ISO9660 Level 3 (packet writing) is not supported. Files saved using the Live File System component (on a Windows Vista-based computer) are not supported.	
		USB memory: FAT16, FAT32	
Supported versions*1	MP3	Version	MPEG1 Audio Layer 3
		Sampling frequency	32 kHz - 48 kHz
		Bit rate	32 kbps - 320 kbps VBR*4
	WMA*2	Version	WMA9 (compatible WMA7 and WMA8)
		Sampling frequency	16 kHz - 48 kHz
		Bit rate	48 kbps - 320 kbps, VBR*4
	AAC	Version	MPEG-4 AAC
		Sampling frequency	8 kHz - 48 kHz
		Bit rate	32 kbps - 192 kbps, VBR*4
Tag information (Song title and Artist name)		ID3 tag VER1.0, VER1.1, VER2.2, VER2.3	
		AAC tag supported	
Folder levels		CD, CD-R, CD-RW	Folder levels: 8, Folders: 255 (including root folder), Files: 512 (Max. 255 files for one folder)
		USB	Folder levels: 8, Folders 255, Files: 2500 (Max. 255 files for one folder) Memory size: 4GB
Displayable character codes*3		01: ASCII, 02: ISO-8859-1, 03: UNICODE (UTF-16 BOM Big Endian), 04: UNICODE (UTF-16 Non-BOM Big Endian), 05: UNICODE (UTF-8), 06: UNICODE (Non-UTF-16 BOM Little Endian), 07:SHIFT-JIS	

\*1 Files created with a combination of 48 kHz sampling frequency and 64 kbps bit rate cannot be played.

\*2 Protected WMA files (DRM) cannot be played.

\*3 Available codes depend on what kind of media, versions and information are going to be displayed.

\*4 When VBR files are played, the playback time may not be displayed correctly. WMA7 and WMA8 are not applied to VBR.

**Troubleshooting guide:**

Symptom	Cause and Countermeasure
Cannot play	Check if the disc or USB was inserted correctly.
	Check if the disc is scratched or dirty.
	Check if there is condensation inside the player, and if there is, wait until the condensation is gone (about 1 hour) before using the player.
	If there is a temperature increase error, the CD player will play correctly after it returns to the normal temperature.
	If there is a mixture of music CD files (CD-DA data) and MP3/WMA/AAC files on a CD, only the music CD files (CD-DA data) will be played.
	Files with extensions other than ".MP3", ".WMA", ".M4A", ".mp3", ".wma" or "m4a" cannot be played. In addition, the character codes and number of characters for folder names and file names should be in compliance with the specifications.
	Check if the disc or the file is generated in an irregular format. This may occur depending on the variation or the setting of MP3/WMA/AAC writing applications or other text editing applications.
	Check if the finalization process, such as session close and disc close, is done for the disc.
Check if the disc or USB is protected by copyright.	
Poor sound quality	Check if the disc is scratched or dirty.
It takes a relatively long time before the music starts playing.	If there are many folder or file levels on the disc or USB memory device, some time may be required before the music starts playing.
Music cuts off or skips	The writing software and hardware combination might not match, or the writing speed, writing depth, writing width, etc., might not match the specifications. Try using the slowest writing speed.
Skipping with high bit rate files	Skipping may occur with large quantities of data, such as for high bit rate data.
Move immediately to the next song when playing.	When a non-MP3/WMA/AAC file has been given an extension of ".MP3", ".WMA", ".M4A", ".mp3", ".wma" or "m4a", or when play is prohibited by copyright protection, the player will skip to the next song.
The songs do not play back in the desired order.	The playback order is the order in which the files were written by the writing software, so the files might not play in the desired order.
	Random/Shuffle may be active on the audio system or on a USB device.

## FM-AM RADIO WITH COMPACT DISC (CD) PLAYER

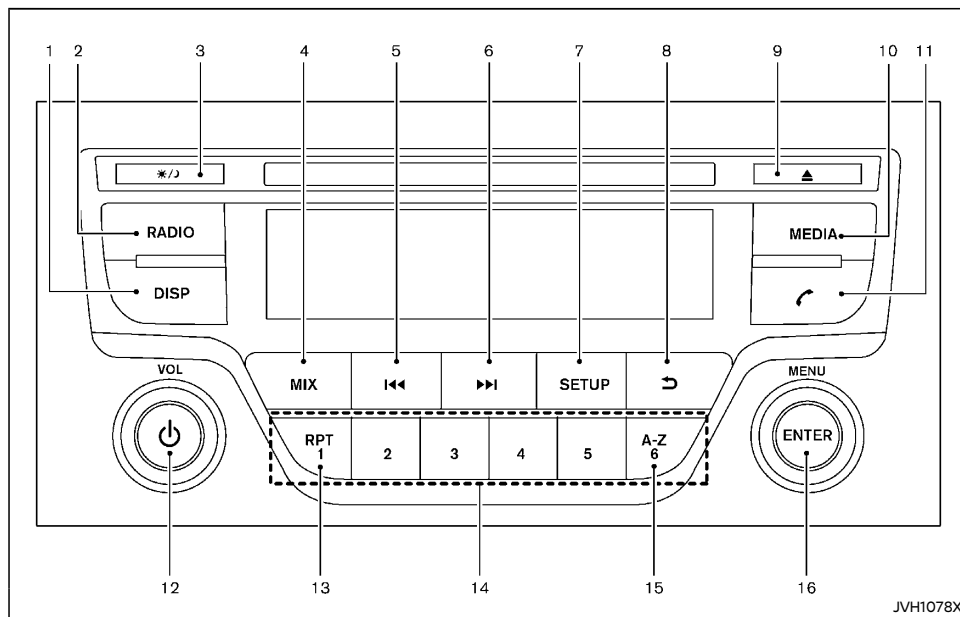

- |                                     |                             |
|-------------------------------------|-----------------------------|
| 1. DISP (Display) button            | 9. CD eject button          |
| 2. RADIO button                     | 10. MEDIA button            |
| 3. Day/Night button                 | 11. Phone button            |
| 4. MIX button                       | 12. Power/VOL (Volume) dial |
| 5. Seek/track (rewind) button       | 13. RPT (Repeat) button     |
| 6. Seek/track (fast forward) button | 14. Station memory buttons  |
| 7. SETUP button                     | 15. A-Z button              |
| 8. Back button                      | 16. MENU/ENTER dial         |

## Audio main operation

The audio system operates when the ignition switch is placed in the "ON" or "ACC" position.

### Power/VOL dial:

#### Power ON/OFF:

To turn on the audio system, push the Power/VOL dial.

The system will turn on in the mode, which was used immediately before the system was turned off.

To turn off the audio system, push the Power/VOL dial.

#### Volume control:

To control the volume, turn the Power/VOL dial.

Turn the Power/VOL dial clockwise to make the sound louder.

Turn the Power/VOL dial counterclockwise to make the sound quieter.

The audio unit is equipped with a speed volume. This means that the audio system automatically adjusts the volume level in relation to vehicle speed.

### SETUP button:

To configure Audio, Clock, Radio, or Language settings, perform the following procedure:

1. Push the SETUP button.
2. Turn the MENU/ENTER dial clockwise or counterclockwise, the display will appear in the following order.  
Audio ↔ Clock ↔ Radio ↔ Language
3. Push the MENU/ENTER dial to select the item.

After the desired levels have been set, push the Back button repeatedly or push the SETUP

button.

#### **Audio setting:**

Turn the MENU/ENTER dial until the Audio is displayed, and push the MENU/ENTER dial.

Turn the MENU/ENTER dial, and the mode will change as follows.

Sound ⇔ AUX In ⇔ Speed Vol. ⇔ Audio Default

Push the MENU/ENTER dial to select the setting you want to change. Turn the MENU/ENTER dial to adjust the selected item.

- **Sound:**

Bass:

Use this control to enhance or attenuate bass response sound.

Treble:

Use this control to enhance or attenuate the treble.

Bal. (Balance) :

Use this control to adjust the balance of the volume between the left and right speakers.

Fade:

Use this control to adjust the balance of the volume between the front and the rear speakers.

- **AUX In:**

Use this control to adjust the volume output from the auxiliary source.

- **Speed Vol. (Volume) :**

This mode controls the volume output from the speakers automatically in relation to vehicle speed.

Adjusting the setting to 0 (zero) turns off the speed volume feature.

- **Audio Default:**

The audio unit has a saved preset settings as a factory default. Select "Yes" to change

all settings back to the factory preset settings. Select "No" to exit the menu keeping the current settings.

#### **Clock setting:**

Turn the MENU/ENTER dial until the Clock is displayed, and push the MENU/ENTER dial.

Turn the MENU/ENTER dial, the mode will change as follows:

Set Time ⇔ ON/OFF ⇔ Format

- **Set Time**

Select "Set Time" then adjust the clock as follows:

The hour display will start flashing. Turn the MENU/ENTER dial to adjust the hour and push the MENU/ENTER dial. The minute display will start flashing. Turn the MENU/ENTER dial to adjust the minute and push the MENU/ENTER dial to finish the clock adjustment.

- **ON/OFF**

The clock display can be turned on and off. When the indicator is turned on, the clock will be displayed. (The clock will keep being displayed even after the power of the audio unit is turned off.) When the indicator is turned off, the clock will not be displayed.

- **Format**

Switch the clock display between 24-hour mode and 12-hour clock mode.

#### **Radio setting:**

Turn the MENU/ENTER dial until the Radio is displayed, and push the MENU/ENTER dial.

The FM station which can be received will be updated.

#### **Language setting:**

Turn the MENU/ENTER dial until the Language is displayed, and push the MENU/ENTER dial.

Select the appropriate language and push the MENU/ENTER dial. Upon completion, the screen will automatically adapt the language setting.



#### **Day/Night button:**

Push the Day/Night button to switch the display brightness between the daytime and nighttime modes.

The switches on the audio unit will also illuminate in the nighttime mode.



#### **Phone button:**

For information on how to use the phone button, see "Bluetooth® Hands-Free Phone System" (P.4-47).



#### **MEDIA button:**

Push the MEDIA button to play a compatible device when it is connected.

Each time the MEDIA button is pushed, the audio source will change.

CD → USB/iPod → BT (Bluetooth® audio) → AUX → CD

A source that is not available will be skipped.

## Radio operation

### Frequency range and step change:

To change the frequency range and step specification of the radio, perform the following operations.

1. Turn on the audio system.
2. Push the RADIO button and select AM or FM mode.
3. Push and hold the SETUP button for more than 3 seconds.
4. After the 3 seconds, keep holding the SETUP button and turn the MENU/ENTER dial counterclockwise until you hear 3 clicks, clockwise until you hear 3 clicks, and then counterclockwise until you hear 3 clicks.
5. Turn the MENU/ENTER dial until "Region" is highlighted, and push the MENU/ENTER dial.
6. Select an appropriate region from the following options:
  - EUR
  - Gom Pacific
  - Gom S. America
7. To apply the setting, turn off the audio system, place the ignition switch in the "OFF" position, and then place the ignition switch back in the "ON" position.

### **RADIO** RADIO button:



When the RADIO button is pushed while another audio source is playing, the other audio source will turn off and the radio will turn on.



To change the radio bands, push the RADIO button until the desired band appears.

FM 1 → FM 2 → AM → FM 1

When the RADIO button is pushed for more than 1.5 seconds, the FM station which can be received will be updated.

### Seek/track buttons:

Push  or  button briefly to manually change the frequency.





To adjust the broadcasting station frequency automatically, push and hold the  or  button. When the system detects a broadcasting station, it will stop at the station.

### Station memory buttons:

During radio reception, pushing the station memory button will select the stored radio station.

The audio system can store up to 12 FM station frequencies (6 in each of FM 1, FM 2) and 6 AM station frequencies.

To store the station frequency manually:

1. Tune to the desired broadcasting station frequency by using the  or  button.
2. Push and hold a station memory button  -  until a beep sounds.
3. The channel indicator will display, indicating that the memory is stored properly.
4. Perform steps 1 - 3 for all other memory buttons.

If the battery cable is disconnected, or if the audio fuse blows, the station memory will be erased. In such a case, reset the desired stations.

## CD player operation

### Loading:

Insert a CD into the slot with the label side facing up. The CD will be guided automatically into the slot and will start playing. After loading the CD, the number of tracks and the playtime will appear on the display.



### CAUTION:

**Do not force the CD into the slot. This could damage the player.**

### NOTE:

- The CD player accepts normal audio CDs or CDs containing MP3/WMA/AAC files.
- An error notification message will be displayed when inserting an incompatible disc type (e.g. DVD), or if the player cannot read the CD. Eject the disc and insert another disc.

### MEDIA button:

To change to the CD mode, push the MEDIA button with a CD inserted until the CD mode is selected.

### List view:



While the track is being played, push the MENU/ENTER dial to display the available tracks in a listed view mode. To select a track from the list, turn the MENU/ENTER dial then push MENU/ENTER dial.

### Quick search:





In the list view mode, a quick search can be performed to find a track from the list. Push the A-Z button, turn the MENU/ENTER dial to the first alphabetic letter of the song title and then push the MENU/ENTER dial. When found, a list

of the available songs will be displayed. Select, and push the MENU/ENTER dial to play the preferred track.



#### **Seek/track buttons:**

Push and hold the  or  button to fast forward or rewind through the track. When the button is released, the track will play at normal playing speed.

Track up/down:

Pushing the  or  button once, the track will skip forward to the next track or backward to the beginning of the current track. Push the  or  button more than once to skip through the tracks.

#### **Folder browsing:**

If the recorded media contains folders with music files, pushing the  or  button will play in sequence the tracks of each folder.

To select a preferred folder:

1. Push the MENU/ENTER dial or the Back button and a list of tracks in the current folder is displayed.
2. Push the Back button.
3. Turn the MENU/ENTER dial for the preferred folder.
4. Push the MENU/ENTER dial to access the folder. Push the MENU/ENTER dial again to start playing the first track or turn the MENU/ENTER dial, and push the MENU/ENTER dial to select another track.

If the selected folder contains sub folders, push the MENU/ENTER dial, a new screen with a list of sub folders will be displayed. Turn the MENU/ENTER dial for the sub folder then push the MENU/ENTER dial to select. Select the root folder item when songs are recorded addition-

ally in the root folder.

To return to the previous folder screen, push the Back button.

#### **RPT button:**

Push the RPT button and the current track will be played continuously.

#### **MIX button:**

Push the MIX button and all the tracks will be played in a random order.

#### **DISP button:**

While a CD with recorded music information tags (CD-text/ID3-text tags) is being played, the title of the played track is displayed when available.

When the DISP button is pushed repeatedly, further information about the track can be displayed along with the track title as follows:

Track time → Artist name → Album title → Track time

Track details:

Pushing and holding the DISP button will turn the display into a detailed overview. Push the Back button to return to the previous screen.

#### **CD eject button:**

When the CD eject button is pushed while the ignition switch is placed in the "ON" or "ACC" position, the CD will be ejected.

If a CD is ejected by pushing the CD eject button, and it is not taken out from the loading slot within 20 seconds, the CD will automatically be reloaded to the slot to protect the CD.

### USB (Universal Serial Bus) connection port



#### **USB device main operation:**

The USB connection port is located on the lower part of the instrument panel. See "USB (Universal Serial Bus) connection port" (P.4-38). Connect a USB memory device into the connection port. The USB memory device will be activated automatically.

Refer to your device manufacturer's owner information regarding the proper use and care of the device.

If the system has been turned off while the USB memory device was playing, pushing the Power/VOL dial will start the USB memory device.

The following operations are identical to the audio main operation of the Compact Disc (CD) operation. For details, see "CD player operation" (P.4-35).

- List view
- Quick search
-   (Seek/track)
- MIX (Random play)
- RPT (Repeat track)
- Folder browsing

#### **MEDIA button:**

To operate the USB memory device, push the MEDIA button repeatedly until the USB/iPod mode is selected.

#### **DISP button:**

While a track with recorded music information tags (ID3-tags) is being played, the title of the played track is displayed.

When the DISP button is pushed repeatedly,

further information about the track can be displayed along with the track title as follows:

Track time → Artist name → Album title → Track time

Track details:

Pushing and holding the DISP button will turn the display into a detailed overview. Push the Back button to return to the display for the main display mode.

## iPod player operation

### Connecting iPod:

Connect the iPod to the USB connection port using the USB cable that came with your iPod.

The USB connection port is located on the lower part of the instrument panel. See "USB (Universal Serial Bus) connection port" (P.4-38).

When the iPod is connected to the vehicle, the iPod music library can only be operated by the vehicle audio controls.

\* iPod and iPhone are a trademark of Apple Inc., registered in the U.S. and other countries.

Refer to your device manufacturer's owner information regarding the proper use and care of the device.

### Compatibility:

The system unit shall be compatible with all devices (past and future) supporting Apple Accessory Protocol on USB link.

It includes (and not limited to):

- iPod Generation 5 devices
- iPod Classic I and II (Generation 6 and 7)
- iTunes Generation OS 1, 2, 3, 4 and next
- iPhone Generation OS 1, 2, 3, 4 and next

- iPod Nano (1G, 2G, 3G)
- iPad 1, 2 and 3

### NOTE:

**This audio system do not support iPad charging.**

### MEDIA button:

To operate the iPod, push the MEDIA button repeatedly until the USB/iPod mode is selected and then push the MENU/ENTER dial.

### iPod main operation:

Interface:



The interface for iPod operation shown on the audio system display is similar to the iPod interface. Use the MENU/ENTER dial to play a track on the iPod.

The following items can be chosen from the menu list screen.

- Playlists
- Artists
- Albums
- Tracks
- More

For further information about each item, see the iPod owner's manual.

The following operations are identical to the audio main operation of the Compact Disc (CD) operation. For details, see "CD player operation" (P.4-35).

- List view
- Quick search
-   (Seek/track)
- MIX (Random play)

- RPT (Repeat track)
- Folder browsing

### DISP button:

While a track with recorded music information tags (ID3-tags) is being played, the title of the played track is displayed.

When the DISP button is pushed repeatedly, further information about the track can be displayed along with the track title as follows:

Track time → Artist name → Album title → Track time

Track details:

Pushing and holding the DISP button will turn the display into a detailed overview. To return to the main display, push the Back button.

## Bluetooth® audio player operation

### Regulatory information:



Bluetooth® is a trademark owned by Bluetooth SIG, Inc. and licensed to Visteon Corporation.

### CE statement:

Hereby Visteon Corp. declares that this system is in compliance with the essential requirements and other relevant provisions of Directive 1999/5/EC.



**NOTE:**

The audio system only supports Bluetooth® devices with AVRCP (Audio Video Remote Control Profile) version 1.3, or 1.0 or earlier.

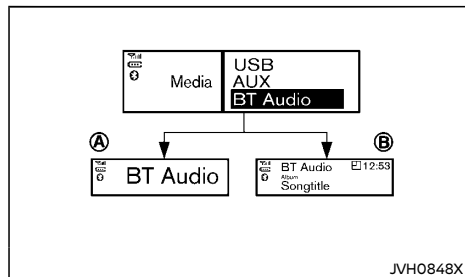
**Bluetooth® audio player main operation:**

To play Bluetooth® audio, the Bluetooth® audio device needs to be paired to the in-vehicle system. For the pairing operation, see "Pairing device" (P.4-48).

**MEDIA MEDIA button:**

To operate the Bluetooth® audio streaming use the following method:

Push the MEDIA button repeatedly until "BT Audio" is shown.

The type of display, (A) or (B), shown on the audio system can vary depending on the Bluetooth® version of the device.

**Seek/track buttons**

Push and hold the or button to fast forward or rewind through the track. When the button is released, the track will play at normal playing speed.

**Track up/down:**

Pushing the or button once, the track will skip forward to the next track or backward to the beginning of the current track. Push the or button more than once to skip through the tracks.

**DISP DISP button:**

If the song contains music information tags (ID3- tags), the title of the played song will be displayed. If tags are not provided then the display will not show any messages.

When the DISP button is pushed repeatedly further information about the song can be displayed along with the song title.

A long push on the DISP button will turn the display into a detailed overview which after a few seconds returns to the main display; or push the DISP button briefly.

**AUX device player operation**

The AUX input jack is located on the lower part of the instrument panel. See "AUX (auxiliary) input jack" (P.4-39). The AUX input jack accepts any standard analog audio input such as from a portable cassette tape/CD player, MP3 player or laptop computer.

NISSAN strongly recommends using a stereo mini plug cable when connecting your music device to the audio system. Music may not play properly when a monaural cable is used.

**WARNING:**

**Do not allow the cable or an external device connected to the AUX terminal to affect your driving.**

**NOTE:**

- Depending on the external device, please note that the volume may be louder or quieter than that of the external device.
- When the AUX contacts the plug of the connector cable, noise may be heard.
- The connected external device cannot be operated with the main audio system. The volume and sound quality can be adjusted.
- The song title in the external device cannot be displayed on the audio display.
- For the power source of the external device, use the special battery. The external device cannot be charged with the AUX terminal. Noise may be heard if the CD, radio etc. is operated while charging the battery with the power outlet of the vehicle.

**MEDIA MEDIA button:**

To change to the AUX mode, push the MEDIA button repeatedly until the AUX mode is selected.

**USB (Universal Serial Bus) CONNECTION PORT****WARNING:**

**Do not connect, disconnect or operate the USB device while driving. Doing so can be a distraction. If distracted you could lose control of your vehicle and cause an accident or serious injury.**





### CAUTION:

- Do not force the USB device into the USB connection port. Inserting the USB device tilted or up-side-down into the port may damage the port. Make sure that the USB device is connected correctly into the USB connection port.
- Do not grab the USB connection port cover (if equipped) when pulling the USB device out of the port. This could damage the port and the cover.
- Do not leave the USB cable in a place where it can be pulled unintentionally. Pulling the cable may damage the port.

Refer to your device manufacturer's owner information regarding the proper use and care of the device.

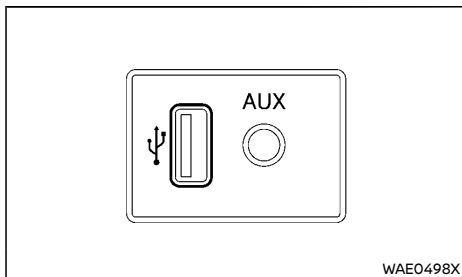

Example

The USB connection port is located on the lower part of the instrument panel. Insert USB devices or iPod connectors into this port.

### AUX (auxiliary) INPUT JACK

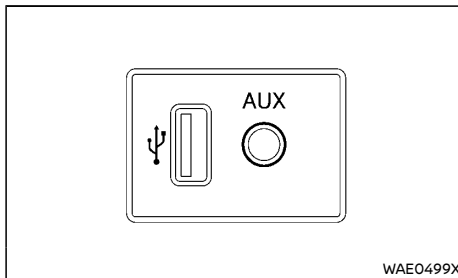

Example

The AUX input jack is located on the lower part of the instrument panel. Compatible audio devices, such as some MP3 players, can be connected to the system through the AUX input jack.

Before connecting a device to a jack, turn off the power of the portable device.

With a compatible device connected to the jack, push the corresponding button (depends on the audio system) repeatedly until the display switches to the AUX mode.

NISSAN strongly recommends using a stereo mini plug cable when connecting your music device to the audio system. Music may not play properly when a monaural cable is used.

### CD/USB MEMORY CARE AND CLEANING

#### CD

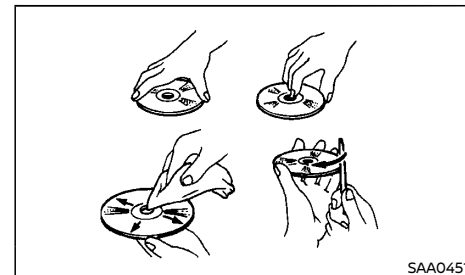

SAA0451

- Handle a disc by its edges. Never touch the surface of the disc. Do not bend the disc.
- Always place the discs in the storage case when they are not being used.
- To clean a disc, wipe the surface from the center to the outer edge using a clean, soft cloth. Do not wipe the disc using a circular motion.  
Do not use a conventional record cleaner or alcohol intended for industrial use.
- A new disc may be rough on the inner and outer edges. Remove the rough edges by rubbing the inner and outer edges with the side of a pen or pencil as illustrated.

#### USB memory

- Do not place heavy objects on the USB memory.
- Do not store the USB memory in highly humid locations.
- Do not expose the USB memory to direct sunlight.

- Do not spill any liquids on the USB memory. Refer to the USB memory Owner's Manual for details.

### AUDIO CONTROL STEERING SWITCH (if equipped)

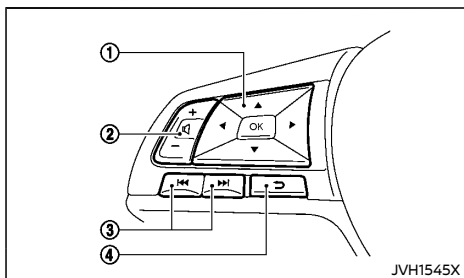

- Menu control buttons/OK button
- Volume control buttons
- Tuning buttons
- Back button

#### Menu control buttons/OK button

Push the ◀ / ▶ buttons and switch the vehicle information display to audio mode. Push the OK button until the preferred available audio source is selected.

#### Volume control buttons

Push the + or - button to increase or decrease the volume.

#### ▶▶ / ◀◀ Tuning buttons

Push the ▶▶ / ◀◀ buttons to select a station or track.

Depending on the status of the vehicle information display, the tuning buttons cannot be used for audio control.

#### RADIO:

- Pushing ▶▶ / ◀◀ shorter Next or previous preset station
- Pushing ▶▶ / ◀◀ longer Next or previous station

#### CD, iPod, USB device or Bluetooth® audio:

- Pushing ▶▶ / ◀◀ shorter Next track or the beginning of the current track (the previous track if the button is pushed immediately after the current track starts playing)
- Pushing ▶▶ / ◀◀ longer Forward or rewind

#### ↶ Back button

Push the Back button to return to the previous screen or cancel the current selection.

## REAR ENTERTAINMENT SYSTEM (RES) (if equipped)

If your vehicle is equipped with the Rear Entertainment System (RES), you can enjoy images and sound from a compatible HDMI-connected device (such as video games, PC, smartphones, etc.) in the vehicle. The images can be projected on the roof-mounted rear display while the audio is playing through the in-vehicle speakers.

Start the engine before using the Rear Entertainment System. When the ignition switch is placed in the "OFF" position, the power of the Rear Entertainment System also turns off.

#### ⚠ WARNING:

**The driver must not attempt to operate the Rear Entertainment System while driving so full attention may be given to vehicle operation.**

#### ⚠ CAUTION:

- Do not attempt to use the system in extremely high or low temperature condition [below -20°C (-4°F) or above 70°C (158°F)].
- To avoid draining the vehicle battery, do not operate the system for more than 15 minutes without starting the engine.
- Do not allow the system to get wet. Excessive moisture such as spilled liquids may cause the system to malfunction.
- Do not disassemble or modify the unit. Doing so may cause an accident, fire, electric shock, and/or malfunction.
- Do not use the unit when it is malfunctioning or in an abnormal condition. Doing so may cause a fire or electric shock.

## NOTE:

In some countries, movies cannot be played in the vehicle at any time for regulatory reasons, regardless of whether the vehicle is parked or in motion.

## TECHNICAL INFORMATION

### License

#### HDMI:

The terms HDMI and HDMI High-Definition Multimedia Interface, and the HDMI Logo are trademarks or registered trademarks of HDMI Licensing Administrator, Inc. in the United States and other countries.

#### For Thailand

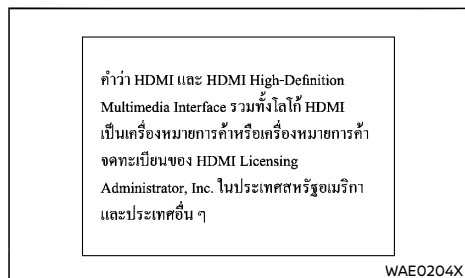

#### For the Middle East

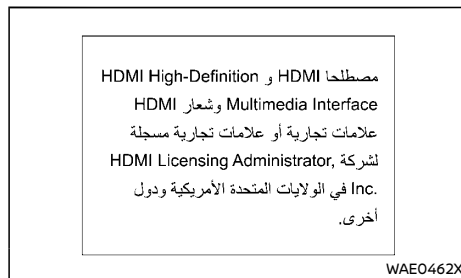

## SYSTEM COMPONENTS

### Rear display



#### CAUTION:

- The glass screen on the liquid crystal display may break if hit with a hard or sharp object. If the glass breaks, do not touch the liquid crystalline material. In case of contact with skin, wash immediately with soap and water.
- Use soft, damp cloth when cleaning the Rear Entertainment System components. Do not use solvents or cleaning solutions.
- If the display is left open, it may unexpectedly contact a body part of a passenger, resulting in an injury. Also, if a strong force is applied, it may result in a malfunction. Close the display when it is not being used.

The rear display is located on the ceiling.

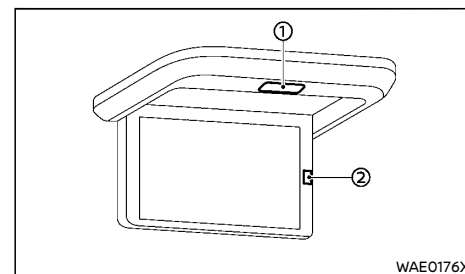

#### Rear display (flip-down type)

- ① OPEN button
- ② Remote controller light sensor

#### Opening the display:

1. Push the OPEN button ①. The display will open slightly.

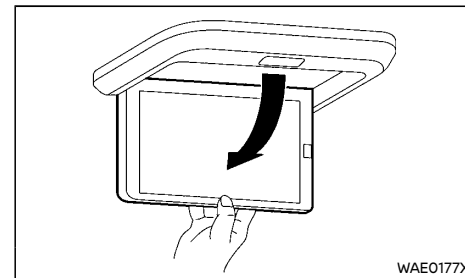

2. Hold the center of the lower part of the display by hand, gently pull it down in the direction of the arrow as illustrated, and open until it locks in place.

### Closing the display:

Hold the center of the lower part of the display and push it up until a locking sound occurs and it locks in place.

### Turning the display on/off:

The power of the display can be turned on/off using the remote controller. See "Remote controller" (P.4-42).

To use the remote controller, do not block the range between the remote controller and the remote controller light sensor ②.

#### NOTE:

- When opening/closing the display, hold the center of the lower part of the display outer frame. Directly holding or pushing the display may cause a display error and/or deterioration of the display.
- Do not strongly push the edge of the display. If the edge of the display is strongly pushed, circular patterns may appear on the display. These are inherent symptoms to any liquid crystal display and should not be considered a malfunction.

### HDMI port

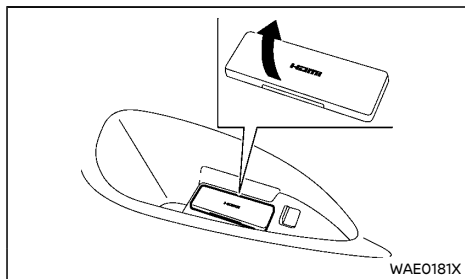

The HDMI port is located by the soft bottle holder on the left side of the third row seat. Open the lid as illustrated and connect a compatible device to the HDMI port. The images from the connected device can be viewed on the rear display.

#### NOTE:

- Do not apply strong pressure to any portable device or cable that is connected to the HDMI port. It could damage the device and the port.
- Depending on the HDMI-connected device, the full image may not fit into the screen of the rear display or some extra margin may appear around the image. It is due to the characteristics or the settings of the connected device and is not a malfunction.
- Depending on the HDMI-connected device, the image output setting may not be switched automatically to display the image on the rear display. In that case, change the image output setting of the connected device according to the instruction manual of the connected device.

### Remote controller



#### CAUTION:

Never heat, disassemble, or put the remote controller into fire or water. Doing so may cause an explosion of or leakage from the battery, resulting in a fire or an injury.

Operate the remote controller toward the rear display.

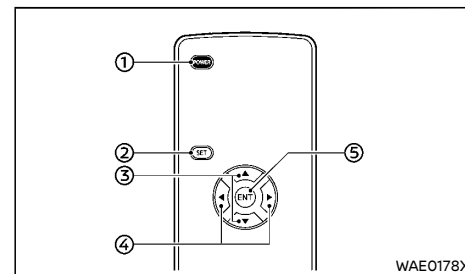

#### ① POWER button

Use this button to turn the Rear Entertainment System on/off when the rear display is open.

#### ② SET button

Use this button to show the Display Menu for adjusting image quality and switching the screen mode. See "Display settings" (P.4-44)

#### ③ ▲ / ▼ button

Use this button to select the setting items in the Display Menu.

#### ④ ◀ / ▶ button

Use this button to make adjustments to the item selected in the Display Menu.

#### ⑤ ENT button

Use this button to confirm the adjustments and close the Display Menu.

#### Operating tips:

- To operate the rear display, operate the remote controller with its light-emitting area facing toward the remote controller light sensor of the rear display.
- If the remote controller light sensor is exposed to direct sunshine, the unit may not be operated with the remote controller.

In such a case, block the sunshine before operating.

- Do not leave the remote controller on the dashboard under direct sunshine or other locations where temperature is high. Doing so may result in deformation of the unit, leakage from the battery, or other malfunctions.
- When you do not use the remote controller for 1 month or longer, remove the battery from the remote controller to prevent leakage. If leakage occurs, wipe the liquid off and exchange the battery.
- When the transmitting distance of the remote controller becomes short or when the operable range becomes narrow, replace the battery.

#### Remote controller battery replacement:



#### CAUTION:

- Only use a battery designated for the remote controller. When installing, be careful with the polarity of the battery (⊕ pole and ⊖ pole). Install according to the instructions. Failure to observe the instructions may cause an explosion of or leakage from the battery, resulting in an injury and/or pollution of the surrounding areas.
- Dispose of used batteries at specified places according to the specified method.
- Never leave the battery for the remote controller in a place within the reach of infants and small children. They may swallow the battery. If an infant or child swallows the battery, immediately contact a doctor.

- **When changing batteries, do not let dust or oil get on the components.**

To replace the battery:

1. Open the battery tray as illustrated. (To open the tray, insert a pin or a paper clip into a pinhole on the battery tray.)

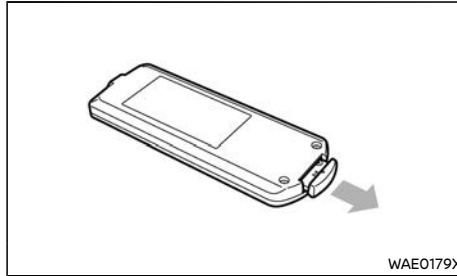

2. Replace the battery with a new lithium battery (CR2025). Ensure that the ⊕ side of the battery is facing upward.

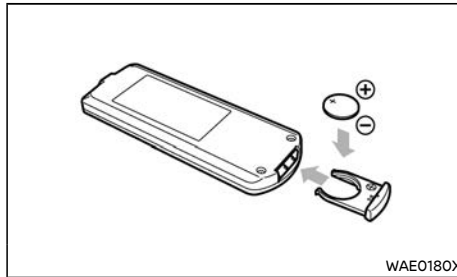

3. Close the battery tray securely.

#### SOUND SETTING

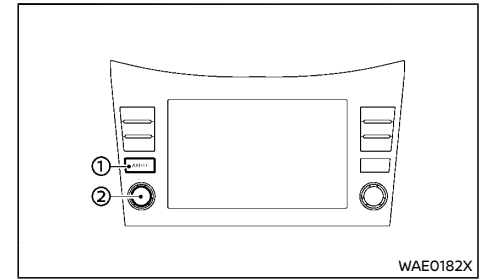

Type A

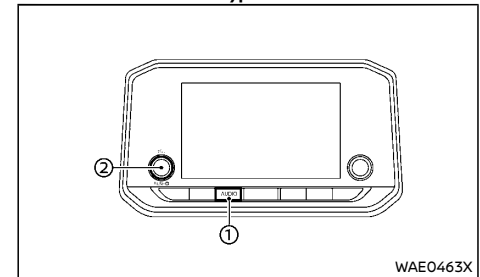

Type B

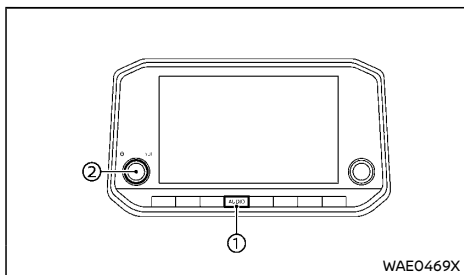

Type C

Sound setting can be operated on the Nissan-Connect System. Refer to the NissanConnect Owner's Manual.

### Selecting audio source

1. Push the AUDIO button ① multiple times until the audio source selection screen is displayed.
2. Touch the "Rear Display" key. The HDMI-connected device is selected as an audio source.

### Adjusting volume

Turn the VOL dial ② to adjust the volume.

### DISPLAY SETTINGS

Display settings of the rear display can be changed using the remote controller.

1. Push the SET button of the remote controller. The Display Menu screen will appear on the rear display.
2. Select an item that you want to adjust using the ▲ / ▼ button, and make an adjustment using the ◀ / ▶ button.
3. Pushing the SET or ENT button ends the adjustment and closes the Display Menu

screen.

Available setting items:

- **Brightness**  
The brightness of the screen can be adjusted.
- **Color Tone**  
The color tone of the screen can be adjusted.
- **Color Depth**  
The color depth of the screen can be adjusted.
- **Contrast**  
The contrast of the screen can be adjusted.
- **Black Level**  
The black level of the screen can be adjusted.
- **Display Mode**  
The display mode can be switched among Normal, Wide, Cinema, and Full.

### NOTE:

- **If no operation is performed for a certain period of time (approximately 5 seconds), the Display Menu screen will disappear, but the set values will be stored.**
- **Push the SET button or ENT button to immediately exit the Display Menu screen.**

## TROUBLESHOOTING GUIDE

Symptom	Cause and Countermeasure
No image is shown	The engine is turned off. Turn the engine on.
	The power of the rear display is turned off. Hold the remote controller toward the rear display and push the POWER button to turn on the display.
No sound output	The audio is turned off. Turn the audio on. Select the "Rear Display" key on the audio source selection screen. Turn the VOL button to adjust the volume.
The color is too light	The color depth is set to a light level. Adjust color depth.
The screen is too dark or pale	Brightness, contrast, and/or black level are not adjusted correctly. Adjust brightness, contrast, and/or black level.
The rear display always has dots with the same color or black	There may be small dark or bright dots on the display. These are inherent symptoms to any liquid crystal display and should not be considered a malfunction.
When the power is turned on under a low temperature, the screen is dark and hard to see	This is due to the characteristics of the liquid crystal display. This is not a malfunction.
The display cannot be operated with the remote controller	The remote controller light sensor by the rear display is dirty. Remove the dirt on the remote controller light sensor using a soft cloth.
	The rear display is closed. Open the rear display.
	The battery of the remote controller is dead. Exchange the battery.

### NOTE:

Consult a NISSAN dealer if malfunction occurs. Repairing or removing the unit by yourself may worsen the problem.

## ANTENNA

### ROD ANTENNA (if equipped)

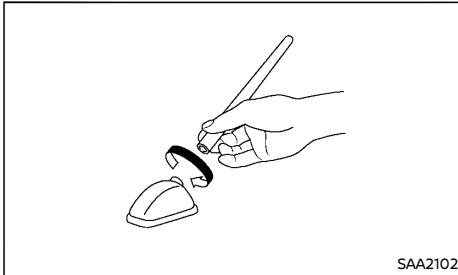

The antenna can be removed if necessary.

Hold the bottom of the antenna and remove by turning counterclockwise.

To install the antenna, turn the antenna clockwise and tighten.



#### CAUTION:

To avoid damaging or deforming the antenna, be sure to remove the antenna under the following conditions.

- The vehicle enters an automatic car wash.
- The vehicle enters a garage with a low ceiling.
- The vehicle is covered with a car cover.

### SHARK FIN ANTENNA (if equipped)

The shark fin antenna is located on the rear part of the vehicle roof.



#### CAUTION:

- A build up of ice on the shark fin antenna can affect radio performance. Remove the ice to restore radio reception.
- When removing snow from the roof, do not apply strong force to the shark fin antenna. That may cause broken shark fin antenna and roof panel dent.
- When using a high pressure car wash, keep the high pressure nozzle away from the shark fin antenna. The seal may be deformed or damaged.
- The radio performance may be affected if cargo carried on the roof blocks the radio signal. If possible, do not put cargo near the shark fin antenna.

## CAR PHONE AND CB RADIO

When installing a CB, ham radio or a car phone in your vehicle, be sure to observe the following cautions, otherwise the new equipment may adversely affect the Engine Control System and other electronic parts.



#### CAUTION:

- Keep the antenna as far away as possible from the Electronic Control Module.
- Keep the antenna wire at least 20 cm (8 in) away from the Engine Control harnesses. Do not route the antenna wire next to any harnesses.
- Adjust the antenna standing wave ratio as recommended by the manufacturer.
- Connect the ground wire from the radio chassis to the body.
- For details, consult a NISSAN dealer.



## Bluetooth® HANDS-FREE PHONE SYSTEM (if equipped)



### WARNING:

- Use a phone after stopping your vehicle in a safe location. If you have to use a phone while driving, exercise extreme caution at all times so full attention may be given to vehicle operation.
- If you find yourself unable to devote full attention to vehicle operation while using the phone, pull off the road to a safe location and stop your vehicle before doing so.



### CAUTION:

To avoid draining the vehicle battery, use a phone after starting the engine.

Bluetooth® is a wireless radio communication standard. This system offers a hands-free facility for your cellular phone to enhance driving comfort.

To use the Bluetooth® Hands-Free Phone System, your cellular phone must first be setup. For details, see "Bluetooth® settings" (P.4-48). Once it has been setup, the hands-free mode is automatically activated on the registered cellular phone (via Bluetooth®) when it comes into range.

A notification message appears on the audio display when the phone is connected, when an incoming call is being received, as well as when a call is initiated.

When a call is active, the audio unit mounted control buttons, microphone, and steering wheel mounted control buttons (if equipped) enable hands-free communication.

If the audio system is in use at the time, the radio, CD, iPod, USB audio, Bluetooth® audio or AUX source mode will be muted and will stay

muted until the active call has ended.

The Bluetooth® system may not be able to connect with your cellular phone for the following reasons:

- The cellular phone is too far away from the vehicle.
- The Bluetooth® mode on your cellular phone has not been activated.
- Your cellular phone has not been paired with the Bluetooth® system of the audio unit.
- The cellular phone does not support Bluetooth® technology.

### NOTE:

- For details, see your cellular phone's Owner's Manual.
- For assistance with your cellular phone integration, please visit your local NISSAN dealer.

## REGULATORY INFORMATION

### Bluetooth® trademark



Bluetooth® is a trademark owned by Bluetooth SIG, Inc. and licensed to Visteon Corporation.

### CE statement

Hereby Visteon Corp. declares that this system is in compliance with the essential requirements and other relevant provisions of Directive 1999/5/EC.



### NOTE:



The audio system only supports Bluetooth® devices with AVRCP (Audio Video Remote Control Profile) version 1.3, or 1.0 or earlier.

## CONTROL BUTTONS AND MICROPHONE

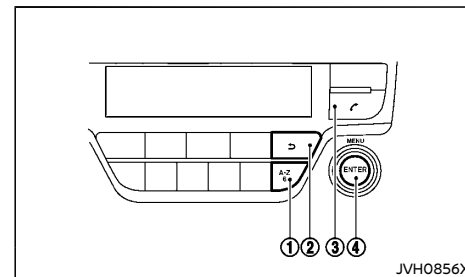
### Audio unit:





1. A-Z button

2. Back  button
3. Phone  button
4. MENU/ENTER dial

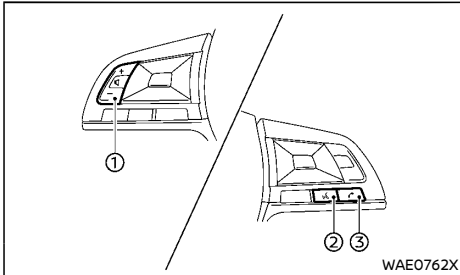
**Steering wheel mounted control (if equipped):**



1. Volume control buttons  
Push the buttons to increase or decrease the volume of the speakers.
2. Phone send  button
  - Accept an incoming call by pushing once.
  - Redial the last outgoing call by pushing the button for more than 2 seconds.
3. Phone end  button
  - Reject an incoming call by pushing the button during an incoming call.
  - End an active call by pushing the button once.

**Microphone:**



Microphone is located near the map lights.

**Bluetooth® SETTINGS**

**Pairing device**

Enter the phone setup menu via the  button on the audio unit, select the "Bluetooth" key, and then check if the Bluetooth® is set to on. (If not, push the MENU/ENTER dial to turn it on.)

To setup the Bluetooth® system to pair (connect or register) your preferred cellular phone, follow the following procedure.

1. To pair a device, select the "Scan devices" key or the "Pair device" key on the display.
  2. A notification message will be displayed when the phone is successfully paired.
  3. The display will return to the current audio source status after the connection is complete.
- While the Bluetooth® connection is active, the following icons will appear on the display.
    -  : Signal strength indicator
    -  : Battery status indicator\*
    -  : Bluetooth® connection ON indicator

\*: If low battery is indicated, the Bluetooth® device must be recharged soon.
  - Up to 5 different Bluetooth® devices can be connected. However, only one device can be used at a time. If 5 different Bluetooth® devices are registered, a new device can only replace one of the 5 existing paired devices.
  - The pairing procedure and operation may vary according to device type and compatibility. See the Bluetooth® device Owner's Manual for further details.

**Setting items**

To set up the Bluetooth® system with a device, the following items are available:

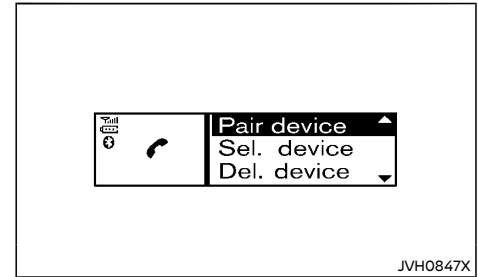

- Scan devices  
Shows all available visible Bluetooth® devices and initializes Bluetooth® connection from the audio unit.
- Pair device  
Initializes Bluetooth® connection from the mobile device.
- Sel. device  
Paired Bluetooth® devices are listed and can be selected for connection.
- Del. device  
A registered Bluetooth® device can be deleted.
- Bluetooth  
If this setting is turned off, the connection between the Bluetooth® devices and the in-vehicle Bluetooth® module will be cancelled.

### Scan devices:

1. Push the  button on the audio unit. Select "Scan devices" key. The audio unit searches for the Bluetooth® devices and shows all devices that were found.

Make sure your Bluetooth® device is available at this time.

2. Select the device to be paired using the MENU/ENTER dial.
3. The pairing procedure depends on the device to be connected:

#### a. Device without PIN code:

The Bluetooth® connection will be automatically connected without any further input.

#### b. Device with PIN code:

Two different ways of pairing are possible depending on the device:

##### • Type A:

The message "To pair" and "Enter Pin" 0000 will be displayed.

Confirm the PIN code on the device. The Bluetooth® connection will be made.

##### • Type B:

The message "Pairing request" and "Confirm password" together with a 6 digit code will be displayed. The unique and identical code should be displayed on the device. If the code is identical confirm on the device.

The Bluetooth® connection will be made.

### Pair device:



- Turn on the Bluetooth® on the audio unit. See "Bluetooth" (P.4-49).
- Use the audio unit to pair:  
Push the  button on the audio unit. Select the "Pair device" key.  
The pairing procedure depends on the Bluetooth® device to be connected:
  - 1) Device without PIN code:  
The Bluetooth® connection will be automatically connected without any further input.
  - 2) Device with PIN code:  
Two different ways of pairing are possible depending on the device. For the correct procedure details, see "Scan devices" (P.4-49).
- Use the Bluetooth® audio/cellular phone device to pair:
  - 1) Switch on the search mode for Bluetooth® devices.  
If the search mode finds the audio unit it will be shown on the device display.
  - 2) Select the unit device shown as "My Car".
  - 3) Enter the number code shown on the relevant device with the device's own keypad, and push the confirmation key on the Bluetooth® device.

Refer to the relevant Bluetooth® device Owner's Manual for further details.

### Sel. device:

The paired device list shows which Bluetooth® audio or cellular phone devices have been paired or registered to the system. Select the appropriate device to connect to the system.

The following icons (if equipped) indicate the capability of the registered device:

-  : Cellular phone integration
-  : Audio streaming (A2DP - Advanced Audio Distribution Profile)



### Del. device:

A registered device can be removed from Bluetooth® system registration. Select a registered device and push the MENU/ENTER dial to confirm to deletion.

### Bluetooth:

If Bluetooth® signal has been turned off, a notification message "ON/OFF" appears when you select "Bluetooth" from the phone menu. (Push the  button on the audio unit to display the phone menu.) To turn the Bluetooth® signal on, push the MENU/ENTER dial and a follow up screen will appear. Select "ON" and push the MENU/ENTER dial to display the Bluetooth® settings menu screen.



### USING THE SYSTEM

The hands-free mode can be operated using the  button on the audio unit or the  button (if equipped) on the steering wheel.





### Receiving a call

When receiving an incoming call, the display on the audio unit will show the caller's phone number (or a notification message that the caller's phone number cannot be shown) and operation icons. To highlight different icons, turn the MENU/ENTER dial. Push the MENU/ENTER dial to select the highlighted icon.



### Answering a call and during a call:

Answer the call by selecting the  icon or by pushing the  button (if equipped) on the steering wheel.



During the call, the following icons are available:

- : Select this item to end the call.
- : Select this item to put the call on hold.
- : Select this item to transfer the call from the hands-free phone system to your cellular phone.
- : Select this item to transfer the call back to the hands-free phone system from the cellular phone.
- #123: Select this item to enter numbers during a call. For example, use this function when directed by an automated phone system to dial an extension number.
- : Select this item to switch the call on line between the first and the second call. See "Second incoming call" (P.4-51).

#### Putting a call on hold:

To put a call on hold, select the  icon. Select the  icon to return to the call. To end the call, select the  icon.

#### Rejecting a call:

To reject an incoming call, select the  icon or push the  button (if equipped) on the steering wheel.

#### Making a call



#### WARNING:

**Park the vehicle in a safe location, and apply the parking brake before making a call.**

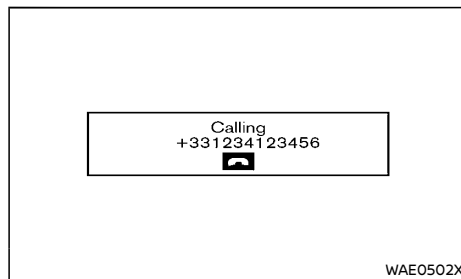

A call can be initiated using one of the following methods:

- Making a call from the phonebook
- Manually dialing a phone number
- Redialing
- Using call history (Call List menu)
  - Dialed
  - Received
  - Missed

#### Making a call from the phonebook:

Once the Bluetooth® connection has been made between the registered cellular phone and the hands-free phone system, phonebook data will be transferred automatically to the hands-free phone system. The transfer may take a while before completion.



#### NOTE:

**Phonebook data will be erased when:**

- Switching to another registered cellular phone.
- Cellular phone is disconnected.
- The registered cellular phone is deleted from the audio system.

1. Push the  button on the audio unit.
2. Turn the MENU/ENTER dial to highlight "Phonebook" and push the MENU/ENTER dial.
3. Scroll down through the list, select the appropriate contact name (highlighted), and push the MENU/ENTER dial.
4. The screen will show the number to be dialed. Push the MENU/ENTER dial to dial the number.

If more than one number is registered, select an appropriate icon.

-  : Home
-  : Cellular phone
-  : Office

#### Quick searching the phonebook:

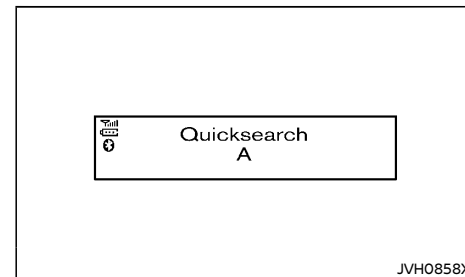

The quick search mode can be used as follows:

1. Push the A-Z button.
2. Turn the MENU/ENTER dial for the first alphabetic or numerical letter of the contact name. Once highlighted, push the MENU/ENTER dial to select the letter.
3. The display will show the corresponding contact name(s). Where necessary, use the MENU/ENTER dial to scroll further for the appropriate contact name to call.
4. The screen will show the number to be dialed. Push the MENU/ENTER dial to dial the number.

#### Manually dialing a phone number:

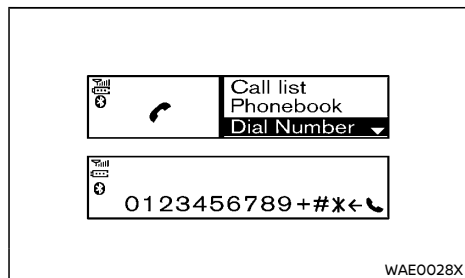

To dial a phone number manually, perform the following operation:

1. Push the button on the audio unit and turn the MENU/ENTER dial to highlight "Dial Number".
2. Push the MENU/ENTER dial to select "Dial Number".
3. Turn the MENU/ENTER dial to scroll along and highlight each number of the phone number. Push the MENU/ENTER dial to select the highlighted number.

To delete the last number entered, scroll to

the "←" (Backspace symbol) and once highlighted, push the MENU/ENTER dial. The last number will be deleted. Pushing the MENU/ENTER dial repeatedly will delete each subsequent number.

4. After entering the last number, highlight the icon and push the MENU/ENTER dial to dial the number.

#### Redial:

To call the last number dialed, push and hold the button on the audio unit or the button (if equipped) on the steering wheel for more than 2 seconds.

#### Using call history (Call list menu):

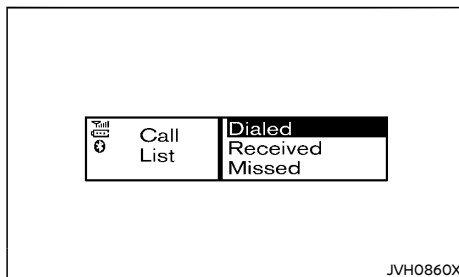

A number from the dialed, received, or missed call lists can also be used to make a call.

1. Push the button on the audio unit and select "Call List" on the display.
2. Turn the MENU/ENTER dial and scroll to an item, and push the MENU/ENTER dial to select an item.

#### Available items:

- Dialed

Use the dialed call mode to make a call which is based on the list of outgoing

(dialed) calls.

- Received

Use the received call mode to make a call which is based on the list of received calls.

- Missed

Use the missed call mode to make a call which is based on the list of missed calls.

3. Scroll to the preferred phone number and push the MENU/ENTER dial, the button on the audio unit.

#### Second incoming call

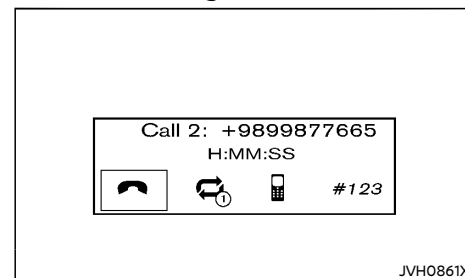



#### Example

Whenever there is a second incoming call, an indication is shown on the display. By selecting the icon the call is accepted and the current call is put on hold.

Selecting the icon using the MENU/ENTER dial rejects the second incoming call. When this is done during the conversation it ends the call.

Selecting the icon using the MENU/ENTER dial switches the call on line between the first and the second call.

## Ending a call

To end an active call, highlight the  icon and push the ENTER/MENU dial or push the  button (if equipped) on the steering wheel.

## GENERAL SETTINGS

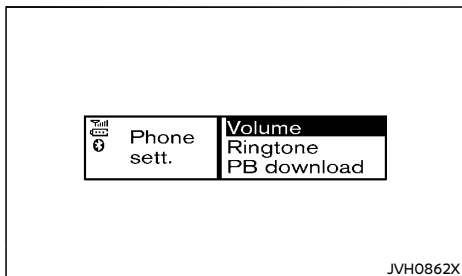

Using the MENU/ENTER dial, highlight "Settings" from the phone menu and push the MENU/ENTER dial.

Volume settings and manually downloading the phonebook can be done using this menu.

### Menu operation:

Turn the MENU/ENTER dial to change the highlighted item and to change the volume settings.

Push the MENU/ENTER dial to select the highlighted item and to apply the setting.

### Menu items:

- Volume
  - Ring  
Set the phone ringing volume.
  - Call  
Set the volume of the conversation during a call.

- Ringtone
  - Car  
Switch the ringtone to ring from the vehicle or the cellular phone.
  - Phone  
Switch the phone ringing volume on or off.
- PB download  
Download the phonebook of the mobile device to the audio unit manually.

# 5 Starting and driving

Break-in schedule .....	5-4	Starting engine (models with Intelligent Key system) .....	5-14
Before starting engine .....	5-4	Driving vehicle .....	5-15
Precautions when starting and driving .....	5-4	Driving with Automatic Transmission (AT) .....	5-15
Exhaust gas (carbon monoxide) .....	5-5	Driving with Manual Transmission (MT) .....	5-18
Three-way catalyst (if equipped) .....	5-5	Four-Wheel Drive (4WD) (if equipped) .....	5-19
Tire Pressure Monitoring System (TPMS) (if equipped) .....	5-5	Part time 4WD system .....	5-20
Turbocharger system (if equipped) .....	5-8	4WD mode switch operation .....	5-22
On-pavement and off-road driving precautions .....	5-8	4WD mode indicator .....	5-23
Driving safety precautions .....	5-8	4WD warning .....	5-23
Care when driving .....	5-9	Tire recommendation for 4WD .....	5-24
Engine cold start period .....	5-9	Drive Mode Selector switch (if equipped) .....	5-25
Loading luggage .....	5-9	SAND mode (selectable when 4WD mode is 4H) ....	5-26
Driving in wet conditions .....	5-9	SPORT mode (selectable when 4WD mode is 2WD or 4H) .....	5-26
Driving in winter conditions .....	5-10	STANDARD mode (selectable when 4WD mode is 2WD or 4H or 4LO) .....	5-26
Ignition switch (models without Intelligent Key system) .....	5-10	ECO mode (selectable when 4WD mode is 2WD) .....	5-26
Manual Transmission (MT) .....	5-10	Rear differential locking system (if equipped) .....	5-26
Automatic Transmission (AT) .....	5-10	Vehicle Dynamic Control (VDC) system (if equipped) .....	5-27
Key positions .....	5-11	Vehicle Dynamic Control (VDC) OFF switch .....	5-28
Push-button ignition switch (models with Intelligent Key system) .....	5-11	Hill descent control system (if equipped) .....	5-28
Precautions on push-button ignition switch operation .....	5-11	Hill descent control switch .....	5-29
Intelligent Key system .....	5-11	Hill start assist system (if equipped) .....	5-29
Automatic Transmission (AT) .....	5-12	Lane Departure Warning (LDW) (if equipped) .....	5-30
Steering lock .....	5-12	LDW system operation .....	5-31
Ignition switch positions .....	5-12	How to enable/disable the LDW system .....	5-32
Intelligent Key battery discharge .....	5-13	LDW system limitations .....	5-32
Starting engine (models without Intelligent Key system) .....	5-14	System temporarily unavailable .....	5-33

System malfunction .....	5-33	Intelligent Forward Collision Warning system (if equipped) .....	5-68
System maintenance .....	5-34	Intelligent Forward Collision Warning system operation .....	5-68
Blind Spot Warning (BSW) (if equipped) .....	5-34	Turning the Intelligent Forward Collision Warning system ON/OFF .....	5-70
BSW system operation .....	5-35	Intelligent Forward Collision Warning system limitations .....	5-70
How to enable/disable the BSW system .....	5-36	System temporarily unavailable .....	5-73
BSW system limitations .....	5-36	System malfunction .....	5-74
BSW driving situations .....	5-37	System maintenance .....	5-74
System temporarily unavailable .....	5-39	Intelligent Driver Alertness (if equipped) .....	5-74
System malfunction .....	5-39	Intelligent Driver Alertness system operation .....	5-75
System maintenance .....	5-39	How to enable/disable the Intelligent Driver Alertness system .....	5-75
Rear Cross Traffic Alert (RCTA) (if equipped) .....	5-40	Intelligent Driver Alertness system limitations .....	5-76
RCTA system operation .....	5-41	System malfunction .....	5-76
How to enable/disable the RCTA system .....	5-42	ECO drive report (if equipped) .....	5-76
RCTA system limitations .....	5-43	Fuel Efficiency and Carbon Dioxide Reduction driving tips .....	5-77
System temporarily unavailable .....	5-44	Increasing fuel economy and reducing Carbon Dioxide emissions .....	5-77
System malfunction .....	5-45	Parking .....	5-78
System maintenance .....	5-45	Parking sensor (sonar) system (if equipped) .....	5-79
Cruise control (if equipped) .....	5-45	Parking sensor (sonar) indicator (if equipped) .....	5-80
Precautions on cruise control .....	5-46	Parking sensor (sonar) system switch .....	5-81
Cruise control operations .....	5-46	Parking sensor (sonar) system setting (if equipped) .....	5-81
Intelligent Cruise Control (ICC) (if equipped) .....	5-47	Trailer towing (except for South Africa) .....	5-82
How to select the cruise control mode .....	5-49	Trailer towing (for South Africa) .....	5-82
Vehicle-to-vehicle distance control mode .....	5-49	Operating precautions .....	5-82
Conventional (fixed speed) cruise control mode .....	5-58	Maximum load limits .....	5-82
Intelligent Emergency Braking (if equipped) .....	5-61	Tyre pressure .....	5-83
Intelligent Emergency Braking system operation .....	5-62	Safety chains .....	5-83
Turning the Intelligent Emergency Braking system ON/OFF .....	5-63		
Intelligent Emergency Braking system limitations .....	5-64		
System temporarily unavailable .....	5-66		
System malfunction .....	5-67		
System maintenance .....	5-67		



Trailer brakes .....	5-83
Trailer detection (if equipped) .....	5-83
Power steering .....	5-84
Brake system .....	5-84
Brake precautions .....	5-84
Brake assist .....	5-84
Anti-lock Braking System (ABS) .....	5-84
Vehicle security .....	5-85

Cold weather driving .....	5-86
Battery .....	5-86
Engine coolant .....	5-86
Tire equipment .....	5-86
Special winter equipment .....	5-86
Parking brake .....	5-86
Corrosion protection .....	5-87

## BREAK-IN SCHEDULE

During the first 1,600 km (1,000 miles), follow these recommendations to obtain maximum engine performance and ensure the future reliability and economy of your new vehicle. Failure to follow these recommendations may result in shortened engine life and reduced engine performance.

- Do not drive at a constant speed, either fast or slow, for long periods of time.
- Do not run the engine over 4,000 rpm.
- Do not accelerate at full throttle in any gear.
- Do not start quickly.
- Do not brake hard as much as possible.
- Do not tow a trailer for at least the first 800 km (500 miles) (for South Africa).

## BEFORE STARTING ENGINE



### WARNING:

**The driving characteristics of your vehicle will change remarkably by any additional load and its distribution, as well as by adding optional equipment (trailer coupling, etc.). Your driving style and speed must be adjusted according to the circumstances. Especially when carrying heavy loads, your speed must be reduced adequately.**

- Make sure the area around the vehicle is clear.
- Check fluid levels such as engine oil, coolant, brake (and clutch) fluid, window washer fluid as frequently as possible, at least whenever you refuel.
- Visually inspect tires for their appearance and condition. Measure and check the tire pressure for proper inflation.
- Check that all windows and lights are clean.
- Adjust the seat and head restraint positions.
- Adjust the inside and outside rearview mirror positions.
- Fasten your seat belt and ask all passengers to do the same.
- Check that all doors are closed.
- Check the operation of the warning lights when the ignition switch is placed in the "ON" position.
- Maintenance items in the "8. Maintenance and do-it-yourself" section should be checked periodically.

## PRECAUTIONS WHEN STARTING AND DRIVING



### WARNING:

- Never leave children or adults who would normally require the support of others left alone either. They could unknowingly activate switches or controls and inadvertently become involved in a serious accident and injure themselves. On hot, sunny days, temperatures in a closed vehicle could quickly become high enough to cause severe or possibly fatal illness to people or animals.
- Properly secure all cargo to help prevent it from sliding or shifting. Do not place cargo higher than the seatbacks. In a sudden stop or collision, unsecured cargo could cause personal injury.

### NOTE:

During the first few months after purchasing a new vehicle, if you smell strong odors of Volatile Organic Compounds (VOCs) inside the vehicle, ventilate the passenger compartment thoroughly. Open all the windows before entering or while in the vehicle. In addition, when the temperature in the passenger compartment rises, or when the vehicle is parked in direct sunlight for a period of time, turn off the air recirculation mode of the air conditioner and/or open the windows to allow sufficient fresh air into the passenger compartment.

## EXHAUST GAS (carbon monoxide)



### WARNING:

- Do not breathe exhaust gas; it contains colorless and odorless carbon monoxide. Carbon monoxide is dangerous. It can cause unconsciousness or death.
- If you suspect that exhaust fumes are entering the vehicle, drive with all windows fully open, and have the vehicle inspected immediately.
- Do not run the engine in closed spaces such as a garage.
- Do not park the vehicle with the engine running for an extended period of time.
- Keep the back door closed while driving, otherwise exhaust gas could be drawn into the passenger compartment. If you must drive with the back door open, follow these precautions:
  - Open all the windows.
  - Turn the air recirculation mode off and set the fan speed control to the highest level to circulate the air.
- If electrical wiring or other cable connections must pass to a trailer through the seal of the back door or the body, follow the manufacturer's recommendations to prevent carbon monoxide entry into the vehicle.
- If a special body or other equipment is added for recreational or other usage, follow the manufacturer's recommendation to prevent carbon monoxide entry into the vehicle. (Some recreational vehicle appliances such as stoves, refrigerators, heaters, etc. may also generate carbon monoxide.)

- The exhaust system and body should be inspected by a qualified mechanic whenever:
  - Your vehicle is raised while being serviced.
  - You suspect that exhaust fumes are entering into the passenger compartment.
  - You notice a change in the sound of the exhaust system.
  - You have had an accident involving damage to the exhaust system, underbody, or rear of the vehicle.

## THREE-WAY CATALYST (if equipped)



### WARNING:

- The exhaust gas and the exhaust system are very hot. Keep people, animals and flammable materials away from the exhaust system components.
- Do not stop or park the vehicle over flammable materials such as dry grass, wastepaper or rags. They may ignite and cause a fire.

The three-way catalyst is an emission control device installed in the exhaust system. Exhaust gas in the three-way catalyst is burned at high temperatures to help reduce pollutants.



### CAUTION:

- Do not use leaded gasoline. (See "Recommended fluids/lubricants and capacities" (P.9-2).) Deposits from leaded gasoline seriously reduce the ability of the three-way catalyst to help reduce exhaust pollutants and/or damage the three-way catalyst.

- Keep your engine tuned up. Malfunctions in the ignition, fuel injection, or electrical systems may cause overrich fuel to flow into the three-way catalyst, causing it to overheat. Do not keep driving if the engine misfires, or if noticeable loss of performance or other unusual operating conditions are detected. Have the vehicle inspected promptly by a NISSAN dealer.
- Avoid driving with an extremely low fuel level. Running out of fuel could cause the engine to misfire, damaging the three-way catalyst.
- Do not race the engine while warming it up.
- Do not push or tow your vehicle to start the engine.

## TIRE PRESSURE MONITORING SYSTEM (TPMS) (if equipped)

Each tire, including the spare (if provided), should be checked monthly when cold and inflated to the inflation pressure recommended by the vehicle manufacturer on the vehicle placard or tire inflation pressure label. (If your vehicle has tires of a different size than the size indicated on the vehicle placard or tire inflation pressure label, you should determine the proper tire inflation pressure for those tires.)

As an added safety feature, your vehicle has been equipped with a Tire Pressure Monitoring System (TPMS) that illuminates a low tire pressure telltale when one or more of your tires is significantly under-inflated. Accordingly, when the low tire pressure telltale illuminates, you should stop and check your tires as soon as possible, and inflate them to the proper pressure. Driving on a significantly under-inflated tire causes the tire to overheat and can lead to tire failure. Under-inflation also reduces

fuel efficiency and tire tread life, and may affect the vehicle's handling and stopping ability.

Please note that the TPMS is not a substitute for proper tire maintenance, and it is the driver's responsibility to maintain correct tire pressure, even if under-inflation has not reached the level to trigger illumination of the TPMS low tire pressure telltale.

Your vehicle has also been equipped with a TPMS malfunction indicator to indicate when the system is not operating properly. The TPMS malfunction indicator is combined with the low tire pressure telltale. When the system detects a malfunction, the telltale will flash for approximately one minute and then remain continuously illuminated. This sequence will continue upon subsequent vehicle start-ups as long as the malfunction exists. When the malfunction indicator is illuminated, the system may not be able to detect or signal low tire pressure as intended. TPMS malfunctions may occur for a variety of reasons, including the installation of replacement or alternate tires or wheels on the vehicle that prevent the TPMS from functioning properly. Always check the TPMS malfunction telltale after replacing one or more tires or wheels on your vehicle to ensure that the replacement or alternate tires and wheels allow the TPMS to continue to function properly.

### Additional information

- Since the spare tire is not equipped with the TPMS, the TPMS does not monitor the tire pressure of the spare tire.
- The TPMS will activate only when the vehicle is driven at speeds above 25 km/h (16 MPH). Also, this system may not detect a sudden drop in tire pressure (for example a flat tire while driving).

- The low tire pressure warning light may not automatically turn off when the tire pressure is adjusted. After the tire is inflated to the recommended pressure, reset the tire pressures registered in your vehicle (model with TPMS reset function) and then drive the vehicle at speeds above 25 km/h (16 MPH) to activate the TPMS and turn off the low tire pressure warning light.
- Tire pressure rises and falls depending on the heat caused by the vehicle's operation and the outside temperature. Do not reduce the tire pressure after driving because the tire pressure rises after driving. Low outside temperature can lower the temperature of the air inside the tire which can cause a lower tire inflation pressure. This may cause the low tire pressure warning light to illuminate. If the warning light illuminates in low ambient temperature, check the tire pressure for all four tires.
- Depending on a change in the outside temperature, the low tire pressure warning light may illuminate even if the tire pressure has been adjusted properly. Adjust the tire pressure to the recommended COLD tire pressure again when the tires are cold, and reset the TPMS (model with TPMS reset function).
- You can check the pressure of all tires in the vehicle information display. (See "Trip computer" (P.2-33).)

For additional information, see "Low tire pressure warning light" (P.2-15).



### **WARNING:**

- **If the low tire pressure warning light illuminates while driving, avoid sudden steering maneuvers or abrupt braking, reduce vehicle speed, pull off the road to**

**a safe location and stop the vehicle as soon as possible. Driving with under-inflated tires may permanently damage the tires and increase the likelihood of tire failure. Serious vehicle damage could occur and may lead to an accident and could result in serious personal injury. Check the tire pressure for all four tires. Adjust the tire pressure to the recommended COLD tire pressure shown on the tire placard to turn the low tire pressure warning light off. If the light still illuminates while driving after adjusting the tire pressure, a tire may be flat or the TPMS may be malfunctioning. If you have a flat tire, replace it with a spare tire as soon as possible. If no tire is flat and all tires are properly inflated, have the vehicle checked by a NISSAN dealer. (See "Flat tire" (P.6-2) for changing a flat tire.)**

- **After adjusting the tire pressure, be sure to reset the TPMS. Otherwise, the TPMS will not warn of low tire pressure (model with TPMS reset function).**
- **Since the spare tire is not equipped with the TPMS, when a spare tire is mounted or a wheel is replaced, the TPMS will not function and the low tire pressure warning light will flash for approximately 1 minute. The light will remain on after the 1 minute. Contact a NISSAN dealer as soon as possible for tire replacement and/or system resetting.**
- **Replacing tires with those not originally specified by NISSAN could affect the proper operation of the TPMS.**
- **Do not inject any tire liquid or aerosol tire sealant into the tires, as this may cause a malfunction of the tire pressure sensors.**

**CAUTION:**

- **The TPMS may not function properly when the wheels are equipped with tire chains or the wheels are buried in snow.**
- **Do not place metalized film or any metal parts (antenna, etc.) on the windows. This may cause poor reception of the signals from the tire pressure sensors, and the TPMS will not function properly.**

Some devices and transmitters may temporarily interfere with the operation of the TPMS and cause the low tire pressure warning light to illuminate. Some examples are:

- Facilities or electric devices using similar radio frequencies are near the vehicle.
- If a transmitter set to similar frequencies is being used in or near the vehicle.
- If a computer (or similar equipment) or a DC/AC converter is being used in or near the vehicle.

Low tire pressure warning light may illuminate in the following cases.

- If the vehicle is equipped with a wheel and tire without TPMS.
- If the TPMS has been replaced and the ID has not been registered.
- If the wheel is not originally specified by NISSAN.

**TPMS resetting (model with TPMS reset function)**

To keep the TPMS functioning properly, the reset operation must be performed in the following cases.

- when the tire pressure is adjusted
- when a tire or a wheel is replaced

- when the tires are rotated
- Perform the following procedures to reset the TPMS.

1. Park the vehicle in a safe and level place.
2. Apply the parking brake and place the shift lever in the "P" (Park) position.
3. Adjust the tire pressure on all four tires to the recommended COLD tire pressure shown on the tire placard. Use a tire pressure gauge to check the tire pressure.
4. Place the ignition switch in the "ON" position.

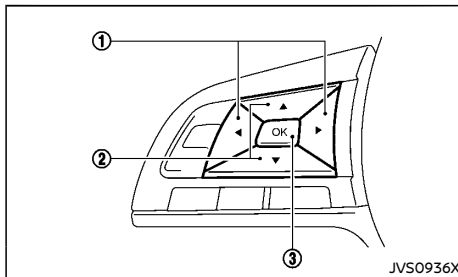

5. Press the ◀ ▶ button ① until "Settings" appears.
6. Use the ⬥ button ② until "Tire Pressures" is selected, and press OK ③.
7. Use the ⬥ button ② until "Calibrate" is selected, and press OK ③.
8. Use the ⬥ button ② until "Start" is selected, and press OK ③ to reset the TPMS. When the TPMS resetting starts, the message "TPMS resetting" will be displayed.
9. After resetting the TPMS, drive the vehicle for several minutes at speeds above 25 km/h (16 MPH).

If the low tire pressure warning light illuminates after the resetting operation, it may indicate that the TPMS is not functioning properly. Have the system checked by a NISSAN dealer.

For information regarding the low tire pressure warning light, see "Low tire pressure warning light" (P.2-15).

## TURBOCHARGER SYSTEM (if equipped)

The turbocharger system uses engine oil for lubrication and cooling of its rotating components. The turbocharger turbine turns at extremely high speeds and it can reach an extremely high temperature. It is essential to maintain a flow of clean oil through the turbocharger system. A sudden interruption to the oil supply may cause a malfunction in the turbocharger.

To ensure prolonged life and performance of the turbocharger, it is essential to comply with the following maintenance procedure:



### CAUTION:

- **Change the engine oil of the turbocharged diesel engine as prescribed. See the separately provided maintenance booklet for additional information.**
- **Use only the recommended engine oil. For details, see "Recommended fluids/lubricants and capacities" (P.9-2).**
- **If the engine has been operating at high rpm for an extended period of time, let it idle for a few minutes prior to shutdown.**
- **Do not accelerate the engine to high rpm immediately after starting it.**
- **When starting the engine at ambient temperatures below -5°C (23°F), an engine protection mode may be activated. During this time, the engine output is reduced. The engine protection mode is switched off automatically after a maximum of 3 minutes (provided the accelerator pedal is released completely).**

## ON-PAVEMENT AND OFF-ROAD DRIVING PRECAUTIONS

**Utility vehicles have a significantly higher rollover rate than other types of vehicles.**

They have higher ground clearance than passenger cars to make them capable of performing in a wide variety of on-pavement and off-road applications. This gives them a higher center of gravity than ordinary cars. An advantage of higher ground clearance is a better view of the road, allowing you to anticipate problems. However, they are not designed for cornering at the same speeds as conventional passenger cars any more than low-slung sports cars are designed to perform satisfactorily under off-road conditions. If at all possible, avoid sharp turns or abrupt maneuvers, particularly at high speeds. As with other vehicles of this type, failure to operate this vehicle correctly may result in loss of control or vehicle rollover.

For information about driving using Four-Wheel Drive (4WD) (if equipped), see "Four-Wheel Drive (4WD)" (P.5-19).

### DRIVING SAFETY PRECAUTIONS

Please observe the following precautions:



### WARNING:

- **Drive carefully when off the road and avoid dangerous areas. Every person who drives or rides in this vehicle should be seated with their seat belt fastened. This will keep you and your passengers in position when driving over rough terrain.**
- **Do not drive across steep slopes. Instead drive either straight up or straight down the slopes. Off-road vehicles can tip over sideways much more easily than they can forward or backward.**

- **Many hills are too steep for any vehicle. If you drive up them, you may stall. If you drive down them, you may not be able to control your speed. If you drive across them, you may roll over.**
- **Do not shift ranges while driving on downhill grades as this could cause loss of control of the vehicle.**
- **Stay alert when driving to the top of a hill. At the top there could be a drop-off or other hazard that could cause an accident.**
- **If your engine stalls or you cannot make it to the top of a steep hill, never attempt to turn around. Your vehicle could tip or roll over. Always back straight down in R (Reverse) range. Never back down in N (Neutral) or with the clutch pedal depressed (MT model) using only the brake, as this could cause loss of control.**
- **Heavy braking going down a hill could cause your brakes to overheat and fade, resulting in loss of control and an accident. Apply brakes lightly and use a low range to control your speed.**
- **Unsecured cargo can be thrown around when driving over rough terrain. Properly secure all cargo so it will not be thrown forward and cause injury to you or your passengers.**
- **To avoid raising the center of gravity excessively, do not exceed the rated capacity of the roof rack and evenly distribute the load. Secure heavy loads in the cargo area as far forward and as low as possible. Do not equip the vehicle with tires larger than specified in this manual. This could cause your vehicle to roll over.**

- Do not grip the inside or spokes of the steering wheel when driving off-road. The steering wheel could move suddenly and injure your hands. Instead drive with your fingers and thumbs on the outside of the rim.
- Before operating the vehicle, ensure that the driver and all passengers have their seat belts fastened.
- Always drive with the floor mats in place as the floor may become hot.
- Lower your speed when encountering strong crosswinds. With a higher center of gravity, your NISSAN is more affected by strong side winds. Slower speeds ensure better vehicle control.
- Do not drive beyond the performance capability of the tires, even with 4WD engaged. (4WD models)
- Do not attempt to raise two wheels off the ground and shift the transmission to any drive or reverse position with the engine running. Doing so may result in drivetrain damage or unexpected vehicle movement which could result in serious vehicle damage or personal injury. (4WD models)
- Do not attempt to test a 4WD equipped vehicle on a 2-wheel dynamometer or similar equipment even if the other two wheels are raised off the ground. Make sure you inform test facility personnel that your vehicle is equipped with 4WD before it is placed on a dynamometer. Using the wrong test equipment may result in drivetrain damage or unexpected vehicle movement which could result in serious vehicle damage or personal injury. (4WD models)
- When a wheel is off the ground due to an unlevel surface, do not spin the wheel excessively.
- Accelerating quickly, sharp steering maneuvers or sudden braking may cause loss of control.
- If at all possible, avoid sharp turning maneuvers, particularly at high speeds. Your vehicle has a higher center of gravity than a conventional passenger car. The vehicle is not designed for cornering at the same speeds as conventional passenger cars. Failure to operate this vehicle correctly could result in loss of control and/or a rollover accident.
- Always use tires of the same type, size, brand, construction (bias, bias-belted or radial), and tread pattern on all four wheels. Install tire chains on the rear wheels when driving on slippery roads and drive carefully.
- Be sure to check the brakes immediately after driving in mud or water. See "Brake system" (P.5-84) for wet brakes.
- Avoid parking your vehicle on steep hills. If you get out of the vehicle and it rolls forward, backward or sideways, you could be injured.
- Whenever you drive off-road through sand, mud or water as deep as the wheel hub, more frequent maintenance may be required. See the maintenance information in a separate maintenance booklet.
- Rinse the underside of the vehicle with fresh water after driving through mud or sand. Remove any brush or sticks that are trapped.

## CARE WHEN DRIVING

Driving your vehicle to fit the circumstances is essential for your safety and comfort. As a driver, you should be the one who knows best how to drive in the given circumstances.

### ENGINE COLD START PERIOD

Due to the higher engine speeds, when the engine is cold, extra caution must be exercised when selecting a gear during the engine warm-up period after starting the engine.

### LOADING LUGGAGE

Loads and their distribution and the attachment of equipment (roof baggage carriers, etc.) will considerably change the driving characteristics of the vehicle. Your driving style and speed must be adjusted according to the circumstances.

### DRIVING IN WET CONDITIONS

- Avoid accelerating or stopping suddenly.
- Avoid sharp turning or lane changing suddenly.
- Avoid following too close to the vehicle in front.

When water covers the road surface with water puddles, small water streams, etc., reduce speed to prevent hydroplaning which can cause skidding and loss of control. Worn tires will increase this risk.

## IGNITION SWITCH (models without Intelligent Key system)

### DRIVING IN WINTER CONDITIONS

- Drive cautiously.
- Avoid accelerating or stopping suddenly.
- Avoid sharp turning or lane changing suddenly.
- Avoid sudden steering.
- Avoid following too close to the vehicle in front.



#### WARNING:

**Never remove the key or turn the ignition switch to the "LOCK" position while driving. The steering wheel will lock. This will cause the driver to lose control of the vehicle and could result in serious vehicle damage or personal injury.**

### MANUAL TRANSMISSION (MT)

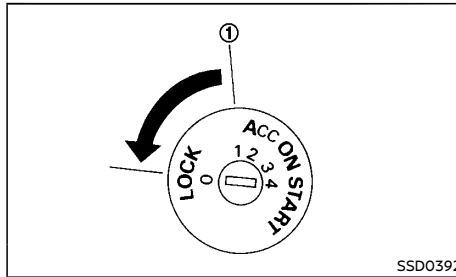

The switch includes an anti-theft steering lock device.

The ignition key can only be removed when the switch is in the "LOCK" normal parking position (0).

There is an "OFF" position ① in between "LOCK" and "ACC", although it does not show on the lock cylinder.

**To lock the steering wheel, remove the key. To unlock the steering wheel, insert the key and turn it gently while rotating the steering wheel slightly right and left.**

### AUTOMATIC TRANSMISSION (AT)

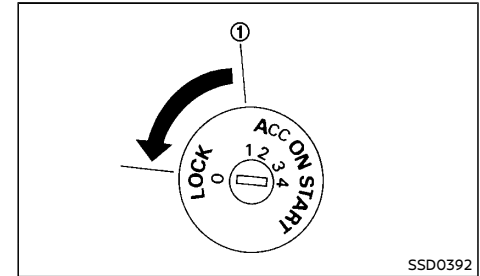

The ignition lock is designed so that the ignition switch cannot be turned to the "LOCK" position until the shift lever is moved to the "P" (Park) position. When moving the ignition switch to the "LOCK" position, to remove the key from the ignition switch, make sure the shift lever is in the "P" (Park) position.

When the ignition switch cannot be turned to the "LOCK" position:

1. Move the shift lever to the "P" (Park) position.
2. Turn the ignition switch slightly in the "ON" direction.
3. Place the ignition switch in the "LOCK" position.
4. Remove the key.

If the ignition switch is turned to the "LOCK" position, the shift lever cannot be moved from the "P" (Park) position. The shift lever can be moved if the ignition switch is in the "ON" position with the foot brake pedal depressed.

The "OFF" position ① is between the "LOCK" and "ON" positions, although it is not marked on the ignition switch.



## PUSH-BUTTON IGNITION SWITCH (models with Intelligent Key system)

### KEY POSITIONS

#### LOCK (Normal parking position) (0):

The ignition key can only be removed at this position.

#### OFF (1):

The engine can be turned off without locking the steering wheel.

#### ACC (Accessories) (2):

This position activates electrical accessories such as the radio when the engine is not running.

#### ON (Normal operating position) (3):

This position turns on the ignition system and electrical accessories.

#### START (4):

This position starts the engine. As soon as the engine has started, release the key immediately. It will automatically return to the "ON" position.

### PRECAUTIONS ON PUSH-BUTTON IGNITION SWITCH OPERATION



#### WARNING:

**Do not operate the push-button ignition switch while driving the vehicle except in an emergency. (The engine will stop when the ignition switch is pushed 3 consecutive times or the ignition switch is pushed and held for more than 2 seconds.) The steering wheel may lock and could cause the driver to lose control of the vehicle. This could result in serious vehicle damage or personal injury.**

Before operating the push-button ignition switch, be sure to move the shift lever to the "P" (Park) position (for Automatic Transmission model) or the shift lever to the "N" (Neutral) position (for Manual Transmission model).

### INTELLIGENT KEY SYSTEM

The Intelligent Key system can operate the ignition switch without taking the key out from your pocket or bag. The operating environment and/or conditions may affect the Intelligent Key system operation.

Some indicators and warnings for operation are displayed in the vehicle information display. (See "Vehicle information display (models with color display)" (P.2-21).)



#### CAUTION:

- **Be sure to carry the Intelligent Key with you when operating the vehicle.**
- **Never leave the Intelligent Key inside the vehicle when you leave the vehicle.**
- **If the vehicle battery is discharged, the ignition switch cannot be switched from**

**the "LOCK" position, and if the steering lock is engaged, the steering wheel cannot be moved. Charge the battery as soon as possible. (See "Jump starting" (P.6-7).)**

### Operating range

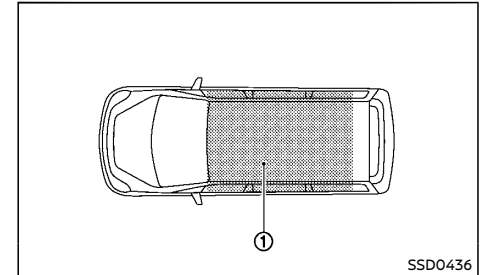

SSD0436

The Intelligent Key can only be used for starting the engine when the Intelligent Key is within the specified operating range ① as illustrated.

When the Intelligent Key battery is almost discharged or strong radio waves are present near the operating location, the Intelligent Key system's operating range becomes narrower and may not function properly.

If the Intelligent Key is within the operating range, it is possible for anyone, even someone who does not carry the Intelligent Key, to push the ignition switch to start the engine.

- The cargo area is not included in the operating range, but the Intelligent Key may function.
- If the Intelligent Key is placed on the instrument panel, inside the glove box, door pocket or the corner of the interior compartment, the Intelligent Key may not function.

- If the Intelligent Key is placed near the door or window outside the vehicle, the Intelligent Key may function.

## AUTOMATIC TRANSMISSION (AT)

The ignition lock is designed so that the ignition switch cannot be switched to the "LOCK" position until the shift lever is moved to the "P" (Park) position. When pushing the ignition switch to the "OFF" position, make sure the shift lever is in the "P" (Park) position.

When the ignition switch cannot be switched to the "LOCK" position:

1. "Shift to Park" warning appears on the vehicle information display and a chime sounds.
2. Move the shift lever to the "P" (Park) position.
3. If the ignition switch is in the "ACC" position, PUSH warning appears on the vehicle information display.
4. Push the ignition switch. The ignition switch is switched to the "OFF" position.
5. Open the door. The ignition switch turns to the "LOCK" position.

For warnings and indicators on the vehicle information display, see "Vehicle information display (models with color display)" (P.2-21).

If the ignition switch is switched to the "LOCK" position, the shift lever cannot be moved from the "P" (Park) position. The shift lever can be moved if the ignition switch is in the "ON" position with the foot brake pedal depressed.

## STEERING LOCK

The ignition switch is equipped with an anti-theft steering lock device.

### To lock steering wheel

1. Place the ignition switch in the "OFF" position where the ignition switch position indicator will not illuminate.
2. Open or close the door. The ignition switch turns to the "LOCK" position.
3. Turn the steering wheel 1/6 of a turn to the right or left from the straight up position.

### To unlock steering wheel

Push the ignition switch, and the steering wheel will be automatically unlocked.



### CAUTION:

- If the battery of the vehicle is discharged, the push-button ignition switch cannot be switched from the "LOCK" position.
- If the steering lock release malfunction indicator appears in the vehicle information display, push the ignition switch again while rotating the steering wheel slightly to the right and left. (See "Vehicle information display (models with color display)" (P.2-21).)

## IGNITION SWITCH POSITIONS



### WARNING:

Never place the ignition switch in the "OFF" position while driving. The steering wheel may lock and cause the driver to lose control of the vehicle, resulting in serious vehicle damage or personal injury.



### CAUTION:

- Do not leave the vehicle for extended periods of time when the ignition switch is in the "ON" position and the engine is not running. This can discharge the battery.
- Use electrical accessories with the engine running to avoid discharging the vehicle battery. If you must use accessories while the engine is not running, do not use them for extended periods of time and do not use multiple electrical accessories at the same time.

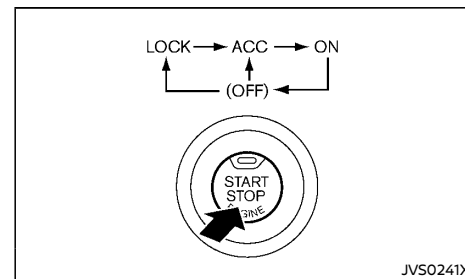

When the ignition switch is pushed without depressing the brake pedal, the ignition switch position will change as follows:

- Push once to change to "ACC".
- Push two times to change to "ON".
- Push three times to change to "OFF".
- Push four times to return to "ACC".
- Open or close any door to return to "LOCK" from the "OFF" position.

### LOCK position

The ignition switch and steering lock can only be locked at this position.

The ignition switch will be unlocked when it is pushed to the "ACC" position while carrying the Intelligent Key.

### ACC position

The electrical accessory power activates at this position without the engine turned on.

### ON position

The ignition system and the electrical accessory power activate at this position without the engine turned on.

### OFF position

The engine is turned off with the steering wheel unlocked.

## INTELLIGENT KEY BATTERY DISCHARGE

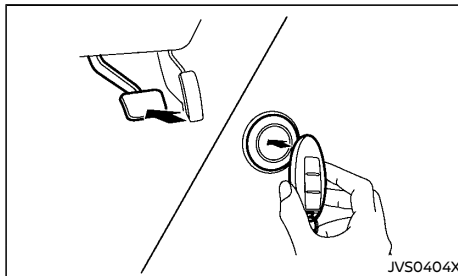

If the battery of the Intelligent Key is discharged, or environmental conditions interfere with the Intelligent Key operation, start the engine according to the following procedure:

#### 1. **Automatic Transmission (AT) model:**

Move the shift lever to the "P" (Park) position.

#### **Manual Transmission (MT) model:**

Move the shift lever to the "N" (Neutral) position.

2. Firmly depress the brake pedal.
3. Touch the ignition switch with the Intelligent Key as illustrated. (A chime will sound.)
4. Push the ignition switch while depressing the brake pedal (AT model) or the clutch pedal (MT model) within 10 seconds after the chime sounds. The engine will start.

After step 3 is performed, when the ignition switch is pushed without depressing the brake pedal (AT model) or the clutch pedal (MT model), the ignition switch position will change to "ACC".

### NOTE:

- When the ignition switch is pushed to the "ACC" or "ON" position or the engine is started by the above procedures, the Key Battery low warning appears on the vehicle information display even if the Intelligent Key is inside the vehicle. This is not a malfunction. To turn off the warning, touch the ignition switch with the Intelligent Key again.
- If the Key Battery low warning appears on the vehicle information display, replace the battery as soon as possible. (See "Battery" (P.8-22).)

## STARTING ENGINE (models without Intelligent Key system)

1. Apply the parking brake.
2. Depress the foot brake pedal.
3. **Automatic Transmission (AT) model:**  
Move the shift lever to the "P" (Park) or the "N" (Neutral) position.

**The starter is designed to operate only when the shift lever is in the proper position.**

### Manual Transmission (MT) model:

Move the shift lever to the "N" (Neutral) position and depress the clutch pedal to the floor while starting the engine.

4. **For diesel engine models:** Turn the ignition switch to the "ON" position and wait until the glow plug indicator light  turns off.

Crank the engine with your foot off the accelerator pedal by turning the ignition switch to the "START" position.

5. Immediately release the ignition switch when the engine starts. If the engine starts, but fails to run, repeat the above procedures.

If the engine is very hard to start in extremely cold or hot weather, depress the accelerator pedal and hold it to help start the engine.



### CAUTION:

- **Do not operate the starter for more than 15 seconds at a time. If the engine does not start, turn the ignition switch off and wait 20 seconds before cranking the engine again. Otherwise, the starter could be damaged.**

- **If it becomes necessary to start the engine with a booster battery and jumper cables, the instructions and cautions contained in the "6. In case of emergency" section should be carefully followed.**
6. Allow the engine to idle for at least 30 seconds after starting the engine to warm-up. Drive at moderate speeds for a short distance first, especially in cold weather.



### CAUTION:

**Do not leave the vehicle unattended while the engine is warming up.**

## STARTING ENGINE (models with Intelligent Key system)

1. Apply the parking brake.
2. **Automatic Transmission (AT) model:**  
Move the shift lever to the "P" (Park) or the "N" (Neutral) position.

**The starter is designed to operate only when the shift lever is in the proper position.**

### Manual Transmission (MT) model:

Move the shift lever to the "N" (Neutral) position.

**The starter is designed to not operate unless the clutch pedal is fully depressed.**

**The Intelligent Key must be carried when operating the ignition switch.**

3. Place the ignition switch in the "ON" position. Firmly depress the brake pedal (AT model) or the clutch pedal (MT model) and push the ignition switch to start the engine.

**For diesel engine models:** Wait until the glow plug indicator light  turns off.

If the engine is already warmed up, the glow plug indicator light may not illuminate when the engine is started.

To start the engine immediately, push and release the ignition switch while depressing the brake pedal or clutch pedal with the ignition switch in any position.

4. Immediately release the ignition switch when the engine starts. If the engine starts, but fails to run, repeat the above procedures.

If the engine is very hard to start in extremely cold or hot weather, depress the accelerator pedal and hold it. Push the ignition switch for up to 15 seconds while holding. Release the accelerator pedal when the engine starts.

## DRIVING VEHICLE

### CAUTION:

- As soon as the engine has started, release the ignition switch immediately.
  - Do not operate the starter for more than 15 seconds at a time. If the engine does not start, push the ignition switch to the "OFF" position and wait 20 seconds before cranking the engine again. Otherwise, the starter could be damaged.
  - If it becomes necessary to start the engine with a booster battery and jumper cables, the instructions and cautions contained in the "6. In case of emergency" section should be carefully followed.
5. Allow the engine to idle for at least 30 seconds after starting the engine to warm-up. Drive at moderate speeds for a short distance first, especially in cold weather.

### CAUTION:

Do not leave the vehicle unattended while the engine is warming up.

6. To stop the engine, move the shift lever to the "P" (Park) position (AT model) or move the shift lever to the "N" (Neutral) position (MT model), apply the parking brake, and push the ignition switch to the "OFF" position.

### DRIVING WITH AUTOMATIC TRANSMISSION (AT)

The Automatic Transmission (AT) in your vehicle is electronically controlled to produce maximum power and smooth operation.

The recommended operating procedures for this transmission are shown on the following pages. Follow these procedures for maximum vehicle performance and driving enjoyment.

### CAUTION:

- The cold engine idle speed is high, so use caution when shifting into a forward or reverse gear before the engine has warmed up.
- Avoid revving up the engine while the vehicle is stopped. This could cause unexpected vehicle movement.
- Do not downshift abruptly on slippery roads. This may cause a loss of control.
- Never shift to either the "P" (Park) or "R" (Reverse) position while the vehicle is moving forward and "P" (Park) or "D" (Drive) position while the vehicle is moving rearward. This could cause an accident or damage the transmission.
- Except in an emergency, do not shift to the "N" (Neutral) position while driving. Coasting with the transmission in the "N" (Neutral) position may cause serious damage to the transmission.
- Start the engine in either the "P" (Park) or "N" (Neutral) position. The engine will not start in any other gear position. If it does, have your vehicle checked by a NISSAN dealer.

- Shift into the "P" (Park) position and apply the parking brake when at a standstill for longer than a short waiting period.
- Keep the engine at idling speed while shifting from the "N" (Neutral) position to any driving position.
- When stopping the vehicle on an uphill grade, do not hold the vehicle by depressing the accelerator pedal. The foot brake pedal should be depressed in this situation.

### Starting vehicle

1. After starting the engine, fully depress the foot brake pedal before attempting to move the shift lever out of the "P" (Park) position.
2. Keep the foot brake pedal depressed and move the shift lever into a driving position.
3. Release the parking brake, the foot brake pedal, and then gradually start the vehicle in motion.

The AT is designed so the foot brake pedal **MUST** be depressed before shifting from the "P" (Park) position to any driving position while the ignition switch is in the "ON" position.

The shift lever cannot be moved out of the "P" (Park) position and into any of the other gear positions if the ignition switch is placed in the "LOCK", "OFF" or "ACC" position.

### CAUTION:

- **DEPRESS THE FOOT BRAKE PEDAL** - Shifting the shift lever to "D", "R" or manual shift mode without depressing the foot brake pedal causes the vehicle to move slowly when the engine is running. Make

sure the foot brake pedal is depressed fully and the vehicle is stopped before shifting the shift lever.

- **MAKE SURE OF THE SHIFT LEVER POSITION** - Make sure the shift lever is in the desired position. "D" and manual shift mode are used to move forward and "R" to back up. Depress the accelerator pedal to start the vehicle and merge with traffic (avoid abrupt starting and spinning the wheels).
- **WARM UP THE ENGINE** - Due to the higher idle speeds when the engine is cold, extra caution must be exercised when shifting the shift lever into the driving position immediately after starting the engine.
- **PARKING THE VEHICLE.**

Depress the foot brake pedal and, once the vehicle stops, move the shift lever into the "P" (Park) position, pull the parking brake lever and release the foot brake pedal.

### Shifting

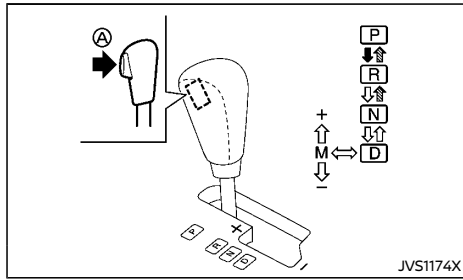

Left-Hand Drive (LHD) model

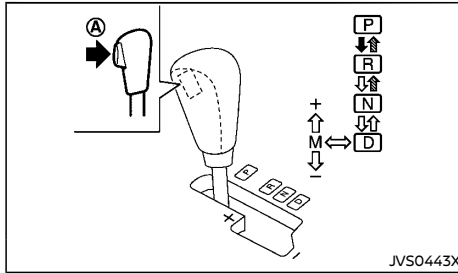

Right-Hand Drive (RHD) model

- ➔: Push the button **A** while depressing the brake pedal
- ➔: Push the button **A**
- ➔: Just move the shift lever



### WARNING:

- **Apply the parking brake if the shift lever is in any position while the engine is not running. Failure to do so could cause the vehicle to move unexpectedly or roll away and result in serious personal injury or property damage.**
- **If the shift lever cannot be moved from the "P" (Park) position while the engine is running and the foot brake pedal is depressed, the stop lights may not work. Malfunctioning stop lights could cause an accident injuring yourself and others.**

After starting the engine, fully depress the foot brake pedal, push the shift lever button and move the shift lever out of the "P" (Park) position.

If the ignition switch is placed in the "OFF" or "ACC" position for any reason while the shift

lever is in any positions other than the "P" (Park) position, the ignition switch cannot be placed in the "LOCK" position.

If the ignition switch cannot be placed in the "LOCK" position, perform the following steps:

1. Apply the parking brake.
  2. Place the ignition switch in the "ON" position while depressing the foot brake pedal.
  3. Move the shift lever to the "P" (Park) position.
  4. **Models with Intelligent Key system:**  
Place the ignition switch in the "OFF" position.
- Models without Intelligent Key system:**  
Place the ignition switch in the "LOCK" position.

### P (Park):

Use this position when the vehicle is parked or when starting the engine. **Make sure that the vehicle is completely stopped and move the shift lever into the "P" (Park) position.** Apply the parking brake. When parking on a hill, first depress the foot brake pedal, apply the parking brake, and then move the shift lever into the "P" (Park) position.

### R (Reverse):

Use this position to back up. Make sure that the vehicle is completely stopped before selecting the "R" (Reverse) position.

### N (Neutral):

Neither the forward nor reverse gear is engaged. The engine can be started in this position. You may shift to the "N" (Neutral) position and restart a stalled engine while the vehicle is moving.

## D (Drive):

Use this position for all normal forward driving.

## Manual shift mode

When the shift lever is shifted to the manual shift gate and moved up or down while driving, the transmission enters the manual shift mode. Shift range can be selected manually.

When shifting up, move the shift lever to the + (up) side. The transmission shifts to the higher range.

When shifting down, move the shift lever to the - (down) side. The transmission shifts to the lower range.

When canceling the manual shift mode, return the shift lever to the "D" (Drive) position. The transmission returns to the normal driving mode.

In the manual shift mode, the shift range is displayed in the vehicle information display between the speedometer and tachometer.

Shift ranges up or down one by one as follows:

$M_1 \rightarrow M_2 \rightarrow M_3 \rightarrow M_4 \rightarrow M_5 \rightarrow M_6 \rightarrow M_7$   
← ← ← ← ← ← ←

$M_7$  (7th):

Use this position for all normal forward driving at highway speeds.

$M_6$  (6th) and  $M_5$  (5th):

Use these positions when driving up long slopes, or for engine braking when driving down long slopes.

$M_4$  (4th),  $M_3$  (3rd) and  $M_2$  (2nd):

Use these positions for hill climbing or engine braking on downhill grades.

$M_1$  (1st):

Use this position when climbing steep hills

slowly or driving slowly through deep snow, or for maximum engine braking on steep downhill grades.

- Remember not to drive at high speeds for extended periods of time in lower than 7th gear. This reduces fuel economy.
- Moving the shift lever to the same side twice will shift the ranges in succession. However, if this motion is rapidly done, the second shifting may not be completed properly.
- **In the manual shift mode, the transmission may not shift to the selected gear or may automatically shift to the other gear. This helps maintain driving performance and reduces the chance of vehicle damage or loss of control.**
- **When the transmission does not shift to the selected gear, the Automatic Transmission (AT) position indicator light (in the vehicle information display) will blink and the buzzer will sound.**
- **In the manual shift mode, the transmission automatically shifts down to 1st gear before the vehicle comes to a stop. When accelerating again, it is necessary to shift up to the desired range.**

Accelerator downshift - in D (Drive) position -  
For passing or climbing hills, depress the accelerator pedal to the floor. This shifts the transmission down into a lower gear, depending on the vehicle speed.

## Shift lock release

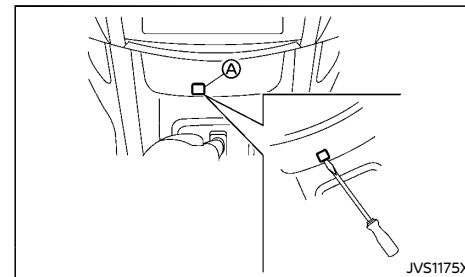

If the battery is discharged, the shift lever may not be moved from the "P" (Park) position even with the brake pedal depressed.

To release the shift lock, perform the following procedure:

### 1. Models with Intelligent Key system:

Place the ignition switch in the "OFF" or "LOCK" position.

### Models without Intelligent Key system:

Place the ignition switch in the "LOCK" position.

2. Apply the parking brake.
3. Remove the shift lock release cover **A** using a suitable tool and push down the shift lock release using a suitable tool.
4. Push the shift lever button and move the shift lever to the "N" (Neutral) position while holding down the shift lock release.

Place the ignition switch in the "ON" position to release the steering wheel lock.

The vehicle may be moved, by pushing, to the desired location.

If the shift lever cannot be moved out of the "P"

(Park) position, have a NISSAN dealer check the AT system as soon as possible.

### Fail-safe

When the fail-safe operation occurs, the AT will be locked in any of the forward gears depending on conditions.

**If the vehicle is driven under extreme conditions, such as excessive wheel spinning and subsequent hard braking, the fail-safe system may be activated. This will occur even if all electrical circuits are functioning properly. In this case, place the ignition switch in the "OFF" position and wait for 3 seconds. Then place the ignition switch back in the "ON" position. The vehicle should return to its normal operating condition. If it does not return to its normal operating condition, have a NISSAN dealer check the transmission and repair it if necessary.**

## DRIVING WITH MANUAL TRANSMISSION (MT)



### WARNING:

- **Do not downshift abruptly on slippery roads. This may cause a loss of control.**
- **Do not over-rev the engine when shifting to a lower gear. This may cause a loss of vehicle control or engine damage.**



### CAUTION:

- **Do not rest your foot on the clutch pedal while driving. This may damage the clutch system.**
- **Fully depress the clutch pedal before shifting to help prevent transmission damage.**
- **Stop the vehicle completely before shifting into the "R" (Reverse) position.**
- **When the vehicle is stopped for a period of time, for example, waiting at stoplights, shift to the "N" (Neutral) position and release the clutch pedal with the foot brake pedal depressed.**

### Starting vehicle

1. After starting the engine, depress the clutch pedal to the floor and move the shift lever to the "1" (1st) or "R" (Reverse) position.
2. Slowly depress the accelerator pedal, releasing the clutch pedal and parking brake at the same time.

### Shifting gear

To change gears, or when upshifting or downshifting, fully depress the clutch pedal, shift into the appropriate gear, then slowly and smoothly release the clutch pedal.

Start the vehicle in the "1" (1st) position and shift to the "2" (2nd), "3" (3rd), "4" (4th), "5" (5th) and "6" (6th) gear in sequence according to the vehicle speed

If it is difficult to move the shift lever into the "R" (Reverse) or "1" (1st) position, shift to the "N" (Neutral) position, and then release the clutch pedal once. Fully depress the clutch pedal again and shift into "R" or "1" position.

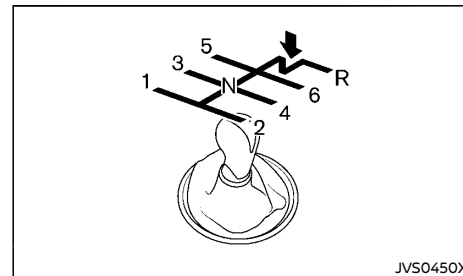

To back up, depress the shift lever and then move it to the "R" (Reverse) position after the vehicle has completely stopped.

### Suggested maximum speed in each gear

Downshift to a lower gear if the engine is not running smoothly, or if you need to accelerate.

Using 6th gear is recommended for achieving the most fuel economy during highway driving.

Do not exceed the maximum suggested speed (shown below) in any gear. For level road driving, use the highest gear suggested for



that speed. Always observe posted speed limits, and drive according to the road conditions which will ensure safe operation. Do not over-rev the engine when shifting to a lower gear as it may cause engine damage or loss of vehicle control.

**YD25DDTi engine models (except for South Africa):**

	km/h (MPH)
1st	34 (21)
2nd	65 (40)
3rd	99 (62)
4th	134 (83)
5th	— (—)
6th	— (—)

**YD25DDTi engine models (for South Africa):**

	km/h (MPH)
1st	31 (19)
2nd	59 (37)
3rd	90 (56)
4th	121 (75)
5th	— (—)
6th	— (—)

**QR25DE engine models (except for the Middle East):**

	km/h (MPH)
1st	39 (24)
2nd	73 (45)
3rd	112 (69)
4th	— (—)
5th	— (—)
6th	— (—)

**QR25DE engine models (for the Middle East):**

	km/h (MPH)
1st	43 (27)
2nd	74 (46)
3rd	107 (67)
4th	— (—)
5th	— (—)
6th	— (—)

**FOUR-WHEEL DRIVE (4WD) (if equipped)**



**WARNING:**

- Do not attempt to raise two wheels off the ground and shift the transmission to any drive or reverse position with the engine running. Doing so may result in drivetrain damage or unexpected vehicle movement which could result in serious vehicle damage or personal injury.
- Do not attempt to test a 4WD equipped vehicle on a 2-wheel dynamometer or similar equipment even if the other two wheels are raised off the ground. Make sure you inform test facility personnel that your vehicle is equipped with 4WD before it is placed on a dynamometer. Using the wrong test equipment may result in drivetrain damage or unexpected vehicle movement which could result in serious vehicle damage or personal injury.



**CAUTION:**

- Do not drive the vehicle in the 4H or 4LO position on dry hard surface roads. Driving on dry, hard surfaces in 4H or 4LO may cause unnecessary noise, tire wear and increased fuel consumption.

If the Four-Wheel Drive (4WD) warning light turns on when driving on dry hard surface roads:

- in the 4H position, shift the 4WD mode switch to 2WD.
- in the 4LO position, stop the vehicle and shift the transmission lever to the "N" (Neutral) position with the brake pedal depressed and shift the 4WD mode switch to 2WD.

If the 4WD warning light is still on after the above operation, have your vehicle checked by a NISSAN dealer as soon as possible.

- The transfer case may be damaged if you continue driving with the 4WD warning light blinking.

See "On-pavement and off-road driving precautions" (P.5-8) for other precautions.

### PART TIME 4WD SYSTEM

The part time 4WD system provides three drive modes: 2WD, 4H and 4LO. The desired drive mode can be selected using the 4WD mode switch according to the driving conditions.

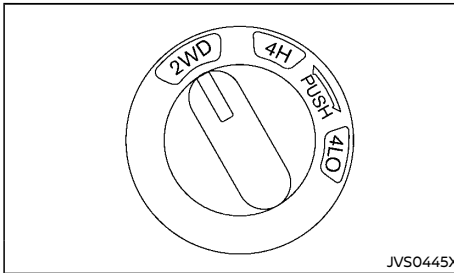



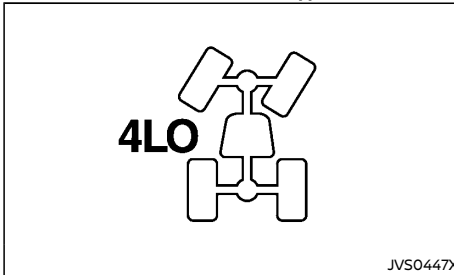

4WD mode switch (Type B)

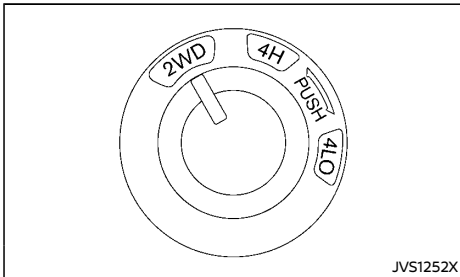

4WD mode indicator



4WD mode switch (Type A)

4WD mode switch	Wheels driven	Indicator		Use conditions	Operation of 4WD mode switch (See "4WD mode switch operation" (P.5-22).)
		4WD mode	4LO		
2WD	Rear wheels		-	For driving on dry, paved roads.	Shifting between the 2WD and 4H drive modes can be done while driving. The indicator will change when the drive mode is changed. Shifting between the 2WD and 4H modes must be performed at speed below 100 km/h (60 MPH).
4H	Four wheels		-	For driving on rough, sandy or snow-covered roads.	
4LO	Neutral		Blinking	The 4LO indicator blinks when shifting between 4H and 4LO.	Shifting between the 4H and 4LO drive modes: <ul style="list-style-type: none"> <li>Stop the vehicle, depress the brake pedal and move the shift lever to the N (Neutral) position.</li> <li>Depress and turn the 4WD mode switch. The 4WD mode switch will not shift between 4H and 4LO if the transmission is not in the N (Neutral) position or the vehicle is moving.</li> <li>Wait for the 4LO indicator to stop blinking and stay on or off before shifting your transmission into gear or releasing the clutch pedal (MT model).</li> </ul>
	Four wheels		Stay on*	For use when maximum power and traction are required at low speeds (for example, on steep grades or rocky, sandy, muddy roads).	

\*: When the 4LO position is selected, the VDC system is disabled and the VDC off indicator light illuminates. See "Vehicle Dynamic Control (VDC) off indicator light" (P.2-19).



### WARNING:

**AT model:** If the 4WD mode indicator is "OFF" or the ATP warning light is "ON", this indicates that the automatic transmission P (Park) position will not function and could result in the vehicle moving unexpectedly, causing serious personal injury or property damage. Always set the parking brake.



### CAUTION:

To avoid vehicle damage:

- Do not operate the 4WD mode switch when cornering, reversing or if the rear wheels are spinning freely. The vehicle must be moving straight ahead.

- Do not move the shift lever (AT model) or release the clutch pedal (MT model) when the 4LO indicator is blinking. Failure to do this may cause the gears to grind and damaging the powertrain.
- MT model: Do not accelerate rapidly from a stopped position when the 4LO indicator is blinking. Drive straight ahead at a low speed until the 4LO indicator is lit. The 4LO indicator blinks when shifting between 4LO and 4H.
- If the 4WD warning light comes on, perform the following procedure:
  - Turn off the engine.
  - Start the engine.
  - Check if the 4WD warning light comes on.

If the 4WD warning light is still on after

following the above procedure, have the system checked and serviced immediately by a NISSAN dealer.

The transfer case 4WD mode switch is used to select either Two-Wheel Drive (2WD) or Four-Wheel Drive (4WD) depending on the driving conditions. Turn the 4WD mode switch to select a drive mode (2WD, 4H or 4LO).

To change into or out of 4LO mode:

- The vehicle MUST BE standing still.
- Depress the brake pedal and move the shift lever to N (Neutral).
- Depress and turn the 4WD mode switch to change into or out of 4LO.

**WARNING:**

- AT model: When parking, apply the parking brake before stopping the engine and make sure that the 4WD mode indicator is on and that the ATP warning light is off, otherwise, the vehicle could unexpectedly move even if the automatic transmission is in the P (Park) position.
- The 4LO indicator must stop blinking and remain on or turn off before shifting the transmission into gear. The vehicle may move unexpectedly if the shift lever is shifted from the N (Neutral) position to any other gear while the 4LO indicator is blinking.

**CAUTION:**

- Never turn the 4WD mode switch between 4LO and 4H while driving.
- The 4H drive mode provides greater power and traction. Avoid excessive speed as it will cause increased fuel consumption and higher oil temperatures, and could damage power train components. Speeds over 100 km/h (60 MPH) in 4H are not recommended.
- The 4LO drive mode provides maximum power and traction. Avoid raising vehicle speed excessively. The maximum speed is approximately 50 km/h (30 MPH).
- The 4WD mode switch can be turned between 2WD and 4H while driving straight ahead. Do not turn the 4WD mode switch while making a turn or reversing.
- Do not turn the 4WD mode switch between 2WD and 4H while driving on steep downhill grades. Use the engine brake

and low transmission gears for engine braking.

- Do not turn the 4WD mode switch between 2WD and 4H with the rear wheels spinning.
- Do not drive the vehicle in 4H or 4LO mode on dry, hard surfaced roads. This may cause unnecessary noise and tire wear. NISSAN recommends driving in 2WD under these conditions.
- It is not possible to shift the 4WD transfer case between 4H and 4LO at low ambient temperatures when the engine is cold. Doing so may cause the 4LO indicator to blink. Wait until the 4WD transfer case has reached operational temperature (after driving for a while) before using the 4WD mode switch to change between 4H and 4LO.

When driving on rough roads

- Set the 4WD mode switch to 4H or 4LO.
- Drive carefully and according to the road surface conditions.

If the vehicle gets stuck

- Place stones or wooden blocks under the tires to free the vehicle.
- Set the 4WD mode switch to 4H or 4LO.
- Use the rear differential locking system (if equipped). Turn the switch on while the vehicle is stationary and apply the throttle to try to free the vehicle.
- If it is difficult to free the vehicle, drive the vehicle forwards and backwards to increase the momentum. If the vehicle is stuck deep in mud, tire chains may be effective.

**CAUTION:**

- Do not spin the wheels excessively. The wheels will sink deep into the mud and it will be difficult to free the vehicle from the mud.
- Avoid shifting gears with the engine running at high speeds as this may cause a malfunction.

4WD MODE SWITCH OPERATION

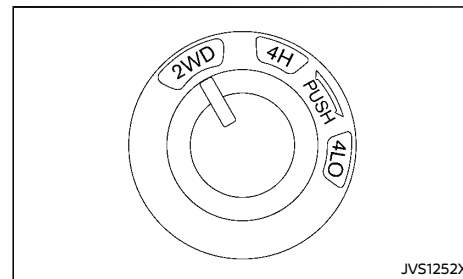

Type A

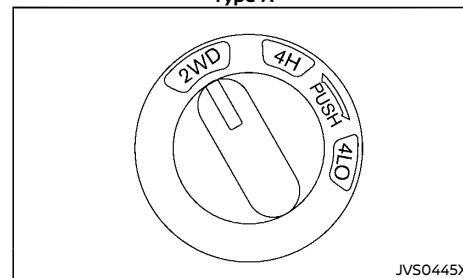

Type B

- Set the 4WD mode switch to 2WD, 4H or 4LO, depending on driving conditions.
- You may feel a slight vehicle movement if the 4WD mode switch is operated while making a turn, accelerating or decelerating, or if the ignition switch is placed in the "OFF" position while the 4WD mode switch is set to 4H or 4LO. This is normal.
- When the vehicle is stopped after making a turn, you may feel a slight jolt after the shift lever is moved to N (Neutral) or P (Park). This occurs because the transfer clutch is released and not because of a malfunction.

**CAUTION:**

- **The 4WD mode switch can be turned between 2WD and 4H while driving straight ahead. Do not turn the 4WD mode switch while making a turn or reversing.**
- **Do not operate the 4WD mode switch while driving on steep downhill grades. Use the engine brake and low automatic transmission gears for engine braking.**
- **Do not operate the 4WD mode switch with the rear wheels spinning.**
- **Before turning the 4WD mode switch to 4H from 2WD, make sure that the vehicle speed is less than 100 km/h (60 MPH). Failure to do so can damage the 4WD system.**
- **Never turn the 4WD mode switch between 4LO and 4H while driving.**

### 4WD MODE INDICATOR

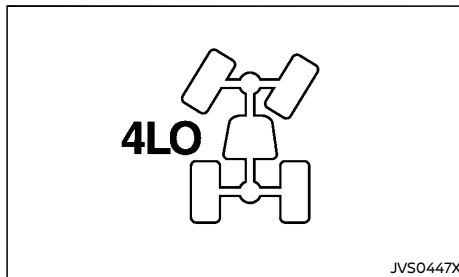



The 4WD mode indicator is displayed in the vehicle information display.

While the engine is running, the 4WD mode indicator will illuminate the position selected by the 4WD mode switch.

- **The 4WD mode indicator may blink while shifting from one drive mode to the other. When the shifting is completed, the 4WD mode indicator will come on. If the indicator does not come on immediately, make sure the area around the vehicle is safe, and drive the vehicle straight, accelerate or decelerate or move the vehicle in reverse, then shift the 4WD mode switch.**
- **When the 4WD mode indicator blinks even if you switch the 4WD mode switch from 2WD or 4H to 4LO, move the vehicle and depress the brake pedal, then shift the transmission lever to the "N" (Neutral) position. If the 4WD mode indicator is still blinking after the operation, perform the procedure again.**
- If the 4WD warning light comes on or 4WD system fault warning appears, the 4WD mode indicator turns off.

### 4WD WARNING

#### Warning light

Warning light	Comes on or blinks when:
 Illuminates	There is a malfunction in the 4WD system
 Blinks	The difference in wheel rotation is large

The Four-Wheel Drive (4WD) warning light is located in the meter.

The 4WD warning light comes on when the ignition switch is placed in the "ON" position. It turns off soon after the engine is started.

If any malfunction occurs in the 4WD system when the ignition switch is in the "ON" position, the 4WD warning light will either remain illuminated or blink.

If the 4WD warning light comes on, the 4WD mode indicator turns off.

A large difference between the diameters of front and rear wheels will make the 4WD warning light blink. Change the 4WD mode switch to 2WD and do not drive fast.

**CAUTION:**

- **If the 4WD warning light comes on or blinks during operation for a while, have your vehicle checked by a NISSAN dealer as soon as possible.**
- **Shifting between 4H and 4LO is not recommended when the 4WD warning light turns on.**

- When the 4WD warning light comes on, the 2WD mode may be engaged even if the 4WD mode switch is in 4H. Be especially careful when driving. If corresponding parts are malfunctioning, the 4WD mode will not be engaged even if the 4WD mode switch is shifted.
- Do not drive the vehicle in the 4H or 4LO position on dry hard surface roads. Driving on dry, hard surfaces in 4H or 4LO may cause unnecessary noise, tire wear and increased fuel consumption.

If the 4WD warning light turns on when driving on dry hard surface roads:

- in the 4H position, shift the 4WD mode switch to 2WD.
- in the 4LO position, stop the vehicle and shift the transmission lever to the “N” (Neutral) position with the brake pedal depressed and shift the 4WD mode switch to 2WD.

If the 4WD warning light is still on after the above operation, have your vehicle checked by a NISSAN dealer as soon as possible.

- The transfer case may be damaged if you continue driving with the warning light blinking.

## Warning indicator

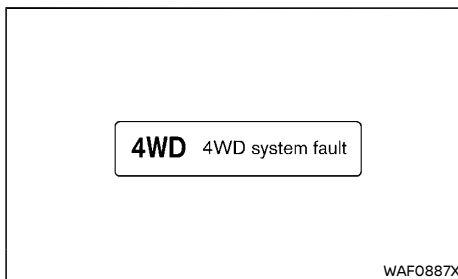

If any malfunction occurs in the Four-Wheel Drive (4WD) system while the engine is running, a warning message appears in the vehicle information display.

If the “4WD system fault” warning appears, there may be a malfunction in the 4WD system. Reduce vehicle speed and have your vehicle checked by a NISSAN dealer as soon as possible.



### CAUTION:

- Do not operate the engine on a free roller when any of the wheels raised.
- If the “4WD system fault” warning appears while driving, there may be a malfunction in the 4WD system. Reduce the vehicle speed and have your vehicle checked by a NISSAN dealer as soon as possible. Be especially careful when driving.
- The power train may be damaged if you continue driving with the “4WD system fault” warning on.

## TIRE RECOMMENDATION FOR 4WD



### CAUTION:

- Always use tires of the same size, brand, construction (bias, bias-belted or radial), and tread pattern on all four wheels. Failure to do so may result in a circumference difference between tires on the front and rear axles, which will cause excessive tire wear and may damage the transmission, transfer case and differential gears.
- ONLY use spare tires specified for the Four-Wheel Drive (4WD) models.

If excessive tire wear is found, it is recommended that all four tires be replaced with tires of the same size, brand, construction and tread pattern. The tire pressure and wheel alignment should also be checked and corrected as necessary. Contact a NISSAN dealer.

### Snow tires

If you install snow tires, they must also be of the same size, brand, construction and tread pattern on all four wheels.

### Tire inflation pressure

Periodically check the pressures of all tires, including the spare, with a gauge while at a service station. If necessary, adjust to the specified pressure. Tire pressures are shown on the tire placard affixed to the driver's side center pillar.

## DRIVE MODE SELECTOR SWITCH (if equipped)

### Tire rotation

NISSAN recommends that tires should be rotated every 5,000 km (3,000 miles).

### Snow chains

**Snow chains must be installed only on the rear wheels and not on the front wheels.**

Do not drive with snow chains on paved roads that are clear of snow. Driving with chains in such conditions can cause damage to the various mechanisms of the vehicle due to overstress. When driving on clear paved roads, be sure to change to Two-Wheel Drive (2WD) mode.

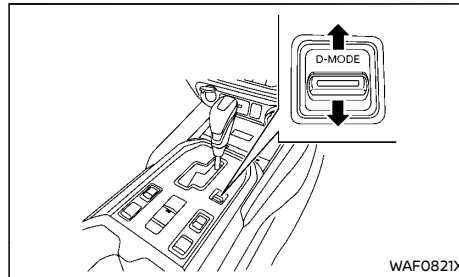

Drive Mode Selector switch

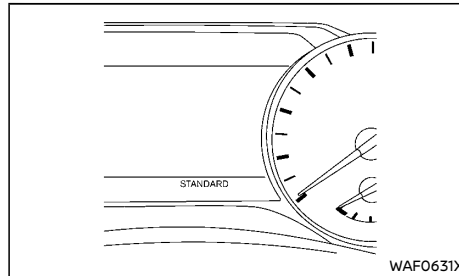

Vehicle information display

Four driving modes can be selected by using the Drive Mode Selector switch: SAND, SPORT, STANDARD, ECO.

#### NOTE:

**When the Drive Mode Selector switch selects a mode, the mode may not switch immediately. This is not a malfunction.**

The current mode is displayed in the vehicle information display.

To change the mode, push the Drive Mode Selector switch up or down. The mode list will appear in the vehicle information display and you can select the mode.

The following driving mode can be selected depending on the 4WD mode switch positions.

4WD mode switch position	Drive Mode
2WD	SPORT
	STANDARD
	ECO
4H	SAND
	SPORT
4LO	STANDARD
	STANDARD

#### NOTE:

**The mode list will be turned off in approximately 6 seconds after the mode is selected.**

If the driving mode cannot be switched using the Drive Mode Selector switch when the ignition switch is in the "ON" position, have the system checked by a NISSAN dealer.



#### WARNING:

**Do not stare at the Drive Mode Selector switch or the display while driving so that full attention may be given to vehicle operation.**

**SAND MODE** (selectable when 4WD mode is 4H)

Allows for easier driving in the sand/desert condition.

In the sand mode, AT gear ratio is selected lower gear to improve road-running ability in sand/desert.



**CAUTION:**

**Never drive on dry, hard surface roads in the SAND mode, as this will overload the power-train and may cause a serious malfunction. Additionally, this will cause premature tire wear and reduced fuel economy.**

**SPORT MODE** (selectable when 4WD mode is 2WD or 4H)

Adjusts the engine and transmission points for a higher response.

**NOTE:**

**In the SPORT mode, fuel economy may be reduced.**

**STANDARD MODE** (selectable when 4WD mode is 2WD or 4H or 4LO)

Allows for optimum driving according to the driving conditions.

This mode will be selected first each time the ignition switch is placed in the "ON" position.

**ECO MODE** (selectable when 4WD mode is 2WD)

Allows the driver to drive economically.

In ECO mode, gear ratio is selected higher gear to get better fuel economy, and response sensitivity of accelerator pedal becomes slow to support economical driving.

**NOTE:**

**Selecting the ECO mode will not necessarily improve fuel economy as many driving factors influence its effectiveness.**

## REAR DIFFERENTIAL LOCKING SYSTEM (if equipped)

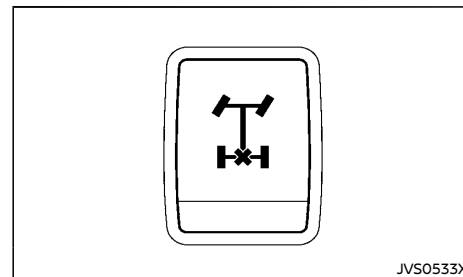

The rear differential lock is designed to transmit engine power to the left and right wheels equally.

If your vehicle is stuck in sand, snow, mud, etc. or one wheel is off the ground and the differential lock is not on, engine power is transmitted to one wheel causing it to spin, so leaving insufficient traction on the other wheel. The rear differential lock allows the left and right wheels to rotate as a unit, enabling your vehicle to free itself.

To lock the rear differential gear, reduce the vehicle speed below 7 km/h (4 MPH) and turn the 4WD mode switch to the 4LO position. Then push the differential lock mode switch to the "ON" position. The differential lock indicator light "  " will blink in the meter and then stay on when the differential gear is completely locked.

After using the rear differential lock, or during normal driving, push the differential lock mode switch to the "OFF" position. The differential lock indicator light will turn off after the differential lock is released.

- **The rear differential lock-up device operates only when the engine is running.**



## VEHICLE DYNAMIC CONTROL (VDC) SYSTEM (if equipped)

- In 4H mode, the rear differential lock-up device does not operate when the differential lock mode switch is turned to the "ON" position. (The differential lock indicator light will flash.)







### WARNING:

- Use the rear differential lock only in an emergency when it is not possible to free a stuck vehicle even using the 4LO position.
- When the differential lock is in operation, turning the vehicle becomes hard and, especially at high speeds, is dangerous.
- While differential lock is on, the Anti-lock Braking System (ABS) warning light and the Vehicle Dynamic Control (VDC) off indicator light illuminate. This indicates that anti-lock function may not fully operate.
- Do not operate the differential lock when the vehicle is turning or when one side wheel is rotating. Otherwise the power train system parts could be damaged.
- Avoid quick starts while the differential lock is in operation. Otherwise the power train system parts could be damaged.

Observe the above precautions. Otherwise, loss of normal steering control may result.



### WARNING:

- The Vehicle Dynamic Control (VDC) system is designed to help the driver maintain stability but does not prevent accidents due to abrupt steering operation at high speeds or by careless or dangerous driving techniques. Reduce vehicle speed and be especially careful when driving and cornering on slippery surfaces and always drive carefully.
- Do not modify the vehicle's suspension. If suspension parts such as shock absorbers, struts, springs, stabilizer bars, bushings and wheels are not NISSAN recommended for your vehicle or are extremely deteriorated, the VDC system may not operate properly. This could adversely affect vehicle handling performance, and the VDC warning light  may illuminate.
- If brake related parts such as brake pads, rotors and calipers are not NISSAN recommended or are extremely deteriorated, the VDC system may not operate properly and the VDC warning light  may illuminate.
- If engine control related parts are not NISSAN recommended or are extremely deteriorated, the VDC warning light  may illuminate.
- When driving on extremely inclined surfaces such as higher banked corners, the VDC system may not operate properly and the VDC warning light  may illuminate. Do not drive on these types of roads.
- When driving on an unstable surface such as a turntable, ferry, elevator or ramp, the

VDC warning light  may illuminate. This is not a malfunction. Restart the engine after driving onto a stable surface.

- If wheels or tires other than the NISSAN recommended ones are used, the VDC system may not operate properly and the VDC warning light  may illuminate.
- The VDC system is not a substitute for winter tires or tire chains on a snow covered road.

The Vehicle Dynamic Control (VDC) system uses various sensors to monitor driver inputs and vehicle motion. Under certain driving conditions, the VDC system helps to perform the following functions.



- Controls brake pressure to reduce wheel slip on one slipping drive wheel so power is transferred to a non slipping drive wheel on the same axle.
- Controls brake pressure and engine output to reduce drive wheel slip based on vehicle speed (traction control function).
- Controls brake pressure at individual wheels and engine output to help the driver maintain control of the vehicle in the following conditions:
  - understeer (vehicle tends to not follow the steered path despite increased steering input)
  - oversteer (vehicle tends to spin due to certain road or driving conditions).

The VDC system can help the driver to maintain control of the vehicle, but it cannot prevent loss of vehicle control in all driving situations.

When the VDC system operates, the VDC warning light  in the instrument panel flashes so note the following:

- The road may be slippery or the system may determine some action is required to help the vehicle on the steered path.
- You may feel a pulsation in the brake pedal and hear a noise or vibration from under the hood. This is normal and indicates that the VDC system is working properly.
- Adjust your speed and driving to the road conditions.

If a malfunction occurs in the system, the VDC warning light  illuminates in the instrument panel. The VDC system automatically turns off.

The VDC OFF switch is used to turn off the VDC system. The VDC off indicator light  illuminates to indicate the VDC system is off. When the VDC OFF switch is used to turn off the system, the VDC system still operates to prevent one drive wheel from slipping by transferring power to a non slipping drive wheel. The VDC warning light  flashes if this occurs. All other VDC functions are off and the VDC warning light  will not flash. The VDC system is automatically reset to on when the ignition switch is placed in the "OFF" position then back to the "ON" position.

When the 4LO position is selected with the Four-Wheel Drive (4WD) mode switch, the VDC system is disabled and the VDC off indicator light illuminates. (4WD models)

See "Vehicle Dynamic Control (VDC) warning light" (P.2-17) and "Vehicle Dynamic Control (VDC) off indicator light" (P.2-19).

The computer has a built-in diagnostic feature that tests the system each time you start the engine and move the vehicle forward or in reverse at a slow speed. When the self-test occurs, you may hear a "clunk" noise and/or feel a pulsation in the brake pedal. This is normal and is not an indication of a malfunction.

## 5-28 Starting and driving

### VEHICLE DYNAMIC CONTROL (VDC) OFF SWITCH

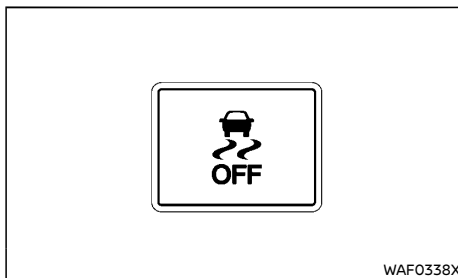

The vehicle should be driven with the Vehicle Dynamic Control (VDC) system ON for most driving conditions.

When the vehicle is stuck in mud or snow, the VDC system reduces the engine output to reduce wheel spin. The engine speed will be reduced even if the accelerator is depressed to the floor. If maximum engine power is needed to free a stuck vehicle, turn the VDC system off.

To turn off the Vehicle Dynamic Control (VDC) system, push the VDC OFF switch. The VDC off indicator light  will illuminate.

Push the VDC OFF switch again or restart the engine to turn ON the system.

## HILL DESCENT CONTROL SYSTEM (if equipped)



### WARNING:

- **Never rely solely on the hill descent control system to control vehicle speed when driving on steep downhill grades. Always drive carefully when using the hill descent control system and decelerate the vehicle speed by depressing the brake pedal if necessary. Be especially careful when driving on frozen, muddy or extremely steep downhill roads. Failure to control vehicle speed may result in a loss of control of the vehicle and possible serious injury or death.**
- **The hill descent control system may not control the vehicle speed on a hill under all load or road conditions. Always be prepared to depress the brake pedal to control vehicle speed. Failure to do so may result in a collision or serious personal injury.**

When the hill descent control system is activated, it automatically applies smooth brakes to control speed on a steep and slippery descent or off the road without brake or accelerator operation. The hill descent control system helps maintain vehicle speed when driving under 25 km/h (16 MPH) on a steep descent that engine braking alone in the 4H or 4LO mode cannot control the speed.

### NOTE:

**When the hill descent control system operates continuously for a long time, the temperature of the Vehicle Dynamic Control (VDC) system actuator may increase and the hill descent control system may be temporarily disabled. The hill descent control system on indicator light will turn off. The hill descent control system will resume operat-**

ing automatically and the indicator light will illuminate again when the temperature of the VDC system actuator is reduced. If the indicator light does not illuminate, turn off the system.

#### HILL DESCENT CONTROL SWITCH

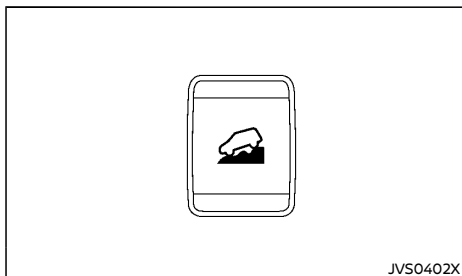

When additional braking is required on steep downhill roads, activate the hill descent control system by pushing the hill descent control switch on.

When the hill descent control system is activated, the hill descent control system on indicator light will illuminate. (See "Hill descent control system ON indicator light" (P.2-18).) Also, the stop/tail lights illuminate while the hill descent control system is applying the brakes to control the vehicle speed.

To activate the hill descent control system, satisfy all of the following conditions:

- Shift the transmission to the forward or reverse gear.
- Shift the 4WD mode switch to the 4H or 4LO position and drive the vehicle at a speed under 25 km/h (16 MPH).

- Push the hill descent control switch to the "ON" position.

If the accelerator or brake pedal is depressed while the hill descent control system is on, the system will stop operating temporarily. As soon as the accelerator or brake pedal is released, the hill descent control system begins to function again if the hill descent control operating conditions are fulfilled.

The hill descent control system on indicator light blinks if the hill descent control switch is on and all conditions for system activation are not met, or if the system becomes disengaged for any reason.

To turn off the hill descent control system, push the hill descent control switch to the "OFF" position.

## HILL START ASSIST SYSTEM (if equipped)



### WARNING:

- **Never rely solely on the hill start assist system to prevent the vehicle from moving backward on a hill. Always drive carefully and attentively. Depress the brake pedal when the vehicle is stopped on a steep hill. Be especially careful when stopped on a hill on frozen or muddy roads. Failure to prevent the vehicle from rolling backwards may result in a loss of control of the vehicle and possible serious injury or death.**
- **The hill start assist system is not designed to hold the vehicle at a standstill on a hill. Depress the brake pedal when the vehicle is stopped on a steep hill. Failure to do so may cause the vehicle to roll backwards and may result in a collision or serious personal injury.**
- **The hill start assist system may not prevent the vehicle from rolling backwards on a hill under all load or road conditions. Always be prepared to depress the brake pedal to prevent the vehicle from rolling backwards. Failure to do so may result in a collision or serious personal injury.**

The hill start assist system automatically keeps the brakes applied to help prevent the vehicle from rolling backwards in the time it takes the driver to release the brake pedal and apply the accelerator when the vehicle is stopped on a hill.

The hill start assist system will operate automatically under the following conditions:

- The transmission is shifted to a forward or reverse gear.

## LANE DEPARTURE WARNING (LDW) (if equipped)

- The vehicle is stopped completely on a hill by applying the brake.

The maximum holding time is 2 seconds. After 2 seconds the vehicle will begin to roll back and the hill start assist system will stop operating completely.

The hill start assist system will not operate when the transmission is shifted to the "N" (Neutral) or "P" (Park) position or on a flat and level road.

When the Vehicle Dynamic Control (VDC) warning light illuminates in the meter, the hill start assist system will not operate. (See "Warning lights, indicator lights and audible reminders" (P.2-12).)



### WARNING:

**Failure to follow the warnings and instructions for proper use of the LDW system could result in serious personal injury or death.**

- **The LDW system will not steer the vehicle or prevent loss of control. It is the driver's responsibility to stay alert, drive safely, keep the vehicle in the traveling lane, and be in control of the vehicle at all times.**

The LDW system will operate when the vehicle is driven at speeds of approximately 70 km/h (43 MPH) and above, and only when the lane markings are clearly visible on the road.

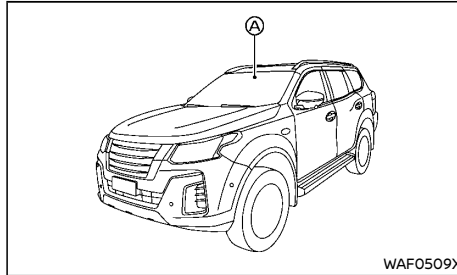

The LDW system monitors the lane markers on the traveling lane using the camera unit (A) located above the inside rearview mirror.

The LDW system warns the driver with the LDW indicator and chime that the vehicle is beginning to leave the driving lane. For additional information, refer to "LDW system operation" (P.5-31).

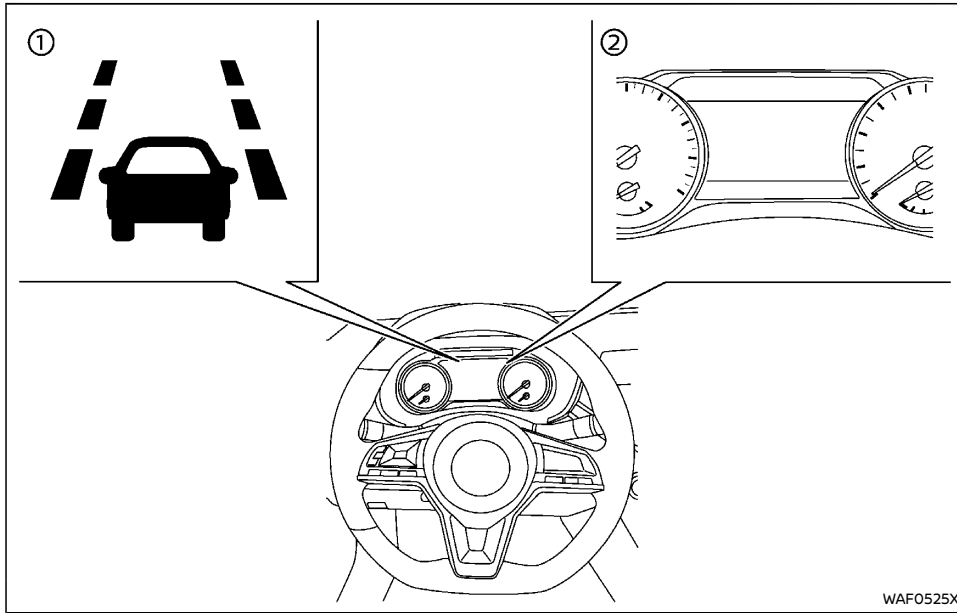

**NOTE:**

The LDW system is not designed to warn when you operate the lane change signal and change traveling lanes in the direction of the signal. (The LDW system will become operable again approximately 2 seconds after the lane change signal is turned off.)

- ① LDW indicator (on the vehicle information display)
- ② Vehicle information display

**LDW SYSTEM OPERATION**

The LDW system operates above approximately 70 km/h (43 MPH) and when the lane markings are clear.

If the vehicle approaches either the left or right side of the traveling lane, the LDW indicator (orange) on the vehicle information display will flash and a warning chime will sound.

WAF0525X

## HOW TO ENABLE/DISABLE THE LDW SYSTEM

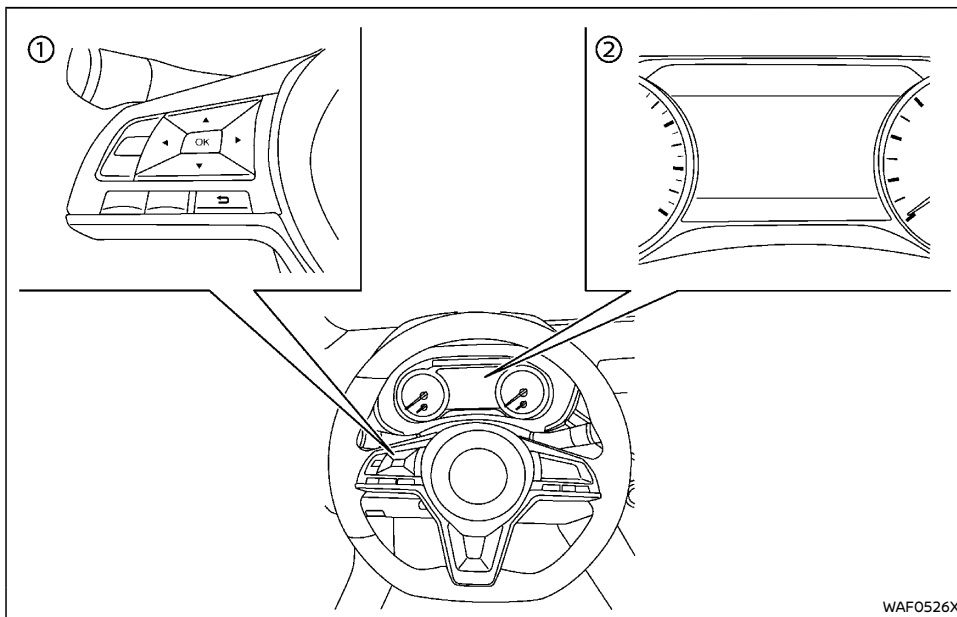

① Steering-wheel-mounted controls (left side)

② Vehicle information display

Perform the following steps to enable or disable the LDW system.

1. Press the ◀ ▶ button until "Settings" appears in the vehicle information display. Use the ⬇ button to select "Driver Assistance". Then press the "OK" button.

2. Select "Lane" and press the "OK" button.

3. To set the LDW system to on or off, use the ⬆ ⬇ buttons to navigate in the menu and use the "OK" button to select or change an item:

- To turn on the LDW system, use the "OK" button to check the box for "Warning (LDW)".

### NOTE:

When enabling/disabling the system, the system will retain current settings even if the engine is restarted.

### LDW SYSTEM LIMITATIONS



#### WARNING:

Listed below are the system limitations for the LDW system. Failure to follow the warnings and instructions for proper use of the LDW system could result in serious injury or death.

- The system will not operate at speeds below approximately 70 km/h (43 MPH) or if it cannot detect lane markers.
- Excessive noise will interfere with the warning chime sound, and the chime may not be heard.
- Do not use the LDW system under the following conditions as it may not function properly:
  - During bad weather (rain, fog, snow, etc.).
  - When driving on slippery roads, such as on ice or snow.
  - When driving on winding or uneven roads.
  - When there is a lane closure due to road repairs.
  - When driving in a makeshift or temporary lane.
  - When driving on roads where the lane width is too narrow.
  - When driving without normal tire conditions (for example, tire wear, low tire pressure, installation of spare

- tire, tire chains, non-standard wheels).
- When the vehicle is equipped with non-original brake parts or suspension parts.
- When you are towing a trailer or other vehicle (for South Africa).
- The system may not function properly under the following conditions:
  - On roads where there are multiple parallel lane markers; lane markers that are faded or not painted clearly; yellow painted lane markers; non-standard lane markers; or lane markers covered with water, dirt, snow, etc.
  - On roads where discontinued lane markers are still detectable.
  - On roads where there are sharp curves.
  - On roads where there are sharply contrasting objects, such as shadows, snow, water, wheel ruts, seams or lines remaining after road repairs. (The LDW system could detect these items as lane markers.)
  - On roads where the traveling lane merges or separates.
  - When the vehicle's traveling direction does not align with the lane marker.
  - When traveling close to the vehicle in front of you, which obstructs the lane camera unit detection range.
  - When rain, snow, dirt or object adheres to the windshield in front of the lane camera unit.

- When the headlights are not bright due to dirt on the lens or if the aiming is not adjusted properly.
- When strong light enters the lane camera unit. (For example, the light directly shines on the front of the vehicle at sunrise or sunset.)
- When a sudden change in brightness occurs. (For example, when the vehicle enters or exits a tunnel or under a bridge.)

#### SYSTEM TEMPORARILY UNAVAILABLE

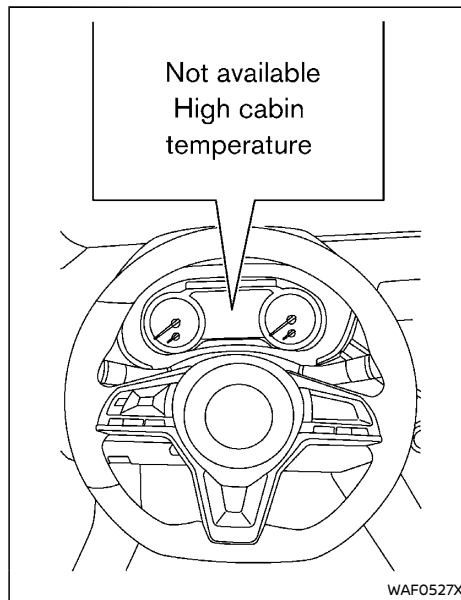

If the vehicle is parked in direct sunlight under high temperature conditions (over approximately 40°C (104°F)) and then started, the LDW system may be deactivated automatically and the following message will appear in the vehicle information display: "Not available: High cabin temperature".

When the interior temperature is reduced, the LDW system will resume operating automatically.

The LDW system is not designed to warn under the following conditions:

- When you operate the lane change signal and change traveling lanes in the direction of the signal. (The LDW system will become operable again approximately 2 seconds after the lane change signal is turned off.)
- When the vehicle speed lowers to less than approximately 70 km/h (43 MPH).

After the above conditions have finished and the necessary operating conditions are satisfied, the LDW system will resume.

#### SYSTEM MALFUNCTION

If the LDW system malfunctions, it will cancel automatically and "System Malfunction" will appear in the vehicle information display. If "System Malfunction" appears in the vehicle information display, pull off the road to a safe location and stop the vehicle. Place the ignition switch in the "OFF" position and restart the engine. If "System Malfunction" continues to appear in the vehicle information display, have the system checked at a NISSAN dealer.

## BLIND SPOT WARNING (BSW) (if equipped)

### SYSTEM MAINTENANCE

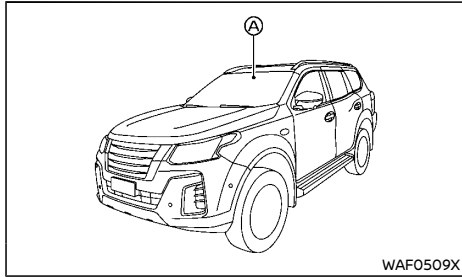

The lane camera unit (A) for the LDW system is located above the inside rearview mirror.

To keep the proper operation of the LDW system and prevent a system malfunction, be sure to observe the following:

- Always keep the windshield clean.
- Do not attach a sticker (including transparent material) or install an accessory near the camera unit.
- Do not place reflective materials, such as white paper or a mirror, on the instrument panel. The reflection of sunlight may adversely affect the camera unit's capability of detecting the lane markers.
- Do not strike or damage the areas around the camera unit. Do not touch the camera lens or remove the screw located on the camera unit. If the camera unit is damaged due to an accident, it is recommended that you visit a NISSAN dealer.



### WARNING:

Failure to follow the warnings and instructions for proper use of the BSW system could result in serious injury or death.

- The BSW system is not a replacement for proper driving procedures and is not designed to prevent contact with vehicles or objects. When changing lanes, always use the side and rear mirrors and turn and look in the direction your vehicle will move to ensure it is safe to change lanes. **Never rely solely on the BSW system.**

The BSW system helps alert the driver of other vehicles in adjacent lanes when changing lanes.

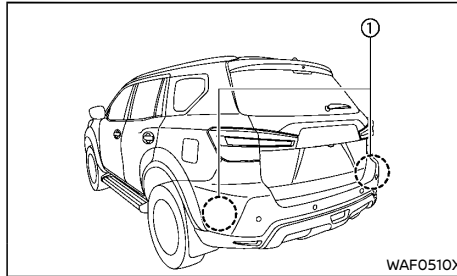

The BSW system uses radar sensors (1) installed near the rear bumper to detect other vehicles in an adjacent lane.

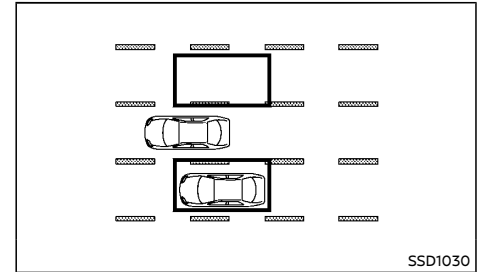

### Detection zone

The radar sensors can detect vehicles on either side of your vehicle within the detection zone shown as illustrated. This detection zone starts from the outside mirror of your vehicle and extends approximately 3.0 m (10 ft) behind the rear bumper, and approximately 3.0 m (10 ft) sideways.



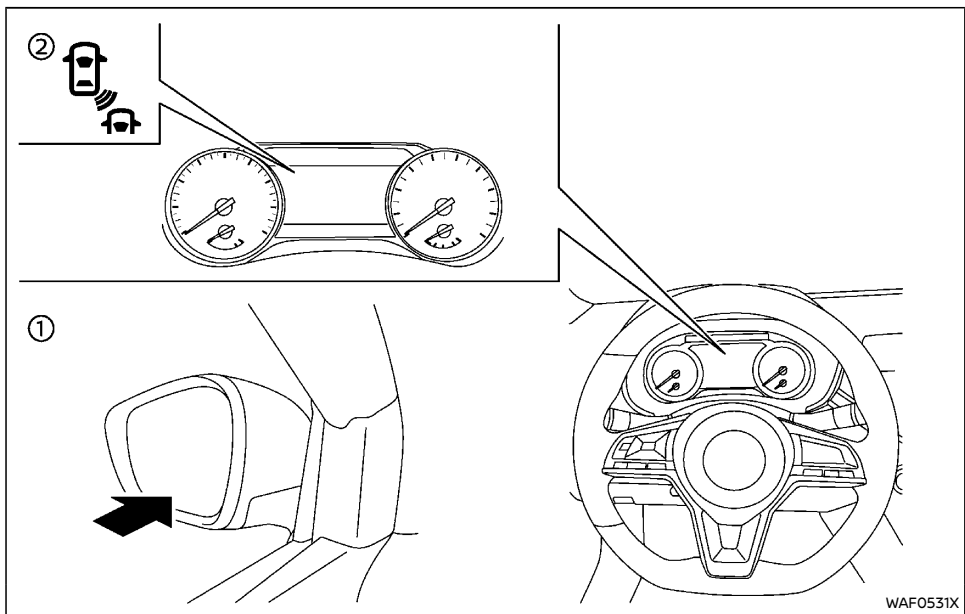

- ① Side indicator light
- ② BSW indicator (on the vehicle information display)

### BSW SYSTEM OPERATION

The BSW system operates above approximately 32 km/h (20 MPH).

If the radar sensors detect a vehicle in the detection zone, the side indicator light ① illuminates.

If the turn signal is then activated, the system chimes (twice) and the side indicator light flashes. The side indicator light continues to flash until the detected vehicle leaves the detection zone.

The side indicator light illuminates for a few

seconds when the ignition switch is placed in the "ON" position.

The brightness of the side indicator light is adjusted automatically depending on the brightness of the ambient light.

If a vehicle comes into the detection zone after the driver activates the turn signal, then only the side indicator light flashes and no chime sounds. For additional information, refer to "BSW driving situations" (P.5-37).

## HOW TO ENABLE/DISABLE THE BSW SYSTEM

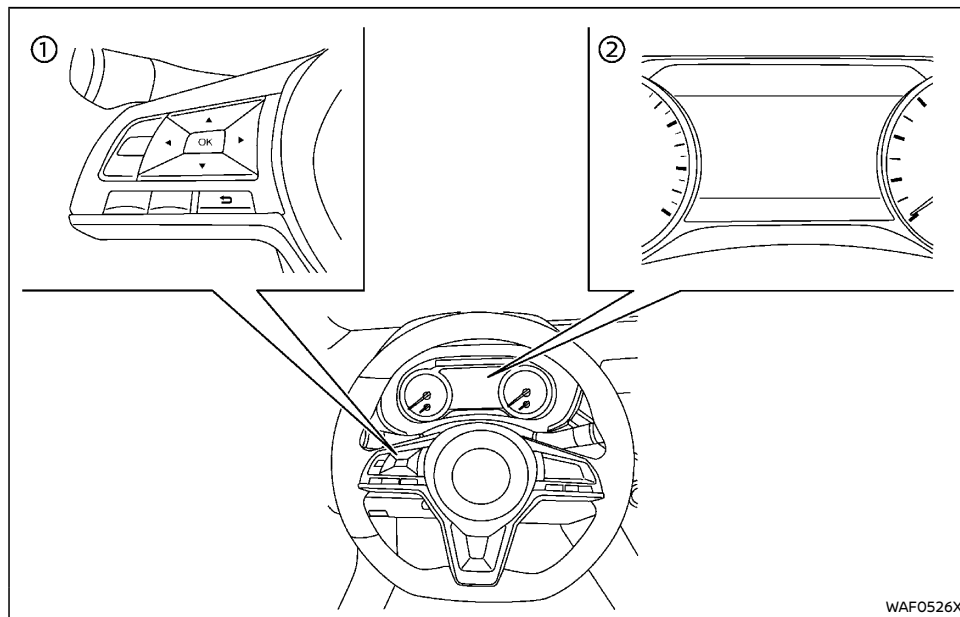

① Steering-wheel-mounted controls (left side)

② Vehicle information display

Perform the following steps to enable or disable the BSW system.

1. Press the ◀ ▶ button until "Settings" appears in the vehicle information display. Use the ⬇ button to select "Driver Assistance". Then press the "OK" button.

2. Select "Blind Spot" and press the "OK" button.

3. To set the BSW system to on or off, use the ⬆ buttons to navigate in the menu and use the "OK" button to select or change an item:

- To turn on the BSW system, use the "OK" button to check the box for "Warning (BSW)".

## NOTE:

When enabling/disabling the system, the system will retain current settings even if the engine is restarted.

## BSW SYSTEM LIMITATIONS



### WARNING:

Listed below are the system limitations for the BSW system. Failure to operate the vehicle in accordance with these system limitations could result in serious injury or death.

- The BSW system cannot detect all vehicles under all conditions.
- The radar sensors may not be able to detect and activate BSW when certain objects are present such as:
  - Pedestrians, bicycles, animals.
  - Vehicles such as motorcycles, low height vehicles, or high ground clearance vehicles.
  - Oncoming vehicles.
  - Vehicles remaining in the detection zone when you accelerate from a stop.
  - A vehicle merging into an adjacent lane at a speed approximately the same as your vehicle.
  - A vehicle approaching rapidly from behind.
  - A vehicle which your vehicle overtakes rapidly.
  - A vehicle that passes through the detection zone quickly.

– When overtaking several vehicles in a row, the vehicles after the first vehicle may not be detected if they are traveling close together.

- The radar sensor's detection zone is designed based on a standard lane width. When driving in a wider lane, the radar sensors may not detect vehicles in an adjacent lane. When driving in a narrow lane, the radar sensors may detect vehicles driving two lanes away.
- The radar sensors are designed to ignore most stationary objects, however objects such as guardrails, walls, foliage and parked vehicles may occasionally be detected. This is a normal operation condition.
- The following conditions may reduce the ability of the radar to detect other vehicles:
  - Severe weather
  - Road spray
  - Ice/frost/dirt build-up on the vehicle
- Do not attach stickers (including transparent material), install accessories or apply additional paint near the radar sensors. These conditions may reduce the ability of the radar to detect other vehicles.
- Excessive noise (for example, audio system volume, open vehicle window) will interfere with the chime sound, and it may not be heard.

## BSW DRIVING SITUATIONS

Indicator on



Indicator off



Indicator flashing



Another vehicle approaching from behind

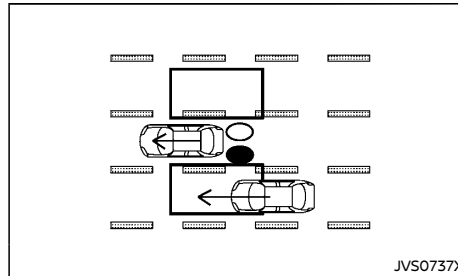

**Illustration 1 – Approaching from behind**

Illustration 1: The side indicator light illuminates if a vehicle enters the detection zone from behind in an adjacent lane.

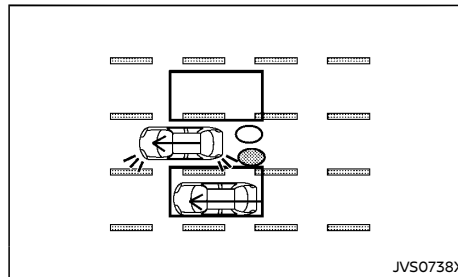

**Illustration 2 – Approaching from behind**

Illustration 2: If the driver activates the turn

signal, then the system chimes (twice) and the side indicator light flashes.

### NOTE:

- The radar sensors may not detect vehicles which are approaching rapidly from behind.
- If the driver activates the turn signal before a vehicle enters the detection zone, the side indicator light will flash but no chime will sound when the other vehicle is detected.

Overtaking another vehicle

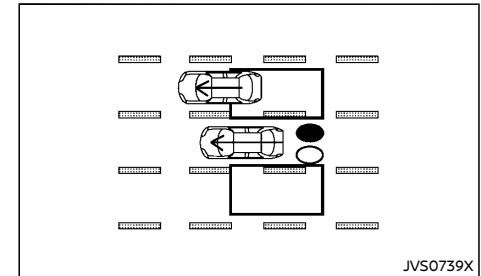

**Illustration 3 – Overtaking another vehicle**

Illustration 3: The side indicator light illuminates if you overtake a vehicle and that vehicle stays in the detection zone for approximately 2 seconds.

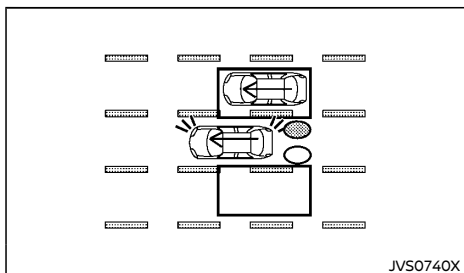

**Illustration 4 - Overtaking another vehicle**

Illustration 4: If the driver activates the turn signal while another vehicle is in the detection zone, then the system chimes (twice) and the side indicator light flashes.

**NOTE:**

- When overtaking several vehicles in a row, the vehicles after the first vehicle may not be detected if they are traveling close together.
- The radar sensors may not detect slower moving vehicles if they are passed quickly.
- If the driver activates the turn signal before a vehicle enters the detection zone, the side indicator light will flash but no chime will sound when the other vehicle is detected.

**Entering from the side**

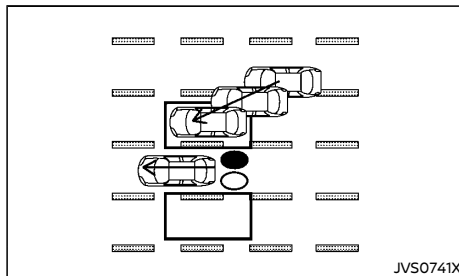

**Illustration 5 - Entering from the side**

Illustration 5: The side indicator light illuminates if a vehicle enters the detection zone from either side.

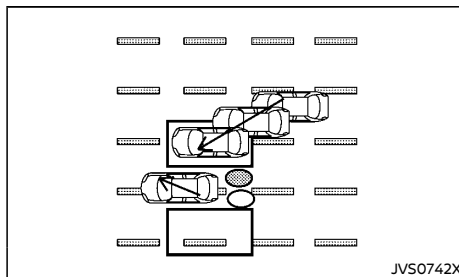

**Illustration 6 - Entering from the side**

If the driver activates the turn signal while another vehicle is in the detection zone, then the system chimes (twice) and the side indicator light flashes.

**NOTE:**

- If the driver activates the turn signal before a vehicle enters the detection zone, the side indicator light will flash but no chime will sound when the other

vehicle is detected.

- The radar sensors may not detect a vehicle which is traveling at about the same speed as your vehicle when it enters the detection zone.

## SYSTEM TEMPORARILY UNAVAILABLE

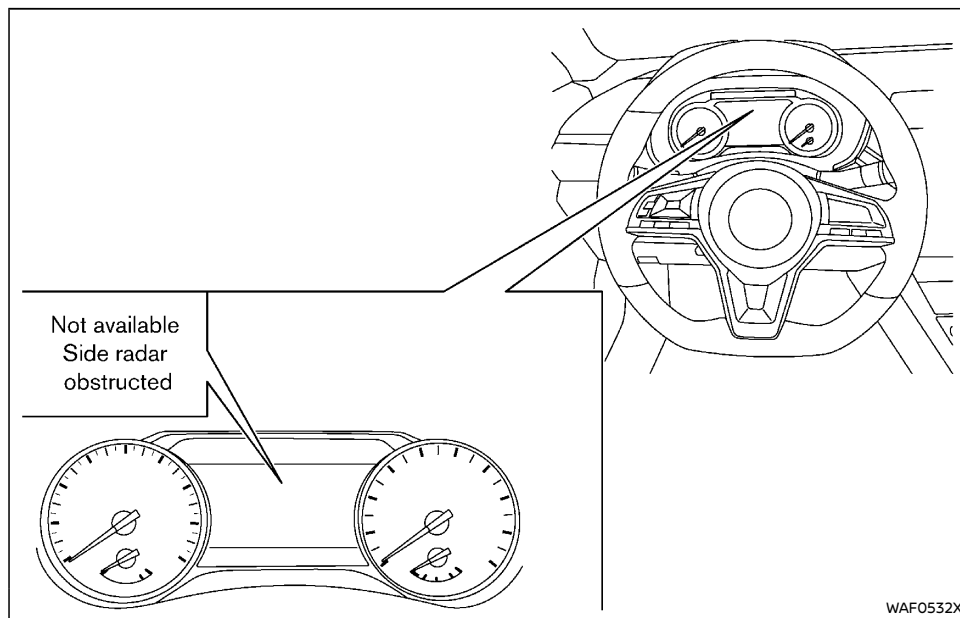

When radar blockage is detected, the BSW system will be turned off automatically, a chime will sound and the "Not available: Side radar obstructed" warning message will appear in the vehicle information display.

The system is not available until the conditions no longer exist.

The radar sensors may be blocked by temporary ambient conditions such as splashing water, mist or fog. The blocked condition may

also be caused by objects such as ice, frost or dirt obstructing the radar sensors.

### NOTE:

**If the BSW system stops working, the RCTA system will also stop working.**

### Action to take:

When the above conditions no longer exist, the system will resume automatically.

If the "Not available: Side radar obstructed"

warning message continues to appear, have the system checked by a NISSAN dealer.

## SYSTEM MALFUNCTION

When the BSW system malfunctions, it will be turned off automatically and the "System Malfunction" warning message will appear in the vehicle information display.

### NOTE:

**If the BSW system stops working, the RCTA system will also stop working.**

### Action to take:

Stop the vehicle in a safe location, turn the engine off and restart the engine. If the message continues to appear, have the BSW system checked by a NISSAN dealer.

## SYSTEM MAINTENANCE

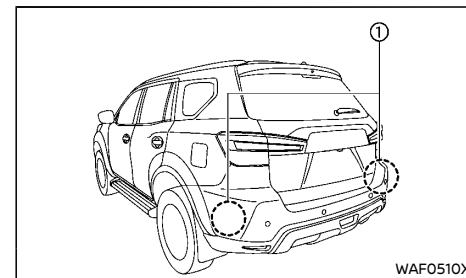

The two radar sensors ① for the BSW system are located near the rear bumper. Always keep the area near the radar sensors clean.

The radar sensors may be blocked by temporary ambient conditions such as splashing water, mist or fog.

The blocked condition may also be caused by objects such as ice, frost or dirt obstructing the

## REAR CROSS TRAFFIC ALERT (RCTA) (if equipped)

radar sensors.

Check for and remove objects obstructing the area around the radar sensors.

Do not attach stickers (including transparent material), install accessories or apply additional paint near the radar sensors.

Do not strike or damage the area around the radar sensors.

See a NISSAN dealer if the area around the radar sensors is damaged due to a collision.

For the radio approval numbers and information, see "Radio approval number and information" (P.9-12).



### WARNING:

**Failure to follow the warnings and instructions for proper use of the RCTA system could result in serious injury or death.**

- **The RCTA system is not a replacement for proper driving procedures and is not designed to prevent contact with vehicles or objects. When backing out of a parking space, always use the side and rear mirrors and turn and look in the direction your vehicle will move. Never rely solely on the RCTA system.**

The RCTA system will assist you when backing out from a parking space. When the vehicle is in reverse, the system is designed to detect other vehicles approaching from the right or left of the vehicle. If the system detects cross traffic, it will alert you.

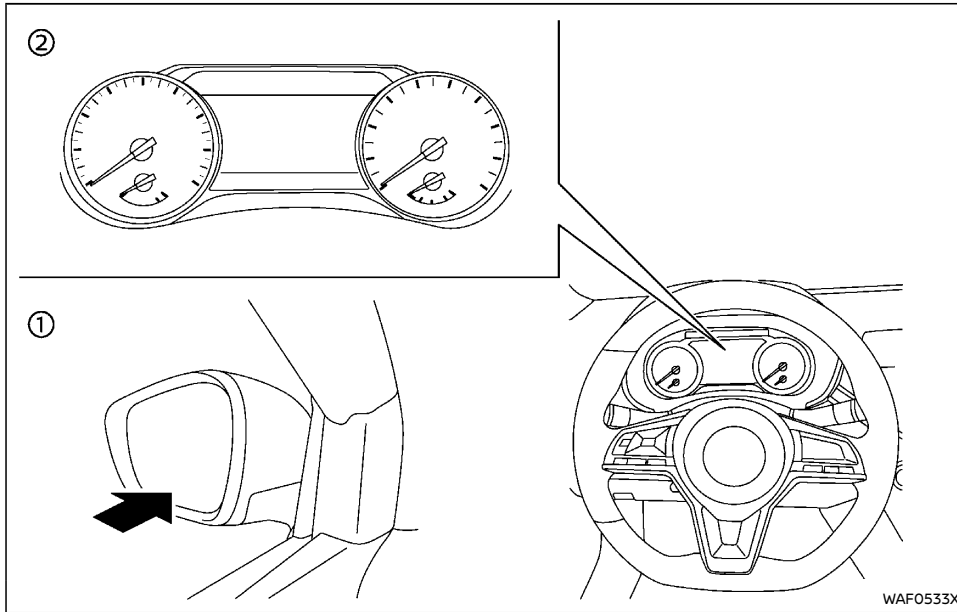

- ① Side indicator light
- ② Vehicle information display

### RCTA SYSTEM OPERATION

The RCTA system can help alert the driver of an approaching vehicle when the driver is backing out of a parking space.

When the shift position is in "R" (Reverse) and the vehicle speed is less than approximately 8 km/h (5 MPH), the RCTA system is operational.

If the radar detects an approaching vehicle from either side, the system chimes (once) and the side indicator light flashes on the side the vehicle is approaching from.

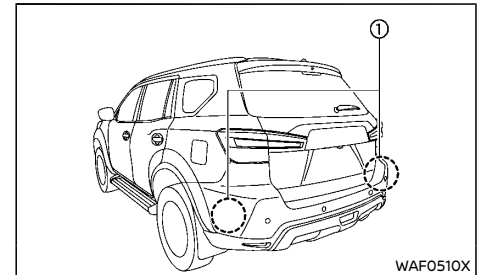
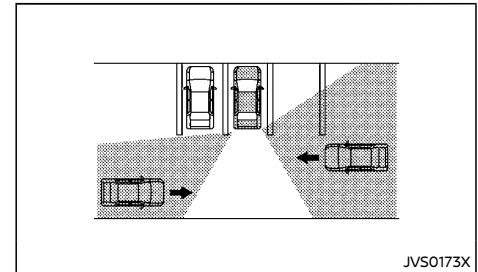

The RCTA system uses radar sensors ① installed on both sides near the rear bumper to detect an approaching vehicle.

The radar sensors ① can detect an approaching vehicle from up to approximately 20 m (66 ft) away.

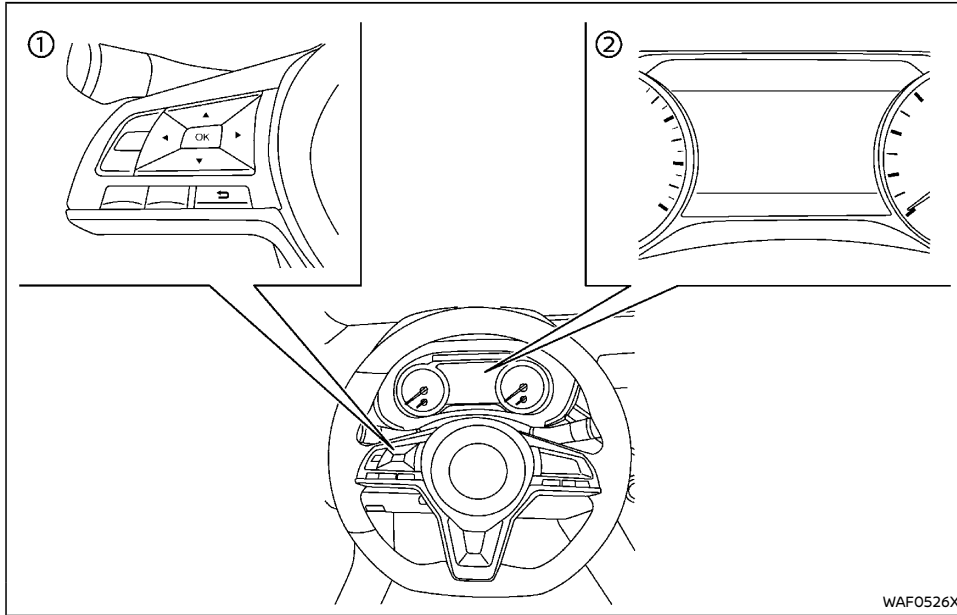

## HOW TO ENABLE/DISABLE THE RCTA SYSTEM



WAF0526X

- ① Steering-wheel-mounted controls (left side)
  - ② Vehicle information display
1. Use the  button to select "Cross Traffic Alert" and press the "OK" button to turn on or off the RCTA system.

Perform the following steps to enable or disable the RCTA system.

1. Press the   button until "Settings" appears in the vehicle information display. Use the  button to select "Driver Assistance". Then press the "OK" button.

### NOTE:

**When enabling/disabling the system, the system setting will be retained even if the engine is restarted.**



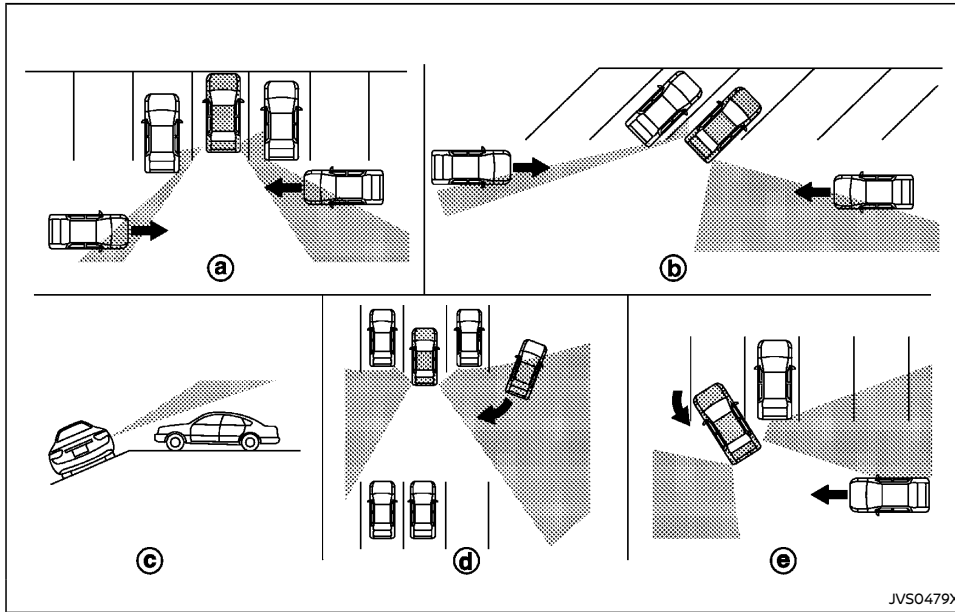

JV50479X

## RCTA SYSTEM LIMITATIONS

### WARNING:

Listed below are the system limitations for the RCTA system. Failure to operate the vehicle in accordance with these system limitations could result in serious injury or death.

- Always check surroundings and turn to check what is behind you before backing up. The radar sensors detect approaching (moving) vehicles. The radar sensors

cannot detect every object such as:

- Pedestrians, bicycles, motorcycles, animals or child-operated toy vehicles
- A vehicle that is passing at speeds greater than approximately 30 km/h (19 MPH)
- A vehicle that is passing at speeds lower than approximately 8 km/h (5 MPH)

- The radar sensors may not detect approaching vehicles in certain situations:
  - Illustration (a): When a vehicle parked next to you obstructs the beam of the radar sensor.
  - Illustration (b): When the vehicle is parked in an angled parking space.
  - Illustration (c): When the vehicle is parked on inclined ground.
  - Illustration (d): When an approaching vehicle turns into your vehicle's parking lot aisle.
  - Illustration (e): When the angle formed by your vehicle and approaching vehicle is small
- The following conditions may reduce the ability of the radar to detect other vehicles:
  - Severe weather
  - Road spray
  - Ice/frost/dirt build-up on the vehicle
- Do not attach stickers (including transparent material), install accessories or apply additional paint near the radar sensors. These conditions may reduce the ability of the radar to detect other vehicles
- Excessive noise (e.g. audio system volume, open vehicle window) will interfere with the chime sound, and it may not be heard.

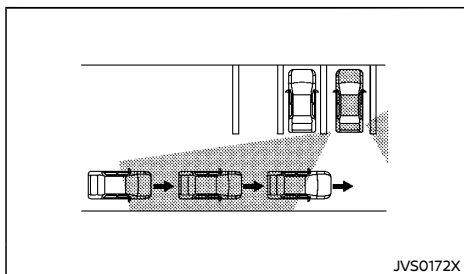

Illustration 1

JVS0172X

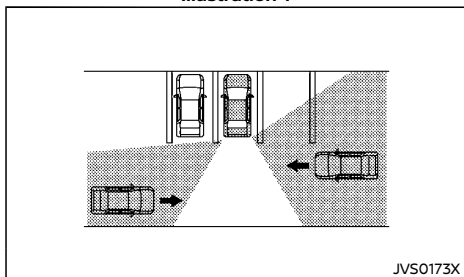

Illustration 2

JVS0173X

**NOTE:**

In the case of several vehicles approaching in a row (Illustration 1) or in the opposite direction (Illustration 2), a chime may not be sounded by the RCTA system after the first vehicle passes the sensors.

**SYSTEM TEMPORARILY UNAVAILABLE**

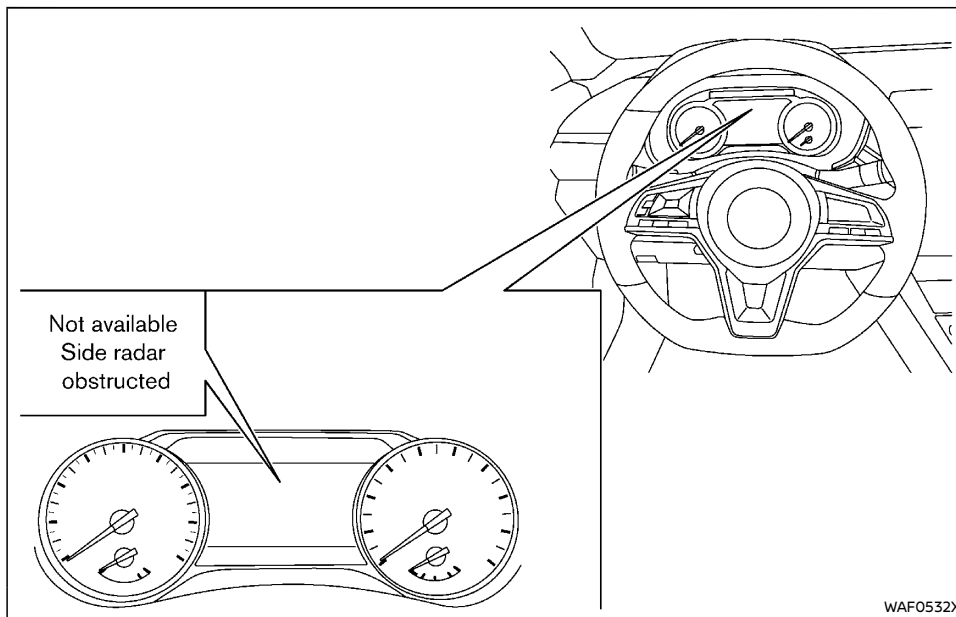

WAF0532X

When radar blockage is detected, the system will be deactivated automatically. The "Not available: Side radar obstructed" warning message will appear in the vehicle information display.

The systems are not available until the conditions no longer exist.

The radar sensors may be blocked by temporary ambient conditions such as splashing water, mist or fog.

The blocked condition may also be caused by objects such as ice, frost or dirt obstructing the radar sensors.

**NOTE:**

**If the BSW system stops working, the RCTA system will also stop working.**

### Action to take:

When the above conditions no longer exist, the system will resume automatically.

### SYSTEM MALFUNCTION

When the RCTA system malfunctions, it will turn off automatically. The "System fault" warning message will appear in the vehicle information display.

### NOTE:

If the BSW system stops working, the RCTA system will also stop working.

### Action to take:

Stop the vehicle in a safe location, turn the engine off and restart the engine. If the message continues to appear, have the system checked by a NISSAN dealer.

### SYSTEM MAINTENANCE

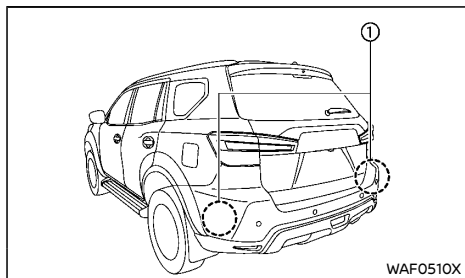

The two radar sensors ① for the RCTA systems are located near the rear bumper. Always keep the area near the radar sensors clean.

The radar sensors may be blocked by temporary ambient conditions such as splashing water, mist or fog.

The blocked condition may also be caused by

objects such as ice, frost or dirt obstructing the radar sensors.

Check for and remove objects obstructing the area around the radar sensors.

Do not attach stickers (including transparent material), install accessories or apply additional paint near the radar sensors.

Do not strike or damage the area around the radar sensors. It is recommended that you visit a NISSAN dealer if the area around the radar sensors is damaged due to a collision.

For the radio approval numbers and information, see "Radio approval number and information" (P.9-12).

## CRUISE CONTROL (if equipped)

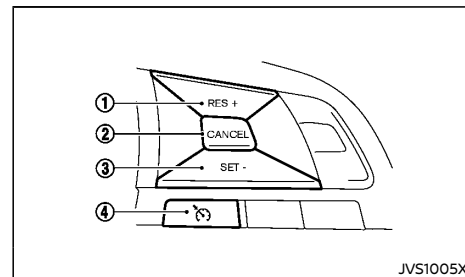

1. RES+ switch
2. CANCEL switch
3. SET- switch
4. Cruise control MAIN switch



### WARNING:

- Always observe the posted speed limits and do not set the speed over them.
- Do not use the cruise control when driving under the following conditions. Doing so could cause a loss of vehicle control and result in an accident.
  - When it is not possible to keep the vehicle at a constant speed
  - When driving in heavy traffic
  - When driving in traffic that varies speed
  - When driving in windy areas
  - When driving on winding or hilly roads
  - When driving on slippery (rain, snow, ice, etc.) roads



### CAUTION:

**On manual Transmission (MT) model, do not shift to the "N" (Neutral) position without depressing the clutch pedal when the cruise control is operated. Should this occur, depress the clutch pedal and turn the Cruise ON/OFF switch off immediately. Failure to do so may cause engine damage.**

### PRECAUTIONS ON CRUISE CONTROL

- If the cruise control system malfunctions, it will cancel automatically. The CRUISE indicator in the vehicle information display will then blink to warn the driver.
- If the CRUISE indicator blinks, turn the cruise control MAIN switch off and have the system checked by a NISSAN dealer.
- The CRUISE indicator may blink when the cruise control MAIN switch is turned ON while pushing the RES+, SET– or CANCEL switch. To properly set the cruise control system, perform the following procedures.

### CRUISE CONTROL OPERATIONS

The cruise control allows driving at speeds above 40 km/h (25 MPH) without keeping your foot on the accelerator pedal.

Except for YS23DDTT engine models, the cruise control will automatically be canceled if the vehicle slows down more than approximately 13 km/h (8 MPH) below the set speed.

For YS23DDTT engine models, the cruise control will automatically be canceled if the vehicle speed slows to less than approximately 33 km/h (21 MPH).

Moving the shift lever to the "N" (Neutral) position will cancel the cruise control.

### Turning on cruise control

Push the cruise control MAIN switch ④. The CRUISE indicator appears.

### Setting cruising speed

1. Accelerate to the desired speed.
2. Push the SET– switch ③ and release it.
3. Take your foot off the accelerator pedal.

The vehicle will maintain the set speed.

### Passing another vehicle:

Depress the accelerator pedal to accelerate. After releasing the accelerator pedal, the vehicle will return to the previously set speed.

The vehicle may not maintain the set speed when going up or down steep hills. In such cases, drive without the cruise control.

### Resetting to slower speed:

Use any one of the following methods to reset to a slower speed.

- Lightly tap the foot brake pedal. When the vehicle reaches the desired speed, push and release the SET– switch ③.
- Push and hold the SET– switch ③. When the vehicle reaches the desired speed, release the SET– switch ③.
- Quickly push and release the SET– switch ③. This will reduce the vehicle speed by about 1 km/h (0.6 MPH).

### Resetting to faster speed:

Use any one of the following methods to reset to a faster speed.

- Depress the accelerator pedal. When the vehicle reaches the desired speed, push and release the SET– switch ③.

- Push and hold the RES+ switch ①. When the vehicle reaches the desired speed, release the RES+ switch ①.
- Quickly push and release the RES+ switch ①. This will increase the vehicle speed by about 1 km/h (0.6 MPH).

### Resuming at preset speed:

Push and release the RES+ switch ①.

The vehicle will resume the last set cruising speed when the vehicle speed is over 40 km/h (25 MPH).

### Canceling cruising speed

Use any one of the following methods to cancel the set speed.

- Push the CANCEL switch ②.
- Tap the foot brake pedal.
- Push the cruise control MAIN switch ④. The CRUISE indicator will turn off.

## INTELLIGENT CRUISE CONTROL (ICC) (if equipped)



### WARNING:

Failure to follow the warnings and instructions for proper use of the ICC system could result in serious injury or death.

- ICC is not a collision avoidance or warning device. For highway use only and it is not intended for congested areas or city driving. Failure to apply the brakes could result in an accident.
- The ICC system is only an aid to assist the driver and is not a collision warning or avoidance device. It is the driver's responsibility to stay alert, drive safely, and be in control of the vehicle at all times.
- Always observe posted speed limits and do not set the speed over them.
- Always drive carefully and attentively when using either cruise control mode. Read and understand the Owner's Manual thoroughly before using the cruise control. To avoid serious injury or death, do not rely on the system to prevent accidents or to control the vehicle's speed in emergency situations. Do not use cruise control except in appropriate road and traffic conditions.
- In the conventional (fixed speed) cruise control mode, a warning chime will not sound to warn you if you are too close to the vehicle ahead. Pay special attention to the distance between your vehicle and the vehicle ahead of you or a collision could occur.

The ICC system maintains a selected distance from the vehicle in front of you within the following speed up to the set speed.

- 0 to 160 km/h (0 to 100 MPH)  
The set speed can be selected by the driver between the following speeds.
- 30 to 160 km/h (20 to 100 MPH)  
The vehicle travels at a set speed when the road ahead is clear.  
The ICC system can be set to one of two cruise control modes.
  - Vehicle-to-vehicle distance control mode:  
For maintaining a selected distance between your vehicle and the vehicle in front of you up to the preset speed.
  - Conventional (fixed speed) cruise control mode:  
For cruising at a preset speed.

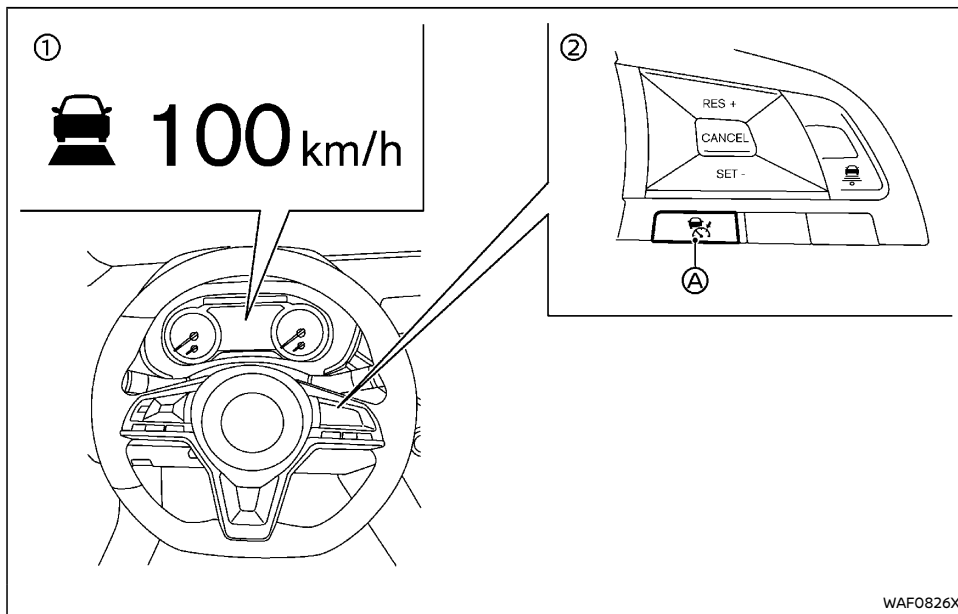

WAF0826X

- ① Displays and indicators
- ② ICC switches
- Ⓐ Cruise ON/OFF switch

Push the Cruise ON/OFF switch Ⓐ to choose the cruise control mode between the vehicle-to-vehicle distance control mode and the conventional (fixed speed) cruise control mode.

Once a control mode is activated, it cannot be changed to the other cruise control mode. To change the mode, push the Cruise ON/OFF switch Ⓐ once to turn the system off. Then push the Cruise ON/OFF switch Ⓐ again to turn

the system back on and select the desired cruise control mode.

Always confirm the setting in the ICC system display.

For the vehicle-to-vehicle distance control mode, see "Vehicle-to-vehicle distance control mode" (P.5-49).

For the conventional (fixed speed) cruise control mode, see "Conventional (fixed speed) cruise control mode" (P.5-58).

## HOW TO SELECT THE CRUISE CONTROL MODE

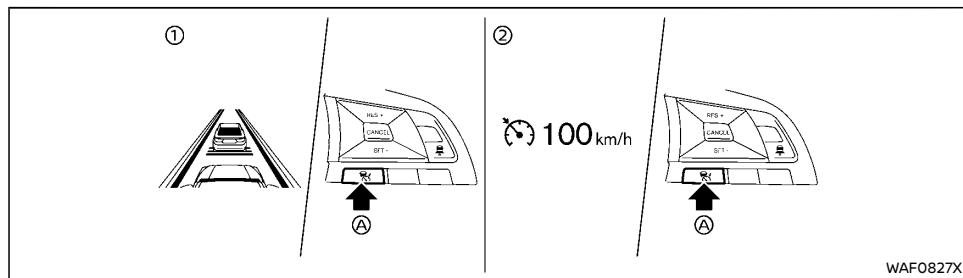

### Selecting the vehicle-to-vehicle distance control mode

To choose the vehicle-to-vehicle distance control mode ①, quickly push and release the Cruise ON/OFF switch (A).

### Selecting the conventional (fixed speed) cruise control mode

To choose the conventional (fixed speed) cruise control mode ②, push and hold the Cruise ON/OFF switch (A) for longer than approximately 1.5 seconds. See "Conventional (fixed speed) cruise control mode" (P.5-58).

## VEHICLE-TO-VEHICLE DISTANCE CONTROL MODE

In the vehicle-to-vehicle distance control mode, the ICC system automatically maintains a selected distance from the vehicle traveling in front of you according to that vehicle's speed (up to the set speed), or at the set speed when the road ahead is clear.

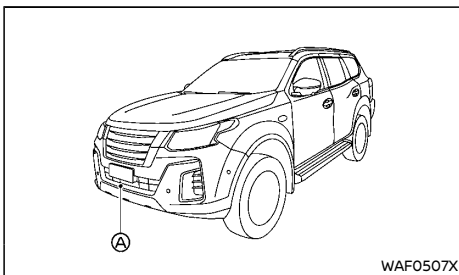

The system is intended to enhance the operation of the vehicle when following a vehicle traveling in the same lane and direction.

If the radar sensor (A) detects a slower moving vehicle ahead, the system will reduce the vehicle speed so that your vehicle follows the vehicle in front at the selected distance.

The system automatically controls the throttle and applies the brakes (up to approximately 40% of vehicle braking power) if necessary.

The detection range of the sensor is approximately 200 m (650 ft) ahead.

## Vehicle-to-vehicle distance control mode operation

The vehicle-to-vehicle distance control mode is designed to maintain a selected distance from the vehicle in front of you and can reduce the speed to match a slower vehicle ahead. The system will decelerate the vehicle as necessary and if the vehicle ahead comes to a stop, the vehicle decelerates to a standstill. However, the ICC system can only apply up to 40% of the vehicle's total braking power.

This system should only be used when traffic conditions allow vehicle speeds to remain fairly constant or when vehicle speeds change gradually. If a vehicle moves into the traveling lane ahead or if a vehicle traveling ahead rapidly decelerates, the distance between vehicles may become closer because the ICC system cannot decelerate the vehicle quickly enough. If this occurs, the ICC system will sound a warning chime and blink the system display to notify the driver to take necessary action.

The system will cancel and a warning chime will sound if the speed is below approximately 25 km/h (15 MPH) and a vehicle is not detected ahead. The system will also disengage when the vehicle goes above the maximum set speed.

See "Approach warning" (P.5-53).

The following items are controlled in the vehicle-to-vehicle distance control mode:

- When there are no vehicles traveling ahead, the vehicle-to-vehicle distance control mode maintains the speed set by the driver. The set speed range is between approximately 30 to 160 km/h (20 to 100 MPH).

- When there is a vehicle traveling ahead, the vehicle-to-vehicle distance control mode adjusts the speed to maintain the distance, selected by driver, from the vehicle ahead. The adjusting speed range is up to the set speed. If the vehicle ahead comes to a stop, the vehicle decelerates to a standstill within the limitations of the system. The system will cancel once it judges a standstill with a warning chime.
- When the vehicle traveling ahead has moved out from its lane of travel, the vehicle-to-vehicle distance control mode accelerates and maintains vehicle speed up to the set speed.

The ICC system does not control vehicle speed or warn you when you approach stationary and slow moving vehicles. You must pay attention to vehicle operation to maintain proper distance from vehicles ahead when approaching toll gates or traffic congestion.

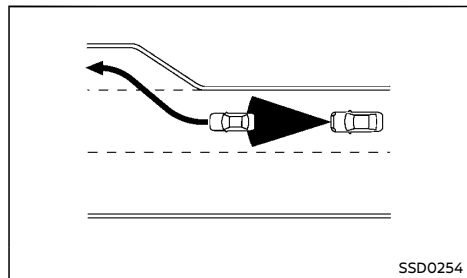

When driving on the freeway at a set speed and approaching a slower traveling vehicle ahead, the ICC system will adjust the speed to maintain the distance, selected by the driver, from the vehicle ahead. If the vehicle ahead changes lanes or exits the freeway, the ICC system will accelerate and maintain the speed up to the

set speed. Pay attention to the driving operation to maintain control of the vehicle as it accelerates to the set speed.

The vehicle may not maintain the set speed on winding or hilly roads. If this occurs, you will have to manually control the vehicle speed.

Normally when controlling the distance to a vehicle ahead, this system automatically accelerates or decelerates your vehicle according to the speed of the vehicle ahead. Depress the accelerator to properly accelerate your vehicle when acceleration is required for a lane change. Depress the brake pedal when deceleration is required to maintain a safe distance to the vehicle ahead due to its sudden braking or if a vehicle cuts in. Always stay alert when using the ICC system.

### Vehicle-to-vehicle distance control mode switches

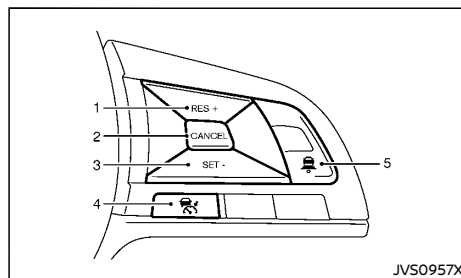

The system is operated by the CRUISE ON/OFF switch and four control switches, all mounted on the steering wheel.

1. RES + switch:  
Resumes set speed or increases speed incrementally.

2. CANCEL switch:  
Deactivates the system without erasing the set speed.
3. SET - switch:  
Sets desired cruise speed or reduces speed incrementally.
4. CRUISE ON/OFF switch:  
Master switch to activate the system
5. DISTANCE switch:  
Changes the vehicle's following distance:
  - Long
  - Middle
  - Short

### Vehicle-to-vehicle distance control mode display and indicators

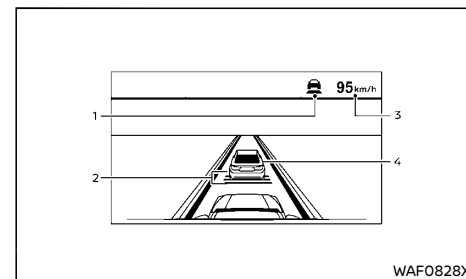

The display is located between the speedometer and tachometer.

1. This indicator indicates the ICC system status depending on a color.
  - ICC system ON indicator (gray):  
Indicates that the Cruise ON/OFF switch is ON.



- ICC system set indicator (green):  
Indicates that cruising speed is set
  - ICC system warning (yellow):  
Indicates that there is a malfunction in the ICC system.
2. Set distance indicator:  
Displays the selected distance between vehicles set with the DISTANCE switch.
  3. Set vehicle speed indicator:  
Indicates the set vehicle speed.
  4. Vehicle ahead detection indicator:  
Indicates whether it detects a vehicle in front of you.

### Operating vehicle-to-vehicle distance control mode

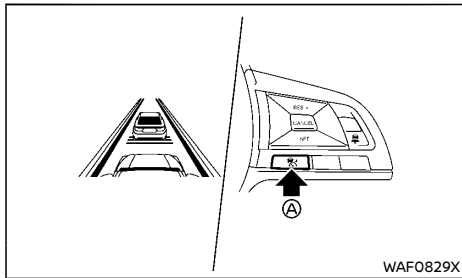

**To turn on the cruise control**, quickly push and release the CRUISE ON/OFF switch **A**. The ICC system ON indicator (gray), set distance indicator and set vehicle speed indicator come on and in a standby state for setting.

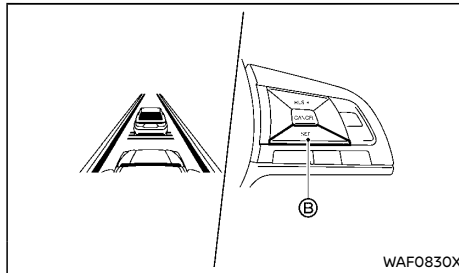

**To set cruising speed**, accelerate your vehicle to the desired speed, push the SET - switch **B** and release it. (The ICC system set indicator (green), vehicle ahead detection indicator, set distance indicator and set vehicle speed indicator come on.) Take your foot off the accelerator pedal. Your vehicle will maintain the set speed.

When the SET - switch **B** is pushed under the following conditions, the system cannot be set and the ICC indicators will blink for approximately 2 seconds:

- When traveling below 30 km/h (20 MPH) and the vehicle ahead is not detected
- When the shift lever is not in the D (Drive) or manual shift mode
- When the parking brake is applied
- When the brakes are operated by the driver

When the SET - switch **B** is pushed under the following conditions, the system cannot be set.

A warning chime will sound and a message will pop up:

- When the VDC system is off (To use the ICC system, turn on the VDC system. Push the CRUISE ON/OFF switch to turn off the ICC system and reset the ICC system by push-

ing the CRUISE ON/OFF switch again.)

For additional information about the VDC system, see "Vehicle Dynamic Control (VDC) system" (P.5-27).

- When VDC is operating
- When a wheel is slipping (To use the ICC system, make sure the wheels are no longer slipping.)

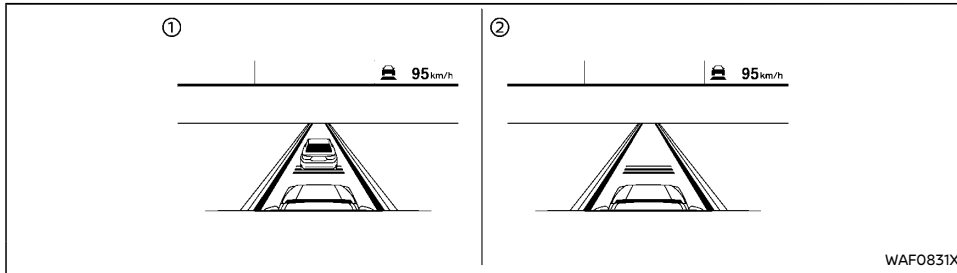

- ① System set display with vehicle ahead  
 ② System set display without vehicle ahead

The driver sets the desired vehicle speed based on the road conditions. The ICC system maintains the set vehicle speed, similar to standard cruise control, as long as no vehicle is detected in the lane ahead.

The ICC system displays the set speed.

#### Vehicle detected ahead:

When a vehicle is detected in the lane ahead, the ICC system decelerates the vehicle by controlling the throttle and applying the brakes to match the speed of a slower vehicle ahead. The system then controls the vehicle speed based on the speed of the vehicle ahead to maintain the driver selected distance.

#### NOTE:

- The stoplights of the vehicle come on when braking is performed by the ICC system.
- When the brake operates, a noise may be heard. This is not a malfunction.

When a vehicle ahead is detected, the vehicle ahead detection indicator comes on. The ICC system will also display the set speed and

selected distance.

#### Vehicle ahead not detected:

When a vehicle is no longer detected ahead, the ICC system gradually accelerates your vehicle to resume the previously set vehicle speed. The ICC system then maintains the set speed.

When a vehicle is no longer detected the vehicle ahead detection indicator turns off.

If a vehicle ahead appears during acceleration to the set vehicle speed or any time the ICC system is in operation, the system controls the distance to that vehicle.

When a vehicle is no longer detected under approximately 25 km/h (15 MPH), the system will be canceled.

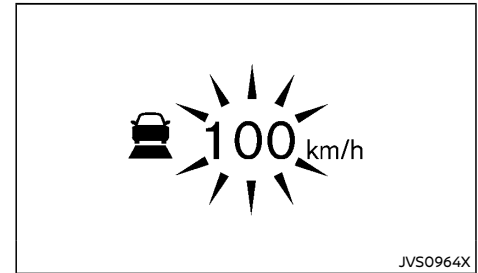

**When passing another vehicle**, the set speed indicator will flash when the vehicle speed exceeds the set speed. The vehicle detect indicator will turn off when the area ahead of the vehicle is open. When the pedal is released, the vehicle will return to the previously set speed.

Even though your vehicle speed is set in the ICC system, you can depress the accelerator pedal when it is necessary to accelerate your vehicle rapidly.

#### How to change the set vehicle speed

**To cancel the preset speed**, use any of these methods:

- Push the CANCEL switch. The set vehicle speed indicator will go out.
- Tap the brake pedal. The set vehicle speed indicator will go out.
- Turn the CRUISE ON/OFF switch off. The ICC indicators will go out.

**To reset at a faster cruising speed**, use one of the following methods:

- Depress the accelerator pedal. When the vehicle attains the desired speed, push and release the SET - switch.

- Push and hold the RES + switch. The set vehicle speed will increase by approximately 5 km/h (5 MPH).
- Push, then quickly release the RES + switch. Each time you do this, the set speed will increase by approximately 1 km/h (1 MPH).

**To reset at a slower cruising speed,** use one of the following methods:

- Lightly tap the brake pedal. When the vehicle attains the desired speed, push the SET - switch and release it.
- Push and hold the SET - switch. The set vehicle speed will decrease by approximately 5 km/h (5 MPH).
- Push, then quickly release the SET - switch. Each time you do this, the set speed will decrease by approximately 1 km/h (1 MPH).

**To resume the preset speed,** push and release the RES + switch. The vehicle will resume the last set cruising speed when the vehicle speed is over 30 km/h (20 MPH).

How to change the set distance to the vehicle ahead

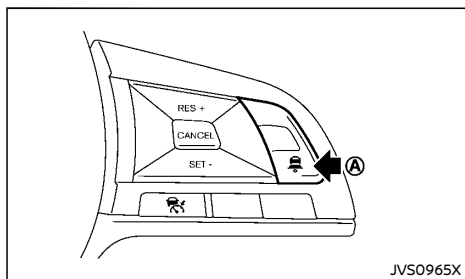

The distance to the vehicle ahead can be selected at any time depending on the traffic conditions.

Each time the DISTANCE switch (A) is pushed, the set distance will change to long, middle, short and back to long again in that sequence.

Distance	Display	Approximate distance at 100 km/h (60 MPH) [m (ft)]
Long		60 (200)
Middle		45 (150)
Short		30 (100)

JVS0966X

- The distance to the vehicle ahead will change according to the vehicle speed. The higher the vehicle speed, the longer the distance.
- If the engine is stopped, the set distance becomes "long". (Each time the engine is started, the initial setting becomes "long".)

### Approach warning

If your vehicle comes closer to the vehicle ahead due to rapid deceleration of that vehicle or if another vehicle cuts in, the system warns the driver with the chime and ICC system display. Decelerate by depressing the brake pedal to maintain a safe vehicle distance if:

- The chime sounds.
- The vehicle ahead detection indicator blinks.

The warning chime may not sound in some cases when there is a short distance between vehicles. Some examples are:

- When the vehicles are traveling at the same speed and the distance between vehicles is not changing
- When the vehicle ahead is traveling faster and the distance between vehicles is increasing

- When a vehicle cuts in near your vehicle

The warning chime will not sound when:

- Your vehicle approaches other vehicles that are parked or moving slowly.
- The accelerator pedal is depressed, overriding the system.

#### NOTE:

**The approach warning chime may sound and the system display may blink when the radar sensor detects objects on the side of the vehicle or on the side of the road. This may cause the ICC system to decelerate or accelerate the vehicle. The radar sensor may detect these objects when the vehicle is driven on winding roads, narrow roads, hilly roads or when entering or exiting a curve. In these cases you will have to manually control the proper distance ahead of your vehicle.**

Also, the sensor sensitivity can be affected by vehicle operation (steering maneuver or driving position in the lane) or traffic or vehicle condition (for example, if a vehicle is being driven with some damage).

#### Automatic cancellation

A chime sounds under the following conditions and the control is automatically canceled.

- When the vehicle ahead is not detected and your vehicle is traveling below the speed of 25 km/h (15 MPH).
- When the system judges the vehicle is at standstill
- When the shift lever is not in the "D" (Drive) position, manual shift mode or "L" (Low) position
- When the parking brake is applied
- When the VDC system is turned off
- When VDC operates
- When distance measurement becomes impaired due to adhesion of dirt or obstruction to the sensor
- When a wheel slips
- When the radar signal is temporarily interrupted
- On repeated uphill and downhill roads

#### Vehicle-to-vehicle distance control mode limitations



#### WARNING:

Listed below are the system limitations for the ICC system. Failure to operate the vehicle in accordance with these system limitations could result in serious injury or death.

- **The ICC system is primarily intended for use on straight, dry, open roads with light traffic. It is not advisable to use the system in city traffic or congested areas.**
- **The ICC system will not adapt automatically to road conditions. This system should be used in evenly flowing traffic.**

**Do not use the system on roads with sharp curves, steep uphill and downhill, or on icy roads, in heavy rain or in fog.**

- **As there is a performance limit to the distance control function, never rely solely on the ICC system. This system does not correct careless, inattentive or absent-minded driving, or overcome poor visibility in rain, fog, or other bad weather. Decelerate the vehicle speed by depressing the brake pedal, depending on the distance to the vehicle ahead and the surrounding circumstances in order to maintain a safe distance between vehicles.**
- **If the vehicle ahead comes to a stop, the vehicle decelerates to a standstill within the limitations of the system. The system will cancel once it judges that the vehicle has come to a standstill and sound a warning chime. To prevent the vehicle from moving, the driver must depress the brake pedal.**
- **Always pay attention to the operation of the vehicle and be ready to manually control the proper following distance. The ICC system may not be able to maintain the selected distance between vehicles (following distance) or selected vehicle speed under some circumstances.**
- **The system may not detect the vehicle in front of you in certain road or weather conditions. To avoid accidents, never use the ICC system under the following conditions:**
  - On roads where the traffic is heavy or there are sharp curves
  - On slippery road surfaces such as on ice or snow, etc.

- **During bad weather (rain, fog, snow, etc.)**
- **When rain, snow or dirt adhere to the system sensor**
- **On steep downhill roads (the vehicle may go beyond the set vehicle speed and frequent braking may result in overheating the brakes)**
- **On repeated uphill and downhill roads**
- **When traffic conditions make it difficult to keep a proper distance between vehicles because of frequent acceleration or deceleration**
- **Interference by other radar sources.**
- **Do not use the ICC system if you are towing a trailer. The system may not detect a vehicle ahead (if equipped).**
- **In some road or traffic conditions, a vehicle or object can unexpectedly come into the sensor detection zone and cause automatic braking. You may need to control the distance from other vehicles using the accelerator pedal. Always stay alert and avoid using the ICC system when it is not recommended in this section.**

The radar sensor will not detect the following objects:

- Stationary and slow moving vehicles
- Pedestrians or objects in the roadway
- Oncoming vehicles in the same lane
- Motorcycles traveling offset in the travel lane

The sensor generally detects the signals returned from the vehicle ahead. Therefore, if the sensor cannot detect the reflection from the vehicle ahead, the ICC system may not maintain the selected distance.

The following are some conditions in which the sensor cannot properly detect a vehicle ahead and the system may not operate properly:

- When the snow or road spray from traveling vehicles reduces the sensor's detection
- When excessively heavy baggage is loaded in the rear seat or the luggage compartment of your vehicle
- When your vehicle is towing a trailer, etc. (if equipped)

The ICC system is designed to automatically check the sensor's operation within the limitation of the system.

When the sensor is covered with dirt or is obstructed, the system will automatically be canceled. If the sensor is covered with ice, a transparent or translucent vinyl bag, etc., the ICC system may not detect them. In these instances, the vehicle-to-vehicle distance control mode may not cancel and may not be able to maintain the selected following distance from the vehicle ahead. Be sure to check and clean the sensor regularly.

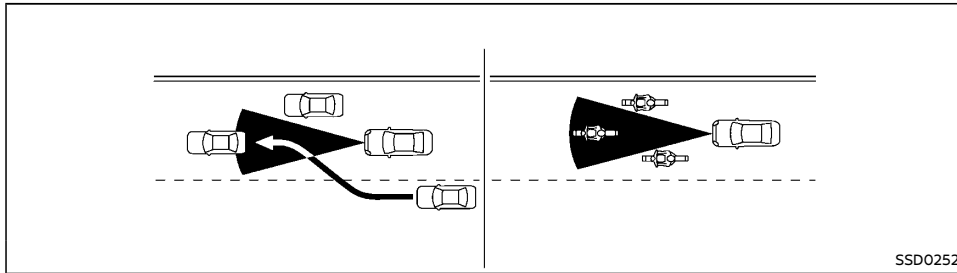

The detection zone of the radar sensor is limited. A vehicle ahead must be in the detection zone for the vehicle-to-vehicle distance detection mode to maintain the selected distance from the vehicle ahead.

A vehicle ahead may move outside of the detection zone due to its position within the same lane of travel. Motorcycles may not be detected in the same lane ahead if they are traveling offset from the centerline of the lane. A vehicle that is entering the lane ahead may not be detected until the vehicle has completely moved into the lane. **If this occurs, the ICC system may warn you by blinking the system indicator and sounding the chime. The driver may have to manually control the proper distance away from vehicle traveling ahead.**

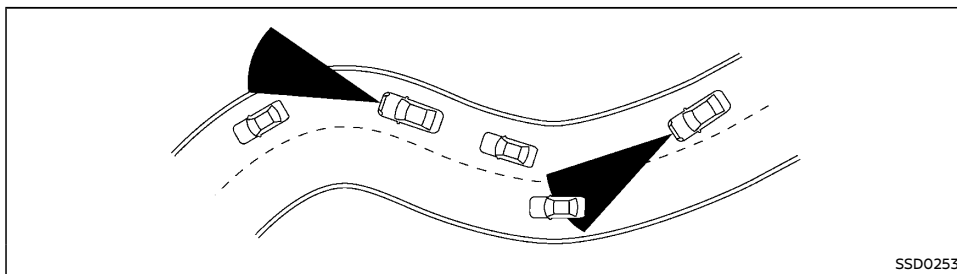

SSD0253

When driving on some roads, such as winding, hilly, curved, narrow roads, or roads which are under construction, the radar sensor may detect vehicles in a different lane, or may temporarily not detect a vehicle traveling ahead. This may cause the ICC system to decelerate or accelerate the vehicle.

The detection of vehicles may also be affected by vehicle operation (steering maneuver or traveling position in the lane, etc.) or vehicle condition. **If this occurs, the ICC system may warn you by blinking the system indicator and sounding the chime unexpectedly. You will have to manually control the proper distance away from the vehicle traveling ahead.**

### System temporarily unavailable

The following are conditions in which the ICC system may be temporarily unavailable. In these instances, the ICC system may not cancel and may not be able to maintain the selected following distance from the vehicle ahead.

### Condition A:

Under the following conditions, the ICC system is automatically canceled. A chime will sound and the system will not be able to be set:

- When the VDC is turned off
- When the VDC operates
- When a vehicle ahead is not detected and your vehicle is traveling below the speed of 25 km/h (15 MPH)
- When the system judges the vehicle is at a standstill
- When the shift lever is not in the D (Drive) or manual shift mode
- When the parking brake is applied
- When a tire slips
- When the radar signal is temporarily interrupted
- On repeated uphill and downhill roads
- When the 4WD mode switch is in the 4H or 4LO position

### Action to take:

When the conditions listed above are no longer present, turn the system off using the CRUISE ON/OFF switch. Turn the ICC system back on to use the system.

### Condition B:

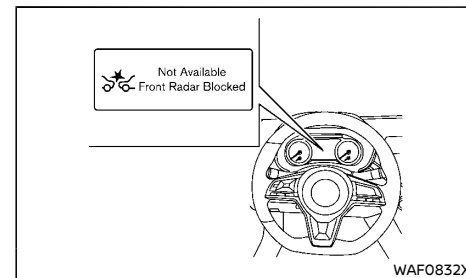

WAF0832X

The chime will sound and the "Not Available: Front Radar Blocked" warning message will appear in the vehicle information display.

- When the radar sensor area is covered with dirt or is obstructed, making it impossible to detect a vehicle ahead, the ICC system is automatically canceled.

### Action to take:

If the warning message appears, park the vehicle in a safe place and turn the engine off. When the radar signal is temporarily interrupted, clean the sensor area and restart the engine. If the "Not Available: Front Radar Blocked" warning message continues to be displayed, have the ICC system checked by a NISSAN dealer.

- When driving on roads with limited road structures or buildings (for example, long bridges, deserts, snow fields, driving next to long walls), the system may illuminate the ICC system warning (yellow) and display the "Not Available: Front Radar Blocked" message.

### Action to take:

When the conditions listed above are no longer present, turn the ICC system back on to use the system.

### Condition C:

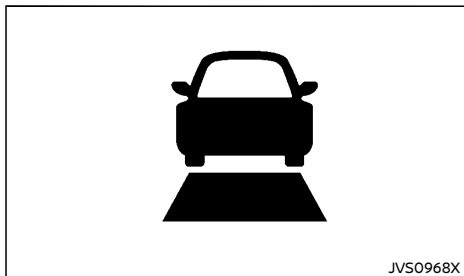

When the ICC system is not operating properly, the chime sounds and the ICC system warning (yellow) will appear.

### Action to take:

If the warning appears, park the vehicle in a safe place. Turn the engine off, restart the engine, resume driving and set the ICC system again.

**If it is not possible to set the system or the warning stays on, it may indicate that the ICC system is malfunctioning. Although the vehicle is still driveable under normal conditions, have the vehicle checked. See a NISSAN dealer for this service.**

### System maintenance

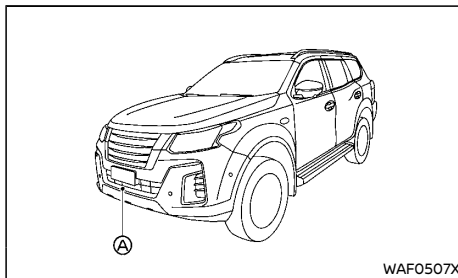

The sensor for the ICC system (A) is located on the front of the vehicle.

To keep the ICC system operating properly, be sure to observe the following:

- Always keep the sensor area clean.
- Do not strike or damage the areas around the sensor.
- Do not cover or attach stickers or similar objects near the sensor area. This could cause failure or malfunction.
- Do not attach metallic objects near the sensor area (brush guard, etc.). This could cause failure or malfunction.
- Do not alter, remove or paint the front bumper. Contact a NISSAN dealer before customizing or restoring the front bumper.

For the radio approval numbers and information, see "Radio approval number and information" (P.9-12).

### CONVENTIONAL (fixed speed) CRUISE CONTROL MODE

This mode allows driving at a speed between 40 to 160 km/h (25 to 100 MPH) without keeping your foot on the accelerator pedal.



### WARNING:

- **In the conventional (fixed speed) cruise control mode, a warning chime does not sound to warn you if you are too close to the vehicle ahead, as neither the presence of the vehicle ahead nor the vehicle-to-vehicle distance is detected.**
- **Pay special attention to the distance between your vehicle and the vehicle ahead of you or a collision could occur.**
- **Always confirm the setting in the ICC system display.**
- **Do not use the conventional (fixed speed) cruise control mode when driving under the following conditions:**
  - when it is not possible to keep the vehicle at a set speed
  - in heavy traffic or in traffic that varies in speed
  - on winding or hilly roads
  - on slippery roads (rain, snow, ice, etc.)
  - in very windy areas
- **Doing so could cause a loss of vehicle control and result in an accident.**



## Conventional (fixed speed) cruise control switches

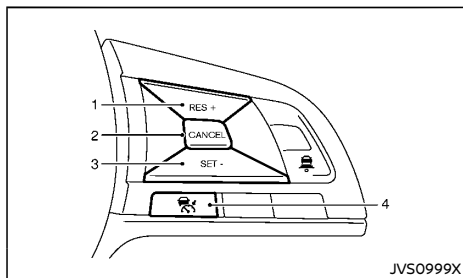

1. RES + switch:  
Resumes set speed or increases speed incrementally.
2. CANCEL switch:  
Deactivates the system without erasing the set speed.
3. SET - switch:  
Sets the desired cruise speed, reduces speed incrementally.
4. CRUISE ON/OFF switch:  
Master switch to activate the system.

## Conventional (fixed speed) cruise control mode display and indicators

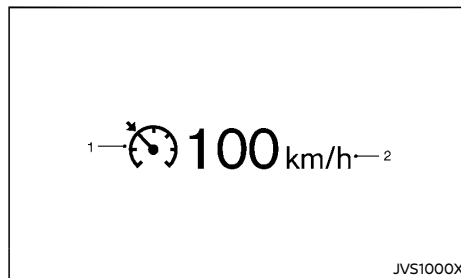

The display is located in the vehicle information display.

1. Cruise indicator:  
This indicator indicates the condition of ICC system depending on a color.
  - Cruise control ON indicator (gray):  
Indicates that the Cruise ON/OFF switch is ON.
  - Cruise control set indicator (green):  
Indicates that the cruising speed is set.
  - Cruise system warning (yellow):  
Indicates that there is a malfunction in the ICC system.
2. Set vehicle speed indicator:  
This indicator indicates the set vehicle speed.

## Operating conventional (fixed speed) cruise control mode

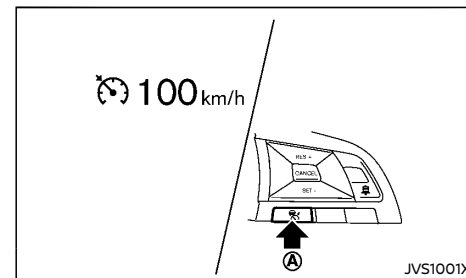

**To turn on the conventional (fixed speed) cruise control mode**, push and hold the Cruise ON/OFF switch  for longer than about 1.5 seconds.

When pushing the CRUISE ON/OFF switch on, the conventional (fixed speed) cruise control mode display and indicators are displayed in the vehicle information display. After you hold the CRUISE ON/OFF switch on for longer than about 1.5 seconds, the ICC system display goes out. The cruise indicator appears. You can now set your desired cruising speed. Pushing the CRUISE ON/OFF switch again will turn the system completely off.

When the ignition switch is placed in the "OFF" position, the system is also automatically turned off.

To use the ICC system again, quickly push and release the CRUISE ON/OFF switch (vehicle-to-vehicle distance control mode) or push and hold it (conventional cruise control mode) again to turn it on.

**CAUTION:**

To avoid accidentally engaging cruise control, make sure to turn the CRUISE ON/OFF switch off when not using the ICC system.

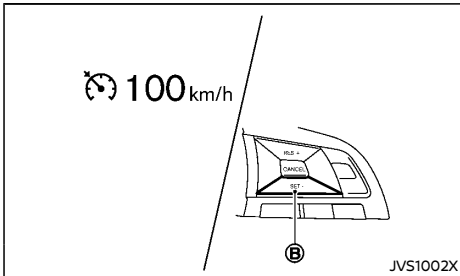

To set cruising speed, accelerate your vehicle to the desired speed, push the SET - switch (B) and release it. (The color of the cruise indicator changes to green and set vehicle speed indicator comes on.) Take your foot off the accelerator pedal. Your vehicle will maintain the set speed.

- To pass another vehicle, depress the accelerator pedal. When you release the pedal, the vehicle will return to the previously set speed.
- The vehicle may not maintain the set speed when going up or down steep hills. If this happens, manually maintain vehicle speed.

To cancel the preset speed, use any of the following methods:

1. Push the CANCEL switch. The vehicle speed indicator will turn off.
2. Tap the brake pedal. The vehicle speed indicator will turn off.

3. Turn the CRUISE ON/OFF switch off. Both the cruise indicator and set vehicle speed indicator will turn off.

To reset at a faster cruising speed, use one of the following three methods:

1. Depress the accelerator pedal. When the vehicle attains the desired speed, push and release the SET - switch.
2. Push and hold the RES + switch. When the vehicle attains the desired speed, release the switch.
3. Push, then quickly release the RES + switch. Each time you do this, the set speed will increase by about 1 km/h (1 MPH).

To reset at a slower cruising speed, use one of the following three methods:

1. Lightly tap the brake pedal. When the vehicle attains the desired speed, push the SET - switch and release it.
2. Push and hold the SET - switch. Release the switch when the vehicle slows down to the desired speed.
3. Push, then quickly release the SET - switch. Each time you do this, the set speed will decrease by about 1 km/h (1 MPH).

To resume the preset speed, push and release the RES + switch. The vehicle will resume the last set cruising speed when the vehicle speed is over 40 km/h (25 MPH).

### System temporarily unavailable

A chime sounds under the following conditions and the control is automatically canceled.

- When the vehicle slows down more than 13 km/h (8 MPH) below the set speed
- When the shift lever is not in the D (Drive) or manual shift mode
- When the parking brake is applied.
- When the VDC operates
- When a wheel slips
- When the 4WD mode switch is in the 4H or 4LO position

### Warning

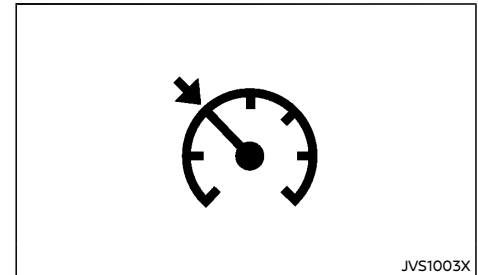

When the system is not operating properly, the chime sounds and the color of the cruise indicator will change to yellow.

### Action to take:

If the color of the cruise indicator changes to yellow, park the vehicle in a safe place. Turn the engine off, restart the engine, resume driving and then perform the setting again.

If it is not possible to set or the indicator stays on, it may indicate that the system is malfunctioning. Although the vehicle is still driveable under normal conditions, have the

## INTELLIGENT EMERGENCY BRAKING (if equipped)

vehicle checked by a NISSAN dealer.



### WARNING:

Failure to follow the warnings and instructions for proper use of the Intelligent Emergency Braking system could result in serious personal injury or death.

- The Intelligent Emergency Braking system is a supplemental aid to the driver. It is not a replacement for the driver's attention to traffic conditions or responsibility to drive safely. It cannot prevent accidents due to carelessness or dangerous driving techniques.
- The Intelligent Emergency Braking system does not function in all driving, traffic, weather and road conditions.

The Intelligent Emergency Braking system can assist the driver when there is a risk of a forward collision with the vehicle ahead in the traveling lane.

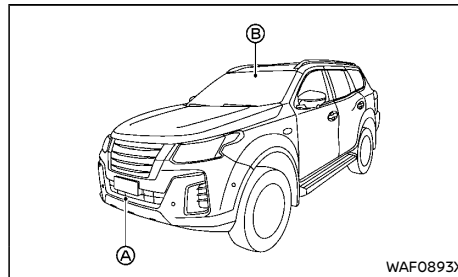

The Intelligent Emergency Braking system uses a radar sensor (A) located on the front of the vehicle and camera unit (B) installed behind the windshield to measure the distance to the vehicle ahead in the same lane.

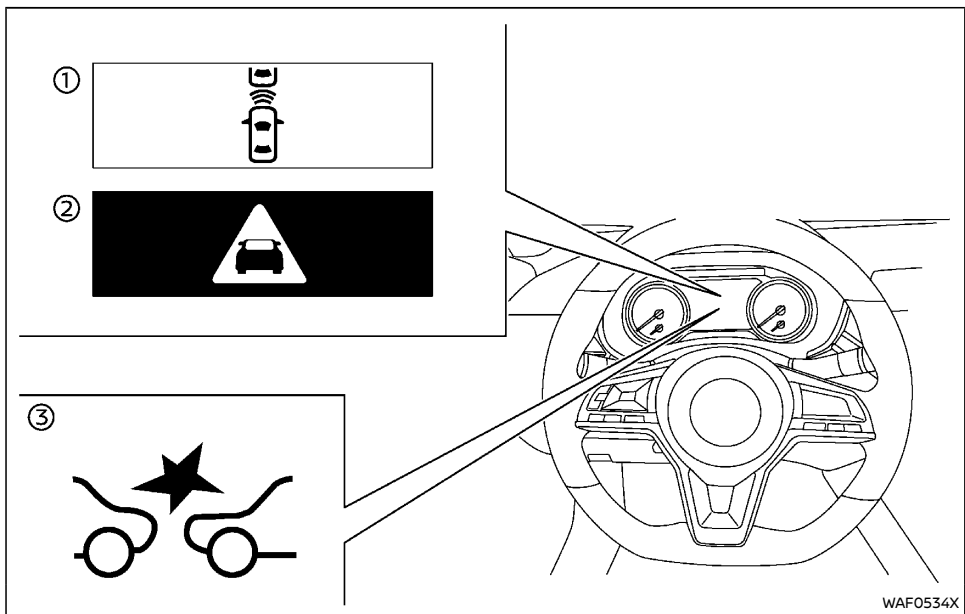

- ① Vehicle ahead detection indicator
- ② Intelligent Emergency Braking emergency warning indicator
- ③ Intelligent Emergency Braking system warning light (on the meter panel)

### INTELLIGENT EMERGENCY BRAKING SYSTEM OPERATION

The Intelligent Emergency Braking system will function when your vehicle is driven at speeds above approximately 5 km/h (3 MPH).

If a risk of a forward collision is detected, detection system will firstly provide the warning to the driver by illuminating the warning (yellow) in the vehicle information display and providing an audible alert.

If the driver applies the brakes quickly and forcefully after the warning, and the Intelligent

Emergency Braking system detects that there is still the possibility of a forward collision, the system will automatically increase the braking force.

If the driver does not take action, the Intelligent Emergency Braking system issues the second visual (flashing) (red) and audible warning. If the driver releases the accelerator pedal, then the system applies partial braking.

If the risk of a collision becomes imminent, the Intelligent Emergency Braking system applies harder braking automatically.

While the Intelligent Emergency Braking system is operating, you may hear the sound of brake operation. This is normal and indicates that the Intelligent Emergency Braking system is operating properly.

#### NOTE:

**The vehicle's stop lights come on when braking is performed by the Intelligent Emergency Braking system.**

Depending on vehicle speed and distance to the vehicle ahead, as well as driving and roadway conditions, the system may help the driver avoid a forward collision or may help mitigate the consequences of a collision should one be unavoidable.

If the driver is handling the steering wheel, accelerating or braking, the Intelligent Emergency Braking system will function later or will not function.

The automatic braking will cease under the following conditions:

- When the steering wheel is turned as far as necessary to avoid a collision.
- When the accelerator pedal is depressed.

- When there is no longer a vehicle detected ahead.

If the Intelligent Emergency Braking system has stopped the vehicle, the vehicle will remain at a standstill for approximately 2 seconds before the brakes are released.

## TURNING THE INTELLIGENT EMERGENCY BRAKING SYSTEM ON/OFF

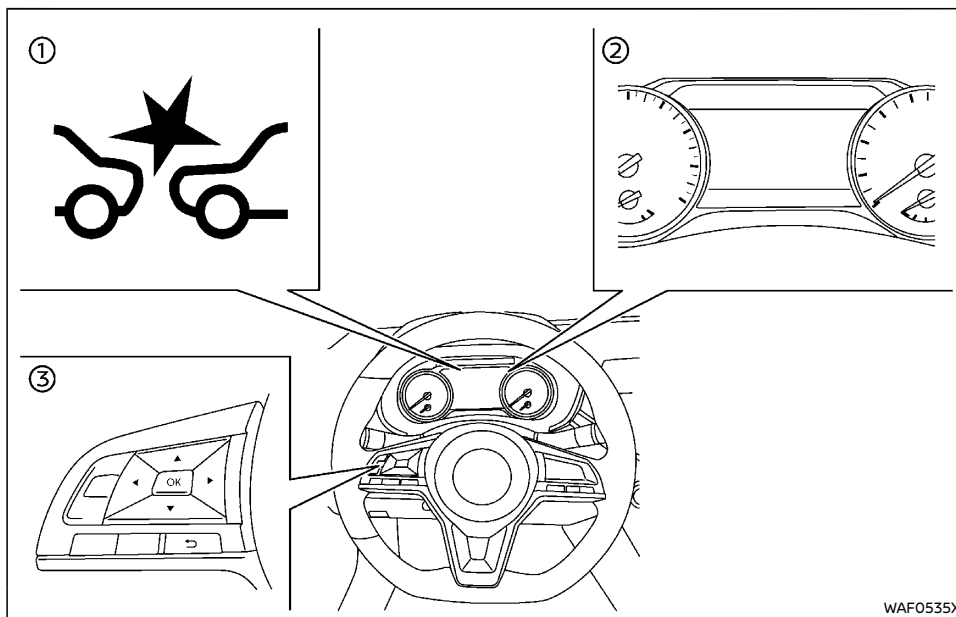

- ① Intelligent Emergency Braking system warning light
- ② Vehicle information display
- ③ Steering-wheel-mounted controls (left side)

Perform the following steps to enable or disable the Intelligent Emergency Braking system.

1. Press the ◀ ▶ button until "Settings" appears in the vehicle information display. Use the ⬇ button to select "Driver Assistance". Then press the "OK" button.
2. Use the ⬆ button to select "Emergency Brake" and press the "OK" button to turn on or off the Intelligent Emergency Braking system.

When the Intelligent Emergency Braking system is turned off, the Intelligent Emergency

Braking system warning light (orange) ① illuminates.

**NOTE:**

The Intelligent Emergency Braking system will be automatically turned ON when the engine is restarted.

**INTELLIGENT EMERGENCY BRAKING SYSTEM LIMITATIONS**



**WARNING:**

Listed below are the system limitations for the Intelligent Emergency Braking system. Failure to operate the vehicle in accordance with these system limitations could result in serious injury or death.

- The Intelligent Emergency Braking system cannot detect all vehicles under all conditions.
- The radar sensor does not detect the following objects:
  - Pedestrians, animals or obstacles in the roadway
  - Oncoming vehicles
  - Crossing vehicles
- The radar sensor has some performance limitations. If a stationary vehicle is in the vehicle's path, the Intelligent Emergency Braking system will not function when the vehicle is driven at speeds over approximately 80 km/h (50 MPH).
- The radar sensor may not detect a vehicle ahead in the following conditions:
  - Dirt, ice, snow or other material covering the radar sensor.

- Interference by other radar sources.
- Snow or road spray from traveling vehicles.
- If the vehicle ahead is narrow (e.g. motorcycle)
- When driving on a steep downhill slope or roads with sharp curves.
- While towing a trailer or other vehicle. (for South Africa)
- In some road or traffic conditions, the Intelligent Emergency Braking system may unexpectedly apply partial braking. When acceleration is necessary, continue to depress the accelerator pedal to override the system.
- The Intelligent Emergency Braking system may react to:
  - objects on the roadside (traffic sign, guardrail, trees, vehicle, etc.)

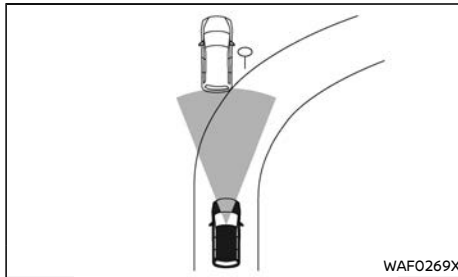

- objects above road (low bridge, traffic sign, etc.)
- objects on the road surface (railroad track, grate, steel plate, etc.)

- objects in the parking garage (beam, pillar, etc.)
- vehicles or objects in adjacent lane or close to the vehicle
- Braking distances increase on slippery surfaces.
- The system is designed to automatically check the sensor's functionality, within certain limitations. The system may not always properly warn the driver about functional issues during the first few minutes after starting the engine. The system may not detect some forms of obstruction of the sensor area such as ice, snow, mud, stickers, for example. In these cases, the system may not be able to warn the driver properly. Be sure that you check, clean and clear the sensor area regularly.
- Excessive noise will interfere with the warning chime sound, and the chime may not be heard.

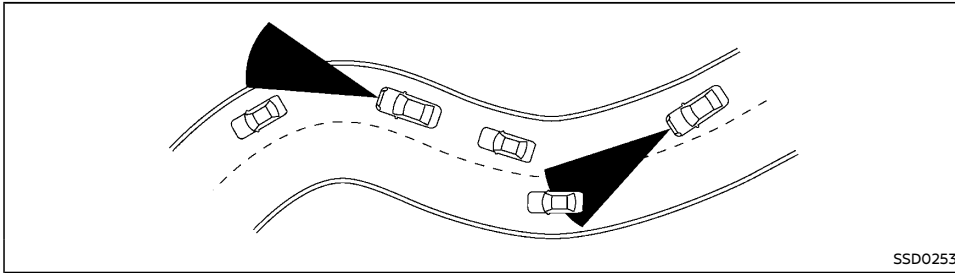

When driving on some roads, such as winding, hilly, curved, narrow roads, or roads which are under construction, the sensor may detect vehicles in a different lane, or may temporarily not detect a vehicle traveling ahead. This may cause the system to work inappropriately.

The detection of vehicles may also be affected by vehicle operation (steering maneuver or traveling position in the lane, etc.) or vehicle condition. **If this occurs, the system may warn you by blinking the system indicator and sounding the chime unexpectedly. You will have to manually control the proper distance away from the vehicle traveling ahead.**

## SYSTEM TEMPORARILY UNAVAILABLE

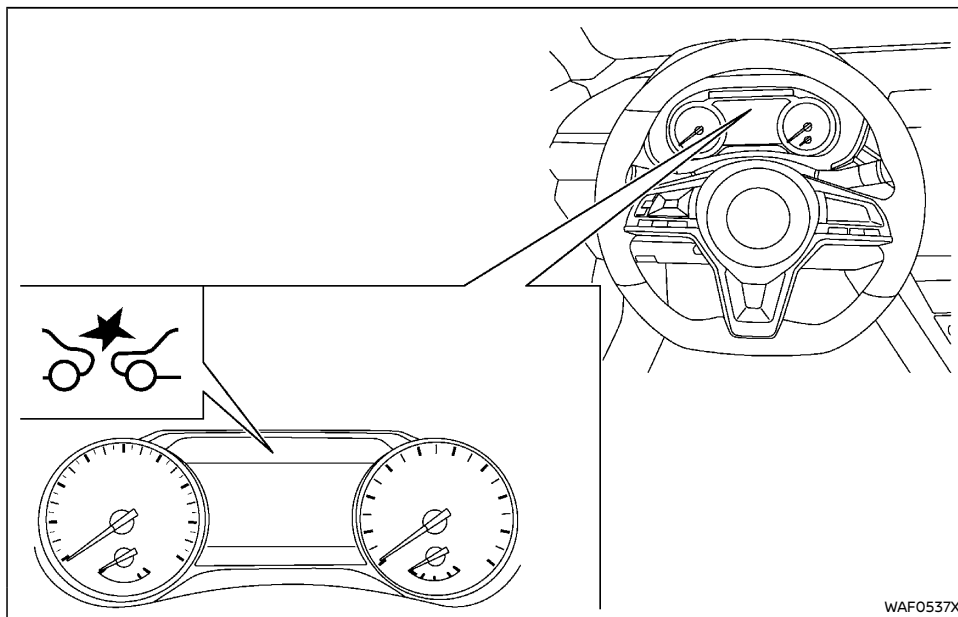

### Condition A

When the radar sensor picks up interference from another radar source, making it impossible to detect a vehicle ahead, the Intelligent Emergency Braking system is automatically turned off.

The Intelligent Emergency Braking system warning light (orange) will illuminate.

### Action to take

When the above conditions no longer exist, the Intelligent Emergency Braking system will resume automatically.

### Condition B

In the following condition, the Intelligent Emergency Braking system warning light (orange) will illuminate and the "Not Available: Front Radar Blocked" warning message will appear in the vehicle information display.

- The sensor area on the front of the vehicle is covered with dirt or is obstructed.

### Action to take

If the warning light (orange) comes on, stop the vehicle in a safe place and turn the engine off. Clean the radar cover on the front of the vehicle with a soft cloth, and restart the engine. If the warning light continues to illuminate, have the Intelligent Emergency Braking system checked by a NISSAN dealer.

- When driving on roads with limited road structures or buildings (for example, long bridges, deserts, snow fields, driving next to long walls).

### Action to take

When the above conditions no longer exist, the Intelligent Emergency Braking system will resume automatically.

### Condition C

When Vehicle Dynamic Control (VDC) system is OFF, the Intelligent Emergency Braking brake will not operate. In this case only visible and audible warning operates. The Intelligent Emergency Braking system warning light (orange) will illuminate.

### Action to take

When the VDC system is ON, the Intelligent Emergency Braking system will resume automatically.

### Condition D

If the following conditions, the Intelligent Emergency Braking system warning light will flash (no message appears in the vehicle information display).

- Strong light is shining from the front of the vehicle.



- The cabin temperature is over approximately 40°C (104°F) in direct sunlight.
- The camera area of the windshield is misted or frozen.
- The camera unit detects its misalignment condition.
- The radar sensor picks up interference from another radar source.

#### Action to take

When the above conditions no longer exist, the Intelligent Emergency Braking will resume automatically.

#### NOTE:

**When the inside of the windshield on camera area is misted or frozen, it will take a period of time to remove it after air conditioner turns on. If dirt appears on this area, it is recommended you visit a NISSAN dealer.**

#### SYSTEM MALFUNCTION

If the Intelligent Emergency Braking system malfunctions, it will be turned off automatically, a chime will sound, the Intelligent Emergency Braking system warning light (orange) will illuminate and the "System fault" warning message will appear in the vehicle information display.

#### Action to take:

If the Intelligent Emergency Braking system warning light (orange) comes on, stop the vehicle in a safe location. Turn the engine off and restart the engine. If the warning light continues to illuminate, have the Intelligent Emergency Braking system checked by a NISSAN dealer.

## SYSTEM MAINTENANCE

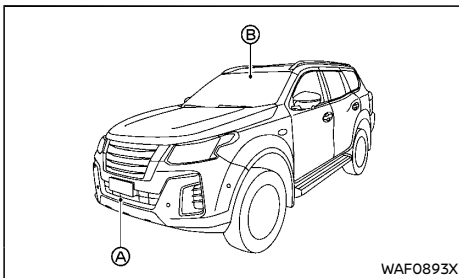

The radar sensor (A) is located on the front of the vehicle. The camera (B) is located on the upper side of the windshield.

To keep the system operating properly, be sure to observe the following:

- Always keep the sensor area on the front of the vehicle and windshield clean.
- Do not strike or damage the areas around the sensors (ex. bumper, windshield).
- Do not cover or attach stickers or similar objects on the front of the vehicle near the sensor area. This could cause failure or malfunction.
- Do not attach metallic objects near the radar sensor area (brush guard, etc.). This could cause failure or malfunction.
- Do not place reflective materials, such as white paper or a mirror, on the instrument panel. The reflection of sunlight may adversely affect the camera unit's detection capability.
- Do not alter, remove or paint the front of the vehicle near the sensor area. Contact a NISSAN dealer before customizing or restoring the sensor area.

For the radio approval numbers and information, see "Radio approval number and information" (P.9-12).

## INTELLIGENT FORWARD COLLISION WARNING SYSTEM (if equipped)

### WARNING:

Failure to follow the warnings and instructions for proper use of the Intelligent Forward Collision Warning system could result in serious injury or death.

- The Intelligent Forward Collision Warning system can help warn the driver before a collision occurs but will not avoid a collision. It is the driver's responsibility to stay alert, drive safely and be in control of the vehicle at all times.

The Intelligent Forward Collision Warning system can help alert the driver when there is a sudden braking of a second vehicle traveling in front of the vehicle ahead in the same lane.

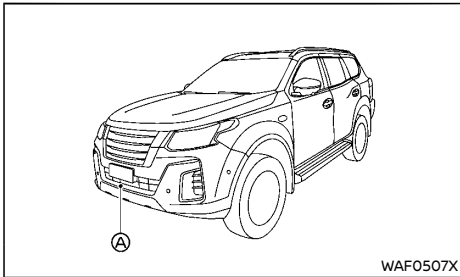

The Intelligent Forward Collision Warning system uses a radar sensor  located on the front of the vehicle to measure the distance to the vehicle ahead in the same lane.

## INTELLIGENT FORWARD COLLISION WARNING SYSTEM OPERATION

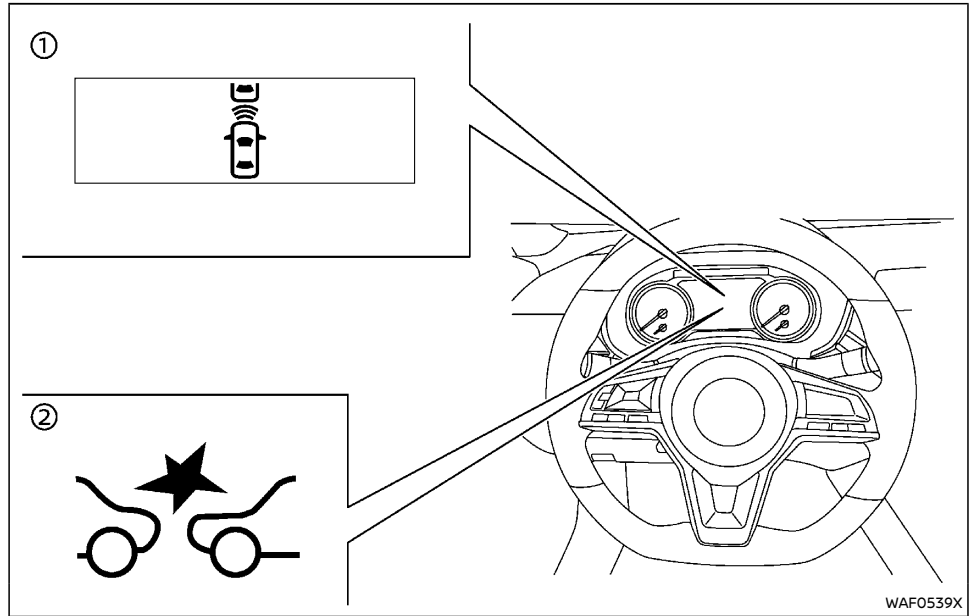

- ① Vehicle ahead detection indicator
- ② Intelligent Emergency Braking system warning light

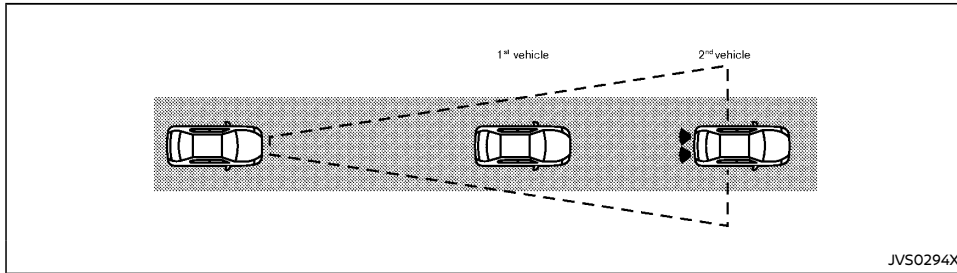

The Intelligent Forward Collision Warning system operates at speeds above approximately 5 km/h (3 MPH).

If there is a potential risk of a forward collision, the Intelligent Forward Collision Warning system will warn the driver by blinking the vehicle ahead detection indicator, and sounding an audible alert.

## TURNING THE INTELLIGENT FORWARD COLLISION WARNING SYSTEM ON/OFF

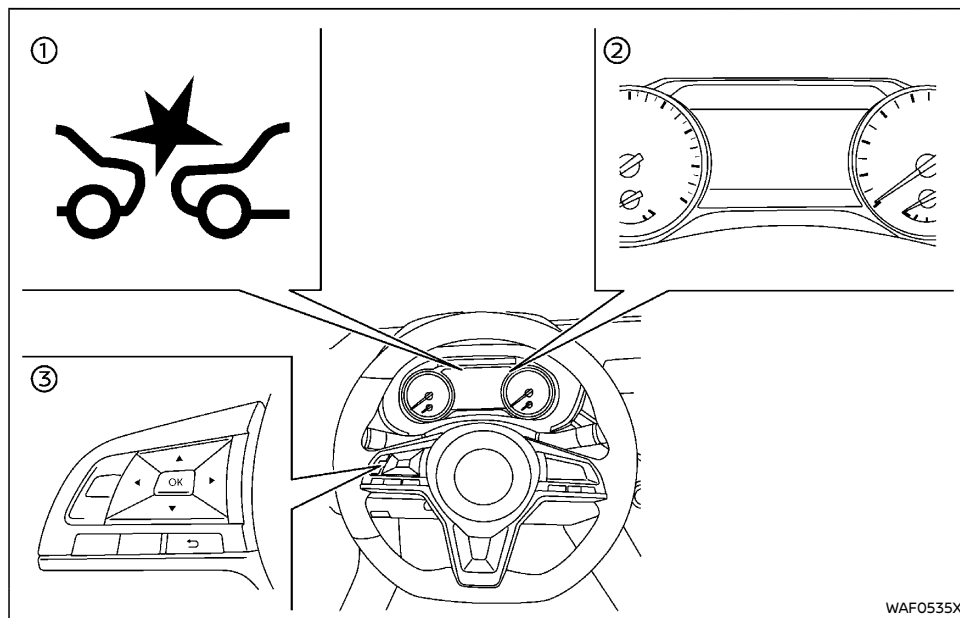

- ① Intelligent Emergency Braking system warning light
- ② Vehicle information display
- ③ Steering-wheel-mounted controls (left side)

Perform the following steps to enable or disable the Intelligent Forward Collision Warning system.

1. Press the ◀ ▶ button until "Settings" appears in the vehicle information display. Use the ⬇ button to select "Driver Assistance". Then press the "OK" button.
2. Use the ⬆ button to select "Emergency Brake" and press the "OK" button to turn on or off the Intelligent Forward Collision Warning system.

When the Intelligent Forward Collision Warning system is turned off, the Intelligent Emergency

Braking system warning light illuminates.

### NOTE:

When the Intelligent Forward Collision Warning system is turned off, the Intelligent Emergency Braking system is also turned off. For details about the Intelligent Emergency Braking system, see "Intelligent Emergency Braking" (P.5-61).

### INTELLIGENT FORWARD COLLISION WARNING SYSTEM LIMITATIONS

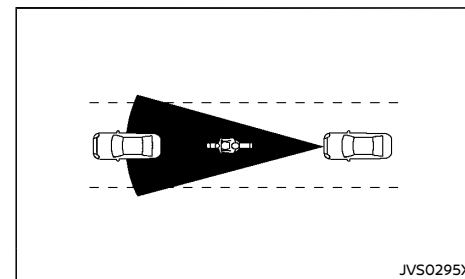

Illustration A

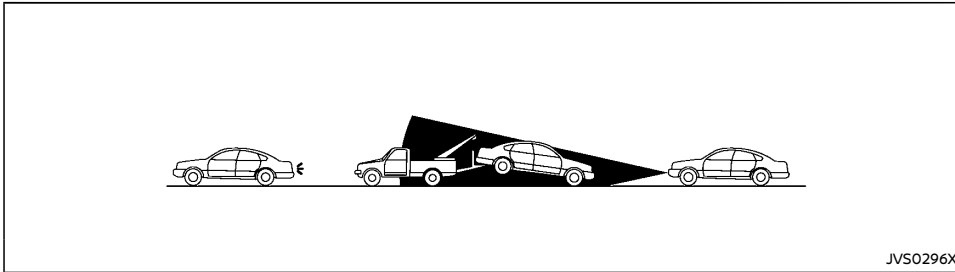

Illustration B



**WARNING:**

Listed below are the system limitations for the Intelligent Forward Collision Warning system. Failure to operate the vehicle in accordance with these system limitations could result in serious injury or death.

- The Intelligent Forward Collision Warning system cannot detect all vehicles under all conditions.
- The radar sensor does not detect the following objects:
  - Pedestrians, animals or obstacles in the roadway
  - Oncoming vehicles
  - Crossing vehicles
- (Illustration A) The Intelligent Forward Collision Warning system does not function when a vehicle ahead is a narrow vehicle, such as a motorcycle.
- The radar sensor may not detect a vehicle ahead in the following conditions:
  - Snow or heavy rain
  - Dirt, ice, snow or other material covering the radar sensor.
  - Interference by other radar sources.
  - Snow or road spray from traveling vehicles.
  - Driving in a tunnel
  - When your vehicle is towing a trailer, etc. (for South Africa)
  - (Illustration B) When the vehicle ahead is being towed.
  - (Illustration C) When the distance to the vehicle ahead is too close, the beam of the radar sensor is obstructed.
  - (Illustration D) When driving on a steep downhill slope or roads with sharp curves.
- The system is designed to automatically check the sensor's functionality, within certain limitations. The system may not detect some forms of obstruction of the sensor area such as ice, snow, stickers, etc. In these cases, the system may not be able to warn the driver properly. Be sure that you check, clean and clear the

sensor area regularly.

- Excessive noise will interfere with the warning chime sound, and the chime may not be heard.

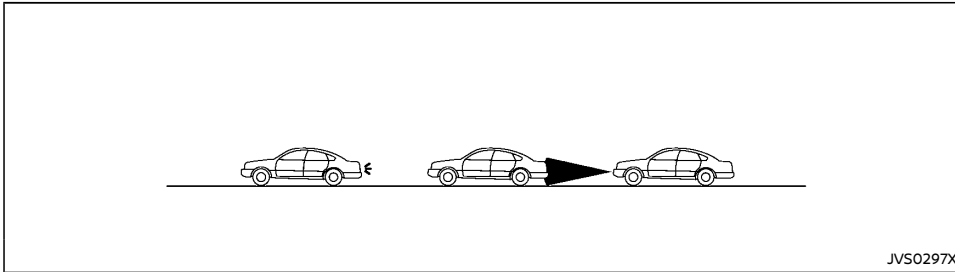

JVS0297X

Illustration C

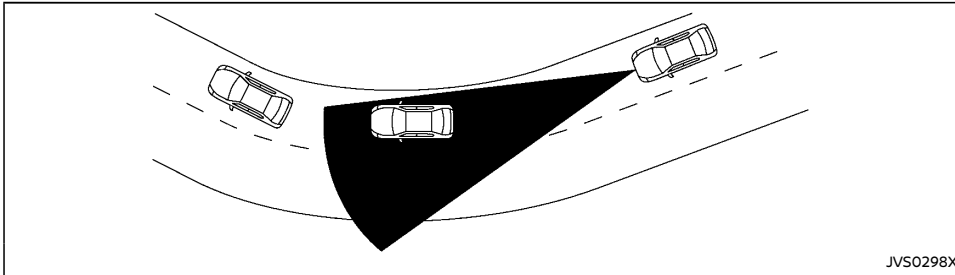

JVS0298X

Illustration D

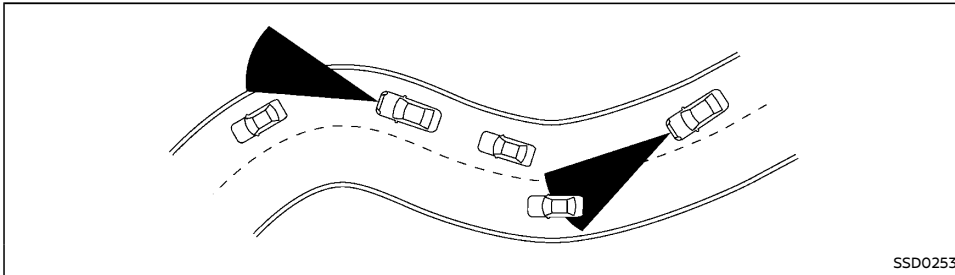

SSD0253

under construction, the radar sensor may detect vehicles in a different lane, or may temporarily not detect a vehicle traveling ahead. This may cause the Intelligent Forward Collision Warning system to work inappropriately.

The detection of vehicles may also be affected by vehicle operation (steering maneuver or traveling position in the lane, etc.) or vehicle condition. **If this occurs, the system may warn you by blinking the system indicator and sounding the chime unexpectedly. You will have to manually control the proper distance away from the vehicle traveling ahead.**

When driving on some roads, such as winding, hilly, curved, narrow roads, or roads which are

## SYSTEM TEMPORARILY UNAVAILABLE

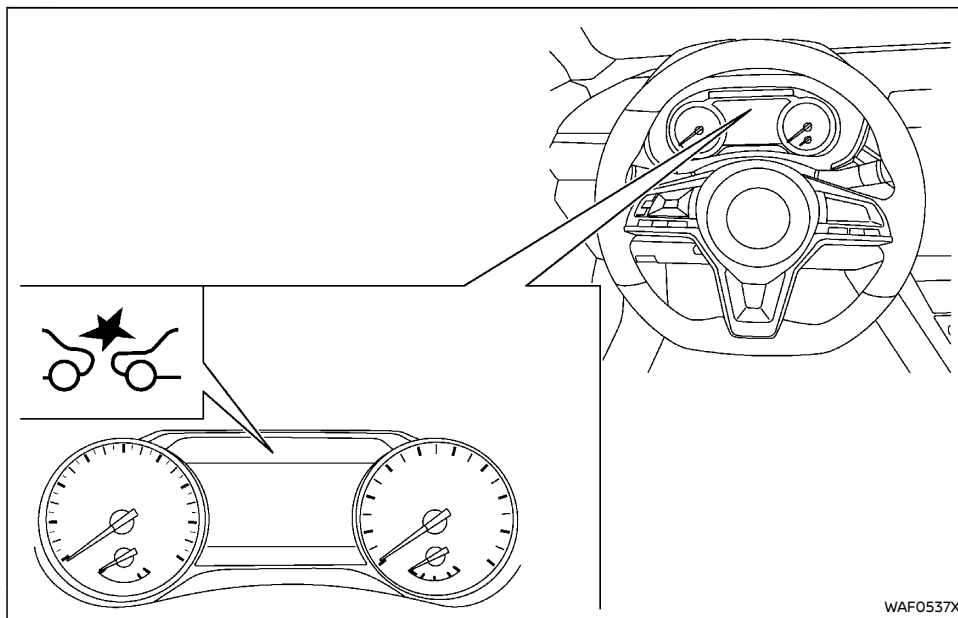

### Condition A

When the radar sensor picks up interference from another radar source, making it impossible to detect a vehicle ahead, the Intelligent Forward Collision Warning system is automatically turned off.

The Intelligent Emergency Braking system warning light (orange) will illuminate.

### Action to take:

When the above conditions no longer exist, the Intelligent Forward Collision Warning system will resume automatically.

### Condition B

When the sensor area of the front bumper is covered with dirt or is obstructed, making it impossible to detect a vehicle ahead, the Intelligent Forward Collision Warning system is automatically turned off.

- The Intelligent Emergency Braking system warning light (orange) will illuminate and the "Not Available: Front Radar Blocked" warning message will appear in the vehicle information display.

### Action to take:

If the warning light (orange) comes on, stop the vehicle in a safe place, move the shift lever to the "P" (Park) position and turn the engine off. Clean the radar cover area with a soft cloth, and restart the engine. If the warning light continues to illuminate, have the Intelligent Forward Collision Warning system checked by a NISSAN dealer.

- When driving on roads with limited road structures or buildings (for example, long bridges, deserts, snow fields, driving next to long walls).

### Action to take:

When the above conditions no longer exist the Intelligent Forward Collision Warning system will resume automatically.

### NOTE:

**If the Intelligent Emergency Braking system stops working, the Intelligent Forward Collision Warning system will also stop working.**

## SYSTEM MALFUNCTION

If the Intelligent Forward Collision Warning system malfunctions, it will be turned off automatically, a chime will sound, the Intelligent Emergency Braking system warning light (orange) will illuminate and the warning message "System fault" will appear in the vehicle information display.

### Action to take:

If the warning light (orange) comes on, stop the vehicle in a safe location, turn the engine off and restart the engine. If the warning light continues to illuminate, have the Intelligent Forward Collision Warning system checked by a NISSAN dealer.

## SYSTEM MAINTENANCE

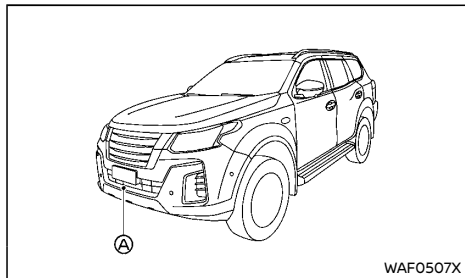

The radar sensor **A** is located on the front of the vehicle.

To keep the system operating properly, be sure to observe the following:

- Always keep the sensor area of the front bumper clean.
- Do not strike or damage the areas around the sensor.

## INTELLIGENT DRIVER ALERTNESS (if equipped)



### WARNING:

**Failure to follow the warnings and instructions for proper use of the Intelligent Driver Alertness system could result in serious injury or death.**

- The Intelligent Driver Alertness system is only a warning to inform the driver of a potential lack of driver attention or drowsiness. It will not steer the vehicle or prevent loss of control.
- The Intelligent Driver Alertness system does not detect and provide an alert of the driver's lack of attention or fatigue in every situation.
- It is the driver's responsibility to:
  - stay alert,
  - drive safely,
  - keep the vehicle in the traveling lane,
  - be in control of the vehicle at all times,
  - avoid driving when tired,
  - avoid distractions (texting, etc).

The Intelligent Driver Alertness system helps alert the driver if the system detects a lack of attention or driving fatigue.

The system monitors driving style and steering behavior over a period of time, and it detects changes from the normal pattern. If the system detects that driver attention is decreasing over a period of time, the system uses audible and visual warnings to suggest that the driver take a break.



## INTELLIGENT DRIVER ALERTNESS SYSTEM OPERATION



If the system detects driver fatigue or that driver attention is decreasing, the message "Take a break?" appears in the vehicle information display and a chime sounds when the vehicle is driven at speeds above 60 km/h (37 MPH).

The system continuously monitors driver attention and can provide multiple warnings per trip. The system resets and starts reassessing driving style and steering behavior when the ignition switch is cycled from the "ON" to the "OFF" position and back to the "ON" position.

## HOW TO ENABLE/DISABLE THE INTELLIGENT DRIVER ALERTNESS SYSTEM

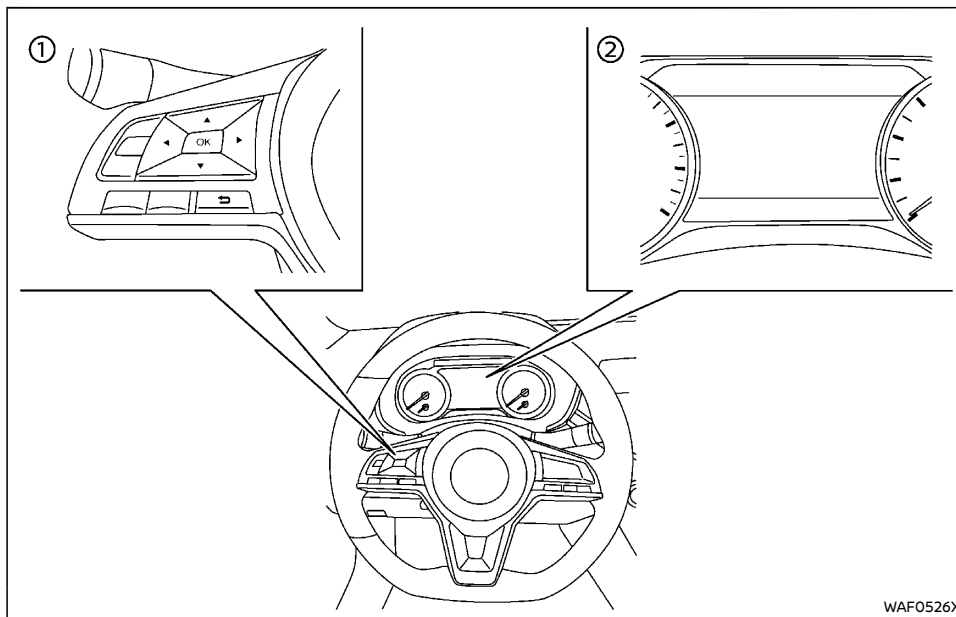

① Steering-wheel-mounted controls (left side)

② Vehicle information display

Perform the following steps to enable or disable the Intelligent Driver Alertness system.

1. Press the ◀ ▶ button until "Settings" appears in the vehicle information display. Use the ⬆ button to select "Driver Assistance". Then press the "OK" button.

2. Use the ⬆ button to select "Driver Attention Alert" and press the "OK" button to turn on or off the Intelligent Driver Alertness system.

### NOTE:

**The setting will be retained even if the engine is restarted.**

## INTELLIGENT DRIVER ALERTNESS SYSTEM LIMITATIONS



### WARNING:

Listed below are the system limitations for the Intelligent Driver Alertness system. Failure to operate the vehicle in accordance with these system limitations could result in serious injury or death.

- The Intelligent Driver Alertness system may not operate properly and may not provide an alert in the following conditions:
  - Poor road conditions such as an uneven road surface or pot holes.
  - Strong side wind.
  - If you have adopted a sporty driving style with higher cornering speeds or higher rates of acceleration.
  - Frequent lane changes or changes to vehicle speed.
- The Intelligent Driver Alertness system may not provide an alert in the following conditions:
  - Vehicle speeds lower than 60 km/h (37 MPH).
  - Short lapses of attention.
  - Instantaneous distractions such as dropping an object.

## SYSTEM MALFUNCTION

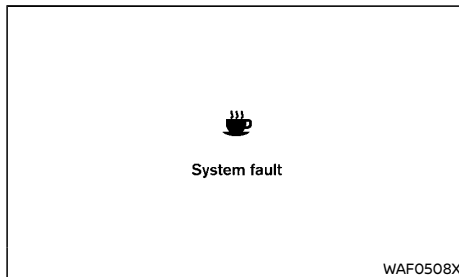

If the Intelligent Driver Alertness system malfunctions, the Intelligent Driver Alertness Malfunction warning message will appear in the vehicle information display and the function will be stopped automatically.

### Action to take:

Stop the vehicle in a safe location, place the vehicle in "P" (Park) position, turn the engine off and restart the engine. If the system warning message continues to appear, have the system checked by a NISSAN dealer.

## ECO DRIVE REPORT (if equipped)

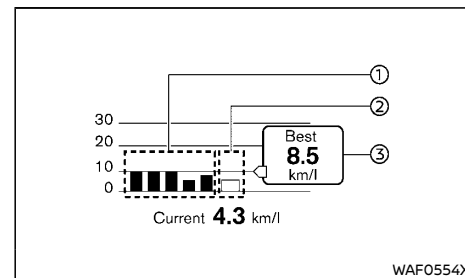

When the ignition switch is in the "OFF" position, ECO management display appears.

- ① Previous 5 times (History)
- ② Current fuel economy
- ③ Best fuel economy

The result of ECO evaluation is displayed 30 seconds after the ignition switch is placed in the "ON" position and the vehicle is driven at least 500 meters (1/3 miles).

- ①: The average fuel economy for the previous 5 times will be displayed.
- ②: The average fuel economy since the last reset will be displayed.
- ③: The best fuel economy of the past history will be displayed.

The ECO drive report can be set to be "ON" or "OFF". See "Settings" (P.2-22).

## FUEL EFFICIENCY AND CARBON DIOXIDE REDUCTION DRIVING TIPS

Follow these easy-to-use Fuel Efficiency and Carbon Dioxide Reduction Driving Tips to help you achieve the most fuel economy from your vehicle and reduce carbon dioxide emissions.

1. Use smooth accelerator and brake pedal application.
  - Avoid rapid starts and stops.
  - Use smooth, gentle accelerator and brake application whenever possible.
  - Maintain constant speed while commuting and coast whenever possible.
2. Maintain constant speed.
  - Look ahead to try and anticipate and minimize stops.
  - Synchronizing your speed with traffic lights allows you to reduce your number of stops.
  - Maintaining a steady speed can minimize red light stops and improve fuel efficiency.
3. Drive at economical speeds and distances.
  - Observing the speed limit and not exceeding 97 km/h (60 MPH) (where legally allowed) can improve fuel efficiency due to reduced aerodynamic drag.
  - Maintaining a safe following distance behind other vehicles reduces unnecessary braking.
  - Safely monitoring traffic to anticipate changes in speed permits reduced braking and smooth acceleration changes.
  - Select a gear range suitable to road conditions.
4. Use cruise control (if equipped).
  - Using cruise control during highway driving helps maintain a steady speed.
5. Plan for the shortest route.
  - Utilize a map or navigation system (if equipped) to determine the best route to save time.
6. Avoid idling.
  - Shutting off your engine when safe for stops exceeding 30-60 seconds saves fuel and reduces emissions.
7. Buy an automated pass for toll roads.
  - Automated passes permit drivers to use special lanes to maintain cruising speed through the toll and avoid stopping and starting.
8. Winter warm up.
  - Limit idling time to minimize impact to fuel economy.
  - Vehicles typically need no more than 30 seconds of idling at start-up to effectively circulate the engine oil before driving.
  - Your vehicle will reach its ideal operating temperature more quickly while driving versus idling.
9. Keeping your vehicle cool.
  - Park your vehicle in a covered parking area or in the shade whenever possible.
  - When entering a hot vehicle, opening the windows will help to reduce the inside temperature faster, resulting in reduced demand on your A/C system.
10. Do not carry excessive weight.
  - Remove unnecessary objects from the vehicle to reduce vehicle weight.

## INCREASING FUEL ECONOMY AND REDUCING CARBON DIOXIDE EMISSIONS

- Keep your engine tuned up.
- Follow the recommended scheduled maintenance.
- Keep the tires inflated to the correct pressure. Low tire pressure increases tire wear and lowers fuel economy.
- Keep the wheels in correct alignment. Improper alignment increases tire wear and lowers fuel economy.
- Use the recommended viscosity engine oil. (See "Recommended fluids/lubricants and capacities" (P.9-2).)

## PARKING



### WARNING:

- Do not stop or park the vehicle over flammable materials such as dry grass, waste paper or rags. They may ignite and cause a fire.
- Safe parking procedures require that both the parking brake be applied and the shift lever placed into the "P" (Park) position for Automatic Transmission (AT) model or in an appropriate gear for Manual Transmission (MT) model. Failure to do so could cause the vehicle to move unexpectedly or roll away and result in an accident.
- When parking the vehicle, make sure the shift lever is moved to the "P" (Park) position. The shift lever cannot be moved out of the "P" (Park) position without depressing the foot brake pedal (AT model).
- Never leave the engine running while the vehicle is unattended.
- Do not leave children unattended inside the vehicle. They could unknowingly activate switches or controls. Unattended children could become involved in serious accidents.
- To help avoid risk of injury or death through unintended operation of the vehicle and/or its systems, do not leave children, people who require the assistance of others or pets unattended in your vehicle. Additionally, the temperature inside a closed vehicle on a warm day can quickly become high enough to cause a significant risk of injury or death to people and pets.

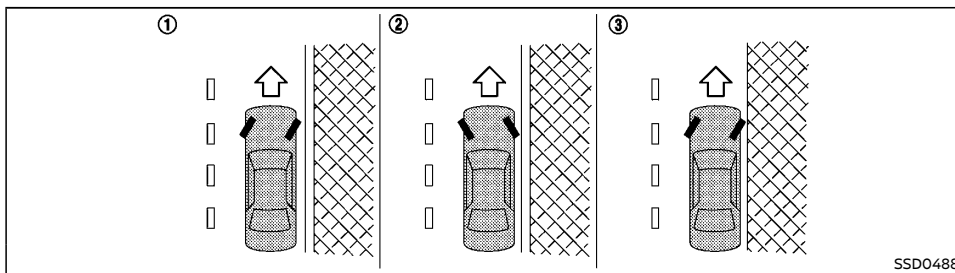

Left-Hand Drive (LHD) model

SSD0488

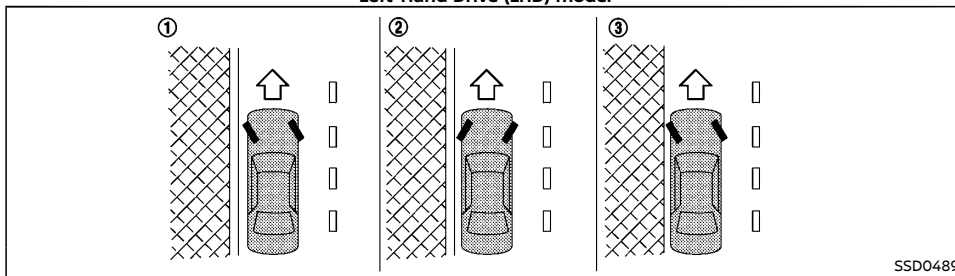

Right-Hand Drive (RHD) model

SSD0489

1. Firmly apply the parking brake.
2. Automatic Transmission (AT) model: Move the shift lever to the "P" (Park) position.

Manual Transmission (MT) model: Move the shift lever to the "R" (Reverse) position. When parking on an uphill grade, move the shift lever to the "1" (1st) position.

3. To help prevent the vehicle from moving into traffic when parked on an incline, it is a good practice to turn the wheels as illustrated.

HEADED DOWNHILL WITH CURB ①

Turn the wheels into the curb and move

the vehicle forward until the curb side wheel gently touches the curb. Then apply the parking brake.

HEADED UPHILL WITH CURB ②

Turn the wheels away from the curb and allow the vehicle to move back until the curb side wheel gently touches the curb. Then apply the parking brake.

HEADED UPHILL OR DOWNHILL, WITHOUT CURB ③

Turn the wheels toward the side of the road so the vehicle will move away from the center of the road if the vehicle moves.

## PARKING SENSOR (sonar) SYSTEM (if equipped)

Then apply the parking brake.

### 4. **Model with Intelligent Key:**

Place the ignition switch in the "OFF" position.

### **Model without Intelligent Key:**

Place the ignition switch in the "LOCK" position and remove the key.

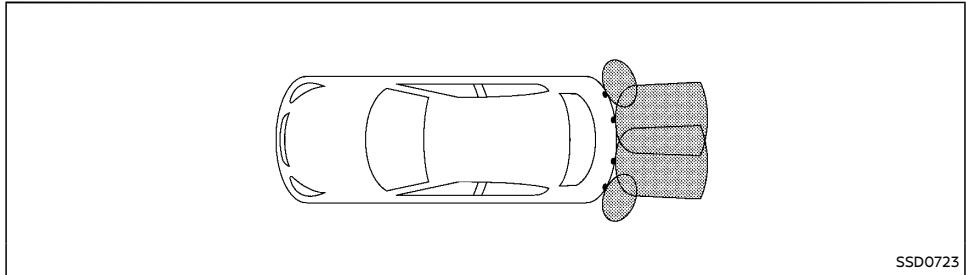

**Models with rear sonar**

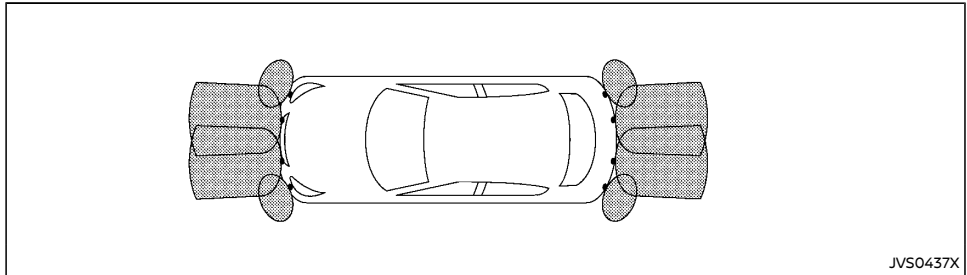

**Models with front and rear sonar**

The parking sensor (sonar) system sounds a tone to inform the driver of obstacles near the bumper.



### **WARNING:**

- The parking sensor (sonar) system is a convenience but it is not a substitute for proper parking. The driver is always responsible for safety during parking and other manoeuvres. Always look around and check that it is safe to do so before parking.

- Read and understand the limitations of the parking sensor (sonar) system as contained in this section. The colors of the corner sensor indicator and the distance guide lines in the front (if equipped)/rear view indicate different distances to the object (if equipped). Inclement weather or ultrasonic sources such as an automatic car wash, a truck's compressed-air brakes or a pneumatic drill may affect the function of the system; this may include reduced performance or a false activation.

- This function is designed as an aid to the driver in detecting large stationary objects to help avoid damaging the vehicle. The system is not designed to prevent contact with small or moving objects. Always move slowly.
- The system will not detect small objects below the bumper, and may not detect objects close to the bumper or on the ground.
- The system may not detect the following objects.
  - Fluffy objects such as snow, cloth, cotton, glass-wool, etc.
  - Thin objects such as rope, wire and chain, etc.
  - Wedge-shaped objects
- If your vehicle sustains damage to the bumper fascia, leaving it misaligned or bent, the sensing zone may be altered causing inaccurate measurement of obstacles or false alarms.
- The front (if equipped) and rear sonar sensors may cause malfunction when a horn, etc. sounds or there is a ultrasonic source (such as parking sensors of other vehicles) around the vehicle because the front and rear sonar sensors detect the distance between the vehicle and the obstacle by detecting the sound wave reflected from the surface of an obstacle.

**CAUTION:**

- Keep the interior of the vehicle as quiet as possible to hear the tone clearly.
- The front and rear parking sensors (sonar) (for models with front and rear sonar) detect the distance between the

vehicle and the obstacle by detecting the sound wave reflected from the surface of the obstacle. When there is a sound such as horn, or an ultrasonic source (such as parking sensors of other vehicles) around the vehicle, the sensor (sonar) may not detect objects properly.

- Keep the sensors (located on the bumper fascia) free from snow, ice and large accumulations of dirt. Do not clean the sensors with sharp objects. If the sensors are covered, the accuracy of the sensor function will be diminished.

**For the vehicle equipped with rear sensor:**

The system inform with visual (if equipped) and audible signal of rear obstacles when the shift lever is in the "R" (Reverse) position.

The system is deactivated at speeds above 10 km/h (6 MPH). It is reactivated at lower speeds.

The intermittent tone will stop after 3 seconds when an obstacle is detected by only the corner sensor and the distance does not change. The tone will stop when the obstacle get away from the vehicle.

**For the vehicle equipped with front and rear sensor:**

The system inform with visual and audible signal of front obstacles when the shift lever is in the "D" (Drive) position and both front and rear obstacles when the shift lever is in the "R" (Reverse) position.

The system is deactivated at speeds above 10 km/h (6 MPH). It is reactivated at lower speeds.

The intermittent tone will stop after 3 seconds when an obstacle is detected by only the parking sensor and the distance does not change. The tone will stop when the obstacle get away from the vehicle.

**PARKING SENSOR (sonar) INDICATOR (if equipped)**

For the vehicle equipped with rear sensor

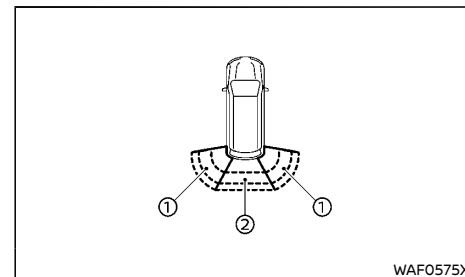

**Type A**

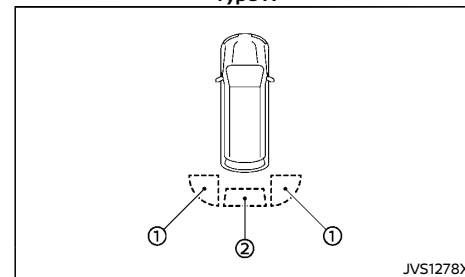

**Type B**

When the corner of the vehicle moves closer to an object, the corner sensor indicators ① appears.

When the center of the vehicle moves close to an object, the center sensor indicator ② appears.

When the object is detected, the indicator (green) appears and the tone sounds intermittently. When the vehicle moves closer to the

object, the color of the indicator turns yellow. When the vehicle is very close to the object, the indicator turns red, and the tone sounds continuously.

For the vehicle equipped with front and rear sensor

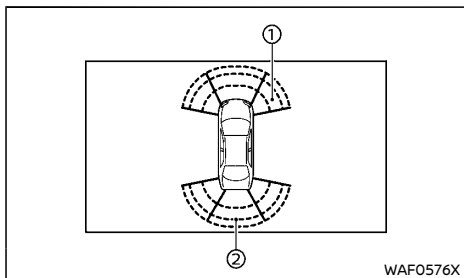

When the corner of the vehicle moves closer to an object, the parking sensor indicator ① appears.

When the center of the vehicle moves close to an object, the center sonar indicator ② appears.

When the object is detected, the indicator (green) appears and blinks and the tone sounds intermittently. When the vehicle moves closer to the object, the color of the indicator turns yellow and the rate of the blinking increase. When the vehicle is very close to the object, the indicator stops blinking and turns red, and the tone sounds continuously.

## PARKING SENSOR (sonar) SYSTEM SWITCH

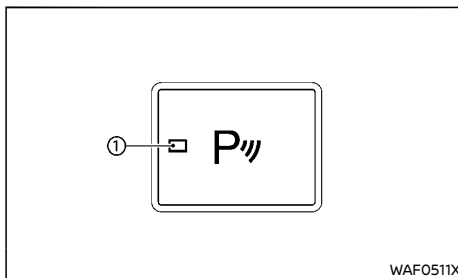

The parking sensor (sonar) system switch allows the driver to turn the parking sensor (sonar) system on and off. To turn the parking sensor (sonar) system on and off, the ignition switch must be in the "ON" position.

The indicator light ① on the switch will illuminate when the system is turned on.

If the indicator light flashes when the parking sensor (sonar) system is not turned off, it may indicate a malfunction in the parking sensor (sonar) system.

The parking sensor (sonar) system will be turned on automatically under the following conditions:

- When the ignition switch is switched from the "OFF" position to the "ON" position.
- When the shift lever is shifted into the "R" (Reverse) position.
- When the vehicle speed increases to 10 km/h (6 MPH) and decreases.

## PARKING SENSOR (sonar) SYSTEM SETTING (if equipped)

The following status of the parking sensor (sonar) system can be changed by switches on the steering-wheel-mounted controls. For details, see "Settings" (P.2-22).

### Moving Object (if equipped)

Activate or deactivate the use of sensor. For more details, see "Moving Object Detection (MOD)" (P.4-19).

ON (default) - OFF

### Sensor

Activate or deactivate the use of sensor.

ON (default) - OFF

### Volume

Adjust the volume of the tone.

High - Medium (default) - Low

### Range or Distance

Adjust the detection range of the sensor.

Long - Medium (default) - Short

## TRAILER TOWING (except for South Africa)

Your vehicle was designed to be used to carry passengers and luggage. NISSAN does not recommend trailer towing, because it places additional loads on your vehicle's engine, drive-train, steering, braking, and other systems.



### CAUTION:

**Vehicle damage resulting from towing a trailer is not covered by the warranties.**

## TRAILER TOWING (for South Africa)

Your new vehicle was designed to be used primarily to carry passengers and luggage.

Towing a trailer will place additional loads on your vehicle's engine, drive train, steering, braking and other systems. The towing of a trailer will exaggerate other conditions such as sway caused by crosswinds, rough road surfaces or passing trucks.

Your driving style and speed must be adjusted according to the circumstances. Before towing a trailer, see a NISSAN dealer for an explanation about the proper use of towing equipment.

### OPERATING PRECAUTIONS

- Avoid towing a trailer during the break-in period.
- Before driving, make sure that the lighting system of the trailer works properly.
- Observe the legal maximum speeds for trailer operation.
- Avoid abrupt starts, accelerations and stops.
- Avoid sharp turns and lane changes.
- Always drive your vehicle at a moderate speed.
- Do not use the following systems (if equipped) while towing a trailer:
  - Lane Departure Warning (LDW) system
  - Intelligent Emergency Braking system
  - Intelligent Forward Collision Warning system
- Follow the trailer manufacturer's instructions.
- Choose proper coupling devices (trailer hitch, safety chain, roof carrier, etc.) for your vehicle and trailer. These devices are available from a NISSAN dealer where you can also obtain more detailed information about trailer towing.

- Never allow the total trailer load (trailer weight plus its cargo weight) to exceed the maximum set for the vehicle and the coupling device. See a NISSAN dealer for more information.
- The trailer must be loaded so that heavy goods are placed over the axle. The maximum allowable vertical load on the trailer hitch must not be exceeded.
- Have your vehicle serviced more often than at the intervals specified in a separate maintenance booklet.
- Trailer towing requires more fuel than under normal circumstances because of a considerable increase in traction power and resistance.

**While towing a trailer, check the engine coolant temperature indicator to prevent the vehicle from overheating.**

### MAXIMUM LOAD LIMITS

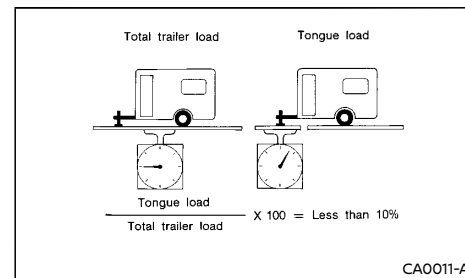

Maximum trailer loads (including tyres and other loaded equipment):

1. Never allow the total trailer load to exceed:
  - The maximum 750 kg (1,654 lb) for a trailer without brakes.



- The maximum 2,100 kg (4,631 lb) for a trailer with brakes.
2. The total trailer load must be lower than the following three values even if it does not exceed the maximum permissible trailer loads.
- Towing capacity displayed on a tow-bar.
  - Trailer's gross vehicle mass marked on a coupling body.
  - Gross vehicle mass marked on a trailer data plate.

The maximum trailer load which can be towed by your vehicle depends on the towing equipment fitted to the vehicle. Therefore, it is important to not only have the correct equipment fitted but also to use it correctly. Towing loads greater than the value specified for your vehicle or using towing equipment which is not provided by NISSAN could seriously affect the handling and/or performance of your vehicle.

Vehicle damage resulting from improper towing procedures is not covered by NISSAN warranties. Information on trailer towing and the required equipment should be obtained from a NISSAN dealer.

**"Never exceed the Gross Vehicle Mass (GVM), Gross Combination Mass (GCM) or Front/Rear Gross Axle Weight Rating (GAWR)"**

### Maximum tongue load

Never allow the tongue load to exceed 4% of the total trailer load. If the tongue load exceeds 4%, rearrange the cargo in the trailer.

### Maximum rear gross axle weight

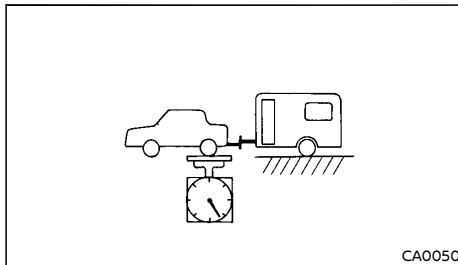

The rear gross axle weight must not exceed the Gross Axle Weight Rating (GAWR).

#### **GAWR:**

#### **Rear**

**STD Grade: 1,600 kg (3,528 lb)**

**MID Grade 2WD: 1,550 kg (3,418 lb)**

**MID Grade 4WD: 1,600 kg (3,528 lb)**

**Premium Grade: 1,550 kg (3,418 lb)**

The trailer must be loaded so that heavy goods are placed over the axle.

### TYRE PRESSURE

When towing a trailer, inflate the vehicle tyres to the maximum recommended COLD tyre pressure (for full loading) indicated on the tyre placard.

Do not tow a trailer when the vehicle is installed with a temporary spare tyre or a compact spare tyre.

### SAFETY CHAINS

Always use a suitable chain between the vehicle and trailer. The chain should be crossed and should be attached to the hitch, not to the vehicle bumper or axle. Be sure to leave enough slack in the chain to permit turning corners.

### TRAILER BRAKES

Ensure that trailer brakes are installed as required by local regulations. Also check that all other trailer equipment conforms to local regulations.

Always block the wheels on both the vehicle and trailer when parking. Apply the hand brake on the trailer if equipped. Parking on a steep slope is not recommended.

If parking on a steep slope is unavoidable, place the shift lever in the "P" (Park) position (Automatic transmission model), or in an appropriate position (Manual transmission model), and turn the front wheels towards the curb.

### TRAILER DETECTION (if equipped)

When towing a trailer with a genuine NISSAN tow bar electrical kit and the turn signal switch is used, the electrical system of the vehicle will detect the additional electrical load of the trailer lighting. As a result, the direction indicator tone will be different.

## POWER STEERING



### WARNING:

**If the engine is not running or is turned off while driving, the power assist for the steering will not work. The steering will be much harder to operate.**

The power assisted steering is designed to use a hydraulic pump driven by the engine, to assist steering.

If the engine stops or the drive belt breaks, you will still have control of the vehicle. However, greater steering effort is needed, especially in sharp turns and at low speeds.

## BRAKE SYSTEM

The brake system has two separate hydraulic circuits. If one circuit malfunctions, you will still have braking ability at two wheels.

### BRAKE PRECAUTIONS

#### Vacuum assisted brakes

The brake booster aids braking by using engine vacuum. If the engine stops, you can stop the vehicle by depressing the foot brake pedal. However, greater foot pressure on the foot brake pedal will be required to stop the vehicle. The stopping distance will be longer.

If the engine is not running or is turned off while driving, the power assisted brakes will not function. Braking will be harder.



### WARNING:

**Do not coast with the engine stopped.**

#### Using brakes

Avoid resting your foot on the foot brake pedal while driving. This will overheat the brakes, wear out the brake linings/pads faster, and increase fuel consumption.

To help reduce brake wear and to prevent the brakes from overheating, reduce speed and downshift to a lower gear before going down a slope or long grade. Overheated brakes may reduce braking performance and could result in loss of vehicle control.

While driving on a slippery surface, be careful when braking, accelerating or downshifting. Abrupt braking or acceleration could cause the wheels to skid and result in an accident.

#### Wet brakes

When the vehicle is washed or driven through water, the brakes may get wet. As a result, your braking distance will be longer and the vehicle may pull to one side during braking.

To dry the brakes, drive the vehicle at a safe speed while lightly depressing the foot brake pedal to heat up the brakes. Do this until the brakes return to normal. Avoid driving the vehicle at high speeds until the brakes function correctly.

### BRAKE ASSIST

When the force applied to the brake pedal exceeds a certain level, the Brake Assist is activated generating greater braking force than a conventional brake booster even with light pedal force.



### WARNING:

**The Brake Assist is only an aid to assist braking operation and is not a collision warning or avoidance device. It is the driver's responsibility to stay alert, drive safely and be in control of the vehicle at all times.**

### ANTI-LOCK BRAKING SYSTEM (ABS)



### WARNING:

**The Anti-lock Braking System (ABS) is a sophisticated device, but it cannot prevent accidents resulting from careless or dangerous driving techniques. It can help maintain vehicle control during braking on slippery surfaces. Remember that stopping distances on slippery surfaces will be longer than on normal surfaces even with ABS. Stopping distances may also be longer on rough, gravel or snow covered roads, or if you are**

## VEHICLE SECURITY

using tire chains. Always maintain a safe distance from the vehicle in front of you. Ultimately, the driver is responsible for safety.

Tire type and condition may also affect braking effectiveness.

- When replacing tires, install the specified size of tires on all four wheels.
- When installing a spare tire, make sure that it is the proper size and type as specified on the tire placard. (See "Tire placard" (P.9-10).)
- For detailed information, see "Tires and wheels" (P.8-32).

The Anti-lock Braking System (ABS) controls the brakes so the wheels do not lock during hard braking or when braking on slippery surfaces. The system detects the rotation speed at each wheel and varies the brake fluid pressure to prevent each wheel from locking and sliding. By preventing each wheel from locking, the system helps the driver maintain steering control and helps to minimize swerving and spinning on slippery surfaces.

### Using system

Depress the brake pedal and hold it down. Depress the brake pedal with firm steady pressure, but do not pump the brakes. The ABS will operate to prevent the wheels from locking up. Steer the vehicle to avoid obstacles.



#### **WARNING:**

**Do not pump the brake pedal. Doing so may result in increased stopping distances.**

### Self-test feature

The ABS includes electronic sensors, electric pumps, hydraulic solenoids and a computer. The computer has a built-in diagnostic feature that tests the system each time you start the engine and move the vehicle at a low speed in forward or reverse. When the self-test occurs, you may hear a "clunk" noise and/or feel a pulsation in the brake pedal. This is normal and does not indicate a malfunction. If the computer senses a malfunction, it switches the ABS off and illuminates the ABS warning light on the instrument panel. The brake system then operates normally, but without anti-lock assistance. If the ABS warning light illuminates during the self-test or while driving, have the vehicle checked by a NISSAN dealer.

### Normal operation

The ABS operates at speeds above 5 to 10 km/h (3 to 6 MPH). The speed varies according to road conditions.

When the ABS senses that one or more wheels are close to locking up, the actuator rapidly applies and releases hydraulic pressure. This action is similar to pumping the brakes very quickly. You may feel a pulsation in the brake pedal and hear a noise from under the hood or feel a vibration from the actuator when it is operating. This is normal and indicates that the ABS is operating properly. However, the pulsation may indicate that road conditions are hazardous and extra care is required while driving.

When the differential lock (if equipped) is engaged, the ABS warning light illuminates. This indicates that the anti-lock function is not fully operating. (See "Rear differential locking system" (P.5-26) for the rear differential lock function.)

When leaving your vehicle unoccupied:

- Always take the key with you - even when leaving the vehicle in your own garage.
- Close all windows completely and lock all doors.
- Always park your vehicle where it can be seen. Park in a well lit area during the night.
- If the security system is equipped, use it - even for a short period.
- Never leave children or pets in the vehicle unattended.
- Never leave valuables inside the vehicle. Always take valuables with you.
- Never leave the vehicle documents in the vehicle.
- Never leave articles on a roof rail. Remove them from the rack and keep and lock them inside the vehicle.
- Never leave the spare key in the vehicle.

## COLD WEATHER DRIVING



### WARNING:

- **Whatever the condition, drive with caution. Accelerate and decelerate with great care. If accelerating or decelerating too fast, the drive wheels will lose even more traction.**
- **Allow more stopping distance in cold weather driving. Braking should be started sooner than on dry pavement.**
- **Keep at a greater distance from the vehicle in front of you on slippery roads.**
- **Wet ice (0°C, 32°F and freezing rain), very cold snow and ice can be slick and very difficult to drive on. The vehicle will have a lot less traction or grip under these conditions. Try to avoid driving on wet ice until the road is salted or sanded.**
- **Watch for slippery spots (glaring ice). These may appear on an otherwise clear road in shaded areas. If a patch of ice is seen ahead, brake before reaching it. Try not to brake while actually on the ice, and avoid any sudden steering maneuvers.**
- **Do not use cruise control on slippery roads. (if equipped)**
- **Snow can trap dangerous exhaust gas under your vehicle. Keep snow clear of the exhaust pipe and from around your vehicle.**

### BATTERY

If the battery is not fully charged during extremely cold weather conditions, the battery fluid may freeze and damage the battery. To maintain maximum efficiency, the battery should be checked regularly. For details, see "Battery" (P.8-22) of this manual.

### ENGINE COOLANT

If the vehicle is to be left outside without anti-freeze, drain the cooling system, including the engine block. Refill before operating the vehicle. For details, see "Changing engine coolant" (P.8-9) of this manual.

### TIRE EQUIPMENT

1. If you have snow tires installed on the front/rear wheels of your vehicle, they should be of the same size, loading range, construction and type (bias, bias-belted or radial) as the rear/front tires.
2. If the vehicle is to be operated in severe winter conditions, snow tires should be installed on all four wheels.
3. For additional traction on icy roads, studded tires may be used. However, some countries, provinces and states prohibit their use. Check local, state and provincial laws before installing studded tires.  
**Skid and traction capabilities of studded snow tires, on wet or dry surfaces, may be poorer than that of non-studded snow tires.**
4. Snow chains may be used if desired. Make sure they are the proper size for the tires on your vehicle and are installed according to the chain manufacturer's instructions. Use chain tensioners when recommended by the tire chain manufacturer to ensure a

tight fit. Loose end links of the tire chains must be secured or removed to prevent the possibility of whipping action damage to the fenders or underbody. In addition, drive at a reduced speed, otherwise, your vehicle may be damaged and/or vehicle handling and performance may be adversely affected.

### SPECIAL WINTER EQUIPMENT

It is recommended that the following items be carried in the vehicle during the winter:

- A scraper and stiff-bristled brush to remove ice and snow from the windows.
- A sturdy, flat board to be placed under the jack to give it firm support.
- A shovel to dig the vehicle out of snow-drifts.

### PARKING BRAKE

When parking in the area where the outside temperature is below 0°C (32°F), do not apply the parking brake to prevent it from freezing. For safe parking:

- Place the shift lever in the "P" (Park) position (Automatic transmission model).
- Place the shift lever in the "1" (1st) or "R" (Reverse) gear (Manual transmission model).
- Securely block the wheels.

## CORROSION PROTECTION

Chemicals used for road surface deicing are extremely corrosive and will accelerate corrosion and the deterioration of underbody components such as the exhaust system, fuel and brake lines, brake cables, floor pan and fenders.

**In the winter, the underbody must be cleaned periodically. For additional information, see "Corrosion protection" (P.7-5) of this manual.**

For additional protection against rust and corrosion, which may be required in some areas, consult a NISSAN dealer.

**MEMO**

# 6 In case of emergency

Hazard indicator flasher switch .....	6-2	Installing spare tire .....	6-6
Flat tire .....	6-2	Stowing damaged tire and tools .....	6-7
Tire Pressure Monitoring System (TPMS) (if equipped) .....	6-2	Jump starting .....	6-7
Stopping vehicle .....	6-2	Push starting .....	6-11
Preparing tools .....	6-3	If your vehicle overheats .....	6-11
Removing the spare tire .....	6-4	Towing your vehicle .....	6-12
Blocking wheels .....	6-5	Towing precautions .....	6-12
Removing tire .....	6-5	Towing recommended by NISSAN .....	6-13

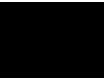

## HAZARD INDICATOR FLASHER SWITCH

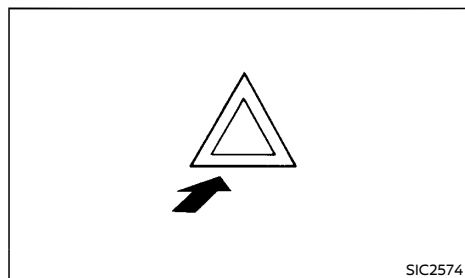

The hazard indicator flasher switch operates regardless of the ignition switch position except when the battery is discharged.

The hazard indicator flasher is used to warn other drivers when you have to stop or park under emergency conditions.

When the hazard indicator flasher switch is pushed, all turn signal lights will flash. To turn off the hazard indicator flasher, push the hazard indicator flasher switch again.

When an impact that could activate the supplemental air bags is detected, the hazard warning flasher lights blink automatically. If the hazard warning flasher switch is pushed, the hazard warning flashers will turn off.

### **WARNING:**

**Do not turn the hazard warning flasher switch to off until you can make sure that it is safe to do so. Also, the hazard flasher warning may not blink automatically depending on the force of impact.**

## FLAT TIRE

If you have a flat tire, follow the instructions in this section.

### TIRE PRESSURE MONITORING SYSTEM (TPMS) (if equipped)

#### **WARNING:**

- **If the low tire pressure warning light illuminates while driving, avoid sudden steering maneuvers or abrupt braking, reduce vehicle speed, pull off the road to a safe location and stop the vehicle as soon as possible. Driving with under-inflated tires may permanently damage the tires and increase the likelihood of tire failure. Serious vehicle damage could occur and may lead to an accident and could result in serious personal injury. Check the tire pressure for all four tires. Adjust the tire pressure to the recommended COLD tire pressure shown on the tire placard to turn the low tire pressure warning light off. If the light still illuminates while driving after adjusting the tire pressure, a tire may be flat or the TPMS may be malfunctioning. If you have a flat tire, replace it with a spare tire as soon as possible. If no tire is flat and all tires are properly inflated, have the vehicle checked by a NISSAN dealer.**
- **Since the spare tire is not equipped with the TPMS, when a spare tire is mounted or a wheel is replaced, the TPMS will not function and the low tire pressure warning light will flash for approximately 1 minute. The light will remain on after the 1 minute. Contact a NISSAN dealer as soon as possible for tire replacement and/or system resetting.**

- **Replacing tires with those not originally specified by NISSAN could affect the proper operation of the TPMS.**
- **Do not inject any tire liquid or aerosol tire sealant into the tires, as this may cause a malfunction of the tire pressure sensors.**

The Tire Pressure Monitoring System (TPMS) monitors tire pressure of all tires except the spare. When the low tire pressure warning light is lit, one or more of your tires is significantly under-inflated. If the vehicle is being driven with low tire pressure, the TPMS will activate and warn you of it by the low tire pressure warning light (in the meter panel). This system will activate only when the vehicle is driven at speeds above 25 km/h (16 MPH).

For more details, see "Low tire pressure warning light" (P.2-15) and "Tire Pressure Monitoring System (TPMS)" (P.5-5).

### STOPPING VEHICLE

#### **WARNING:**

- **Be sure to apply the parking brake firmly.**
- **Be sure to move the shift lever to the "P" (Park) position (Automatic Transmission model).**
- **Be sure to move the shift lever to the "R" (Reverse) position (Manual Transmission model).**
- **Never change tires when the vehicle is on a slope, ice or slippery area. This is hazardous.**
- **Never change tires when the oncoming traffic is close to your vehicle. Call for professional road assistance.**



1. Safely move the vehicle off the road away from traffic.
2. Turn on the hazard indicator flasher lights.
3. Park on a level surface.
4. Apply the parking brake.
5. **Automatic Transmission model:**  
Move the shift lever to the "P" (Park) position.
- Manual Transmission model:**  
Move the shift lever to the "R" (Reverse) position.
6. Turn off the engine.
7. Open the hood:
  - To warn other traffic.
  - To signal professional road assistance personnel that you need assistance.
8. Have all passengers get out from the vehicle and stand in a safe place, away from other traffic and clear of the vehicle.

## PREPARING TOOLS

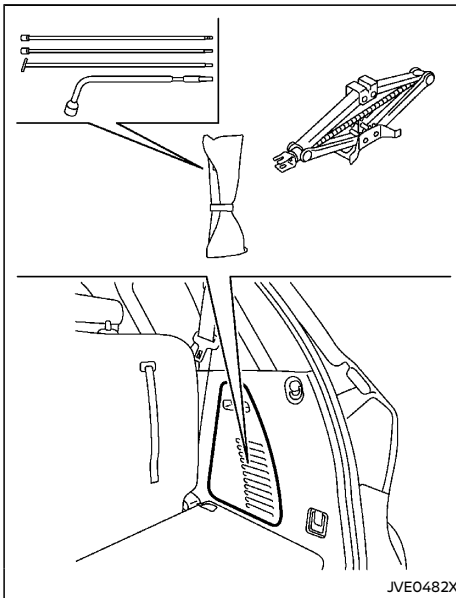

Remove the jack and necessary tools from the storage area.

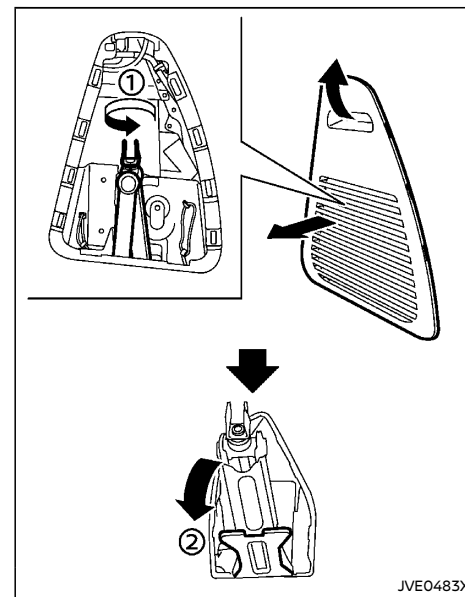

1. Remove the storage door.
2. Unhook the clips restraining the tool kit, and then remove the tool kit.
3. Loosen the jack by turning the jack lever ① as shown in the illustration.
4. Tilt the top ② of the jack towards you, and then remove the jack slowly. To store the jack, perform this in the reverse order and then tighten the jack lever so that it does not rattle.

JVE0483X

**CAUTION:**

When removing the jack, be careful that your hands do not hit against the vehicle. Otherwise, this could result in personal injury.

**NOTE:**

- When storing the jack, do not overtighten the jack lever using a screw driver. Doing so could cause deformation of the installation area for the jack.
- Do not allow the jack to contact the interior parts. Doing so could cause damage to the vehicle.

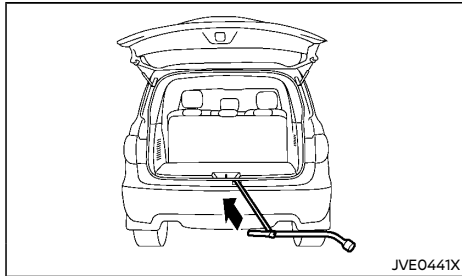
**REMOVING THE SPARE TIRE****CAUTION:**

Do not insert the jack rod straight as it is designed to be inserted at an angle as shown.

1. Fit the square end of the jack rod into the square hole of the wheel nut wrench to form a handle. Connect the T-shaped end of the jack rod and the extension bar.

2. Locate the oval opening above the middle of the rear bumper.
3. Place the T-shaped end of the jack rod through the opening and direct it towards the spare tire winch, located directly above the spare wheel.

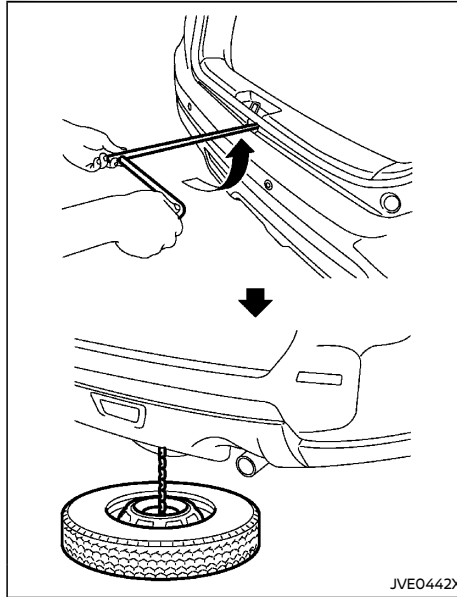

4. Seat the T-shaped end of the jack rod into the T-shaped opening of the spare wheel winch. Apply pressure to keep the jack rod engaged in the spare wheel winch and turn the jack rod counterclockwise to lower the spare wheel.

5. Once the spare tire is completely lowered, remove the jack rod and reach under the vehicle to remove the retainer chain.
6. Carefully slide the spare wheel from under the rear of the vehicle.

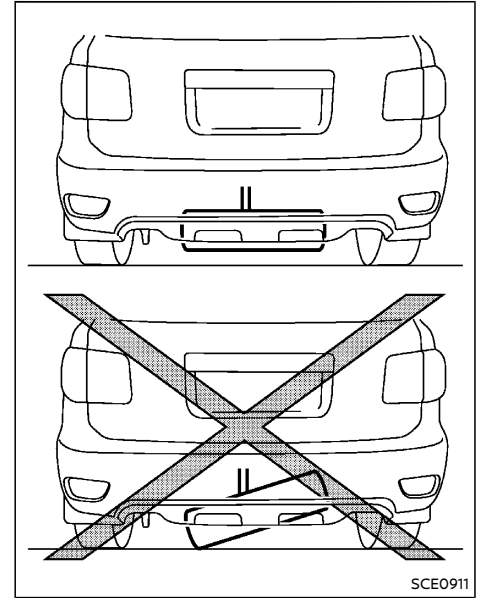
**CAUTION:**

When storing the wheel, be sure to mount the wheel horizontally. Securing a wheel that is in a tilted position as illustrated may cause looseness and dropping of the wheel while driving. Lower the wheel on the ground

again, and make sure that the hanging plate is properly set. Hang the wheel again and make sure that the wheel is held horizontally, then store the wheel.

## BLOCKING WHEELS

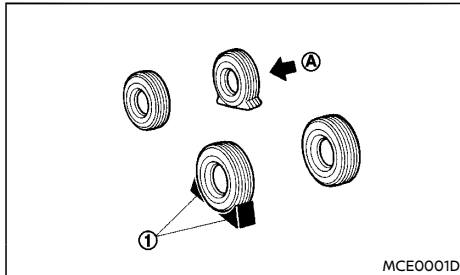

### WARNING:

Be sure to block the appropriate wheel to prevent the vehicle from moving, which may cause personal injury.

Place suitable blocks ① at both the front and back of the wheel diagonally opposite the flat tire ② to prevent the vehicle from moving when it is jacked up.

## REMOVING TIRE



### WARNING:

- Be sure to read and follow the instructions in this section.
- **DO NOT GET UNDER A VEHICLE THAT IS SUPPORTED BY A JACK.**

- Never use a jack which was not provided with your vehicle.
- The jack, which is provided with your vehicle, is designed only to lift your vehicle during a tire change.
- Never jack up the vehicle at a location other than the jack-up point that is specified.
- Never lift the vehicle more than necessary.
- Never use blocks on or under the jack.
- Never start or run the engine while the vehicle is on the jack. The vehicle may move suddenly, and this may cause an accident.
- Never allow passengers to remain in the vehicle while the tire is off the ground.
- Be sure to read the caution label attached to the jack body before using.

## Jacking up vehicle

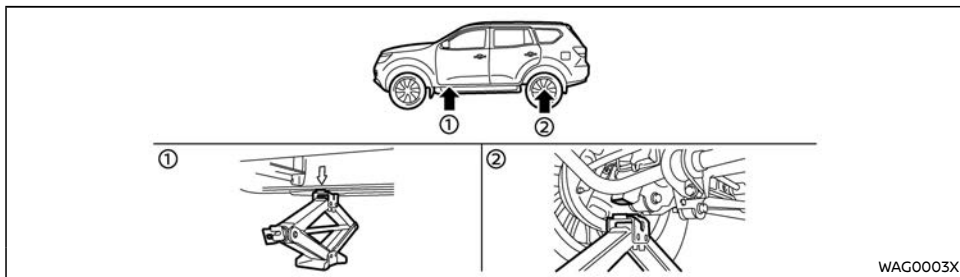

- ① For front wheel
- ② For rear wheel

1. Place the jack directly under the jack-up points ① or ② as illustrated.

**The jack should be placed on firm level ground.**

2. Loosen each wheel nut, counterclockwise, one or two turns with the wheel nut wrench.

**Do not remove the wheel nuts until the tire is off the ground.**

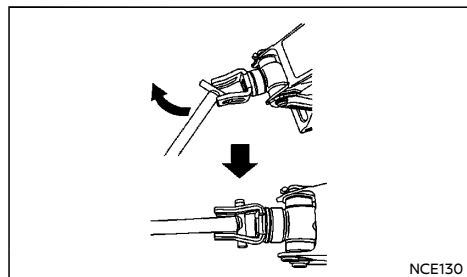

3. Install the assembled jack rod into the jack as shown.
4. Carefully raise the vehicle until the clearance between the tire and ground is achieved.
5. To lift the vehicle, securely hold the jack lever and rod with both hands and turn the jack lever.

### Removing tire

1. Remove the wheel nuts.
2. Remove the damaged tire.

### CAUTION:

**The tire is heavy. Be sure that your feet are clear from the tire and use gloves as necessary to avoid injury.**

## INSTALLING SPARE TIRE

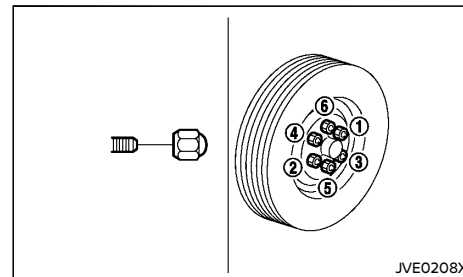

### WARNING:

- **Never use wheel nuts which are not provided with your vehicle. Incorrect wheel nuts or improperly tightened wheel nuts may cause the wheel to become loose or come off. This could cause an accident.**

- **Never use oil or grease on the wheel studs or nuts. This may cause the wheel nuts to become loose.**

1. Clean any mud or dirt from the surface between the wheel and hub.
2. Carefully put the spare tire on and tighten the wheel nuts with your fingers. Check that all the wheel nuts contact the wheel surface horizontally.
3. Tighten the wheel nuts alternately and evenly in the sequence illustrated (① - ⑥), more than 2 times with the wheel nut wrench, until they are tight.
4. Lower the vehicle slowly until the tire touches the ground.

5. Tighten the wheel nuts securely, with the wheel nut wrench, in the sequence illustrated.

6. Lower the vehicle completely.

**Tighten the wheel nuts to the specified torque with a torque wrench as soon as possible.**

**Wheel nut tightening torque:  
133 N·m (13.6 kg·m, 98 ft·lb)**

**The wheel nuts must be kept tightened to specification at all times. It is recommended that the wheel nuts be tightened to specification at each lubrication interval.**



**WARNING:**

**Retighten the wheel nuts when the vehicle has been driven for 1,000 km (600 miles) (also in case of a flat tire, etc.).**

For models equipped with Tire Pressure Monitoring System (TPMS)

- After adjusting the tire pressure, the TPMS must be reset (model with TPMS reset function). See "Tire Pressure Monitoring System (TPMS)" (P.5-5) for details about the resetting procedure.
- After adjusting tire pressure to the COLD tire pressure, the display of the tire pressures may show higher pressure than the COLD tire pressure after the vehicle has been driven more than 1.6 km (1 mile). This is because the tire pressurizes as the tire temperature rises. This does not indicate a system malfunction.

## STOWING DAMAGED TIRE AND TOOLS



**WARNING:**

**Be sure that the tire, jack and tools are properly stored after use. Such items can become dangerous projectiles in an accident or sudden stop.**

Securely store the damaged tire, jack and tools in the storage area in the reverse order of removal. (See "Preparing tools" (P.6-3) and "Removing the spare tire" (P.6-4).)

## JUMP STARTING



**WARNING:**

- **Incorrect jump starting can lead to a battery explosion. The battery explosion may result in severe injury or death. It may also result in damage to the vehicle. Be sure to follow the instructions in this section.**
- **Explosive hydrogen gas is always present in the vicinity of the battery. Keep all sparks and flames away from the battery.**
- **Always wear suitable eye protection and remove rings, bracelets, and any other jewelry whenever working on or near a battery.**
- **Never lean over the battery while jump starting.**
- **Never allow battery fluid to come into contact with eyes, skin, clothes or the vehicle's painted surfaces. Battery fluid is a corrosive sulfuric acid which can cause severe burns. If the fluid comes into contact with anything, immediately flush the contacted area with plenty of water.**
- **Keep the battery out of the reach of children.**
- **The booster battery must be rated at 12 volts. Use of an incorrectly rated battery will damage your vehicle.**
- **Never attempt to jump start a frozen battery. It could explode and cause serious injury.**

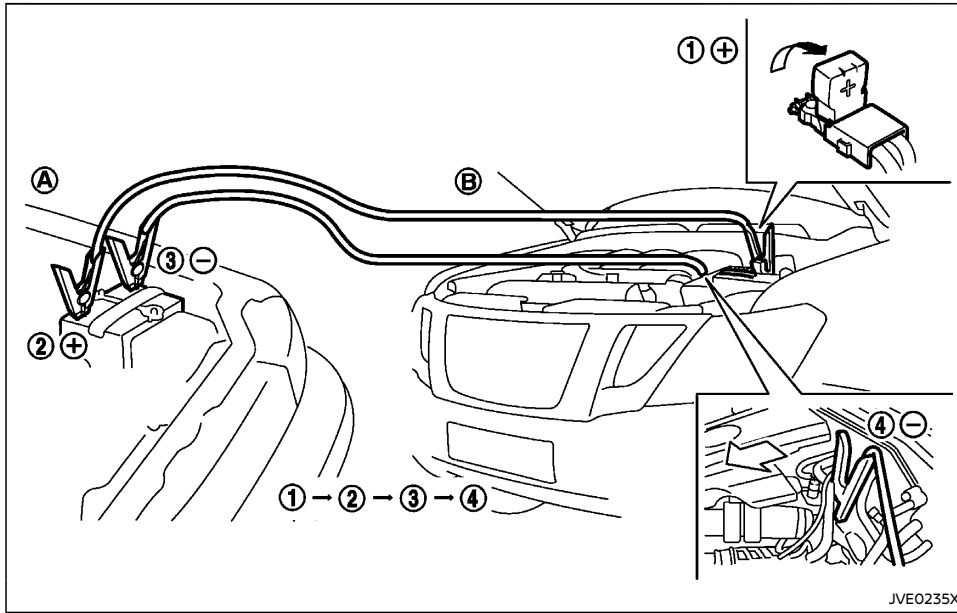

YD25DDTi engine models

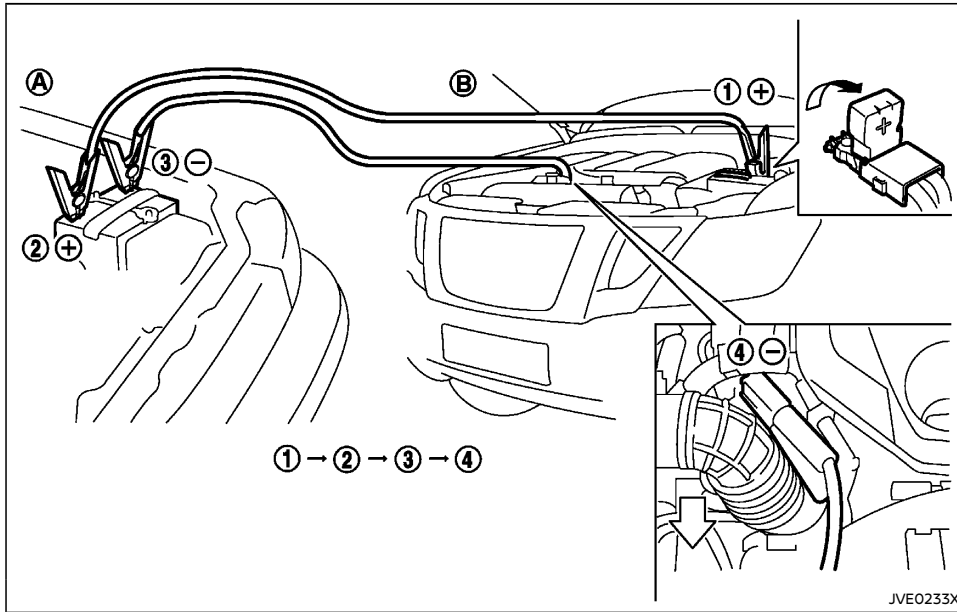

YS23DDTT engine models

JVE0233X

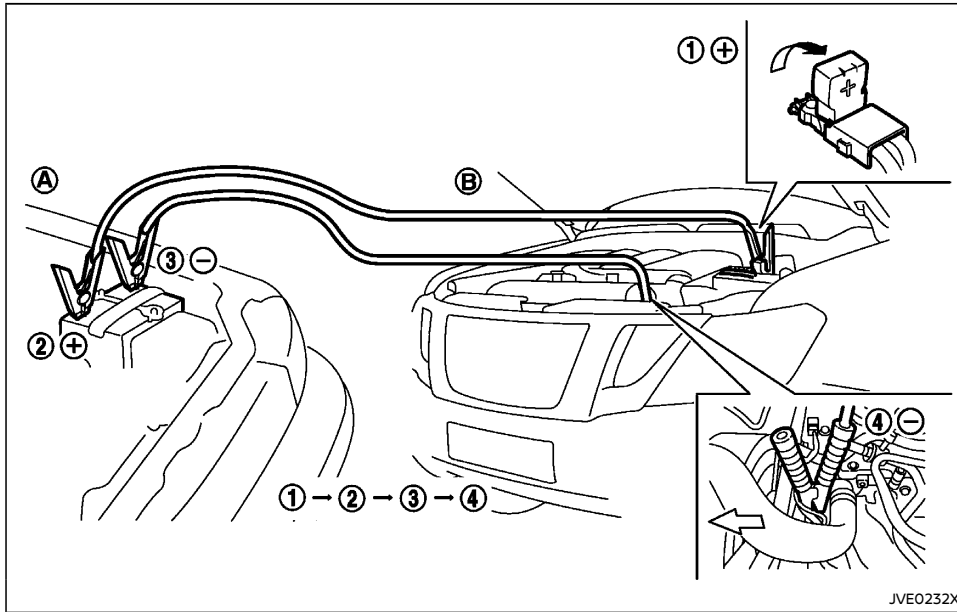

QR25DE engine models

JVE0232X

1. If the booster battery is in another vehicle (A), position the two vehicles (A) and (B) to bring the batteries into close proximity to each other.

**CAUTION:**

- Do not allow the two vehicles to touch.
- If the battery of vehicle (B) equipped with the Intelligent Key system is discharged, the steering wheel will lock and cannot be turned with the ignition switch in the

“OFF” position. Supply power using jumper cables before pushing the ignition switch to any position other than the “OFF” position and disengaging the steering lock.

2. Apply the parking brake.
3. **Automatic transmission (AT) model:**  
Move the shift lever to the “P” (Park) position.  
**Manual transmission (MT) model:**

Move the shift lever to the “N” (Neutral) position.

4. Switch off all unnecessary electrical systems (headlights, heater, air conditioner, etc.).
5. Place the ignition switch in the “OFF” position.
6. Remove the vent caps, if equipped, on the battery.
7. Cover the battery with a firmly wrung out moist cloth to reduce the hazard of an explosion.
8. Connect the jumper cables in the sequence as illustrated (1, 2, 3, 4).

**CAUTION:**

- Always connect positive (+) to positive (+) and negative (-) to body ground, NOT to the battery's negative (-).
- Be sure that the jumper cables do not touch moving parts in the engine compartment.
- Be sure that the jumper cable's clamps do not contact any other metal.

9. Start the engine of the booster vehicle (A) and let it run for a few minutes.
10. Depress the accelerator pedal of the booster vehicle (A) at about 2,000 rpm.
11. Start the engine of the jumped vehicle (B) in the normal manner.

**CAUTION:**

Never keep the starter motor engaged for more than 10 seconds. If the engine does not start right away, place the ignition switch in the “LOCK” position and wait at least 10



## PUSH STARTING

Do not attempt to start the engine by pushing the vehicle.



### CAUTION:

- **Automatic Transmission (AT) model cannot be started by pushing. Attempting to do so may cause damage to the transmission.**
- **Three-way catalyst equipped model should not be started by pushing. Attempting to do so may cause damage to the three-way catalyst.**
- **Diesel Oxidation Catalyst equipped model should not be started by pushing. Attempting to do so may cause damage to the catalyst.**
- **Never try to start the engine by towing. When the engine starts, the forward surge could cause the vehicle to collide with the towing vehicle.**

### seconds before trying again.

12. After the engine is started, carefully disconnect the jumper cables in the opposite sequence from that illustrated (④, ③, ②, ①).
13. Remove and dispose of the cloth properly as it may be contaminated with corrosive acid.
14. Replace the vent caps, if removed.

## IF YOUR VEHICLE OVERHEATS



### WARNING:

- **Never continue driving if your vehicle overheats. Doing so could cause engine damage and/or a vehicle fire.**
- **Never open the hood if steam is coming out.**
- **Never remove the radiator or coolant reservoir cap while the engine is hot. If the radiator or coolant reservoir cap is removed when the engine is hot, pressurized hot water will spurt out and possibly cause burning, scalding or serious injury.**
- **If steam or coolant is coming from the engine, stand clear of the vehicle to prevent getting scalded.**
- **The engine cooling fan can start at any time when the coolant temperature exceeds preset degrees.**
- **Be careful not to allow your hands, hair, jewelry or clothing to come into contact with, or to get caught in the cooling fan or drive belts.**

If your vehicle is overheating, or if you feel a lack of engine power, detect unusual noise, etc., take the following steps:

1. Safely move the vehicle off the road away from traffic.
2. Turn on the hazard indicator flashers.
3. Apply the parking brake.
4. **Automatic transmission model:**

Move the shift lever to the "P" (Park) position.

### **Manual transmission model:**

Move the shift lever to the "N" (Neutral)

position.

**DO NOT STOP THE ENGINE.**

5. Open all the windows.
6. Turn off the air conditioner. Move the temperature control to maximum hot and the fan control to high speed.
7. Get out from the vehicle.
8. Visually inspect and listen for steam or coolant escaping from the radiator before opening the hood. Wait until no steam or coolant can be seen before proceeding.
9. Open the engine hood.
10. Visually inspect if the cooling fan is running.
11. Visually inspect the radiator and radiator hoses for leakage. If the cooling fan is not running or the coolant is leaking, stop the engine.
12. After the engine cools down, check the coolant level in the reservoir with the engine running. **Do not open the radiator or coolant reservoir cap.**
13. Add coolant to the reservoir if necessary.

Have your vehicle inspected/repared at a NISSAN dealer.

## TOWING YOUR VEHICLE

When towing your vehicle, local regulations for towing must be followed. Incorrect towing equipment could damage your vehicle. To assure proper towing and to prevent accidental damage to your vehicle, NISSAN recommends that you have professional road assistance personnel tow your vehicle. It is advisable to have the professional road assistant carefully read the following precautions.

### TOWING PRECAUTIONS

- Be sure that the transmission, steering system and powertrain are in working condition before towing. If any units are damaged, the vehicle must be towed using a dolly or flatbed tow truck. (Two-Wheel Drive (2WD) model)
- NISSAN recommends that your vehicle be towed with the driving wheels off the ground. (Two-Wheel Drive (2WD) model)
- Always attach safety chains before towing.
- Never tow Four-Wheel Drive (4WD) model with any of the wheels on the ground as this may cause serious and expensive damage to the drivetrain.

## TOWING RECOMMENDED BY NISSAN

### Towing Two-Wheel Drive (2WD) models

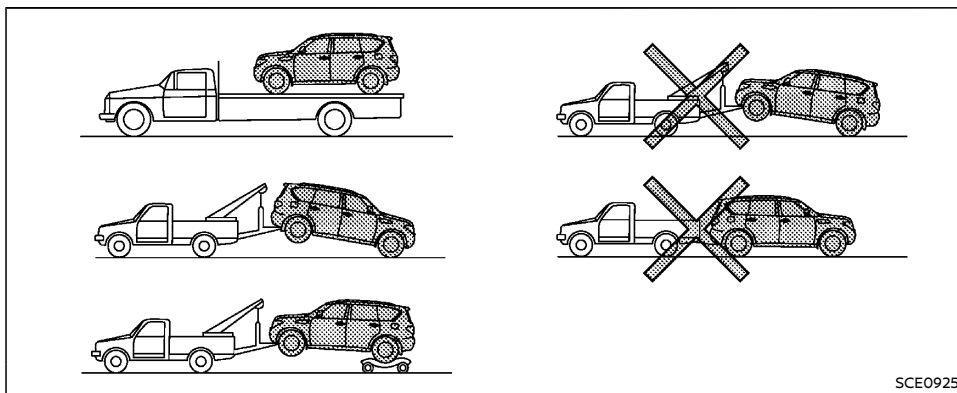

#### Front wheels on the ground:

1. Place the ignition switch in the "ON" position and turn all accessories off.
2. Secure the steering wheel in a straight ahead position with rope or similar device.
3. Move the shift lever to the "N" (Neutral) position.
4. Release the parking brake.
5. Attach safety chains before towing.

#### Rear wheels on the ground:

NISSAN recommends that towing dollies be used under the rear wheels when towing your vehicle or the vehicle be placed on a flatbed tow truck as illustrated.



#### CAUTION:

**Never tow Automatic Transmission (AT) model with the rear wheels on the ground. Doing so will cause serious and expensive damage to the transmission.**

Manual Transmission (MT) model:

If you have to tow a MT vehicle with rear wheel on the ground, perform the following procedures.



#### CAUTION:

**Observe the following restricted towing speeds and distances.**

- **Speed: Below 50 km/h (30 MPH)**
- **Distance: Less than 65 km (40 miles)**

1. Place the ignition switch in the "ON" position and turn all accessories off.
2. Move the shift lever to the "N" (Neutral) position.
3. Release the parking brake.
4. Attach safety chains whenever towing.

#### All four wheels on the ground:

NISSAN recommends that the vehicle be placed on a flatbed tow truck as illustrated.



#### CAUTION:

**Never tow Automatic Transmission (AT) model with all four wheels on the ground. Doing so will cause serious and expensive damage to the drivetrain.**

Manual Transmission (MT) model:

If you have to tow a MT vehicle with all four wheels on the ground, perform the following procedures.



#### CAUTION:

- **Never tow a Manual Transmission (MT) model backward with all four wheels on the ground.**
  - **Observe the following restricted towing speeds and distances.**
    - **Speed: Below 50 km/h (30 MPH)**
    - **Distance: Less than 65 km (40 miles)**
1. Place the ignition switch in the "ON" position and turn all accessories off.

2. Move the shift lever to the "N" (Neutral) position.
3. Release the parking brake.

### Towing Four-Wheel Drive (4WD) models

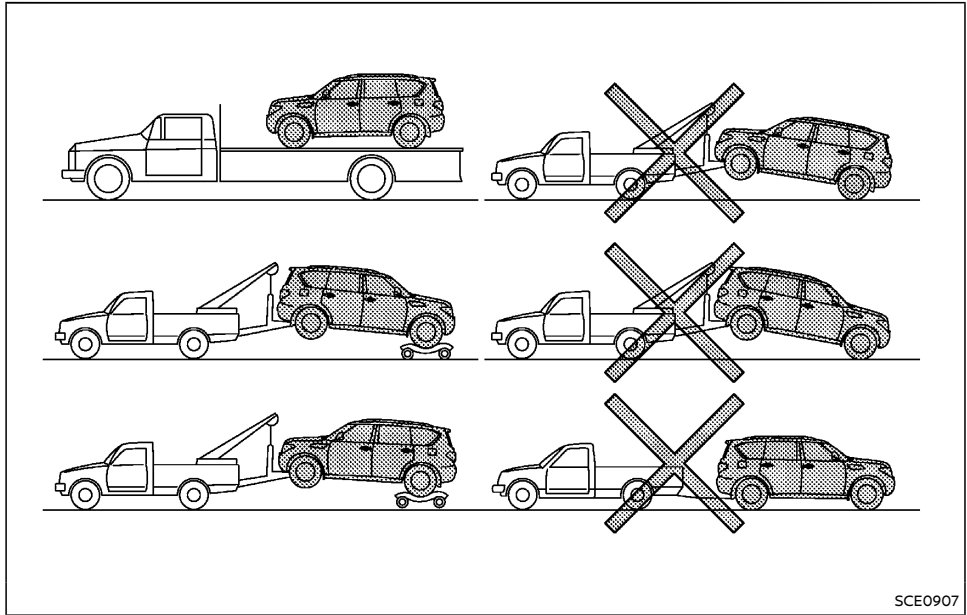

NISSAN recommends that your vehicle be towed with all wheels off the ground as illustrated or place the vehicle on a flatbed truck.



#### CAUTION:

Never tow 4WD models with any of the wheels on the ground. Doing so will cause serious and expensive damage to the drivetrain.

### Freeing trapped vehicle



#### WARNING:

- Never allow anyone to stand near the towing line during the pulling operation.
- Never spin the tires at high speed. This could cause them to explode and result in serious injury. Parts of the vehicle could also overheat and be damaged.

- **Do not pull the vehicle using the rear hook. The rear hook is not designed to pull the vehicle out in the event that the vehicle becomes trapped.**

In the event that your vehicle's tires become trapped in sand, snow, or mud, and the vehicle is unable to free itself without being pulled, use the towing hook.

- Use the towing hook only. Do not attach the pulling device to any other part of the vehicle body. Otherwise, the vehicle body may be damaged.
- Use the towing hook to free a vehicle only. Never tow a vehicle using only the towing hook.
- The towing hook is under tremendous stress when used to free a trapped vehicle. Always pull the pulling device straight out from the vehicle. Never pull on the towing hook at an angle.



**CAUTION:**

**In order to not break the towing line, tension it slowly.**

**Front:**

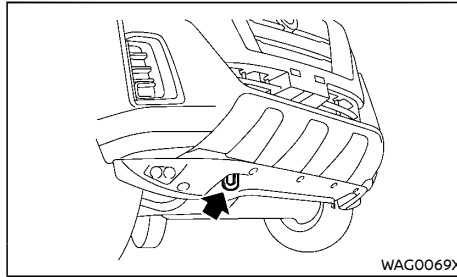

**Left-Hand Drive model**

The layout illustrated is for the Left-Hand Drive (LHD) model. On the Right-Hand Drive (RHD) model, the towing hook is located on the opposite side.

**Rear:**

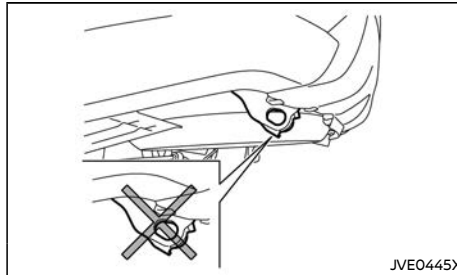

Do not use the rear hook to pull the vehicle.

**MEMO**

# 7 Appearance and care

Cleaning exterior .....	7-2	Cleaning interior .....	7-4
Washing .....	7-2	Air fresheners .....	7-4
Removing spots .....	7-2	Floor mats .....	7-4
Waxing .....	7-2	Glass .....	7-4
Glass .....	7-3	Seat belts .....	7-5
Underbody .....	7-3	Corrosion protection .....	7-5
Wheels .....	7-3	Most common factors contributing to vehicle corrosion .....	7-5
Aluminum alloy wheels .....	7-3	Environmental factors influence the rate of corrosion .....	7-5
Side step boards .....	7-3	To protect your vehicle from corrosion .....	7-5
Chrome parts .....	7-3		



## CLEANING EXTERIOR

In order to maintain the appearance of your vehicle, it is important to take proper care of it.

Whenever possible, park your vehicle inside a garage or in a covered area to minimize the chances of damaging the paint surface of your vehicle.

When it is necessary to park outside, park in a shady area or protect the vehicle with a body cover. **Be careful not to scratch the paint surface when putting on or removing the body cover.**

### WASHING

In the following instances, wash your vehicle as soon as possible to protect the paint surface:

- After a rainfall, which may cause the paint surface damage from acid rain.
  - After driving on coastal roads, which may cause rusting from the sea breeze.
  - When contaminants such as soot, bird droppings, tree sap, metal particles or bugs get on the paint surface.
  - When dust or mud builds up on the paint surface.
1. Wash the vehicle surface with a wet sponge and plenty of water.
  2. Clean the vehicle surface gently and thoroughly using a mild soap, a special vehicle soap or a general purpose dishwashing liquid mixed with clean, lukewarm (never hot) water.



#### CAUTION:

- **Do not wash the vehicle with strong household soap, strong chemical detergents, gasoline or solvents.**

- **Do not wash the vehicle in direct sunlight or while the vehicle body is hot, as the paint surface may become water-spotted.**
  - **Avoid using tight-napped or rough cloths, such as washing mitts. Care must be taken when removing caked-on dirt or other foreign substances so the paint surface is not scratched or damaged.**
  - **Lock all doors before going through automatic car wash. Locking doors helps prevent fuel-filler lid from opening and becoming damaged.**
3. Rinse the vehicle thoroughly with plenty of clean water.
  4. Use a dampened chamois to dry the paint surface and avoid leaving water spots.

When washing the vehicle, take care of the following:

- Inside flanges, joints and folds on the doors, hatches and hood are particularly vulnerable to the effects of road salt. Therefore, these areas must be cleaned regularly.
- Be sure that the drain holes in the lower edge of the doors are not clogged.
- Spray water to the underbody and in the wheel wells to loosen the dirt and/or wash away road salt.

## REMOVING SPOTS

Remove tar and oil spots, industrial dust, insects, and tree sap as quickly as possible from the paint surface to avoid lasting damage or staining. Special cleaning products are available at a NISSAN dealer or any automotive accessory store.

## WAXING

Regular waxing protects the paint surface and helps maintain a new vehicle appearance.

After waxing, polishing is recommended to remove built-up residue and to avoid a weathered appearance.

A NISSAN dealer can assist you in choosing the appropriate waxing products.



#### CAUTION:

- **Wash your vehicle thoroughly and completely before applying wax to the paint surface.**
- **Always follow the manufacturer's instructions supplied with the wax.**
- **Do not use a wax containing any abrasives, cutting compounds or cleaners that may damage the vehicle finish.**

Machine compounding or aggressive polishing on a base coat/clear coat paint finish may dull the finish or leave swirl marks.



## GLASS

Use glass cleaner to remove smoke and dust film from the glass surfaces. It is normal for glass to become coated with a film after the vehicle is parked in the hot sun. Glass cleaner and a soft cloth will easily remove this film.

## UNDERBODY

In areas where road salt is used in the winter, it is necessary to clean the vehicle's underbody regularly in order to prevent dirt and salt from building up and causing the acceleration of corrosion on the underbody and suspension.

Before the winter and again in the spring, the underseal must be checked and, if necessary, re-treated.

## WHEELS

- Wash the wheels when washing the vehicle to maintain their appearance.
- Clean the inner side of the wheels when the wheel is changed or the underside of the vehicle is washed.
- Do not use abrasive cleaners when washing the wheels.
- Inspect wheel rims regularly for dents or corrosion. This may cause loss of pressure or damage the tire bead.
- NISSAN recommends that the road wheels be waxed to protect against road salt in areas where it is used during winter.

## ALUMINUM ALLOY WHEELS

Wash the wheels regularly with a sponge dampened in a mild soap solution, especially during winter in areas where road salt is used. The salt residue from road salt could discolor the wheels if it is not washed off regularly.



### CAUTION:

**Follow the directions below to avoid staining or discoloring the wheels:**

- **Do not use a cleaner that uses strong acid or alkali contents to clean the wheels.**
- **Do not apply wheel cleaners to the wheels when they are hot. The wheel temperature should be the same as ambient temperature.**
- **Rinse the wheel to completely remove the cleaner within 15 minutes after the cleaner is applied.**

## SIDE STEP BOARDS



### CAUTION:

**When cleaning the side step boards, follow the instructions below:**

- **Do not use a cleaner that uses strong acid or alkali contents to clean the side step boards. Using strong acid or alkali contents may damage the side step board surface.**
- **Rinse off the cleaner completely from the side step boards right after it is applied.**

## CHROME PARTS

Clean all chrome parts regularly with a non-abrasive chrome polish to maintain the finish.

## CLEANING INTERIOR

Occasionally remove loose dust from the interior trim, plastic parts and seats using a vacuum cleaner or soft bristled brush. Wipe the vinyl and leather surfaces with a clean, soft cloth dampened in mild soap solution, then wipe clean with a dry, soft cloth.

Regular care and cleaning is required in order to maintain the appearance of the leather.

Before using any fabric protector, read the manufacturer's recommendations. Some fabric protectors contain chemicals that may stain or bleach the seat material.

Use a soft cloth dampened only with water to clean the meter and gauge lens covers.

### CAUTION:

- **Never use benzine, thinner or any similar material.**
- **Small dirt particles can be abrasive and damaging to leather surfaces and should be removed promptly. Do not use saddle soap, car waxes, polishes, oils, cleaning fluids, solvents, detergents or ammonia-based cleaners as they damage the leather natural finish.**
- **Never use fabric protectors unless recommended by the manufacturer.**
- **Do not use glass or plastic cleaner on meter or gauge lens covers. It may damage the lens covers.**
- **Do not use the chlorine-based cleaning liquid such as chlorine dioxide and hypochlorous acid, which may cause the paint peeling, corrosion, etc. If it is unavoidable to clean or sterilize interior surfaces, use less than 75% ethanol. Wipe the interior parts with a dry cloth dampened with ethanol. Wipe off ethanol completely. If**

**you leave it uncleaned, it may cause paint peeling, discoloration, etc. Since ethanol is flammable, be careful of fire.**

## AIR FRESHENERS

Most air fresheners use a solvent that could affect the vehicle interior. If you use an air freshener, take the following precautions:

- Hanging-type air fresheners can cause permanent discoloration when they contact vehicle interior surfaces. Place the air freshener in a location that allows it to hang free and not contact an interior surface.
- Liquid-type air fresheners typically clip on the vents. These products can cause immediate damage and discoloration when spilled on interior surfaces.

Carefully read and follow the manufacturer's instructions before using air fresheners.

## FLOOR MATS

The use of genuine NISSAN floor mats (if equipped) can extend the life of your vehicle carpet and make it easier to clean the interior. Regardless of what mats are used, be sure they are fitted for your vehicle and are properly positioned in the foot well to prevent interference with pedal operation. Mats should be maintained with regular cleaning and replaced if they become excessively worn.

## Floor mat positioning aid

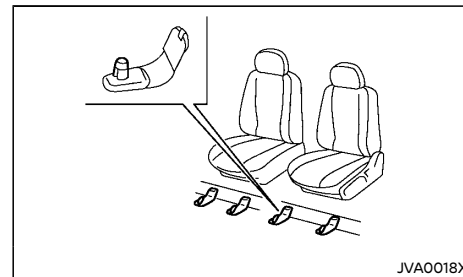

This vehicle includes floor mat brackets to act as a floor mat positioning aid. NISSAN floor mats have been specially designed for your vehicle model.

Position the mat by placing the floor mat bracket hook through the floor mat grommet hole while centering the mat in the foot area.

Periodically check that the mats are properly positioned.

## GLASS

Use glass cleaner to remove smoke and dust film from the glass surfaces. It is normal for glass to become coated with a film after the vehicle is parked in the hot sun. Glass cleaner and a soft cloth will easily remove this film.

### CAUTION:

**When cleaning the inside of the windows, do not use sharp-edged tools, abrasive cleaners or chlorine-based disinfectant cleaners. They could damage the electrical conductors, such as radio antenna elements or rear window defogger elements.**

## CORROSION PROTECTION

### SEAT BELTS



#### WARNING:

- **Do not allow wet seat belts to roll up in the retractor.**
- **Never use bleach, dye or chemical solvents to clean the seat belts, since these materials may severely weaken the seat belt webbing.**

The seat belts can be cleaned by wiping them with a sponge dampened in a mild soap solution.

Allow the belts to dry completely in the shade before using them. (See "Seat belts" (P.1-11).)

### MOST COMMON FACTORS CONTRIBUTING TO VEHICLE CORROSION

- The accumulation of moisture-retaining dirt and debris in body panel sections, cavities, and other areas.
- Damage to the paint surface and other protective coatings caused by gravel and stone chips or minor traffic accidents.

### ENVIRONMENTAL FACTORS INFLUENCE THE RATE OF CORROSION

#### Moisture

The accumulation of sand, dirt and water on the inside floor of the vehicle can accelerate corrosion. Wet floor carpet/floor mats will not dry completely inside the vehicle. They should be removed and completely dried to avoid floor panel corrosion.

#### Relative humidity

Corrosion will be accelerated in areas of high relative humidity.

#### Temperature

High temperatures accelerate the rate of corrosion to those parts which are not well ventilated.

Corrosion will also be accelerated in areas where the temperatures stay above freezing.

#### Air pollution

Industrial pollution, the presence of salt in the air in coastal areas, or heavy road salt use accelerates the corrosion process. Road salt also accelerates the disintegration of paint surfaces.

### TO PROTECT YOUR VEHICLE FROM CORROSION

- Wash and wax your vehicle often to keep the vehicle clean.
- Always check for minor damage to the paint surface and if any exists, repair it as soon as possible.
- Keep the drain holes in the lower edge of the doors open to avoid water accumulation.
- Check the vehicle underbody for accumulation of sand, dirt or salt. If present, wash with water as soon as possible.



#### CAUTION:

- **Never remove dirt, sand or other debris from the passenger compartment by washing it out with a hose. Remove dirt with a vacuum cleaner.**
- **Never allow water or other liquids to come in contact with electronic components inside the vehicle as this may damage them.**

Chemicals used for road surface deicing are extremely corrosive. They accelerate corrosion and deterioration of underbody components such as the exhaust system, fuel and brake lines, brake cables, floor pan and fenders.

**In the winter, the underbody must be cleaned periodically.**

For additional protection against rust and corrosion, which may be required in some areas, consult a NISSAN dealer.

**MEMO**

# 8 Maintenance and do-it-yourself

Maintenance requirements .....	8-3	Brake fluid .....	8-17
Scheduled maintenance .....	8-3	Clutch fluid (if equipped) .....	8-18
General maintenance .....	8-3	Automatic Transmission Fluid (ATF) (if equipped) .....	8-19
Where to go for service .....	8-3	7-speed Automatic Transmission (AT) model .....	8-19
General maintenance .....	8-3	Power steering fluid .....	8-19
Explanation of general maintenance items .....	8-3	Air cleaner filter .....	8-19
Maintenance precautions .....	8-5	Wiper blades .....	8-20
Engine compartment check locations .....	8-6	Windshield wiper blades .....	8-20
YD25DDTi engine .....	8-6	Rear window wiper blade .....	8-21
YS23DDTT engine .....	8-7	Window washer fluid .....	8-21
QR25DE engine .....	8-8	Battery .....	8-22
Engine cooling system .....	8-8	Vehicle battery .....	8-22
Checking engine coolant level .....	8-9	Remote controller battery (if equipped) .....	8-23
Changing engine coolant .....	8-9	Intelligent Key battery (if equipped) .....	8-25
Engine oil .....	8-10	Variable voltage control system (if equipped) .....	8-26
Checking engine oil level .....	8-10	Fuses .....	8-26
Changing engine oil and oil filter .....	8-11	Engine compartment .....	8-26
Protect environment .....	8-14	Passenger compartment .....	8-27
Fuel filter (YD25DDTi engine model) .....	8-14	Lights .....	8-29
Draining water .....	8-14	Headlights .....	8-29
Bleeding the fuel system .....	8-15	Exterior lights .....	8-29
Drive belt .....	8-15	Interior lights .....	8-29
Spark plugs (QR25DE engine model) .....	8-16	Light locations .....	8-30
Iridium-tipped spark plugs .....	8-16	Tires and wheels .....	8-32
Brakes .....	8-16	Tire Pressure Monitoring System (TPMS) (if equipped) .....	8-32
Checking parking brake .....	8-16	Tire inflation pressure .....	8-32
Checking foot brake .....	8-16	Types of tires .....	8-33
Brake booster .....	8-17		

Tire chains .....	8-33
Tire rotation .....	8-34
Tire wear and damage .....	8-34
Tire age .....	8-34

Changing tires and wheels .....	8-34
Wheel balance .....	8-35
Spare tire .....	8-35

## MAINTENANCE REQUIREMENTS

Some day-to-day and regular maintenance is essential to maintain your vehicle's good mechanical condition, as well as its emission and engine performance.

It is the owner's responsibility to make sure that the specified maintenance, as well as general maintenance, is performed.

As the vehicle owner, you are the only one who can ensure that your vehicle receives the proper maintenance care.

### SCHEDULED MAINTENANCE

For your convenience, the required scheduled maintenance items are described and listed in a separate Warranty Information and Maintenance booklet. You must refer to that booklet to ensure that necessary maintenance is performed on your vehicle at regular intervals.

### GENERAL MAINTENANCE

General maintenance includes those items which should be checked during normal day-to-day operation of the vehicle. They are essential if your vehicle is to continue to operate properly. It is your responsibility to perform these procedures regularly as prescribed.

Performing general maintenance checks requires minimal mechanical skill and only a few general automotive tools.

These checks or inspections can be done by yourself, a qualified technician, or if you prefer, your NISSAN dealer.

### WHERE TO GO FOR SERVICE

If maintenance service is required or your vehicle appears to malfunction, have the systems checked and tuned by an authorised NISSAN dealer.

## GENERAL MAINTENANCE

During normal day-to-day operation of the vehicle, general maintenance should be performed regularly as prescribed in this section. If you detect any unusual sounds, vibrations or smells, be sure to check for the cause or have a NISSAN dealer do it promptly. In addition, you should notify a NISSAN dealer if you think that repairs are required.

When performing any checks or maintenance work, closely observe "Maintenance precautions" (P.8-5).

### EXPLANATION OF GENERAL MAINTENANCE ITEMS

**Additional information on the following items with "" is found later in this section.**

#### Outside vehicle

The maintenance items listed here should be performed from time to time, unless otherwise specified.

#### **Doors and hood:**

Check that all doors and the hood operate smoothly as well as the back door, trunk lid and hatch. Also make sure that all latches lock securely. Lubricate if necessary. Make sure that the secondary latch keeps the hood from opening when the primary latch is released. When driving in areas using road salt or other corrosive materials, check lubrication frequently.

#### **Lights\*:**

Clean the headlights on a regular basis. Make sure that the headlights, stop lights, tail lights, turn signal lights, and other lights are all operating properly and installed securely. Also check the aim of the headlights.

**Tires\*:**

Check the pressure with a gauge often and always prior to long distance trips. Adjust the pressure in all tires, including the spare, to the pressure specified. Check carefully for damage, cuts or excessive wear.

**Tire rotation\*:**

In the case that Two-Wheel Drive (2WD) and front and rear tires are same size; tires should be rotated every 10,000 km (6,000 miles). Tires marked with directional indicators can only be rotated between front and rear. Make sure that the directional indicators point in the direction of wheel rotation after the tire rotation is completed.

In the case that Four-Wheel Drive and All Wheel Drive (4WD/AWD) and front and rear tires are same size; tires should be rotated every 5,000 km (3,000 miles). Tires marked with directional indicators can only be rotated between front and rear. Make sure that the directional indicators point in the direction of wheel rotation after the tire rotation is completed.

In the case that front tires are different size from rear tires; tires cannot be rotated.

The timing for tire rotation may vary according to your driving habits and the road surface conditions.

**Tire Pressure Monitoring System (TPMS) transmitter components (if so equipped):**

Replace the TPMS transmitter grommet seal, valve core and cap when the tires are replaced due to wear or age.

**Wheel alignment and balance:**

If the vehicle should pull to either side while driving on a straight and level road, or if you detect uneven or abnormal tire wear, there may be a need for wheel alignment. If the steering wheel or seat vibrates at normal highway speeds, wheel balancing may be needed.

**Windshield:**

Clean the windshield on a regular basis. Check the windshield at least every six months for cracks or other damage. Repair as necessary.

**Wiper blades\*:**

Check for cracks or wear if not functioning correctly. Replace as necessary.

**Inside vehicle**

The maintenance items listed here should be checked on a regular basis, such as when performing periodic maintenance, cleaning the vehicle, etc.

**Accelerator pedal:**

Check the pedal for smooth operation and make sure that the pedal does not catch or require uneven effort. Keep the floor mats away from the pedal.

**Brake pedal\*:**

Check the pedal for smooth operation and make sure that it is the proper distance from the floor mat when depressed fully. Check the brake booster function. Be sure to keep the floor mats away from the pedal.

**Parking brake\*:**

Check the parking brake operation regularly. Check that the lever (if so equipped) or the pedal (if so equipped) has the proper travel. Also make sure that the vehicle is held securely on a fairly steep hill when only the parking brake is applied.

**Seat belts:**

Check that all parts of the seat belt system (for example, buckles, anchors, adjusters and retractors) operate properly and smoothly, and are installed securely. Check the belt webbing for cuts, fraying, wear or damage.

**Steering wheel:**

Check for changes in the steering condition, such as excessive play, hard steering or strange noises.

**Warning lights and chimes:**

Make sure that all warning lights and chimes are operating properly.

**Windshield defogger:**

Check that the air comes out of the defogger outlets properly and in good quantity when operating the heater or air conditioner.

**Windshield wiper and washer\*:**

Check that the wipers and washer operate properly and that the wipers do not streak.

**Under hood and vehicle**

The maintenance items listed here should be checked periodically (for example, each time you check the engine oil or refuel).



### **Battery (except for maintenance free batteries)\*:**

Check the fluid level in each cell. It should be between the UPPER and LOWER lines. Vehicles operated in high temperatures or under severe conditions require frequent checks of the battery fluid level.

### **Brake (and clutch) fluid level(s)\*:**

For Manual Transmission (MT) model; make sure that the brake and clutch fluid levels are between the MAX and MIN lines on the reservoirs.

Except for Manual Transmission (MT) model; make sure that the brake fluid level is between the MAX and MIN lines on the reservoir.

### **Engine coolant level\*:**

Check the coolant level when the engine is cold. Make sure that the coolant level is between the MAX and MIN lines on the reservoir.

### **Engine drive belt(s)\*:**

Make sure that drive belt(s) is not frayed, worn, cracked or oily.

### **Engine oil level\*:**

Check the level after parking the vehicle (on a level ground) and turning off the engine.

### **Fluid leaks:**

Check under the vehicle for fuel, oil, water or other fluid leaks after the vehicle has been parked for a while. Water dripping from the air conditioner after use is normal. If you should notice any leaks or if fuel fumes are evident, check for cause and have it corrected immediately.

### **Power steering fluid level and lines\*:**

Check the level when the fluid is cold with the engine off. Check the lines for proper attachment, leaks, cracks, etc.

### **Windshield washer fluid\*:**

Check that there is adequate fluid in the reservoir.

## **MAINTENANCE PRECAUTIONS**

When performing any inspection or maintenance work on your vehicle, always take care to prevent serious accidental injury to yourself or damage to the vehicle. The following are general precautions which should be closely observed.



### **WARNING:**

- **Park the vehicle on a level surface, apply the parking brake securely and block the wheels to prevent the vehicle from moving.** Move the shift lever to the "P" (Park) position (AT model) or the shift lever to the "N" (Neutral) position (MT model).
- **Be sure the ignition switch is in the "OFF" or "LOCK" position when performing any parts replacement or repairs.**
- **Do not work under the hood while the engine is hot. Always turn off the engine and wait until it cools down.**
- **If you must work with the engine running, keep your hands, clothing, hair and tools away from moving fans, belts and any other moving parts.**
- **It is advisable to secure or remove any loose clothing and any jewelry, such as rings, watches, etc. before working on your vehicle.**

- **If you must run the engine in an enclosed space such as a garage, be sure there is proper ventilation for exhaust gases to escape.**
- **Never get under the vehicle while it is supported by a jack.**
- **Keep smoking materials, flame and sparks away from fuel and the battery.**
- **Never connect or disconnect either the battery or any transistorized component connector while the ignition switch is in the "ON" position.**
- **On gasoline engine models with the Multiport Fuel Injection (MFI) system, the fuel filter and fuel lines should be serviced by a NISSAN dealer because the fuel lines are under high pressure even when the engine is turned off.**
- **Your vehicle is equipped with an automatic engine cooling fan. It may come on at any time without warning, even if the ignition switch is in the "OFF" position and the engine is not running. To avoid injury, always disconnect the negative battery cable before working near the fan.**
- **Always wear eye protection whenever you work on your vehicle.**
- **Never leave the engine or the transmission related component harness connector disconnected while the ignition switch is in the "ON" position.**
- **Avoid direct contact with used engine oil and coolant. Improperly disposed engine oil, engine coolant, and/or other vehicle fluids can hurt the environment. Always conform to local regulations for disposal of vehicle fluids.**

This "8. Maintenance and do-it-yourself" section

## ENGINE COMPARTMENT CHECK LOCATIONS

provides instructions regarding only those items which are relatively easy for an owner to perform.

You should be aware that incomplete or improper servicing may result in operating difficulties or excessive emissions, and could affect your warranty coverage. **If in doubt about any servicing, have it done by a NISSAN dealer.**

### YD25DDTi ENGINE

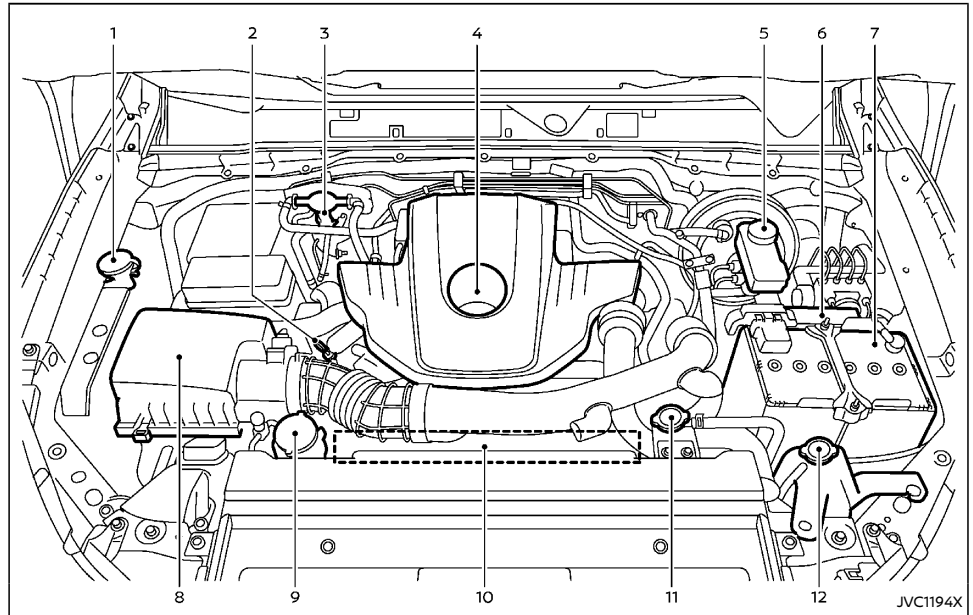

- |   |  |
|---|--|
| 1. Window washer fluid reservoir        | 8. Air cleaner   |
| 2. Engine oil dipstick                  | 9. Power steering fluid reservoir  |
| 3. Priming valve                        | 10. Engine drive belt location   |
| 4. Engine oil filler cap                | 11. Radiator filler cap  |
| 5. Brake and clutch*1 fluid reservoir*2 | 12. Engine coolant reservoir   |
| 6. Fuse/fusible link holder             | *1: For Manual Transmission (MT) model   |
| 7. Battery                              | *2: The layout illustrated is for the Left-Hand Drive (LHD) model. On the Right-Hand Drive (RHD) model, brake (and clutch) fluid |

reservoir is located on the opposite side.

### YS23DDTT ENGINE

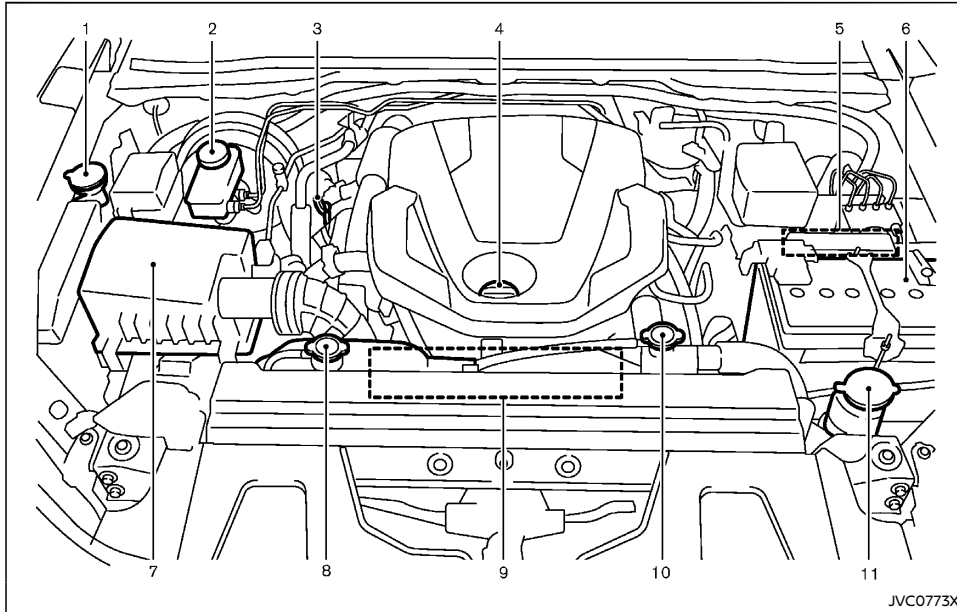

- |                                  |                                    |
|----------------------------------|------------------------------------|
| 1. Window washer fluid reservoir | 8. Engine coolant reservoir        |
| 2. Brake fluid reservoir         | 9. Engine drive belt location      |
| 3. Engine oil dipstick           | 10. Radiator filler cap            |
| 4. Engine oil filler cap         | 11. Power steering fluid reservoir |
| 5. Fuse/fusible link holder      |                                    |
| 6. Battery                       |                                    |
| 7. Air cleaner                   |                                    |

## ENGINE COOLING SYSTEM

### QR25DE ENGINE

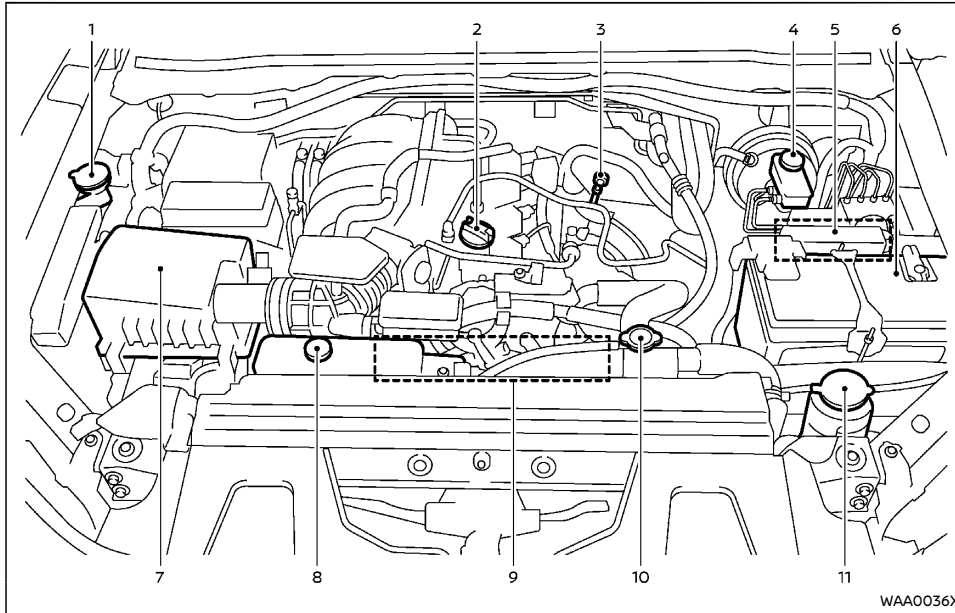

1. Window washer fluid reservoir
2. Engine oil filler cap
3. Engine oil dipstick
4. Brake and clutch\*1 fluid reservoir\*2
5. Fuse/fusible link holder
6. Battery
7. Air cleaner
8. Engine coolant reservoir

9. Engine drive belt location
  10. Radiator filler cap
  11. Power steering fluid reservoir
- \*1: For Manual Transmission (MT) model  
\*2: The layout illustrated is for the Left-Hand Drive (LHD) model. On the Right-Hand Drive (RHD) model, brake (and clutch) fluid reservoir is located on the opposite side.



#### WARNING:

- Never remove the radiator or coolant reservoir cap when the engine is hot. Serious burns could be caused by high-pressure fluid escaping from the radiator. Wait until the engine and radiator cool down.
- Engine coolant is poisonous and should be stored carefully in marked containers out of the reach of children.

The engine cooling system is filled at the factory with a high-quality, year-round, anti-freeze coolant solution. The anti-freeze solution contains rust and corrosion inhibitors, therefore additional cooling system additives are not necessary.



#### CAUTION:

- Never use any cooling system additives such as radiator sealer. Additives may clog the cooling system and cause damage to the engine, transmission and/or cooling system.
- When adding or replacing coolant, be sure to use only Genuine NISSAN Engine Coolant or equivalent in its quality with the proper mixture ratio. Examples of the mixture ratio of coolant and water are shown in the following table:

### For YD25DDTi and QR25DE engine models

Outside temperature down to		Engine coolant (concentrated)	Demineralized or distilled water
°C	°F		
-15	5	30%	70%
-35	-30	50%	50%

### For YS23DDTT engine model

Outside temperature down to		Engine coolant (concentrated)	Demineralized or distilled water
°C	°F		
-35	-30	50%	50%

Use Genuine NISSAN Engine Coolant or equivalent in its quality. Genuine NISSAN Engine Coolant is a pre-mixed (mixture ratio 50%) type coolant.

The use of other types of coolant solutions may damage the engine cooling system.

The radiator is equipped with a pressure cap. To prevent engine damage, use only a Genuine NISSAN radiator cap or its equivalent when replacement is required.

### CHECKING ENGINE COOLANT LEVEL

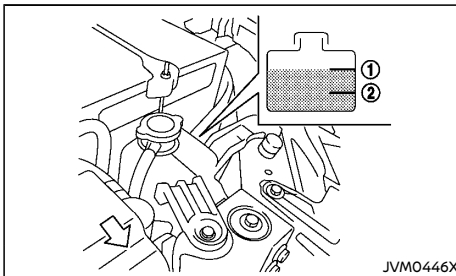

YD25DDTi engine

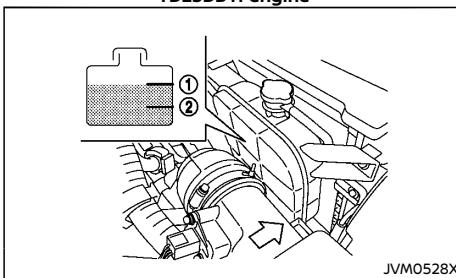

YS23DDTT engine

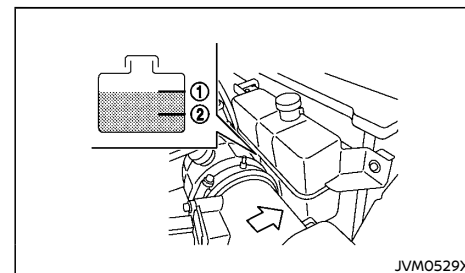

QR25DE engine

Check the coolant level in the reservoir when the engine is cold. If the coolant level is below the MIN level ②, add coolant up to the MAX level ①. If the reservoir is empty, check the coolant level in the radiator **when the engine is cold**. If there is insufficient coolant in the radiator, fill the radiator with coolant up to the filler opening and also add it to the reservoir up to the MAX level ①. Tighten the cap securely after adding engine coolant.

**If the cooling system frequently requires coolant, have it checked by a NISSAN dealer.**

### CHANGING ENGINE COOLANT

Contact a NISSAN dealer if replacement is required.

Major engine cooling system repair should be performed by a NISSAN dealer. The service procedures can be found in the appropriate NISSAN Service Manual.

Improper servicing can result in reduced heater performance and engine overheating.

## ENGINE OIL



### WARNING:

- To avoid being scalded, never change the coolant when the engine is hot.
- Never remove the radiator or coolant reservoir cap when the engine is hot. Serious burns could be caused by high pressure fluid escaping from the radiator.
- Avoid direct skin contact with used coolant. If skin contact is made, wash thoroughly with soap or hand cleaner as soon as possible.
- Keep coolant out of reach of children and pets.

Engine coolant must be disposed of properly. Check your local regulations.

### CHECKING ENGINE OIL LEVEL

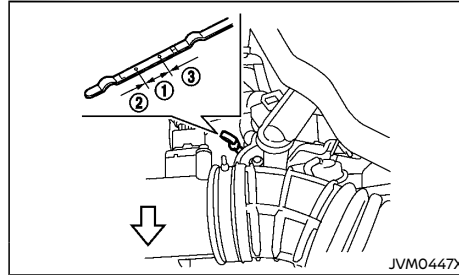

YD2DDTi engine

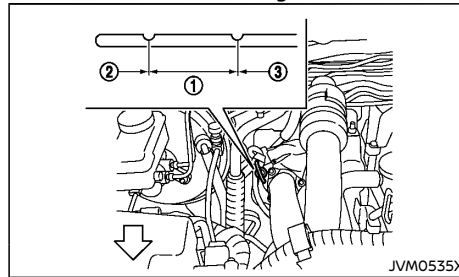

YS23DDTT engine

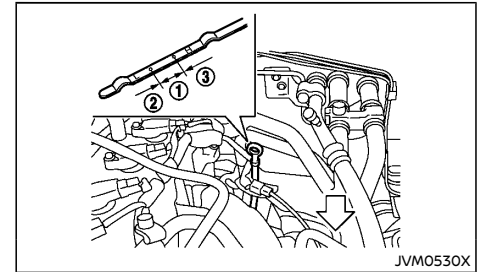

QR25DE engine

1. Park the vehicle on a level surface and apply the parking brake.
2. Start the engine and warm it up until the engine temperature reaches the normal operating temperature (approximately 5 minutes).
3. Stop the engine.
4. Wait at least 10 minutes for the engine oil to drain back to the oil pan.
5. Remove the dipstick and wipe it clean.
6. Reinsert the dipstick all the way.
7. Remove the dipstick and check the oil level. It should be within the range ①.
8. If the oil level is below ②, remove the oil filler cap and pour the recommended oil into the opening. Do not overfill ③.  
When filling the engine oil, do not remove the dipstick.
9. Recheck the oil level with the dipstick.



### CAUTION:

- The oil level should be checked regularly. Operating your vehicle with an insufficient amount of oil can damage the

engine, and such damage is not covered by the warranty.

- It is normal to add some oil between oil maintenance intervals or during the break-in period, depending on the severity of operating conditions.

## CHANGING ENGINE OIL AND OIL FILTER

### WARNING:

- Used oil must be disposed of properly. Never pour or dump oil into the ground, canals, rivers, etc. It should be disposed of at proper waste facilities. NISSAN recommends having your oil changed by a NISSAN dealer.
- Be careful not to burn yourself, as the engine oil may be hot.
- Prolonged and repeated contact with used engine oil may cause skin cancer.
- Avoid direct skin contact with used oil. If contacted, wash thoroughly with soap or hand cleaner and plenty of water as soon as possible.
- Store used engine oil in marked containers out of the reach of children.

### Vehicle set-up

1. Park the vehicle on a level surface and apply the parking brake.
2. Start the engine and warm it up until the engine temperature reaches the normal operating temperature (approximately 5 minutes).
3. Stop the engine.
4. Wait at least 10 minutes for the engine oil to drain back to the oil pan.

## Engine oil and filter

For QR25DE and YD25DDTi engine models:

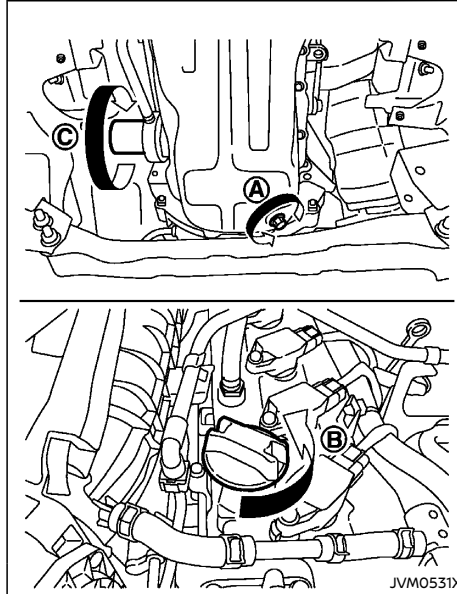

QR25DE engine (2WD) model

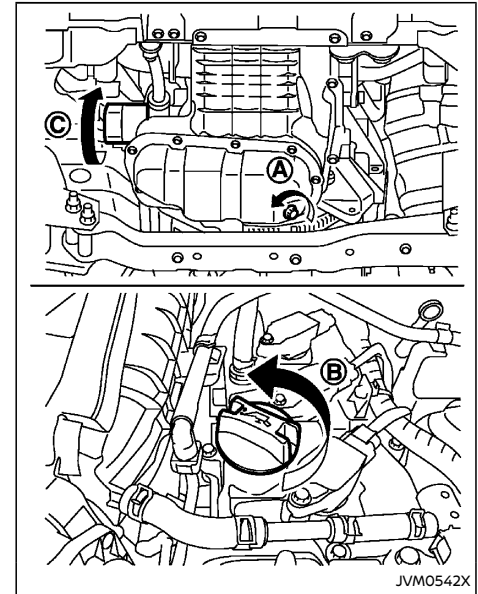

QR25DE engine (4WD) model

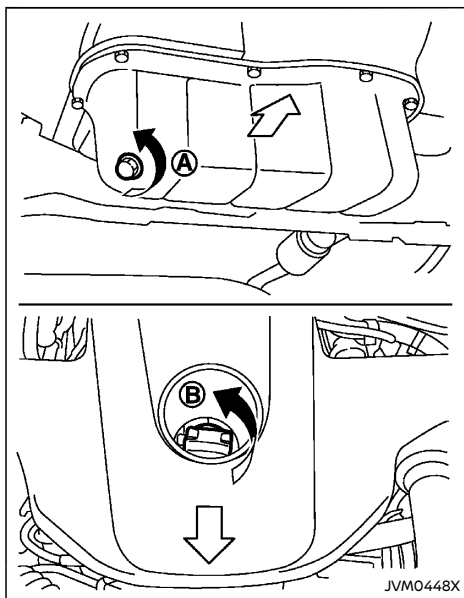

YD25DDTi engine model

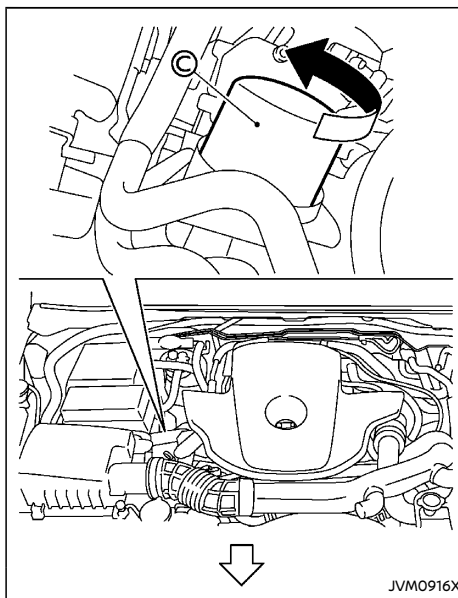

YD25DDTi engine model

1. Place a large drain pan under the drain plug **(A)**.
2. Remove the drain plug with a wrench.
3. Remove the oil filler cap **(B)** and completely drain the oil.



**CAUTION:**

**Waste oil must be disposed of properly. Check your local regulations.**

4. (Perform steps 4 to 8 only when the engine oil filter change is needed.)  
Loosen the oil filter **(C)** with an oil filter wrench.
5. Remove the oil filter by turning it by hand.
6. Wipe the engine oil filter mounting surface with a clean cloth.  
**Be sure to remove any old gasket remaining on the mounting surface.**
7. Apply new engine oil to the gasket of a new oil filter.
8. Screw in the oil filter clockwise until a slight resistance is felt, and then tighten an additional 2/3 of a turn to secure the oil filter.

**Oil filter tightening torque:**

**YD25DDTi engine**

**16 to 20 N·m**

**(1.6 to 2.0 kg·m, 12 to 15 ft·lb)**

**QR25DE engine**

**15 to 20 N·m**

**(1.5 to 2.0 kg·m, 11 to 15 ft·lb)**

9. Clean and reinstall the drain plug and new washer. Securely tighten the drain plug with a wrench. Do not use excessive force.  
**Drain plug tightening torque:**  
**29 to 39 N·m**  
**(3.0 to 4.0 kg·m, 22 to 29 ft·lb)**
10. Sufficiently refill with the recommended engine oil. (See "Recommended fluids/lubricants and capacities" (P.9-2).)
11. Securely install the oil filler cap.
12. Start the engine.
13. Check the drain plug and the oil filter for any sign of leakage. Correct as required.



14. Stop the engine.
15. Wait at least 10 minutes. Check the engine oil level according to the proper procedure. (See "Checking engine oil level" (P.8-10).) Add engine oil if necessary.

**For YS23DDTT engine model:**

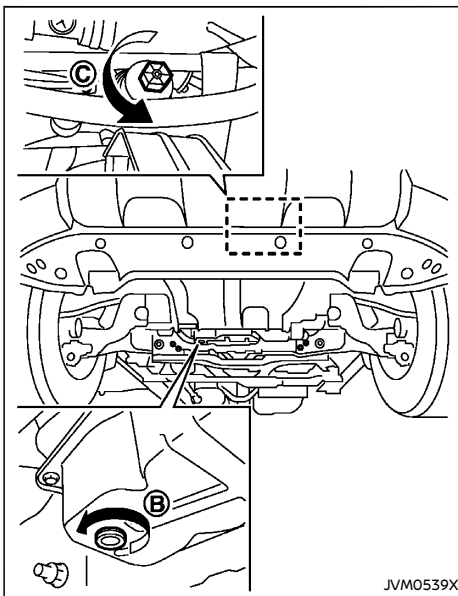
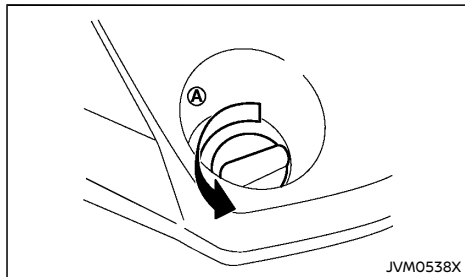

- Ⓐ Oil filler cap
- Ⓑ Oil drain plug
- Ⓒ Oil filter

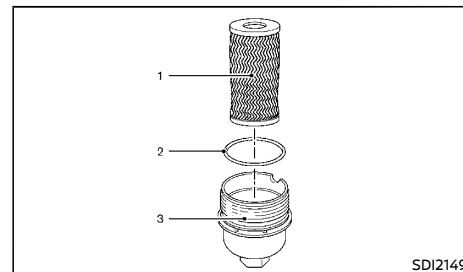

- 1 Oil filter element
  - 2 O-ring (mounted on the cover)
  - 3 Oil filter cover/cap
1. Place a large drain pan under the drain plug Ⓑ.
  2. Remove the drain plug with a wrench.
  3. Remove the oil filler cap Ⓐ and completely drain the oil.
- If the oil filter is to be changed, remove and replace it at this time.



**CAUTION:**

**Waste oil must be disposed of properly. Check your local regulations.**

4. Remove the front spoiler and the engine under cover.
5. Loosen the oil filter cover Ⓒ with a wrench.
6. Remove the oil filter cover then the oil filter element.
7. Remove the rubber O-ring from the filter cover.
8. Wipe the entire oil filter cover with a clean cloth.

**Be sure to remove any old O-ring remaining on the mounting surface.**

9. Apply new engine oil to the O-ring.  
Install the new O-ring on the oil filter cap.
10. Insert the oil filter element into the engine oil filter cover.
11. Screw in the oil filter cover until a slight resistance is felt, and then tighten the filter completely.

**Oil filter cover tightening torque:**

**25 N·m  
(2.6 kg-m, 18 ft-lb)**

12. Clean and reinstall the drain plug and new washer. Securely tighten the drain plug with a wrench. Do not use excessive force.

**Drain plug tightening torque:**

**50 N·m  
(5.1 kg-m, 36.9 ft-lb)**

13. Refill the recommended engine oil and quantity. (See "Recommended fluids/lubricants and capacities" (P.9-2).)
14. Securely install the oil filler cap.
15. Start the engine.
16. Check the drain plug for any sign of leakage.
17. Dispose of the used oil in the proper manner. Check your local regulations.
18. Check the engine oil level according to the proper procedure. (See "Checking engine oil level" (P.8-10).)
19. Reinstall the engine under cover and the front spoiler.

## After operation

Dispose of waste oil and filter properly. Check your local regulations.

## PROTECT ENVIRONMENT

It is illegal to pollute drains, watercourses and soil. Use authorized waste collection facilities, including civil amenity sites and garages providing facilities for disposal of used oil and used oil filters. If in doubt, contact your local authority for advice on disposal.

**The regulations concerning the pollution of the environment will vary from country to country.**

## FUEL FILTER (YD25DDTi engine model)

### DRAINING WATER

If the water-in-fuel warning light "  " comes on while the engine is running, drain water in the fuel filter as follows:

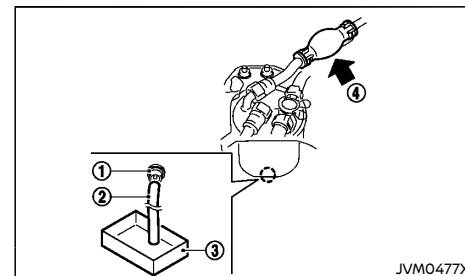

1. Connect a suitable drain hose (2) to the drain plug (1).
2. Place a drain pan (3) under the hose (2).
3. Loosen manually the drain plug (1) with 4 to 5 turns and operate the priming valve (4) to drain the water out of the fuel filter.
4. After draining, close the drain plug manually.



### CAUTION:

- **If the drain plug is tightened excessively, it can be damaged and as a result, fuel will leak.**
  - **Do not use tools to tighten the drain plug.**
5. Bleed air from the fuel system. For details, see "Bleeding the fuel system" (P.8-15).
  6. Start the engine and make sure there is no fuel leakage. Correct as required.

## BLEEDING THE FUEL SYSTEM

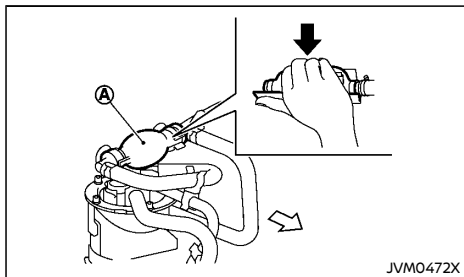

JVM0472X

Bleed the air out of the fuel system after refilling an empty fuel tank by the following procedure:

1. Operate the priming valve **A** several times until there is a sudden resistance felt in the pressure, then stop.
2. Crank the engine until the engine starts.



### CAUTION:

**Do not crank the engine for more than 30 seconds.**

### NOTE:

- If the engine does not start, stop cranking and repeat step 1 of the procedure.
- If the engine does not operate smoothly after it has started, race it two or three times.

## DRIVE BELT

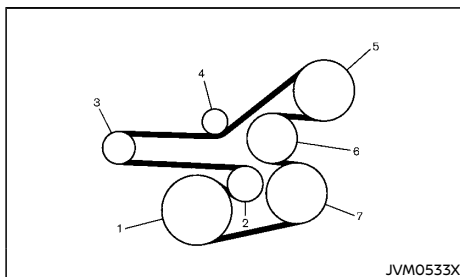

JVM0533X

### QR25DE engine

1. Crankshaft pulley
2. Automatic tensioner
3. Alternator
4. Idler pulley
5. Power steering fluid pump
6. Water pump
7. Air conditioner compressor

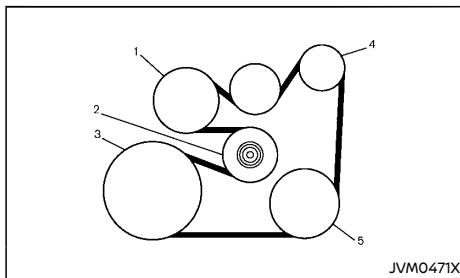

JVM0471X

### YD25DDTi engine

1. Water pump
2. Automatic tensioner
3. Crankshaft pulley
4. Alternator

## 5. Air conditioner compressor

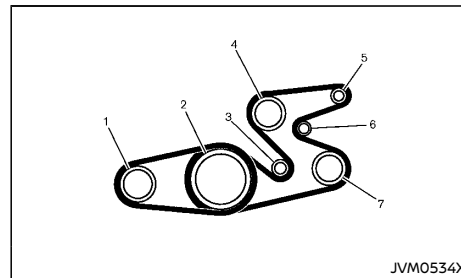

JVM0534X

### YS23DDTT engine

1. Air conditioner compressor
2. Crankshaft pulley
3. Idler pulley
4. Water pump
5. Alternator
6. Automatic tensioner
7. Power steering fluid pump

Be sure the ignition switch is in the "LOCK" position.

Visually inspect the belt for signs of unusual wear, cuts, fraying or looseness. Check the condition regularly. If the belt is in poor condition or loose, have it replaced or adjusted by a NISSAN dealer.

## SPARK PLUGS (QR25DE engine model)



### WARNING:

Be sure the engine and ignition switch are off and that the parking brake is applied.

Replace the spark plugs according to the maintenance schedule log in a separate maintenance booklet.

If replacement is required, contact a NISSAN dealer.

### IRIDIUM-TIPPED SPARK PLUGS

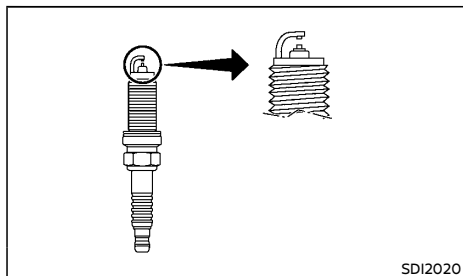

It is not necessary to replace the iridium-tipped spark plugs as frequently as the conventional type of spark plugs. These spark plugs are designed to last much longer than the conventional type of spark plug.



### CAUTION:

- Do not reuse the iridium-tipped spark plugs by cleaning or re-gapping.
- Always replace with the recommended iridium-tipped spark plugs.

## BRAKES

### CHECKING PARKING BRAKE

#### Lever type

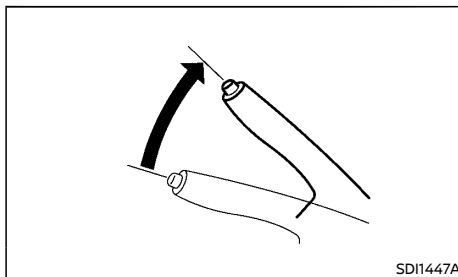

From the released position, pull the parking brake lever slowly and firmly. If the number of clicks is out of the range listed, see a NISSAN dealer.

**8 to 9 clicks under a pulling force of 196 N (20 kg, 44 lb)**

#### Switch type

Periodically check the holding ability of the parking brake by parking on a steep hill and restraining the vehicle by using only the parking brake. If it does not hold satisfactorily, see a NISSAN dealer.

### CHECKING FOOT BRAKE

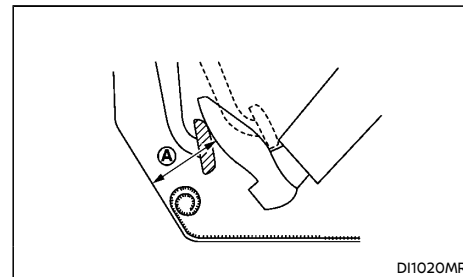

### WARNING:

See a NISSAN dealer for a brake system check if the brake pedal height does not return to normal.

With the engine running, check the distance between the upper surface of the pedal and the metal floor. If it is out the range listed, see a NISSAN dealer.

**Depressing force  
490 N (50 kg, 110 lb)**

LHD model	RHD model
Ⓐ: 96 mm (3.8 in) or more*1	Ⓐ: 86 mm (3.4 in) or more*1
Ⓑ: 79 mm (3.1 in) or more*2	Ⓐ: 69 mm (2.7 in) or more*2

\*1: For lever type

\*2: For switch type

## Brake pad wear warning

The disc brake pads have audible wear warnings. When a brake pad requires replacement, it will make a high pitched scraping sound when the vehicle is in motion. This scraping sound will first occur only when the brake pedal is depressed. After more wear of the brake pad, the sound will always be heard even if the brake pedal is not depressed. Have the brakes checked as soon as possible if the wear warning sound is heard.

Under some driving or climate conditions, occasional brake squeaks, squeals or other noises may be heard. Occasional brake noise during light to moderate stops is normal and does not affect the function or performance of the brake system.

The rear drum brakes do not have audible wear indicators. Should you ever hear an unusually loud noise from the rear drum brakes, have them checked as soon as possible by a NISSAN dealer.

Proper brake inspection intervals should be followed. For additional information, see a separate maintenance booklet.

## BRAKE BOOSTER

Check the brake booster function as follows:

1. With the engine off, depress and release the foot brake pedal several times. When the brake pedal movement (distance of travel) remains the same from one pedal application to the next, continue on to the next step.
2. While depressing the foot brake pedal, start the engine. The pedal height should drop a little.

3. With the foot brake pedal depressed, stop the engine. Keep the pedal depressed for about 30 seconds. The pedal height should not change.
4. Run the engine for 1 minute without depressing the foot brake pedal, then turn it off. Depress the foot brake pedal several times. The pedal travel distance will decrease gradually with each depression as the vacuum is released from the booster.

If the brakes do not operate properly, have the brakes checked by a NISSAN dealer.

## BRAKE FLUID



### WARNING:

- Use only new fluid from a sealed container. Old, inferior, or contaminated fluid may damage the brake system. The use of improper fluids can damage the brake system and affect the vehicle's stopping ability.
- Clean the filler cap before removing.
- Brake fluid is poisonous and should be stored carefully in marked containers out of the reach of children.



### CAUTION:

- Refilling and checking the brake system should be left to a NISSAN dealer who will have the necessary brake fluid and technical knowledge.
- Do not spill the fluid on painted surfaces. This will damage the paint. If fluid is spilled, wash with water.

See "Recommended fluids/lubricants and capacities" (P.9-2) for recommended types of fluid.

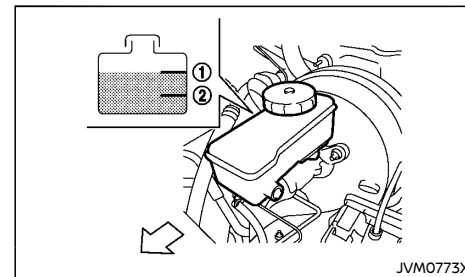

Automatic Transmission (AT) model

## CLUTCH FLUID (if equipped)

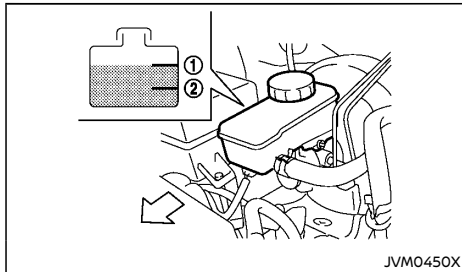

### Manual Transmission (MT) model

Check the fluid level in the reservoir. If the fluid is below the MIN line ②, the brake warning light (red) will illuminate. Add fluid up to the MAX line ①.

If fluid must be added frequently, the system should be thoroughly checked by your NISSAN dealer.



### WARNING:

- Use only new fluid from a sealed container. Old, inferior, or contaminated fluid may damage the clutch system.
- Clean the filler cap before removing.
- Clutch fluid is poisonous and should be stored carefully in marked containers out of the reach of children.



### CAUTION:

- Refilling and checking the clutch system should be left to a NISSAN dealer who will have the necessary clutch fluid and technical knowledge.
- Do not spill the fluid on painted surfaces. This will damage the paint. If fluid is spilled, wash with water.

NISSAN dealer.

See "Recommended fluids/lubricants and capacities" (P.9-2) for recommended types of fluid.

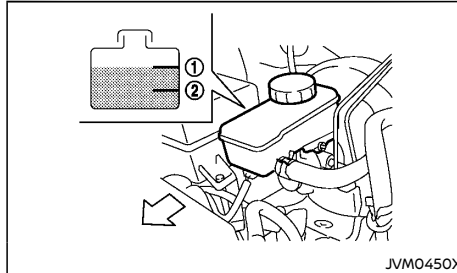

Check the fluid level in the reservoir. If the fluid is below the MIN line ②, add fluid up to the MAX line ①.

If the fluid must be added frequently, the clutch system should be thoroughly checked by a

## AUTOMATIC TRANSMISSION FLUID (ATF) (if equipped)

### 7-SPEED AUTOMATIC TRANSMISSION (AT) MODEL

Contact a NISSAN dealer if checking or replacement is required.

#### CAUTION:

- Use only Genuine NISSAN Matic S ATF. Do not mix with other fluids.
- Using Automatic Transmission Fluid (ATF) other than Genuine NISSAN Matic S ATF will cause deterioration in driveability and automatic transmission durability, and may damage the automatic transmission, which is not covered by the warranty.

## POWER STEERING FLUID

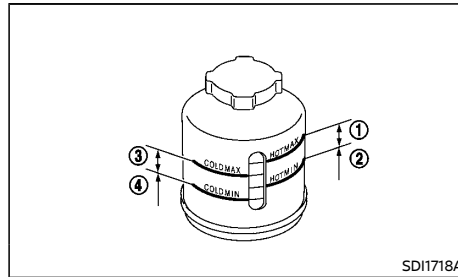

#### WARNING:

Power steering fluid is poisonous and should be stored carefully in marked containers out of the reach of children.

Check the fluid level in the reservoir. The fluid level should be checked in the HOT range (①: HOT MAX., ②: HOT MIN.) at fluid temperatures of 50 to 80°C (122 to 176°F) or in the COLD range (③: COLD MAX., ④: COLD MIN.) at fluid temperatures of 0 to 30°C (32 to 86°F).

If it is necessary to add fluid, use only specified fluid. **Do not overfill.** (See "Recommended fluids/lubricants and capacities" (P.9-2) for recommended types of fluid.)

## AIR CLEANER FILTER

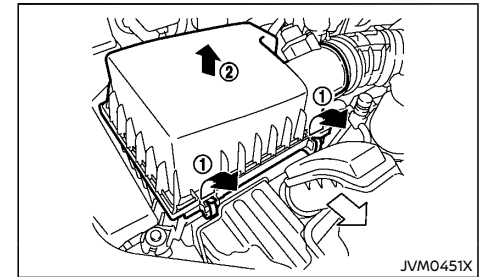

#### WARNING:

- Operating the engine with the air cleaner filter off can cause you or others to be burned. The air cleaner filter not only cleans the intake air, it also stops flame if the engine backfires. If the air cleaner filter is not installed and the engine backfires, you could be burned. Never drive with the air cleaner filter off. Be cautious working on the engine when the air cleaner filter is off.
- Never pour fuel into the throttle body or attempt to start the engine with the air cleaner removed. Doing so could result in serious injury.

To remove the filter, release the lock pins ① and pull the unit upward ②.

The dry paper type filter element may be cleaned and reused. Replace the air filter according to the maintenance schedule shown in a separate maintenance booklet.

When replacing the filter, wipe the inside of the air cleaner housing and the cover with a damp cloth.

## WIPER BLADES

### WINDSHIELD WIPER BLADES

#### Cleaning

If the windshield does not become clear after using the windshield washer or if the wiper blades chatter when operating the windshield wipers, wax or other materials may be on the windshield and/or wiper blades.

Clean the outside of the windshield surface with a washer solution or mild detergent. Your windshield is clean if beads do not form when rinsing with water.

Clean the blade by wiping it with a cloth soaked in a washer solution or a mild detergent. Rinse the blade with water. If your windshield is still not clear after cleaning the blades and using the wipers, replace the blades.

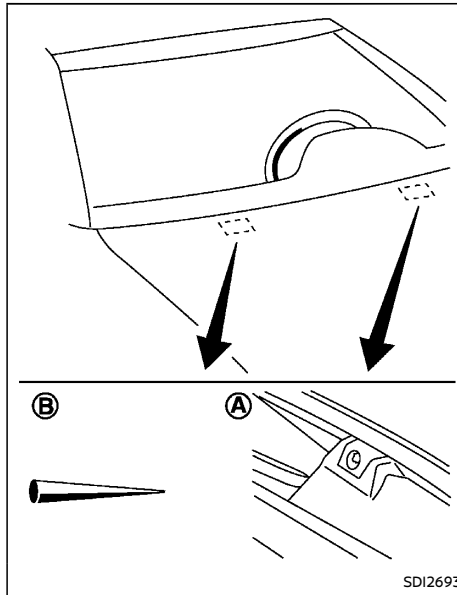

Be careful not to clog the washer nozzle (A). This may cause improper windshield washer operation. If the nozzle is clogged, remove any objects with a needle or small pin (B). Be careful not to damage the nozzle.



## Replacing

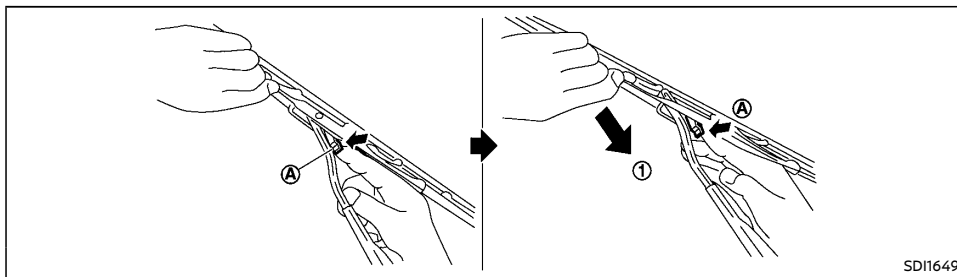

Replace the wiper blades if they are worn.

1. Pull the wiper arm.
2. Push and hold the release tab (A), and then move the wiper blade down (1) the wiper arm to remove.
3. Remove the wiper blade.
4. Insert the new wiper blade onto the wiper arm until it clicks into place.



### CAUTION:

- After wiper blade replacement, return the wiper arm to its original position. Otherwise the wiper arm or the engine hood may be scratched and may cause damage.
- Worn windshield wiper blades can damage the windshield and impair driver vision.

## REAR WINDOW WIPER BLADE

Contact a NISSAN dealer if checking or replacement is required.

## WINDOW WASHER FLUID

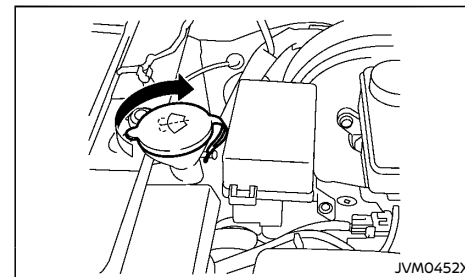







### WARNING:

**Anti-freeze is poisonous and should be stored carefully in marked containers out of the reach of children.**

Check the fluid level in the reservoir tank and add fluid if necessary.

Add a washer solvent to the water for better cleaning. In the winter season, add windshield washer antifreeze. Follow the manufacturer's instructions for the mixture ratio.

## BATTERY

Caution symbols for battery			⚠ WARNING
①		No smoking, No exposed flames, No sparks	Never smoke around battery. Never expose battery to open flames or electrical sparks.
②		Shield eyes	Handle the battery cautiously. Always wear eye protection glasses to protect against explosion or battery acid.
③		Keep away from children	Never allow children to handle battery. Keep the battery out of the reach of children.
④		Battery acid	Do not allow battery fluid to contact your skin, eyes, fabrics, or painted surfaces. After handling the battery or battery cap, immediately wash your hands thoroughly. If the battery fluid gets into your eyes, or onto your skin or clothing, flush with water immediately for at least 15 minutes and seek medical attention. Battery fluid is acid. If the battery fluid gets into your eyes or onto your skin, it could cause loss of your eyesight or burns.
⑤		Note operating instructions	Before handling the battery, read this instruction carefully to ensure correct and safe handling.
⑥		Explosive gas	Hydrogen gas, generated by battery fluid, is explosive.

SDI1573

## VEHICLE BATTERY



### WARNING:

**Do not operate the vehicle if the fluid in the battery is low. Low battery fluid can cause a higher load on the battery which can generate heat, reduce battery life, and in some cases lead to an explosion.**

## Checking battery fluid level

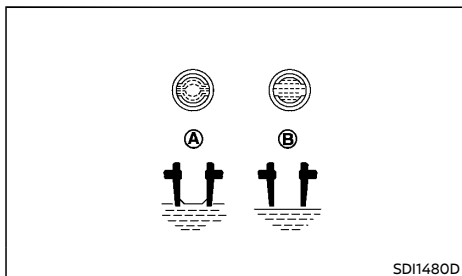
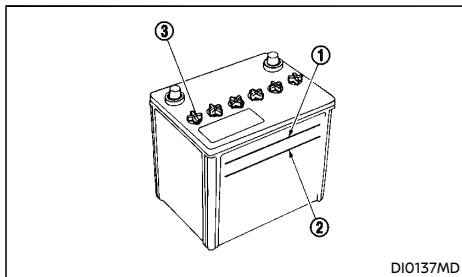

Check the fluid level in each cell. The battery fluid level should be between the UPPER LEVEL ① and LOWER LEVEL ② lines.

If it is necessary to add fluid, add only demineralized/distilled water to bring the level to the indicator in each filler opening. Do not overfill.

1. Remove the cell plugs ③ using a suitable tool.
2. Add demineralized/distilled water up to the UPPER LEVEL ① line.

If the side of the battery is not clear, check the distilled water level by looking directly

above the cell; the condition ④ indicates OK and the condition ⑤ needs more to be added.

3. Replace and tighten the cell plugs.
- Vehicles operated in high temperatures or under severe conditions require frequent checks of the battery fluid level.
  - Keep the battery surface clean and dry. Any corrosion should be cleared with a firmly wrung out moist cloth.
  - Make certain the terminal connections are clean and securely tightened.
  - If the vehicle is not to be used for more than 30 days, disconnect the negative (-) battery terminal cable to prevent battery discharge.

## Jump starting

If jump starting is necessary, see "Jump starting" (P.6-7). If the engine does not start by jump starting or the battery does not charge, the battery may have to be replaced. Contact a NISSAN dealer for replacing the battery.

## REMOTE CONTROLLER BATTERY (if equipped)

### Battery replacement



#### WARNING:

**Do not ingest the battery, Chemical Burn Hazard**

**(The remote control supplied with) This product contains a coin button cell battery. If the coin/button cell battery is swallowed, it can cause severe internal burns in just 2 hours and can lead to death.**

**Keep new and used batteries away from children. If the battery compartment does not close securely, stop using the product and keep it away from children.**

**If you think batteries might have been swallowed or placed inside any part of the body, seek immediate medical attention.**



#### CAUTION:

- Be careful not to allow children to swallow the battery and removed parts.
- An improperly disposed battery can harm the environment. Always confirm local regulations for battery disposal.
- When changing batteries, do not let dust or oil get on the components.
- Danger of explosion if battery is incorrectly replaced. Replace only with the same or equivalent type.
- Do not exposed to excessive heat such as sunshine, fire or the like, that can result in an explosion or the leakage of flammable liquid or gas during use, storage or

transportation.

- Do not dispose of a battery into fire or a hot oven, or give mechanically crushing or cutting of a battery, that can result in an explosion.
- Do not subjected to extremely low air pressure at high altitude that may result in an explosion or the leakage of flammable liquid or gas.



This symbol is intended to alert the user to the presence of important operating and maintenance (servicing) instructions in the literature accompanying the appliance.

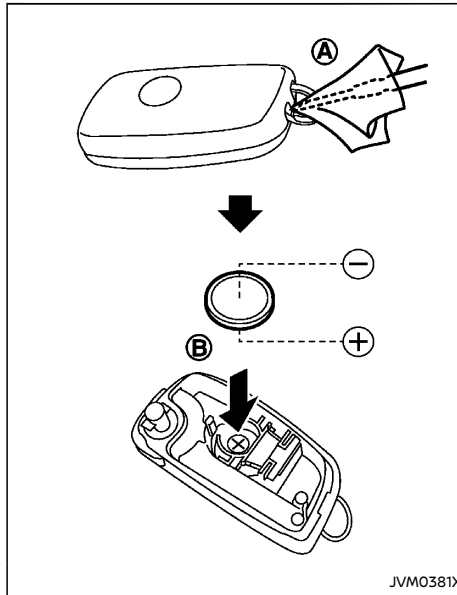

To replace the battery:

1. Insert a small screwdriver into the slit **A** to open the lid. Use a cloth to protect the casing.
2. Replace the battery with a new one.  
Recommended battery: CR2032 or equivalent
  - Do not touch the internal circuit and electric terminals as doing so could cause a malfunction.

- Make sure that the  $\oplus$  side faces the bottom of the case **B**.

3. Close the lid securely.
4. Operate the buttons to check its operation. See a NISSAN dealer if you need assistance for replacement.

**FCC Notice:**

**This device complies with Part 15 of the FCC Rules. Operation is subject to the following two conditions: (1) this device may not cause harmful interference, and (2) this device must accept any interference received, including interference that may cause undesired operation.**

**FCC CAUTION:**

**Changes or modifications not expressly approved by the party responsible for compliance could void the user's authority to operate the equipment.**

## INTELLIGENT KEY BATTERY (if equipped)

### Battery replacement



#### WARNING:

Do not ingest the battery, Chemical Burn Hazard

(The remote control supplied with) This product contains a coin button cell battery. If the coin/button cell battery is swallowed, it can cause severe internal burns in just 2 hours and can lead to death.

Keep new and used batteries away from children. If the battery compartment does not close securely, stop using the product and keep it away from children.

If you think batteries might have been swallowed or placed inside any part of the body, seek immediate medical attention.



#### CAUTION:

- Be careful not to allow children to swallow the battery and removed parts.
- An improperly disposed battery can harm the environment. Always confirm local regulations for battery disposal.
- When changing batteries, do not let dust or oil get on the components.
- Danger of explosion if battery is incorrectly replaced. Replace only with the same or equivalent type.
- Do not exposed to excessive heat such as sunshine, fire or the like, that can result in an explosion or the leakage of flammable liquid or gas during use, storage or transportation.

- Do not dispose of a battery into fire or a hot oven, or give mechanically crushing or cutting of a battery, that can result in an explosion.
- Do not subjected to extremely low air pressure at high altitude that may result in an explosion or the leakage of flammable liquid or gas.



This symbol is intended to alert the user to the presence of important operating and maintenance (servicing) instructions in the literature accompanying the appliance.

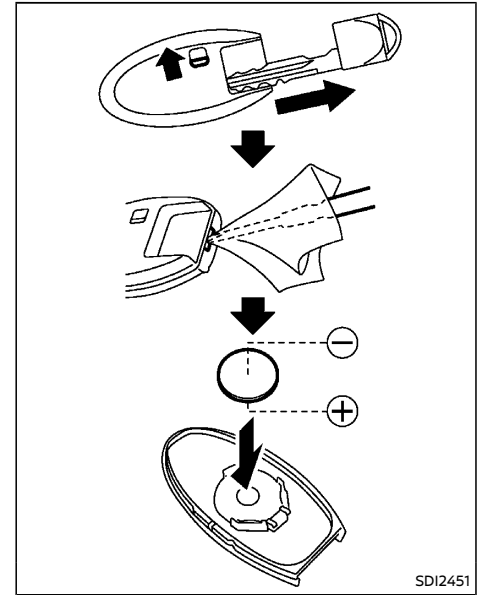

SDI2451

To replace the battery:

1. Release the lock knob at the back of the Intelligent Key and remove the mechanical key.
2. Insert a small screwdriver into the slit of the corner and twist it to separate the upper part from the lower part. Use a cloth to protect the casing.
3. Replace the battery with a new one.
  - Recommended battery: CR2032 or equivalent

- Do not touch the internal circuit and electric terminals as doing so could cause a malfunction.
- Make sure that the ⊕ side faces the bottom of the case.

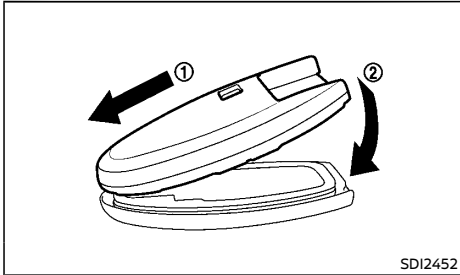

4. Align the tips of the upper and lower parts ①, and then push them together until it is securely closed ②.
5. Operate the buttons to check its operation. See a NISSAN dealer if you need assistance for replacement.

**FCC Notice:**

**This device complies with Part 15 of the FCC Rules. Operation is subject to the following two conditions: (1) this device may not cause harmful interference, and (2) this device must accept any interference received, including interference that may cause undesired operation.**

**FCC CAUTION:**

**Changes or modifications not expressly approved by the party responsible for compliance could void the user's authority to operate the equipment.**

**VARIABLE VOLTAGE CONTROL SYSTEM (if equipped)**

The variable voltage control system measures the amount of electrical discharge from the battery and controls voltage generated by the alternator.



**CAUTION:**

- Do not ground accessories directly to the battery terminal. Doing so will bypass the variable voltage control system and the vehicle battery may not charge completely.
- Use electrical accessories with the engine running to avoid discharging the vehicle battery.

**FUSES**

**ENGINE COMPARTMENT**

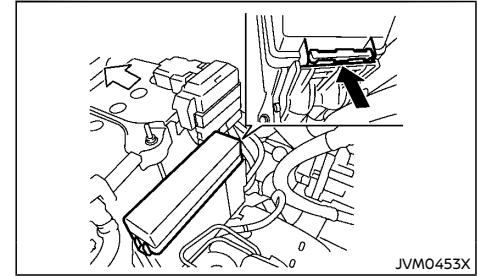

**CAUTION:**

- Never use a fuse of a higher or lower amperage rating than that specified on the fuse box cover. This could damage the electrical system or cause a fire.
- Never use wire or wrapping foil in place of a fuse. This could damage the electrical system or cause a fire.

The location and the amperage rating of fuses are shown on the backside of the fuse box lid.

The number of fuses may vary depending on the features equipped to the vehicle.

If any electrical equipment does not operate, check for an open fuse.

1. Be sure the ignition switch is in the "OFF" or "LOCK" position.
2. Be sure the headlight switch is in the "OFF" position.
3. Open the engine hood.
4. Remove the fuse/fusible link cover by pushing the tab.

5. Locate the fuse which needs to be replaced.

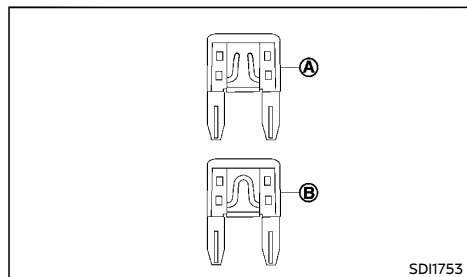

6. Remove the fuse using the fuse puller located in the passenger compartment fuse box.

7. If the fuse is open (A), replace it with a new fuse (B).

If the new fuse also opens, after installing, have the electrical system checked, and if necessary repaired, by a NISSAN dealer.

### Fusible links

If any electrical equipment does not operate and the fuses are in good condition, check the fusible links. If any of these fusible links are melted, replace only with genuine NISSAN parts.

## PASSENGER COMPARTMENT

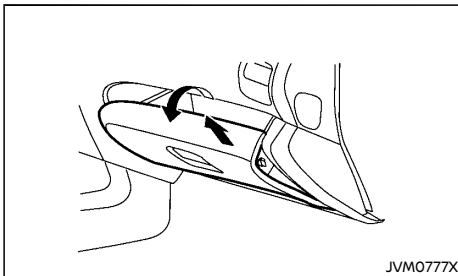

Left-Hand Drive model

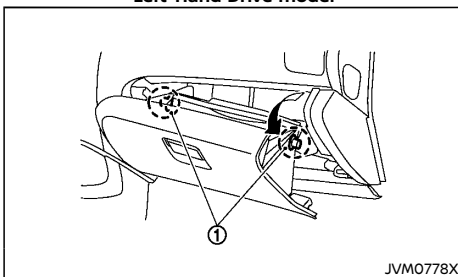

Left-Hand Drive model

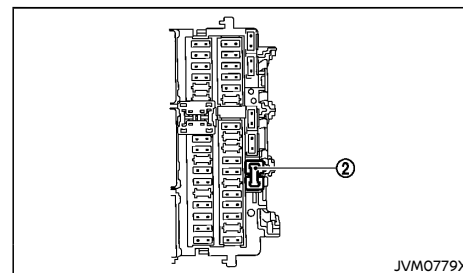

Left-Hand Drive model

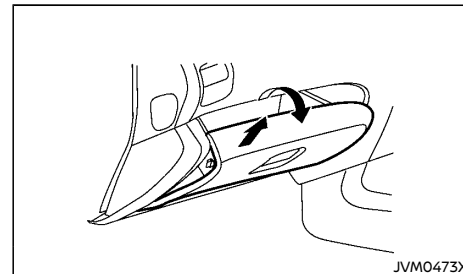

Right-Hand Drive model

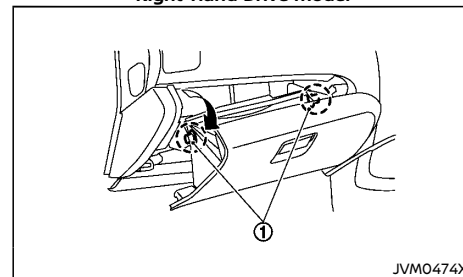

Right-Hand Drive model

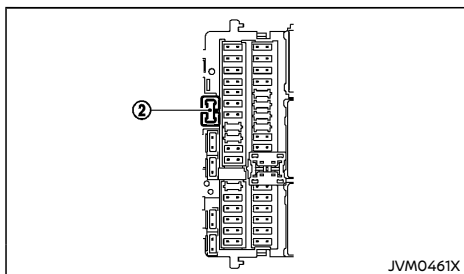

#### Right-Hand Drive model

1. Be sure the ignition switch is in the "OFF" position.
2. Be sure the headlight switch is in the "OFF" position.
3. Open the glove box.
4. Hold the glove box lid and pull it up to release the hinges located on the underside of the glove box.
5. Carefully release the left and right stoppers ① and remove the glove box.
6. Locate the fuse that needs to be replaced.
7. Remove the fuse using the fuse puller ②.

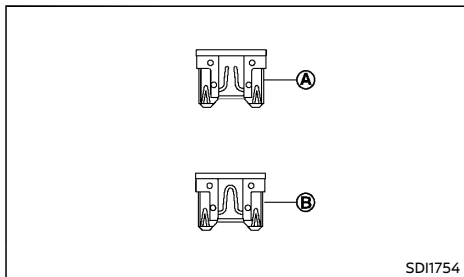

8. If the fuse is open ①, replace it with a new fuse ②.
9. Install the glove box following removal steps in opposite sequence.

If the new fuse also opens, after installing, have the electrical system checked, and if necessary repaired, by a NISSAN dealer.

#### Extended storage fuse switch (if equipped)

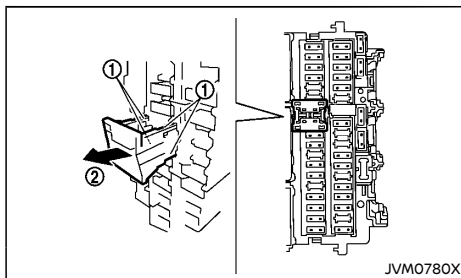

#### Left-Hand Drive model

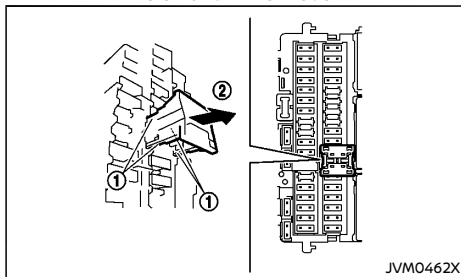

#### Right-Hand Drive model

To reduce battery drain, the extended storage fuse switch comes from the factory switched off. Prior to delivery of your vehicle, the switch is pushed in (switched on) and should always remain on.

If the extended storage fuse switch is not pushed in (switched on), the "Shipping Mode On Push Storage Fuse" warning may appear in the vehicle information display (models with color display). See "Vehicle information display warnings and indicators" (P.2-27).

If any electrical equipment does not operate, remove the extended storage fuse switch and check for an open fuse.

#### NOTE:

**If the extended storage fuse switch malfunctions or if the fuse is open, it is not necessary to replace the switch. In this case, remove the extended storage fuse switch and replace it with a new fuse of the same rating.**

#### How to remove the extended storage fuse switch:

1. To remove the extended storage fuse switch, be sure the ignition switch is in the "OFF" or "LOCK" position.
2. Be sure the headlight switch is in the "OFF" position.
3. Remove the fuse box cover.
4. Pinch the locking tabs ① found on each side of the storage fuse switch.
5. Pull the extended storage fuse switch straight out from the fuse box ②.



## LIGHTS

### HEADLIGHTS

Fog may temporarily form inside the lens of the exterior lights in the rain or in a car wash. A temperature difference between the inside and the outside of the lens causes the fog. This is not a malfunction. If large drops of water collect inside the lens, contact a NISSAN dealer.

#### LED headlight model

If replacement is required, contact a NISSAN dealer.

### EXTERIOR LIGHTS

Item	Wattage (W)
Front turn signal light	21
Clearance light and daytime running light (if equipped)*	LED
Front fog light* (if equipped)	LED
Side turn signal light* (on the outside rearview mirror) (if equipped)	LED
Side turn signal light (on the front fender) (if equipped)	5
Rear combination light	
Turn signal	21
Stop*	LED
Tail*	LED
Reverse	16
Rear fog light (if equipped)	21
License plate light*	5
High-mounted stop light*	LED

\*: See a NISSAN dealer for replacement.

### INTERIOR LIGHTS

Item	Wattage (W)
Map light*	LED
Rear personal light*	LED
Step light (if equipped)	3.4
Cargo light*	LED
Vanity mirror light (if equipped)	1.8

\*: See a NISSAN dealer for replacement.

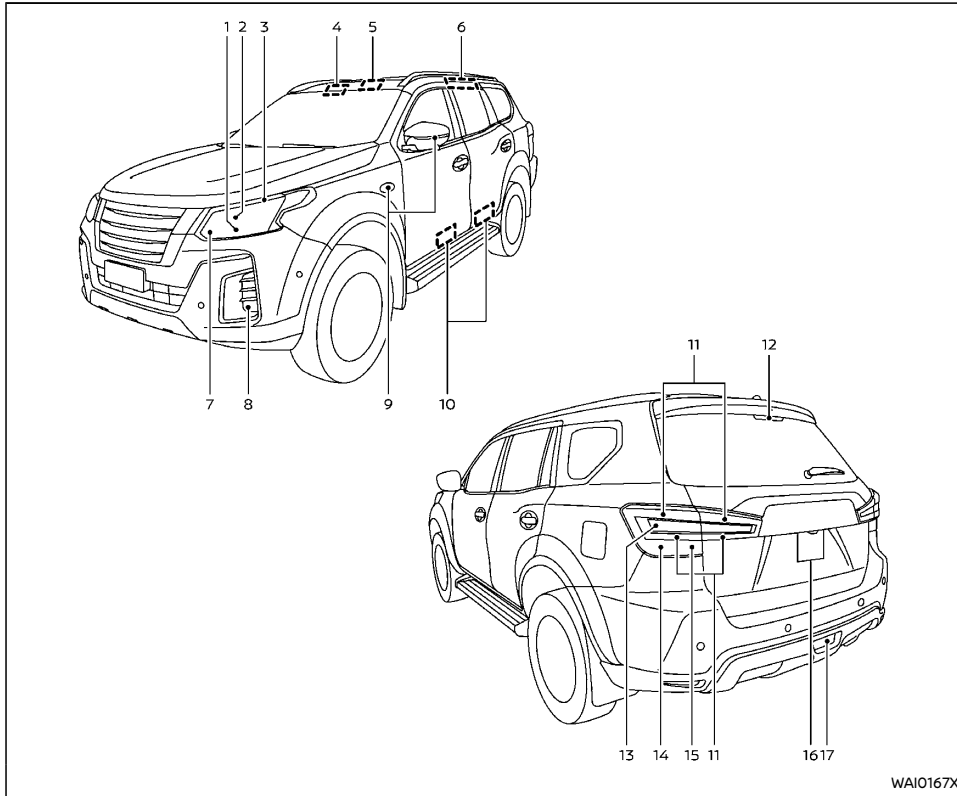

## LIGHT LOCATIONS

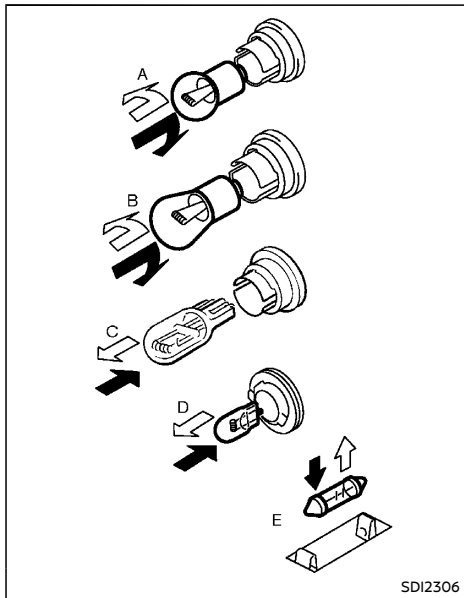

1. Headlight (low-beam)
2. Headlight (high-beam)
3. Front clearance light and daytime running light (if equipped)
4. Map light
5. Rear personal light
6. Cargo light
7. Front turn signal light
8. Front fog light (if equipped)
9. Side turn signal light (on the front fender or the outside rearview mirror)
10. Step light (if equipped)
11. Tail light
12. High-mounted stop light
13. Stop light
14. Rear turn signal light
15. Reverse light
16. License plate light
17. Rear fog light (if equipped)

## Replacement procedures



- : REMOVE  
: INSTALL

All other lights are either type A, B, C, D or E. When replacing a bulb, first remove the lens and/or cover.

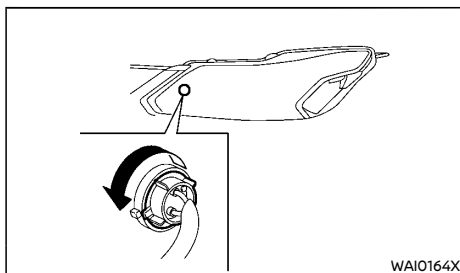

Front turn signal light

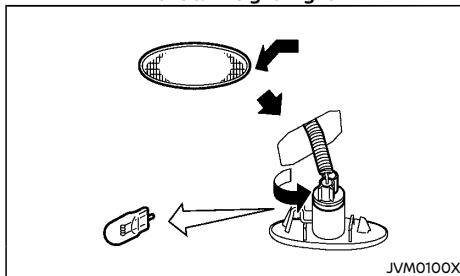

Side turn signal light (on the front fender) (if equipped)

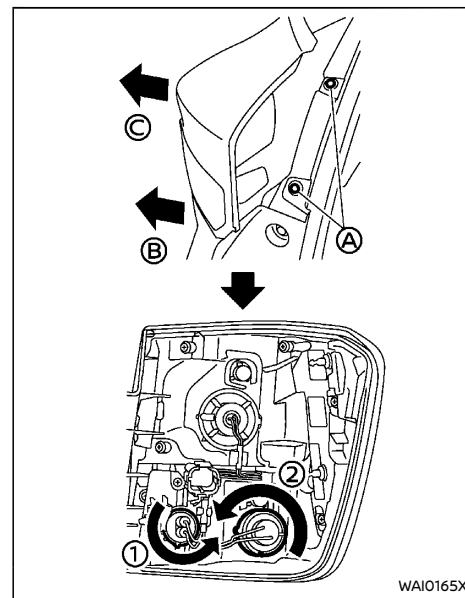

Rear combination light

1. Open the back door.
2. Remove the bolts **A** using a suitable tool.
3. Push the bottom part of the rear combination light **B** and then move the light **C** as shown to make a clearance.
4. Carefully pry the light using a suitable tool.
5. Replace the bulbs. (Reverse light **1**, Turn signal light **2**)
6. Install the combination light in the reverse order of removal.

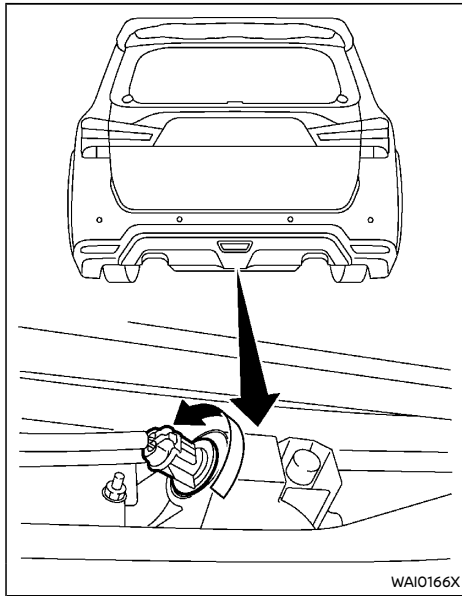

Rear fog light (if equipped)

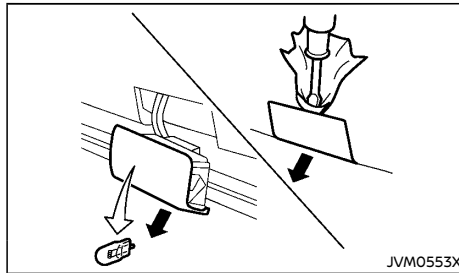

Step light (if equipped)

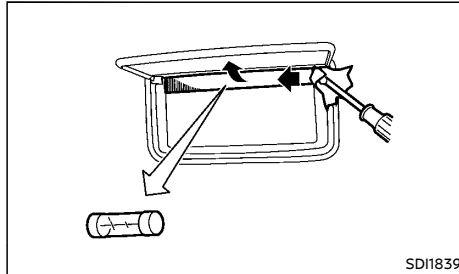

Vanity mirror light (if equipped)

## TIRES AND WHEELS

If you have a flat tire, see "Flat tire" (P.6-2).

### TIRE PRESSURE MONITORING SYSTEM (TPMS) (if equipped)

The Tire Pressure Monitoring System (TPMS) monitors tire pressure of all tires except the spare. When the low tire pressure warning light is lit, one or more of your tires is significantly under-inflated.

The TPMS will activate only when the vehicle is driven at speeds above 25 km/h (16 MPH). Also, this system may not detect a sudden drop in tire pressure (for example a flat tire while driving).

For more details about the TPMS, see "Tire Pressure Monitoring System (TPMS)" (P.5-5).

For additional information, see "Low tire pressure warning light" (P.2-15).

### TIRE INFLATION PRESSURE

Periodically check the pressure of the tires, including the spare. An incorrect tire pressure may adversely affect tire life and vehicle handling. The tire pressure should be checked when tires are COLD. Tires are considered COLD after the vehicle has been parked for 3 or more hours, or driven less than 1.6 km (1 mile). COLD tire pressures are shown on the tire placard.

Insufficient pressure can lead to an overheating of the tire and subsequent internal damage. At high speeds, this could result in tread separation and even bursting of the tire.

## TYPES OF TIRES



### CAUTION:

**When changing or replacing tires, be sure all four tires are of the same type (that is, summer, all season or snow) and construction. A NISSAN dealer may be able to help you with information about tire type, size, speed rating and availability.**

Replacement tires may have a lower speed rating than the factory equipped tires, and they may not match the potential maximum vehicle speed. Never exceed the maximum speed rating of the tire.

### All season tires

NISSAN specifies all season tires on some models to provide good performance all year, including snowy and icy road conditions. All season tires are identified by ALL SEASON and/or M&S on the tire sidewall. Snow tires have better snow traction than all season tires and may be more appropriate in some areas.

### Summer tires

NISSAN specifies summer tires on some models to provide superior performance on dry roads. Summer tire performance is substantially reduced in snow and ice. Summer tires do not have the tire traction rating M&S on the tire sidewall.

If you plan to operate your vehicle in snowy or icy conditions, NISSAN recommends the use of snow or all season tires on all four wheels.

## Snow tires

If snow tires are needed, it is necessary to select tires equivalent in size and load rating to the original equipment tires. If you do not, it can adversely affect the safety and handling of your vehicle.

Generally, snow tires have lower speed ratings than factory equipped tires and may not match the potential maximum vehicle speed. Never exceed the maximum speed rating of the tire. If you install snow tires, they must be the same size, brand, construction and tread pattern on all four wheels.

For additional traction on icy roads, studded tires may be used. However, some states and provinces prohibit their use. Check local, state and provincial laws before installing studded tires. Skid and traction capabilities of studded snow tires on wet or dry surfaces may be poorer than that of non-studded snow tires.

### Four-Wheel Drive (4WD) model



### CAUTION:

- **Always use tires of the same type, size, brand, construction (bias, bias-belted or radial), and tread pattern on all four wheels. Failure to do so may result in a circumference difference between tires on the front and rear axles which will cause excessive tire wear and may damage the transmission, transfer case and differential gears.**
- **ONLY use spare tires specified for the 4WD model.**

If excessive tire wear is found, it is recommended that all four tires be replaced with tires of the same size, brand, construction and tread pattern. The tire pressure and wheel alignment

should also be checked and corrected as necessary. Contact a NISSAN dealer.

## TIRE CHAINS

Use of tire chains may be prohibited according to location. Check the local laws before installing tire chains. When installing tire chains, make sure that they are of proper size for the tires on your vehicle and are installed according to the chain manufacturer's instructions.

Use chain tensioners when recommended by the tire chain manufacturer to ensure a tight fit. Loose end links of the tire chains must be secured or removed to prevent the possibility of whipping action damage to the fenders or underbody. If possible, avoid fully loading your vehicle when using tire chains. In addition, drive at a reduced speed. Otherwise, your vehicle may be damaged and/or vehicle handling and performance may be adversely affected.

**Tire chains must be installed only on the rear wheels and not on the front wheels.**

Do not drive with tire chains on paved roads which are clear of snow. Driving with chains in such conditions can cause damage to the various mechanisms of the vehicle due to some overstress.

## TIRE ROTATION

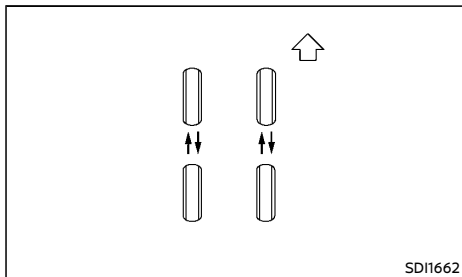

NISSAN recommends that tires be rotated every 5,000 km (3,000 miles) for Four-Wheel Drive (4WD) or every 10,000 km (6,000 miles) for Two-Wheel Drive (2WD) model. However, the timing for tire rotation may vary according to your driving habits and the road surface conditions. (See "Flat tire" (P.6-2) for the tire replacement.)



### WARNING:

- After rotating the tires, adjust the tire pressure.
- Retighten the wheel nuts when the vehicle has been driven for 1,000 km (600 miles) (also in cases of a flat tire, etc.).
- Do not include the spare tire in tire rotation.
- Incorrect tire selection, fitting, care or maintenance can affect vehicle safety with risk of accident and injury. If in doubt, consult a NISSAN dealer or the tire manufacturer.

For models equipped with Tire Pressure Monitoring System (TPMS) (model with TPMS reset function)

After the tires are rotated, the TPMS must be reset. See "Tire Pressure Monitoring System (TPMS)" (P.5-5) for details about the resetting procedure.

## TIRE WEAR AND DAMAGE

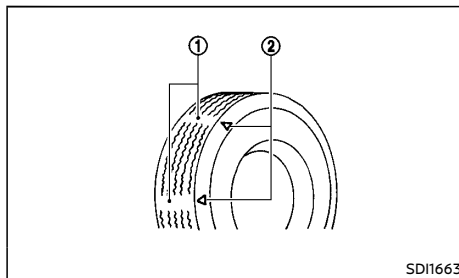

- ① : Wear indicator  
② : Wear indicator location marks. The locations are shown by " Δ ", "TWI", etc. depending on tire types.

Tires should be periodically inspected for wear, cracking, bulging or objects caught in the tread. If excessive wear, cracks, bulging or deep cuts are found, the tire should be replaced immediately.

The original tires have a built-in tread wear indicator. When the wear indicator is visible, the tire should be replaced.

Improper service of a spare tire may result in serious personal injury. If it is necessary to repair the spare tire, contact a NISSAN dealer.

## TIRE AGE

Never use a tire over six years old, regardless of whether it has been used or not.

Tires degrade with age as well as with the vehicle usage. Have your tires checked and balanced often by a repair shop or, if you prefer, a NISSAN dealer.

## CHANGING TIRES AND WHEELS



### WARNING:

**Do not install a deformed wheel or tire even if it has been repaired. Such wheels or tires could have structural damage and could fail without warning.**

When replacing a tire, use the same size, speed rating and load carrying capacity as originally equipped. (See "Tires and wheels" (P.9-8) for recommended types and sizes of tires and wheels.) The use of tires other than those recommended or the mixed use of tires of different brands, construction (bias, bias-belted, or radial), or tread patterns can adversely affect the ride, braking, handling, ground clearance, body-to-tire clearance, snow chain clearance, Tire Pressure Monitoring System (TPMS) (if equipped), speedometer calibration, headlight aim and bumper height. Some of these effects may lead to accidents and could result in serious personal injury.

If the wheels are changed for any reason, always replace with wheels which have the same offset dimension. Wheels of a different offset could cause early tire wear, possibly degraded vehicle handling characteristics and/or interference with the brake discs/drums. Such interference can lead to decreased braking efficiency and/or early brake pad/shoe wear.

Confirm the following for the TPMS (if equipped).



**WARNING:**

- **After a tire or a wheel is replaced, the TPMS must be reset (model with TPMS reset function). (See “Tire Pressure Monitoring System (TPMS)” (P.5-5) for details about the resetting procedure.)**
- **Since the spare tire is not equipped with the TPMS, when a spare tire is mounted or a wheel is replaced, the TPMS will not function and the low tire pressure warning light will flash for approximately 1 minute. The light will remain on after 1 minute. Contact a NISSAN dealer as soon as possible for tire replacement and/or system resetting.**
- **Replacing tires with those not originally specified by NISSAN could affect the proper operation of the TPMS.**
- **The TPMS sensor may be damaged if it is not handled correctly. Be careful when handling the TPMS sensor.**
- **When replacing the TPMS sensor, the ID registration may be required. Contact a NISSAN dealer for ID registration.**
- **Do not use a valve stem cap that is not specified by NISSAN. The valve stem cap may become stuck.**
- **Be sure that the valve stem caps are correctly fitted. Otherwise the valve may be clogged up with dirt and cause a malfunction or loss of pressure.**

## WHEEL BALANCE

Unbalanced wheels may affect vehicle handling and tire life. Even with regular use, wheels can get out of balance. Therefore, they should be balanced as required.

## SPARE TIRE

Conventional spare tire

A standard tire (the same size as the road wheels) is supplied with your vehicle.

**MEMO**



# 9 Technical information

Recommended fluids/lubricants and capacities .....	9-2	For Indonesia .....	9-12
Fuel information .....	9-4	For Vietnam .....	9-13
Recommended SAE viscosity number (except for YS23DDTT engine model) .....	9-4	For the United Arab Emirates .....	9-13
Air conditioner system refrigerant and lubricant .....	9-5	For Bahrain .....	9-14
Engine .....	9-6	For Oman .....	9-14
Technical characteristics (for Gulf Standard models) .....	9-7	For Qatar .....	9-15
Tires and wheels .....	9-8	For Jordan .....	9-15
Dimensions .....	9-8	For Georgia .....	9-15
When travelling or registering in another country .....	9-9	For Libya .....	9-17
Vehicle identification .....	9-9	For Tahiti .....	9-17
Vehicle identification label (if equipped) .....	9-9	For New Caledonia .....	9-18
Vehicle Identification Number (VIN) plate (if equipped) .....	9-9	For Western Samoa .....	9-20
Vehicle Identification Number (VIN) .....	9-9	For Thailand .....	9-20
Certification label (if equipped) .....	9-9	For South Africa .....	9-20
Engine serial number .....	9-10	For Benin .....	9-21
Tire placard .....	9-10	For Comoros .....	9-22
Air conditioner specification label .....	9-10	For Ghana .....	9-22
Uniform tire quality grading (if equipped) .....	9-11	For Nigeria .....	9-23
Treadwear .....	9-11	For Zambia .....	9-23
Traction AA, A, B and C .....	9-11	For West Sahara .....	9-24
Temperature A, B and C .....	9-11	For Abu Dhabi .....	9-24
Installation of an RF-transmitter .....	9-11	For Central Africa .....	9-24
Radio approval number and information .....	9-12	For Guinea Bissau .....	9-25
For the Philippines .....	9-12	For Sao Tome Principe .....	9-26
		Other radio approval information .....	9-27

## RECOMMENDED FLUIDS/ LUBRICANTS AND CAPACITIES

The following are approximate capacities. The actual refill quantities may be slightly different. When refilling, follow the procedures instructed in the "8. Maintenance and do-it-yourself" section to determine the proper refill capacity.

Fluid type			Capacity (approximate)			Recommended Fluids/Lubricants
			Metric Measure	US Measure	Imperial Measure	
Fuel			78 L	20-5/8 gal	17-1/8 gal	· See "Fuel information" (P.9-4).
Engine oil <sup>1)</sup>  Drain and refill <sup>2)</sup> : For additional information, see "Changing engine oil and oil filter" (P.8-11).	YD25DDTI	With oil filter change	5.3 L	5-5/8 qt	4-5/8 qt	<ul style="list-style-type: none"> <li>· Genuine "NISSAN Motor Oil 5W-30 CF-4 or B1" is recommended.</li> <li>· If the above motor oil is not available, use "NISSAN Motor Oil" or equivalent that matches the following grade and viscosity.               <ul style="list-style-type: none"> <li>· Oil grade:                   <ul style="list-style-type: none"> <li>– API CF-4<sup>2)</sup></li> <li>– ACEA B1, B3, B4 or B5</li> </ul> </li> <li>· <sup>2)</sup> Never use API CG-4.</li> </ul> </li> <li>· SAE Viscosity: See "Recommended SAE viscosity number (except for YS23DDTT engine model)" (P.9-4).</li> </ul>
		Without oil filter change	4.8 L	5-1/8 qt	4-1/4 qt	
	YS23DDTT	With oil filter change	6.3 L	6-5/8 qt	5-1/2 qt	
		Without oil filter change	6.0 L	6-3/8 qt	5-1/4 qt	
	QR25DE	With oil filter change	4.7 L	5 qt	4-1/8 qt	
		Without oil filter change	4.4 L	4-5/8 qt	3-7/8 qt	
Engine coolant  with reservoir	YD25DDTI	Except for South Africa	10.6 L	11-1/4 qt	9-3/8 qt	<ul style="list-style-type: none"> <li>· Genuine NISSAN Engine Coolant (blue) or equivalent</li> <li>· Use Genuine NISSAN Engine Coolant or equivalent in its quality, in order to avoid possible aluminum corrosion within the engine cooling system caused by the use of non-genuine engine coolant. Note that any repairs for the incidents within the engine cooling system while using non-genuine engine coolant may not be covered by the warranty even if such incidents occurred during the warranty period.</li> </ul>
		For South Africa	11.1 L	11-3/4 qt	9-3/4 qt	
	YS23DDTT	11.1 L	11-3/4 qt	9-3/4 qt		
	QR25DE	8.1 L	8-5/8 qt	7-1/8 qt		
	Automatic Transmission Fluid (ATF)	-	-	-	-	
						<ul style="list-style-type: none"> <li>· Genuine NISSAN Matic S ATF</li> <li>· NISSAN recommends using Genuine NISSAN Matic S ATF ONLY in NISSAN automatic transmissions. Do not mix with other fluids. Using fluids that are not equivalent to Genuine NISSAN Matic S ATF may damage the automatic transmission. Damage caused by the use of fluids other than as recommended is not covered under the warranty.</li> </ul>

Fluid type		Capacity (approximate)			Recommended Fluids/Lubricants
		Metric Measure	US Measure	Imperial Measure	
Manual transmission (MT) gear oil	Two-Wheel Drive (2WD) model	3.0 L	3-1/8 qt	2-5/8 qt	<ul style="list-style-type: none"> <li>Genuine NISSAN Manual Transmission Fluid (MTF) HQ Multi 75W-85</li> <li>If Genuine NISSAN Manual Transmission Fluid (MTF) HQ Multi is not available, API GL-4, Viscosity SAE 75W-85 may be used as a temporary replacement. However, use Genuine NISSAN Manual Transmission Fluid (MTF) HQ Multi as soon as it is available.</li> </ul>
	Four-Wheel Drive (4WD) model	3.4 L	3-5/8 qt	3 qt	
Transfer fluid		1.4 L	1-1/2 qt	1-1/4 qt	<ul style="list-style-type: none"> <li>7 ATF III</li> <li>Using fluid other than 7 ATF III may cause deterioration in driveability and transfer durability, and may damage the transfer, which is not covered by the warranty.</li> </ul>
Power steering fluid		Refill to the proper fluid level according to the instructions in the "8. Maintenance and do-it-yourself" section.			<ul style="list-style-type: none"> <li>Genuine NISSAN PSF or equivalent</li> <li>DEXRON™ VI type ATF may also be used.</li> </ul>
Brake and clutch fluid					<ul style="list-style-type: none"> <li>Genuine NISSAN Brake Fluid or equivalent DOT3 or DOT4</li> <li>Never mix different types of fluids (DOT3 and DOT4).</li> </ul>
Differential gear oil	Front	0.85 L	7/8 qt	3/4 qt	<ul style="list-style-type: none"> <li>Genuine NISSAN Differential Oil Hypoid Super GL-5 80W-90 (mineral oil) or equivalent</li> <li>NISSAN recommends using Genuine NISSAN Differential Oil Hypoid Super GL-5 80W-90 ONLY in NISSAN final drive. Do not mix with other fluids. Using fluids that are not equivalent to Genuine NISSAN Differential Oil Hypoid Super GL-5 80W-90 may damage the final drive. Damage caused by the use of fluids other than as recommended is not covered under the warranty.</li> </ul>
	Rear	2.85 L	3 qt	2-1/2 qt	
Multi-purpose grease		-	-	-	<ul style="list-style-type: none"> <li>NLGI No. 2 (Lithium soap base)</li> </ul>
Air conditioner system refrigerant		-	-	-	<ul style="list-style-type: none"> <li>HFC-134a (R-134a)</li> </ul>
Air conditioner system lubricants		-	-	-	<ul style="list-style-type: none"> <li>NISSAN A/C System Oil DH-PS(PAG) or equivalent</li> </ul>

## FUEL INFORMATION

Gasoline engine (model with three-way catalyst)



### CAUTION:

**Do not use leaded gasoline. Using leaded gasoline will damage the three-way catalyst.**

Use UNLEADED REGULAR gasoline with an octane rating of at least 91 (RON).

Diesel engine\*

**YD25DDTi engine:**

Diesel fuel above 50 cetane must be used.

**YS23DDTT engine:**

Diesel fuel above 50 cetane and with a maximum of 50 ppm of sulfur (EN590) must be used.

For Thailand:

This vehicle is able to be used with diesel fuel (B20), which is defined fuel specification and quality in the Notification of Department of Energy Business. However, more frequent fuel filter replacement is necessary. For details, see the separate maintenance booklet.

\* If two types of diesel fuel are available, use summer or winter fuel properly according to the following temperature conditions.

- Above  $-7^{\circ}\text{C}$  ( $20^{\circ}\text{F}$ ) ... Summer type diesel fuel.
- Below  $-7^{\circ}\text{C}$  ( $20^{\circ}\text{F}$ ) ... Winter type diesel fuel.



### CAUTION:

- **Do not use home heating oil, gasoline or other alternate fuels in your diesel engine. The use of those or adding those to diesel fuel can cause engine damage.**

- **Do not use summer fuel at temperatures below  $-7^{\circ}\text{C}$  ( $20^{\circ}\text{F}$ ). The cold temperatures will cause wax to form in the fuel. As a result, it may prevent the engine from running smoothly.**

RECOMMENDED SAE VISCOSITY NUMBER (except for YS23DDTT engine model)

Gasoline engine oil

**0W-20 is preferable. If 0W-20 is not available, select the viscosity, from the chart below, that is suitable for the outside temperature range.**

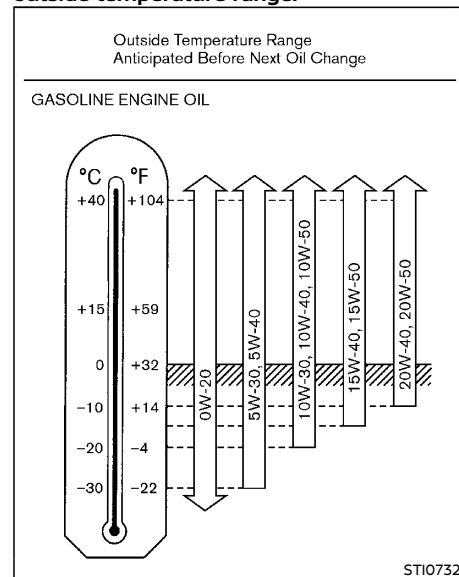

## Diesel engine oil

For YD25DDTi engine model

**5W-30 is preferable.**

**If 5W-30 is not available, select the viscosity, from the chart below, that is suitable for the outside temperature range.**

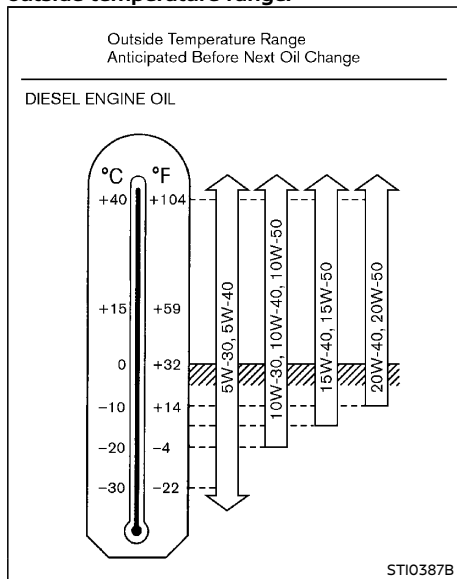

## AIR CONDITIONER SYSTEM REFRIGERANT AND LUBRICANT

The air conditioner system of your vehicle must be charged with the refrigerant HFC-134a (R134a) and the lubricant NISSAN A/C System Oil DH-PS(PAG) or equivalents.



### CAUTION:

**Use of any other refrigerants or lubricants will cause severe damage, and you may need to replace your vehicle's entire air conditioner system.**

The release of refrigerants into the atmosphere is prohibited in many countries and regions. The refrigerant HFC-134a (R-134a) in your vehicle will not harm the Earth's ozone layer. However, it may contribute in a small part to the global warming effect. NISSAN recommends that the refrigerant be appropriately recovered and recycled. Contact a NISSAN dealer when servicing the air conditioner system.

## ENGINE

Engine Model		QR25DE	YD25DDTi	YS23DDTT
Type		Gasoline, 4-cycle, DOHC	Diesel, 4-cycle	Diesel, 4-cycle
Cylinder arrangement		4-cylinder, in-line	4-cylinder, in-line	4-cylinder, in-line
Bore × Stroke	mm (in)	89 × 100 (3.504 × 3.937)	89 × 100 (3.504 × 3.937)	85 × 101.3 (3.346 × 3.988)
Displacement	cm <sup>3</sup> (cu in)	2,488 (151.82)	2,488 (151.82)	2,298 (140.22)
Idle speed at the "N" (Neutral) position	rpm	625±60 (MT) 700±50 (AT)	750±50*1	750±50
Ignition timing (B.T.D.C.) at the "N" (Neutral) position		10°±2	-	-
Spark plugs				
Type	Standard	FXE20HE11	-	-
Gap	mm (in)	1.0-1.1 (0.043)		
Camshaft operation		Timing chain	Timing chain	Timing chain

\*1: When driving at high altitude, idling speed will increase.

## TECHNICAL CHARACTERISTICS (for Gulf Standard models)

Engine model		QR25DE
Maximum net power	kw/rpm	124/6,000
Maximum net torque	N·m/rpm	241/4,000
Maximum speed*1	km/h (MPH)	180 (112)

\*1: Gulf Standard regulation requires automobile manufacturers to indicate the maximum vehicle speed for applicable models. The maximum vehicle speed, listed above, is the measured speed under certain testing conditions. The actual value may differ according to the vehicle usage and road and environmental conditions. NISSAN recommends you to ALWAYS observe posted speed limits and never drive too fast for conditions.

## TIRES AND WHEELS

		Standard	Spare	
Tire size		255/65R17 110H	Conventional	
		255/60R18 108H	Conventional	
			Size	Offset mm (in)
Road wheel	Standard	Aluminum	17 × 7J	45 (1.77)
			18 × 7J	45 (1.77)
	Spare	Aluminum	17 × 7J	45 (1.77)
			18 × 7J	45 (1.77)
	Steel	17 × 7J	45 (1.77)	

See the tire placard on your vehicle for the recommended COLD tire pressure.

## DIMENSIONS

		Unit: mm (in)
Overall length		4,890 (192.5)*1
		4,900 (192.9)*2*3
Overall width		1,865 (73.4)
Overall height		1,865 (73.4)
Front tread		1,565 (61.6)
Rear tread		1,570 (61.8)
Wheelbase		2,850 (112.2)

\*1: Without license plate, except for the Middle East

\*2: With license plate, except for the Middle East

\*3: For the Middle East



## WHEN TRAVELLING OR REGISTERING IN ANOTHER COUNTRY

When planning to travel in another country or region, find out whether the fuel required for your vehicle is available in that country or region. Using a low octane/cetane rated fuel may cause engine damage. Therefore, be sure that the required fuel is available wherever you go. For additional information regarding recommended fuel, see earlier in this section.

When transferring the registration of your vehicle to another country, state, province or district, contact the appropriate authorities to find out that the vehicle complies with the local legal requirements. In some cases, a vehicle cannot meet the legal requirements, and it may be necessary to modify the vehicle to meet local laws and regulations. In addition, there may be possibilities that a vehicle cannot be adapted in certain areas.

The laws and regulations for motor vehicle emission control and safety standards vary according to the country, state, province or district; therefore, the vehicle specification may differ.

When any vehicles are to be taken into another country, state, province or district, its modification, transportation, registration, and any other expenses which may result, are the responsibility of the user. NISSAN is not responsible for any inconveniences that may result.

## VEHICLE IDENTIFICATION

It is prohibited to cover, paint, weld, cut, drill, alter or remove Vehicle Identification Number (VIN).

### VEHICLE IDENTIFICATION LABEL (if equipped)

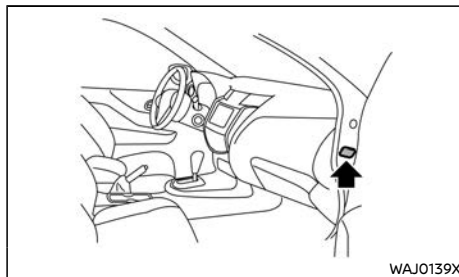

The vehicle identification label is affixed as illustrated.

### VEHICLE IDENTIFICATION NUMBER (VIN) PLATE (if equipped)

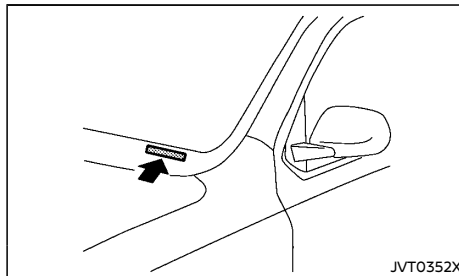

The vehicle identification number plate is attached as shown.

### VEHICLE IDENTIFICATION NUMBER (VIN)

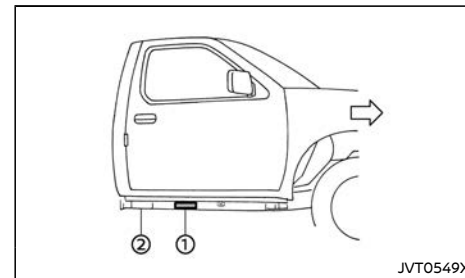

The Vehicle Identification Number (VIN) ① is stamped on the frame ② as shown.

### CERTIFICATION LABEL (if equipped)

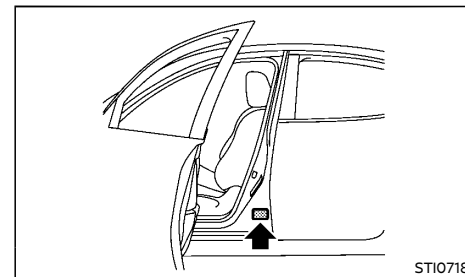

## ENGINE SERIAL NUMBER

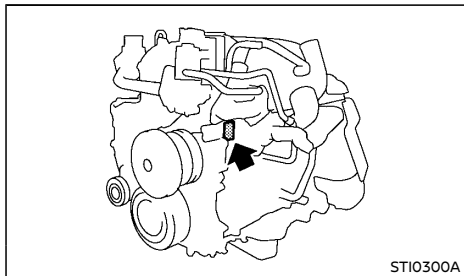

**YD25DDTi engine**

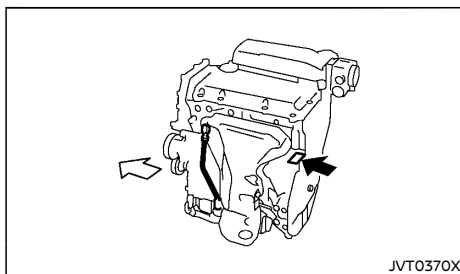

**QR25DE engine**

The number is stamped on the engine as shown.

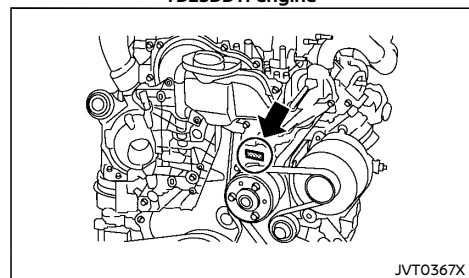

**YS23DDTT engine**

## TIRE PLACARD

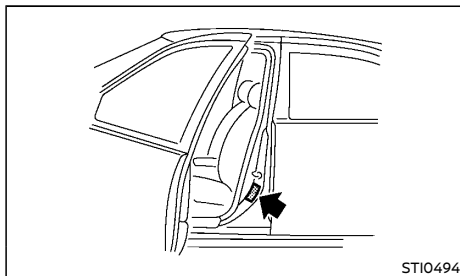

The cold tire pressures are shown on the tire placard affixed to the driver's side center pillar.

## AIR CONDITIONER SPECIFICATION LABEL

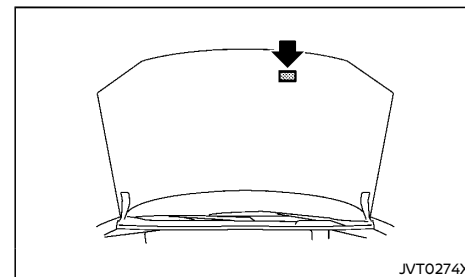

The air conditioner specification label is attached to the underside of the hood as shown.

## UNIFORM TIRE QUALITY GRADING (if equipped)

Quality Grades: All passenger car tires must conform to local safety requirements in addition to these grades.

Quality grades can be found where applicable on the tire sidewall between tread shoulder and maximum section width. For example:

### Treadwear 200 Traction AA Temperature A

#### TREADWEAR

The treadwear grade is a comparative rating based on the wear rate of the tire when tested under controlled conditions on a specified government test course. For example, a tire graded 150 would wear one and one-half (1 1/2) times as well on the government course as a tire graded 100. The relative performance of tires depends upon the actual conditions of their use, however, and may depart significantly from the norm due to variations in driving habits, service practices and differences in road characteristics and climate.

#### TRACTION AA, A, B AND C

The traction grades, from highest to lowest, are AA, A, B, and C. Those grades represent the tire's ability to stop on wet pavement as measured under controlled conditions on specified government test surfaces of asphalt and concrete. A tire marked C may have poor traction performance.



#### WARNING:

**The traction grade assigned to this tire is based on straight-ahead braking traction tests, and does not include acceleration, cornering, hydroplaning, or peak traction characteristics.**

#### TEMPERATURE A, B AND C

The temperature grades are A (the highest), B, and C, representing the tire's resistance to the generation of heat and its ability to dissipate heat when tested under controlled conditions on a specified indoor laboratory test wheel. Sustained high temperature can cause the material of the tire to degenerate and reduce tire life, and excessive temperature can lead to sudden tire failure. The grade C corresponds to a level of performance which all passenger car tires must meet under the local regulations. Grades B and A represent higher levels of performance on the laboratory test wheel than the minimum required by law.



#### WARNING:

**The temperature grade for this tire is established for a tire that is properly inflated and not overloaded. Excessive speed, under-inflation, or excessive loading, either separately or in combination, can cause heat build-up and possible tire failure.**

## INSTALLATION OF AN RF-TRANSMITTER

### For countries conforming to UN regulation No.10 or equivalent:

The installation of an RF transmitter in your vehicle could affect electric equipment systems. Be sure to check with your NISSAN dealer for precautionary measures or special instructions regarding installation. Upon request, your NISSAN dealer will provide the detailed information (frequency band, power, antenna position, installation guide, etc.) regarding installation.

## RADIO APPROVAL NUMBER AND INFORMATION

FOR THE PHILIPPINES

Side radar sensor (if equipped)

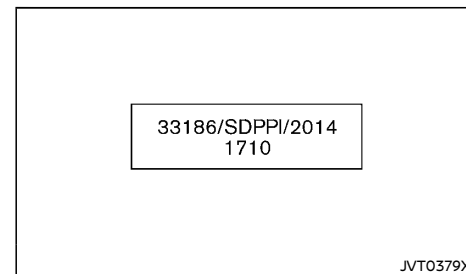
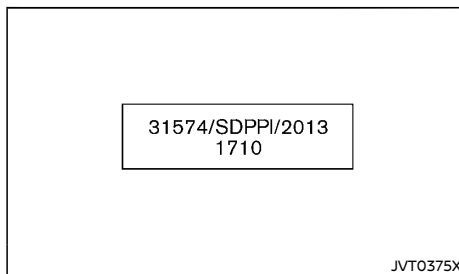

FOR INDONESIA

Remote keyless entry system (if equipped)

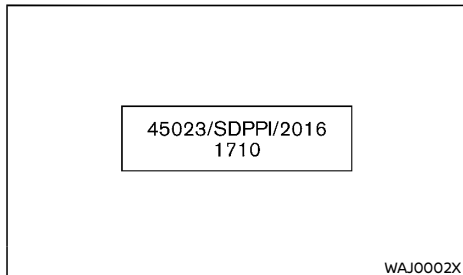

Intelligent Key system (if equipped)

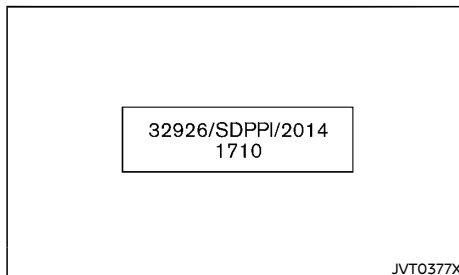

Tire Pressure Monitoring System (TPMS) transmitter (if equipped)

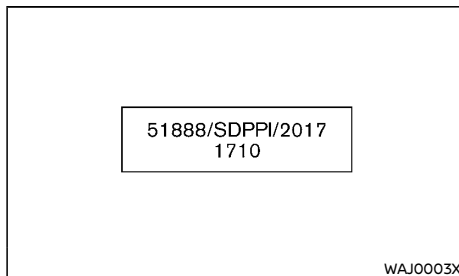
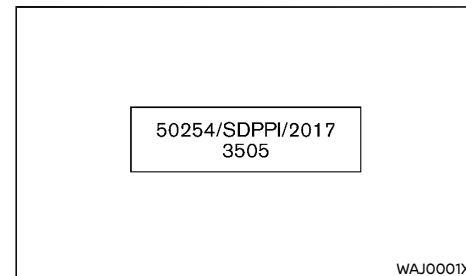

## FOR VIETNAM

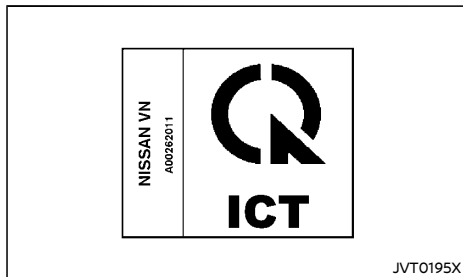

- Remote keyless entry system (if equipped)
- Intelligent Key system (if equipped)

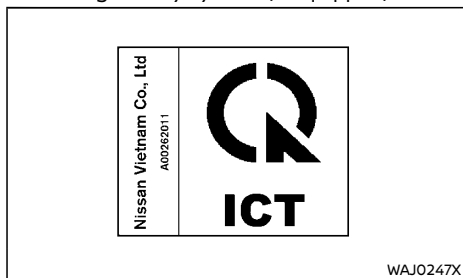

- Tire Pressure Monitoring System (TPMS) transmitter (if equipped)

## FOR THE UNITED ARAB EMIRATES

### NISSAN Anti-Theft System (NATS) immobilizer

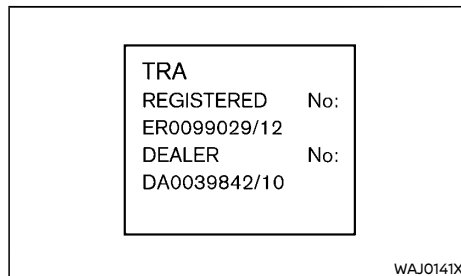

### BCM (Body Control Module)

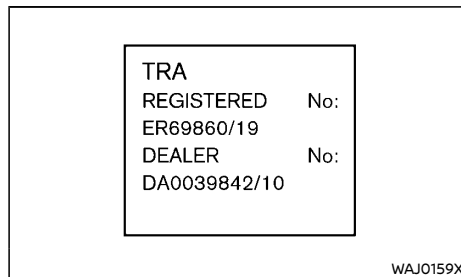

## Front radar sensor (if equipped)

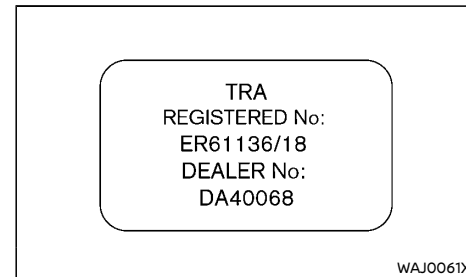

## Side radar sensor (if equipped)

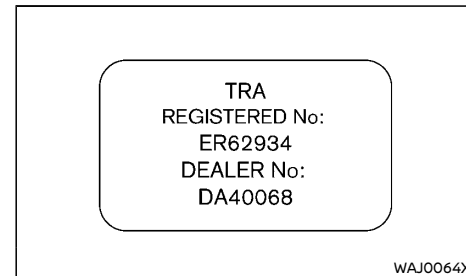

### Tire Pressure Monitoring System (TPMS) sensor

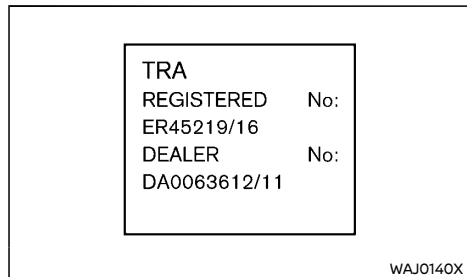

### FOR OMAN

#### Side radar sensor (if equipped)

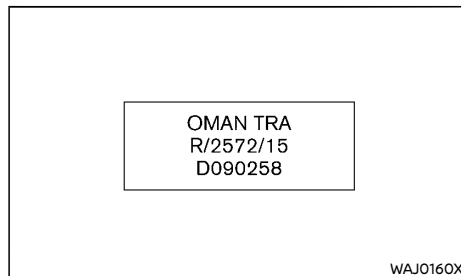

### FOR BAHRAIN

#### Front radar sensor (if equipped)

The Equipment Identified hereon is approved for use under the following rules.

- 1- This equipment must not cause harmful interference to other services.
- 2- This equipment is subject to harmful interference, and the owner of this equipment must not claim for protection.

#### Side radar sensor (if equipped)

The Equipment Identified hereon is approved for use under the following rules.

- 1- This equipment must not cause harmful interference to other services.
- 2- This equipment is subject to harmful interference, and the owner of this equipment must not claim for protection.

#### Intelligent Key system (if equipped)

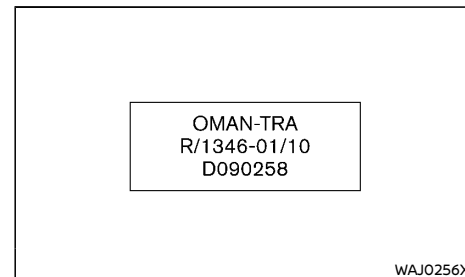
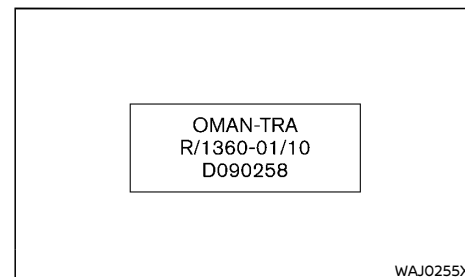
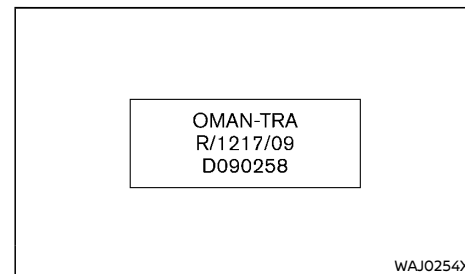
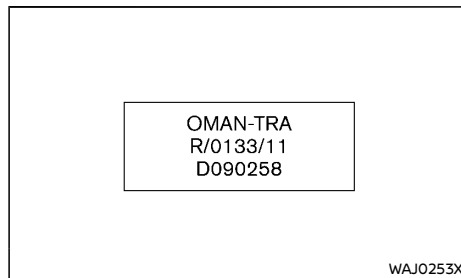

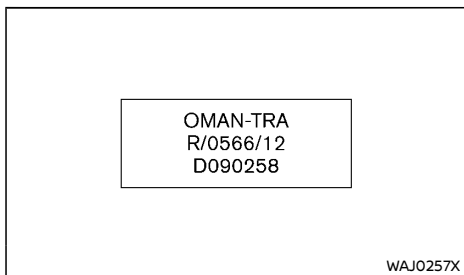

#### FOR QATAR

Front radar sensor (if equipped)



Hereby, ADC Automotive Distance Control Systems GmbH declares that the radio equipment type ARS4-B is in compliance with Directive 2014/53/EU.

The full text of the EU declaration of conformity is available at the following internet address:

<http://continental.automotive-approvals.com/>

#### FOR JORDAN

Front radar sensor (if equipped)

TRC's type approval certificate number: TRC/LPD/2014/248

Side radar sensor (if equipped)

TRC's type approval certificate number: TRC/LPD/2015/80

Tire Pressure Monitoring System (TPMS) sensor

TRC's type approval certificate number: TRC/LPD/2016/78

Tire Pressure Monitoring System (TPMS) tuner

TRC's type approval certificate number: TRC/LPD/2015/426

Intelligent Key system (if equipped)

TRC's type approval certificate number: TRC/LPD/2017/594

TRC's type approval certificate number: TRC/LPD/2010/7

TRC's type approval certificate number: TRC/LPD/2013/3

TRC's type approval certificate number: TRC/LPD/2013/206

TRC's type approval certificate number: TRC/LPD/2012/51

TRC's type approval certificate number: TRC/LPD/2013/4

TRC's type approval certificate number: TRC/LPD/2010/34

TRC's type approval certificate number: TRC/LPD/2010/7

#### FOR GEORGIA

Front radar sensor (if equipped)



Hereby, ADC Automotive Distance Control Systems GmbH declares that the radio equipment type ARS4-B is in compliance with Directive 2014/53/EU.

The full text of the EU declaration of conformity is available at the following internet address:

<http://continental.automotive-approvals.com/>

Side radar sensor (if equipped)



Hereby, ADC Automotive Distance Control Systems GmbH declares that the radio equipment type SRR3-B is in compliance with Directive 2014/53/EU.

The full text of the EU declaration of conformity is available at the following internet address:

<http://continental.automotive-approvals.com/>

Tire Pressure Monitoring System (TPMS) tuner

- Manufacturer name:  
ALPS ELECTRIC CO.,LTD.
- Registered trademark:  
**ALPS ELECTRIC CO., LTD.**
- Manufacturer address:  
6-3-36, Nakazato,  
Furukawa, Osaki-city,  
Miyagi-pref., JAPAN 989-6181

- Importer name, Address:  
Nissan International SA  
Zone d'activités La Pièce 12  
1180 Rolle, Switzerland

• Operating frequency band: 433.92 MHz  
Hereby, ALPS ELECTRIC CO., LTD., declares that the radio equipment type TWD1G791 is in compliance with Directive 2014/53/EU.

The full text of the EU declaration of conformity is available at the following internet address:

<http://www.alps.com/products/common/pdf/Tuner/TWD1G791.pdf>

Intelligent Key system (if equipped)

**MODEL TWC1G135, PASSIVE ENTRY SYSTEM (TUNER):**

Hereby, ALPS ELECTRIC CO.,LTD., declares that the radio equipment type TWC1G135 is in compliance with Directive 2014/53/EU.

The full text of the EU declaration of conformity is available at the following internet address:

<https://www.alps.com/products/common/pdf/Tuner/TWC1G135.pdf>

- Manufacturer name:  
ALPS ELECTRIC CO,LTD
- Importer name, Address:  
Nissan International SA  
Zone d'activités La Pièce 12  
1180 Rolle, Switzerland
- Operating frequency band: 433.92 MHz
- Maximum radio-frequency power: ≤ 10 dBm

**MODEL TWB1G662, PASSIVE ENTRY SYSTEM (HAND UNIT):**

Hereby, ALPS ELECTRIC CO.,LTD., declares that the radio equipment type TWB1G662 is in compliance with Directive 2014/53/EU.

The full text of the EU declaration of conformity is available at the following internet address:

<https://www.alps.com/products/common/pdf/HandUnit/TWB1G662.pdf>

- Manufacturer name:  
ALPS ELECTRIC CO,LTD
- Importer name, Address:  
Nissan International SA  
Zone d'activités La Pièce 12  
1180 Rolle, Switzerland
- Operating frequency band: 433.92 MHz
- Maximum radio-frequency power: ≤ 10 dBm

**MODEL TWC1U326, PASSIVE ENTRY SYSTEM (TUNER):**

Hereby, ALPS ELECTRIC CO.,LTD., declares that the radio equipment type TWC1U326 is in compliance with Directive 2014/53/EU.

The full text of the EU declaration of conformity is available at the following internet address:

<https://www.alps.com/products/common/pdf/Tuner/TWC1U326.pdf>

- Manufacturer name:  
ALPS ELECTRIC CO,LTD
- Importer name, Address:  
Nissan International SA  
Zone d'activités La Pièce 12  
1180 Rolle, Switzerland
- Operating frequency band: 433.92 MHz
- Maximum radio-frequency power: ≤ 10 dBm

**MODEL TWB1U787, PASSIVE ENTRY SYSTEM (HAND UNIT):**

Hereby, ALPS ELECTRIC CO.,LTD., declares that the radio equipment type TWB1U787 is in compliance with Directive 2014/53/EU.

The full text of the EU declaration of conformity is available at the following internet address:

<https://www.alps.com/products/common/pdf/HandUnit/TWB1U785.pdf>

- Manufacturer name:  
ALPS ELECTRIC CO,LTD
- Importer name, Address:  
Nissan International SA  
Zone d'activités La Pièce 12  
1180 Rolle, Switzerland
- Operating frequency band: 433.92 MHz
- Maximum radio-frequency power: ≤ 10 dBm

**MODEL TWK1A002, ANT ASSY-IMMOBILISER:**

Hereby, ALPS ELECTRIC CO.,LTD., declares that the radio equipment type TWK1A002 is in compliance with Directive 2014/53/EU.

The full text of the EU declaration of conformity is available at the following internet address:

<https://www.alps.com/products/common/pdf/Immobilizer/TWK1A002.pdf>

- Manufacturer name:  
ALPS ELECTRIC CO,LTD
- Importer name, Address:  
Nissan International SA  
Zone d'activités La Pièce 12  
1180 Rolle, Switzerland
- Operating frequency band: 433.92 MHz
- Maximum radio-frequency power: ≤ 10 dBm



## FOR LIBYA

### Tire Pressure Monitoring System (TPMS) tuner

- Manufacturer name:  
ALPS ELECTRIC CO.,LTD.
- Registered trademark:  
**ALPS ELECTRIC CO., LTD.**
- Manufacturer address:  
6-3-36, Nakazato,  
Furukawa, Osaki-city,  
Miyagi-pref., JAPAN 989-6181
- Importer name, Address:  
ARATA International  
Ajman Free Zone, Ajman, UAE
- Operating frequency band: 433.92 MHz

Hereby, ALPS ELECTRIC CO., LTD., declares that the radio equipment type TWD1G791 is in compliance with Directive 2014/53/EU.

The full text of the EU declaration of conformity is available at the following internet address:

<http://www.alps.com/products/common/pdf/Tuner/TWD1G791.pdf>

### Intelligent Key system (if equipped)

#### **MODEL TWC1U326, PASSIVE ENTRY SYSTEM (TUNER):**

Hereby, ALPS ELECTRIC CO.,LTD., declares that the radio equipment type TWC1U326 is in compliance with Directive 2014/53/EU.

The full text of the EU declaration of conformity is available at the following internet address:

<https://www.alps.com/products/common/pdf/Tuner/TWC1U326.pdf>

- Manufacturer name:  
ALPS ELECTRIC CO,LTD

- Importer name, Address:  
ARATA International  
Ajman Free Zone, Ajman, UAE
  - Operating frequency band: 433.92 MHz
  - Maximum radio-frequency power: ≤ 10 dBm
- MODEL TWB1U787, PASSIVE ENTRY SYSTEM (HAND UNIT):**

Hereby, ALPS ELECTRIC CO.,LTD., declares that the radio equipment type TWB1U787 is in compliance with Directive 2014/53/EU.

The full text of the EU declaration of conformity is available at the following internet address:

<https://www.alps.com/products/common/pdf/HandUnit/TWB1U785.pdf>

- Manufacturer name:  
ALPS ELECTRIC CO,LTD
  - Importer name, Address:  
ARATA International  
Ajman Free Zone, Ajman, UAE
  - Operating frequency band: 433.92 MHz
  - Maximum radio-frequency power: ≤ 10 dBm
- MODEL TWK1A002, ANT ASSY-IMMOBILISER:**

Hereby, ALPS ELECTRIC CO.,LTD., declares that the radio equipment type TWK1A002 is in compliance with Directive 2014/53/EU.

The full text of the EU declaration of conformity is available at the following internet address:



<https://www.alps.com/products/common/pdf/Immobilizer/TWK1A002.pdf>

- Manufacturer name:  
ALPS ELECTRIC CO,LTD
- Importer name, Address:  
ARATA International  
Ajman Free Zone, Ajman, UAE

- Operating frequency band: 433.92 MHz
- Maximum radio-frequency power: ≤ 10 dBm

## FOR TAHITI

### Remote keyless entry system (if equipped)

<b>ALPS</b> <small>ALPS ELECTRIC CO., LTD. Engineering Headquarters 6-3-36, Nakazato, Furukawa, Osaki-city, Miyagi-pref. 989-6181, Japan Phone: +81 225 326111 Fax: +81 225 326112</small>	
<b>DECLARATION OF CONFORMITY</b>	
For	
	Product: keyless transmitter Model: TWB1U761 Type: Transmitter
Supplied by Alps Electric Co., Ltd	Technical Construction File held by Alps Electric Co., Ltd
6-3-36, Nakazato, Furukawa, Osaki-city, Miyagi-pref. JAPAN 989-6181	6-3-36, Nakazato, Furukawa, Osaki city, Miyagi-pref. JAPAN 989-6181
Notified Body - R&TTE Directive: N/A	
Standard used for comply EN 60955:2002 +Amd.1:2006+Amd.11:2008 -Amd.2:2010+ Amd.12:2011	
R&TTE Directive (Article 3.1(a) Safety)	EN 301 489-1 V1 9 2 2011-09
R&TTE Directive (Article 3.1(b) EMC)	EN 301 489-3 V1 4.1:2002-08
R&TTE Directive (Article 3.2 Spectrum)	EN 300 220-1 V2.4.1:2012-05 EN 300 220-2 V2.4.1:2012-05
Means of Conformity We declare under our sole responsibility that the Product (s) is conformity with the essential requirements and other relevant requirements of the Radio and Telecommunications Terminal Equipment (R&TTE) Directive (1999/5/EC).	
Date of Issue: August 9, 2013	
Signature of Responsible Person: 	
Tetsu Kinoshita Group Manager GROUP 2 ENGINEERING DEPT. M5	
JVT0382X	

## Intelligent Key system (if equipped)

<b>ALPS</b> ALPS ELECTRIC CO., LTD. <small>Engineer Headquarters 6-3-36, Nakazato, Furukawa, Osaka-city, Miyagi-pref. JAPAN 989-6181 Phone: +81 983-23-0111 Fax: +81 983-23-0129</small>	
<b>DECLARATION OF CONFORMITY</b>	
For	
<b>CE</b>	Product: Passive Entry System (Hand Use) Model: TWBEG662 Type: Transceiver
Supplied by Alps Electric Co., Ltd	Technical Construction File held by Alps Electric Co., Ltd
6-3-36, Nakazato, Furukawa, Osaka-city, Miyagi-pref. JAPAN 989-6181	6-3-36, Nakazato, Furukawa, Osaka-city, Miyagi-pref. JAPAN 989-6181
Notified Body - R&TTE Directorate N/A	
Standard used for conformity	
R&TTE Directive (Article 3.1(a) Safety)	EN60950-2:2002+Amd.1:2006+Amd.11:2008 +Amd.2:2010+Amd.12:2011
R&TTE Directive (Article 3.1(b) EMC)	EN 301 489-1 V1.9.2 2011-09 EN 301 489-3 V1.4.1 2007-08
R&TTE Directive (Article 3.2 Spectrum)	EN 300 330-1 V1.1 2010-02 EN 300 336-2 V1.5.1 2010-02 EN 300 228-1 V3.4.1 2012-05 EN 300 228-2 V2.4.1 2012-05
<p><b>Means of Conformity</b></p> <p>We declare under our sole responsibility that the Product (s) is conforming with the essential requirements and other relevant requirements of the Radio and Telecommunication Terminal Equipment (R&amp;TTE) Directive (1999/5/EC).</p>	
Date of issue: September 3, 2013	
Signature of Responsible Person:	Toru Kinoshita Group Manager GROUP 2 ENGINEERING DEPT. MS
<i>T. Kinoshita</i>	
JVT0384X	

<b>ALPS</b> ALPS ELECTRIC CO., LTD. <small>Engineer Headquarters 6-3-36, Nakazato, Furukawa, Osaka-city, Miyagi-pref. JAPAN 989-6181 Phone: +81 983-23-0111 Fax: +81 983-23-0129</small>	
<b>DECLARATION OF CONFORMITY</b>	
For	
<b>CE</b>	Product: Immobilizer Antenna Model: TWK1A002 Type: Transceiver
Supplied by Alps Electric Co., Ltd	Technical Construction File held by Alps Electric Co., Ltd
6-3-36, Nakazato, Furukawa, Osaka-city, Miyagi-pref. JAPAN 989-6181	6-3-36, Nakazato, Furukawa, Osaka-city, Miyagi-pref. JAPAN 989-6181
Notified Body - R&TTE Directorate N/A	
Standard used for conformity	
R&TTE Directive (Article 3.1(a) Safety)	EN60950-2:2002+Amd.1:2006+Amd.11:2008 +Amd.2:2010+Amd.12:2011
R&TTE Directive (Article 3.1(b) EMC)	EN 301 489-1 V1.9.2 2011-09 EN 301 489-3 V1.4.1 2007-08
R&TTE Directive (Article 3.2 Spectrum)	EN 300 330-1 V1.1 2010-02 EN 300 336-2 V1.5.1 2010-02
<p><b>Means of Conformity</b></p> <p>We declare under our sole responsibility that the Product (s) is conforming with the essential requirements and other relevant requirements of the Radio and Telecommunication Terminal Equipment (R&amp;TTE) Directive (1999/5/EC).</p>	
Date of issue: September 3, 2013	
Signature of Responsible Person:	Toru Kinoshita Group Manager GROUP 2 ENGINEERING DEPT. MS
<i>T. Kinoshita</i>	
JVT0386X	

## FOR NEW CALEDONIA

## Remote keyless entry system (if equipped)

<b>ALPS</b> ALPS ELECTRIC CO., LTD. <small>Engineer Headquarters 6-3-36, Nakazato, Furukawa, Osaka-city, Miyagi-pref. JAPAN 989-6181 Phone: +81 983-23-0111 Fax: +81 983-23-0129</small>	
<b>DECLARATION OF CONFORMITY</b>	
For	
<b>CE</b>	Product: TPMS/Keyless Tuner Model: TWC1G124 Type: Receiver
Supplied by Alps Electric Co., Ltd	Technical Construction File held by Alps Electric Co., Ltd
6-3-36, Nakazato, Furukawa, Osaka-city, Miyagi-pref. JAPAN 989-6181	6-3-36, Nakazato, Furukawa, Osaka-city, Miyagi-pref. JAPAN 989-6181
Notified Body - R&TTE Directorate N/A	
Standard used for conformity	
R&TTE Directive (Article 3.1(a) Safety)	EN 60950-2:2002+Amd.1:2006+Amd.11:2008 +Amd.2:2010+Amd.12:2011
R&TTE Directive (Article 3.1(b) EMC)	EN 301 489-1 V1.9.2 2011-09 EN 301 489-3 V1.4.1 2007-08
R&TTE Directive (Article 3.2 Spectrum)	EN 300 228-1 V2.4.1 2012-05 EN 300 228-2 V2.4.1 2012-05
<p><b>Means of Conformity</b></p> <p>We declare under our sole responsibility that the Product (s) is conforming with the essential requirements and other relevant requirements of the Radio and Telecommunication Terminal Equipment (R&amp;TTE) Directive (1999/5/EC).</p>	
Date of issue: August 9, 2013	
Signature of Responsible Person:	Toru Kinoshita Group Manager GROUP 2 ENGINEERING DEPT. MS
<i>T. Kinoshita</i>	
JVT0383X	

**DECLARATION OF CONFORMITY**  
 For



Product: keyless transmitter  
 Model: TWB1U761  
 Type: Transceiver

Supplied by  
 Alps Electric Co., Ltd

Technical Construction File held by  
 Alps Electric Co., Ltd

6-3-36, Nakazono, Fushikawa, Osaka-city,  
 Miyagi-pref. JAPAN 989-6181

6-3-36, Nakazono, Fushikawa, Osaka-city,  
 Miyagi-pref. JAPAN 989-6181

Notified Body - R&TTE Directive

N/A

Standard used for comply  
 EN 60955:2002+Amd.1:2006+Amd.11:2008  
 -Amd.2:2010+Amd.12:2011

R&TTE Directive  
 (Article 3.1(a) Safety)

EN 301 489-1 V1.9.2:2011-09  
 EN 301 489-3 V1.4.1:2002-08

R&TTE Directive  
 (Article 3.1(b) EMC)

R&TTE Directive  
 (Article 3.2 Spectrum)

EN 300 220-1 V2.4.1:2012-05  
 EN 300 220-2 V2.4.1:2012-05

We declare under our sole responsibility that the Product (a) is conformity with the essential requirements and other relevant requirements of the Radio and Telecommunication Terminal Equipment (R&TTE) Directive (1999/5/EC).

Date of Issue: August 9, 2013

Signature of Responsible Person:

Toru Kinoshita  
 Group Manager  
 GROUP 2 ENGINEERING DEPT. MS

*T. Kinoshita*

JVT0382X

Intelligent Key system (if equipped)

**DECLARATION OF CONFORMITY**  
 For



Product: Passive Entry System (Hand Use)  
 Model: TWB1G662  
 Type: Transceiver

Supplied by  
 Alps Electric Co., Ltd

Technical Construction File held by  
 Alps Electric Co., Ltd

6-3-36, Nakazono, Fushikawa, Osaka-city,  
 Miyagi-pref. JAPAN 989-6181

6-3-36, Nakazono, Fushikawa, Osaka-city,  
 Miyagi-pref. JAPAN 989-6181

Notified Body - R&TTE Directive

N/A

Standard used for comply  
 EN60955:2002+Amd.1:2006+Amd.11:2008  
 +Amd.2:2010+Amd.12:2011

R&TTE Directive  
 (Article 3.1(a) Safety)

R&TTE Directive  
 (Article 3.1(b) EMC)

R&TTE Directive  
 (Article 3.2 Spectrum)

EN 301 489-1 V1.9.2:2011-09  
 EN 301 489-3 V1.4.1:2002-08

EN 300 330-1 V1.1.1:2010-02  
 EN 300 330-2 V1.1.1:2010-02  
 EN 300 220-1 V2.4.1:2012-05  
 EN 300 220-2 V2.4.1:2012-05

We declare under our sole responsibility that the Product (a) is conformity with the essential requirements and other relevant requirements of the Radio and Telecommunication Terminal Equipment (R&TTE) Directive (1999/5/EC).

Date of Issue: September 3, 2013

Signature of Responsible Person:

Toru Kinoshita  
 Group Manager  
 GROUP 2 ENGINEERING DEPT. MS

*T. Kinoshita*

JVT0384X

**DECLARATION OF CONFORMITY**  
 For



Product: Passive Entry System (Timer)  
 Model: TWC1G135  
 Type: Receiver

Supplied by  
 Alps Electric Co., Ltd

Technical Construction File held by  
 Alps Electric Co., Ltd

6-3-36, Nakazono, Fushikawa, Osaka-city,  
 Miyagi-pref. JAPAN 989-6181

6-3-36, Nakazono, Fushikawa, Osaka-city,  
 Miyagi-pref. JAPAN 989-6181

Notified Body - R&TTE Directive

N/A

Standard used for comply  
 EN60955:2002+Amd.1:2006+Amd.11:2008  
 +Amd.2:2010+Amd.12:2011

R&TTE Directive  
 (Article 3.1(a) Safety)

R&TTE Directive  
 (Article 3.1(b) EMC)

R&TTE Directive  
 (Article 3.2 Spectrum)

EN 301 489-1 V1.8.2:2011-09  
 EN 301 489-3 V1.4.1:2002-08

EN 300 220-1 V2.4.1:2012-05  
 EN 300 220-2 V2.4.1:2012-05

We declare under our sole responsibility that the Product (a) is conformity with the essential requirements and other relevant requirements of the Radio and Telecommunication Terminal Equipment (R&TTE) Directive (1999/5/EC).

Date of Issue: September 3, 2013

Signature of Responsible Person:

Toru Kinoshita  
 Group Manager  
 GROUP 2 ENGINEERING DEPT. MS

*T. Kinoshita*

JVT0385X

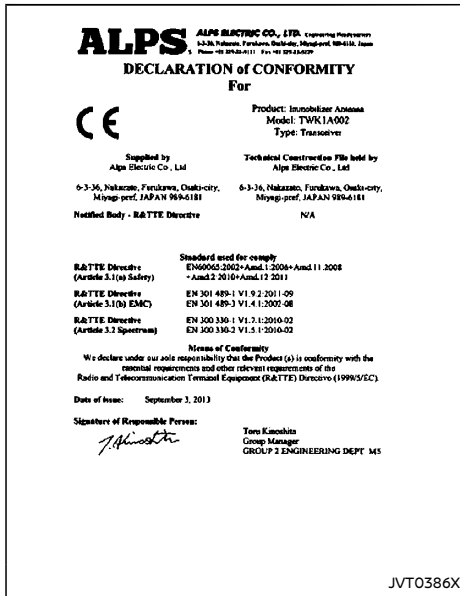

**FOR WESTERN SAMOA**

Remote keyless entry system (if equipped)

**Approval No.**

T-280/13

T-318/13

Intelligent Key system (if equipped)

**Approval No.**

T-319/13

T-320/13

T-279/13

**FOR THAILAND**

This telecommunication equipment is in compliance with NTC requirements.

- Intelligent Key system
- NISSAN Anti-Theft System (NATS)

**FOR SOUTH AFRICA**

Tire Pressure Monitoring System (TPMS) sensor



Tire Pressure Monitoring System (TPMS) tuner



Remote keyless entry system (if equipped)





Intelligent Key system (if equipped)



FOR BENIN

Intelligent Key system (if equipped)



## FOR COMOROS

### Intelligent Key system (if equipped)

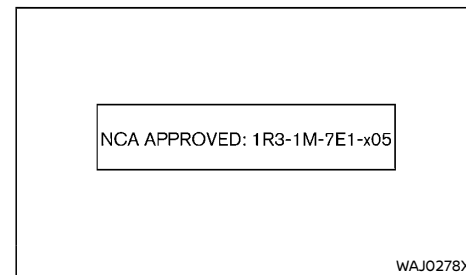

## FOR GHANA

### Intelligent Key system (if equipped)



FOR NIGERIA

Intelligent Key system (if equipped)

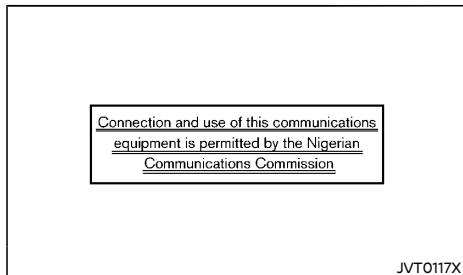

**TWB1G662 (285E3 1KA9D)**

**TWC1G135 (28595 4JW0B/28596 1FE0A)**

**TWK1A002 (28590 1FA1A)**

FOR ZAMBIA

Remote keyless entry system (if equipped)



Intelligent Key system (if equipped)



## FOR WEST SAHARA

### Intelligent Key system (if equipped)



## FOR ABU DHABI

### Intelligent Key system (if equipped)

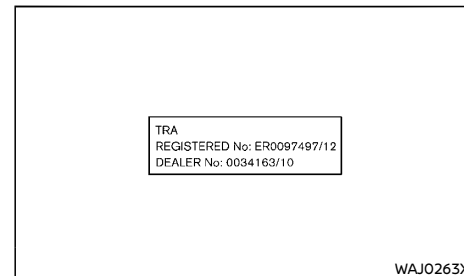
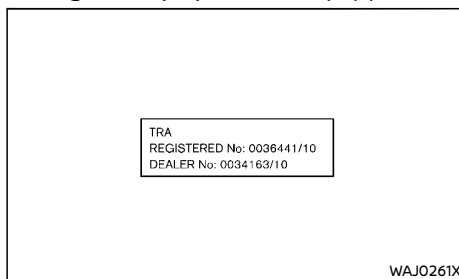

## FOR CENTRAL AFRICA

### Intelligent Key system (if equipped)

#### **MODEL TWC1G135, PASSIVE ENTRY SYSTEM (TUNER):**

Hereby, ALPS ELECTRIC CO.,LTD., declares that the radio equipment type TWC1G135 is in compliance with Directive 2014/53/EU.

The full text of the EU declaration of conformity is available at the following internet address:

<https://www.alps.com/products/common/pdf/Tuner/TWC1G135.pdf>



- Manufacturer name:  
ALPS ELECTRIC CO,LTD
- Importer name, Address:  
Autostar Rca  
Avenue des Martyrs  
Bangui - CENTRAL AFRICAN REP.  
BP1042
- Operating frequency band: 433.92 MHz
- Maximum radio-frequency power: ≤ 10 dBm

**MODEL TWB1G662, PASSIVE ENTRY SYSTEM (HAND UNIT):**

Hereby, ALPS ELECTRIC CO.,LTD., declares that the radio equipment type TWB1G662 is in compliance with Directive 2014/53/EU.

The full text of the EU declaration of conformity is available at the following internet address:

<https://www.alps.com/products/common/pdf/HandUnit/TWB1G662.pdf>

- Manufacturer name:  
ALPS ELECTRIC CO,LTD
- Importer name, Address:  
Autostar Rca  
Avenue des Martyrs  
Bangui - CENTRAL AFRICAN REP.  
BP1042
- Operating frequency band: 433.92 MHz
- Maximum radio-frequency power: ≤ 10 dBm

**MODEL TWK1A002, ANT ASSY-IMMOBILISER:**

Hereby, ALPS ELECTRIC CO.,LTD., declares that the radio equipment type TWK1A002 is in compliance with Directive 2014/53/EU.

The full text of the EU declaration of conformity is available at the following internet address:

<https://www.alps.com/products/common/pdf/Immobilizer/TWK1A002.pdf>

- Manufacturer name:  
ALPS ELECTRIC CO,LTD
- Importer name, Address:  
Autostar Rca  
Avenue des Martyrs  
Bangui - CENTRAL AFRICAN REP.  
BP1042
- Operating frequency band: 433.92 MHz
- Maximum radio-frequency power: ≤ 10 dBm

**FOR GUINEA BISSAU**

Intelligent Key system (if equipped)

**MODEL TWC1G135, PASSIVE ENTRY SYSTEM (TUNER):**

Hereby, ALPS ELECTRIC CO.,LTD., declares that the radio equipment type TWC1G135 is in compliance with Directive 2014/53/EU.

The full text of the EU declaration of conformity is available at the following internet address:

<https://www.alps.com/products/common/pdf/Tuner/TWC1G135.pdf>

- Manufacturer name:  
ALPS ELECTRIC CO,LTD
- Importer name, Address:  
MAVEGRO TRADING  
Rua Eduardo Mondlane  
Bissau, Guinea-Bissau
- Operating frequency band: 433.92 MHz
- Maximum radio-frequency power: ≤ 10 dBm

**MODEL TWB1G662, PASSIVE ENTRY SYSTEM (HAND UNIT):**

Hereby, ALPS ELECTRIC CO.,LTD., declares that the radio equipment type TWB1G662 is in compliance with Directive 2014/53/EU.

The full text of the EU declaration of conformity is available at the following internet address:

<https://www.alps.com/products/common/pdf/HandUnit/TWB1G662.pdf>

- Manufacturer name:  
ALPS ELECTRIC CO,LTD
- Importer name, Address:  
MAVEGRO TRADING  
Rua Eduardo Mondlane  
Bissau, Guinea-Bissau
- Operating frequency band: 433.92 MHz
- Maximum radio-frequency power: ≤ 10 dBm

**MODEL TWK1A002, ANT ASSY-IMMOBILISER:**

Hereby, ALPS ELECTRIC CO.,LTD., declares that the radio equipment type TWK1A002 is in compliance with Directive 2014/53/EU.

The full text of the EU declaration of conformity is available at the following internet address:

<https://www.alps.com/products/common/pdf/Immobilizer/TWK1A002.pdf>

- Manufacturer name:  
ALPS ELECTRIC CO,LTD
- Importer name, Address:  
MAVEGRO TRADING  
Rua Eduardo Mondlane  
Bissau, Guinea-Bissau
- Operating frequency band: 433.92 MHz
- Maximum radio-frequency power: ≤ 10 dBm

## FOR SAO TOME PRINCIPE

Intelligent Key system (if equipped)

### **MODEL TWC1G135, PASSIVE ENTRY SYSTEM (TUNER):**

Hereby, ALPS ELECTRIC CO.,LTD., declares that the radio equipment type TWC1G135 is in compliance with Directive 2014/53/EU.

The full text of the EU declaration of conformity is available at the following internet address:

<https://www.alps.com/products/common/pdf/Tuner/TWC1G135.pdf>

- Manufacturer name:  
ALPS ELECTRIC CO.,LTD
- Operating frequency band: 433.92 MHz
- Maximum radio-frequency power:  $\leq 10$  dBm

### **MODEL TWB1G662, PASSIVE ENTRY SYSTEM (HAND UNIT):**

Hereby, ALPS ELECTRIC CO.,LTD., declares that the radio equipment type TWB1G662 is in compliance with Directive 2014/53/EU.

The full text of the EU declaration of conformity is available at the following internet address:

<https://www.alps.com/products/common/pdf/HandUnit/TWB1G662.pdf>

- Manufacturer name:  
ALPS ELECTRIC CO.,LTD
- Operating frequency band: 433.92 MHz
- Maximum radio-frequency power:  $\leq 10$  dBm

### **MODEL TWK1A002, ANT ASSY-IMMOBILISER:**

Hereby, ALPS ELECTRIC CO.,LTD., declares that the radio equipment type TWK1A002 is in compliance with Directive 2014/53/EU.

The full text of the EU declaration of conformity is available at the following internet address:

<https://www.alps.com/products/common/>

[pdf/Immobilizer/TWK1A002.pdf](https://www.alps.com/products/common/pdf/Immobilizer/TWK1A002.pdf)

- Manufacturer name:  
ALPS ELECTRIC CO.,LTD
- Operating frequency band: 433.92 MHz
- Maximum radio-frequency power:  $\leq 10$  dBm

## OTHER RADIO APPROVAL INFORMATION

**MEMO**

**MEMO**

**MEMO**

# 10 Index

## A

ABS (Anti-lock Braking System).....	5-84
Air bag system	
Supplemental curtain side-impact air bag system.....	1-29, 1-34
Supplemental front-impact air bag system.....	1-29, 1-34
Supplemental side-impact air bag system.....	1-29, 1-34
Air conditioner	
Air conditioner operation.....	4-22
Air conditioner service.....	4-27
Air conditioner specification label.....	9-10
Air conditioning system refrigerant and lubricant recommendations.....	4-27
Antenna.....	4-46
Anti-lock Braking System (ABS).....	5-84
Anti-lock braking system (ABS) warning light.....	2-13
Appearance care	
Exterior appearance care.....	7-2
Interior appearance care.....	7-4
Armrest.....	1-8
Audible reminders.....	2-19
Audio operation precautions.....	4-27
Audio system.....	4-27
Audio control steering switch.....	4-40
FM-AM radio with Compact Disc (CD) player.....	4-33
Auto door lock releasing mechanism.....	3-5
Automatic air conditioner.....	4-25
Automatic emergency call.....	1-38
AUX device player operation.....	4-38
Auxiliary input jack.....	4-39
Average speed.....	2-34

## B

Back door.....	3-19
Battery.....	8-5, 8-22
Battery saver system.....	2-38, 2-51
Intelligent Key battery.....	8-25
Intelligent Key battery replacement.....	8-25
Remote controller battery.....	8-23
Remote controller battery replacement.....	8-23
Variable voltage control system.....	8-26
Bleeding the fuel system.....	8-15
Blind Spot Warning (BSW).....	5-34
Bluetooth® audio player operation.....	4-37
Bluetooth® Hands-Free Phone System.....	4-47
Brake	
Anti-lock Braking System (ABS).....	5-84
Brake assist.....	5-84
Brake booster.....	8-17
Brake fluid.....	8-17
Brake system.....	5-84
Electronic parking brake system warning light.....	2-14
Parking brake.....	3-28, 5-86
Parking brake check.....	8-16
Press brake pedal warning (for electronic parking brake equipped models).....	2-32
Warning light.....	2-14
Break-in schedule.....	5-4
Brightness control	
Instrument panel.....	2-11
Bulb check/instrument panel.....	2-13
Bulb replacement.....	8-3, 8-29

## C

Camera aiding parking sensor (sonar) function.....	4-17
Card holder.....	2-49

Cargo light.....	2-51
Catalytic converter, Three way catalyst.....	5-5
CD player operation.....	4-35
CD/USB memory care and cleaning.....	4-39
Certification label.....	9-9
Child restraint installation using ISOFIX.....	1-23
Child restraint installation using three-point type seat belt.....	1-25
Child restraints.....	1-16
Universal child restraints for front seat and rear seats.....	1-18
Child safety.....	1-13
Child safety rear door lock.....	3-5
Chimes, Audible reminders.....	2-19
Circuit breaker, Fusible link.....	8-27
Cleaning exterior and interior.....	7-2, 7-4
Clock.....	2-36
Clutch	
Clutch fluid.....	8-18
Cockpit.....	2-3
Cold weather driving.....	5-86
Console box.....	2-47
Console light.....	2-50
Coolant	
Changing engine coolant.....	8-9
Checking engine coolant level.....	8-9
Corrosion protection.....	7-5
Cruise control.....	5-45
Fixed speed cruise control (on ICC system).....	5-58
Intelligent Cruise Control (ICC).....	5-47
Cup holders.....	2-48

## D

Daytime running light system.....	2-38
Defogger switch.....	2-42
Dimensions.....	9-8

Display	
Vehicle information display (model with color display).....	2-21
Vehicle information display (model without color display).....	2-20
Door open warning light.....	2-14
Draining water.....	8-14
Drive belt.....	8-15
Drive Mode.....	5-25
Driving	
Cold weather driving.....	5-86
On-pavement and off-road driving.....	5-8
Precautions when starting and driving.....	5-4
Safety precautions.....	5-8

## E

eCall/SOS system.....	1-38
ECO drive report.....	5-76
ECO mode.....	5-26
Economy, Fuel.....	5-77
Elapsed time and trip odometer.....	2-34
Emergency services call.....	1-38
Engine	
Break-in schedule.....	5-4
Changing engine coolant.....	8-9
Checking engine coolant level.....	8-9
Checking engine oil level.....	8-10
Coolant temperature gauge.....	2-9
Engine compartment check locations.....	8-6
Engine cooling system.....	8-8
Engine oil.....	8-10
Engine serial number.....	9-10
Engine specifications.....	9-6
Engine start operation indicator.....	2-29
Fuel filter.....	8-14
If your vehicle overheats.....	6-11
Remote engine start.....	3-16
Exhaust gas (carbon monoxide).....	5-5

## F

Flat tire.....	6-2
Flexible seating.....	1-8
Floor mat cleaning.....	7-4
Fluid	
Brake fluid.....	8-17
Clutch fluid.....	8-18
Engine coolant.....	8-8
Engine oil.....	8-10
Power steering fluid.....	8-19
Window washer fluid.....	8-5, 8-21
FM-AM radio with Compact Disc (CD) player.....	4-33
Fog light switch.....	2-39
Front seat, Front seat adjustment.....	1-2
Fuel	
Bleeding the fuel system.....	8-15
Fuel economy.....	5-77
Fuel filter.....	8-14
Fuel-filler cap.....	3-21
Gauge.....	2-10
Fuel Efficiency and Carbon Dioxide Reduction driving tips.....	5-77
Fuel information.....	9-4
Fuel-filler lid.....	3-21
Fuses.....	8-26
Fusible links.....	8-27

## G

Gauge.....	2-7
Engine coolant temperature gauge.....	2-9
Fuel gauge.....	2-10
Odometer.....	2-9
Speedometer.....	2-9
Tachometer.....	2-9
Trip computer (models without color display).....	2-20
General maintenance.....	8-3

Glove box.....	2-47
----------------	------

## H

Hands-Free Phone System.....	4-47
Head restraints.....	1-9
Headlight warning light.....	2-15
Headlights	
Automatic aiming control.....	2-38
Bulb replacement.....	8-29
Headlight switch.....	2-36
Heater.....	4-22
Hill descent control system.....	5-28
Hill start assist system.....	5-29
Hood release.....	3-18
Horn.....	2-43

## I

Ignition switch.....	5-10
Ignition switch (Push-button).....	5-11
Impact sensing door lock releasing mechanism.....	3-5
Indicator light	
Electronic parking brake indicator light.....	2-18
Indicator lights.....	2-18
Indicators	
Vehicle information display (model with color display).....	2-21
Vehicle information display (model without color display).....	2-20
Instrument brightness control.....	2-11
Instrument panel.....	2-5
Intelligent Around View Monitor.....	4-9
Intelligent Cruise Control (ICC).....	5-47
Intelligent Driver Alertness.....	5-74
Intelligent Emergency Braking.....	5-61
Intelligent Emergency Braking system warning light.....	2-15



Intelligent Forward Collision Warning system.....	5-68
Intelligent Key.....	3-2
Intelligent Key battery.....	8-25
Intelligent Key system.....	3-7
Key operating range.....	3-8
Intelligent Rear View Mirror.....	3-22
Interior light switch.....	2-50
Interior lights.....	2-50
iPod player operation.....	4-37
ISOFIX child restraint system.....	1-22

## J

Jump starting.....	6-7
--------------------	-----

## K

Key	
Intelligent Key.....	3-2
NISSAN Anti-Theft System (NATS*) key.....	3-2
Keys.....	3-2
For Intelligent Key system.....	3-7

## L

Labels	
Air conditioner specification label.....	9-10
Engine serial number.....	9-10
Vehicle Identification Number (VIN).....	9-9
Lane Departure Warning (LDW).....	5-30
Light	
Bulb replacement.....	8-3, 8-29
Fog light switch.....	2-39
Headlight switch.....	2-36
Headlights bulb replacement.....	8-29
Indicator lights.....	2-18
Interior lights.....	2-50
Map lights.....	2-51
Rear personal light.....	2-51

Replacement.....	8-3, 8-29
Warning/indicator lights and audible reminders.....	2-13
Lock	
Back door lock.....	3-19
Low fuel warning.....	2-29
Low fuel warning light.....	2-15
Low Tire Pressure warning.....	2-31
Low tire pressure warning light.....	2-15
Low tire pressure warning system.....	5-5
Luggage floor box.....	2-49
Luggage hooks.....	2-49

## M

Maintenance	
Battery.....	8-5, 8-22
General maintenance.....	8-3
Maintenance precautions.....	8-5
Maintenance requirements.....	8-3
Seat belt maintenance.....	1-16
Malfunction Indicator Light (MIL).....	2-18
Manual air conditioner and heater.....	4-23
Manual eCall.....	1-39
Map lights.....	2-51
Master warning light.....	2-17
Maximum load limits.....	5-82
Mechanical key (Intelligent Key system).....	3-3
Mechanical key (NISSAN Anti-Theft System).....	3-2
Meter	
Trip computer (models without color display).....	2-20
Meters and gauges.....	2-7
Instrument brightness control.....	2-11
Mirror	
Intelligent Rear View Mirror.....	3-22
Mirror, Vanity mirror.....	3-27
Moving Object Detection (MOD).....	4-19

## N

New vehicle break-in.....	5-4
NISSAN Anti-Theft System (NATS*) key.....	3-2
NissanConnect Owner's Manual.....	4-3

## O

Odometer.....	2-9
Odometer (models with color display).....	2-9
Odometer (models without color display).....	2-9
Oil	
Checking engine oil level.....	8-10
Engine oil.....	8-10
Oil control system.....	2-35
Operating precautions.....	5-82
Outside air temperature.....	2-20, 2-36
Overheat, If your vehicle overheats.....	6-11

## P

Panic alarm.....	3-13
Parking brake.....	3-28, 5-86
Electronic parking brake indicator light.....	2-18
Parking sensor (sonar) system.....	5-79
Phone	
Bluetooth® Hands-Free Phone System.....	4-47
Power	
Power outlet.....	2-44
Power steering fluid.....	8-19
Power windows.....	2-43
Pre-tensioner seat belt system.....	1-32, 1-37
Precautions	
Audio operation.....	4-27
Cruise control.....	5-46
Driving safety.....	5-8
Maintenance.....	8-5
On-pavement and off-road driving.....	5-8

Seat belt usage.....	1-11
When starting and driving.....	5-4
Push starting.....	6-11
Push-button ignition switch.....	5-11

## R

Radio operation.....	4-35
Rear cooler.....	4-26
Rear Cross Traffic Alert (RCTA).....	5-40
Rear differential locking system.....	5-26
Rear door lock, Child safety rear door lock.....	3-5
Rear Entertainment System.....	4-40
Rear fog light.....	2-39
Rear personal light.....	2-51
Rear seat roof ventilators.....	4-21
Rear ventilators.....	4-21
Rear view monitor.....	4-3
Rear window wiper and washer switch.....	2-41
Remote controller battery.....	8-23
Remote engine start.....	3-16
Remote keyless entry system.....	3-6
Roof, Roof rack.....	2-49

## S

Safety chains.....	5-83
Safety, Child seat belts.....	1-13
SAND mode.....	5-26
Seat	
ISOFIX child restraint system.....	1-22
Seat adjustment, Front seats.....	1-2
Seat belt	
Child restraint installation using three-point type seat belt.....	1-25
Seat belt(s)	
Child safety.....	1-13
Injured persons.....	1-14
Pre-tensioner seat belt system.....	1-32, 1-37

Precautions on seat belt usage.....	1-11
Pregnant women.....	1-13
Seat belt cleaning.....	7-5
Seat belt maintenance.....	1-16
Seat belt warning light.....	2-17
Seat belts.....	1-11
Shoulder belt height adjustment.....	1-14
Seat(s)	
Seats.....	1-2
Second row seats.....	1-5
Third row seats.....	1-6
Shift lever	
Shift lock release.....	5-17
Shift lock release	
Transmission.....	5-17
Shoulder belt height adjustment.....	1-14
SOS call switch.....	1-39
Spare tire.....	8-35
Spark plugs.....	8-16
Speedometer.....	2-9
SPORT mode.....	5-26
SRS air bag deployment conditions.....	1-34
STANDARD mode.....	5-26
Starting	
Jump starting.....	6-7
Precautions when starting and driving.....	5-4
Push starting.....	6-11
Steering	
Audio control steering switch.....	4-40
Power steering fluid.....	8-19
Steering lock.....	5-12
Steering lock release malfunction indicator.....	2-29
Tilting steering wheel.....	3-21
Sun visors.....	2-50
Sunglasses holder.....	2-47
Supplemental air bag systems	
Supplemental curtain side-impact air bag system.....	1-34
Supplemental front-impact air bag system.....	1-34

Supplemental side-impact air bag system.....	1-34
Supplemental curtain side-impact air bag system.....	1-29
Supplemental front-impact air bag system.....	1-29
Supplemental side-impact air bag system.....	1-29
Switch	
Fog light switch.....	2-39
Headlight switch.....	2-36
Ignition switch.....	5-10
Power door lock switch.....	3-4
Turn signal switch.....	2-38

## T

Tachometer.....	2-9
Technical characteristics.....	9-7
Temperature gauge, Engine coolant temperature gauge.....	2-9
Three-way catalyst.....	5-5
Tilting steering wheel.....	3-21
Tire recommendation for 4WD.....	5-24
Tires	
Flat tire.....	6-2
Low tire pressure warning light.....	2-15
Low tire pressure warning system.....	5-5
Tire chains.....	8-33
Tire pressure.....	5-83
Tire Pressure Monitoring System (TPMS).....	5-5, 6-2, 8-32
Tire rotation.....	8-4, 8-34
Types of tires.....	8-33
Uniform tire quality grading.....	9-11
Towing, Tow truck towing.....	6-12
TPMS resetting.....	5-7
TPMS, Tire Pressure Monitoring System.....	5-5
Trailer towing.....	5-82
Transmission, Transmission shift lever lock release.....	5-17

Trip computer (models with color display).....	2-33
Trip computer (models without color display).....	2-20
Turbocharger system.....	5-8
Turn signal switch.....	2-38

## U

Underbody cleaning.....	7-3
Uniform tire quality grading.....	9-11
USB (Universal Serial Bus) charging connector.....	2-45
USB (Universal Serial Bus) connection port.....	4-38
USB memory device operation.....	4-36
Using remote keyless entry system.....	3-6

## V

Vanity mirror.....	3-27
Vanity mirror light.....	2-51
Variable voltage control system.....	8-26
Vehicle	
Dimensions.....	9-8
Identification Number (VIN).....	9-9
Vehicle dynamic control (VDC) system.....	5-27
Vehicle information display	
Vehicle information display warnings and indicators.....	2-27
Vehicle information display (models with color display).....	2-21
How to use the vehicle information display.....	2-21
Settings.....	2-22
Startup display.....	2-22
Vehicle information display (models without color display).....	2-20
Vehicle speed.....	2-34

Vehicle speed sensing door lock mechanism.....	3-5
--	-----

## W

Warning	
4WD warning.....	5-23
Intelligent Forward Collision Warning system.....	5-68
Lights.....	2-13
Low Tire Pressure warning.....	2-31
Tire Pressure Monitoring System (TPMS).....	5-5, 6-2
Vehicle information display (models with color display).....	2-21
Vehicle information display (models without color display).....	2-20
Warning lights, indicator lights and audible reminders.....	2-12
Warning light	
Anti-lock braking system (ABS) warning light.....	2-13
Brake warning light (red).....	2-14
Door open warning light.....	2-14
Electronic parking brake system warning light.....	2-14
Headlight warning light.....	2-15
Low fuel warning light.....	2-15
Low tire pressure warning light.....	2-15
Seat belt warning light.....	2-17
Washer switch	
Rear window wiper and washer switch.....	2-41
Washer switch, Windshield wiper and washer switch.....	2-40
Washing.....	7-2
Waxing.....	7-2
Welcome light and farewell light function.....	3-9
Wheels and tires	
Care of wheels.....	7-3
Cleaning aluminum alloy wheels.....	7-3

Tires and wheels.....	8-32, 9-8
Window washer fluid.....	8-5, 8-21
Window(s)	
Cleaning.....	7-3, 7-4
Power windows.....	2-43
Windshield wiper and washer switch.....	2-40
Wiper	
Rear window wiper and washer switch.....	2-41
Rear window wiper blade.....	8-21
Windshield wiper and washer switch.....	2-40
Wiper blades.....	8-20
Wireless charger.....	2-46

## GAS STATION INFORMATION

### FUEL INFORMATION

Gasoline engine (model with three-way catalyst)



#### CAUTION:

**Do not use leaded gasoline. Using leaded gasoline will damage the three-way catalyst.**

Use UNLEADED REGULAR gasoline with an octane rating of at least 91 (RON).

Diesel engine\*

#### YD25DDTi engine:

Diesel fuel above 50 cetane must be used.

#### YS23DDTT engine:

Diesel fuel above 50 cetane and with a maximum of 50 ppm of sulfur (EN590) must be used.

For Thailand:

This vehicle is able to be used with diesel fuel (B20), which is defined fuel specification and quality in the Notification of Department of Energy Business. However, more frequent fuel filter replacement is necessary. For details, see the separate maintenance booklet.

- \* If two types of diesel fuel are available, use summer or winter fuel properly according to the following temperature conditions.
- Above  $-7^{\circ}\text{C}$  ( $20^{\circ}\text{F}$ ) ... Summer type diesel fuel.
- Below  $-7^{\circ}\text{C}$  ( $20^{\circ}\text{F}$ ) ... Winter type diesel fuel.



#### CAUTION:

- **Do not use home heating oil, gasoline or other alternate fuels in your diesel engine. The use of those or adding those to diesel fuel can cause engine damage.**
- **Do not use summer fuel at temperatures below  $-7^{\circ}\text{C}$  ( $20^{\circ}\text{F}$ ). The cold temperatures will cause wax to form in the fuel. As a result, it may prevent the engine from running smoothly.**

#### RECOMMENDED ENGINE OIL

See "Recommended fluids/lubricants and capacities" (P.9-2).

#### TIRE COLD PRESSURE

See the tire placard affixed to the driver's side center pillar.

## QUICK REFERENCE

- In case of emergency ... 6-1  
(Flat tire, engine will not start, overheating, towing)
- How to start the engine ... 5-1
- How to read the meters and gauges ... 2-1
- Maintenance and do-it-yourself ... 8-1
- Technical information ... 9-1