

FOREWORD

Thank you for purchasing a NISSAN vehicle.

This user's manual is for NissanConnect System offered in your NISSAN vehicle.

Operation instructions for the following systems are included in this manual.

- Audio
- Hands-free phone
- Apple CarPlay
- Android Auto
- NissanConnect Services
- Navigation
- Voice recognition
- Information and settings viewable on NissanConnect

Please read this manual carefully to ensure safe operation of NissanConnect System.

- Because of possible specification changes and optional equipment, some sections of this manual may not apply to your vehicle.
- All information, specifications and illustrations in this manual are those in effect at the time of printing. NISSAN reserves the right to change specifications or design at any time without notice.

- Do not remove this manual from the vehicle when selling this vehicle. The next user of the system may need the manual.

© 2021 NISSAN MOTOR CO., LTD.

Contents

Introduction	1
Getting started	2
Audio system	3
Hands-Free Phone	4
Information	5
Navigation (if equipped)	6
Voice recognition (if equipped)	7
Troubleshooting guide	8
Index	9

1 Introduction

How to use this manual	1-2	Trademarks	1-5
For safe operation	1-2	Legal disclaimer for NissanConnect Services (for Mexico)	1-6
Reference symbols	1-2	Licenses	1-7
Screen illustrations	1-2	Software Licenses	1-7
Terms displayed on screen	1-2	Telematic Control Unit (if equipped)	1-7
Safety information	1-3		
Regulatory information	1-4		
Radio approval number and information	1-4		

HOW TO USE THIS MANUAL

This manual uses special words, symbols, icons and illustrations organized by function.

Please refer to the following items and familiarize yourself with them.

FOR SAFE OPERATION



WARNING:

This is used to indicate the presence of a hazard that could cause death or serious personal injury. To avoid or reduce the risk, the procedures must be followed precisely.



CAUTION:

This is used to indicate the presence of a hazard that could cause minor or moderate personal injury or damage to your vehicle. To avoid or reduce the risk, the procedures must be followed carefully.



NOTE:

Indicates items that help you understand and maximize the performance of your vehicle. If ignored, they may lead to a malfunction or poor performance.

REFERENCE SYMBOLS



INFO:

This indicates information that is necessary for efficient use of your vehicle or accessories.



Reference page:

This indicates the title and page that you should refer to.

< >:

This indicates a button on the control panel or the steering wheel.

[]:

This indicates a key/item displayed on the screen.

SCREEN ILLUSTRATIONS

- The illustrations in this manual are representatives of various models and may not be identical with the design and specifications of your vehicle.
- Icons and menu items displayed on the screen may be abbreviated or omitted from the screen illustrations when appropriate. The omitted icons and menu items are described as dotted lines as illustrated.

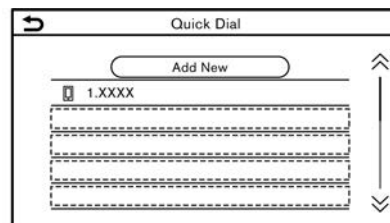

TERMS DISPLAYED ON SCREEN

In this manual, some menu items may be spelled or termed differently from those displayed on your screen depending on models, markets or software versions.

SAFETY INFORMATION

This system is primarily designed to help you support pleasant driving as outlined in this manual. However, you, the driver, must use the system safely and properly. Information and the availability of services may not always be up to date. The system is not a substitute for safe, proper and legal driving.

Before using the system, please read the following safety information. Always use the system as outlined in this manual.



WARNING:

- To operate the system, first park the vehicle in a safe location and set the parking brake. Operating the system while driving can distract the driver and may result in a serious accident.
- Exercise extreme caution at all times so full attention may be given to vehicle operation. If the system does not respond immediately, please be patient and keep your eyes on the road. Inattentive driving may lead to a crash resulting in serious injuries or death.
- Do not rely on route guidance (if equipped) alone. Always be sure that all driving maneuvers are legal and safe in order to avoid accidents.
- Do not disassemble or modify this system. If you do, it may result in accidents, fire or electrical shock.

- If you notice any foreign objects in the system hardware, spill liquid on the system or notice smoke or a smell coming from it, stop using the system immediately and it is recommended you contact a NISSAN dealer. Ignoring such conditions may lead to accidents, fire or electrical shock.



CAUTION:

- Some jurisdictions may have laws limiting the use of video screens while driving. Use this system only where it is legal to do so.
- Extreme temperature conditions [below -20°C (-4°F) and above 70°C (158°F)] could affect the performance of the system.
- The display screen may break if it is hit with a hard or sharp object. If the display screen breaks, do not touch it. Doing so could result in an injury.



NOTE:

Do not keep the system running with the engine stopped. Doing so may discharge the vehicle battery. When you use the system, always keep the engine running.

Models with NissanConnect Services:

NissanConnect Services may not be available in some regions. Completing the NissanConnect Services registration is necessary to use NissanConnect Services related functions.

REGULATORY INFORMATION

RADIO APPROVAL NUMBER AND INFORMATION

For the Middle East and Europe

Hereby, Robert Bosch GmbH declares that the radio equipment type AIVIP33A0 is in compliance with Directive 2014/53/EU.

The full text of the EU declaration of conformity is available at the following internet address:

<https://eu-doc.bosch.com>



Frequency Band

2400 MHz - 2480 MHz

5490 MHz - 5600 MHz

Radiated Power [EIRP]

Bluetooth < 10 mW

WLAN < 100 mW

Hints/Restrictions

Internal Antenna

Internal antenna not accessible by user.
Any change of the user will violate the legal approval of this product.

For Ukraine

Декларація про відповідність

Справжнім «Robert Bosch GmbH» заявляє, що Automotive Infotainment System моделі AIVIP33A0 відповідає основним вимогам та іншим відповідним положенням директиви 2014/53/ЄС, а також суттєвим вимогам Технічного регламенту радіообладнання, затвердженого постановою Кабінету Міністрів України від 24 травня 2017 року № 355.

З повним текстом української Декларації про відповідність можна ознайомитись, відвідавши сторінку на: <https://eu-doc.bosch.com>
Виробник: «Robert Bosch GmbH»/ «Роберт Бош ГмбХ» (Роберт-Бош-Плаза 1, 70839 Герлінген, Німеччина).



Діапазон частот:

Bluetooth (IEEE 802.15.1), WLAN 802.11 b/g/n:
2400,0 - 2483,5 МГц;
WLAN 802.11 a/n/ac:
5150 – 5250 МГц/ 5725-5875 МГц
(Glonass/GPS): 1559 - 1610 МГц
AM/FM/DAB:
526,5 – 1606,5 кГц
87,5-108 МГц
174 - 230 МГц

Максимальна вихідна потужність

ЕІВП не більше, дБм (мВт) :
1,4 (1,38) Bluetooth (IEEE 802.15.1)
17,4 (54,95) WLAN 802.11 b/g/n
16,7 (46,77) WLAN 802.11 a/n/ac
13,7 (23,44) (SRD)

For Russia



For Thailand

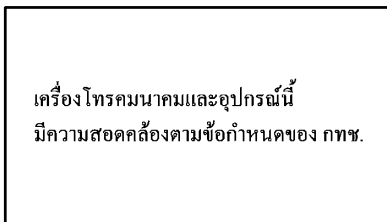

For Mexico

La operación de este equipo está sujeta a las siguientes dos condiciones:

- (1) es posible que este equipo o dispositivo no cause interferencia perjudicial y
- (2) este equipo o dispositivo debe aceptar cualquier interferencia, incluyendo la que pueda causar su operación no deseada.

Modelo: AIVIH61L1, AIVIP33A0 and AIVIL42P0

Marca: Bosch

TRADEMARKS



Apple, iPhone, iPod, and iPod touch are trademarks of Apple Inc., registered in the U.S. and other countries. Apple CarPlay is a trademark of Apple Inc. Use of the Apple CarPlay logo means that a vehicle user interface meets Apple performance standards. Apple is not responsible for the operation of this vehicle or its compliance with safety and regulatory standards. Please note that the use of this product with iPhone or iPod may affect wireless performance.



Bluetooth® is a trademark owned by Bluetooth SIG, Inc. and licensed to Robert Bosch GmbH and Clarion Co., Ltd.



Music recognition technology and related data are provided by Gracenote®. Gracenote is the industry standard in music recognition technology and related content delivery. For more information, visit www.gracenote.com. Music related data from Gracenote, Inc., copyright © 2000 to present Gracenote. Gracenote Software, copyright © 2000 to present Gracenote. One or more patents owned by Gracenote apply to this product and service. See the Gracenote website for a non-exhaustive list of applicable Gracenote patents. Gracenote, the Gracenote logo and logotype are either a registered trademark or a trademark of Gracenote, Inc. in the United States and/or other countries.

App Store

Apple and the Apple logo are trademarks of Apple Inc., registered in the U.S. and other countries. App Store is a service mark of Apple Inc.

Siri

Siri is a trademark of Apple Inc., registered in the U.S. and other countries.

Google/Android/Google Play/Android Auto

Google, Android, Google Play, Android Auto, and other marks are trademarks of Google LLC.

LEGAL DISCLAIMER FOR NISSANCONNECT SERVICES (for Mexico)

Feature availability is dependent on vehicle model, trim level, packaging and options. Compatible connected device may be required and feature availability may be dependent on device's capability. Refer to connected device's owner's manual for details. Late availability for some features.

Driving is serious business and requires your full attention. Only use features and connected devices when safe and legal to do so. Some features, including automatic crash notification and SOS, are dependent upon the telematics device being in operative condition, its ability to connect to a wireless network, compatible wireless network availability, navigation map data and GNSS signal receptions, the absence of which can limit or prevent the ability to reach Customer Care or receive support. GNSS mapping may not be detailed in all areas or reflect current road status. Never program GNSS while driving.

Only use Remote Engine Start and Remote Horn features in accordance with any laws, rules or ordinances in effect in your vehicle's location.

Some services and features are provided by independent companies not within NISSAN's control. Should service provider terminate or restrict service or features, service or features may be suspended or terminated without notice or with no liability to NISSAN or its partners or agents.

Services and features may require compatible cellular network provided by independent companies not within NISSAN or its partners' or agents' control. Cellular network signal strength may vary and may not be available in all areas or at all times. Services and features may not function if cellular network is unavailable, restricted, or terminated.

NISSAN and its partners or agents are not responsible for associated costs or other third party changes that may be required for continued operation due to cellular network unavailability, restriction, or termination (including equipment replacements/upgrades, if available, or roaming charges on alternative networks). Technology is evolving, and changes by independent companies are not within NISSAN's or its partners' or agents' control. Enrollment, owner consent, personal identification number (PIN), and subscription agreement may be required to receive full suite of features and services.

Trial periods (if applicable) begin on the date of vehicle purchase or lease of a new NISSAN. Trial periods may be subject to change at any time and may be subject to early termination without notice. Required subscriptions may be sold separately for each available feature or service after trial period ends, and may continue until you call service provider to cancel. Installation costs, one-time activation fee, other fees and taxes may apply. Fees and programming subject to change. Feature

may be subject to age restrictions in some areas. Subscriptions governed by service provider's subscription agreement, terms and conditions and privacy statements available at service provider's website.

LICENSES

SOFTWARE LICENSES

- Open Source Software Licenses
<http://oss.bosch-cm.com/nissan.html>
- This product is protected by certain intellectual property rights of Microsoft. Use or distribution of such technology outside of this product is prohibited without a license from Microsoft.

TELEMATIC CONTROL UNIT (if equipped)

<http://opensourceautomotive.com/IC/tZ7T3eE6AiV4>

MEMO







2 Getting started

Control buttons and touch screen display	2-2	Basic operation	2-7
Buttons on control panel	2-2	Selecting menu from Launch Bar	2-7
Touch screen display	2-3	How to view and operate HOME	
Switches on steering wheel	2-4	MENU screen	2-8
USB (Universal Serial Bus)		Swipe-down notifications	2-9
connection ports	2-5	Functions disabled while driving	
Starting system	2-6	(if equipped)	2-9
Start-up screen (if equipped)	2-6	System settings	2-10
Log-in screen (if equipped)	2-6	Settings menu	2-10
		Connections settings	2-12

CONTROL BUTTONS AND TOUCH SCREEN DISPLAY

BUTTONS ON CONTROL PANEL

The control panel buttons are located at the center of the instrument panel. Available functions, designs, locations, etc. may differ depending on the specifications, control panel types and software versions.

Button	Function
<MENU>	Push to display the HOME MENU screen.  "How to view and operate HOME MENU screen" (page 2-8)
<*/>	Push to switch between the day screen (bright) and the night screen (dark) and to adjust the level of screen brightness. Push and hold the button to turn off the display. Push the button again to turn on the display.
< ⏪ BACK>/< ⏩ >	Depending on the screen, pushing the button will display the previous screen.
<AUDIO>	Push to display the audio screen. When this button is pushed while the audio screen is displayed, a screen to select an audio source will be displayed.  "Selecting audio source" (page 3-7)
< ⏻ /VOL>/<VOL/PUSH ⏻ >/<VOL/PUSH POWER>	Push to turn the power of the audio system on/off. Turn to adjust the volume.
< ⏮ >/< ⏭ >	Use the buttons for audio operations.  "Audio operations" (page 3-7)
<PUSH SOUND/⌂ ⌂>/<TUNE SCROLL/PUSH SOUND>/<⌂ ⌂>/ENTER SETTING>	Depending on the conditions when a menu screen is displayed, turning the dial can select items on the screen. Push to confirm the selected item or setting. Depending on the models, the button can also be used for audio operations.  "Audio operations" (page 3-7) Models with navigation system: Turning the dial can adjust the map scale on the navigation screen.
<MAP>	Push to display the current location map. When a split map screen is displayed, push this button to display the full map screen. When available, voice guidances can be repeated by pushing and holding this button.  "6. Navigation"
< 📞 >	Push to display the phone screen.  "4. Hands-Free Phone"



INFO:

For **<CAMERA>** operation, refer to the vehicle Owner's Manual.

TOUCH SCREEN DISPLAY

The touch screen display is located at the center of the instrument panel. Various information and operation menus are displayed on the touch screen display. Touch keys and icons on the screen for operation.

Liquid crystal display

The touch screen display on this unit is a liquid crystal display and should be handled with care.



WARNING:

Never disassemble the display. Some parts utilize extremely high voltage. Touching them may result in serious personal injury.

Characteristics of liquid crystal display:

- If the temperature inside the vehicle is especially low, the display will stay relatively dim or the movement of the images may be slow. These conditions are normal. The display will function normally when the interior of the vehicle has warmed up.
- Some pixels in the display are darker or brighter than others. This condition is an inherent characteristic of liquid

crystal displays, and it is not a malfunction.

- A remnant of the previous display image may remain on the screen. This screen burn is inherent in liquid crystal displays, and it is not a malfunction.
- The screen may become distorted by strong magnetic fields.
- Depending on the condition, brightness may be adjusted automatically to prevent the display from screen burning.

Maintenance of display:

To clean the display screen, use a dry, soft cloth. If additional cleaning is necessary, use a small amount of neutral detergent with a soft cloth. Never spray the screen with water or detergent. Dampen the cloth first, then wipe the screen.















CAUTION:





- **Clean the display with the ignition switch in the OFF position. If the display is cleaned while the ignition switch is placed in the ON position, unintentional operation may occur.**
- **To clean the display, never use a rough cloth, alcohol, benzene, thinner or any kind of solvent or paper towel with a chemical cleaning agent. They will scratch or deteriorate the panel.**

- **Do not splash any liquid, such as water or car fragrance, on the display. Contact with liquid will cause the system to malfunction.**

SWITCHES ON STEERING WHEEL

Switches on the steering wheel can be used to perform operations such as taking phone calls, changing volume, and conducting voice operations. Available functions and designs may differ depending on the specifications, switch types and software versions.

Switch	Function
<  >	<p>Push to answer a received call, to end an active call or to read a received text message. Push and hold to reject an incoming call or to ignore a received text message.</p> <p>When no phone call is received or when there is no active call, pushing this switch will display the phone screen.</p> <p>Depending on models and conditions, pushing and holding this switch will start a voice recognition session for making a phone call.</p> <p> "4. Hands-Free Phone"</p>
<  > (TALK)	<p>If your iPhone is connected to the in-vehicle system via Bluetooth®, Siri Eyes Free (if equipped) can be activated by pushing and holding this switch without having to activate Apple CarPlay (if equipped).</p> <p> "Siri Eyes Free" (page 5-22)</p> <p>When Apple CarPlay (if equipped) or Android Auto (if equipped) is active, pushing and holding this switch will start a Siri or Google Assistant session.</p> <p> "Siri operation" (page 5-17)</p> <p> "Google Assistant™ operation" (page 5-20)</p> <p>Models with Voice Recognition System:</p> <p>Push to use the Voice Recognition System. Push and hold to end the voice recognition session.</p> <p> "Giving voice commands" (page 7-2)</p>
<  >	<p>Push to go back to the previous screen while operating the Voice Recognition System (if equipped).</p> <p>Push and hold to end a voice recognition session.</p>
<  >	<p>Push the + or - side of the switch to adjust the volume.</p>
<  /  >	<p>Tilt to select the voice command while operating the Voice Recognition System (if equipped).</p> <p>Push to confirm the selected item while operating the Voice Recognition menu screen.</p> <p> "7. Voice recognition"</p> <p>This switch can also be used for audio operations.</p> <p> "Audio operations" (page 3-7)</p>

Switch	Function
< ▲ >/< ▼ >/< ◀ >/< ▶ >/<OK> (Push switch type)	Push < ▲ >/< ▼ > to select the voice command while operating the Voice Recognition menu screen (if equipped). Push < ◀ >/< ▶ > to switch to the previous or next page while operating the Voice Recognition menu screen. Push <OK> to confirm the selected item while operating the Voice Recognition menu screen.  "7. Voice recognition"
<SOURCE>	Push to change the audio source.  "Audio operations" (page 3-7)
< ◀ / ▶ / > >/<OK> (Scroll dial type)	Push the left side of the switch to return to the previous screen while operating the Voice Recognition System (if equipped). Push and hold the left side of the switch to end a voice recognition session. Scroll <OK> to select a voice command while operating the Voice Recognition System. Push <OK> to confirm the selected voice command while operating the Voice Recognition System.  "7. Voice recognition"
< ◀◀ >/< ▶▶ >	This switch can be used for audio operations.  "Audio operations" (page 3-7) Depending on models and conditions, push to read the previous or next message while received text message is displayed on the touch screen display.  "Received message screen" (page 4-7)

 **INFO:**

Steering wheel switches are mainly for the vehicle information display control and may not be able to operate the touch screen display depending on the conditions. For details of the vehicle information display, refer to the vehicle Owner's Manual.

USB (Universal Serial Bus) CONNECTION PORTS

 **WARNING:**

Do not connect, disconnect or operate the USB device while driving. Doing so can be a distraction. If distracted you could lose control of your vehicle and cause an accident or serious injury.

 **CAUTION:**

- **Do not force the USB device into the USB connection port. Depending on the USB connection port, inserting the USB device tilted or upside down may damage the port. Make sure that the USB device is connected correctly into the USB connection port.**
- **Do not grab the USB connection port cover (if equipped) when pulling the USB device out of the port. This**

could damage the port and the cover.

- **Do not leave the USB cable in a place where it can be pulled unintentionally. Pulling the cable may damage the port.**

The vehicle is equipped with USB connection ports. When connected, the in-vehicle audio system can play audio contents from the compatible device.

The USB connection ports are located on the lower part of the instrument panel or inside the console box.

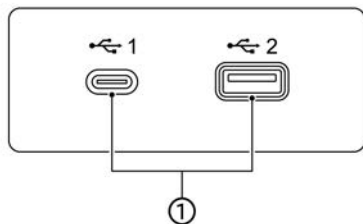

① USB connection ports:

Connect a compatible device to play media such as an iPod or a USB memory device.

Connect an iPhone or an Android phone to use Apple CarPlay (if equipped) or Android Auto (if equipped).

INFO:

- Refer to your USB device manufacturer's owner information regarding the proper use and care of the device.
- Cables made by Apple Inc. should be used to connect electronic devices marketed by Apple Inc.

STARTING SYSTEM

The system starts when the ignition switch is placed in the ACC or ON position.

START-UP SCREEN (if equipped)

The start-up screen is displayed when the ignition switch is placed in the ACC or ON position.

After an animated start-up screen is displayed, a message screen will be displayed. Touch [OK] after reading and agreeing to the message displayed on the screen. If you do not agree to the message, some of the functions on the system will be disabled.

NOTE:

Do not keep the system running with the engine stopped. Doing so may discharge the vehicle battery. When you use the system, always keep the engine running.

LOG-IN SCREEN (if equipped)

Three unique users can be recognized by the vehicle, with personal settings linked to the Intelligent Key assigned to each user. Register the user information when the Intelligent Key is used for the first time as necessary. When [Welcome Message] setting is turned on, a welcome message screen is displayed with the detected user's name each time the system starts.

 "Settings menu" (page 2-10)

BASIC OPERATION

1. The system starts when the ignition switch is placed in the ON position. A welcome message screen is displayed.
2. Check the message that is displayed on the screen. If the name shown in the welcome message is incorrect, touch to select the preferred user. Touching [Edit User] on the settings screen can also change the user.
☞ "Settings menu" (page 2-10)

The system can be operated with the touch panel as well as the switches on the control panel and the steering wheel. This manual mainly describes the touch panel operation.

SELECTING MENU FROM LAUNCH BAR

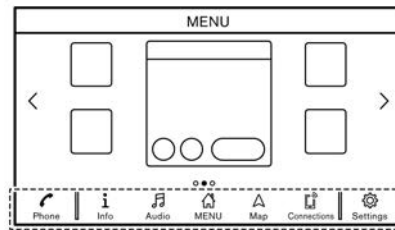

Example

Various system functions can be accessed by touching the items on the Launch Bar ① which is displayed on most of the main menu screens. (The Launch Bar does not appear on some screens such as scrolled map screen, keyboard screen, etc.)

Touch the item on the Launch Bar to display the corresponding screens.

The items on the Launch Bar differ according to which button on the control panel is pushed.

The following menus are available on the Launch Bar. (Displayed items may vary

depending on models, specifications and software versions.)

When pushing <MENU>:

Shortcuts for various functions are displayed.

- [Phone]*
☞ "Phone" (page 4-4)
- [Info]
☞ "Information menu" (page 5-2)
- [Audio]
☞ "Audio operations" (page 3-7)
- [MENU]
Touching [MENU] on the Launch Bar will display the center page of the HOME MENU screen.
- [Map]
☞ "Displaying navigation screen" (page 6-2)
- [Connections]
☞ "Connections settings" (page 2-12)
- [Settings]
☞ "System settings" (page 2-10)

*: [Phone] will be replaced by [📺] when Apple CarPlay (if equipped) is active, and it will be replaced by [📶] when Android Auto (if equipped) is active.

When pushing <AUDIO>:

Shortcuts mainly for the audio functions are displayed.

☞ “Selecting audio source” (page 3-7)

When pushing <MAP> (if equipped):

Shortcuts mainly for the navigation functions are displayed.

☞ “Launch Bar” (page 6-2)

HOW TO VIEW AND OPERATE HOME MENU SCREEN

Push <MENU> to display the HOME MENU screen.

The HOME MENU consists of 3 pages which can display preferred shortcuts and widgets.

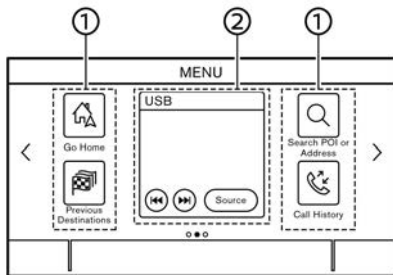

Example

① Shortcut icons:

Icons for frequently used menu items can be placed on the HOME MENU screens as shortcuts.

② Widget:

Useful information from primary menu functions can be displayed as widgets. Depending on the contents of the widget, keys may be available for operation of the function.

Customizing HOME MENU screen

The HOME MENU screen can be personalized by selecting which shortcuts and widgets are to be displayed and where to place them on the screen.

Selecting shortcut or widget:

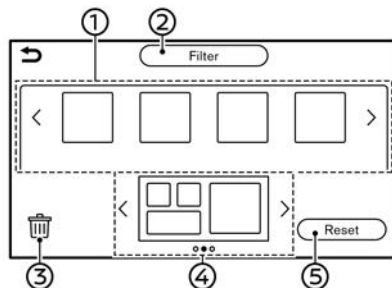

Example

1. Touch [Settings] on the Launch Bar.
2. Touch [Customise Home Menu]/[Customize Home Menu].
3. Drag the shortcut or widget icon ① to each page layout ④.

If a different shortcut or a widget is already located on the page layout ④, a message will be displayed. Touch

[Yes] to replace the shortcut/widget. The page layout ④ can be changed by dragging the icons.

The categories of shortcuts or widgets can be narrowed down by touching [Filter] ② and selecting preferred categories.

Dragging an icon into the [Trash] ③ can delete the current shortcut or widget to create a blank spot.

INFO:

- Touch [Trash] ③, and then a message will appear. While the message is displayed, touching any icon on the page layout ④ and then touching [Delete] can delete the selected icon. To delete all icons, touch [Select All] and then touch [Delete].
- Touch [Reset] ⑤ to reset the HOME MENU screen to the default setting.

SWIPE-DOWN NOTIFICATIONS

By swiping down on the touch screen display, a list of notifications (such as missed calls, text message reception) can be displayed.

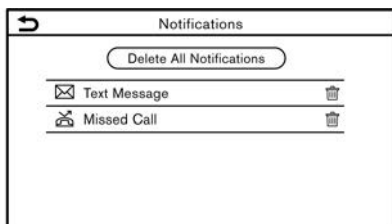

INFO:

- Touch an item on the list to see the details of the item.
- Touch  to delete an item.
- Touch [Delete All Notifications] to delete all items.

FUNCTIONS DISABLED WHILE DRIVING (if equipped)

To ensure safe driving, some functions cannot be operated while driving.

The on-screen functions that are not available while driving will be "grayed-out" or muted. In some cases, certain text will not be displayed on the screen.

To use these functions, first park the vehicle in a safe location and then operate the system.

SYSTEM SETTINGS







The system settings can be changed for personal convenience.





SETTINGS MENU

Touch [Settings] on the Launch Bar, and then touch a setting item you wish to adjust.

Available setting items may vary depending on models, specifications and software versions.

Available setting items

Setting item	Result
[Connections]	Displays the Devices, Wi-Fi (if equipped) and USB setting screen.  "Connections settings" (page 2-12)
[Phone]	Displays the Phone and text message settings screen.  "Phone and text message settings" (page 4-10)
[Navigation]	Displays the navigation settings screen.  "Navigation settings" (page 6-36)
[Sound]	Displays the audio settings screen.
[Volume & Beeps]	Displays the volume adjustment screen.
[Clock]	Displays the clock adjustment screen.
[Customise Home Menu]/[Customize Home Menu]	Displays the HOME MENU editing screen.
[Customise Audio Sources]/[Customize Audio Sources]	Displays the editing screen for audio source menus on the Launch Bar.  "Selecting from Launch Bar" (page 3-8)
[NissanConnect Services]	Displays the NissanConnect Services settings screen.  "NissanConnect Services (if equipped for Europe, Russia and Ukraine)" (page 5-5)  "NissanConnect Services powered by SiriusXM™ (for Mexico)" (page 5-6)
[System Voice]	Displays the system voice settings screen.  "System Voice settings" (page 7-5)
[Camera]	Displays the camera settings screen. See the vehicle Owner's Manual for details of the monitor system.
[Seat]	[Message Settings] Displays the massage seat settings screen.

[Parking]		Displays the parking settings screen. See the vehicle Owner's Manual for details.
[More Settings]/[Others]	[Display]	Displays the display settings screen.
	[Language]	Displays the language settings screen.
	[Units]	Displays the units settings screen.
	[Keyboard Type]	Keyboard type can be selected.
	[Return All Settings to Default]	This resets all settings to default.
[System Update]/[System Updates]	[Version Information]	Displays the version information screen.
	[Software Update]	The system software can be updated.  "Updating system software" (page 5-4)
	[Map Update]	The map data can be updated.  "How to update map data" (page 6-44)
[Apps]	[Smartphone Connection]	Displays the Connections screen.  "Connections settings" (page 2-12)
	[Notifications]	Displays the swipe-down notification setting screen.  "Swipe-down notifications" (page 2-9)
[Edit User]		A maximum of four Intelligent Keys can be registered to store settings for three profiled users and one guest. One user setting information can be stored per Intelligent Key. Each time the ignition switch is placed in the OFF position, the personal settings such as navigation, audio, etc. at that point will be memorized by the Intelligent Key. When the system is turned on, the user will be recognized and the memorized settings will be applied.  "Log-in screen" (page 2-6)
	[User Profiles]	Registers/edits user information and copy/delete user settings.
	[Sync Profile with Intelligent Key]	Turns on/off the function that synchronizes the registered profile with the Intelligent Key. When this item is turned off, the user will be logged in as a guest.
	[Welcome Message]	Sets the welcome message on/off.

CONNECTIONS SETTINGS

Changing the settings and viewing information of connected devices, Wi-Fi (if equipped) and USB are available on the Connections screen.

Setting devices

Settings of the devices connected via Bluetooth®, USB or Wi-Fi (if equipped), such as smartphones used for Hands-Free Phone, Apple CarPlay (if equipped), Android Auto (if equipped), etc., can be changed.

The information of the devices can also be confirmed.

☞ "Apple CarPlay" (page 5-15)

☞ "Android Auto™" (page 5-19)

☞ "USB memory device, iPod and Bluetooth® audio operation" (page 3-14)

☞ "Bluetooth® Hands-Free Phone System" (page 4-2)

Connecting cellular phone/audio device:

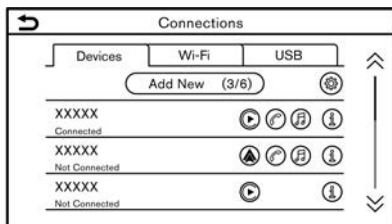

Example

To use the Bluetooth® device with the in-

vehicle system for the first time, the device connection operation is required.

1. Push **<MENU>** and touch [Connections] on the Launch Bar.
2. Touch [Devices] and touch [Add New]. A message is displayed.

INFO:

If no Bluetooth® device is connected and Apple CarPlay (if equipped) or Android Auto (if equipped) is not active, the same screen can be displayed by pushing and holding **< ⏪ >** on the steering wheel.

3. Operate as guided by the system.







NOTE:

Some cellular phones or other devices may cause interference or a buzzing noise to come from the audio system speakers. Storing the device in a different location may reduce or eliminate the noise.

INFO:

- The paired phone will be added to the list on the Devices screen.
- Touching name of the other device on the list will switch the connected device.
- Touching  will allow the device to activate/deactivate Apple CarPlay (if

equipped). This icon is displayed if the device is compatible with Apple CarPlay.

- Touching  will allow the device to activate/deactivate Android Auto (if equipped). This icon is displayed if the device is compatible with Android Auto.
- Touching  will allow the device to be connected via Bluetooth® and be used on the Hands-Free Phone System.
- You can register a favorite hands-free phone. The  by the phone device name selected as a favorite will be marked with "★".
☞ "Bluetooth® settings" (page 2-13)
- Touching  will allow the device to be connected via Bluetooth® and be used for Bluetooth® Audio.
- You can register a favorite Bluetooth® audio device. The  by the device name selected as a favorite will be marked with "★".
☞ "Bluetooth® settings" (page 2-13)
- Depending on the models, touching  (if equipped) will enable Bluetooth® tethering.
- Touching  will display the information of the device.
- Up to 6 Bluetooth® devices can be registered. If 6 devices are already registered, one of the devices must

first be deleted before another device can be registered.

- The pairing procedure of the cellular phone varies according to each cellular phone. See the cellular phone Owner's Manual for the details.
- Consult a NISSAN dealer for information regarding Bluetooth® device connection to your vehicle.

Bluetooth® settings:

The Bluetooth® settings can be changed according to your preference.

1. Push **<MENU>** and touch [Connections] on the Launch Bar.
2. Touch [Devices].
3. Touch .

Available setting items may vary depending on models, specifications and software versions.

Available setting items

Setting item	Action
[Bluetooth]	Turns the Bluetooth® connection on/off.
[Allow 2 Phones Simultaneously]	When turned on, up to 2 Bluetooth® devices can be connected as hands-free phones to the in-vehicle system simultaneously.

[Favourite Phone]/[Favorite Phone]	A Bluetooth® device can be registered as a favorite hands-free phone. If the hands-free phone device is within the range with Bluetooth® turned on, the device registered as favorite will automatically be connected to the in-vehicle system with priority upon the system activation.
[Favourite Audio]/[Favorite Audio]	A Bluetooth® device can be registered as a favorite audio device. If the Bluetooth® audio device is within the range with Bluetooth® turned on, the device registered as favorite will automatically be connected to the in-vehicle system with priority upon the system activation.
[Device Name]	The device name can be changed.
[PIN]	The PIN code can be changed.



INFO:

With [Device Name], the device name that appears on the screen can be changed and be renamed from the name set as default to the preferred name (such as "Steve's Car" for example).



Device information:

You can display the information of the devices connected to the vehicle.

1. Push **<MENU>** and touch [Connections] on the Launch Bar.
2. Touch [Devices].
3. Touching  by the device name will display the information of the device.

Available items may vary depending on models, specifications and software versions.

Available items

Setting item	Action
[Delete]	Paired devices can be deleted from the list.
[Device Information]	Displays the information of connected Bluetooth® device.
[Smartphone Projection]	Displays the smartphone setting screen.  "Apple CarPlay" (page 5-15)  "Android Auto™" (page 5-19)

Deleting device information:

Paired devices can be deleted from the list.

1. Push **<MENU>** and touch [Connections] on the Launch Bar.

2. Touch [Devices].
3. Touch [📶] by the cellular phone name you wish to delete.
4. Touch [Delete]. Touch [Yes] when a message appears.

Wi-Fi setting (if equipped)

A Wi-Fi connection can be made by using an available Wi-Fi network near the vehicle or tethering function of smartphone, etc. Wi-Fi connectivity is useful for updating map data (if equipped) and system software (if equipped), or Premium Traffic (if equipped).

- 📖 "Updating system software" (page 5-4)
- 📖 "How to update map data" (page 6-44)
- 📖 "Premium Traffic information" (page 6-26)

Connecting to a Wi-Fi network:

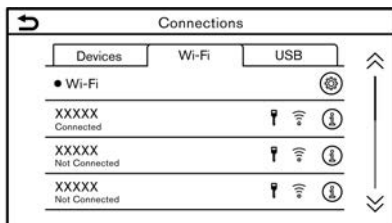

Example

To use the Wi-Fi connection for the first time, the following connecting procedures are required.

1. Push **<MENU>** and touch [Connections] on the Launch Bar.
2. Touch [Wi-Fi].
3. Touch the name of the device you wish to connect.

	Indicates that a password is set.
	Indicates the strength of the signal the Wi-Fi device is receiving.

4. Enter the network password and touch [OK]. The device will be connected.

If a listed device is in a status capable of making Wi-Fi connection, touching the device name on the list will start the connection.

INFO:

- Enter the password correctly, including capitalization.
- Touching [📶] will display the network information. Turning [Auto Connect] on will automatically connect the vehicle to the network if the network is available.
- Touch [Car Hotspot]/[Vehicle Hotspot] (if equipped) and turn on the indicator to activate the Wi-Fi hotspot communication. It enables devices such as smartphones to connect to a Wi-Fi network.

- Enabling the Wi-Fi hotspot functionality of your smartphone may incur additional charges from your cellular provider. Consult your cellular provider contract regarding the communication fee.
- The system can connect to only WPA2 security network (not connect WEP, WPA1 network).
- Wi-Fi networks that require a web browser cannot be accessed through this unit.

Wi-Fi settings:

The Wi-Fi settings can be changed according to your preference.

1. Push **<MENU>** and touch [Connections] on the Launch Bar.
2. Touch [Wi-Fi].
3. Touch [⚙️].
4. Touch a preferred item.

Available setting items may vary depending on models, specifications and software versions.

Available setting items

Setting item	Action
[Wi-Fi]	Turns the Wi-Fi connection on/off.
[Car Hotspot]/ [Vehicle Hotspot]	Turns the vehicle hotspot on/off.
[Network Name (SSID)]	Displays the Wi-Fi network name.
[Password]	Displays the Wi-Fi network password.

Deleting Wi-Fi network:

The stored Wi-Fi network can be deleted from the list.

1. Push **<MENU>** and touch [Connections] on the Launch Bar.
2. Touch [Wi-Fi].
3. Touch [i] by the name of the network you wish to delete.
4. Touch [Forget this Network]/[Forget This Network]. Touch [Yes] when a message appears.

Displaying USB device information

The information of the connected USB device can be viewed.

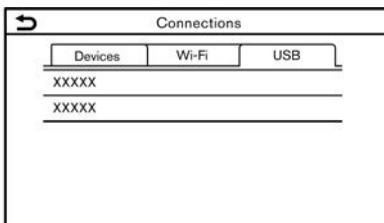

Example

1. Push **<MENU>** and touch [Connections] on the Launch Bar.
2. Touch [USB].
3. Touch the name of the device you wish to check. The name and the type of the device are displayed.

MEMO

3 Audio system

Audio operation precautions	3-2	USB memory device, iPod and Bluetooth®	
Radio	3-2	audio player	3-12
USB (Universal Serial Bus) connection port	3-3	Smartphone audio (if equipped)	3-18
Compressed Audio Files (MP3/WMA/AAC)	3-4	Audio settings	3-19
Bluetooth® audio	3-7	Audio adjustments with audio	
Audio operations	3-7	adjust bar	3-20
Audio main operation	3-7	USB memory device care and cleaning	3-20
Radio	3-8	USB memory device	3-20

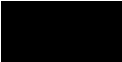

AUDIO OPERATION PRECAUTIONS



CAUTION:

- **Operate the audio system only when the vehicle engine is running. Operating the audio system for extended periods of time with the engine turned off can discharge the vehicle battery.**
- **Do not allow the system to get wet. Excessive moisture such as spilled liquids may cause the system to malfunction.**
- **Park the vehicle in a safe location and apply the parking brake to view movies (if equipped) on the touch screen display.**

RADIO

Place the ignition switch in the ACC or ON position before turning on the radio. If you listen to the radio with the engine not running, the ignition switch should be placed in the ACC position.

Radio reception is affected by station signal strength, distance from radio transmitter, buildings, bridges, mountains and other external influences. Intermittent changes in reception quality normally are caused by these external influences.

Using a cellular phone in or near the vehicle may influence radio reception quality.

Radio reception

Your radio system is equipped with state-of-the-art electronic circuits to enhance radio reception. These circuits are designed to extend reception range, and to enhance the quality of that reception.

However there are some general characteristics of both FM and AM radio signals that can affect radio reception quality in a moving vehicle, even when the finest equipment is used. These characteristics are completely normal in a given reception area, and do not indicate any malfunction in your radio system.

Reception conditions will constantly change because of vehicle movement. Buildings, terrain, signal distance and interference from other vehicles can work against ideal reception. Described below are some of the factors that can affect your radio reception.

Some cellular phones or other devices may cause interference or a buzzing noise to come from the audio system speakers. Storing the device in a different location may reduce or eliminate the noise.

FM radio reception

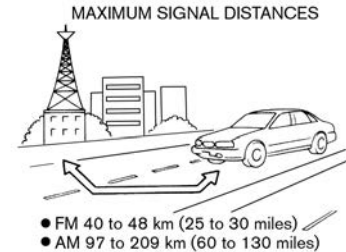

Range: FM range is normally limited to 40 to 48 km (25 to 30 miles), with monaural (single station) FM having slightly more range than stereo FM. External influences may sometimes interfere with FM station reception even if the FM station is within 40 km (25 miles). The strength of the FM signal is directly related to the distance between the transmitter and receiver. FM signals follow a line-of-sight path, exhibiting many of the same characteristics as light. For example they will reflect off objects.

Fade and drift: As your vehicle moves away from a station transmitter, the signals will tend to fade and/or drift.

Static and flutter: During signal interference from buildings, large hills or due to antenna position, usually in conjunction with an increased distance from the station transmitter, static or flutter can be heard. This can be reduced by low-

ering the treble setting to reduce the treble response.

Multipath reception: Because of the reflective characteristics of FM signals, direct and reflected signals reach the receiver at the same time. The signals may cancel each other, resulting in momentary flutter or loss of sound.

AM radio reception

AM signals, because of their low frequency, can bend around objects and skip along the ground. In addition, the signals can bounce off the ionosphere and be bent back to earth. Because of these characteristics, AM signals are also subject to interference as they travel from transmitter to receiver.

Fading: Occurs while the vehicle is passing through motorway underpasses or in areas with many tall buildings. It can also occur for several seconds during ionospheric turbulence even in areas where no obstacles exist.

Static: Caused by thunderstorms, electrical power lines, electric signs and even traffic lights.

Digital Audio Broadcast (DAB) (if equipped)

The supported standards for this system are DAB and DAB+.

USB (Universal Serial Bus) CONNECTION PORT



WARNING:

Do not connect, disconnect or operate the USB device while driving. Doing so can be a distraction. If distracted you could lose control of your vehicle and cause an accident or serious injury.



CAUTION:

- **Do not force the USB device into the USB connection port. Depending on the USB connection port, inserting the USB device tilted or upside down may damage the port. Make sure that the USB device is connected correctly into the USB connection port.**
- **Do not grab the USB connection port cover (if equipped) when pulling the USB device out of the port. This could damage the port and the cover.**
- **Do not leave the USB cable in a place where it can be pulled unintentionally. Pulling the cable may damage the port.**

The vehicle is not equipped with a USB device. USB devices should be purchased separately as necessary.

This system cannot be used to format

USB devices. To format a USB device, use a personal computer.

This system supports various USB memory devices, USB hard drives and iPod players. Some USB devices may not be supported by this system.

- Partitioned USB devices may not be played correctly.
- Some characters used in other languages (Chinese, Japanese, etc.) are not displayed properly on the display. Using English language characters with a USB device is recommended.

General notes for USB use:

Refer to your device manufacturer's owner information regarding the proper care of the device.

Notes for iPod use:

iPod is a trademark of Apple Inc., registered in the U.S. and other countries.

- Improperly plugging in the iPod may cause a checkmark to be displayed on and off (flickering). Always make sure that the iPod is connected properly.
- Audiobooks may not play in the same order as they appear on an iPod.

Compatibility:

Made for

- iPhone 12 Pro Max
- iPhone 12 Pro

- iPhone 12
- iPhone 12 mini
- iPhone SE (2nd generation)
- iPhone 11 Pro Max
- iPhone 11 Pro
- iPhone 11
- iPhone XS Max
- iPhone XS
- iPhone XR
- iPhone X
- iPhone 8 Plus
- iPhone 8
- iPhone 7 Plus
- iPhone 7
- iPhone SE
- iPhone 6s Plus
- iPhone 6s
- iPhone 6 Plus
- iPhone 6
- iPhone 5s
- iPhone 5c
- iPhone 5
- iPod touch (7th generation)
- iPod touch (6th generation)



INFO:

- Make sure that iOS is updated.
- Refer to your device manufacturer's owner information regarding the proper use and care of the device.

COMPRESSED AUDIO FILES (MP3/WMA/AAC)

Explanation of terms

- MP3 — MP3 is short for Moving Pictures Experts Group Audio Layer 3. MP3 is the most well-known compressed digital audio file format. This format allows for near "CD quality" sound, but at a fraction of the size of normal audio files. MP3 conversion of an audio track can reduce the file size by approximately a 10:1 ratio (Sampling: 44.1 kHz, Bit rate: 128 kbps) with virtually no perceptible loss in quality. The compression reduces certain parts of sound that seem inaudible to most people.
- WMA — Windows Media Audio (WMA) is a compressed audio format created by Microsoft as an alternative to MP3. The WMA codec offers greater file compression than the MP3 codec, enabling storage of more digital audio tracks in the same amount of space when compared to MP3s at the same level of quality. This product is protected by certain
- intellectual property rights of Microsoft Corporation and third parties. Use or distribution of such technology outside of this product is prohibited without a license from Microsoft or an authorized Microsoft subsidiary and third parties.
- Bit rate — Bit rate denotes the number of bits per second used by a digital music file. The size and quality of a compressed digital audio file is determined by the bit rate used when encoding the file.
- Sampling frequency — Sampling frequency is the rate at which the samples of a signal are converted from analog to digital (A/D conversion) per second.
- Multisession — Multisession is one of the methods for writing data to media. Writing data once to the media is called a single session, and writing more than once is called a multisession.
- ID3/WMA tag — The ID3/WMA tag is the part of the encoded MP3 or WMA file that contains information about the digital music file such as song title, artist, album title, encoding bit rate, track time duration, etc. ID3 tag information is displayed on the Album/Artist/Track title line on the display.
- AAC — Advanced Audio Coding (AAC) is a compressed audio format. AAC

offers greater file compression than MP3 and enables music file creation and storage at the same quality as MP3.

* Windows® and Windows Media® are registered trademarks or trademarks of Microsoft Corporation in the United States of America and/or other countries.

Playback order

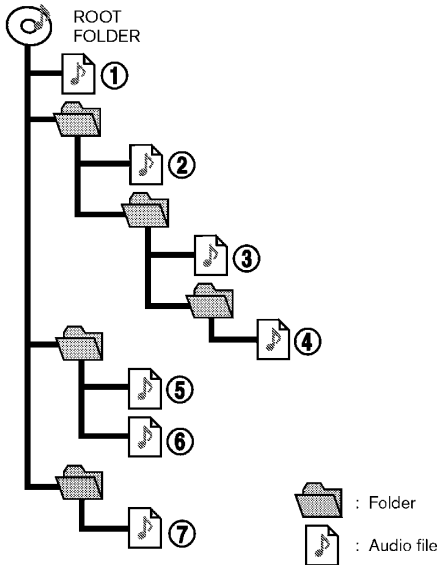

- Names of folders not containing compressed audio files are not shown on the display.
- The playback order is the order in which the files were written by the writing software, so the files might not play in the desired order.
- Music playback order of compressed audio files is as illustrated.

Specification chart for USB

Supported media	USB2.0
Supported file systems	FAT16, FAT32
Folder levels	Folder levels: 8, Files via folder: 255, Folders: 512 (including root folder), Files: 8000
Tag information (Song title, Artist name and Album name)	ID3 tag VER1.0, VER1.1, VER2.2, VER2.3, VER2.4 (MP3 only)
	WMA tag (WMA only)
	AAC tag (AAC only)

Format			Sampling frequency	Supported bitrate
MP3 *1	MPEG1	Layer-3	32, 44.1, 48 kHz	32-320 kbps
	MPEG2		16, 22.05, 24 kHz	8-160 kbps
WMA *2			8, 11.025, 16, 22.05, 32, 44.1, 48 kHz	12-192 kbps
AAC (MPEG4) *3 (Extension "m4a" only)			11.025, 16, 22.05, 32, 44.1, 48 kHz	8-320 kbps
FLAC			8-192 kHz	128-12,288 kbps
WAV			8-192 kHz	128-12,288 kbps

*1 MPEG2.5 is not supported.

*2 WMA7, WMA8, WMA9, WMA9.1, WMA9.2 are supported. (WMA9 Professional, Lossless, Voice are not supported.)

*3 Only AAC files encoded by iTunes are supported. HE-AAC (High-Efficiency) is not supported.

BLUETOOTH® AUDIO

- Some Bluetooth® audio devices may not be recognized by the in-vehicle audio system.
- It is necessary to set up the wireless connection between a compatible Bluetooth® audio device and the in-vehicle Bluetooth® module before using the Bluetooth® audio.
- The Bluetooth® audio may stop playing when
 - receiving a hands-free call.
 - checking the connection to the hands-free phone.
 - connecting the hands-free phone or the audio device.
 - downloading the phonebook memory from the connected cellular phone.
- Do not place a Bluetooth® audio device in an area surrounded by metal or far away from the in-vehicle Bluetooth® module to prevent tone quality degradation and wireless connection disruption.
- While an audio device is connected through a Bluetooth® wireless connection, the battery of the device may discharge quicker than usual.
- This system supports the Bluetooth® Advanced Audio Distribution Profile

(A2DP) and Audio/Video Remote Control Profile (AVRCP).

- Wireless LAN (Wi-Fi) and the Bluetooth® functions share the same frequency band (2.4 GHz). Using the Bluetooth® and the wireless LAN functions at the same time may slow down or disconnect the communication and cause undesired noise. It is recommended that you turn off the wireless LAN (Wi-Fi) when using the Bluetooth® functions.

AUDIO OPERATIONS

AUDIO MAIN OPERATION

Turning audio system on/off

The ignition switch must be in the ACC or ON position to turn on the audio system. Push **< ⏻ /VOL>/<VOL/PUSH ⏻ >/<VOL/PUSH POWER>** or **<AUDIO>** on the control panel to turn on the last audio source that was playing immediately before the system was turned off. To turn off the audio system, push **< ⏻ /VOL>/<VOL/PUSH ⏻ >/<VOL/PUSH POWER>** on the control panel again.



INFO:

The audio system can also be turned on by turning **< ⏻ /VOL>/<VOL/PUSH ⏻ >/<VOL/PUSH POWER>** on the control panel when the system is turned off.

Selecting audio source

Selecting from source menu screen:

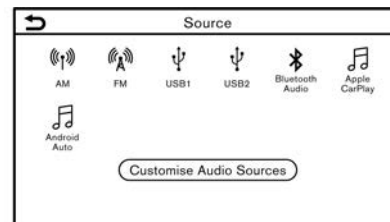

Example

1. Push **<AUDIO>** when the audio screen is displayed.

2. Select an audio source you prefer to play.

INFO:

- Touching [Source] on the upper left corner of the audio screen will also display the audio source menu screen.
- When [Rear Display] (if equipped) is selected, audio source will switch to the Rear Entertainment System (RES) (if equipped). However, the image from the HDMI-connected device cannot be displayed on the touch screen display. For details, see the vehicle Owner's Manual.
- Depending on the models, specifications and software versions, the audio source can also be changed by operating the vehicle information display. Refer to the vehicle Owner's Manual for the detail of the vehicle information display.

Selecting from Launch Bar:

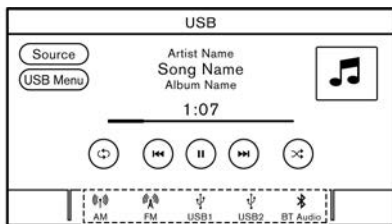

Example

The source icons are displayed on the Launch Bar. Touch the icon to select the preferred audio source.

Customizing Launch Bar:

The source icons displayed on the Launch Bar can be customized.

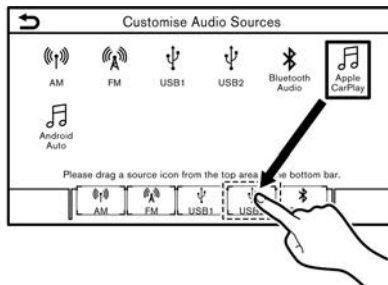

Example

1. Push <AUDIO> or touch [Source], while the Audio screen is displayed.
2. Touch [Customise Audio Sources]/[Customize Audio Sources].
3. Drag the preferred source icon to the Launch Bar.
4. Push < ⏪ BACK>/< ⏩ > on the control panel or touch [⏪] to confirm the setting.

Selecting using steering wheel switch (if equipped):

For models with <SOURCE> on the steering wheel, the audio source can be changed by pushing the switch.

RADIO

Radio operation

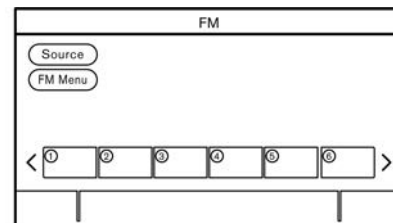

Radio activation and band selection:

To listen to the radio, turn on the audio system and select a preferred radio band.  "Selecting audio source" (page 3-7)

INFO:

When the stereo broadcast signal is weak, the radio will automatically change from stereo to monaural reception.

AM/FM/DAB (if equipped) radio operation:

General operations of AM, FM and DAB radio are as follows.

Available functions and buttons/switches may vary depending on the models, specifications, software versions and conditions.

Function	Operation	
	Models with fast tuning	Models without fast tuning
Manual tuning (AM/FM), Selecting service component (DAB)	<ul style="list-style-type: none"> Control panel <ul style="list-style-type: none"> Turn <TUNE SCROLL/PUSH SOUND>. 	<ul style="list-style-type: none"> Control panel <ul style="list-style-type: none"> Turn <TUNE SCROLL/PUSH SOUND>. Push <◀◀>/<▶▶>.
Fast tuning	<ul style="list-style-type: none"> Control panel <ul style="list-style-type: none"> Push and hold <◀◀>/<▶▶>. 	-
Seek tuning	<ul style="list-style-type: none"> Control panel <ul style="list-style-type: none"> Push <◀◀>/<▶▶>. Steering wheel switch <ul style="list-style-type: none"> Push and hold <◀◀>/<▶▶>. Tilt and hold <▲ / ▼>. 	<ul style="list-style-type: none"> Control panel <ul style="list-style-type: none"> Push and hold <◀◀>/<▶▶>. Steering wheel switch <ul style="list-style-type: none"> Push and hold <◀◀>/<▶▶>.
Presetting stations	<ul style="list-style-type: none"> Touch screen display <ol style="list-style-type: none"> Select a radio band. Tune to the station you wish to store. Touch and hold one of the preset numbers in the preset list on the radio screen. <p>The information such as frequency etc. will be displayed on the preset list.</p>	
Selecting preset stations	<ul style="list-style-type: none"> Steering wheel switch <ul style="list-style-type: none"> Push <◀◀>/<▶▶>. Tilt <▲ / ▼>. Touch screen display <ul style="list-style-type: none"> Briefly touch a preferred station on the preset list on the radio screen. 	

Menu items

Touch [FM Menu], [AM Menu] or [DAB Menu] (if equipped) on each radio screen to display the corresponding menu screen. Available menu items may vary depending on models, specifications and software versions.

[FM Menu]:

[TA]*	When this item is turned on, received TA (Traffic Announcement) will interrupt the audio source that is playing.
[REG]	When this item is turned on, the system will switch to regional radio programs when detected.
[SCAN]	Touch to scan tune the stations. The stations will be tuned from low to high frequencies and stop at each broadcasting station for several seconds. Touching [SCAN] again during this period of several seconds will stop scan tuning and the radio will remain tuned to that station.
[Radio Text]	Displays the radio text information.
[Refresh]	Touch to update the station list displayed on the right side of the FM menu screen.
Station List	Displays the station list on the right side of the FM menu screen.

[AM Menu]:

[TA]*	When this item is turned on, received TA (Traffic Announcement) will interrupt the audio source that is playing.
[SCAN]	Touch to scan tune the stations. The stations will be tuned from low to high frequencies and stop at each broadcasting station for several seconds. Touching [SCAN] again during this period of several seconds will stop scan tuning and the radio will remain tuned to that station.
[Refresh]	Touch to update the station list displayed on the right side of the AM menu screen.
Station List	Displays the station list on the right side of the AM menu screen.

[DAB Menu] (if equipped):

[TA]*	When this item is turned on, received TA (Traffic Announcement) will interrupt the audio source that is playing.
[Radio Text]	Touch to display the radio text information.
[Refresh]	Touch to update the station list displayed on the right side of the DAB menu screen.
[DAB-FM]	When this item is turned on, the system searches for and tunes to FM stations when DAB reception is poor.
Station List	Displays the station list on the right side of the DAB menu screen.

*: Depending on the models, specifications and software versions, [TA] may be displayed on the main operation screens for some audio sources.

USB MEMORY DEVICE, iPod AND BLUETOOTH® AUDIO PLAYER



WARNING:

Do not connect, disconnect or operate the USB device while driving. Doing so can be a distraction. If distracted you could lose control of your vehicle and cause an accident or serious injury.



CAUTION:

- **Do not force the USB device into the USB connection port. Depending on the USB connection port, inserting the USB device tilted or upside down may damage the port. Make sure that the USB device is connected correctly into the USB connection port.**
- **Do not grab the USB connection port cover (if equipped) when pulling the USB device out of the port. This could damage the port and the cover.**
- **Do not leave the USB cable in a place where it can be pulled unintentionally. Pulling the cable may damage the port.**

Connection and activation

USB memory device:

Connection

Connect a compatible USB memory device into the port.

 "USB (Universal Serial Bus) connection ports" (page 2-5)

Refer to your device manufacturer's owner information regarding the proper use and care of the device.

Activation

USB memory device can be played by selecting the source on the audio source menu screen.

 "Selecting audio source" (page 3-7)

iPod:

Connection

Connect a compatible iPod to the USB connection port via a USB cable.

 "USB (Universal Serial Bus) connection ports" (page 2-5)

The battery of the iPod will be charged while the device is connected to the vehicle if the iPod supports charging via a USB connection.

Depending on the device and firmware version of the iPod, the display on the iPod shows a NISSAN or Accessory Attached screen when the connection is completed. When the iPod is connected to the vehicle, the iPod music library can only be operated by the vehicle audio

controls.

Activation

The iPod can be played by selecting the source on the audio source menu screen.

 "Selecting audio source" (page 3-7)

Bluetooth® audio:

Your vehicle is equipped with Bluetooth® Audio. If you have a compatible Bluetooth® device with streaming audio capability (A2DP profile), you can set up a wireless connection between your Bluetooth® device and the in-vehicle audio system. This connection allows you to listen to the audio from the Bluetooth® device using your vehicle speakers. It also may allow basic control of the device for playing and skipping audio files using the AVRCP Bluetooth® profile. Not all Bluetooth® devices have the same level of controls for AVRCP. Please consult the manual for your Bluetooth® device for more details.

Connection

Connect a compatible streaming audio capable Bluetooth® device (A2DP profile) to set up a wireless connection between the Bluetooth® device and the in-vehicle system. Bluetooth® connection can be set up from the Connections screen.

 "Setting devices" (page 2-12)



INFO:

- Depending on the Bluetooth® audio device that is connected, it may not be possible to perform audio operations or a delay may occur before music is played back.
- Not all Bluetooth® devices have the same level of controls for AVRCP. Consult the manual for your Bluetooth® device for more details.
- Wireless LAN (Wi-Fi) and the Bluetooth® functions share the same frequency band (2.4 GHz). Using the Bluetooth® and the wireless LAN functions at the same time may slow down or disconnect the communication and cause undesired noise. It is recommended that you turn off the wireless LAN (Wi-Fi) when using the Bluetooth® functions.

Activation

A Bluetooth® audio device can be played by selecting the source on the audio source menu screen.

 "Selecting audio source" (page 3-7)

USB memory device, iPod and Bluetooth® audio operation

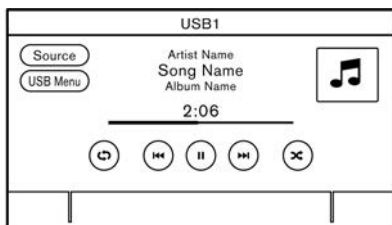

General operations of USB memory device, iPod and Bluetooth® audio are as follows. Available functions and buttons/switches may vary depending on the models, specifications, software versions and conditions.

Function	Operation	Applicable source
Play	<ul style="list-style-type: none"> • Touch screen display <ul style="list-style-type: none"> – Touch [▶]. 	USB, iPod, Bluetooth® audio
Pause	<ul style="list-style-type: none"> • Touch screen display <ul style="list-style-type: none"> – Touch []. 	USB, iPod, Bluetooth® audio
Skipping tracks	<ul style="list-style-type: none"> • Control panel <ul style="list-style-type: none"> – Push < ⏮ > / < ⏭ > . – Turn < TUNE SCROLL / PUSH SOUND > *. • Steering wheel switch <ul style="list-style-type: none"> – Push < ⏮ > / < ⏭ > . – Tilt < ▲ / ▼ > . • Touch screen display <ul style="list-style-type: none"> – Touch [⏮] / [⏭] . <p>*: Depending on the models, turning < TUNE SCROLL / PUSH SOUND > may change folders when available.</p>	USB, iPod, Bluetooth® audio
Rewinding/fast-forwarding	<ul style="list-style-type: none"> • Control panel <ul style="list-style-type: none"> – Push and hold < ⏮ > / < ⏭ > . • Steering wheel switch <ul style="list-style-type: none"> – Push and hold < ⏮ > / < ⏭ > . – Tilt and hold < ▲ / ▼ > . • Touch screen display <ul style="list-style-type: none"> – Touch and hold [⏮] / [⏭] . 	USB, iPod, Bluetooth® audio

Function	Operation	Applicable source
Changing play mode	<ul style="list-style-type: none"> • Touch screen display <ul style="list-style-type: none"> – Touch [↺] to change the repeat mode. – Touch [↻] to change the random mode. 	USB, iPod, Bluetooth® audio

Menu items

Touch [USB Menu], [iPod Menu] and [Menu] (Bluetooth® audio menu) on each audio screen to display the corresponding audio menu screen. Available setting items may vary depending on models, specifications, software versions and the connected audio device. Depending on the connected Bluetooth® device, [Menu] may not be displayed.

[USB Menu]:

[TA]*	When this item is turned on, received TA (Traffic Announcement) will interrupt the audio source that is playing.
[Now Playing]	Touch to display the USB screen.
[Folder List]	Touch to display the folder list. Touch an item on the list to select the folder. The sub-folder or track list will be displayed. Select a sub-folder or track from the list.
[Album Artwork]	Touch to turn on/off the album artwork display on the USB screen.
[Playlists]	Touch to display the list according to the selected item.
[Artists]	
[Albums]	
[Songs]	
[Genres]	
[Composers]	

[iPod Menu]:

[TA]*	When this item is turned on, received TA (Traffic Announcement) will interrupt the audio source that is playing.
[Now Playing]	Touch to display the iPod screen.
[Current List]	Touch to display the current list. A list of tracks in the currently selected category is displayed.
[Album Artwork]	Touch to turn on/off the album artwork display on the iPod screen.

[Playlists]	Touch to display the list according to the selected item.
[Artists]	
[Albums]	
[Songs]	
[Genres]	
[Composers]	
[Audiobooks]	
[Podcasts]	

[Menu] (Bluetooth® audio menu):

[TA]*	When this item is turned on, received TA (Traffic Announcement) will interrupt the audio source that is playing.
[Now Playing]	Touch to display the Bluetooth® audio screen.
[Current List]	Touch to display the current list. A list of tracks in the currently selected folder is displayed.
[Connections]	Touch to display the Connections screen.  "Connections settings" (page 2-12)
Folder list	Touch an item on the list to select the folder.

*: Depending on the models, specifications and software versions, [TA] may be displayed on the main operation screens for some audio sources.

SMARTPHONE AUDIO (if equipped)

You can also listen to music from your compatible smartphone using Apple CarPlay or Android Auto.

 "Apple CarPlay" (page 5-15)

 "Android Auto™" (page 5-19)

Connecting smartphone

Connect the iPhone or Android phone to the USB connection port.

 "USB (Universal Serial Bus) connection ports" (page 2-5)

Depending on the models, iPhone devices can also be connected wirelessly for Apple CarPlay.

 "Connecting wirelessly" (page 5-16)

Smartphone audio operation

1. Connect the iPhone or Android phone and activate Apple CarPlay or Android Auto.
2. Push **<AUDIO>**.
3. Touch [Source].
4. Touch [Apple CarPlay] or [Android Auto] in the audio source menu screen, and the smartphone audio starts activating.

 "Selecting audio source" (page 3-7)

AUDIO SETTINGS

Audio settings can be adjusted or audio related functions can be turned on/off with the following procedure.

Touch [Settings] on the Launch Bar, and then touch [Sound].

Available setting items may vary depending on models, specifications and software versions.

Setting items	Action
[Bass]	Adjust the speaker tone quality and sound balance by touching [-]/[+], [L]/[R] or [R]/[F].
[Mid]/[Middle]	
[Treble]	
[Balance]	
[Fader]/[Fade]	
[Bass Enhancer]	When this item is turned on, the system enhances bass sound.
[Speed-Sensitive Vol.]/[Speed Sensitive Vol.]	Automatically adjusts the volume depending on the vehicle speed. Touch [-]/[+] to change the sensitivity level.

USB MEMORY DEVICE CARE AND CLEANING

USB MEMORY DEVICE

- Never touch the terminal portion of the USB memory device.
- Do not place heavy objects on the USB memory device.
- Do not store the USB memory device in highly humid locations.
- Do not expose the USB memory device to direct sunlight.
- Do not spill any liquids on the USB memory device.

Refer to the USB memory device Owner's Manual for the details.

AUDIO ADJUSTMENTS WITH AUDIO ADJUST BAR

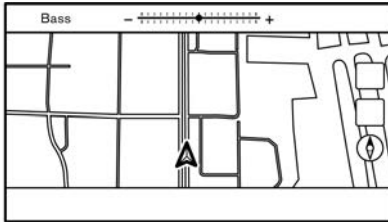

Example

Sound quality can be adjusted with the following buttons.

- <PUSH SOUND/ *>
- <TUNE SCROLL/PUSH SOUND>*
- /ENTER SETTING>*

*: if equipped

When the list screen is not displayed, pushing any of the buttons listed above will display the audio adjustment bar. Each time the button is pushed, the menu will shift to the available setting items.

Turn the button to adjust the level of the selected setting item.

INFO:

This function may not be available when a menu is highlighted on the screen.

4 Hands-Free Phone

Bluetooth® Hands-Free Phone System	4-2
Phone screen	4-3
Indicators	4-3

Phone	4-4
Hands-free text messaging assistant	4-6
Phone and text message settings	4-10



BLUETOOTH® HANDS-FREE PHONE SYSTEM



WARNING:

- Use a phone after stopping your vehicle in a safe location. If you have to use a phone while driving, exercise extreme caution at all times so full attention may be given to vehicle operation.
- If you find yourself unable to devote full attention to vehicle operation while talking on the phone, pull off the road to a safe location and stop your vehicle before doing so.



CAUTION:

To avoid draining the vehicle battery, use a phone only after starting the engine.

Your vehicle is equipped with Bluetooth® Hands-Free Phone System. If you are an owner of a compatible Bluetooth® enabled cellular phone, you can set up the wireless connection between your cellular phone and the in-vehicle phone module. With Bluetooth® wireless technology, you can make or receive a phone call with your cellular phone in your pocket.

Once a cellular phone is connected to the in-vehicle phone module, the procedure for connecting the phone does not need to be performed again. Your phone is automatically selected with the in-vehicle phone module when the ignition switch is

placed in the ACC or ON position with the selected cellular phone turned on and carried in the vehicle.

You can register up to 6 different Bluetooth® devices in the in-vehicle phone module. However, you can talk on only one cellular phone at a time.

The Voice Recognition System (if equipped) supports phone commands, so dialing a phone number using your voice is possible.

 "Voice recognition" (page 7-2)

Before using the Bluetooth® Hands-Free Phone System, refer to the following notes.

- Wireless LAN (Wi-Fi) and the Bluetooth® functions share the same frequency band (2.4 GHz). Using the Bluetooth® and the wireless LAN functions at the same time may slow down or disconnect the communication and cause undesired noise. It is recommended that you turn off the wireless LAN (Wi-Fi) when using the Bluetooth® functions.
- Set up the wireless connection between a compatible cellular phone and the in-vehicle phone module before using the Bluetooth® Hands-Free Phone System.
- Some Bluetooth® enabled cellular phones may not be recognized by the in-vehicle phone module. Consult a NISSAN dealer for phone



compatibility.

- You will not be able to use a hands-free phone under the following conditions:
 - Your vehicle is outside of the phone service area.
 - Your vehicle is in an area where it is difficult to receive radio waves; such as in a tunnel, in an underground parking garage, behind a tall building or in a mountainous area.
 - Your cellular phone is locked in order to prevent dialing.
- When the radio wave condition is not ideal or ambient sound is too loud, it may be difficult to hear the other person's voice during a call.
- Immediately after the ignition switch is placed in the ACC or ON position, it may be impossible to receive a call for a short period of time.
- Do not place the cellular phone in an area surrounded by metal or far away from the in-vehicle phone module to prevent tone quality degradation and wireless connection disruption.
- While a cellular phone is connected through the Bluetooth® wireless connection, the battery power of the cellular phone may discharge quicker than usual.





- Consult a NISSAN dealer if the Bluetooth® Hands-Free Phone System seems to be malfunctioning.
- Some cellular phones or other devices may cause interference or a buzzing noise to come from the audio system speakers. Storing the device in a different location may reduce or eliminate the noise.
- Refer to the cellular phone Owner's Manual regarding the phone pairing procedure specific to your phone, battery charging, cellular phone antenna, etc.
- The antenna display on the screen may not coincide with the antenna display of some cellular phones.
- The battery display on the screen may not coincide with the battery display of some cellular phones.
- The microphone is located near the map light.
- Keep the interior of the vehicle as quiet as possible to hear the caller's voice clearly as well as to minimize its echoes.
- If reception between callers is unclear, adjusting the outgoing call volume may improve the clarity.
 "Control buttons and touch screen display" (page 2-2)



PHONE SCREEN

The phone screen can be displayed by following operations.

- Push <  > on the control panel (if equipped)
- Push <  > on the steering wheel
- Touch [Phone] on the Launch Bar

Available items

Menu item	Action
[Quick Dial]	Displays the Quick Dial screen.  "Making a call" (page 4-4)
[Phonebook]	Displays the phonebook screen.  "Making a call" (page 4-4)
[Call History]	Displays the call history screen.  "Making a call" (page 4-4)
[Dial Number]	Displays the phone number entry screen.  "Making a call" (page 4-4)
[Text Message]	Displays the received message list screen.  "Displaying received message list" (page 4-7)

[Connections]	Displays the Connections screen.  "Setting devices" (page 2-12)
[Volume]	Displays the volume adjustment screen.  "Volume settings" (page 4-11)

INFO:

Depending on the connected device, some functions cannot be used.



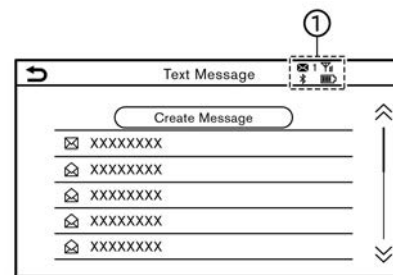

INDICATORS



Example

When a cellular phone is connected through the Bluetooth® wireless connection, indicators ① for phone and text messaging are displayed on the top of the screen.

Available indicators may vary depending on models, specifications and software versions.

	Indicates the number of unread received messages.
	Indicates that Bluetooth® device(s) are connected.
	Indicates the strength of the signal the Bluetooth® device is receiving.
	Indicates the amount of remaining Bluetooth® device battery.

PHONE

Connecting Bluetooth® Hands-Free Phone

A cellular phone device must be connected to the Bluetooth® Hands-Free Phone System before operation. Up to 6 Bluetooth® devices can be registered to the system.

 "Setting devices" (page 2-12)



Phone selection

Follow the instructions below to select a connected device for use with the Bluetooth® Hands-Free Phone System:

1. Touch [Phone] on the Launch Bar.
2. Touch [Connections] and touch [Devices]. A list of the connected cellular phones is displayed.
3. Touch one of the connected cellular phones from the list.

When the connection is successful,

"Connected" is displayed under the device name.



If  is displayed in gray, touch .

INFO:

To select a phone, the Bluetooth® of the cellular phone needs to be turned on.

Making a call

1. Touch [Phone] on the Launch Bar.
2. Select one of the following methods to make a call.

[Quick Dial]	Select a telephone number registered as a Quick Dial number.  "Quick Dial" (page 4-12)
[Phonebook]	Select a person and the phone number you wish to call from the phonebook. Depending on the device, the phonebook will be downloaded from the cellular phone automatically when it is connected. If the automatic download does not take place, the telephone number must be transferred to the hands-free phone system from the cellular phone prior to using this method.  "Phone settings" (page 4-10)
[Call History]	Select a telephone number from recent incoming, outgoing or missed calls.

[Dial Number]	Enter the phone number manually using the keypad displayed on the screen.
---------------	---

INFO:

Either of the connected phone devices can be selected for dialing operation when [Allow 2 Phones Simultaneously] is turned on.

 "Bluetooth® settings" (page 2-13)

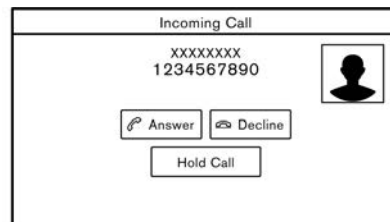

Receiving a call



When you receive a phone call, the display switches to the Incoming Call screen and the ringtone is played through the vehicle's audio system.

Taking a call:

To answer the call, take one of the following actions.

- Push <   on the steering wheel.
- Touch [Answer].

Rejecting a call:

To reject the call, take one of the following actions.

- Push and hold <  > on the steering wheel.
- Touch [Decline].

Holding a call:

To hold the call, touch [Hold Call].

INFO:

If [Allow 2 Phones Simultaneously] is turned on, two hands-free phone devices can be connected at the same time. If one of the connected devices receives an incoming call while the other device is already online, a pop-up message will appear to inform that answering the call will hang up the line of the other connected device. Touch [Answer] to answer the call and hang up the line on the other device. Touch [Decline] to continue the conversation on the other device.

During a call



Example

The Call in Progress screen will appear during a call.

To hang up the phone, touch [Hang Up]/[Hang up].

Operations during a call:

There are some options available other than hanging up a call or answering/rejecting incoming calls.



Touch one of the following displayed keys on the screen to take action.

Available item	Action
[Use Handset]	Transfer the call to the cellular phone.
[Mute]	When muted, your voice will not be heard by the person on the other end of the line.

[Dial Number]	Using the touch tone, send digits to the connected party for using services such as voicemail.
[Switch Call]*	Answer another incoming call. The person you are talking to will be placed on hold. Touch once more to speak to the person on hold again.

*: Available when a call is received while on the line with another person. The availability of this function depends on the cellular phone.

INFO:

To adjust the person's voice to be louder or quieter, push <  > on the steering wheel or turn <  /VOL>/<VOL/PUSH  >/<VOL/PUSH POWER> on the control panel while talking on the phone.

Call from a second person:

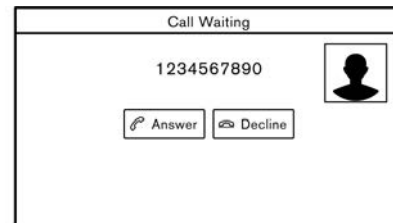

When another phone call is received during a call, the Call Waiting screen will

appear.

Answering call from a second person:

To answer the call from the second person and place the first caller on hold, take one of the following actions.

- Push < > on the steering wheel.
- Touch [Answer].

Rejecting call from a second person:

To reject a call from the second person and continue the conversation with the first caller, touch [Decline].

During a call with a second person:

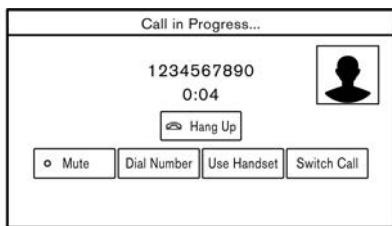

Example

To hang up the phone and return to the conversation with the first caller, touch [Hang Up]/[Hang up].

To switch between two calls on line, touch [Switch Call].

HANDS-FREE TEXT MESSAGING ASSISTANT

WARNING:

- **Use the text messaging feature after parking your vehicle in a safe location. If you have to use the feature while driving, exercise extreme caution at all times so full attention may be given to vehicle operation.**
- **Laws in some jurisdictions may restrict the use of "Text-to-Speech." Check local regulations before using this feature.**
- **Laws in some jurisdictions may restrict the use of some of the applications and features, such as social networking and texting. Check local regulations for any requirements.**
- **If you are unable to devote full attention to vehicle operation while using the text messaging feature, pull off the road to a safe location and stop your vehicle.**

CAUTION:

This feature is disabled if the connected device does not support it. Refer to the cellular phone Owner's Manual for details and instructions.

The system allows for the sending and receiving of text messages through the

vehicle interface.

The availability of the text message function may vary depending on the cellular phone.

Receiving a message

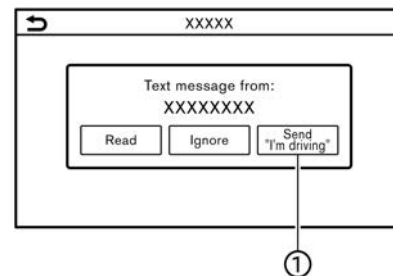

When the cellular phone connected to the vehicle receives a text message, a notification will appear on the touch screen display with a tone. (Depending on the models, the notification will also appear on the vehicle information display.)

To check the message, touch [Read]. Touch [Ignore] to save the message to be checked later.

If you want to respond using a predefined message, touch the message for auto reply ①.

The text message for auto reply can be edited.

"Phone settings" (page 4-10)

INFO:

- Depending on the cellular phone, the notification display setting may need to be activated on the cellular phone.
- Whether to read or ignore the message can be selected operating the switch on the steering wheel. Push <  > to read the message. Push and hold the switch to ignore the message.

Displaying received message list

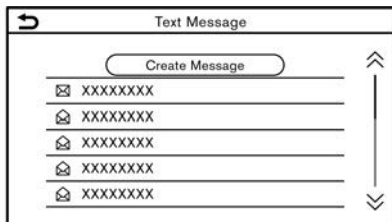

1. Touch [Phone] on the Launch Bar.
2. Touch [Text Message].
3. Touch an item on the list to read or reply to the message.

INFO:

- Up to 100 messages can be stored in the message list.
- Either of the connected phone devices can be selected for text message viewing operation when [Allow 2

Phones Simultaneously] is turned on.
 "Bluetooth® settings" (page 2-13)

Received message screen

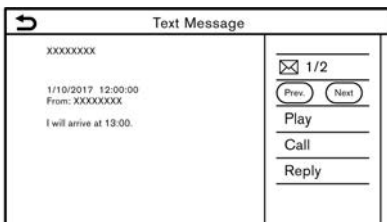

Example





Touching [Read] on the new message notification screen or selecting a message from the message list will show the details of the received message on the display.

Available actions:

- [Prev.]:
Touch to read the previous message.
- [Next]:
Touch to read the next message.
- [Play]/[Stop]:
Touch [Play] to have the hands-free phone system read out the received message. Touch [Stop] to stop reading.
- [Call]:
If the sender of the message is registered in the phonebook, touch this icon to make a call to the sender.

- [Reply]:
A reply message can be selected from the template.
 "Sending a text message" (page 4-8)

INFO:

- Depending on the models, push <  > (if equipped) on the steering wheel to read the previous or next message.
- Depending on the models, the text message can also be viewed and be operated on the vehicle information display. Refer to the vehicle Owner's Manual for details of the vehicle information display.
- Depending on the language setting, the "Text-to-Speech" function may not be available.
- Available keys may vary depending on the situations and models.
- If the sender's name and phone number are registered in the phonebook, the name of the sender is displayed when a message is received.
- To adjust the message reading voice volume, push <  > on the steering wheel or turn <  /VOL>/<VOL/PUSH  >/<VOL/PUSH POWER> on the control panel.

Sending a text message

This function may not be supported depending on the cellular phone.

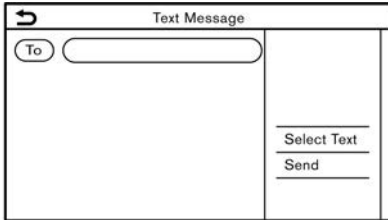

1. Touch [Phone] on the Launch Bar.
2. Touch [Text Message].
3. Touch [Create Message].

INFO:

Either of the connected phone devices can be selected for text message sending operation when [Allow 2 Phones Simultaneously] is turned on.

 "Bluetooth® settings" (page 2-13)

The following items are available.

Available item	Action	
[To]	[Enter Number with Keypad]/ [Enter Number by Keypad]	Enter the phone number of the recipient using the keypad. Touch [OK] to confirm.
	[Quick Dial]	Select a recipient from the Quick Dial list.
	[Phonebook]	Select a recipient from the phonebook.
	[Call History]	Select a recipient/phone number from call history.

[Select Text]	[Fixed]	Touch to display a list of fixed text messages.
	[Customised]/[Customized]	Touch to display a list of custom text message templates. Custom text can be created or edited from the setting menu.  "Phone and text message settings" (page 4-10)
[Send]		Touch to send the message.

PHONE AND TEXT MESSAGE SETTINGS

Phone settings



Bluetooth® Hands-Free Phone System settings can be changed according to the user's preference.

Touch [Phone] on the setting menu screen.

 "System settings" (page 2-10).

Available setting items may vary depending on models, specifications and software versions.

Available setting items

Setting item		Action
[Connections]		Displays the Connections screen. Phone connection, selection, deletion and other features are available.  "Connections settings" (page 2-12)
[Quick Dial]	[Edit]	Entries in the Quick Dial can be edited. Touch [Add New] to register a new entry.  "Quick Dial" (page 4-12)
	[Delete All]	Deletes all of the phone numbers in the Quick Dial.
[Phonebook]	[Download Entire Phonebook]	All of the phone numbers that are stored in a phonebook of a cellular phone that is connected to the vehicle are downloaded at once.
	[Auto Download]/[Auto Downloaded]	Turns on/off automatic downloading of the phonebook from the connected cellular phone.
	[Sort Phonebook by]	Changes the sorted order of contacts in the phonebook.
[Text Message]	[Text Message]	Turns the text messaging function on/off.
	[Text Message Ringtone]	Turns the incoming message sound on/off.
	[Signature]	Turns the signature setting for the outgoing text message on/off.
	[Auto Reply]	Turns on/off the automatic text message reply function.
	[Auto Reply Text Message]	Selects the text message to be used for the automatic reply function.
	[Edit Custom Text]	Creates or edits a customized text message reply.

[Notifications]	[Driver Only]	When this item is turned on, incoming call notification is displayed only in the vehicle information display.
	[Ringtone]	Turns the vehicle ringtone on/off.
[Automatic Hold]		When this item is turned on, an incoming phone call will be put on hold automatically.



INFO:

The phone settings will become inoperable while Apple CarPlay (if equipped) or Android Auto (if equipped) is active.

Volume settings

Volume settings can be adjusted.

1. Touch [Phone] on the Launch Bar.
2. Touch [Volume].

The following volume setting items are available.

Setting items	Action
[Ringtone]	Adjusts the volume level of the ringtone of incoming calls.
[Outgoing Call]	Adjusts the volume level of the outgoing calls.



INFO:

The volume settings can also be accessed from the setting menu screen.

"System settings" (page 2-10)

Quick Dial

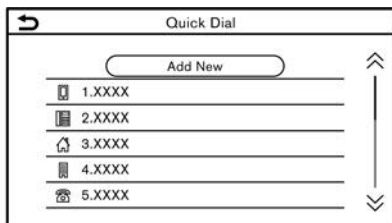

Up to 20 Quick Dial entries can be registered.

Quick Dial entries can be used to quickly make a call or send text messages.

Registration:

1. Touch [Phone] on the Launch Bar.
2. Touch [Quick Dial].
3. Touch [Edit].
4. Touch [Add New] to register a phone number to the Quick Dial list.
5. Select a method for registration.

Available methods:

- [Copy from Call History]:
A phone number can be selected from [All], [Incoming], [Outgoing], or [Missed] call history lists.
- [Copy from Phonebook]:
A phone number can be selected from the phonebook.
- [Enter Number with Keypad]/[Enter Number by Keypad]:

A phone number can be entered manually using keypad.

INFO:

Available methods may vary depending on cellular phone support.

6. When a phone number has been selected, the registration screen is displayed. Enter the phone number and edit the entry information as necessary.
7. Touch [OK] to save the entry.

INFO:

- Quick Dial entries can also be registered from [Phone] on the setting menu screen.
☞ "Phone settings" (page 4-10)
- Either of the connected phone devices can be selected for dialing operation when [Allow 2 Phones Simultaneously] is turned on.
☞ "Bluetooth® settings" (page 2-13)

Voice Tag (if equipped):

A voice tag can be recorded for each of the registered Quick Dial numbers and can be used to dial the number by speaking it.

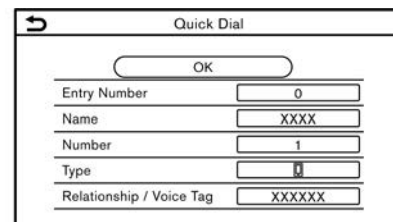

On the Quick Dial registration screen, select [Relationship / Voice Tag].

- Select a preferred relationship from the list.
- Touch [Customise]/[Customize] and touch [Record] to register your original voice tag.

INFO:

- Touch [Play] to play the recorded voice tag.
- Touch [Delete] to delete the voice tag.

5 Information





Information menu	5-2	Apple CarPlay (if equipped)	5-15
Updating system software (if equipped)	5-4	Compatibility	5-15
NissanConnect Services (if equipped for Europe, Russia and Ukraine)	5-5	Connecting iPhone	5-15
Privacy policy NissanConnect Services	5-5	Apple CarPlay operation	5-16
NissanConnect Services menus	5-6	Apple CarPlay settings	5-18
NissanConnect Services settings	5-6	Apple CarPlay system limitations	5-19
NissanConnect Services powered by SiriusXM™ (for Mexico)	5-6	Android Auto™ (if equipped)	5-19
Subscription to NissanConnect Services	5-6	Compatibility	5-19
Important information regarding access to NissanConnect Services	5-6	Initial Android Auto settings	5-20
NissanConnect Services features	5-8	Android Auto operation	5-20
NissanConnect Services menus	5-10	Android Auto settings	5-21
Emergency support (if equipped)	5-12	Android Auto system limitations	5-22
NissanConnect Services settings	5-14	Siri Eyes Free (if equipped)	5-22
		Requirements	5-22
		Siri Eyes Free activation	5-22
		Operating Siri Eyes Free	5-22





INFORMATION MENU

The information screen sets or displays various information.

Push **<MENU>** and then touch [Info] on the Launch Bar to display the Information menu.

Available items may vary depending on models, specifications and software versions. Items displayed on the screen may not function depending on various conditions.

Menu item		Action
[Notifications]		Displays a list of notifications.  "Swipe-down notifications" (page 2-9)
[Vehicle]/[Vehicle Reports]	[Eco Drive Report]	Displays the eco drive report screen.
[NissanConnect Services]		Displays the NissanConnect Services menu screen.  "NissanConnect Services (if equipped for Europe, Russia and Ukraine)" (page 5-5)  "NissanConnect Services powered by SiriusXM™ (for Mexico)" (page 5-6)
[Traffic Information]		Displays the Traffic Information screen.
[Premium Traffic]		 "Viewing traffic information" (page 6-26)
[Where Am I?]		The name and distance of the next/previous street, and other information that indicates the current vehicle location are displayed. Latitude and longitude of the current vehicle location are shown on the bottom right.
[Weather Data Communication]/[TomTom Weather]	[Current Conditions]	Current, hourly or 5-day weather information is displayed.
	[Hourly Weather Forecast]	Weather information for nearby location, near the destination and your preferred city set as a Favorite City can be confirmed.
	[5-Day Weather Forecast]	Current, hourly or 5-day weather information can be changed by touching [Current], [Hourly] or [5-Day]. Nearby location, near the destination and your preferred city can be changed by touching [Nearby], [Near Dest.] or [Favourite City]/[Favorite City]. Favorite city can be changed by touching [Change City].
	[Communication Settings]	Turns the TomTom weather data transmission on/off.

Menu item		Action
[System Information]	[Version Information]	Displays the version information screen.
	[Software Update]	The system software can be updated.  "Updating system software" (page 5-4)
	[Map Update]	The map data can be updated.  "How to update map data" (page 6-44)
	[Licence Information]/[License Information]	Displays the Open Source Software licenses information.
[GPS Position]		Displays Global Navigation Satellite System (GNSS) information, such as number of satellites, latitude/longitude, and approximate altitude, etc.
[Vehicle Data Transmission]		When [OK] is touched, data transmission to NISSAN is enabled. Touching [Decline] disables some functions such as Premium Traffic.
[Smartphone Connection]	[Apple CarPlay]	Displays the Apple CarPlay screen.  "Apple CarPlay" (page 5-15)
	[Android Auto]	Displays the Android Auto screen.  "Android Auto™" (page 5-19)

UPDATING SYSTEM SOFTWARE (if equipped)



WARNING:

TO AVOID RISK OF DEATH OR SERIOUS PERSONAL INJURY WHEN UPDATING THE SYSTEM SOFTWARE:

If you choose to park the vehicle within range of a Wi-Fi connection (if equipped), park the vehicle in a secure, safe well-ventilated location that is open to the air. During the update process, if you choose to park your vehicle, it should be kept in a well-ventilated area to avoid exposure to carbon monoxide. Do not breathe exhaust gases; they contain colorless and odorless carbon monoxide. Carbon monoxide is dangerous. It can cause unconsciousness or death.

1. **Apply the parking brake.**
2. **Remain with the vehicle while the update is in process.**
3. **Do not allow children, pets or people who may need assistance to remain in the vehicle while the software is updating.**



NOTE:

The vehicle is not required to be parked during the software update process. If the vehicle disconnects from the Wi-Fi connection (if equipped), it will resume when the vehicle reconnects to a known Wi-Fi connection.





INFO:

- The system prioritizes Wi-Fi connection (if equipped) over TCU (Telematics Control Unit) (if equipped) when Wi-Fi network connection is available.
- You will be charged separately when the network communication is made via smartphones.
- The download data size of software updates can vary between 80 MB and 300 MB. If you use your smartphone as a Wi-Fi connection, you may incur data charges from your phone carrier. Please connect to a secure WPA2 Wi-Fi network to avoid potential phone carrier data charges.

How to update from the pop-up screen

When both of the following conditions are met, the system informs the driver with a pop-up on the screen when system software update is available.

- [Auto] is selected under [Update Method].
 "How to update from the system menu" (page 5-5)
 - Wi-Fi (if equipped) or TCU (Telematics Control Unit) (if equipped) network connection is available.
 "Wi-Fi setting" (page 2-14)
1. When the pop-up appears and prompts the driver to perform the system software update, operate the system according to the guides shown on the screen to download the updates. Another pop-up will appear when downloading is complete.
 2. After the system software update is complete, place the ignition switch in the OFF position and leave the system for 20 minutes without operating the switches on the control panel and the steering wheel. Place the ignition switch in the ON position and the updated software will be available.



INFO:

- The update may not be reflected if the ignition switch is placed back in the ON position before the 20-minute period has passed.
- In some cases, updates can only be performed via TCU (Telematics Control Unit) (if equipped).

- In some cases, the pop-up message may appear even when [Manual] is selected under [Update Method].

How to update from the system menu



WARNING:

To operate the system for software update, first park the vehicle in a safe location.

System software updates can be downloaded manually via Wi-Fi (if equipped) or TCU (Telematics Control Unit) (if equipped) from the system menu.

1. Connect to network via Wi-Fi (if equipped) if you wish to perform the software update via Wi-Fi connection.
 - ☞ “Wi-Fi setting” (page 2-14)
2. Push <MENU>.
3. Touch [Info] on the Launch Bar and then touch [System Information].
4. Touch [Software Update].

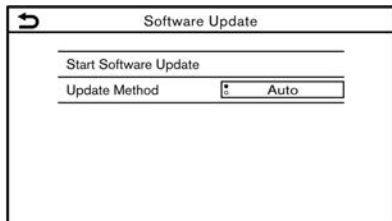

5. Touch [Start Software Update].



INFO:

When [Update Method] is set to [Auto], a notification is made in case that software can be updated.

6. Touch [Download] to start downloading and updating the system software.
7. After the system software download is complete, place the ignition switch in the OFF position and leave the system for 20 minutes without operating the switches on the control panel and the steering wheel. Place the ignition switch in the ON position and the updated software will be available.



INFO:

- The update may not be reflected if the ignition switch is placed back in the ON position before the 20-minute period has passed.
- Depending on the models, specifications and software versions, the same operation can be performed from [System Update]/[System Updates] on the setting menu screen.
 - ☞ “System settings” (page 2-10)

NISSANCONNECT SERVICES (if equipped for Europe, Russia and Ukraine)

This vehicle incorporates a communication device that is called TCU (Telematics Control Unit). The communication connection between this unit and the Nissan Data Center allows for various services.

For Europe:

For details, refer to the NissanConnect Services app and YOU+Nissan Owners' Portal.

For Russia:

For details, refer to the NissanConnect Services app and <https://www.nissan.ru>.

For Ukraine

For details, contact a NISSAN dealer.

PRIVACY POLICY NISSANCONNECT SERVICES

The transferred personal data will be stored only for period necessary for the processing, and will be then deleted or anonymized.

For Europe:

For any further information in relation to the retention period and the protection of your personal data, please refer to the Terms and Conditions available in the NissanConnect Services app and YOU +Nissan Owners' Portal.

For Russia:

For any further information in relation to the retention period and the protection of your personal data, please refer to the Terms and Conditions available in the

NissanConnect Services app and <https://www.nissan.ru>.

For Ukraine:

For any further information in relation to the retention period and the protection of your personal data, please contact a NISSAN dealer.

NISSANCONNECT SERVICES MENUS

With NissanConnect Services, various information can be received and displayed on the screen. The information can also be announced by the system.

NISSANCONNECT SERVICES SETTINGS

NissanConnect Services settings can be changed.

1. Touch [Info] on the Launch Bar.
2. Touch [NissanConnect Services].
3. Touch [NissanConnect Services Settings].

Available setting items may vary depending on models, specifications and software versions.



INFO:

[NissanConnect Services] can also be accessed from [Settings] on the Launch Bar.

Setting items	Action
[Information Channel Setting]	Displays the Information Channel Setting screen.
[Unit ID Information]	Displays the Unit ID Information screen.
[Reset all NissanConnect Svcs. Settings to Default]	All NissanConnect Services settings are returned to default.
[Privacy Mode Setting]	Allows you to accept or decline the Privacy Mode setting.



INFO:

What happens when Privacy Mode is ON?

When Privacy Mode is ON (by declining NissanConnect Services while switching on your vehicle or via the NissanConnect Services settings), your data will not be processed for purposes relating to NissanConnect Services. They might however be processed for the purpose of services other than NissanConnect Services which are (i) either mandatory (such as eCall in Europe, or Glonass in Russia), (ii) that you might have activated independently and manually (such as bCall, concierge service, co-pilot button), or (iii) relating to services that you have subscribed to and remains activated for your safety (SVT, theft/burglar notification).

NISSANCONNECT SERVICES POWERED BY SiriusXM™ (for Mexico)

SUBSCRIPTION TO NISSANCONNECT SERVICES

Subscription is required to use the NissanConnect Services. For the details about the subscription, visit the Nissan Owner Portal or contact a Nissan Mexicana dealer.

NissanConnect Services are offered by SiriusXM™ or other third party vendors in accordance with the terms and conditions and the privacy policies outlined in a Subscription Agreement.

IMPORTANT INFORMATION REGARDING ACCESS TO NISSANCONNECT SERVICES

Feature availability is dependent on vehicle model, trim level, packaging and options. Compatible connected device may be required and feature availability may be dependent on device's capability. Refer to connected device's owner's manual for details. Late availability for some features.

Driving is serious business and requires your full attention. Only use features and connected devices when safe and legal to do so. Some features, including automatic crash notification and SOS, are dependent upon the telematics device being in operative condition, its ability to connect to a wireless network, compatible wireless network availability, navigation map data and GNSS signal receptions, the absence of which can limit or prevent the ability to reach Customer Care or

receive support. GNSS mapping may not be detailed in all areas or reflect current road status. Never program GNSS while driving. Only use Remote Engine Start and Remote Horn features in accordance with any laws, rules or ordinances in effect in your vehicle's location.

Some services and features are provided by independent companies not within NISSAN's control. Should service provider terminate or restrict service or features, service or features may be suspended or terminated without notice or with no liability to NISSAN or its partners or agents. Services and features may require compatible cellular network provided by independent companies not within NISSAN or its partners' or agents' control. Cellular network signal strength may vary and may not be available in all areas or at all times. Services and features may not function if cellular network is unavailable, restricted, or terminated. NISSAN and its partners or agents are not responsible for associated costs or other third party changes that may be required for continued operation due to cellular network unavailability, restriction, or termination (including equipment replacements/upgrades, if available, or roaming charges on alternative networks). Technology is evolving, and changes by independent companies are not within NISSAN's or its partners' or agents' control.

Enrollment, owner consent, personal

identification number (PIN), and subscription agreement may be required to receive full suite of features and services. Trial periods (if applicable) begin on the date of vehicle purchase or lease of a new NISSAN. Trial periods may be subject to change at any time and may be subject to early termination without notice. Required subscriptions may be sold separately for each available feature or service after trial period ends, and may continue until you call service provider to cancel. Installation costs, one-time activation fee, other fees and taxes may apply. Fees and programming subject to change. Feature may be subject to age restrictions in some areas. Subscriptions governed by service provider's subscription agreement, terms and conditions and privacy statements available at service provider's website.

NissanConnect Services is a collection of security and convenience services that add innovation to your daily drive.

If equipped, your vehicle may include NissanConnect connected features and services such as Emergency SOS calling, Automatic Collision Notification, Wi-Fi, Remote Services, Navigation, Bluetooth® and more. For complete information about your NissanConnect features and services, please consult your vehicle's NissanConnect Owner's Manual at www.nissan.com.mx/nissan-connect.

For frequently asked questions, please

visit www.nissan.com.mx/nissan-connect.

For full details on NissanConnect Services or to enroll your vehicle, please visit www.nissan.com.mx/nissan-connect.

You can enroll your NissanConnect Services with your dealer or into the Customer Web Portal "<https://www.nissanconnectservices.mx/nissan-owners/>" by creating an account with your Vehicle Identification Number (VIN) and your personal data. Follow the prompts to enroll in NissanConnect Services.

Some of the available NissanConnect Services include:

- **Automatic Collision Notification (if equipped):**
A service that generates an automatic connection between the vehicle and a live response specialist when the vehicle has been involved in an accident that was severe enough to deploy the air bags.
- **Emergency Call (if equipped):**
Connects you to a live response specialist who will assist in the dispatch of emergency services to the vehicle location. To use this feature, push the Emergency Call (SOS) button near the map light. The Emergency Call (SOS) button should only be used in emergency situations or in conjunction with the Roadside Assistance feature (if equipped), if warranted.

- **Wi-Fi Hotspot (if equipped):**

Enables you to connect up to seven devices to the vehicle and access the Internet when a service provider's subscription is active.

NISSANCONNECT SERVICES FEATURES

NissanConnect Services provides various types of information and services by connecting your vehicle to the NissanConnect Services Data Center and NissanConnect Services Response Center using the TCU (Telematics Control Unit) installed in your vehicle.

If equipped, your vehicle may include NissanConnect connected features and services such as Emergency SOS calling, Automatic Collision Notification, Remote Services, Navigation, Wi-Fi, Bluetooth® and more. For complete information about your NissanConnect features, enrollment and services, please visit www.nissan.com.mx/nissan-connect.



WARNING:

- **Please note that the Automatic Collision Notification service (if equipped) and Emergency Call function (if equipped) cannot be used in the following conditions:**
 - **Emergency functions and services will not be available without a paid subscription to NissanConnect Services.**

- **The NissanConnect Services network system is disabled.**

- **The vehicle moves outside the service area where the TCU (Telematics Control Unit) is connected to the system.**

- **The vehicle is outside the area where the cellular network service is receivable.**

- **The vehicle is in a location with poor signal reception such as tunnels, underground parking garages, behind buildings or in mountainous areas.**

- **The line is busy.**

- **The TCU (Telematics Control Unit) or other systems of your vehicle are not working properly.**

- **It may not be possible to make an emergency call depending on the severity of a collision and/or emergency.**

- **Radio waves could adversely affect electric medical equipment. Individuals who use a pacemaker should contact the device manufacturer regarding any possible effects before using the system.**
- **The TCU (Telematics Control Unit) antenna is installed inside the upper part of the instrument panel. An occupant should not get any closer**

to the antenna than specified by the pacemaker manufacturer. The radio waves from the TCU antenna may adversely affect the operation of the pacemaker while using the NissanConnect Services.



INFO:

- NissanConnect Services features are dependent upon subscription enrollment and the telematics device being in operative condition, cellular connectivity, navigation map data and GNSS signal reception. Terms and conditions of the NissanConnect Services Subscription Agreement apply.
- Enrollment is required in order to use NissanConnect Services. The services that can be received vary depending on the plan in which you are enrolled.
- All services are complimentary for the trial period.
- After the trial period, use of the service will no longer be complimentary.
- Laws in some jurisdictions may restrict the use of "Text-to-Speech." Check local regulations before using this feature.

If equipped, your vehicle may include NissanConnect Services features such as Emergency SOS calling, Automatic Collision Notification, Wi-Fi, Remote Services, Navigation, Bluetooth® and more. Nissan-

Connect Services may be updated. The latest detailed information is available on the following website or from the support line.

NissanConnect Services website:

www.nissan.com.mx/nissan-connect

NissanConnect customer support line:

800 9647726

- **Automatic Collision Notification (if equipped):**

The TCU (Telematics Control Unit) generates a signal automatically to the NissanConnect Services Response Center in the case of an accident severe enough to trigger one of the vehicle's air bags. Upon the signal, a Response Specialist receives the vehicle location and customer information and notifies the proper authorities in accordance with established policies and procedures.

- **Emergency Call (if equipped):**

The Emergency Call feature provides emergency assistance by connecting to a Response Specialist. In the event of an emergency, push the in-vehicle Emergency Call (SOS) button to use this feature. The Response Specialist provides various assistance depending on the situation.

 "Emergency support" (page 5-12)

- **Connection to Roadside Assistance (if equipped):**

Roadside Assistance allows you to receive assistance from the Roadside Response Specialist for a non-emergency incident that requires a towing or third-party response service. The service can be accessed by touching [Call Nissan Assistance] or  (if equipped) on the screen.

 "Connecting to Interactive Voice Menu" (page 5-11)

Roadside Assistance may also be used in conjunction with the Emergency Assistance service, if warranted.

 "Emergency support" (page 5-12)

Notice to Bluetooth® Hands-Free Phone users

The Bluetooth® Hands-Free Phone System will be disabled and not be able to take phone calls while the vehicle is connected to the NissanConnect Services Response Specialists or the emergency support staff at the NISSAN Response Center.

This is to avoid NissanConnect Services Response Specialists and NissanConnect Services emergency support staff from being interrupted by incoming calls. Incoming phone calls received while the vehicle is connected to the Service Center will not be listed in the call history of the Bluetooth® Hands-Free Phone System. However those incoming calls may be

listed in the call history of your mobile phone, depending on its capabilities. After disconnecting communication with the NissanConnect Services Response Specialist or NissanConnect Services emergency support staff, check the incoming call history on your mobile phone when it is safe to do so.

Service subscription

A separately purchased NissanConnect Services subscription is required. For detailed information, contact a NISSAN dealer or refer to the following NissanConnect Services website:

www.nissan.com.mx/nissan-connect

INFO:

If the vehicle is owned by another person and is resold, the subscription for this service must be canceled and all data stored on the device must be deleted.

Operating tips

WARNING:



- **Use the NissanConnect Services after stopping your vehicle in a safe location. If you have to use the NissanConnect Services while driving, exercise extreme caution at all times so full attention may be given to vehicle operation.**

- **If you are unable to devote full attention to vehicle operation while talking with the NissanConnect Services, pull off the road to a safe location and stop your vehicle.**
- Do not use the NissanConnect Services with the engine stopped. Doing so may discharge the vehicle battery.
- The NissanConnect Services cannot be used under the following conditions:
 - The NissanConnect Services subscription has expired.
 - The vehicle is outside the area where the cellular network service is receivable.
 - The vehicle is in a location with poor signal reception such as tunnels, underground parking garages, behind buildings or in mountainous areas.
 - The line is busy.
 - The TCU (Telematics Control Unit) or other systems of your vehicle are not working properly.
 - The NissanConnect Services network system is disabled.
- Communication with the NissanConnect Services Data Center is related to the data communication mode and may cause occasional difficulty in receiving signals, and the signal reception

area may be limited compared to regular mobile phones.

- You may hear clicks or experience interruptions while speaking with the NissanConnect Services Response Specialists. This is due to a shift in the connection zone and is not a malfunction.
- Depending on the line used, the sound volume may decrease. Adjust the volume as necessary.
- Received sounds may be distorted or ambient noise may sound like voices of a crowd. This is due to the use of the digital line and is not a malfunction.
- You may hear your own voice from the speaker when talking with the NissanConnect Services Response Specialists due to a network disturbance. When this occurs, reconnect the line after a few minutes or at a different location.
- This vehicle incorporates a communication device that is called a TCU (Telematics Control Unit). The communication connection between this unit and the NissanConnect Services Data Center allows for various services. When the system connects to the NissanConnect Services Data Center, an antenna icon will appear on the screen. Use the service in a location where the symbol representing good

signal reception appears on the screen.

: When the signal reception is good
: When the signal reception is bad



- The NissanConnect Services use the TCU (Telematics Control Unit) for communications. Even if the signal strength bar of the in-vehicle data communication module indicates good reception, connection to the NissanConnect Services Data Center may be disabled. This does not indicate a malfunction. Operate the system again after a few minutes.

NISSANCONNECT SERVICES MENU

With NissanConnect Services, various information can be received and displayed on the screen. The information can also be announced by the system.

1. Push **<MENU>** and then touch [Info].
2. Touch [NissanConnect Services].
3. Select an item from the NissanConnect Services menu screens.

Available items may vary depending on models, specifications and software versions. Items displayed on the screen may not function depending on various conditions.

Available items	Content
[Call Nissan Assistance]	<p>The system connects to the NissanConnect Services center. Various services to support your driving are available by answering the Interactive Voice Menu.</p> <p> "Connecting to Interactive Voice Menu" (page 5-11)</p>
[History]	<p>Accesses the messages sent to the vehicle from the NissanConnect Services Data Center.</p> <p> "History" (page 5-11)</p>
[NissanConnect Services Settings]	<p>NissanConnect Services settings can be changed.</p> <p> "NissanConnect Services settings" (page 5-14)</p>

Connecting to Interactive Voice Menu

Various services to support your driving are available by using the Interactive Voice Menu. For more details, refer to the NissanConnect Services website or contact the NissanConnect customer support line.

NissanConnect Services website:

www.nissan.com.mx/nissan-connect



NissanConnect customer support line:

800 9647726

1. Push **<MENU>** and touch [Info] on the Launch Bar.
2. Touch [NissanConnect Services].
3. Touch [Call Nissan Assistance].
4. The system connects to the NissanConnect Services center and menu options will be announced. Speak your preferred option.

INFO:

- After selecting [Call Nissan Assistance], it may take some time until the system initiates connection, depending on the technical environment and whether the TCU (Telematics Control Unit) is being used by other services.

- To avoid disconnecting the line, do not turn off the engine.
- Models with navigation system: You can also connect to the NissanConnect Services Interactive Voice Menu by touching   on the map.

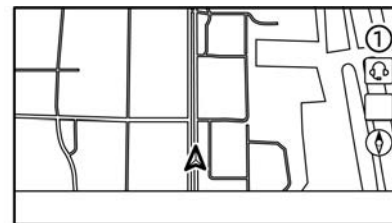

History

Messages received from the NissanConnect Services Data Center are displayed.

1. Push **<MENU>** and then touch [Info].
2. Touch [NissanConnect Services].
3. Touch [History].
4. A message list is displayed. Touch preferred message from the list.

INFO:

- Touch [Stop] during communication with the NissanConnect Services Data Center to cancel the connection.
- A message is displayed when the communication is disconnected while downloading information due to a

poor communication status. Select [Yes] to restart the download.

- Laws in some jurisdictions may restrict the use of "Text-to-Speech". Check local regulations before using this feature.
- Some terminology such as personal names, place names, special terms, symbols, etc. may not be announced correctly. This is not a malfunction.
- The system will pause announcements when interrupted by the voice guidance given by the navigation system (if equipped). When the voice guidance finishes, the system will restart the announcement.
- When the system is making announcements, the volume can be adjusted by turning **< VOL >** / **< VOL / PUSH >** / **< VOL / PUSH POWER >**.
- The selected content is read out while the vehicle is being driven, or if parked, you can read the content on the display.
- Content settings can be made using the NissanConnect Services website. For more details, refer to the NissanConnect Services website or contact the NissanConnect customer support line.

NissanConnect Services website:

www.nissan.com.mx/nissan-connect

NissanConnect customer support line:

800 9647726

EMERGENCY SUPPORT (if equipped)

NissanConnect Services provides various services to support dealing with emergencies of the subscribed vehicle and the driver.

For example, in case of an illness or serious injury, you can seek support by pushing the in-vehicle Emergency Call (SOS) button and connecting to the NissanConnect Services Response Center. The NissanConnect Services Response Center can specify the location of the vehicle via GNSS, and the information will be sent to the police or other agencies as needed.

For information about other NissanConnect Services emergency support related services, refer to the NissanConnect Services website or contact the NissanConnect customer support line.

NissanConnect Services website:

www.nissan.com.mx/nissan-connect

NissanConnect customer support line:

800 9647726



WARNING:

- **Please note that the Automatic Collision Notification service (if equipped) and Emergency Call function cannot be used in the following conditions:**
 - **Emergency functions and services will not be available without a paid subscription to NissanConnect Services.**
 - **The NissanConnect Services network system is disabled.**
 - **The vehicle moves outside the service area where the TCU (Telematics Control Unit) is connected to the system.**
 - **The vehicle is outside the area where the cellular network service is receivable.**
 - **The vehicle is in a location with poor signal reception such as tunnels, underground parking garages, behind buildings or in mountainous areas.**
 - **The line is busy.**
 - **The TCU (Telematics Control Unit) or other systems of your vehicle are not working properly.**
 - **It may not be possible to make an emergency call depending on the severity of a collision and/or**

emergency.

- Park the vehicle in a safe location and set the parking brake before operating the Emergency Call (SOS) button.
- Only use this service in case of an emergency. There may be a penalty for inappropriate use of the service.
- Radio waves could adversely affect electric medical equipment. Individuals who use a pacemaker should contact the device manufacturer regarding any possible effects before using the system.
- The TCU (Telematics Control Unit) antenna is installed inside the upper part of the instrument panel. An occupant should not get any closer to the antenna than specified by the pacemaker manufacturer. The radio waves from the TCU antenna may adversely affect the operation of the pacemaker while using the Nissan-Connect Services.

Making an emergency call



Type A



Type B

The Emergency Call (SOS) button is located near the map light.

1. Push the Emergency Call (SOS) button.
2. When the line is connected, speak to the Response Specialist.

If you want to cancel the emergency call, push and hold the Emergency Call (SOS) button for a few seconds.

INFO:

- If there is a cover on the Emergency Call (SOS) button, open the cover first.
- After the Emergency Call (SOS) button is pushed, it may take some time until the system initiates connection, depending on the technical environment and whether the TCU (Telematics Control Unit) is being used by other services.
- An indicator light on the Emergency Call (SOS) button shows the readiness of the emergency support system. If the indicator light is not illuminated, pushing the Emergency Call (SOS) button does not connect your vehicle to the Response Specialist.
The indicator light blinks while connected to the NissanConnect Services Response Center.
- Even when the indicator light is illuminated, connection to the Nissan-Connect Services Response Center may not be possible. If this occurs in an emergency situation, contact the authorities by other means.
- To avoid disconnecting the line, do not turn off the engine.

NISSANCONNECT SERVICES SETTINGS

The NissanConnect Services setting can be changed. Available menus may vary depending on models, specifications and software versions. Menus displayed on the screen may not function depending on various conditions.

1. Push **<MENU>**.
2. Touch [Info] on the Launch Bar.
3. Touch [NissanConnect Services].
4. Touch [NissanConnect Services Settings].



INFO:

[NissanConnect Services Settings] can also be accessed from [NissanConnect Services] on the settings screen.

"Settings menu" (page 2-10)

Menu		Action
[Vehicle Data Sharing]	[Share Vehicle Information]	Turns the vehicle information sharing function on/off.
	[Delete Shared Vehicle Data]	Deletes the shared vehicle information.
[Unit ID Information]		Displays the Unit ID, TCU (Telematics Control Unit) ID, SIM ID and VIN Information necessary for user registration.
[Reset all NissanConnect Svcs. Settings to Default]		All NissanConnect Services settings are returned to default.
[Vehicle Data Transmission Setting]		When [OK] is touched, data transmission to the NissanConnect Services Data Center is enabled. Touch [Decline] to disable the NissanConnect Services, Premium Traffic, etc.

Apple CarPlay (if equipped)



WARNING:

- **Stop your vehicle in a safe location and apply the parking brake before connecting your iPhone to the vehicle or operating your connected iPhone for setup.**
- **If you are unable to devote full attention to vehicle operation while using Apple CarPlay, pull off the road to a safe location and stop your vehicle.**

You can use Apple CarPlay by connecting a compatible iPhone to your vehicle via a USB cable or wirelessly (if equipped).

With Apple CarPlay, your in-vehicle system can be used as a display and a controller for some of the iPhone functions. Apple CarPlay features Siri which enables operations via voice controls. Visit apple.com for information about the functions that are available and details about Apple's privacy policy.

Certain vehicle information (e.g. location and speed) may be shared with your device while Apple CarPlay is in use. Carrier charges may apply to use Apple CarPlay.

COMPATIBILITY

Refer to the Apple website for compatible devices.



INFO:

- In some countries, iPhone in the market may not be supported by Apple CarPlay.
- For best results, always update your device to the latest software version.
- Apple CarPlay will take the place of your Bluetooth® audio and Bluetooth® hands-free phone functionality.
- Phone menu and access to the connected phone through Voice Recognition System (if equipped) will be disabled while Apple CarPlay is connected. To access your phone, use the Siri function or select the phone icon in the Apple CarPlay top menu screen.
- If you set a route guidance destination with Apple CarPlay, the route setting previously set on NissanConnect navigation system (if equipped) will be canceled.

CONNECTING iPhone

This system supports wireless Apple CarPlay (if equipped). To connect Apple CarPlay wirelessly, the Bluetooth® and Wi-Fi network must be available with the in-vehicle system before operation.

 "Setting devices" (page 2-12)

 "Wi-Fi setting" (page 2-14)



INFO:

Depending on the device and firmware version of the iPhone, wireless Apple CarPlay (if equipped) cannot be used. Always update your device to the latest software version.

Connecting with the USB cable



INFO:

To connect your iPhone with the in-vehicle system, it is recommended to use the Apple Lightning cable (Mfi certified) that was provided with your iPhone.

1. Connect the iPhone to the USB connection port.



 "USB (Universal Serial Bus) connection ports" (page 2-5)
2. Depending on the setting, a Startup Information screen will appear. Touch [Yes] to use Apple CarPlay.
3. Apple CarPlay starts and the Apple CarPlay screen will appear.

4. If a notification appears on the iPhone, select whether or not to use the wireless connection (if equipped). Once you enable wireless Apple CarPlay (if equipped) on the notification, Apple CarPlay will automatically start wirelessly from next time.

Connecting wirelessly (if equipped)

1. Connect the iPhone to the in-vehicle system via Bluetooth®.
 "Setting devices" (page 2-12)

INFO:

If no Bluetooth® device is connected and Apple CarPlay or Android Auto is not active, pushing and holding   on the steering wheel can display the Connections screen.

2. Depending on the setting, a Startup Information screen will appear. Touch [Yes] to use Apple CarPlay.
3. A notification will appear on the iPhone. Select to use the wireless connection.

INFO:

If you select not to use the wireless connection, the iPhone will be connected as a Bluetooth® device.

4. Wireless Apple CarPlay will start and the Apple CarPlay screen will appear.

INFO:



If the Wi-Fi connection is off on the Wi-Fi setting screen, a notification will appear. Touch [Yes] to use wireless Apple CarPlay.

 "Wi-Fi setting" (page 2-14)

Operating tips

- If you do not wish to display the Startup Information screen each time you activate Apple CarPlay, turn on [Don't Ask Any More]/[Don't Ask Any more] on the Startup Information screen. The Startup Information screen will not be displayed from the next Apple CarPlay activation. The Startup Information screen can be set to appear again in the Apple CarPlay setting menu.
 "Apple CarPlay settings" (page 5-18)
- The map update will be stopped while using wireless Apple CarPlay (if equipped).
- The connection with the other Bluetooth® device may be disconnected when wireless Apple CarPlay (if equipped) is activated.
- Once the wireless connection (if equipped) has been established, Apple CarPlay will be automatically connected wirelessly next time.
- Wireless Apple CarPlay (if equipped) uses the Wi-Fi network. After connecting the in-vehicle system to the Wi-Fi

network, the Bluetooth® connection with wireless Apple CarPlay (if equipped) connected device will be disconnected.

- If you connect the iPhone that is using wireless Apple CarPlay (if equipped) via USB cable, the in-vehicle system provides power to the iPhone.
- If wireless Apple CarPlay (if equipped) does not start automatically, touch  on the device settings screen.
 "Setting devices" (page 2-12)
- If you are using Apple CarPlay or Android Auto, you cannot start Apple CarPlay with the other iPhone. To use Apple CarPlay with the other iPhone, disconnect the current device, or deactivate Apple CarPlay or Android Auto on the Connections settings.
 "Connections settings" (page 2-12)

Apple CarPlay OPERATION

After starting Apple CarPlay, the iPhone functions displayed on the screen can be operated using the in-vehicle system.

INFO:

- After exiting the Apple CarPlay screen, return to the Apple CarPlay screen by taking one of the following actions.
 - Touch  on the Launch Bar.

- Touch [Smartphone Connection] on the information screen, and then touch [Apple CarPlay].
- When your iPhone is locked, Apple CarPlay can still be activated by operating the iPhone and allowing Apple CarPlay activation.

Siri operation

With Siri, some of the functions in your iPhone can be voice controlled.

Make sure that Siri on your iPhone is turned on.

Activation:

Push and hold <  > on the steering wheel to start a Siri session.



INFO:

- Push <  > to end Siri operation.
- Keep the interior of the vehicle as quiet as possible. Close the windows to eliminate the surrounding noises (traffic noises, vibration sounds, etc.), which may prevent the system from recognizing the voice commands correctly.
- For functions that can be used with Siri, please refer to the Apple website.

Phone operation

If you wish to use the phone with Apple CarPlay, follow the procedure below:

1. Touch [Phone] on the Apple CarPlay top menu.
2. Operate the screen displayed to make a call, etc.

Apple CarPlay SETTINGS

1. Push **<MENU>**.
2. Touch [Connections] on the Launch Bar and then touch [Devices].
3. Touch  by the iPhone name you wish to change the settings.
4. Touch [Smartphone Projection].

Available items:

Available setting items may vary depending on models, specifications and software versions.

Setting item 1	Setting item 2	Action
[Start-up Options]	[Auto]	Activates Apple CarPlay automatically when an iPhone is connected to the in-vehicle system.
	[Ask Every Time]	Displays the Apple CarPlay Startup Information screen when an iPhone is connected to the in-vehicle system.
	[Never Start]	Apple CarPlay will not activate even if an iPhone is connected to the in-vehicle system.
[Vehicle's Help for Apple CarPlay]		Displays helpful tips for Apple CarPlay operation.



INFO:

Access to songs on your iPod via in-vehicle voice recognition system (if equipped) will not be available when connected to Apple CarPlay. To access to your iPod music, use the Siri function or select the music icon in the Apple CarPlay top menu screen.

Android Auto™ (if equipped)

Apple CarPlay SYSTEM LIMITATIONS

For all features of Apple CarPlay to operate correctly, it is necessary to have a compatible iPhone, a cellular connection and a data plan.

When Apple CarPlay is operating, system performance is affected by the strength of the cellular connection or performance of the phone itself. If performance of the system decreases:

- Disconnect and reconnect your phone
- Cycle phone power off/on to restart

Changing government regulations may also affect operation of Apple CarPlay.



WARNING:

- **Stop your vehicle in a safe location and apply the parking brake before connecting your Android™ phone to the vehicle or operating your connected Android phone for setup.**
- **If you are unable to devote full attention to vehicle operation while using Android Auto, pull off the road to a safe location and stop your vehicle.**

You can use Android Auto by connecting a compatible Android phone to your vehicle via a USB cable. It is also recommended to use the Android phone OEM cable that was provided with your phone.

With Android Auto, your in-vehicle system can be used as a display and a controller for some of the Android phone functions. Voice control of some of the Android phone functions is also possible with Android Auto. Visit www.android.com/auto for information about the functions that are available and details about Google's privacy policy.

Certain vehicle information (e.g. location and speed) may be shared with your device while Android Auto is in use. Carrier charges may apply to use Android Auto.

COMPATIBILITY

Refer to the Android Auto website for compatible devices.



INFO:

- In some countries, Android phone in the market may not be supported by Android Auto.
- Download the Android Auto App from Google Play™ to Android phone in advance.
- For best results, always update your device to the latest Android software and Android Auto App version. When you connect the Android phone to the in-vehicle system, it will automatically update the Android software and Android Auto App version.
- Android Auto will take the place of your Bluetooth® audio and Bluetooth® hands-free phone functionality.
- When setting a route with the navigation system (if equipped), if you set a destination with Android Auto, the route setting of the navigation system will be cancelled.
- The Phone menu and access to the connected phone through the Voice Recognition System (if equipped) will be disabled while Android Auto is connected. To access your phone, talk to your Google Assistant or select the

phone icon in the Android Auto top menu screen.

INITIAL Android Auto SETTINGS

Before using Android Auto, the Android Auto App must be downloaded on your Android phone.

Download the Android Auto App from the Google Play store on your Android phone. It may be necessary to operate the Android phone when connected first.

Depending on the selection, such as approval, some of the features of Android Auto are not available.

Android Auto OPERATION

Unlock your phone's screen before connecting your Android phone.

1. Connect your Android phone to USB connection port.

 "USB (Universal Serial Bus) connection ports" (page 2-5)

2. Depending on the setting, a Startup Information screen will appear. Touch [Yes] to use Android Auto.

INFO:

- If you do not wish to display the Startup Information screen each time you activate Android Auto, turn on [Don't Ask Any More]/[Don't Ask Anymore] on the Startup Information screen. The Startup Information screen will not be displayed

from the next Android Auto activation. The Startup Information screen can be set to appear again in the Android Auto setting menu.

 "Android Auto settings" (page 5-21)

- Your phone's Bluetooth® will be turned on automatically when Android Auto is activated. Keep the Bluetooth® turned on to use the phone functions.
 - Some functions of Android Auto are not available if the Bluetooth® is not connected.
3. The Android Auto top menu screen will appear. The Android phone functions displayed on the screen should now be operable using the in-vehicle system.

INFO:

- While Android Auto is activated on the Android phone, the phone operations, such as making or receiving calls, can only be done with Android Auto.
- Depending on the device, an Android phone requires MTP mode to be selected in the USB transfer setting.
- After exiting the Android Auto screen, return to the Android Auto screen by taking one of the following actions.

– Touch  on the Launch Bar.

– Touch [Smartphone Connection] on the information screen, and then touch [Android Auto].

Google Assistant™ operation

Some of the functions on your Android phone can be voice controlled when Android Auto is active.

Activation:

Push and hold <  > on the steering wheel to start a Google Assistant session.

INFO:

- Push <  > to end voice operation.
- Keep the interior of the vehicle as quiet as possible. Close the windows to eliminate the surrounding noises (traffic noises, vibration sounds, etc.), which may prevent the system from recognizing the voice commands correctly.
- For functions that can be used with the voice operation, refer to www.android.com/auto.

Phone operation

If you wish to use your phone while Android Auto is activated, follow the procedure below:

1. Touch  on the Android Auto screen.

2. Operate the screen displayed to make a call, etc.

Android Auto SETTINGS

1. Push **<MENU>**.
2. Touch [Connections] on the Launch Bar and then touch [Devices].
3. Touch [📱] by the Android phone name you wish to change the settings.
4. Touch [Smartphone Projection].

Available items:

Available setting items may vary depending on models, specifications and software versions.

Setting item 1	Setting item 2	Action
[Start-up Options]	[Auto]	Activates Android Auto automatically when an Android phone is connected to the in-vehicle system.
	[Ask Every Time]	Displays the Android Auto Startup Information screen when an Android phone is connected to the in-vehicle system.
	[Never Start]	Android Auto will not activate even if an Android phone is connected to the in-vehicle system.
[Vehicle's Help for Android Auto]		Displays helpful tips for Android Auto operation.

Siri Eyes Free (if equipped)

Android Auto SYSTEM LIMITATIONS

For all features of Android Auto to operate correctly, it is necessary to have a compatible Android phone, a cellular connection and a data plan.

When Android Auto is operating, system performance is affected by the strength of the cellular connection or performance of the phone itself. If performance of the system decreases:

- Disconnect and reconnect your phone
- Close all apps and restart them
- Cycle phone power off/on to restart

It should also be confirmed that the latest version of both Android OS and the Android Auto App are installed on the cellular phone.

Functionality of Android Auto may decrease or be lost if there are changes to operating systems, hardware, software or other technologies central to supporting the system that are outside of NISSAN's control. Changing government regulations may also affect the operation of Android Auto.

Apple Siri Eyes Free personal assistant can be accessed from the vehicle. Siri Eyes Free can be accessed in Siri Eyes Free mode to reduce user distraction. In this mode, Siri Eyes Free is available for interaction by voice control. After connecting a compatible Apple device via Bluetooth®, Siri Eyes Free can be activated by using <  > on the steering wheel.

Siri is a trademark of Apple Inc., registered in the U.S. and other countries.



INFO:

- Some Siri Eyes Free functions, such as opening apps, may not be available during driving.
- For best results, always update your device to the latest software version.
- Keep the interior of the vehicle as quiet as possible. Close the windows to eliminate the surrounding noises (traffic noises, vibration sounds, etc.), which may prevent the system from recognizing the voice commands correctly.
- For functions that can be used in Siri Eyes Free, please refer to the Apple website.

REQUIREMENTS



Visit Apple's website for details about device compatibility.

Siri must be enabled on the phone. Please check phone settings.

If the device has a lock screen, Siri must be accessible from the lock screen. Please check phone settings.

Siri Eyes Free ACTIVATION

Siri Eyes Free function can be activated using <  > on the steering wheel.

1. Connect a Siri Eyes Free enabled iPhone to the vehicle.
 "Setting devices" (page 2-12)
2. After the Bluetooth® connection is established, push and hold <  > on the steering wheel to activate the Siri Eyes Free function.

OPERATING Siri Eyes Free

1. Push and hold <  > on the steering wheel.
2. Speak your command and then listen to the Siri Eyes Free reply.

After starting Siri Eyes Free, push <  > on the steering wheel again within five seconds of the end of the Siri Eyes Free announcement to extend the session.

6 Navigation (if equipped)

Safety information	6-2	Editing route	6-23
Navigation screen	6-2	Guidance settings	6-25
Displaying navigation screen	6-2	Viewing traffic information (if equipped)	6-26
Launch Bar	6-2	RDS-TMC feature (if equipped)	6-26
Map operation	6-3	Premium Traffic information (if equipped)	6-26
Map types	6-3	Viewing available traffic information	6-26
Road color	6-8	Traffic information settings	6-28
Moving map	6-8	Storing a location/route	6-28
Changing scale of map	6-9	Storing location	6-28
Map settings	6-10	Storing route	6-29
Traffic information on map (if equipped)	6-13	Storing avoid area	6-30
Map Menu screen	6-13	Editing stored information	6-30
Setting destination	6-13	Deleting stored item	6-34
Basic operations	6-13	Navigation settings	6-36
Options before starting the route guidance	6-16	General information for navigation system	6-39
Route guidance	6-16	Current vehicle location	6-39
About route guidance	6-16	Route calculation	6-42
Route menu	6-17	Route guidance	6-43
Route Preference	6-20	How to update map data	6-44
Recalculating route	6-23		

SAFETY INFORMATION

The navigation system is primarily designed to help you reach your destination. However, you, the driver, must use the system safely and properly. Information concerning road conditions, traffic signs and the availability of services may not always be up to date. The system is not a substitute for safe, proper, and legal driving.



WARNING:

Do not rely on route guidance alone. Always be sure that all driving maneuvers are legal and safe in order to avoid accidents.

NAVIGATION SCREEN

DISPLAYING NAVIGATION SCREEN

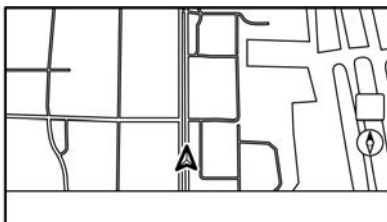

To display the current location map which can be operated, push **<MENU>** and then touch [Map] on the Launch Bar or push **<MAP>**.

LAUNCH BAR

The Launch Bar related to operating the navigation system is displayed on the current location map screen. Displayed items vary depending on the route settings.

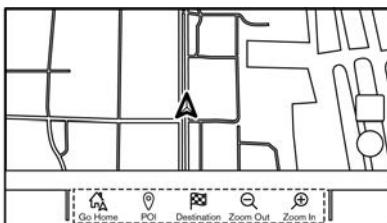

Before setting the destination

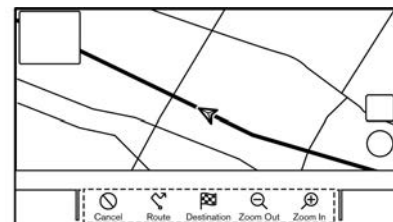

After setting the destination

Menu item	Action
[Add Home]/ [Go Home]	[Add Home]: When the home location is not stored, a home location can be stored in the system. ☞ "Storing home or work location" (page 6-28) [Go Home]: When the home location is stored, sets the home location as a destination.
[POI]	Searches for a Points of Interest to set as a destination.
[Destination]	Displays the destination menu. ☞ "Setting destination" (page 6-13)
[Zoom Out]	Zoom out the map. ☞ "Changing scale of map" (page 6-9)
[Zoom In]	Zoom in the map. ☞ "Changing scale of map" (page 6-9)

MAP OPERATION

[Cancel]	Cancels the route guidance.
[Route]	Displays the route menu screen.  "Route menu" (page 6-17)

MAP TYPES

Two types of map views are available: 2D and 3D.

2D map (except for the Middle East)

The 2D map displays the map in a two-dimensional environment similar to a road map.

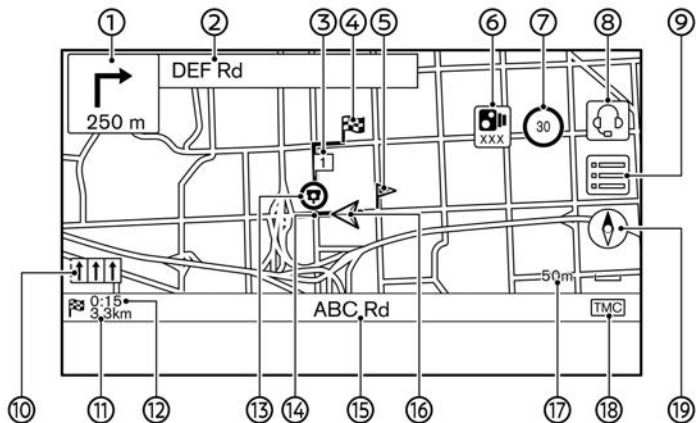

Example

Screen information:

- ① Arrow and distance:

Indicates the distance to the next guide point and the turning direction at that guide point.

If the current vehicle position is off the road, an arrow indicating the direction to the nearest road may be displayed instead of displaying the next turn arrow/distance.

- ② Next street name:

Displays the next street name during

the route guidance.

- ③ Waypoint:

Displays the location of the waypoint that the vehicle will stop by before heading to the final destination. A maximum of 20 waypoints can be set.

- ④ Destination:

Indicates the location of the final destination.

- ⑤ Stored location:

Displays the locations that are stored in the Address Book.

- "Storing location" (page 6-28)

The icons can be changed according to your preferences.

- ⑥ Safety camera warning indicator (if equipped):

The indicator and distance to the camera will be displayed when the vehicle approaches safety cameras.

The safety camera warning indicator setting can be changed.

- "Navigation settings" (page 6-36)

- ⑦ Speed limit indicator (if equipped):

Displays the speed limit of the road which the vehicle is on.

When the vehicle speed exceeds the limit, the indicator flashes.

When the speed limit indicator is not displayed in the unit selected in the Unit settings screen (if equipped), a speed limit in the selected unit may be displayed below the speed limit indicator.

The settings for the speed limit indicator can be changed.









- "Navigation settings" (page 6-36)

- ⑧ (if equipped):

Touch the icon to connect to the NissanConnect Services Interactive Voice Menu.

- "Connecting to Interactive Voice Menu" (page 5-11)

6-4 Navigation (if equipped)

- ⑨ :
Touch to display the Map Menu.
 "Map Menu screen" (page 6-13)
- ⑩ Recommended lane indicator:
When a route is set, the arrow and the recommended driving lane may be displayed depending on the road.
Blue: First recommendation
White: Secondary recommendation
Gray: Not recommended
- ⑪ Remaining distance to the destination:
Indicates the approximate remaining distance to the destination or the waypoint. This indicator will appear when a destination is set and route guidance is started.
- ⑫ Remaining time/Time of arrival:
Indicates the remaining time to the destination/waypoint, or it can be set to display the estimated arrival time. This indicator will appear when a destination is set and the route guidance is started.
The remaining time or arrival time display can be selected to your preference.
 "Route Preference" (page 6-20)
- ⑬ Safety camera icon (if equipped):
Indicates that a safety camera is located at where this icon is displayed.
The safety camera icon setting can be changed.
 "Navigation settings" (page 6-36)
- ⑭ Suggested route:
Appears in bold blue during route guidance.
- ⑮ Street name:
Displays the name of the street that the vehicle is currently driving on.
- ⑯  Vehicle icon:
Indicates the current vehicle location and the direction that the vehicle is heading.
- ⑰ Scale indicator:
Indicates the scale of the map.
- ⑱ Traffic information reception status indicator (if equipped):
This indicator is displayed in a condition where traffic information can be received.
Touch to display the traffic information screen.
 "Viewing traffic events from list" (page 6-26)
[Premium Traffic] (if equipped):
Displayed when Premium Traffic information (if equipped) is active and the traffic information is available.
 "Traffic information settings" (page 6-28)
[TMC] (if equipped):
Displayed when RDS-TMC (if equipped) is active and the traffic information is available.
 "Traffic information settings" (page 6-28)
- ⑲ :
Indicates the directional setting of the map.
Touch to change the map view and the map orientation.

2D map (for the Middle East)

The 2D map displays the map in a two-dimensional environment similar to a road map.

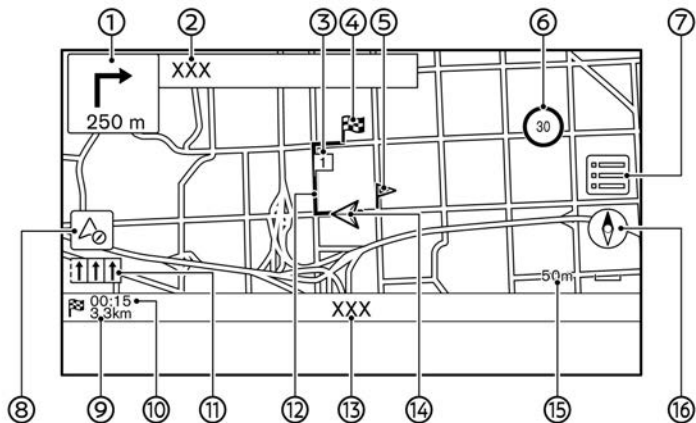









Example

The location of the displayed icons and information may vary depending on models, specifications and software versions.

Screen information:

- ①  Arrow and distance:
Indicates the distance to the next guide point and the turning direction at that guide point.
If the current vehicle position is off the road, an arrow indicating the direction to the nearest road may be displayed instead of displaying the next turn arrow/distance.

- ② Next street name:
Displays the next street name during the route guidance.
- ③  Waypoint:
Displays the location of the waypoint that the vehicle will stop by before heading to the final destination. A maximum of 20 waypoints can be set.
- ④  Destination:
Indicates the location of the final destination.

- ⑤ Stored location:
Displays the locations that are stored in the Address Book.
 "Storing location" (page 6-28)
The icons can be changed according to your preferences.
- ⑥  Speed limit indicator:
Displays the speed limit of the road which the vehicle is on.
When the vehicle speed exceeds the limit, the indicator flashes.
The settings for the speed limit indicator can be changed.
 "Navigation settings" (page 6-36)
- ⑦ :
Touch to display the Map Menu.
 "Map Menu screen" (page 6-13)
- ⑧  (if equipped):
Touch to display the compass mode display.
 "Compass mode display (if equipped for the Middle East)" (page 6-8)
- ⑨ Remaining distance to the destination:
Indicates the approximate remaining distance to the destination or the waypoint. This indicator will appear when a destination is set and route guidance is started.

- ⑩ Remaining time/Time of arrival:
Indicates the remaining time to the destination/waypoint, or it can be set to display the estimated arrival time. This indicator will appear when a destination is set and the route guidance is started.

The remaining time or arrival time display can be selected to your preference.

"Route Preference" (page 6-20)

- ⑪ Recommended lane indicator:
When a route is set, the arrow and the recommended driving lane may be displayed depending on the road.

Blue: Recommended

Gray: Not recommended

- ⑫ Suggested route:
Appears in bold blue during route guidance.

- ⑬ Street name:
Displays the name of the street that the vehicle is currently driving on.

- ⑭ Vehicle icon:
Indicates the current vehicle location and the direction that the vehicle is heading.

- ⑮ Scale indicator:
Indicates the scale of the map.

- ⑯ :
Indicates the directional setting of the map.

Touch to change the map view and the map orientation.

3D map

The 3D map displays the map from an elevated perspective. In 3D map, it is easy to recognize an image of the route because it provides a panoramic view over a long distance.

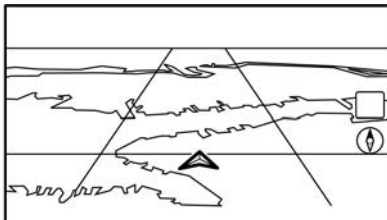

INFO:

The 3D map always appears with the current forward direction facing up.

Building graphics

Building graphics are stored in the map data for certain areas, and can be displayed when the map is zoomed in.

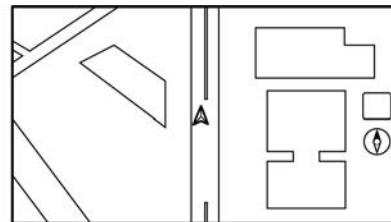

2D building graphics

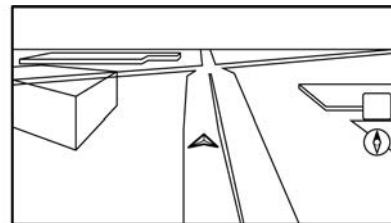

3D building graphics

INFO:

In an area where the building graphics are not stored in the map data, the normal map is displayed even when the map is zoomed in.

Compass mode display (if equipped for the Middle East)

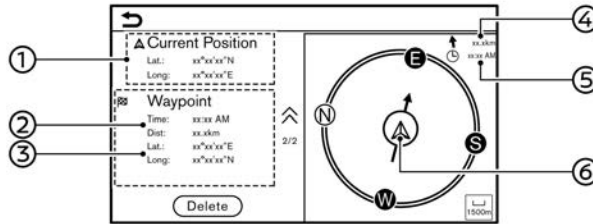

The compass mode can be useful in areas such as deserts where there are no roads or where the area information is not included in the map data. This mode helps the driver to get to the destination by showing the current vehicle location at the center of the map.

Touch  on the map screen to switch to the compass mode screen.

- ① Latitude/longitude of current location
- ② Estimated time of arrival and distance to waypoint/destination
- ③ Latitude/longitude of waypoint/destination
- ④ Direction and straight distance to the destination
- ⑤ Estimated time of arrival at the destination

⑥ Current vehicle location and the direction to waypoint/destination

If no destination has been set, only the latitude and longitude of the current location are displayed.

INFO:

- When the compass mode is active, route guidance will not be provided.
- Touch [Delete] to delete the information of waypoint/destination. Once deleted, the deleted information cannot be displayed again.
- Details of this function are subject to change.

ROAD COLOR

The road types are differentiated by color.

Except for Mexico:

Color	Road type
Yellow and red outline	Motorway
Red or orange	Main road
Yellow or white	Narrow street

For Mexico:

Color	Road type
Dark red	Freeway
Light brown	Major road
Light green	Secondary road
White	Local road

MOVING MAP

The map can be scrolled by the touch panel operations. Map scrolling operations may be limited while driving.

Touch:

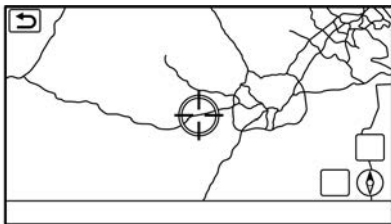

When a point on the map is touched, the cross pointer is displayed and the position touched is moved to the center of the screen.

After moving the map, touch [] on the map screen or push <MAP> to display the current location map screen.

Long touch:

Touch the direction to move to. The map continues to scroll while the screen is touched.

Drag:

Drag the screen to scroll the map.

Swipe/flick:





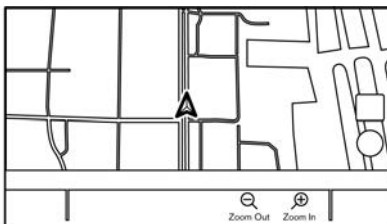

Swipe or flick the screen to scroll the map screen quickly.

CHANGING SCALE OF MAP







To change the map scale, touch [Zoom Out] or [Zoom In] on the Launch Bar.

Other operations:

- While the cross pointer is displayed, the scale bar can be displayed by touching the scale indicator on the map.
Touching [] or [] on the scale bar can change the map scale while the scale bar is displayed.
- Rotating <PUSH SOUND /   / <   / ENTER SETTING> can also change the map scale.
- While the cross pointer is displayed, pinching in or out with your fingers on the map screen can also change the map scale.

Free Zoom:

Rotating <PUSH SOUND /   / <   / ENTER SETTING> to change the map scale may adjust the scale normally, or it may

engage the free zoom (finer scale adjustment in smaller steps).

 "Map settings" (page 6-10)

INFO:

- While driving, pinch-in and pinch-out operations may be disabled.
- Depending on the map scale, traffic information icons cannot be displayed on the map screen.
 "Traffic information on map" (page 6-27)

MAP SETTINGS

The setup for the map view is performed from the Map Menu on the touch screen display.

1. Touch  on the current location map screen.
2. Touch [Map Settings].

Available setting items may vary depending on models, specifications and software versions.

Menu item		Action
[Dual Map View]	[2D Map]	Displays 2D map.
	[Split: 2D Map]	Displays 2D map on both left and right side of the split screen. You can see the different scale and settings of 2D maps at the same time.
	[3D Map]	Displays 3D map.
	[Split: 3D Map]	Displays 2D map on the left side and 3D map on the right side of the split screen.
[Left Side Info]	[Intersection]	Displays the enlarged view of the next intersection on the left side of the screen during route guidance.
	[Turn List]	Displays the turn list on the left side of the screen when a route is set.
	[Drive Report]	Displays your eco drive report on the left side of the screen.
	[Full Map]	Displays full map screen.
[Map Icons]		Select the categories of POI icons to display on the map screen.
[More Settings]/ [Others]	[Map Orientation]	The map orientation can be selected from [North Up] or [Heading Up]. [Map Orientation] is available only when 2D map is displayed.
	[Long Range]	The position of the vehicle icon is located slightly lower than the center of the screen to view a wider area in the traveling direction. Long Range is available only when the map view is in [Heading Up] mode.

Menu item		Action
[Left Split Map Settings]	[Map Orientation]	The map orientation for the left side of split screen can be selected from [North Up] or [Heading Up].
	[Long Range]	With this item turned on, the vehicle position icon on the left screen will be located slightly lower than the center of the screen so that a wider area in the traveling direction can be viewed. Long Range Map View is available only when the left side of split screen is in [Heading Up] mode.
	[Map Scale]	Sets the map scale of the left screen.
[Audio Display on Map]		Turns on/off the audio information displayed at the top of the map screen.
[Map Colour]/[Map Color]		Sets map color from [Standard], [Emphasise Roads]/[Emphasize Roads], [Emphasise Text]/[Emphasize Text] and [Emphasise Traffic]/[Emphasize Traffic].
[Map Text Size]	[Large]	Sets the font size of the text displayed on the map screen.
	[Medium]	
	[Small]	
[Select Text to Display on Map]	[Place Names]	Allows place, facility and road names to be displayed on the map screen.
	[Facility Names]	
	[Road Names]	
[Map Scrolling Information]		Information about the location, on which the center of the cross pointer is placed by scrolling on the map, can be set to be displayed.

Menu item		Action	
	[Tracking Dots Displayed on Map]	[Record & Show Tracking Dots on Map]	Turns the route tracking dots display on/off.
		[Tracking Dot Distance]	Select the interval between tracking dots.
		[Delete Track to Current Location]	Deletes the route tracking dots up to the current location.
	[Small Step Zoom with Dial]		Sets the free zoom function on/off. When this setting is on, it is possible to adjust the scale in smaller steps than with normal scale adjustment.
	[Show all M-way Exits on Route]/[Show all Freeway Exits on Route]		Turns on/off the motorway exit information display.
	[Auto. Show Turn List on M-way]/[Auto. Show Turn List on Freeway]		The turn list can be displayed automatically while driving on a motorway.
	[North Up when Zoomed Out]		When this setting is turned on, the orientation of the map is automatically changed to [North Up] when the widest map scale is selected.
[Back to Map]		Back to the current location map.	

SETTING DESTINATION

TRAFFIC INFORMATION ON MAP (if equipped)

Traffic information can be displayed on the map.

 "Traffic information on map" (page 6-27)

MAP MENU SCREEN

Touch  while the current location map screen or a scrolled map screen is displayed to display the menu corresponding to that screen.

This menu can be used to quickly access helpful functions, such as setting a destination or searching for points of interest nearby.

The system can provide route guidance once a destination is set.

BASIC OPERATIONS

Displaying destination setting menu

There are several methods that can be used to set a destination. Select a preferred method for finding and setting a destination.

Push **<MAP>** and then touch [Destination] on the Launch Bar.

Availability of the destination setting methods varies depending on the models, specifications and software versions. Items displayed on the screen may not function depending on various conditions.

Available destination setting methods:



Setting item	Action
[Enter POI / Address]	Searches for a destination by inputting the address or POI names.
[Online Search]	This function can be used if your vehicle is equipped with TCU (Telematics Control Unit). To use this function, activate the online search under [Options] on the destination search result screen when available.
[Go Home]	Searches for a route from the current location to the previously stored home location.
[Street Address]	Searches for a destination by address.
[Points of Interest]	Searches for a destination from various categories.
[Address Book]	Searches for a destination from the vehicle Address Book.
[City Centre]/[City Center]	Sets the center of a city as the destination.
[Intersection]	Sets an intersection as a destination.
[Previous Destinations]	Searches for the destination from the previous destinations and a previous start point.
[Go to Work]	Searches for a route from the current location to the previously stored work location.
[Phone Number]	Searches for a point of interest by a phone number.
[Destinations by Google]	Sets a place searched by Google as a destination.
[Saved Routes]	Sets a route from the saved route data.
[By Map]	Searches for a destination by map.
[Latitude/Longitude]	Sets a destination from latitude and longitude.
[Door to Door Navigation]/[Smartphone Navigation]	Turns on/off Door to Door Navigation.

 **NOTE:**

Notice for Point of Interest search:

Locations and business hours of facilities are subject to change, which may not be reflected in the map data. Double-check this information before you go to an emergency facility to ensure that you can receive the proper support. Otherwise, you may not receive emergency help when you arrive at the destination. A confirmation message also appears on the navigation screen. Follow the displayed instructions and check the items required.

 **INFO:**

- After setting a destination, the location of the destination can be adjusted and the location can be stored in the Address Book, etc.
 "Options before starting the route guidance" (page 6-16)
- The destinations can be canceled and edited/added.
 "Route menu" (page 6-17)

OPTIONS BEFORE STARTING THE ROUTE GUIDANCE

Before starting the route guidance, select menus for route details to modify the route, preview the turn list, or store the route.

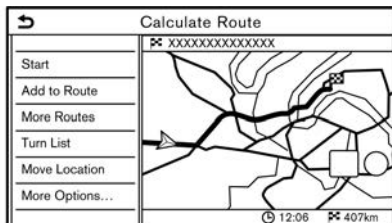

- [Start]: Starts route guidance to the selected destination.
- [Add to Route]: Adds a location to the route previously set.
- [More Routes]: Suggests alternative routes.

INFO:

Touch [1 Type]/[1type] to display alternative routes calculated with a route search condition selected on the [Basic Route Type] setting screen.

 "Route Preference" (page 6-20)
Touch [3 Types]/[3types] to display alternative routes calculated in all three route search conditions ([Fastest], [ECO]/[Eco]

and [Shortest]).

- [Turn List]: Displays a detailed turn list. The map can be displayed and the turn can be avoided by touching a turning point.
- [Move Location]: Displays a map screen and allows the location of the destination to be adjusted.
- [More Options...]: Option such as viewing place information and saving locations/routes can be selected.

ROUTE GUIDANCE

ABOUT ROUTE GUIDANCE

After setting the route, select [Start] to start the route guidance.

During route guidance, the system navigates you through the guide points using visual and voice guidance.



WARNING:

- **The navigation system's visual and voice guidance is for reference purposes only. The contents of the guidance may be inappropriate depending on the situation.**
- **Follow all traffic regulations when driving along the suggested route (e.g., one-way traffic).**
 "Route guidance" (page 6-43)

Voice guidance during route guidance

Basics of voice guidance:

Voice guidance announces which direction to turn when approaching an intersection for which a turn is necessary.



INFO:

- There may be some cases in which voice guidance and actual road conditions do not correspond. This may occur because of discrepancies between the actual road and the infor-

mation on the map data, or may also be due to the vehicle speed.

- In case voice guidance does not correspond to the actual road conditions, follow the information obtained from traffic signs or notices on the road.
- When approaching a guide point (intersection or corner) or destination/waypoint during route guidance, voice guidance announces the remaining distance and/or turning direction. Push and hold **<MAP>** to repeat voice guidance.

ROUTE MENU



WARNING:

Always stop the vehicle in a safe location before modifying the route conditions. Modifying the route conditions while driving may cause an accident.

During route guidance, the route conditions can be modified and the route information can be confirmed. Set route conditions according to your personal preference.

Push **<MAP>** when a destination is set, and then touch [Route] on the Launch Bar.

The route menu screen is displayed.

Available items may vary depending on models, specifications and software versions.

Menu item		Result
[Cancel Route]		Cancels the current route guidance.
[Turn List]		Displays the details of the suggested route.
[Detour]		A detour of a specified distance can be calculated.
[Route Preference]		Set the route search conditions.
[Recalculate]		Manually search for the route again after changing the search conditions, etc. and have the system calculate a route.
[Show Destination]	[Move Location]	Displays a map screen and allows the location of the destination to be adjusted.
	[Nearby POIs]	Search for points of interest near the destination, such as restaurants and gas stations, etc. The location can be set as a destination or a waypoint.
	[Save Location]	Save the destination in the Address Book.
[Edit/Add to Route]		A destination or waypoint can be edited/added to a route that has already been set.
[Guidance Settings]		Various guidance settings can be customized.
[Save Route]		The current route (a destination and waypoints) can be saved. A maximum of 10 routes can be saved. The saved routes can easily be recalled for future use. Saved route includes only the location information, not the route itself. Route may vary depending on the traffic information (if equipped) or other conditions.
[Map Scroll]		Displays the current map screen which can be scrolled to confirm the location of the destination, waypoints, route, etc.

[Simulation]

Simulates the route guidance. This function provides a detailed image of the route with voice guidance.

The following operations are available:

[||]: Pauses the simulation.

[▶]: Resumes the simulation.

[■]: Ends the simulation.

: Increases the play speed.

: Decrease the play speed.

ROUTE PREFERENCE

It is possible to set the conditions of the route search.

1. Touch [Navigation] on the setting menu screen.
 "System settings" (page 2-10)
2. Touch [Route Preference].
3. Touch the item you would like to set.

Available items may vary depending on models, specifications and software versions.

Setting Item		Action	
[Basic Route Type]	[Fastest Route]	Prioritizes the use of fastest route.	
	[Energy-Saving]	Prioritizes a route which uses less energy.	
	[Shortest Distance]	Prioritizes the shortest route. The route may not be the shortest because the system prioritizes roads that are easy to drive on for safety reasons.	
[Other Routing Choices]	[Minimise Motorways]/[Minimize Freeway]		Minimizes the use of motorways.
	[Minimise Toll Roads]/[Minimize Toll Roads]		Minimizes the use of toll roads.
	[Time Restricted Roads]	[Use Restriction Info]	Calculates route taking time restriction information into consideration.
		[Do Not Use Restriction Info]	Calculates route without taking time restriction information into consideration.
		[Avoid]	Calculates route avoiding the use of time restricted roads.
	[Seasonal Restricted Roads]	[Use Restriction Info]	Calculates route taking seasonal restriction information into consideration.
		[Do Not Use Restriction Info]	Calculates route without taking seasonal restriction information into consideration.
		[Avoid]	Calculates route avoiding the use of seasonal restricted roads.

	[Use Traffic Information]	[Auto]	Calculates the route automatically taking traffic information into consideration.
		[Accept]	If a traffic jam or incident occurs, a confirmation screen will appear before calculation.
		[OFF]	Calculates the route without taking traffic information into consideration.
	[Use Avoid Area Settings]		When enabled, the system avoids the previously defined avoid areas.
	[Use Ferries]		Includes the use of ferries.
	[Use Car-Carrying Trains]		Includes the use of car-carrying trains.
	[Use Unpaved Roads]		Includes the use of unpaved roads.
	[Use HOV Lanes]		Includes the use of HOV lanes.
	[Use Learned Routes]		Uses the roads that are most frequently traveled with the help of self-learning technology.
[Customise More Routes]/[Customize More Routes]	[3 Types]/[3types]		Calculates 3 types of route when confirming other routes.
	[1 Type]/[1type]		Calculates routes with a route search condition selected on the [Basic Route Type] setting screen.  "Route Preference" (page 6-20)
[Estimated Time]	[Destination]		Displays the estimated time of arrival or remaining time to the destination during route guidance.
	[Waypoint]		Displays the estimated time of arrival or remaining time to the waypoint during the route guidance.
[Time Shown on Map]	[ETA]		Displays the estimated time of arrival.
	[Remaining]		Displays the remaining time to arrival.

**INFO:**

- [Route Preference] can also be accessed from route menu screen.
- If the vehicle greatly deviates from the suggested route, the system calculates a new route.
- Traffic jam information (if equipped) displayed on the map screen is not statistical traffic information.
- If [Do Not Use Restriction Info] is selected for [Time Restricted Roads] setting, the system calculates a route without any consideration of the regulations concerning the time or day of the week. Therefore, the suggested route may include a road subject to traffic regulations concerning the time or day of the week. When driving along the route, always follow all traffic regulations regardless of whether [Time Restricted Roads] is set to be considered or not.
- The system calculates to reduce the time required for the entire route from the start to the destination. If there are no appropriate routes, the system may lead to a route where a traffic jam occurs instead of leading to a detour.
- The system may not lead to a detour if the traffic closure or a traffic jam occurs far from the present location.

RECALCULATING ROUTE

A route can be manually searched again after changing the search conditions, etc.

1. Push **<MAP>** and then touch [Route] on the Launch Bar.
2. Touch [Recalculate]. A message is displayed and the route is recalculated.
3. Touch [Start] or conduct other operations as necessary.
☞ "Options before starting the route guidance" (page 6-16)



INFO:

- When a waypoint has been set on the route, the system will search for only one route, even if route recalculation is performed.
- When the vehicle deviates from the suggested route, the route from the current location to the destination is automatically searched again by the Auto Reroute function.

EDITING ROUTE

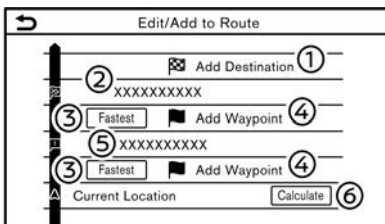

1. Push **<MAP>** and then touch [Route] on the Launch Bar.
2. Touch [Edit/Add to Route].
3. Edit the following settings and touch [Calculate].

Available settings

- ① [Add Destination]:
Touch to add a new destination.
- ② Current destination:
Touch to edit or delete the destination.
☞ "Editing/deleting destination or waypoint" (page 6-24)
- ③ Criteria for calculating a route to the destination/waypoint:
Touch to change the conditions for route calculation.
☞ "Changing route calculation conditions" (page 6-24)
- ④ [Add Waypoint]:
Touch to add a waypoint.
☞ "Setting destination or waypoint"

(page 6-23)

- ⑤ Current waypoint:
Touch to edit or delete the waypoint.
☞ "Editing/deleting destination or waypoint" (page 6-24)
- ⑥ [Calculate]:
After editing the route, touch to recalculate a route with new conditions.

Setting destination or waypoint

A destination or waypoint can be added to a route that has already been set. Up to 20 waypoints besides one destination can be set.

1. Push **<MAP>** and then touch [Route] on the Launch Bar.
2. Touch [Edit/Add to Route].
3. Touch [Add Destination] or [Add Waypoint].



INFO:

- If [Add Destination] is selected, the current destination changes to a waypoint.
4. Set a destination or waypoint. The method of searching for a waypoint is the same as the one for a destination.
☞ "Setting destination" (page 6-13)
 5. Touch [Add to Route] to add the location to the route.

- The route information with the selected location added to the route is displayed. Adjust the route calculation conditions as necessary.
 - ☞ “Changing route calculation conditions” (page 6-24)
- Touch [Calculate] to confirm the route change. The route will be recalculated.

INFO:

The prior route will be deleted automatically.

Editing/deleting destination or waypoint

A destination or waypoint that has already been set can be modified or deleted.

- Push **<MAP>** and then touch [Route] on the Launch Bar.
- Touch [Edit/Add to Route].
- Touch a destination or waypoint that is already set.
- Touch to edit the following settings:

Available settings

- [Delete]:
A selected destination or waypoint that has already been set can be deleted.
- [Change Order]:
The order of a destination and waypoints that are already set can

be changed.

- [Move Destination]/[Move Dest.]:
The location of the destination or waypoint can be adjusted by moving the cross pointer across the map on the touch screen display.

- Touch [Calculate] to apply the change.

INFO:

If the destination is deleted, the route guidance will be canceled.

Changing route calculation conditions

Each section of the route between waypoints can have different route calculation conditions.

- Push **<MAP>** and then touch [Route] on the Launch Bar.
- Touch [Edit/Add to Route].
- Touch the route condition shown on the preferred section of the route to the destination or waypoint.
- Touch the preferred condition.
 - ☞ “Route Preference” (page 6-20)
 The conditions are changed and the display returns to the edit route screen.
- Touch [Calculate] to apply the change.

INFO:

The recalculated route may not be the shortest route because the system prioritizes roads that are easy to drive on for safety reasons.

Changing order of destination and waypoints

The order of a destination and waypoints that are already set can be changed.

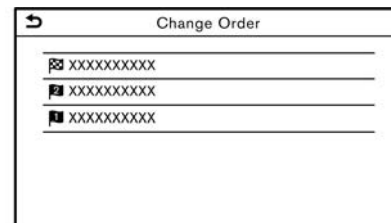

- Push **<MAP>** and then touch [Route] on the Launch Bar.
- Touch [Edit/Add to Route].
- Touch a destination or waypoint that is already set.
- Touch [Change Order].
- Touch a preferred destination or waypoint to replace the previously selected destination or waypoint.
- Touch [Calculate] to apply the change.

GUIDANCE SETTINGS

Various settings are available to customize the guidance information provided by the system.





1. Touch [Navigation] on the setting menu screen.
 "System settings" (page 2-10)
2. Touch [Guidance Settings].
3. Touch an item you would like to set.

Available items may vary depending on models, specifications and software versions.

Setting item	Action
[Guidance Volume]	Adjusts the volume level of voice guidance.
[Guidance Voice]	Activates or deactivates voice guidance.
[Traffic Announcement]	Activates or deactivates the traffic announcement. When this item is activated, the system provides an announcement of traffic information or events on the route. The indicator illuminates if traffic announcement is activated.
[Toll Booth Guide]	Activates or deactivates the function to notify that the vehicle is approaching a toll booth.



INFO:

- [Guidance Settings] can also be accessed from the route menu screen.
 "Route menu" (page 6-17)
- Even when [Traffic Announcement] is turned on, the traffic information is not announced in the area where traffic information is not broadcast.
- The guidance volume can also be adjusted by turning <  /VOL>/<VOL/PUSH  >/<VOL/PUSH POWER> on the control panel or pushing <  > on the steering wheel while voice guidance is being announced.

VIEWING TRAFFIC INFORMATION (if equipped)

Two types of traffic information are available on this system, RDS-TMC (Radio Data System - Traffic Message Channel) (if equipped) and Premium Traffic information (if equipped).

To activate RDS-TMC (if equipped), set [Use Premium Traffic] (if equipped) off.

To activate Premium Traffic information (if equipped), set [Use Premium Traffic] on.

☞ "Traffic information settings" (page 6-28)

RDS-TMC FEATURE (if equipped)

The navigation system receives traffic information from the best available sources and enables the RDS-TMC to broadcast this information for the best possible guidance. The RDS-TMC broadcast is fed by a dedicated FM tuner so that you can still listen to the radio while Traffic Information is being broadcast. Traffic information can be displayed only in areas where RDS-TMC is broadcast. Traffic information is not available in some areas.

PREMIUM TRAFFIC INFORMATION (if equipped)

Real-time traffic information can also be obtained from Premium Traffic information with more street coverage.

The types of event displayed on the screen are the same as RDS-TMC Information (if equipped).

Premium Traffic information is available

by turning [Use Premium Traffic] on and connecting a Wi-Fi device (if equipped) or connecting a smartphone through Wi-Fi (if equipped).

☞ "Traffic information settings" (page 6-28)

VIEWING AVAILABLE TRAFFIC INFORMATION

Viewing traffic events from list

1. Push **<MENU>** and then touch [Info] on the Launch Bar.
2. Touch [Traffic Information] or [Premium Traffic]. A list of available types of information is displayed.

Available items	Function
[Show Traffic on the Route]	Displays a list of traffic information found on the route from the current vehicle location to the destination. Available only when a route is set.
[Nearby Traffic Info]	Displays a list of available traffic information around the current vehicle location.



INFO:

[Traffic Information] or [Premium Traffic] is available only when the traffic information is received.

3. Touch the preferred item. A list of available events are displayed.

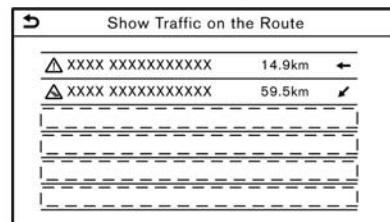

Example

4. Touch an event from the list to check the detailed information and the map. Touch [Avoid] to search for an alternate route.

Displaying urgent traffic information

When an urgent event is found around the current vehicle location, a message pops up automatically on the touch screen display with a voice announcement.

The message includes the icon, event type, event information and the direct distance from the current location to the event.



INFO:

- When there are multiple urgent events, the event with the shortest direct distance from the current location is displayed.
- If the urgent event is on the recommended route, and if a detour is

found, the detour route notification screen is displayed when the vehicle approaches the detour point.

Traffic information on map

Traffic information is displayed on both 2D and 3D map screens.

Screen information

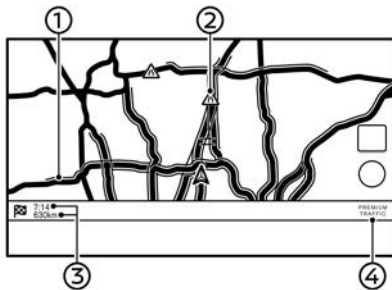

Example

① Road conditions:

Free Flow	Green
Slow traffic	Yellow
Heavy traffic	Red
Road closed and section affected by serious traffic event	Orange and white stripes
Queuing traffic	Orange (Premium Traffic information (if equipped) only)

② Traffic information icon:

If a route is not already set, all of the traffic information icons on the map screen are displayed in gray. When a route is already set, the icons on the route are displayed in color, and the icons outside the route are displayed in gray.

Except for Mexico:

	Stationary traffic
	Slow traffic
	Free flowing traffic
	Stretch is closed
	Accident
	Roadworks
	Narrow lanes
	All other events

For Mexico:

	Traffic jam
	Slow traffic
	Traffic flowing freely
	Road closed
	Accident
	Road work
	Narrow lanes
	All other events

③ Remaining distance and time:

Remaining distance and time calculated with consideration of traffic information on route.

Whether to display the remaining time to the destination or estimated arrival time at the destination can be selected.

"Route Preference" (page 6-20)

④ Traffic indicator:

TMC (if equipped)

Displayed when there is available RDS-TMC received.

Premium Traffic (if equipped)

Displayed when there is available Premium Traffic information received.

INFO:

Traffic icons are displayed in the scale level of 15 m (1/64 miles) - 12.5 km (7.5 miles) range. Some traffic icons are displayed only on the map at higher detail levels.

TRAFFIC INFORMATION SETTINGS

Settings for traffic information related functions can be changed.

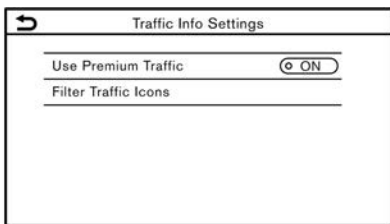

1. Touch [Navigation] on the setting menu screen.
☞ "System settings" (page 2-10)
2. Touch [Traffic Info Settings].
3. Touch the preferred setting. The indicator for the selected setting illuminates.

Available setting items may vary depending on models, specifications and software versions.

Available setting items

- [Use Premium Traffic]:
Turns Premium Traffic information (if equipped) on/off.
- [Filter Traffic Icons]:
Selects which types of traffic incidents (e.g., accident) will be displayed on the map screen.

INFO:

- [Use Premium Traffic] functionality may not be available depending on the models, specifications and software versions.
- [Traffic Info Settings] can also be accessed from current location map screen.
- Even when [Traffic Announcement] is set to off, the route guidance will not be affected. Also, the announcement of emergency information will not be turned off.
☞ "Guidance settings" (page 6-25)

STORING A LOCATION/ROUTE

STORING LOCATION

Often visited locations can be stored in the Address Book. The stored addresses can be easily retrieved to set them as a destination or waypoint. The Address Book can store up to 200 locations.

Storing home or work location

A home or work location can be stored in the system.

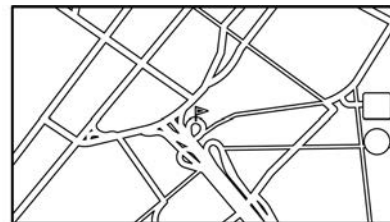

1. Touch [Navigation] on the setting menu screen.
☞ "System settings" (page 2-10)
2. Touch [Address Book].
3. Touch [Add Home Location] or [Add Work Location].
4. Touch an appropriate method to set a location. Refer to the search methods used for destination setting.
☞ "Setting destination" (page 6-13)
5. Touch [OK].
6. A message is displayed, and the address of the location is stored in the Address Book.

- Adjust and edit the contents of the stored item as necessary. Touch [OK] to confirm.
 ↳ "Editing stored location" (page 6-31)

INFO:

If you touch [Go Home (Save Location)] or [Go to Work (Save Location)] on the destination screen while the home or work location is not stored yet, the system will display a message asking if you wish to store a home or work location. Touch [Yes] to store the home or work location.

Storing location by searching

It is possible to store a location by searching in various ways.

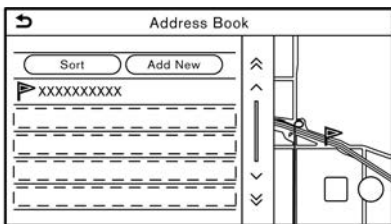

- Touch [Navigation] on the setting menu screen.
 ↳ "System settings" (page 2-10)
- Touch [Address Book].
- Touch [Saved Locations].

- Touch [Add New].
- Touch an appropriate method to set a location. Refer to the search methods used for destination setting.
 ↳ "Setting destination" (page 6-13)
- Touch [OK].
- A message is displayed, and the address of the location is stored in the Address Book.
- Adjust and edit the contents of the stored item as necessary. Touch [OK] to confirm.
 ↳ "Editing stored location" (page 6-31)

INFO:

- When the location is stored in the [Saved Locations], [Address Book] can be used to search for the location.
- When 200 locations are already stored, a new location cannot be stored until a currently stored location is deleted.

Storing location by moving map

- Move to the preferred location on the map and touch  on the touch screen display.

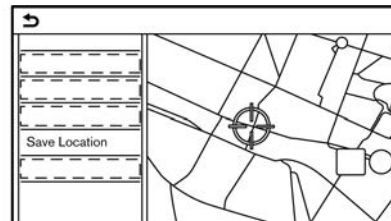

- Touch [Save Location]. A message is displayed.
- The icon representing the stored location is displayed on the map. Push **<MAP>** to return to the current location map screen.

STORING ROUTE

A maximum of 10 calculated routes can be stored. Stored routes can be easily retrieved and set as the suggested route.

A route requires at least one waypoint in order to be stored.

- Push **<MAP>** and then touch [Route] on the Launch Bar.
- Touch [Save Route]. A confirmation message is displayed. If asked, touch [Yes] to store the current route.

INFO:



- At least 1 waypoint must be set for the route to be stored.
- A stored route includes only locations (destination and waypoints) and route calculation conditions, not the route itself.
- The route is stored in the first available position number in the stored routes list.
- When 10 routes are already stored in the address book, a new route cannot be stored until a route is deleted.
 "Deleting stored item" (page 6-34)

STORING AVOID AREA

An Avoid Area can be stored. The Avoid Area is an area that can be excluded from a route, such as a road that is always congested. Once Avoid Areas are stored, the system avoids those areas when calculating a route. Up to 10 Avoid Areas can be stored.

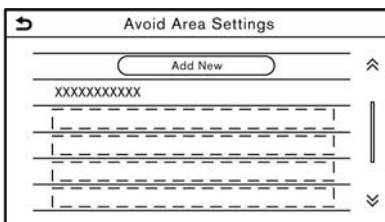
1. Touch [Navigation] on the setting menu screen.
 "System settings" (page 2-10)
2. Touch [Address Book].
3. Touch [Avoid Area].



4. Touch [Add New].
Touch an appropriate method to search for a location.
 "Setting destination" (page 6-13)
5. Touch [OK].
6. Adjust the information of the Avoid Area as necessary.
 "Editing avoid area" (page 6-34)
7. Touch [OK] to store the avoid area information.

INFO:

A maximum of 10 Avoid Areas can be stored. When 10 Avoid Areas are already stored, a new Avoid Area cannot be stored until a currently stored Avoid Area is deleted.

 "Deleting stored item" (page 6-34)

EDITING STORED INFORMATION

Items stored in the system can be edited.

Editing stored location

1. Touch [Navigation] on the setting menu screen.
 "System settings" (page 2-10)
2. Touch [Address Book].

Available items may vary depending on models, specifications and software versions.

Setting item		Action	
[Home Location]*	[Edit]	[Show Icon on Map]	Displays the home icon on the map.
		[Icon]	Selects a home icon of a preferred design.
		[Sound]	Sets the type of the alarm that sounds when the vehicle approaches home.
		[Direction]	Sets the alarm to sound when approaching from a specific direction.
		[Distance]	Sets the alarm to sound when reaching a specific distance to home.
	[Phone Number]/[Phone No.]	Stores the home phone number.	
	[Move Location]	Adjusts the stored home location.	
[Delete]	Deletes the stored home location.		
[OK]	Confirms and saves the edited home information.		
[Work Location]*	[Edit]	[Show Icon on Map]	Displays the work icon on the map.
		[Icon]	Selects a work icon of a preferred design.
		[Sound]	Sets the type of the alarm that sounds when the vehicle approaches work.
		[Direction]	Sets the alarm to sound when approaching from a specific direction.
		[Distance]	Sets the alarm to sound when reaching a specific distance to work.

		[Phone Number]/[Phone No.]	Stores the work phone number.	
	[Move Location]		Adjusts the stored work location.	
	[Delete]		Deletes the stored work location.	
	[OK]		Confirms and saves the edited work information.	
[Saved Locations]	[Sort]	[Sort by Number]	Sorts the saved locations.	
		[Sort by Name]		
		[Sort by Icon]		
		[Sort by Group]		
	[Add New]		Adds a new location.  "Storing location by searching" (page 6-29)	
	Saved Location List	[Edit]	[Show Icon on Map]	Displays the icon of a stored location on the map.
			[Name]	Registers a name of the entry.
			[Voice Tag]	Registers a voice tag for the entry which allows the entry to be used with the Voice Recognition System (if equipped).
			[Icon]	Selects an icon for the entry.
			[Sound]	Sets the type of the alarm that sounds when the vehicle approaches the location.
[Direction]			Sets the alarm to sound when approaching from a specific direction.	
[Distance]			Sets the alarm to sound when reaching a specific distance to the location.	
[Phone Number]/ [Phone No.]			Registers a phone number for the location.	

			[Group]	Registers a group of the entry.
			[Entry Numbers]	Registers an entry number for the location.
		[Move Location]		Adjusts the stored location information.
		[Delete]		Deletes the stored location information.
		[OK]		Confirms and saves the edited stored location information.

*: When home or work location has not been stored, [Add Home Location] or [Add Work Location] is displayed and a home or work location can be stored from the menu.

Editing stored route

1. Touch [Navigation] on the setting menu screen.
 "System settings" (page 2-10)
2. Touch [Address Book].
3. Touch [Saved Routes].
4. Touch the preferred saved route from the list. Saved Routes settings screen will be displayed.

Setting item	Action
[Rename]	Changes the saved route name.
[Replace]	Overwrites the saved route with the current route.
[Delete]	Deletes the saved route.
[OK]	Applies the edited settings.

Editing avoid area

1. Touch [Navigation] on the setting menu screen.
 "System settings" (page 2-10)
2. Touch [Address Book] and then touch [Avoid Area].
3. Touch a preferred Avoid Area from the list. Avoid Area settings screen will be displayed.

Setting item	Action
[Rename]	Changes the name of an Avoid Area.
[Move Location]	Adjusts the Avoid Area location.
[Resize Area]	Adjusts the size of the Avoid Area.
[Motorway]/ [Freeway]	Sets the Avoid Area to include or not include motorways. The color of the Avoid Area changes depending on the setting. Motorway ON: Green Motorway OFF: Blue
[Delete]	Deletes an Avoid Area.
[OK]	Applies the edited setting.

DELETING STORED ITEM

The locations and routes in the Address Book can be deleted. Deleting an individual item and deleting all stored items are available.



Deleted items cannot be restored. Before deleting an item, always make sure that the item is no longer needed.

Deleting stored item individually

1. Touch [Navigation] on the setting menu screen.
 "System settings" (page 2-10)
2. Touch [Address Book].
3. Touch [Delete Saved Items].

Select the preferred item and touch [Yes] to confirm deletion.

Step 1	Step 2	Action
[Delete Home Location]		Deletes home location.
[Delete Work Location]		Deletes work location.
[Delete Address Book]	[Delete All]	Deletes all stored locations.
	[Delete One]	Deletes a selected stored location.
[Delete Saved Routes]	[Delete All]	Deletes all stored routes.
	[Delete One]	Deletes a selected stored route.
[Delete Avoid Areas]	[Delete All]	Deletes all Avoid Areas.
	[Delete One]	Deletes a selected Avoid Area.
[Delete Previous Destinations]	[Delete All Previous Destinations]	Deletes all of the previous destinations.
	[Delete One Previous Destination]	Deletes a selected previous destination.
	[Delete Previous Starting Point]/ [Delete Previous Start Point]	Deletes the previous starting point.
[Delete Learned Routes]		Deletes the learned routes.

Deleting individual item on map

1. Align the cross pointer over the stored location to be deleted by moving on the map, and then touch .

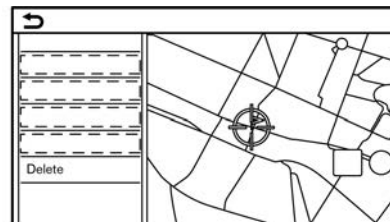

2. Touch [Delete].
3. A confirmation message is displayed. Confirm the contents of the message and touch [Yes].
The stored item is deleted from the Address Book.

NAVIGATION SETTINGS

The navigation system can be customized according to the user's preference.

1. Touch [Navigation] on the setting menu screen.

 "System settings" (page 2-10)

2. Touch the item you would like to set.

Available setting items may vary depending on models, specifications and software versions.

Available items:

- **[Map Settings]**

Sets the display method and direction of the map.

 "Map settings" (page 6-10)

- **[Guidance Settings]**

Sets the various functions for route guidance.

 "Guidance settings" (page 6-25)

- **[Route Preference]**

Changes the routing preferences.



 "Route Preference" (page 6-20)

- **[Traffic Info Settings]**

Sets the various functions of the Traffic information feature.

 "Traffic information settings" (page 6-28)

- **[Safety Guide Settings]**

Setting item	Action
[Speed Limit Indication on Map]	When this item is turned on, the speed limit indicator will appear on the right side of the map screen when there is a speed limit on the road the vehicle is driving on.  "2D map (for the Middle East)" (page 6-6)
[Speed Limit Warning]	When this item is turned on, the speed limit indicator will blink and warn the driver when the vehicle speed exceeds the speed limit.  "2D map (for the Middle East)" (page 6-6)
[Speed Limit Sens.]	Adjusts the speed limit sensitivity for [Speed Limit Warning].
[Safety Camera Warning Settings]	[Safety Camera Icon on Map] When this item is turned on, safety camera icons will appear on the map.

Setting item		Action
	[Safety Camera Warning]	When this item is turned on, safety camera warning indicator will appear on the right side of the map screen when the vehicle is approaching the safety cameras.

- **[Address Book]**

Stores locations and routes. Stored items can be edited or deleted.

 "Storing a location/route" (page 6-28)

- **[Customise POIs]/[Customize POIs]**

Sets the POI categories to be displayed on the Points of Interest screen.

- **[Adjust Current Location]**

If the vehicle icon indicating the current vehicle location is not in the correct position, the location of the vehicle icon on the map screen can be adjusted.

- **[Delete Saved Items]**

Deletes a saved location or route.

 "Deleting stored item individually" (page 6-35)

- **[Delete Previous Destinations]**

Deletes all or one of the previous destinations or the previous start point.

 "Deleting stored item individually" (page 6-35)

- **[Sync with Door to Door Nav]/[Sync with Door to Door Navigation]/[Sync with Smartphone Nav].]**

Turns on/off Door to Door Navigation.

- **[Predictable Destination Settings]**

Setting item	Action
[Offer Predictable Destinations]	Turns on/off the driving habit learning function. When this item is turned on, the system learns the driving habits and suggests the predicted destinations if available upon the system activation.
[Delete Predictable Information]	Deletes the learned driving habits.

- **[Reset All Navigation Settings to Default]**

This resets various settings (display, volume level, etc.) to the default settings.

GENERAL INFORMATION FOR NAVIGATION SYSTEM

CURRENT VEHICLE LOCATION

Display of current vehicle location

This navigation system combines the data obtained from the vehicle (by gyro sensor) and from Global Navigation Satellite System (GNSS) to calculate the current location of the vehicle. This position is then displayed throughout route guidance to a destination.

What is Global Navigation Satellite System (GNSS)?

GNSS is a general term for positioning systems that use signals from satellites. This navigation system receives radio signals from three or more different satellites, and detect the position of the vehicle by utilizing the principle of triangulation.

Positioning adjustment:

When the system judges that the vehicle position is not accurate based on vehicle speed and gyro sensor data calculations, the system will automatically adjust the position of the vehicle icon using GNSS signals.

Receiving signals from GNSS satellites:

The reception of GNSS signals can be weak, depending on the environment. Vehicles in the following areas/environments may not receive GNSS signals.

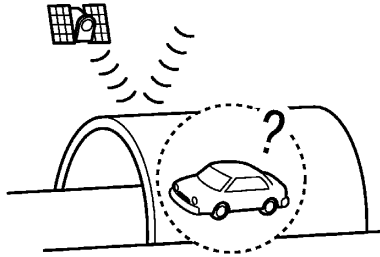

- Inside tunnels or parking garages

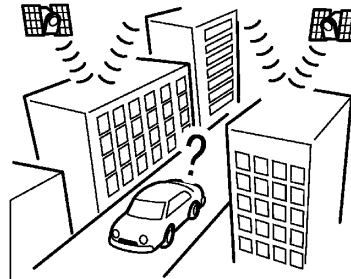

- In areas with numerous tall buildings

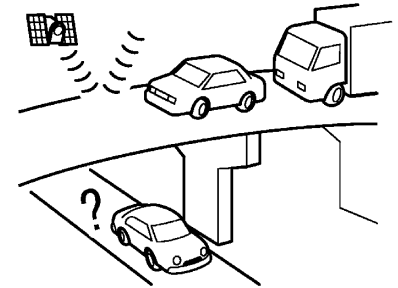

- Under multi-layered highways

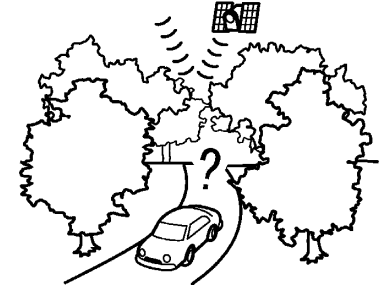

- Areas with numerous tall trees

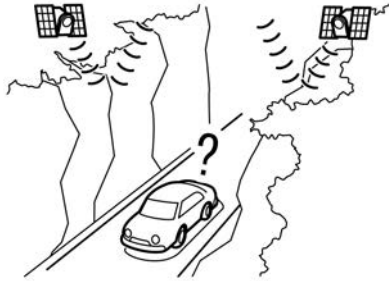

- In canyons

 **INFO:**

The GNSS antenna is located behind the instrument panel or inside the shark fin antenna (if equipped) on the roof. Do not place any objects, especially cellular phones or transceivers, on the instrument panel. Because the strength of the GNSS signal is weak, phones and transceivers will affect or may totally disrupt the signal.

Incorrect display of vehicle position

The following cases may affect the display accuracy of the vehicle's position or traveling direction. The accuracy will return to normal if the driving conditions return to normal.

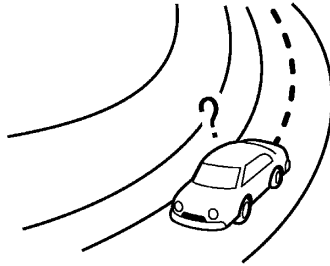

- When there is a similar road nearby.

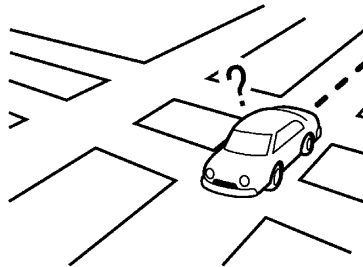

- When the vehicle is traveling in an area with a grid pattern road system.

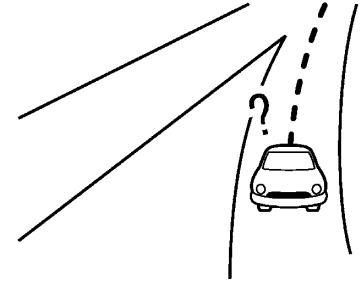

- When the vehicle is passing through a large Y-shaped intersection/junction.

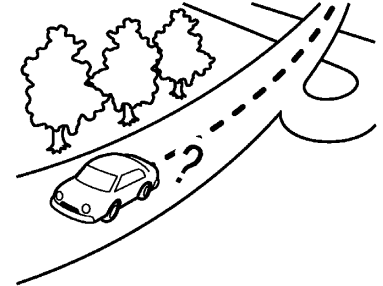

- When the vehicle is traveling on a continuous, slowly curving road.

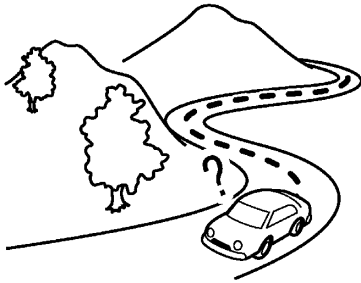

- When the vehicle is traveling on a road with repeating S-shaped curves.



- When the vehicle is on a snow-covered or unpaved road.

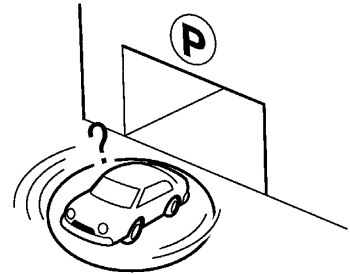

- When the vehicle is rotated on a parking lot turntable while the ignition switch placed in the OFF position.

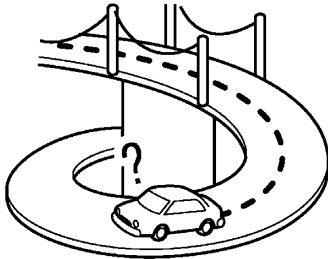

- When the vehicle is on a loop bridge.

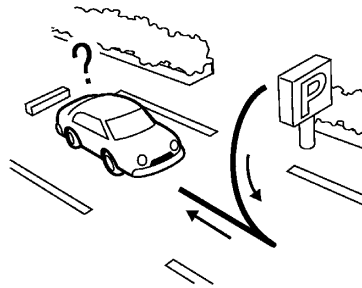

- When repeatedly turning left or right, or driving in zigzags.

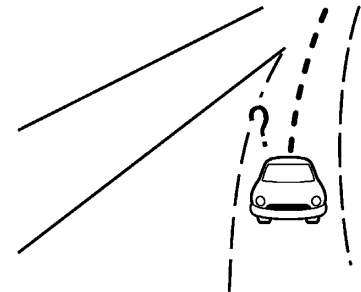

- When driving on a road not displayed on the map screen or a road that has been changed due to additional construction or other reasons.

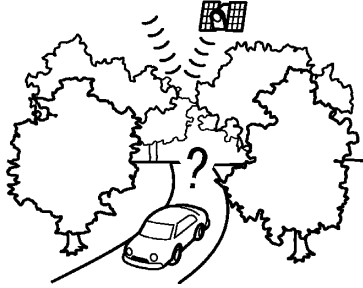

- When the GNSS positioning accuracy is low.

INFO:

- The vehicle icon may be misaligned when starting the vehicle just after starting the engine.
- The vehicle icon may also be misaligned if different sized tires or tire chains are installed.
- The system has a function that automatically corrects the vehicle icon position when it is misaligned from the actual position.
- Vehicle position correction by GNSS may not function when the vehicle is stopped.
- If the vehicle icon position does not return to normal even after driving for a while, correct the vehicle icon position manually.

Detailed Map Coverage Areas (MCA) for navigation system

This system is designed to help guiding to the destination, and it also performs other functions as outlined in this manual. However, the system must be used safely and properly. Information concerning road conditions, traffic signs and the availability of services may not always be up-to-date. The system is not a substitute for safe, proper and legal driving.

Map data covers select metropolitan areas.

Map data includes two types of areas: "Detailed coverage areas" providing all detailed road data and other areas showing "Main roads only".

INFO:

Detailed map data is not available in many areas and is generally limited to select major metropolitan areas.

ROUTE CALCULATION

- The suggested route may not be the shortest, nor are other circumstances such as traffic jams considered.
- Because of the inevitable difference in road conditions and circumstances between the time you use this system and the time the information was produced for the map data, there may be discrepancies in roads and regulations. In such cases, actual road

conditions and regulations take precedence over map data information.

- During route calculation, the map will not scroll, however the vehicle icon will move according to the actual vehicle's movement.
- During route calculation, buttons such as **<MAP>** and **<MENU>** will be disabled.
- In some cases, after the calculation is complete, the calculated route may not be immediately displayed.
- Waypoints that have been passed will be disregarded by rerouting calculation.
- If you scroll the map while the suggested route is being drawn, it may take more time to finish drawing.
- Route calculation may not be completed in the following cases.
 - If there is no main road within a range of 2.5 km (1.5 miles) from the vehicle, a message saying so will appear on the screen. Try recalculating when the vehicle is closer to a main road.
 - If there is no main road within a range of 2.5 km (1.5 miles) from the destination or waypoint, a message saying so will appear on the screen. Try setting the location closer to a main road.

- If the vehicle is too close to the destination or if there are no roads to the destination, a message saying so will appear on the screen.
- If it is impossible to reach the destination or waypoints because of traffic regulations, etc.
- If the only route to reach the destination or waypoints is extremely complicated.
- The following may occur when the route is displayed.
 - If you calculate a route on a main road, the starting point of the route may not exactly match the current vehicle location.
 - The endpoint of the route may not exactly match the destination.
 - If you calculate a route on a main road, the system may display a route from another main road. This may be because the position of the vehicle icon is not accurate. In this case, park the vehicle in a safe location and reset the vehicle icon, or continue driving to see if the position of the vehicle icon is automatically adjusted before recalculating the route.
 - There are cases in which the system shows an indirect route to reach the destination or waypoints, if you set them from stored or

facility information. In order to correct this, you must be careful about the traffic direction, especially when lanes with different travel directions are shown separately, such as interchanges and service areas.

- This system makes no distinction between limited traffic control and total control (blockage). It may show an indirect route even if the road is usable.
- Even if the ferry preference is set to OFF, a route that uses a ferry line may be suggested.

ROUTE GUIDANCE



INFO:

The system will announce street names when the system language is set to English.

Repeating voice guidance

This function is available throughout route guidance, from the time after the route calculation is completed until the vehicle arrives at the destination. Push and hold **<MAP>**. Voice guidance will be repeated.

Notes on voice guidance

- Voice guidance in this system should be regarded as a supplementary function. When driving the vehicle, check the route on the map and follow the actual roads and traffic regulations.
- Voice guidance is activated only for intersections with certain conditions. There may be cases where the vehicle has to turn, but voice guidance is not provided.
- Voice guidance contents may vary, depending on the direction of the turn and the type of intersection.
- The voice guidance timing will vary depending on the situation.
- When the vehicle has deviated from the suggested route, voice guidance is not available. The system will not announce this. Refer to the map and recalculate the route.
 - ☞ "Recalculating route" (page 6-23)
- Voice guidance may not accurately correspond with road numbers and directions at motorway junctions.
- The displayed street names may sometimes differ from the actual names.
- Voice guidance is not available when [Guidance Voice] is turned off.
- Voice guidance will start when the vehicle enters the suggested route.

Refer to the map for directions to the starting point of the route.

- When approaching a waypoint, the voice guidance will announce and inform the driver that the vehicle has reached a waypoint. Voice guidance will switch to the next section of the route. When voice guidance is not available, refer to the map for directions.
- In some cases, voice guidance ends before arrival at the destination. Refer to the destination icon on the map to reach the destination.
- Voice guidance may be partially operational or inoperative due to the angle of roads at an intersection.
- Motorway exit information may differ from the information on the actual exit signs.
- Because it is not possible to consider data concerning roads that are seasonally available or unavailable, a route may be displayed that does not match the actual traffic restrictions. Be sure to follow the actual traffic restrictions while driving.

HOW TO UPDATE MAP DATA



WARNING:

TO AVOID RISK OF DEATH OR SERIOUS PERSONAL INJURY WHEN UPDATING THE MAP SOFTWARE:

If you choose to park the vehicle within range of a Wi-Fi connection (if equipped) or a TCU (Telematics Control Unit) (if equipped), park the vehicle in a secure, safe well-ventilated location that is open to the air. During the update process, if you choose to park your vehicle, it should be kept in a well ventilated area to avoid exposure to carbon monoxide. Do not breathe exhaust gases; they contain colorless and odorless carbon monoxide. Carbon monoxide is dangerous. It can cause unconsciousness or death.

1. **Apply the parking brake.**
2. **Remain with the vehicle while the update is in process.**
3. **Do not allow children, pets or people who may need assistance to remain in the vehicle while the software is updating.**



NOTE:

The vehicle is not required to be parked during the map update process.

Map data can be updated via USB (if equipped), Wi-Fi (if equipped) or a TCU

(Telematics Control Unit) (if equipped).

Updating with USB memory (if equipped)

The navigation map data can be updated with the latest information by downloading a new map database to a USB memory device and installing it in the vehicle.

For map update, use the USB memory with the following specifications:

Supported media: USB2.0

Supported file system: FAT32

1. Push **<MENU>**.
2. Touch [Info] on the Launch Bar and then touch [System Information].
3. **Type A:**
Touch [Map Update] and then touch [Update via USB Device]/[Update by USB device].
4. **Type B:**
Touch [Map Update].
4. Touch [Save Map Information to USB Device]/[Save Map Information to USB].
5. Insert blank USB memory device into the USB connection port.

 "USB (Universal Serial Bus) connection ports" (page 2-5)

 **INFO:**

If data is in the USB memory, it may be deleted.

6. Touch [Start].
7. Touch [OK] after saving the map information to USB.
8. Access to the designated website with your personal computer. Download and install the map update tool in your personal computer. (Consult a NISSAN dealer for details.)
9. Download the updated data and store it in the USB memory with the map update tool.
10. Push **<MENU>**.
11. Touch [Info] on the Launch Bar and then touch [System Information].
12. **Type A:**
Touch [Map Update] and then touch [Update via USB Device]/[Update by USB device].
Type B:
Touch [Map Update].
13. Touch [Install Map Update from USB Device]/[Install Map Update from USB].
14. Insert the USB memory into the USB connection port.
A confirmation message is displayed. Confirm the contents of the message and touch [Yes].

15. Touch [OK] after completing the update.

 **INFO:**

- The navigation system cannot be operated while the map updates.
- Map data should be updated while the engine is running to prevent discharge of the vehicle battery.

Updating using wireless LAN (Wi-Fi) (if equipped)

If your vehicle is equipped with a TCU (Telematics Control Unit), the map data can be updated using the vehicle Wi-Fi connection. Wi-Fi communications can be made by using a Wi-Fi network, smartphone, etc.

 "Wi-Fi setting" (page 2-14)

1. Connect the vehicle to an available Wi-Fi network.
2. Push **<MENU>**.
3. Touch [Info] on the Launch Bar and then touch [System Information].
4. Touch [Map Update].
5. Touch [Update via Wi-Fi]/[Update by Wi-Fi].
A confirmation message is displayed.
6. Select an area to be updated, and touch [Start Updating].

Touch [Yes] to update the selected area.

7. Touch [OK] after completing the update.

 **INFO:**

- When [Cancel] is displayed during the map data update, touching the key can cancel the update.
- The navigation system cannot be operated while the map updates.
- Do not turn off the power source of the smartphone while updating.
- Map data should be updated while the engine is running to prevent discharge of the vehicle battery.
- Touch [Car Hotspot]/[Vehicle Hotspot] (if equipped) and turn on the indicator to activate the Wi-Fi hotspot communication.
- The download data size of map update for one country or one regional zone can vary between 100 MB to 1 GB. Data size in case of updating multiple countries or regional zones can be over 1 GB. Use of Wi-Fi hotspot functionality of your smartphone for map updates may incur additional data charges from your cellular provider. Please connect to your home Wi-Fi network to avoid additional phone data charges.
- Depending on the models, specifications and software versions, the

same operation can be performed from [System Update]/[System Updates] on the setting menu screen.  "System settings" (page 2-10)

- Depending on the models, specifications and software versions, the update is done in the background, and the updates are reflected in the map data the next time the system is started.
- When the vehicle power is shut-down, the map update is suspended. When the map update is resumed, select the same region to update the map from [Update via Wi-Fi]/[Update by Wi-Fi].

Automatic map update (if equipped)

The map data can be updated using the TCU (Telematics Control Unit).

1. Push **<MENU>**.
2. Touch [Info] on the Launch Bar and then touch [System Information].
3. Touch [Map Update].
4. Touch [Map Update Settings].
5. Select an area of the map you wish to update. A confirmation message is displayed. The next time you start the system, a notification message will be displayed if map data update is available.

6. When the new map data is available after the vehicle power is on, a pop-up message informing that a map update is available will appear. Touch [Yes] to update the map data.

INFO:

If user selects [No] on the pop-up screen, the automatic map update and software update will not be available forever and user always has to update map and software manually from the next time.

When the vehicle power is shutdown, the map update is suspended. When the map update is resumed, select the same region to update the map from [Update via Wi-Fi]/[Update by Wi-Fi].

7. Touch [OK] after completing the update.

INFO:

The update is done in the background, and the updates are reflected in the map data the next time the system is started.

Automotive products End User License Provisions

This End-User License Agreement ("**EULA**") is an agreement between you and TomTom International B.V. ("**TomTom**"). You agree that this EULA is enforceable. This EULA applies to your use of the TomTom Map data, software, Traffic and Travel

services or any other TomTom products (together with the "**Services**").

Please read this EULA carefully. By using the Services you agree to all the terms and conditions of this EULA.

1. **GRANT OF LICENSE:** In consideration of you agreeing to abide by the terms of this EULA, TomTom hereby grants to you a non-exclusive, license to use the Services solely in connection with the vehicle. If upgrades, updates or supplements to the Services are provided the use of such upgrades or updates is governed by this EULA.
2. **RESTRICTIONS:** You are prohibited from renting, lending, public presentation, performance or broadcasting or any other kind of distribution of the Services. Other than as permitted by applicable legislation, you will not, and you will not allow any person to, copy or modify the Services or any part thereof or to reverse engineer, de-compile or disassemble the Services.
3. **OWNERSHIP:** Copyright and other intellectual, industrial and/or proprietary rights to the Services are owned by TomTom and/or its suppliers. TomTom permits you to use the Services only in accordance with the terms of this EULA. All rights not specifically granted in this EULA are reserved by TomTom. To the extent applicable, you acknowledge that you have no right to have access to the Services in

source code or in unlocked coding.

4. **THIRD PARTY SOFTWARE LICENSES:** The Services may make use of third party software. Notwithstanding Clauses 2 and 3, use of some third party materials included in the Software may be subject to other terms and conditions. The official copyright notices and specific license conditions of these third party software codes and algorithms are to be found via <http://www.tomtom.com>. You hereby agree to the terms and conditions for such third party software.

5. **LIMITED WARRANTY:**

- YOU ACKNOWLEDGE THAT THE SERVICES HAVE NOT BEEN DEVELOPED TO MEET YOUR INDIVIDUAL REQUIREMENTS AND THAT IT IS THEREFORE YOUR RESPONSIBILITY TO ENSURE THAT THE FACILITIES AND FUNCTIONS OF THE SERVICES MEET YOUR REQUIREMENTS. TOMTOM DOES NOT AND CANNOT WARRANT THAT THE SERVICES OPERATE UNINTERRUPTED OR ERROR-FREE. YOU SHOULD BE PARTICULARLY AWARE OF THE FACT THAT CALCULATION ERRORS MAY OCCUR WHEN USING SOFTWARE IN A NAVIGATION SYSTEM FOR INSTANCE CAUSED BY LOCAL ENVIRONMENTAL CONDITIONS AND/OR INCOMPLETE DATA.

- TO THE MAXIMUM EXTENT PERMITTED BY APPLICABLE LAW, TOMTOM AND ITS SUPPLIERS PROVIDE THE SERVICES "AS IS", AND HEREBY DISCLAIM ALL OTHER WARRANTIES AND CONDITIONS, WHETHER EXPRESS, IMPLIED OR STATUTORY, INCLUDING, BUT NOT LIMITED TO, ANY (IF ANY) IMPLIED WARRANTIES, DUTIES OR CONDITIONS OF SATISFACTORY QUALITY, OF FITNESS FOR A PARTICULAR PURPOSE, OF RELIABILITY OR AVAILABILITY, OF ACCURACY OR COMPLETENESS OF RESPONSES, OF RESULTS, WITH REGARD TO THE SERVICES, AND THE PROVISION OF OR FAILURE TO PROVIDE SUPPORT OR OTHER SERVICES, INFORMATION, SOFTWARE, AND RELATED CONTENT THROUGH THE SERVICES OR OTHERWISE ARISING OUT OF THE USE OF THE SERVICES.

SAFETY: THE SERVICES ARE INTENDED TO BE USED FOR PROVIDING INFORMATION AND NAVIGATION SERVICES RELATED TO YOUR JOURNEY ONLY AND ARE NOT INTENDED TO BE USED AS A SAFETY RELATED TOOL AND CANNOT WARN YOU ABOUT ALL DANGERS AND HAZARDS WITH RESPECT TO THE ROAD YOU ARE DRIVING. THEREFORE, IT REMAINS YOUR DUTY TO DRIVE IN A CAREFUL AND SAFE MANNER (PAYING

ALL DUE CARE AND ATTENTION TO THE ROAD) AS WELL AS OBSERVING ALL APPLICABLE TRAFFIC REGULATIONS AND RULES. IT IS YOUR RESPONSIBILITY NOT TO USE THE SERVICES IN A MANNER THAT WOULD DISTRACT YOU FROM DRIVING SAFELY.

6. **LIMITATION OF LIABILITY:**

TO THE MAXIMUM EXTENT PERMITTED BY APPLICABLE LAW, NEITHER TOMTOM NOR ITS LICENSORS AND SUPPLIERS, OFFICERS, DIRECTORS OR EMPLOYEES SHALL BE LIABLE TO YOU OR TO ANY THIRD PARTY FOR ANY DAMAGES, WHETHER DIRECT, SPECIAL, INCIDENTAL, INDIRECT OR CONSEQUENTIAL (INCLUDING BUT NOT LIMITED TO, DAMAGES FOR THE INABILITY TO USE OR ACCESS THE SERVICES, LOSS OF DATA, LOSS OF BUSINESS, LOSS OF PROFITS, BUSINESS INTERRUPTION OR THE LIKE) ARISING OUT OF OR RELATED TO THE USE OF, THE INABILITY TO USE OR ACCESS, OR OTHERWISE THE PERFORMANCE OF THE SERVICES, EVEN IF NISSAN HAS BEEN ADVISED OF THE POSSIBILITY OF SUCH DAMAGES.

TO THE EXTENT TOMTOM IS NOT PERMITTED UNDER APPLICABLE LAW TO EXCLUDE ITS LIABILITY PURSUANT TO CLAUSE 6.1 ABOVE, TOMTOM'S TOTAL AGGREGATE LIABILITY TO YOU SHALL BE LIMITED TO THE AMOUNT

OF US \$100.00.

THE ABOVE LIMITATIONS OF LIABILITY UNDER THIS CLAUSE 6 DO NOT: (I) AFFECT YOUR RIGHTS UNDER ANY APPLICABLE MANDATORY NATIONAL LEGISLATION; (II) EXCLUDE OR LIMIT ANY LIABILITY THAT CANNOT BE EXCLUDED OR LIMITED UNDER APPLICABLE LAW.

7. TERMINATION: Without prejudice to any other rights, TomTom may immediately terminate this EULA if you fail to comply with any of its terms and conditions. The provisions of this Agreement, which by their nature are intended to survive termination, will remain in effect after termination of this EULA.
8. LINKS TO THIRD PARTY SITES: TomTom and other third parties involved in making the Services available to you ("Third Parties") are not responsible for the contents of any third-party sites or services, any links contained in third-party sites or services, or any changes or updates to third-party sites or services which are delivered by the Services or otherwise. TomTom (and, as applicable, each of the Third Parties) is providing these links and access to third-party sites and services to you only as a convenience, and the inclusion of any link or access does not imply an endorsement by TomTom or any Third Par-

ties of the third-party site or service. Any use by you of such links or third party sites and the manner in which you use such third party sites and links shall be your responsibility and at your risk and you shall not use them in any illegal or fraudulent manner.

Should you have any questions concerning this EULA, or if you desire to contact TomTom for any reason, please visit TomTom's website at <http://www.tomtom.com>.

7 Voice recognition (if equipped)

Voice recognition	7-2	Giving voice commands	7-2
Using Voice Recognition System	7-2	System Voice settings	7-5
Before starting	7-2		



VOICE RECOGNITION

USING VOICE RECOGNITION SYSTEM

Initialization

When the ignition switch is in the ACC or ON position, voice recognition is initialized. When the initialization is complete, the system is ready to accept voice commands. If  on the steering wheel is operated before the initialization completes, the display will show a message to wait until the system is ready.

BEFORE STARTING

To get the best recognition performance from voice recognition, observe the following items.

- The interior of the vehicle should be as quiet as possible. Close the windows to eliminate the surrounding noises (traffic noise, vibration sounds, etc.) and turn down the fan speed level of the heater/air conditioner to lower the noise which may prevent the system from correctly recognizing the voice commands.
- Wait until the tone sounds before speaking a command.
- Speak in a natural conversational voice without pausing between words.
- The system cannot recognize voice

commands spoken from passenger seats.

GIVING VOICE COMMANDS

1. Push  on the steering wheel.

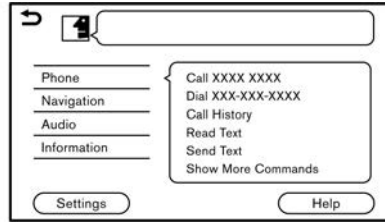









Example

2. A list of commands appears on the screen, and the system provides the voice menu prompt.

Available category commands are displayed on the left side of the screen. Speak or touch a category command from the category command list.

INFO:





- Some of the commands for each category are shown on the right side of the screen and they can also be spoken without selecting a category.
- After executing the category command, only the commands related to the selected category can be recognized.

3. After the tone sounds and the icon on the screen changes from  to , speak a command. You can also select a command by directly touching the screen, using //// (Scroll dial type) on the steering wheel or using **<PUSH SOUND/>**  **<TUNE SCROLL/PUSH SOUND/>**  **/ENTER SETTING>** on the control panel.

INFO:

- The Voice Recognition System will pause its operation when no command is given after a few prompts. To resume the operation, push  on the steering wheel.
4. Continue to follow the voice menu prompts and speak the voice commands after the tone sounds until the preferred operation is executed.

INFO:

- To exit the Voice Recognition System, push and hold  or  (if equipped) on the steering wheel. Pushing and holding the left side of  /  /  (if equipped) on the steering wheel can also exit the Voice Recognition System.
- Depending on the language setting, the Voice Recognition System cannot be used.

Operating tips

- Speak a command after the tone.
- If the command is not recognized, the system will prompt you to speak the command again. Repeat the command in a clear voice.
- Touch [↩] on the touch screen display to return to the previous screen. Pushing <↩> (if equipped) on the steering wheel or pushing the left side of <◀ / ↩ / ▶> (if equipped) on the steering wheel can also return to the previous screen.
- To adjust the volume of the system feedback, push <🔊> on the steering wheel or turn <🔊 /VOL>/<VOL/PUSH 🔊> on the control panel while the system is making an announcement.

Voice Prompt Interrupt:

In most cases, you can interrupt the voice feedback to speak the next command by pushing <🔊> on the steering wheel. After interrupting the system, wait for a tone before speaking your command.

One Shot Call:

To use the system faster when making a call, you may speak the second level command skipping speaking the first level command. For example, push <🔊> on the steering wheel and say "Redial" after the tone without first

saying "Phone".

How to see voice command screen

1. Push <🔊> on the steering wheel to display the first screen of the voice command list.
2. Speak a command or select an item on the voice command list. The second screen is displayed.
3. Speak a command or select an item on the voice command list. The command is executed or the next screen for further command is displayed.
4. Follow the prompts to complete the commands.

Voice command screens:

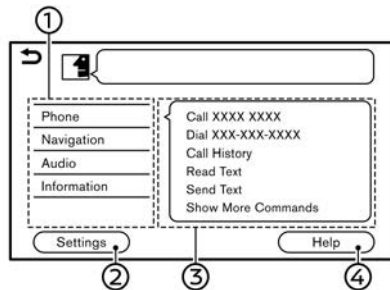

Example

- ① Shows a list of available categories. Speak a category command or touch the key of the corresponding cate-

gory.

- ② Touch [Settings] or say "Settings" to display the system voice settings.
- ③ Shows a list of available commands for the selected category. Speak a preferred command.
- ④ Touch [Help] or say "Help" to hear help announcements on how to use the system.

INFO:

Push <🔊> on the steering wheel to stop the help announcements.

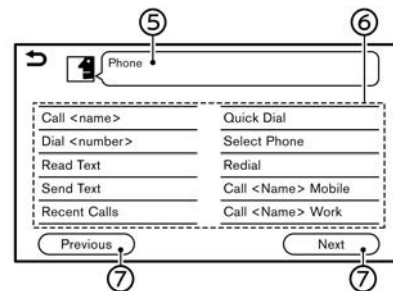

Example

- ⑤ Previously selected command
- ⑥ Command list

You can speak a command from the list or touch the corresponding key. Preferred words can be spoken for the part of the command enclosed in <>.

⑦ [Previous], [Next]

Say as a command or touch to go to the previous/next screen.

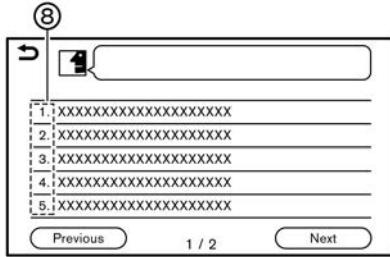

⑧ Speak a number from 1 to 5 or touch an item on the list screen to select the item.

How to speak numbers

The Voice Recognition System requires the user to speak numbers in a certain way when giving voice commands.

General rule:

Only single digits “0” (zero) to “9” can be used. (For example, for the number “600”, speaking “six zero zero” can be recognized by the system, but “six hundred” cannot be recognized.)

 **INFO:**

For the best recognition, speak “zero” for the number “0”, and “oh” for the letter “o”.

SYSTEM VOICE SETTINGS

The system voice settings can be changed.

1. Touch [System Voice] on the setting menu screen.
☞ “System settings” (page 2-10)
2. Touch the item you would like to set.

Available setting items may vary depending on models, specifications and software versions.

Available item	Action
[Initial Voice Prompt]	When this item is turned on, voice prompts are announced.
[Short Voice Prompts]	When this item is turned on, short and minimized voice feedback will be provided.
[Best Match Lists]	When these items are turned on, the voice recognition results are displayed on the list in the order of reliable recognition.
[Phonebook] [Music Commands]	
[Voice Preference]	Guidance voice setting can be selected from a male or female voice. Depending on the language setting, the guidance voice setting cannot be changed.
[Speech Rate]	Adjusts the speech rate of prompt.

MEMO

8 Troubleshooting guide

System unit	8-2	NissanConnect Services (if equipped)	8-16
Liquid crystal display	8-2	Apple CarPlay (if equipped)	8-17
Wi-Fi connection (if equipped)	8-3	Android Auto (if equipped)	8-19
Wi-Fi hotspot (if equipped)	8-4	Siri Eyes Free (if equipped)	8-20
Audio system	8-5	Navigation (if equipped)	8-21
AM radio	8-5	Basic operations	8-21
DAB radio (if equipped)	8-6	Map screen	8-22
iPod player	8-8	Route calculation and visual guidance	8-24
USB memory device	8-10	Voice guidance	8-26
Bluetooth® audio	8-11	Traffic information (if equipped)	8-27
Bluetooth® Hands-Free Phone System	8-13	Voice recognition (if equipped)	8-28



SYSTEM UNIT

LIQUID CRYSTAL DISPLAY

Symptom	Possible cause	Possible solution
The screen is too dark.	The cabin temperature is too low.	Wait until the cabin temperature becomes moderate.
	Screen brightness is set to the maximum darkness.	Adjust the brightness setting of the screen.
The screen is too bright.	Screen brightness is set to the maximum brightness.	Adjust the brightness setting of the screen.
A small black spot or a small bright spot appears on the screen.	This is a typical phenomenon for liquid crystal displays.	This is not a malfunction.
A dot or stripe pattern appears on the screen.	Electromagnetic waves that are generated from neon billboards, high voltage electric power cables, ham radios or other radio devices equipped to other vehicles may adversely affect the screen.	This is not a malfunction.
Image lag appears on the screen.	This is a typical phenomenon for liquid crystal displays.	This is not a malfunction.
Image motion displayed on the screen is slow.	The cabin temperature is less than 10°C (50°F).	Wait until the cabin temperature rises to within 10°C (50°F) and 50°C (122°F).
When looking at the screen from an angle, the screen lightens or darkens.	This is a typical phenomenon for liquid crystal displays.	Adjust the brightness setting of the screen.
The screen turns blue or an error message is displayed on the touch screen display.	A system malfunction has occurred.	It is recommended that you contact a NISSAN dealer for an inspection.

WI-FI CONNECTION (if equipped)

Symptom	Possible cause	Possible solution
The name of the device which you wish to connect is not displayed on the Connections screen.	The device is turned off.	Check that the device is turned on.
	The device does not support a WPA2 security network.	Check that the security network is supported by the device.
The in-vehicle system cannot connect to the Wi-Fi network.	The device is turned off.	Check that the device is turned on.
	The network password is incorrect.	Check that the network password is correct.
		Check the entered password is correct.

WI-FI HOTSPOT (if equipped)

Symptom	Possible cause	Possible solution
The device cannot connect to the vehicle Wi-Fi hotspot.	7 devices already connected.	Delete a connected device.
	The password is incorrect.	Check that the network password is correct.
		Check the entered password is correct.
The device cannot access the Internet.	The service provider's subscription is not active.	Check the service provider's subscription.
	The vehicle is out of the service area of the provider.	Move to a service supported area.
Slow connectivity to the network.	Another wireless connection interferes.	Turn off the other wireless devices.

AUDIO SYSTEM

AM RADIO

Symptom	Possible cause	Possible solution
AM reception deteriorates at night.	AM stations are required to lower their power at night.	This is not a malfunction.

DAB RADIO (if equipped)

Symptom	Possible cause	Possible solution
The sound skips, stutters or echoes.	The radio station has not properly aligned digital and analog audio.	Verify correct operation on another station. Report the station with poor performance.
The volume level is unstable.	Level alignment is inappropriate.	Verify correct operation on another station and check the station availability in the area. Report the station with poor alignment.
The sound fades in/out.	DAB-FM is taking place.	Verify transition performance on several stations in the area. Report stations with poor alignment.
Excessive DAB-FM takes place.	The vehicle is located near the edge of the DAB coverage area.	Verify the radio station coverage in your area.
The sound quality of DAB is no better than that of FM/AM.	Audio processing on the digital audio by the station can potentially decrease digital audio sound quality.	Verify correct operation on another station. Report the station with poor performance.
Local stations keep being lost.	Digital coverage is slightly smaller than analog signal coverage.	Verify correct operation on another station.
	Shadowing (Urban/Terrain) can cause reduced digital coverage.	Verify correct operation on another station.
Some data fields are blank.	Text information is sent at the broadcaster's discretion.	Verify correct operation on another station. Report the station issue.
Text information is truncated.	The display is limited to a fixed number of characters and more data is being sent than can be displayed.	This is not a malfunction.
The DAB-FM setting is turned on but an alternative station does not play and the signal does not appear on the display.	The tuner is waiting for the original signal to recover and is seeking an available alternative signal.	Wait for the signal to return or for the tuner to pick up an alternative signal.
A message indicating that service is not available is displayed on the screen.	The selected service or ensemble is not in service.	Select a different service or ensemble.



INFO:

- When station presetting is performed while a secondary service is playing, the parent primary service will be registered.
- Secondary services do not appear on the station list.

iPod PLAYER

Symptom	Possible cause	Possible solution
The system does not recognize an iPod.	A connector cable is not correctly connected, or the iPod does not correctly operate.	Connect the connector cable again. If the system does not recognize the iPod after performing this procedure above, reset the iPod.
	The iPod that is to be connected is not compatible with the system.	Check the iPod model and firmware versions available for the system.
	The connected USB extension cable is not compatible with the system.	Replace the USB extension cable if the system still does not recognize the iPod after reconnecting the cable properly a number of times.
	The cable is rapidly connected to or disconnected from the USB connection port.	Slowly connect or disconnect the USB cable.
An iPod cannot be operated.	The iPod is connected to the in-vehicle audio system while headsets, etc. are connected to the iPod.	Remove all equipment from the iPod after disconnecting the iPod from the system, and then connect it to the system again.
	The iPod is not operating normally.	Disconnect the iPod from the in-vehicle audio system, and then connect it to the system again.
	The system plays back an album/file that includes a particular album art.	Disconnect the iPod from the in-vehicle audio system, and then reset the iPod. Disable the album art, and then connect the iPod to the system.
An iPod does not respond.	There are too many files in a category.	Decrease the number of files in a category (less than 65500 files).
	The shuffle function is turned on.	Turn off the shuffle function if many files are stored on the iPod.
Music cannot be played back.	A connector is not connected to the iPod.	Firmly connect the connector to the iPod.
Playback cuts out.	The sound cuts due to vibration resulting from an unstable location of the iPod.	Place the iPod on a stable location where it does not roll over.

Symptom	Possible cause	Possible solution
Battery charge of an iPod takes longer.	Battery charge of the iPod may take longer while an iPod is playing back.	If the iPod needs to be charged, it is recommended to stop playing the music.
Battery charge of an iPod is unavailable.	The cable that is connected to the iPod may be damaged or improperly connected.	Check the cable currently in use.
Functions cannot be operated using an iPod that is connected to the in-vehicle audio system.	-	The operation of an iPod must be performed using the in-vehicle audio system after the iPod is connected to the system.
Sound skips.	Surrounding circumstances (noise, etc.) may cause the sound to skip.	This does not indicate a malfunction.
	A USB extension cable is used.	Do not use a USB extension cable.

USB MEMORY DEVICE

Symptom	Possible cause	Possible solution
The system does not recognize a USB device.	A USB extension cable is used.	Do not use a USB extension cable.
	A USB hub is used.	Do not use a USB hub.
	A USB device is rapidly connected to or disconnected from the USB connection port.	Slowly connect or disconnect the USB device.

BLUETOOTH® AUDIO

Symptom	Possible cause	Possible solution
Registration cannot be performed.	The Bluetooth® audio device is not compatible with the in-vehicle audio system.	Check the Bluetooth® audio device Owner's Manual.
	Bluetooth® is disabled on device.	Check that the Bluetooth® function is enabled on device.
	The PIN code is incorrect.	Check the PIN code for the Bluetooth® audio device that is to be registered.
		Check that the PIN code for the Bluetooth® audio device is consistent with that for the in-vehicle audio system.
Another Bluetooth® device is used in the vehicle.	Turn off the other Bluetooth® device until the registration is completed.	
Music cannot be played back.	The Bluetooth® audio device is not compatible with the in-vehicle audio system.	Check the Bluetooth® audio device Owner's Manual.
	The system is not set to the Bluetooth® audio mode.	Push <AUDIO> and select the Bluetooth® audio mode.  "Selecting audio source" (page 3-7)
	A Bluetooth® adapter is turned off.	Turn on a Bluetooth® adapter when it is used for a Bluetooth® audio device.
Playback stops.	The Bluetooth® audio device is not compatible with the in-vehicle audio system.	Use a device compatible with the system. Ask a NISSAN dealer for information regarding model compatibility.
	A cellular call is active.	This is not a malfunction.
	Sound may cut out when a Bluetooth® audio device is operated.	Push <AUDIO> and select the Bluetooth® audio mode, and then operate a function on the touch screen display of the in-vehicle system instead of conducting the operation on the Bluetooth® audio device.

Symptom	Possible cause	Possible solution
Audio operation cannot be performed.	A Bluetooth® audio device that does not support audio operations is in use.	Use a device compatible with the system. Ask a NISSAN dealer for information regarding model compatibility.
	An error occurs when connecting to a Bluetooth® audio profile.	Turn the power source of the Bluetooth® audio player off and on, and then resume connection with the system.







BLUETOOTH® HANDS-FREE PHONE SYSTEM

Symptom	Possible cause	Possible solution
A cellular phone cannot be registered.	The cellular phone is not compatible with the in-vehicle hands-free phone system.	Use a cellular phone compatible with the system. Ask a NISSAN dealer for information regarding model compatibility.
	Registration of the cellular phone has been performed incorrectly.	Check the registration procedure, and then register the cellular phone again.
A cellular phone cannot be connected or is disconnected after the registration is completed.	The Bluetooth® setting of the in-vehicle hands-free phone system is turned off.	Turn on the Bluetooth® setting of the system.
	The Bluetooth® setting of the cellular phone is turned off.	Turn on the Bluetooth® setting of the cellular phone.
	The remaining battery level of the cellular phone is low.	Charge the battery of the cellular phone.
	The wireless Bluetooth® connection may be disrupted depending on the location of the cellular phone.	Do not place the cellular phone in an area surrounded by metal or far away from the in-vehicle hands-free phone system. Do not place the cellular phone close to the seats or your body.
	Registration of the cellular phone is not completed.	Perform registration of the cellular phone.
A call to a particular phone number fails.	If the system tries to make a call several times to the same phone number (for example: the party does not respond to the call, the party is out of the service area, or the call is abandoned before the party responds), the system may reject a request to make a call to the phone number.	Turn off the cellular phone and turn it on again to reset the connection.







Symptom	Possible cause	Possible solution
The system does not recognize the connection of a cellular phone. The system does not receive or make a call.	The cellular phone is not compatible with the in-vehicle hands-free phone system.	Use a cellular phone compatible with the system. Ask a NISSAN dealer for information regarding model compatibility.
	The cellular phone is not connected.	Check the registration procedure, and then register the cellular phone again.
	The phone operation is limited by the functions (such as dial lock, etc.) of the registered cellular phone.	Remove any settings that are limiting use of the cellular phone, and then perform registration again.
The other party cannot hear your voice. The other party can hear your voice, but it cracks or cuts out.	Mute function is enabled.	Verify mute function is disabled.
	The cellular phone is not connected.	Check the registration procedure, and then register the cellular phone again.
	The fan speed of the heater/air conditioner is too fast.	Decrease the fan speed of the heater/air conditioner.
	The ambient noise level is excessive. (For example: heavy rain, construction sites, inside a tunnel, oncoming vehicles, etc.)	Close the windows to shut out ambient noise.
	The noise generated by driving the vehicle is too loud.	Reduce the vehicle speed.
	The incoming voice volume is too loud/soft.	Adjust the volume using < VOL > / < VOL / PUSH > / < VOL / PUSH POWER > on the control panel or < > on the steering wheel.
	The outgoing voice volume is too loud/soft.	Adjust the volume from volume adjustment screen.
The voice is cut out or noise is heard during a call.	The wireless Bluetooth® connection may be disrupted depending on the location of the cellular phone.	Do not place the cellular phone in an area surrounded by metal or far away from the in-vehicle hands-free phone system. Do not place a cellular phone close to the seats or your body.
When a cellular phone is operated to make a call, the hands-free function becomes unavailable.	Some models of a cellular phone do not switch to the hands-free mode when they are operated to make a call.	This is not a malfunction. Make another call using the hands-free function.



Symptom	Possible cause	Possible solution
The other party's voice cannot be heard. There is no ringtone.	The volume level is set to the minimum.	Adjust the volume level.
	A cellular phone is not connected.	Check the registration procedure, and then register the cellular phone again.
Each volume level (ringtone, incoming voice or outgoing voice) is different.	Each volume level is not adjusted properly.	Adjust each volume level properly.
The antenna display is different between the touch screen display and a cellular phone screen. Making or receiving a call is unavailable even though the antenna display shows that it is possible to do so.	The antenna display varies depending on the model of cellular phone.	This does not indicate a malfunction. The antenna display and remaining battery level shown on the touch screen display may be different from those shown on the cellular phone screen. Use them as a reference.
A voice cannot be heard clearly when using a cellular phone behind tall buildings.	Some structures such as tall buildings, etc. may cause irregular reflection of radio waves or completely shut out radio waves that are used for cellular phones.	Move to a place without tall buildings.
Noise is heard when using a cellular phone under/near areas of elevated railroads, high voltage electric power cables, traffic signals, neon billboards, etc.	Electromagnetic waves that are generated from radio devices may adversely affect the cellular phone.	This is not a malfunction.
Noise is heard in the sound from the audio system while using a cellular phone.	Radio waves that are generated from a cellular phone may adversely affect the sound from the audio system.	This is not a malfunction.
Sound skips or stutters.	The cellular phone may have turned on the wireless LAN (Wi-Fi).	Turn off the wireless LAN (Wi-Fi).
Phonebook cannot be downloaded.	An error occurred during the phone pairing process.	Please delete the Bluetooth® pairing information from both the cellular phone and vehicle system before registering it again.
	Phone does not support phonebook download function.	Use a cellular phone compatible with the system. Ask a NISSAN dealer for information regarding model compatibility.

NISSANCONNECT SERVICES (if equipped)







Symptom	Possible cause	Possible solution
The system cannot connect to the NissanConnect Services Data Center.	A subscription for the NissanConnect Services has not been established.	Sign up for a subscription to the NissanConnect Services. For details about subscriptions, visit the website, contact the support line or contact a NISSAN dealer.  "NissanConnect Services (if equipped for Europe, Russia and Ukraine)" (page 5-5)  "NissanConnect Services powered by SiriusXM™ (for Mexico)" (page 5-6)
	The communication line is busy.	Try again after a short period of time.
	The vehicle is in a location where it is difficult to receive radio waves.	When the vehicle moves to an area where radio waves can be transmitted sufficiently, communication will be restored. When the icon on the display shows that the vehicle is inside the communication area, the system can be used.
	TCU (Telematics Control Unit) is not turned on.	If the icon does not show that the vehicle is inside the communication area despite the fact that the vehicle is in that location, visit the website, contact the support line or contact a NISSAN dealer.  "NissanConnect Services (if equipped for Europe, Russia and Ukraine)" (page 5-5)  "NissanConnect Services powered by SiriusXM™ (for Mexico)" (page 5-6)
	Radio wave reception is not sufficient for TCU (Telematics Control Unit) operation.	When the vehicle moves to an area where radio waves can be transmitted sufficiently, communication will be restored. When the icon on the display shows that the vehicle is inside the communication area, the system can be used.
Some of the items that are displayed on the menu screen cannot be selected.	The vehicle is being driven and some menu items are disabled.	Stop the vehicle in a safe location and apply the parking brake before operating the menu screen items.
Some parts of the screen are not displayed.	The vehicle is being driven and some menu items are disabled.	Operate the system after stopping the vehicle in a safe location and applying the parking brake.
The system does not announce information.	The volume level is set to the minimum.	Adjust the volume level by operating <  /VOL>/<VOL/PUSH  >/<VOL/PUSH POWER> on the control panel or <  > on the steering wheel switch while the system is announcing information.

Apple CarPlay (if equipped)

Symptom	Cause and Countermeasure
<p>Cannot start Apple CarPlay though it is tethered to the vehicle.</p>	<p>The USB cable is not connected to the USB connection port. Properly connect the USB cable to the USB connection port.  "USB (Universal Serial Bus) connection ports" (page 2-5)</p>
	<p>[Start-up Options] is set to [Never Start]. Change the setting to [Auto] or [Ask Every Time].  "Apple CarPlay settings" (page 5-18)</p>
	<p>Use an Apple Lightning cable (Mfi certified) to connect your phone to the USB connection port and check that the cable is not broken.</p>
	<p>Apple CarPlay setting is not active on your iPhone. Turn on "CarPlay" on your iPhone.</p>
	<p>The device is not compatible with Apple CarPlay. Check the compatibility requirements.</p>
<p>Cannot use wireless Apple CarPlay (if equipped).</p>	<p>The wireless connection is not completed properly. To activate wireless Apple CarPlay, touch  on the Connections settings screen.  "Connections settings" (page 2-12)</p>
	<p>The wireless connection is not completed properly.  "Connecting iPhone" (page 5-15) Delete iPhone on the devices list and reconnect it to the in-vehicle system.  "Setting devices" (page 2-12)</p>
<p>Apple CarPlay performance decreases. For example, slow connectivity or slow application functionality. or An error message appears when trying to access features of Apple CarPlay. A blank screen appears when trying to access maps.</p>	<p>Confirm you have a compatible iPhone, a cellular connection and an active data plan.</p>
	<p>Use an Apple Lightning cable (Mfi certified) to connect your phone to the USB connection port.</p>
	<p>Phone's performance or cellular connection. Disconnect and reconnect your phone.</p>
	<p>Phone's performance or cellular connection. Cycle phone power off/on to restart.</p>

Symptom	Cause and Countermeasure
Cannot access Siri using <  > on the steering wheel.	The USB cable may not be properly connected. Disconnect and reconnect the USB cable.
	Siri setting is not enabled on the phone. Turn on Siri on your phone.
	Check that you are pushing and holding <  > instead of just pushing the switch to initiate Siri operation.

Android Auto (if equipped)

Symptom	Cause and Countermeasure
<p>Cannot start Android Auto though it is connected to the vehicle.</p>	<p>The USB cable is not connected to the USB connection port. Properly connect the USB cable to the USB connection port.  "USB (Universal Serial Bus) connection ports" (page 2-5)</p>
	<p>[Start-up Options] is set to [Never Start]. Change the setting to [Auto] or [Ask Every Time].  "Android Auto settings" (page 5-21)</p>
	<p>To activate Android Auto, touch  on the Launch Bar or touch [Smartphone Connection] on the information screen and then touch [Android Auto].  "Selecting menu from Launch Bar" (page 2-7)  "Information menu" (page 5-2)</p>
	<p>The connected device is not compatible with Android Auto. Check the compatibility requirements.</p>
	<p>Your Android phone may not be recognized if its battery is low. Charge your Android phone then try again.</p>
<p>Android Auto performance decreases. For example, slow connectivity or slow application functionality. or An error message appears when trying to access features of Android Auto. A blank screen appears when trying to access maps.</p>	<p>Confirm you have a compatible Android phone, a cellular connection and an active data plan.</p>
	<p>Use the Android phone OEM cable to connect your phone to the USB connection port.</p>
	<p>Phone's performance or cellular connection. Disconnect and reconnect your phone.</p>
	<p>Phone's performance or cellular connection. Close all apps and restart them. Phone's performance or cellular connection. Cycle phone power off/on to restart.</p>
<p>Cannot start voice operation using  > on the steering wheel.</p>	<p>The USB cable may not be properly connected. Disconnect and reconnect the USB cable.</p>
	<p>Voice operation cannot be performed while driving. Turn on appropriate settings on your Android phone.</p>
	<p>Check that you are pushing and holding  > instead of just pushing the switch to initiate voice operation.</p>

Siri Eyes Free (if equipped)





Symptom	Cause and Countermeasure
Cannot access Siri Eyes Free using on the steering wheel.	Check if a Bluetooth® connection is established between the iPhone and the system.
	Check if Siri is enabled on the device. On your phone, go to Siri setting.
	Check that Siri can be accessed from the device lock screen. This can be set in the settings menu of your phone.
Audio source does not change automatically to iPod or Bluetooth® Audio mode.	For best results, use the native music app. Performance of music control function while using Podcasts, Audiobook or other third party music apps may vary.
	For best results, play media already stored on your device. Streaming music or playback from cloud storage may degrade performance.
	Switch the source manually.  "Selecting audio source" (page 3-7)
Play, pause, next track, previous track or play timer does not work.	For best results, use the native music app. Performance of music control function while using Podcasts, Audiobook or other third party music apps may vary and is controlled by the device.
Cannot hear any music/audio being played back from a connected iPhone.	Check that the audio source is set to Bluetooth® Audio or iPod mode. A USB connection is required for iPod mode.
Models with navigation system: Cannot hear map turn-by-turn direction guidance from a connected iPhone.	Check that the audio source is set to Bluetooth® Audio or iPod mode. A USB connection is required for iPod mode.
Cannot receive text message notifications on the vehicle audio system.	Check if notification setting is enabled on your phone.
Cannot reply to text message notifications using Siri Eyes Free.	After receiving an incoming text message, follow the on-screen guidance. Push and hold on the steering wheel for Siri Eyes Free operation. After Siri Eyes Free starts, speak an appropriate command to reply to the message using Siri Eyes Free.

NAVIGATION (if equipped)

BASIC OPERATIONS

Symptom	Possible cause	Possible solution
No image is displayed.	The brightness is at the lowest setting.	Adjust the brightness of the display.
	The display is turned off.	Push <*/> to turn on the display.
The volume of the voice guidance is too high or too low.	The volume is not set correctly, or the voice guidance setting is turned off.	Adjust the volume of the voice guidance or turn on the voice guidance setting.
No map is displayed on the screen.	A screen other than a map screen is displayed.	Touch [Map] on the Launch Bar or push <MAP> .
The screen is too dim. The movement is slow.	The temperature in the interior of the vehicle is low.	Wait until the interior of the vehicle has warmed up.
Some pixels in the display are darker or brighter than others.	This condition is an inherent characteristic of liquid crystal displays.	This is not a malfunction.
Some menu items cannot be selected.	Some menu items become unavailable while the vehicle is driven.	Park the vehicle in a safe location, and then operate the navigation system.

MAP SCREEN

Symptom	Possible cause	Possible solution
Names of roads and locations differ between 2D and 3D view.	This is because the quantity of the displayed information is reduced so that the screen does not become too cluttered. There is also a chance that names of the roads or locations may be displayed multiple times, and the names appearing on the screen may be different because of a processing procedure.	This is not a malfunction.
The location of the vehicle icon is misaligned from the actual position.	The vehicle was transported after the ignition switch was placed in the OFF position, for example, by a ferry or car transporter.	Drive the vehicle for a period of time on a road where Global Navigation Satellite System (GNSS) signals can be received.
	The position and direction of the vehicle icon may be incorrect depending on the driving environments and the levels of positioning accuracy of the navigation system.	This is not a malfunction. Drive the vehicle for a period of time to automatically correct the position and direction of the vehicle icon.  "Current vehicle location" (page 6-39)
	Driving with tire chains or tires that have been replaced may result in an incorrect vehicle location display due to miscalculation by the speed sensor.	Drive the vehicle for a period of time (at approximately 30 km/h (19 MPH) for about 30 minutes) to automatically correct the vehicle icon position. If this does not correct the vehicle icon position, it is recommended you contact a NISSAN dealer.
	The map data has a mistake or is incomplete (the vehicle icon position is always misaligned in the same area).	Updated road information will be included in the next version of the map data.  "How to update map data" (page 6-44)
When the vehicle is traveling on a new road, the vehicle icon is located on another road nearby.	Because the new road is not stored in the map data, the system automatically places the vehicle icon on the nearest road available.	Updated road information will be included in the next version of the map data.  "How to update map data" (page 6-44)
The screen does not switch to the night screen even after turning on the headlights.	The daytime screen was set the last time the headlights were turned on.	Set the screen to the night screen mode using  when turning on the headlights.

Symptom	Possible cause	Possible solution
The map does not scroll even when the vehicle is moving.	The current location map screen is not displayed.	Touch [Map] on the Launch Bar or push <MAP> .
The vehicle icon is not displayed.	The current location map screen is not displayed.	Touch [Map] on the Launch Bar or push <MAP> .

ROUTE CALCULATION AND VISUAL GUIDANCE



Symptom	Possible cause	Possible solution
Waypoints are not included in the auto reroute calculation.	Waypoints that have been already passed are not included in the auto reroute calculation.	To go to that waypoint again, edit the route.
Route information is not displayed.	Route calculation has not yet been performed.	Set the destination and perform route calculation.
	The vehicle is not on the suggested route.	Drive on the suggested route.
	Route guidance is turned off.	Turn on route guidance.
	Route information is not provided for certain types of roads.	This is not a malfunction.
The auto reroute calculation (or detour calculation) suggests the same route as the one previously suggested.	Route calculations took priority conditions into consideration, but the same route was calculated.	This is not a malfunction.
A waypoint cannot be added.	Twenty waypoints are already set on the route, including ones that the vehicle has already passed.	A maximum of 20 waypoints can be set on the route. To go to 21 or more waypoints, perform route calculations multiple times as necessary.
The suggested route is not displayed.	Roads near the destination cannot be calculated.	Reset the destination to a main or ordinary road, and recalculate the route.
	The starting point and destination are too close.	Set a more distant destination.
	The starting point and destination are too far away.	Divide the trip by selecting one or two intermediate destinations, and perform route calculations multiple times.
	There are time restricted roads (by the day of the week, by time) near the current vehicle location or destination.	Select [Do Not Use Restriction Info] in the [Time Restricted Roads] setting.] 28 "Route Preference" (page 6-20)
A part of the route is not displayed.	The suggested route includes narrow streets.	This is not a malfunction.

Symptom	Possible cause	Possible solution
The part of the route that the vehicle has already passed is deleted.	A route is managed by sections between waypoints. If the vehicle passed the first waypoint, the section between the starting point and the waypoint is deleted (it may not be deleted depending on the area).	This is not a malfunction.
An indirect route is suggested.	If there are restrictions (such as one-way streets) on roads close to the starting point or destination, the system may suggest an indirect route.	Adjust the location of the starting point or destination.
	The system may suggest an indirect route because route calculation does not take into consideration some areas such as narrow streets.	Reset the destination to a main or ordinary road, and recalculate the route.
The landmark information does not correspond to the actual information.	This may be caused by insufficient or incorrect map data.	Updated information will be included in the next version of the map data.  "How to update map data" (page 6-44)
The suggested route does not exactly connect to the starting point, waypoints or destination.	There is no data for route calculation closer to these locations.	Set the starting point, waypoints and destination on a main road, and perform route calculation.

VOICE GUIDANCE

Symptom	Possible cause	Possible solution
Voice guidance is not available.	The vehicle has deviated from the suggested route.	Go back to the suggested route or request route calculation again.
	Voice guidance is turned off.	Turn on voice guidance.
	Route guidance is turned off.	Turn on route guidance.
The guidance content does not correspond to the actual road conditions.	The content of voice guidance may vary, depending on the types of intersections at which turns are made.	Follow all traffic rules and regulations.

TRAFFIC INFORMATION (if equipped)

Symptom	Possible cause	Possible solution
Traffic information is not displayed.	The Premium Traffic setting is turned off.	Turn on the Premium Traffic setting.  "Traffic information settings" (page 6-28)
	The vehicle is in an area where traffic information is not available.	Scroll to an area where traffic information is available.
	The map scale is set at a level where the icons cannot be displayed.	Check that the map scale is set at a level at which the icons can be displayed.  "Traffic information on map" (page 6-27)
The suggested detour route does not avoid congested areas.	A faster route was not found, based on the road network and available traffic information.	The automatic detour search is not intended for avoiding traffic jams. It searches for the fastest route taking conditions such as traffic jams into consideration. Follow the suggested route.  "Viewing traffic information" (page 6-26)
The route does not avoid a road section with traffic information stating that it is closed due to road construction.	The navigation system does not avoid roads under construction if the day and time of the actual roadwork differs from the one that was declared.	Observe the actual road conditions and follow the instructions on the road to make a detour when necessary. If the road is closed, use the detour function and set the detour distance to avoid the road section that is closed.

VOICE RECOGNITION (if equipped)

Symptom	Possible cause	Possible solution
The system does not operate or fails to interpret the command correctly.	The interior of the vehicle is too noisy.	Close the windows or have the other occupants be quiet.
	The fan speed of the heater/air conditioner is too fast.	Decrease the fan speed of the heater/air conditioner.
	The noise generated by driving the vehicle is too loud.	Reduce the vehicle speed.
	The voice command is spoken in a low voice.	Speak the command in a louder voice.
	The timing of speaking a command is too early.	Speak the command after confirming the following: a voice guidance is announced, a tone sounds, and an icon on the screen changes from gray to orange.
	The command is spoken too slowly.	Speak in a natural voice without pausing between words.
The system prompts to repeat a command.	Pronunciation is unclear.	Speak clearly.
	The command is spoken too late after the tone.	Speak the command within 5 seconds after confirming the following: a voice guidance is announced, a tone sounds, and an icon on the screen changes from gray to orange.
	An improper command is spoken.	Speak the command or a number that is displayed on the screen.
Speak a command that is shown in the command list.		
The system does not correctly recognize a number spoken.	Too many numbers are spoken at once.	Place a pause between the appropriate digits for correct recognition by the system. When speaking a phone number, place a pause between area codes, dial codes, etc.
USB memory device cannot be operated with voice commands.	Depending on the device, iPhone or iPod may be recognized as a USB memory device.	This is not a malfunction.
The USB/iPod operation screen is grayed out.	The audio device is not connected.	Connect an audio device to the system.

Symptom	Possible cause	Possible solution
An error message is displayed when trying to select a track and operate USB/iPod.	The track information is being processed for registration by the system.	Song information will be loaded into the system when a new audio device is registered for the first time or when the song information in the pre-registered device has been changed. Please wait for the loading to complete which may take a few minutes to up to an hour.
	A number of songs exceeding the amount the device can contain are stored in the connected audio device.	Decrease the number of songs stored in the audio device.
	No song is stored in the audio device.	Store songs in the connected audio device. Storing songs with information such as artist name, album name, song name, playlist, etc., will make voice recognition song search available.

MEMO

9 Index

Number	
2D map	6-4, 6-6
3D map	6-7
A	
About route guidance	6-16
Android Auto	5-19
Apple CarPlay	5-15
Audio operation precautions	3-2
Audio operations	3-7
B	
Bluetooth® audio	3-7
Bluetooth® Hands-Free Phone System	4-2
Building graphics	6-7
C	
Changing order of destination and waypoints	6-24
Changing scale of map	6-9
Compass mode display	6-8
Connecting Bluetooth® Hands-Free Phone	4-4
Connections settings	2-12
Control buttons and touch screen display	2-2
Current vehicle location	6-39

D	
Deleting stored item	6-34
Destination setting menu	6-13
Displaying navigation screen	6-2
During a call	4-5
E	
Editing route	6-23
Editing stored information	6-30
F	
Functions disabled while driving	2-9
G	
Giving voice commands	7-2
H	
Hands-free text messaging assistant	4-6
How to see voice command screen ...	7-3
I	
Information menu	5-2
Interactive Voice Menu	5-11
L	
Launch Bar	2-7
Liquid crystal display	2-3

Log-in screen	2-6
M	
Making a call	4-4
Map Menu screen	6-13
Map types	6-3
Map update	6-44
Map view settings	6-10
Moving map	6-8
N	
Navigation screen	6-2
Navigation settings	6-36
NissanConnect Services	5-5, 5-6
O	
One Shot Call	7-3
Options before starting the route guidance	6-16
P	
Phone	4-4
Phone selection	4-4
Phone settings	4-10
Q	
Quick Dial	4-12

R

Radio	3-2, 3-8
Recalculating route	6-23
Receiving a call	4-4
Route calculation	6-42
Route guidance	6-16, 6-43

S

Safety information	1-3, 6-2
Settings menu	2-10
Siri Eyes Free	5-22
Starting system	2-6
Storing a location/route	6-28
Storing avoid area	6-30
Storing home location	6-28
Storing location	6-28
Storing route	6-29
Swipe-down notifications	2-9
System settings	2-10
System update	5-4
System voice settings	7-5

T

Text message settings	4-10
Touch screen display	2-3
Trademarks	1-5
Traffic information settings	6-28

U

USB (Universal Serial Bus) connection ports	2-5
--	-----

USB memory device care and cleaning	3-20
User selection	2-6

V

Viewing traffic information	6-26
Voice Prompt Interrupt	7-3
Voice recognition	7-2