

Foreword

This manual was prepared to help you understand the operation and maintenance of your vehicle so that you may enjoy many kilometers (miles) of driving pleasure. Please read through this manual before operating your vehicle.

A separate warranty information booklet explains details about the warranties covering your vehicle.

Your NISSAN certified LEAF dealer knows your vehicle best. When you require any service or have any questions, we will be glad to assist you with the extensive resources available to us.

READ FIRST — THEN DRIVE SAFELY

Before driving your vehicle, read your Owner's Manual carefully. This will ensure familiarity with controls and maintenance requirements, assisting you in the safe operation of your vehicle.



WARNING:

IMPORTANT SAFETY INFORMATION REMINDERS!

Follow these important driving rules to help ensure a safe and comfortable trip for you and your passengers!

- **NEVER** drive under the influence of alcohol or drugs.
- **ALWAYS** observe posted speed limits and never drive too fast for conditions.
- **ALWAYS** give your full attention to driving and avoid using vehicle features or taking other actions that could distract you.
- **ALWAYS** use your seat belts and appropriate child restraint systems. Pre-teen children should be seated in the rear seat.

- **ALWAYS** provide information about the proper use of vehicle safety features to all occupants of the vehicle.
- **ALWAYS** review this Owner's Manual for important safety information.

MODIFICATION OF YOUR VEHICLE

This vehicle should not be modified. Modification could affect its performance, safety or durability, and may even violate governmental regulations. In addition, damage or performance problems resulting from modification may not be covered under NISSAN warranties.

WHEN READING THE MANUAL

This manual includes information for all options available on this model. Therefore, you may find some information that does not apply to your vehicle.

All information, specifications and illustrations in this manual are those in effect at the time of printing. NISSAN reserves the right to change specifications or design at any time without notice.

IMPORTANT INFORMATION ABOUT THIS MANUAL

You will see various symbols in this manual. They are used in the following ways:



WARNING:

This is used to indicate the presence of a hazard that could cause death or serious personal injury. To avoid or reduce the risk, the procedures must be followed precisely.



CAUTION:

This is used to indicate the presence of a hazard that could cause minor or moderate personal injury or damage to your vehicle. To avoid or reduce the risk, the procedures must be followed carefully.

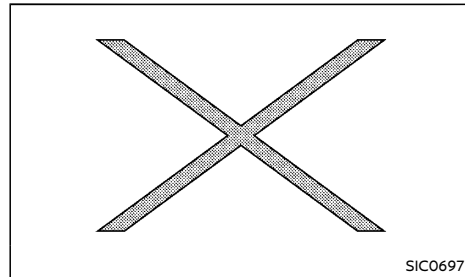

If you see the symbol above, it means **“Do not do this”** or **“Do not let this happen”**.



If you see a symbol similar to those above in an illustration, it means the arrow points to the front of the vehicle.



Arrows in an illustration that are similar to those above indicate movement or action.



Arrows in an illustration that are similar to those above call attention to an item in the illustration.



Bluetooth® is a trademark owned by Bluetooth SIG, Inc. and licensed to Visteon Corporation.

Air bag warning labels



“NEVER use a rearward facing child restraint on a seat protected by an ACTIVE AIRBAG in front of it, DEATH or SERIOUS INJURY to the CHILD can occur.”

Be sure to read “Air bag warning label” (P.1-25).

© 2022 NISSAN MOTOR CO., LTD.

Table of Contents

Illustrated table of contents	0
EV Overview	EV
Charging	CH
Safety—Seats, seat belts and supplemental restraint system	1
Instruments and controls	2
Pre-driving checks and adjustments	3
Display screen, heater and air conditioner, and audio system	4
Starting and driving	5
In case of emergency	6
Appearance and care	7
Maintenance and do-it-yourself	8
Technical information	9
Index	10

0 Illustrated table of contents

Seats, seat belts and Supplemental Restraint System (SRS)	0-2	Cockpit	0-6
Exterior front	0-3	Instrument panel	0-7
Exterior rear	0-4	Meters and gauges	0-8
Passenger compartment	0-5	Motor compartment	0-9
		Warning and indicator lights	0-10

SEATS, SEAT BELTS AND SUPPLEMENTAL RESTRAINT SYSTEM (SRS)

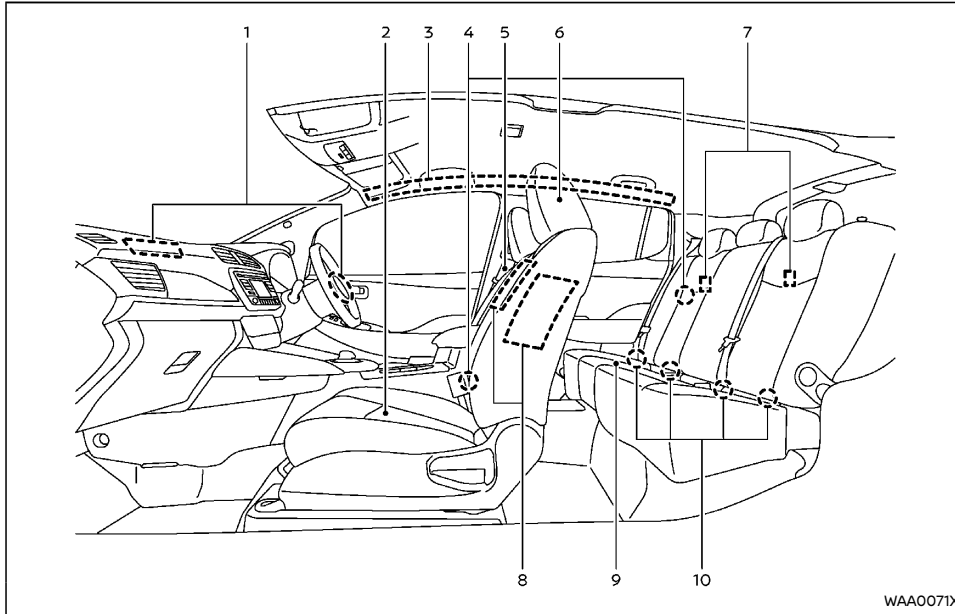

- | | |
|--|--|
| 1. Supplemental front-impact air bags (P.1-22) | 8. Supplemental side-impact air bags* (P.1-22) |
| 2. Front seats (P.1-2) | 9. Rear seats (P.1-4) |
| 3. Supplemental curtain side-impact air bags* (P.1-22) | — Child restraints (P.1-11) |
| 4. Pre-tensioner seat belt system (P.1-30) | 10. ISOFIX child restraint system (P.1-4) |
| 5. Seat belts (P.1-7) | *: if equipped |
| 6. Head restraints (P.1-5) | |
| 7. Child restraint anchor points (for top tether strap child restraint) (P.1-16) | |

EXTERIOR FRONT

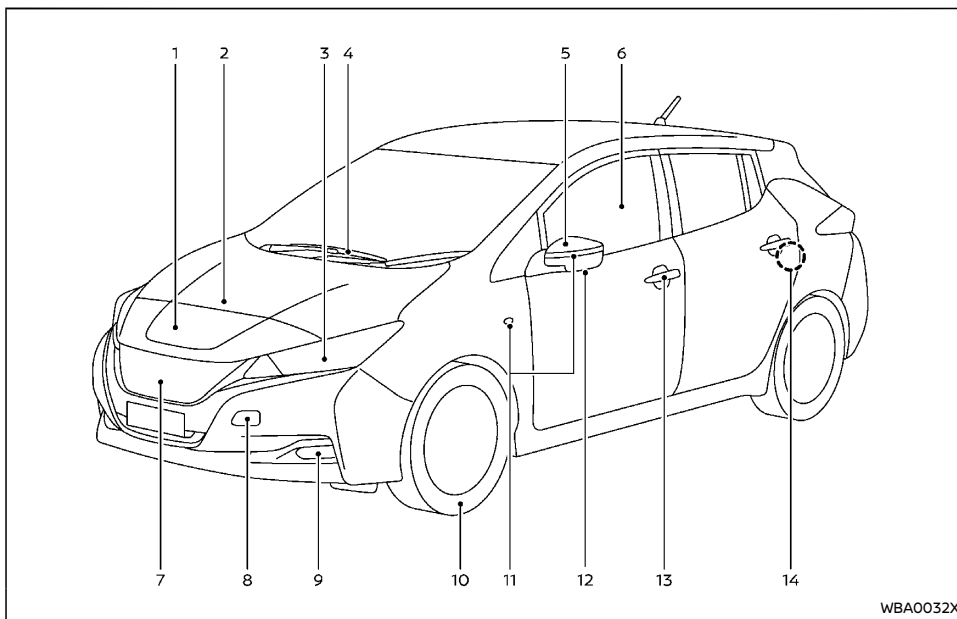

- | | |
|---|--|
| 1. Charge port lid (P.3-13) | 8. Recovery hook (P.6-13) |
| 2. Hood (P.3-10) | 9. Front fog light* (P.2-34) |
| 3. Headlights and turn signal lights (P.2-30) | 10. Tires |
| 4. Windshield wiper and washer | — Wheels and tires (P.8-21, P.9-5) |
| — Switch operation (P.2-34) | — Flat tire (P.6-2) |
| — Window washer fluid (P.8-10) | 11. Side turn signal lights (on the front fender |
| 5. Outside rearview mirrors (P.3-18) | or the outside rearview mirror) (P.2-33) |
| 6. Power windows (P.2-36) | 12. Side view camera* (P.4-3) |
| 7. Front view camera* (P.4-3) | 13. Doors |
| | — Keys (P.3-2) |

- Door locks (P.3-3)
 - Intelligent Key system (P.3-4)
14. Child safety rear door lock (P.3-4)
*: if equipped

EXTERIOR REAR

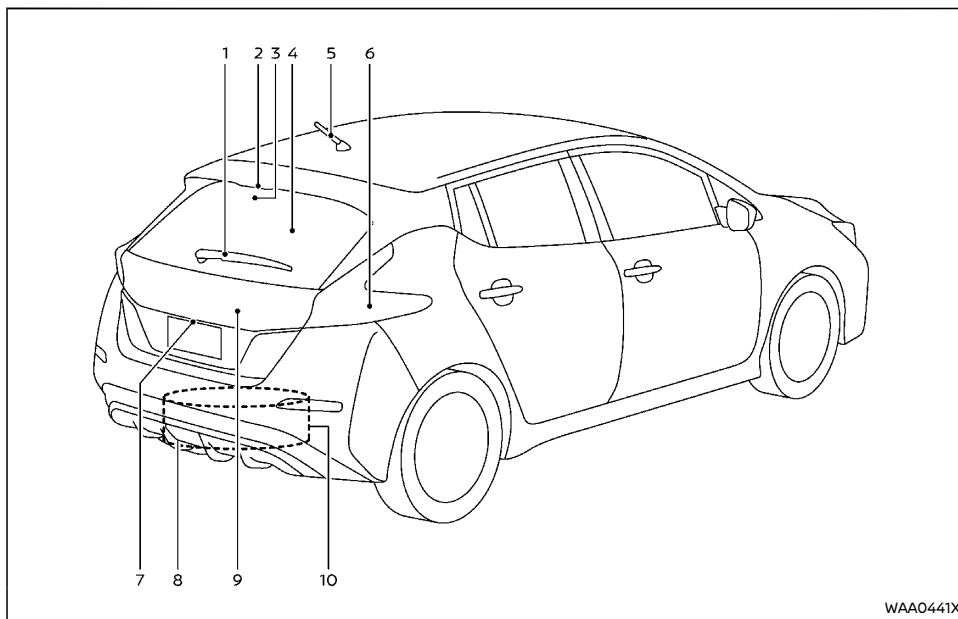

- | | |
|--|--|
| 1. Rear window wiper and washer
– Switch operation (P.2-35)
– Window washer fluid (P.8-10) | 7. Rear view camera* (P.4-3) |
| 2. High-mounted stop light (P.8-15) | 8. Rear fog light* (P.2-34) |
| 3. Intelligent Rear View Mirror camera* (P.3-15) | 9. Rear hatch (P.3-11)
– Intelligent Key system (P.3-4) |
| 4. Rear window defogger (P.2-36) | 10. Spare tire (under the vehicle)* (P.6-2) |
| 5. Antenna (P.4-25) | *: if equipped |
| 6. Rear combination lights (P.8-15) | |

PASSENGER COMPARTMENT

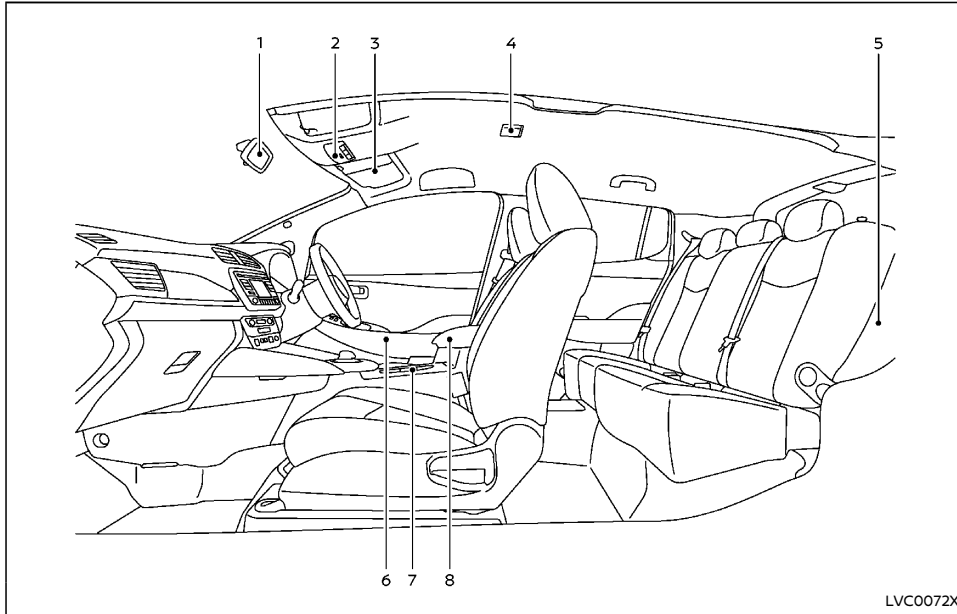

1. Inside rearview mirror (P.3-14)
 - Intelligent Rear View Mirror* (P.3-15)
2. Map lights (P.2-41)
 - Bluetooth® Hands-Free Phone System microphone* (P.4-32 or **)
3. Sun visors (P.2-41)
4. Room light (P.2-42)
5. Cargo area
 - Cargo cover* (P.2-39)
 - NISSAN EVSE (Electric Vehicle Supply
6. Door armrest (driver's side)
 - Power window switch (P.2-36)
 - Power door lock switch (P.3-4)
 - Outside rearview mirror control switch (P.3-18)
7. Front cup holders (P.2-38)
8. Console box (P.2-39)

7. Front cup holders (P.2-38)

8. Console box (P.2-39)

*: if equipped

** : See the separate NissanConnect Owner's Manual (if equipped).

LVC0072X

COCKPIT

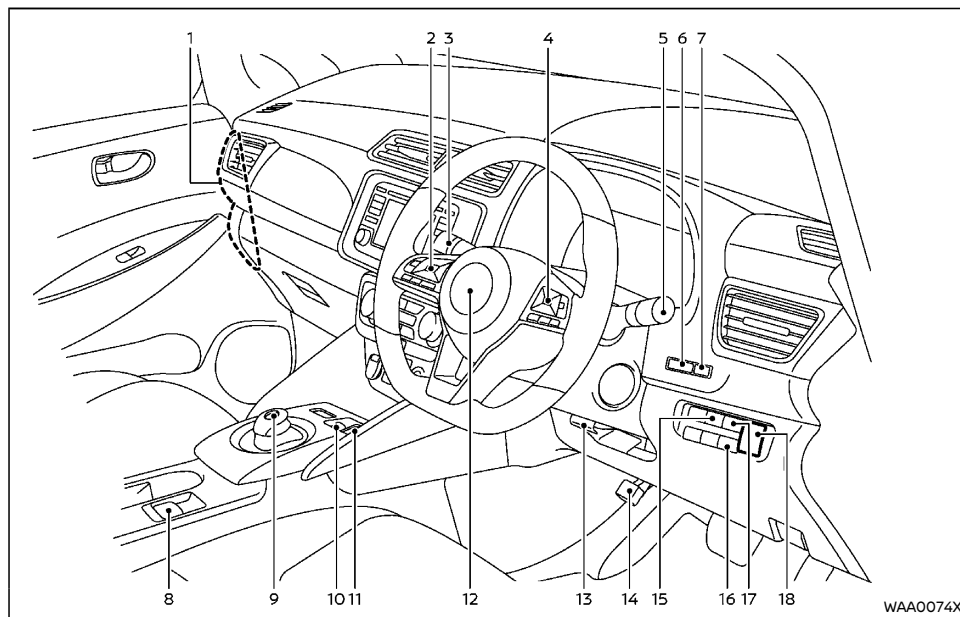

1. Fuse box cover (P.8-13)
2. Steering-wheel-mounted controls (left side)
 - Vehicle information display control (P.2-15)
 - Audio control* (P.4-30 or **)
3. Wiper and washer switch (P.2-34)
4. Steering-wheel-mounted controls (right side)
 - Bluetooth® Hands-Free Phone System control* (P.4-32 or **)
 - Cruise control switches (P.5-14)
 - Voice recognition system switch**
5. Headlight and turn signal switch (P.2-30)/ Fog light switch* (P.2-34)
6. Instrument brightness control switch (P.2-7)
7. TRIP/RESET switch for twin trip odometer (P.2-5)
8. Parking brake (switch type)* (P.3-20)

9. Shift lever/P position switch (P.5-6)
10. e-Pedal switch (P.5-8)
11. ECO mode switch (P.5-31)
12. Steering wheel
 - Electric power steering (P.5-34)
 - Horn (P.2-36)
 - Driver's supplemental front-impact air bag (P.1-22)
13. Tilting steering wheel lock lever (P.3-14)
14. Parking brake (pedal type)* (P.3-19)
15. Immediate charge switch (P.CH-19)
16. Intelligent Lane intervention switch* (P.5-19)
17. Charge port lid opener switch (P.3-13)
18. Headlight aiming control* (P.2-32)

*: if equipped

** : See the separate NissanConnect Owner's Manual (if equipped).

INSTRUMENT PANEL

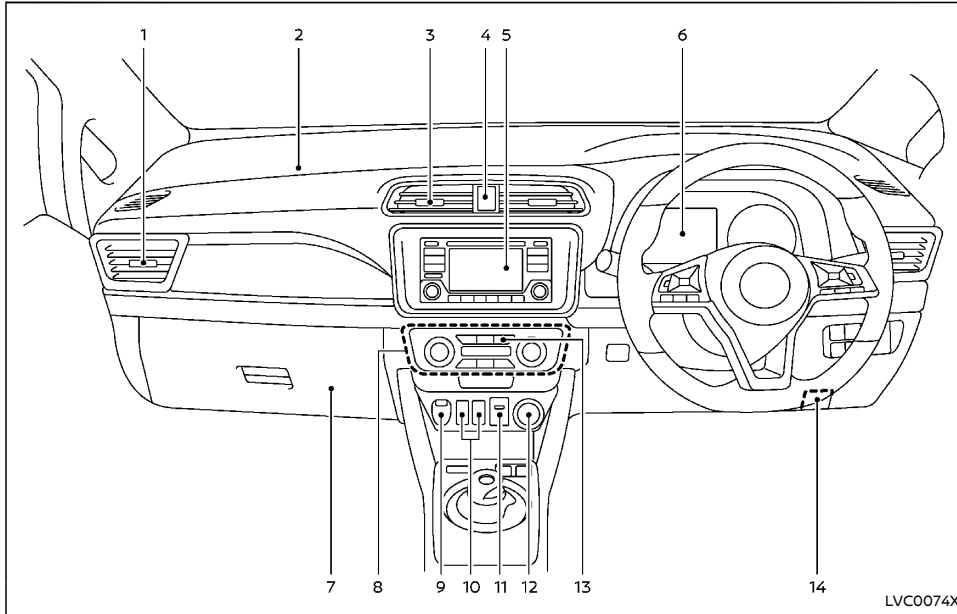

- | | |
|---|--|
| 1. Side ventilator (P.4-13) | 6. Meters and gauges (P.2-4) |
| 2. Front passenger's supplemental front-impact air bag (P.1-22) | 7. Glove box (P.2-38) |
| 3. Center ventilator (P.4-13) | 8. Climate control (heater and air conditioner control) (P.4-13) |
| 4. Hazard warning flasher switch (P.6-2) | 9. Power outlet (P.2-38) |
| 5. Audio system* (P.4-19 or **)
– Intelligent Around View Monitor* (P.4-3)
– Bluetooth® Hands-Free Phone System* (P.4-32 or **) | 10. Front heated seat switches (P.1-3) |
| | 11. USB connection port*/Auxiliary input jack* (P.4-30 or **) |
| | 12. Power switch (P.5-4) |

13. Rear window defogger switch (P.2-36)

14. Hood lock release handle (P.3-10)

*: if equipped

** : See the separate NissanConnect Owner's Manual (if equipped).

METERS AND GAUGES

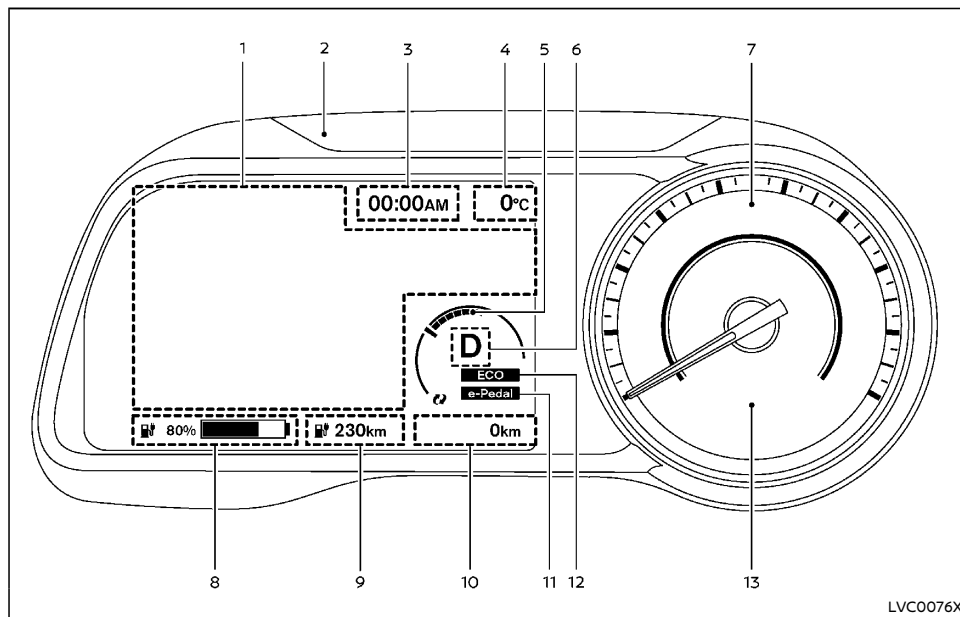

1. Vehicle information display (P.2-15)
 - Trip computer (P.2-26)
 - Timer display (P.2-29)
 - ECO Drive Report (P.2-30)
2. Warning and indicator lights (P.2-8)
 - Master warning light (P.2-12)
3. Clock (P.2-19)
4. Outside air temperature (P.2-7)
5. Power meter (P.2-5)
6. Shift position indicator (P.2-6, P.5-6)
7. Speedometer (P.2-4)
8. Li-ion battery available charge gauge (P.2-6)
9. Driving range (P.2-6)
10. Odometer/twin trip odometer (P.2-5)
11. Rear seat belt warning* (P.2-25)

11. e-Pedal system indicator (P.2-7, P.5-8)
 12. ECO mode indicator (P.2-7, P.5-31)
 13. Warning and indicator lights (P.2-8)
 - READY to drive indicator light (P.2-14)
- *: if equipped



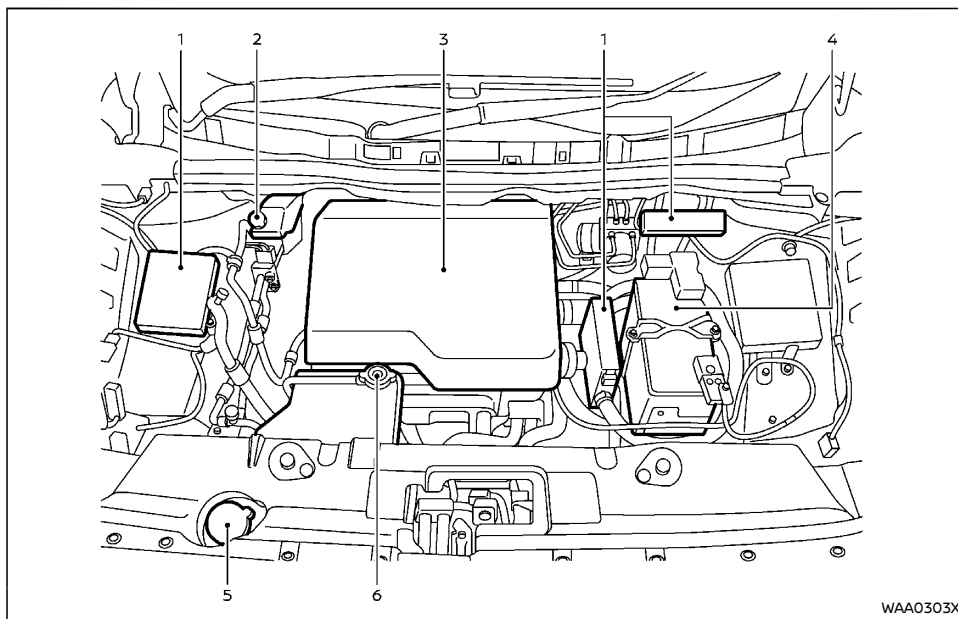









MOTOR COMPARTMENT

















WAA0303X

1. Fuse/fusible link holders (P.8-13)
2. Brake fluid reservoir (P.8-7)
3. Power Delivery Module (PDM) (P.EV-5)
4. 12-volt battery (P.8-11)
— Jump starting (P.6-9)
5. Window washer fluid reservoir (P.8-10)
6. Coolant tank cap (P.8-6)

WARNING AND INDICATOR LIGHTS

Warning light	Name	Page
	12-volt battery charge warning light	P.2-9
	Anti-lock Braking System (ABS) warning light	P.2-9
	Brake system warning light (yellow)	P.2-10
	Brake warning light (red)	P.2-10
	Electric power steering warning light	P.2-11
	Electric shift control system warning light	P.2-11
	Electronic Stability Program (ESP) warning light	P.2-11
	EV system warning light	P.2-11
	Intelligent Emergency Braking system warning light (if equipped)	P.2-11
	Low battery charge warning light	P.2-12
	Master warning light (red/yellow)	P.2-12
	Seat belt warning light	P.2-12
	Supplemental air bag warning light	P.2-12

Indicator light	Name	Page
	Approaching Vehicle Sound for Pedestrians (VSP) warning light	P.2-10
	Electronic parking brake indicator light (if equipped)	P.2-12
	Electronic Stability Program (ESP) OFF indicator light	P.2-12
	Front fog light indicator light (if equipped)	P.2-13
	High beam indicator light	P.2-13
	High beam assist indicator light (if equipped)	P.2-13
	Low beam indicator light	P.2-13
	Plug in indicator light	P.2-13
	Power limitation indicator light	P.2-13
	READY to drive indicator light	P.2-14
	Rear fog light indicator light (if equipped)	P.2-14
	Security indicator light	P.2-14
	Small light indicator light	P.2-14
	Turn signal/hazard indicator lights	P.2-14

Overview

The EV (Electric Vehicle) system	EV-2	Driving the vehicle	EV-10
Li-ion battery	EV-2	At home after driving	EV-12
Driving with a discharged Li-ion battery	EV-3	Efficient use of your vehicle	EV-12
Charging the 12-volt battery	EV-4	Driving range	EV-12
High voltage precautions	EV-5	Improve driving range	EV-12
High-voltage components	EV-5	Li-ion battery life	EV-13
Road accident precautions	EV-6	EV (Electric Vehicle) unique information	EV-14
Emergency shut-off system	EV-6	Meters and indicators	EV-14
EV (Electric Vehicle) characteristics	EV-7	Approaching Vehicle Sound for Pedestrians (VSP) system	EV-15
Noise and vibration	EV-7	Electric shift control system	EV-16
Life with an EV (Electric Vehicle) (scene guide)	EV-8	LED headlight (if equipped)	EV-16
Charging the Li-ion battery	EV-8		
Starting your vehicle	EV-9		

THE EV (Electric Vehicle) SYSTEM

The LEAF is an electric vehicle. Some of the vehicle's systems operate differently and have different operating characteristics than vehicles equipped with an internal combustion engine. It is important to carefully review the entire Owner's Manual for this reason. The main difference is the LEAF is powered by electricity. The LEAF does not require and it is not capable of using gasoline like a vehicle powered by a traditional internal combustion engine. The LEAF uses electricity stored in the lithium ion (Li-ion) battery. The vehicle Li-ion battery must be charged with electricity before the vehicle can be driven. As the vehicle operates, the Li-ion battery gradually discharges. If the Li-ion battery becomes completely discharged, the vehicle will not operate until it is re-charged.

This vehicle uses two types of batteries. One is the 12-volt battery that is the same as the battery in vehicles powered by gasoline engines, the other is the Li-ion battery (high voltage).

The 12-volt battery provides power to the vehicle systems and features such as the audio system (if equipped), supplemental restraint systems, headlights and windshield wipers.

The Li-ion battery provides power to the electric motor (traction motor) that moves the vehicle.

The Li-ion battery also charges the 12-volt battery.

The vehicle must be plugged in for the Li-ion battery to be charged. Additionally, the vehicle system can extend the driving range by converting driving force into electricity that is stored in the Li-ion battery while the vehicle is decelerating or being driven downhill. This is called regenerative brake. This vehicle is considered to be an environmentally friendly vehicle because it does not emit exhaust gases,

such as carbon dioxide and nitrogen oxide.

LI-ION BATTERY



WARNING:

Your vehicle contains a sealed Li-ion high voltage battery. If the Li-ion battery is disposed of improperly, there is a risk of severe burns and electrical shock that may result in serious injury or death and there is also a risk of environmental damage.



CAUTION:

To prevent damage to the Li-ion battery:

- **Do not expose the vehicle to extreme ambient temperatures for extended periods.**
- **Do not store the vehicle in temperatures below -25°C (-13°F) for over seven days.**
- **Do not leave your vehicle for over 14 days where the Li-ion battery available charge gauge reaches a zero or near zero.**
- **Do not use the Li-ion battery for any other purpose.**

NOTE:

- **If the outside temperature is -25°C (-13°F) or less, the Li-ion battery may freeze and it cannot be charged or provide power to drive the vehicle. Move the vehicle to a warm location.**
- **The capacity of the Li-ion battery in your vehicle to hold a charge will, like all such batteries, decrease with time and usage. As the battery ages and capacity decreases, this will result in a decrease from the vehicle's initial driving range. This is normal, expected, and not indicative of any defect in your Li-ion battery.**

- The Li-ion battery has limited service life, and when its charging capacity falls below a specific level, the EV system warning light will illuminate. Owners should bring their vehicle in for inspection and possible battery replacement.
- The Li-ion battery has a limited service life. Contact a NISSAN certified LEAF dealer for information about recycling or disposal of the Li-ion battery. Do not attempt to recycle or dispose of the Li-ion battery yourself.

DRIVING WITH A DISCHARGED LI-ION BATTERY

Warning lights illuminate on the instrument panel and messages are displayed on the vehicle information display to inform you that the Li-ion battery charge is low.

The vehicle's range is very limited when these warning lights illuminate and messages are displayed. Follow the instructions on the vehicle information display and immediately charge the vehicle at the nearest charging station.

There are three levels of information that will be displayed as the Li-ion battery becomes discharged:

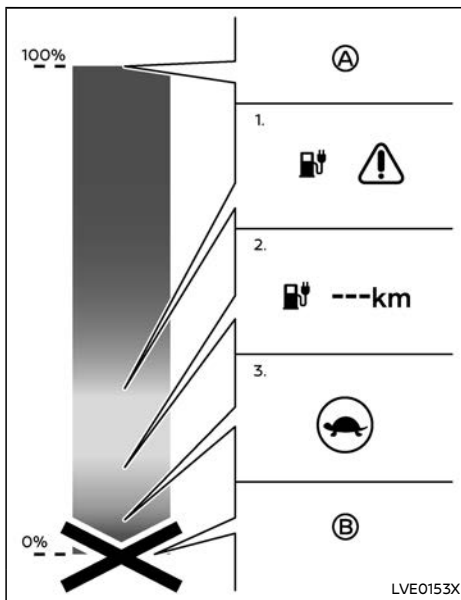

- (A) Full charge
1. Low Li-ion battery
 2. "---" indication
 3. Traction motor output limited
- (B) Battery discharged
1. The following warning lights illuminate on the meter and messages are displayed on the vehicle information display at the same time to indicate low Li-ion battery charge. Charge the Li-ion battery as soon as possible.

- The low battery charge warning light
- The master warning light
- "Battery charge is low. Charge now" warning message is displayed on the vehicle information display. See "Vehicle information display warnings and indicators" (P.2-21).

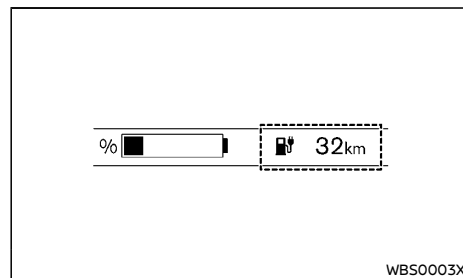

Example

- The driving range on the vehicle information display also flashes when the above warning lights illuminate.

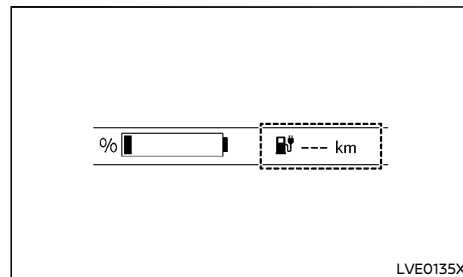

2. If the vehicle is driven and the Li-ion battery continues to discharge, the driving range changes to "---".

3. When the power limitation indicator light  illuminates, traction motor output is limited resulting in reduced vehicle speed. Stop the vehicle in a safe location before the Li-ion battery becomes completely discharged and there is no power available to drive the vehicle. See "If the Li-ion battery becomes completely discharged" (P.6-11).

CHARGING THE 12-VOLT BATTERY

The 12-volt battery is charged automatically using electricity stored in the Li-ion battery.

When the 12-volt battery is being charged, the charging status indicator light on the instrument panel flashes. (except when charging the Li-ion battery or the power switch is in the READY to drive position.) See "Charging status indicator lights" (P.CH-20).

While vehicle is in use

The Li-ion battery charges the 12-volt battery as necessary when the power switch is in the READY to drive position or ON position.

The 12-volt battery is not charged in the following conditions.

- When the power switch is in ACC position.
- When the power switch is in ON position and shift position is in the N (Neutral) position.

While the vehicle is not in use

When the EV (Electric Vehicle) system is off for an extended time, the 12-volt battery may be automatically charged for a short period of time on a regular basis.

HIGH VOLTAGE PRECAUTIONS

HIGH-VOLTAGE COMPONENTS



WARNING:

- The EV (Electric Vehicle) system uses high voltage up to approximately DC 400 volt. The system can be hot during and after starting and when the vehicle is shut off. Be careful of both the high voltage and the high temperature. Follow the warning labels that are attached to the vehicle.
- Never disassemble, remove or replace high-voltage parts and cables as well as their connectors because they can cause severe burns or electric shock that may result in serious injury or death. High-voltage cables are colored orange. The vehicle high voltage system has no user serviceable parts. Take your vehicle to a NISSAN certified LEAF dealer for any necessary maintenance.

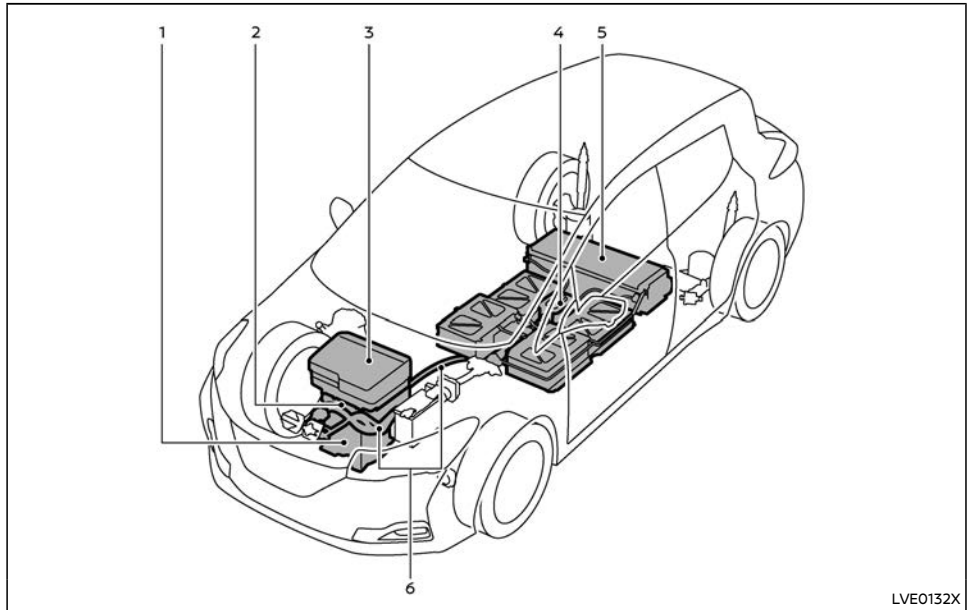

LVE0132X

High-voltage components

1. Traction motor and reduction gear
2. Traction motor inverter
3. Power Delivery Module (PDM)
4. Service plug
5. Li-ion battery
6. High-voltage wire harnesses (colored orange)

ROAD ACCIDENT PRECAUTIONS



WARNING:

In case of a collision:

- If your vehicle is drivable, pull your vehicle off the road, push the P position switch on the shift lever, apply the parking brake and turn the EV (Electric Vehicle) system off.
- Check your vehicle to see if there are exposed high-voltage parts or cables. For their locations, see "High-voltage components" (P.EV-5). To avoid personal injury, never touch high-voltage wiring, connectors, and other high-voltage parts, such as the Power Delivery Module (PDM), inverter unit and Li-ion battery. An electric shock may occur if exposed electric wires are visible when viewed from inside or outside of your vehicle. Therefore, never touch exposed electric wires.
- If the vehicle receives a strong impact to the floor while driving, stop the vehicle in a safe location and check the floor.
- Leaks or damage to the Li-ion battery may result in a fire. If you discover them, contact emergency services immediately. Since the fluid leak may be lithium manganate from the Li-ion battery, never touch the fluid leak inside or outside the vehicle. If the fluid contacts your skin or eyes, wash it off immediately with a large amount of water and receive immediate medical attention to help avoid serious injury.
- If a fire occurs in the EV (Electric Vehicle), leave the vehicle as soon as possible. Only use a type ABC, BC or C fire extinguisher that is meant for use on electrical fires. Using a small amount of water or

the incorrect fire extinguisher can result in serious injury or death from electrical shock.

- If your vehicle needs to be towed, do it with the front wheels raised. If the front wheels are on the ground when towing, the traction motor may generate electricity. This may damage the components of the EV (Electric Vehicle) system and cause a fire.
- If you are not able to safely assess the vehicle due to vehicle damage, do not touch the vehicle. Leave the vehicle and contact emergency services. Advise 1st responders that this is an electric vehicle.

EMERGENCY SHUT-OFF SYSTEM

The emergency shut-off system is activated and the high-voltage system automatically turns off in the following conditions:

- Front and side collisions in which the air bags are deployed.
- Certain rear collisions.
- Certain EV (Electric Vehicle) system malfunctions

For the above collisions and certain other EV (Electric Vehicle) system malfunctions, the READY to drive indicator light will turn off. See "Warning lights, indicator lights and audible reminders" (P.2-8).

The emergency shut-off activates for the above collisions to minimize risk of an event that could cause injury or an accident. If the emergency shut-off system activates, the EV system may not be switched to READY to drive position, contact a NISSAN certified LEAF dealer. Even if the power switch is switched to READY to drive position, the system may shut-off suddenly. Therefore, drive cautiously to the

nearest NISSAN certified LEAF dealer or contact a NISSAN certified LEAF dealer as soon as possible.

EV (Electric Vehicle) CHARACTERISTICS



WARNING:

- Pay special attention to pedestrians. Because there is no engine noise, pedestrians may not know the vehicle is approaching, moving or about to move, and may step into the path of vehicle travel.
- When leaving the vehicle, be sure to turn off the EV (Electric Vehicle) system.
- Be sure to push the P position switch on the shift lever and apply the parking brake when parking because the vehicle can move when the READY to drive indicator light is ON. When the READY to drive indicator light is ON, do not leave your vehicle in a shift position other than the P (Park) position.
- Keep the brake pedal depressed until you are ready to drive. When the vehicle is in the D (Drive), B or R (Reverse) position, if you release the brake pedal and do not depress accelerator, the vehicle will creep and may start abruptly. This may cause serious injury or death.

NOTE:

- The vehicle cannot run with a discharged Li-ion battery. Repeated acceleration consumes more power from the Li-ion battery than driving at a steady speed.
- This vehicle is equipped with a regenerative brake system. The primary purpose of regenerative brake system is to provide some power to recharge the Li-ion battery and extend driving range. A secondary benefit is “engine braking” that operates based on Li-ion battery conditions.

- In the D (Drive) position, when the accelerator pedal is released, the regenerative brake system provides some deceleration.
- When you place the shift lever in the B position and take your foot off the accelerator pedal, more regenerative brake is applied than in the D (Drive) position.
- Less deceleration is provided by the regenerative brake system when the Li-ion battery is fully charged. Regenerative brake is automatically reduced when the Li-ion battery is fully charged to prevent the Li-ion battery from becoming overcharged. Regenerating brake is also automatically reduced when the battery temperature is high/low (indicated by the red/blue zones on the Li-ion battery temperature gauge) to prevent Li-ion battery damage.
- The brake pedal should be used to slow or stop the vehicle depending on traffic or road conditions. The vehicle brakes are not affected by regenerative brake system operation.

- Approaching Vehicle Sound for Pedestrians (VSP)

NOISE AND VIBRATION

You might experience the following noise or vibration as a normal characteristic of this vehicle.

- Traction motor noise from motor compartment
- Water pump and radiator fan noise while charging
- Compressor and radiator fan noise when the Climate Ctrl. Timer is used
- Relay operation noise and vibration at start-up and shut-down of the EV (Electric Vehicle) system (power switch placed in the ON and OFF position)

LIFE WITH AN EV (Electric Vehicle) (scene guide)



WARNING:

The EV (Electric Vehicle) system uses a high voltage current. Failure to follow the proper handling instructions may cause serious injury or death.

This section provides a brief explanation of the most important LEAF functions. Refer to the specific sections of this manual for detailed explanations of the vehicle features and operation.

CHARGING THE LI-ION BATTERY



WARNING:

Be sure to read the "CH. Charging" section and follow the procedures and guidelines described.

There are the following methods of charging the Li-ion battery:

- Quick charge
- Normal charge
- V2X charge/discharge*

*: A compatible V2X device is necessary.

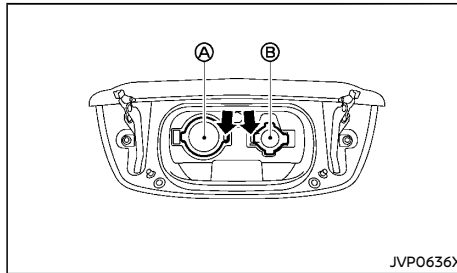

Type 1

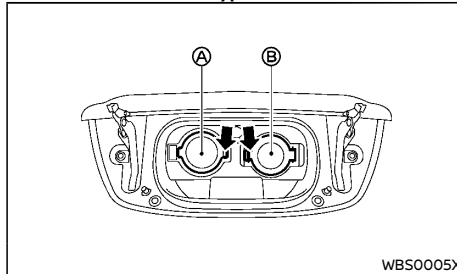

Type 2

- (A) : Quick charge port
For quick charge and V2X charge/discharge connect, use the left-hand side charge port with the black cap.
- (B) : Normal charge port
For normal charge connect, use the right-hand side charge port with the orange cap.

For instructions, see "How to charge the Li-ion battery" (P.CH-5).

STARTING YOUR VEHICLE

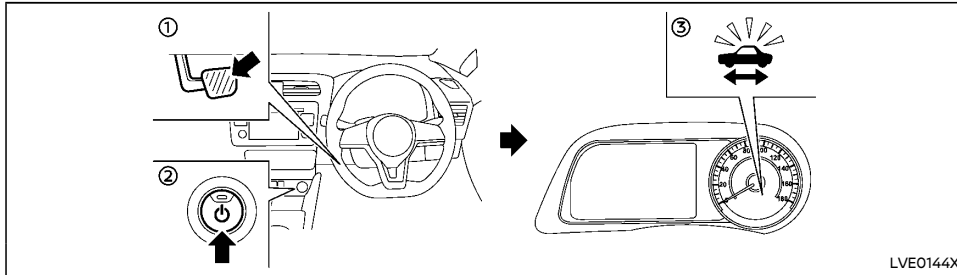

1. Firmly depress the brake pedal.
2. Push the power switch.
3. Check that the READY to drive indicator light illuminates. See "READY to drive indicator light" (P.2-14).
4. Check the Li-ion battery level and the estimated driving range shown on the vehicle information display. See "Li-ion battery available charge gauge" (P.2-6) and "Driving range" (P.2-6).

NOTE:

Before driving, compare the driving distance to the destination with the estimated driving range shown on the vehicle information display.

DRIVING THE VEHICLE

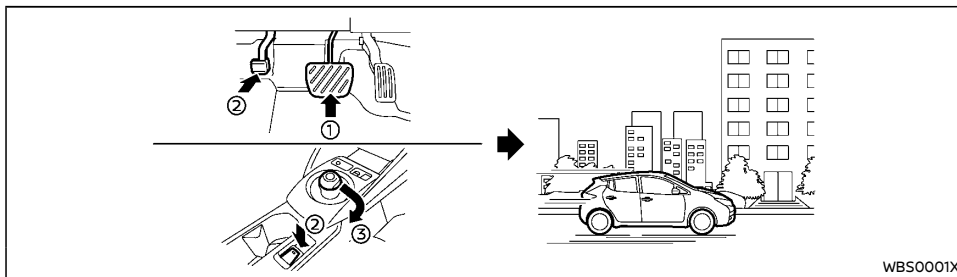

1. Depress the brake pedal.
2. Release the parking brake.
3. Move the shift lever into the D (Drive) position. When released, the shift lever returns to its original center position.
4. Confirm that the vehicle is in the D (Drive) position. The indicator next to the "D" by the shift lever illuminates and "D" is displayed on the vehicle information display.
5. Release the brake pedal.
6. Depress the accelerator pedal and start driving.

There are the following gear positions for driving the vehicle forward:

- Use the D (Drive) position for optimum driving performance.
- Use the B position for downhill driving. When the B position is used, more regenerative brake is applied when the accelerator pedal is released in comparison to the D (Drive) position.

NOTE:

The regenerative brake converts the vehicle's forward motion to electric power to help slow the vehicle.

See "Driving vehicle" (P.5-6).

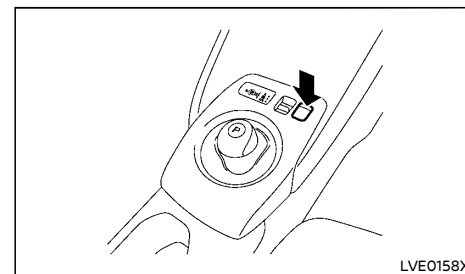
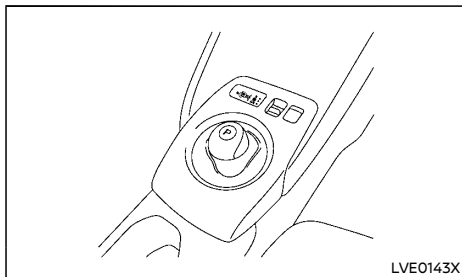

Push the ECO switch located on the center console to turn on the ECO mode. Use the ECO mode for maximum driving range and for city driving. The ECO mode helps reduce power consumption by reducing acceleration when compared to the same accelerator pedal position in the D (Drive) position (normal mode). See "ECO mode" (P.5-31).

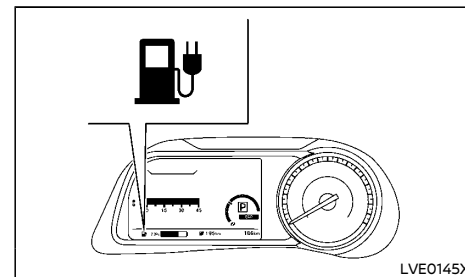

If the low battery charge warning light  illuminates, the Li-ion battery charge is too low for travel. See "Low battery charge warning light" (P.2-12). Charge the Li-ion battery as soon as possible.

Parking the vehicle

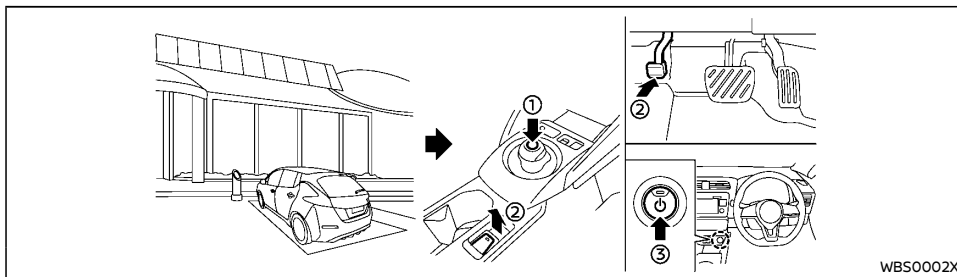

1. When stopping the vehicle, push the P position switch on the shift lever while depressing the brake pedal. Confirm that the vehicle is in the P (Park) position by checking the shift indicator located near the shift lever or on the vehicle information display.
2. Apply the parking brake.
3. Push the power switch to the OFF position.
4. If a parking lot is equipped with charging facilities, charge the Li-ion battery as necessary. See "How to charge the Li-ion battery" (P.CH-5).

EFFICIENT USE OF YOUR VEHICLE

AT HOME AFTER DRIVING

Charging the Li-ion battery

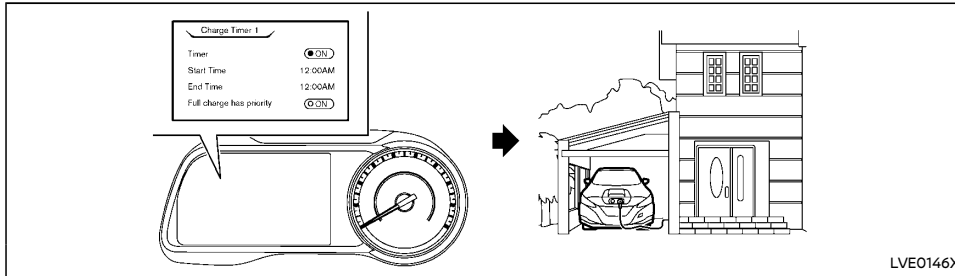

When you return home, connect the vehicle to the charging station installed at your home using the normal charge connector.

Charge the vehicle or set the charging timer function on the vehicle information display to have the vehicle charge at a specific time. See "Charging timer" (P.CH-18).

1. When the power switch is turned off, the settings of the charging timer, the Climate Ctrl. Timer and the charge connector lock (if equipped) functions are displayed on the vehicle information display. See "Vehicle information display" (P.2-15).
2. Open the charge port lid and charge port cap. See "Charge port lid" (P.3-13).
3. Connect the charge connector to the vehicle.
4. When a charging timer is turned on, charging starts at the set time. When a charging timer is not turned on, charging starts immediately.

NOTE:

NISSAN recommends that you connect your EVSE (if equipped) to your vehicle when getting out of the vehicle, even if it is not going to be used. By doing this, you can get the most out of the Climate Ctrl. Timer functions the next time you use the vehicle.

DRIVING RANGE

The distance you can drive the vehicle (driving range) varies considerably depending upon available charge, weather, temperature, usage, battery age, topography, and driving style.

IMPROVE DRIVING RANGE

The available driving range depends on a number of factors.

Actual driving range will vary depending upon:

- Speed
- Vehicle load
- Electrical load from vehicle accessories
- Traffic and road conditions

NISSAN recommends the following driving habits to help maximize driving range:

Before driving:

- Follow recommended scheduled maintenance.
- Keep tires inflated to the correct pressure.
- Keep wheels correctly aligned.
- Pre-heat or pre-cool the interior cabin while the vehicle is charging.
- Remove unnecessary cargo from the vehicle.

While driving:

- Drive in ECO mode
 - The ECO mode helps reduce power consumption by reducing acceleration when compared to the same accelerator pedal position in the D (Drive) position (normal mode).
- Drive at a constant speed. Maintain cruising speeds with a constant accelerator pedal position or by using the cruise control system when appropriate.

- Accelerate slowly and smoothly. Gently depress and release the accelerator pedal for acceleration and deceleration.
- Drive at moderate speeds on the highway.
- Avoid frequent stopping and braking. Maintain a safe distance behind other vehicles.
- Turn off the climate control system when it is not needed.
- Select a moderate temperature setting for heating or cooling to help reduce power consumption.
- Use only the fan to help reduce power consumption.
- In cold weather, use the heated seats as a substitute for climate control system to help reduce power consumption.
- Use the climate control system to control interior temperature and close windows to reduce drag when cruising at highway speed.
- Release the accelerator pedal to slow down and do not apply the brakes when traffic and road conditions allow.
 - This vehicle is equipped with a regenerative brake system. The primary purpose of the regenerative brake system is to provide some power to recharge the Li-ion battery and extend driving range. A secondary benefit is the “engine braking” effect that operates based on Li-ion battery conditions. In the D (Drive) or B position, when the accelerator is released, the regenerative brake system provides some deceleration and some power to the Li-ion battery.
- The vehicle driving range may be substantially reduced in extremely cold conditions (for example -20°C (-4°F)).

- Using the climate control system to heat the cabin when the outside temperature is below 0°C (32°F) uses more electricity and affects the vehicle driving range more than when using the heater when the temperature is above 0°C (32°F).

LI-ION BATTERY LIFE

The Li-ion battery's ability to hold a charge, like all batteries, decreases with battery age and usage which results in decreased driving range when compared to the driving range when the vehicle was new. This is normal and expected, and does not indicate a malfunction of the vehicle or Li-ion battery.

The Li-ion battery's ability to hold a charge can be affected by how you drive the vehicle, store the vehicle, how you charge the Li-ion battery and Li-ion battery temperature during vehicle operation and charging.

To maximize the battery's useful life, use the following driving and charging habits where possible.

- Avoid exposing a vehicle to extreme ambient temperatures for extended periods.
- Avoid storing a vehicle in temperatures below -25°C (-13°F) for over 7 days.
- Avoid leaving your vehicle for over 14 days where the Li-ion battery available charge gauge reaches a zero or near zero (state of charge).
- Allow the vehicle and Li-ion battery to cool down after use before charging.
- Park/store your vehicle in cool locations out of direct sunlight and away from heat sources.
- Avoid sustained high battery temperatures (caused, for example, by exposure to very high ambient temperatures or extending highway driving with multiple quick

charges).

- Use the normal charging method to charge the Li-ion battery and minimize the use of Quick Charger.
- Drive moderately.
- Use the ECO mode.
- Do not operate the charging timer repeatedly while the charge connector is connected to the vehicle after the Li-ion battery charging is completed. Doing so may discharge the 12-volt battery.
- If the vehicle will not be used for an extended period of time, charge the Li-ion battery once every 3 months.
- The power of the Li-ion battery can be checked on the Li-ion battery available charge gauge. See “Li-ion battery available charge gauge” (P.2-6).

EV (Electric Vehicle) UNIQUE INFORMATION

METERS AND INDICATORS

Various meters, gauges and indicators related to the EV (Electric Vehicle) functions are displayed in the vehicle information display.

Vehicle information display

Master warning light:

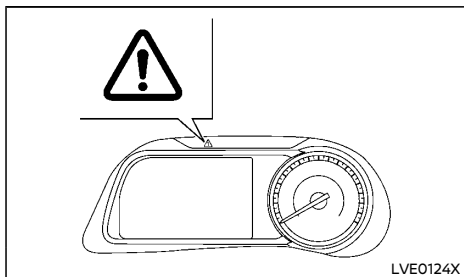

The master warning light (red/yellow) illuminates when messages are displayed on the vehicle information display.

For additional information, see "Master warning light (red/yellow)" (P.2-12).

Power meter:

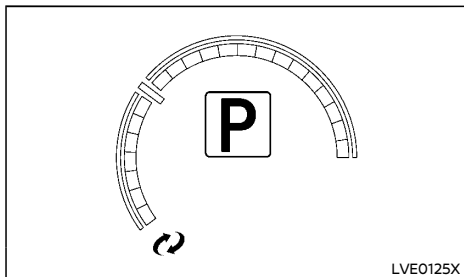

This meter displays the actual traction motor power consumption and the regenerative brake power provided to the Li-ion battery.

For additional information, see "Power meter" (P.2-5).

Driving range:

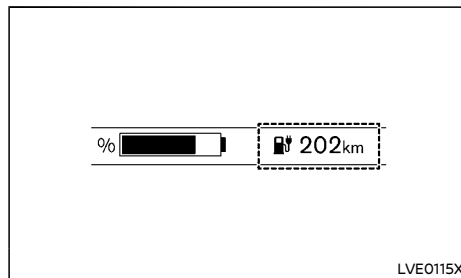

This indicator displays the estimated driving range (calculated based on a program that accounts for current driving style and operational conditions) that can be driven before recharging is necessary.

For additional information, see "Driving range" (P.2-6).

Li-ion battery temperature gauge:

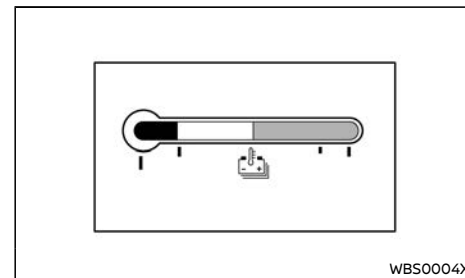

This gauge displays the temperature of the Li-ion battery.

To check this gauge, select it in the trip computer menu. For additional information, see "3. Li-ion battery temperature gauge" (P.2-28).

Li-ion battery available charge gauge:

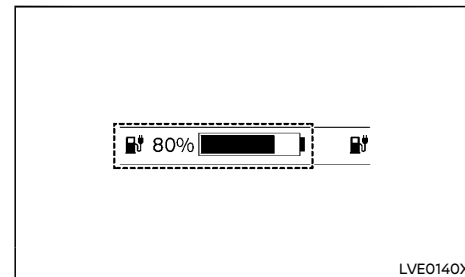

This indicator displays the available Li-ion battery power remaining to drive the vehicle.

For additional information, see "Li-ion battery available charge gauge" (P.2-6).

Li-ion battery capacity level gauge:

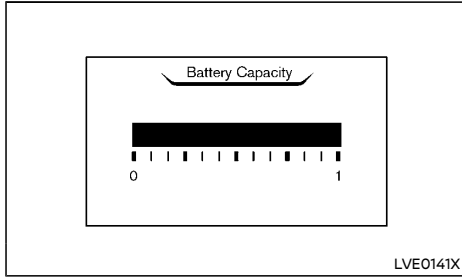

This gauge displays the available capacity of the Li-ion battery remaining to store power.

To check this gauge, select it in the trip computer menu. For additional information, see "4. Li-ion battery capacity level gauge" (P.2-28).

Other information:

The other EV unique information is displayed on the trip computer as well. For additional information, see "Trip computer" (P.2-26).

Warning and indicator lights

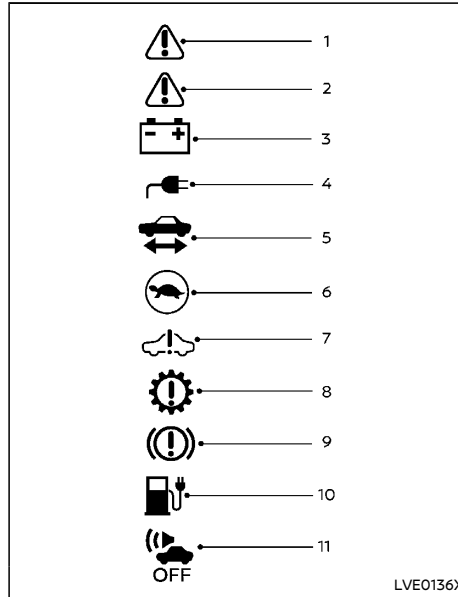

The EV system uses the following EV specific warning and indicator lights, located in the meter panel.

1. Master warning light (red)
2. Master warning light (yellow)
3. 12-volt battery charge warning light
4. Plug in indicator light
5. READY to drive indicator light

6. Power limitation indicator light
7. EV system warning light
8. Electric shift control system warning light
9. Brake system warning light (yellow)
10. Low battery charge warning light
11. Approaching Vehicle Sound for Pedestrians (VSP) warning light

For additional information, see "Warning lights, indicator lights and audible reminders" (P.2-8).

APPROACHING VEHICLE SOUND FOR PEDESTRIANS (VSP) SYSTEM

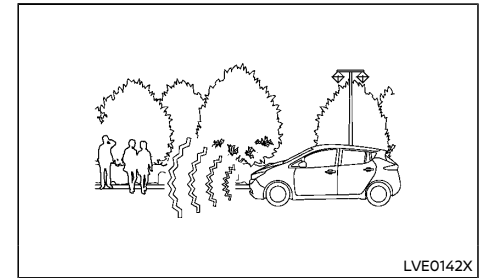

The Approaching Vehicle Sound for Pedestrians (VSP) system is a function that uses sound to alert pedestrians of the presence of the vehicle when it is being driven at a low speed.

When the vehicle starts to move, it produces a sound.

The sound stops when the vehicle speed is more than approximately 30 km/h (19 MPH) while accelerating.

The sound starts when the vehicle speed is less than approximately 25 km/h (16 MPH) while decelerating.

The sound stops when the vehicle stops.

The sound does not stop with the vehicle in the R (Reverse) position even if the vehicle stops.



WARNING:

- If the sound from the VSP system is not heard while driving, stop the vehicle in a safe and quiet location. Open a window and then place the vehicle in the R (Reverse) position with the brake pedal firmly depressed. Check that the operating sound can be heard from the front of the vehicle.
- If the sound cannot be heard, immediately contact a NISSAN certified LEAF dealer for inspection.

NOTE:

If you wish to increase the volume of the VSP system, contact a NISSAN certified LEAF dealer. (It is not possible to lower the volume.)

ELECTRIC SHIFT CONTROL SYSTEM

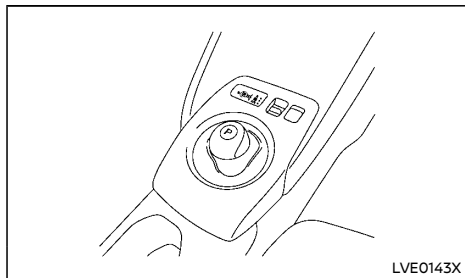

This vehicle is equipped with an electric shift control system. This control system has three features.

- Smooth and easy shift lever operation.
- To place the vehicle in the P (Park) position, push the P position switch on the shift lever.
- The vehicle automatically applies the P (Park) position when the power switch is placed in the OFF position.

For additional information, see "Driving vehicle" (P.5-6).

LED HEADLIGHT (if equipped)

This vehicle uses an LED headlight for the headlight. The LED headlight has the following features.





- Low power consumption
- The shape is very compact.

Contact a NISSAN certified LEAF dealer to replace the headlight.

CH Charging

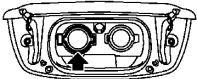
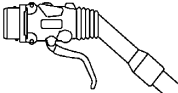
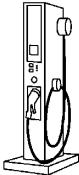
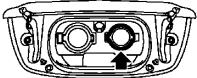
Types of charging	CH-2	Charging methods	CH-18
Precautions on charging	CH-3	Charging timer	CH-18
How to charge the Li-ion battery	CH-5	Charging related indicator lights	CH-20
Quick charge	CH-5	Charging status indicator lights	CH-20
Normal charge	CH-7	NISSAN EVSE (Electric Vehicle Supply Equipment)	
Charge connector lock	CH-14	control box indicator light (if equipped)	CH-22
V2X charge/discharge	CH-16	Charging troubleshooting guide	CH-24

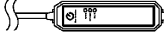
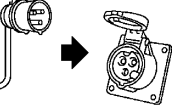
TYPES OF CHARGING

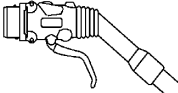
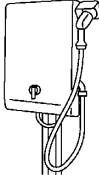
Type of charging	Charge port	Charge connector	Control box	Power	Instructions
Quick charge		 Quick charge connector			Use a public charging station conforming to CHAdeMO standard.
Normal charge*1*2		 Normal charge connector (Type 1)  Normal charge connector (Type 2)	 (for EVSE only)	 Domestic plug Electrical outlet	Use the NISSAN EVSE (Electric Vehicle Supply Equipment) (if equipped). Use only dedicated outlets installed by an Electro-Mobility Operator (EMO).
V2X charge/ discharge*3		 Quick charge connector			Use the V2X device that is installed in your home, office, etc.

WBT0001X

PRECAUTIONS ON CHARGING

- *1. The shape of the charge connector (and port) varies depending on the country (Type 1 or Type 2).
- *2. Normal charge using the NISSAN EVSE (if equipped) is shown as an example.
For normal charge without using the NISSAN EVSE, refer to "Normal charge" (P. CH-7).
- *3. V2X (Vehicle to Everything); The EV supplies electric power to a home or a building, etc.
e.g. Vehicle to Home (V2H), Vehicle to Building (V2B), Vehicle to Grid (V2G), Vehicle to Load (V2L), Vehicle to Vehicle (V2V)



WARNING:

- If you use any medical electric devices, such as an implantable cardiac pacemaker or an implantable cardiovascular defibrillator, check with the electric medical device manufacturer concerning the effects that charging may have on implanted devices before starting the charge operation. Charging may affect the operation.
- Make sure there is no water or foreign material in the charge port, charge connector or electrical plug, and that they are not damaged or affected by rust or corrosion. If any of these conditions are noticeable, do not charge the Li-ion battery. This may result in a short circuit or electric shock and could cause a fire which may result in serious personal injury or death.
- To avoid serious personal injury or death when the Li-ion battery is charging, be aware of the following precautions:
 - Do not touch the metal contacts of the charge port, charge connector or electrical plug.
 - Do not touch the vehicle and the EVSE (Electric Vehicle Supply Equipment) (if equipped) when there is lightning. This may cause an electrical shock.
- Do not disassemble or modify the charge port or the EVSE. This may cause a fire.
- If you notice an unusual odor or smoke coming from the vehicle, stop charging immediately.
- Be careful not to allow your hands, hair, jewelry or clothing to come into contact with, or get caught in, the traction motor

cooling fan. The cooling fan can start at any time during charging.

- For model with EVSE, after using your EVSE and if you place it in the vehicle, secure it firmly with the storage net in the luggage compartment. See "EVSE (Electric Vehicle Supply Equipment) storage net" (P.2-41). Otherwise, it may become a projectile and cause a personal injury during sudden braking or in a collision.



CAUTION:

- To prevent damage to the charging equipment:
 - Do not close the charge port lid without closing the charge port cap.
 - Do not subject the charging equipment to impact.
 - Do not pull or twist the charge cable.
- Make sure to close the charge port lid with the charge port cap closed when charging is finished. If the charge port lid is closed when the charge port cap is open, water or foreign materials may enter the charge port.
- Do not charge when a vehicle body cover is in use. This may cause damage to the charge connector.
- Do not attempt to perform a jump start on the 12-volt battery at the same time when the Li-ion battery is being charged. Doing so may damage the vehicle or charging equipment and could cause an injury. See "Jump starting" (P.6-9).
- Do not insert any object other than the charge connector into the charge port. Doing so may cause damage to the charge port.

- Perform occasional charge using the EVSE.
 - NISSAN recommends using a dedicated electrical circuit and outlet. The dedicated circuit is used to help prevent circuit damage or the circuit breaker from tripping due to the high draw of charging the Li-ion battery. If the circuit is shared, and another electrical device is being used at the same time the vehicle is charging, the breaker may trip.
 - Before you connect the EVSE, be sure to check the rated current shown on the EVSE to ensure that the outlet and circuit have enough current capacity to charge your vehicle safely. The EVSE draws a constant 10–16A*, you must ensure that the outlet and household wiring used for charging are rated at this level and comply with the latest electrical wiring standards and regulations in your country or area.
- *: Max current rating depends on the country.
- The outlet and circuit should be earthed and protected by a dedicated circuit breaker or fuse to protect against electrical hazard. The circuit may cause adverse interference on MCB (Molded Circuit Board) and household electrical appliances such as televisions and audio systems. A licensed professional electrician should install a dedicated circuit if one is not already available.

NOTE:

- When charging the Li-ion battery, place the power switch in the OFF position. When the power switch is in the ON position, the Li-ion battery will not start

charging.

- For your safety, if the charge connector is connected to the vehicle while the power switch is in the READY to drive position, the vehicle will automatically switch to the ON position. Because charging will not be started while the power switch is in this position, be sure to place the power switch in the OFF position.
- It may take more time to charge the Li-ion battery using the quick charger if the vehicle is parked in a cold location for a long time. It may take more time to charge the Li-ion battery using the quick charger if the temperature of the Li-ion battery is high or low. For further information, see “3. Li-ion battery temperature gauge” (P.2-28).
- If the vehicle will not be used for an extended period of time, charge the Li-ion battery once every 3 months.
- The power switch can be placed in the ON position and the climate control can be used while the Li-ion battery is charging. However, because these operations consume Li-ion battery power, it will take longer for the Li-ion battery to become fully charged. Place the power switch in the OFF position to help reduce Li-ion battery charge time.
- If electrical power is interrupted while charging, charging restarts automatically when the electrical power is restored.
- If the charge port is frozen, melt the ice. After the ice has melted, charge the Li-ion battery. Forcing the charge connector to connect may cause a malfunction.
- If foreign materials have entered the charge connector or charge port and it is not possible to connect it, do not

attempt to force the connection. Contact a NISSAN certified LEAF dealer. Forcing the charge connector to connect may cause damage to the charging equipment and vehicle.

- There is a hole on the charge port for water drainage. If the water drainage hole becomes blocked, or if water gets trapped inside the charge port, do not charge. Contact a NISSAN certified LEAF dealer.

HOW TO CHARGE THE LI-ION BATTERY

This vehicle is an electric vehicle and it requires electricity to operate. The Li-ion battery is the only source of power to operate the vehicle.

It is important to conserve power and plan your charging needs when you drive to avoid completely discharging the Li-ion battery.

There are the following methods of charging the Li-ion battery:

- Quick charge
- Normal charge
- V2X charge/discharge*

*: A compatible V2X device is necessary.

QUICK CHARGE

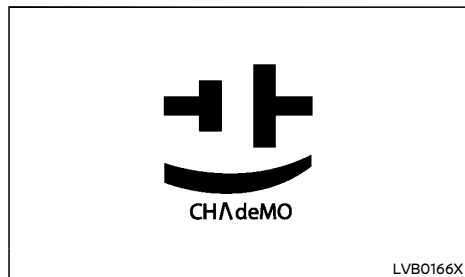

Quick charge uses public charging stations (up to 50kW of power). This vehicle compatible quick chargers are developed to the CHAdeMO standard as identified by the symbol shown.

It may take more time to charge the Li-ion battery using the quick charger if the temperature of the Li-ion battery is high or low.

The Li-ion battery temperature gauge can be used to estimate the approximate time needed to charge the Li-ion battery from discharged (low battery charge warning light illuminated) to 80% charged.

Li-ion battery temperature gauge	Estimated charging time
	more than 80 minutes
	approximately 40-80 minutes
	approximately 40 minutes
	approximately 40-80 minutes
	more than 80 minutes

WBT0162X

If charging stops mid-charge, you can restart charging by pushing the start button on the quick charger station again. Quick charging is possible (even several times a day). If the battery temperature is near the red zone, in order to protect the battery, power of the quick charging will be limited.

For further information, see "3. Li-ion battery temperature gauge" (P.2-28).



WARNING:

- Always use a quick charger with CHAdeMO mark that is compatible with the LEAF. Using an incompatible quick charger may cause a fire or malfunction resulting in serious personal injury or death.
- Before starting the quick charge, carefully read the instructions provided on the quick charger and make sure the quick charge connector is properly connected and locked to the vehicle. Failure to connect or operate the quick charger correctly could cause damage to the vehicle or the charging equipment.

NOTE:

- When the Li-ion battery available charge and Li-ion battery capacity are shown on the quick charger unit, the readings may differ from the actual Li-ion battery available charge/capacity.
- Depending on the quick chargers, the operation procedure may differ from the one shown in this manual. Follow the instructions provided on the quick charger.

How to start quick charge

1. Push the P position switch to place the vehicle in the P (Park) position, and apply the parking brake.
2. Place the power switch in the OFF position. When the power switch is in the ON position, the Li-ion battery will not start charging.
3. Open the charge port lid and the quick charge port cap. (See "Charge port lid" (P.3-13).)

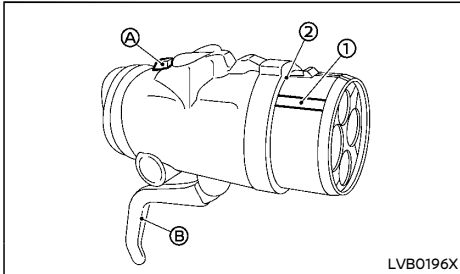
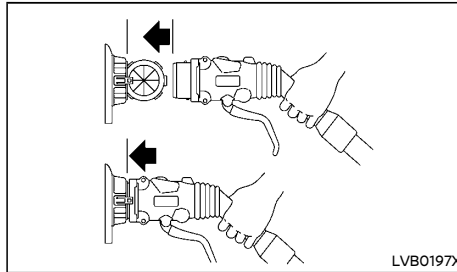
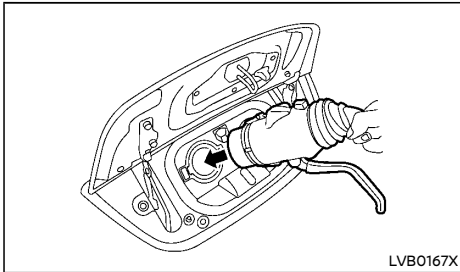

CAUTION:

Be sure to insert the charge connector straight into the quick charge port right up to the base. Failure to do so may result in the Li-ion battery not charging or could cause damage to the charging equipment.

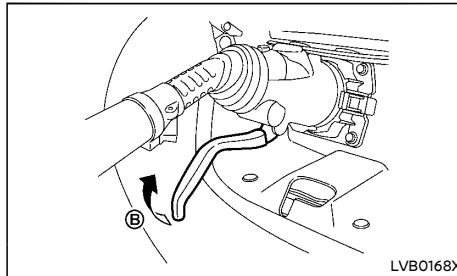

- Align the groove on the charge connector ① with the quick charge port and insert the charge connector right up to the base ②. (A Release button, B Lock lever; There is no need to use them at this stage.)

- Pull the lock lever B up to lock the charge connector.
- Confirm the lock lever is fixed in the lever holder.
- Follow the instructions on the quick charge equipment to start charging. When the

equipment is properly installed and ready to charge, a beep sounds twice and the charging status indicator light will change. See "Charging status indicator lights" (P.CH-20).

Charging ends in the following situations:

- When charging is complete.
- When the possible charge time set for the quick charger is exceeded.

NOTE:

- Charging may automatically stop even if it is not completed.
- If charging stops mid-charge, you can restart charging by pushing the start button on the quick charger station again.
- The charge connector is locked to the charge port during charging and cannot be disconnected. Follow the instructions on the quick charge equipment to stop charging. Confirm charging is stopped by looking at the charging status indicator lights on the instrument panel. The charge connector can be disconnected from the vehicle when charging has stopped.
- When quick charging, the Li-ion battery charging rate is slower as the percentage of available battery charge increases.
- When quick charging, the Li-ion battery charging rate is slower when the Li-ion battery temperature is extremely high or low.

How to stop quick charge

1. Confirm charging is stopped by looking at the charging status indicator lights on the instrument panel. The charge connector can be disconnected from the vehicle when charging is stopped.

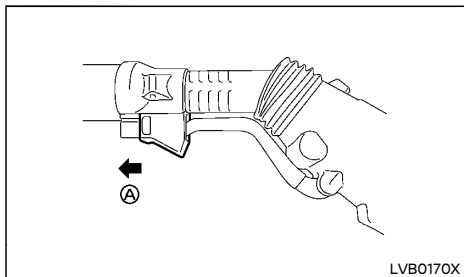

2. Slide back the lever holder **A**.

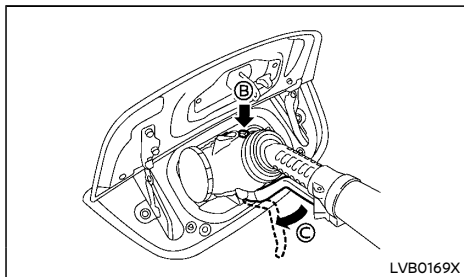

3. Push the release button **B** on the charge connector to release the lock lever **C**.
4. Remove the charge connector from the vehicle and store it away properly.

5. Close the quick charge port cap.

6. Close the charge port lid.



CAUTION:

As the quick charge connector is heavier in comparison to the other charge connectors, allowing it to drop could cause damage to the vehicle or charge connector or personal injury. When removing the connector, be sure to pull it out straight and as carefully as possible.

NORMAL CHARGE

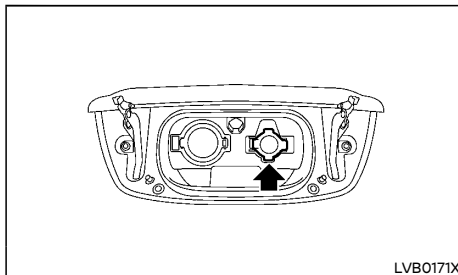

Normal charge port (Type 1)

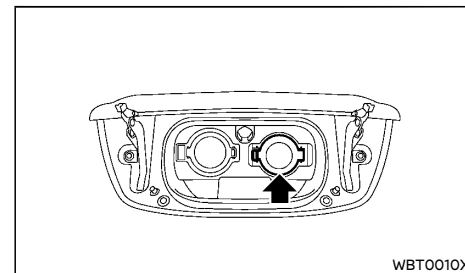

Normal charge port (Type 2)

Normal charge can be performed either at home or at a public charging facility. There are two methods for performing normal charge. You can either connect the vehicle and the power supply to the EVSE (Electric Vehicle Supply Equipment) (if equipped), or connect the vehicle to a normal charger. NISSAN recommends using normal charge for usual charging of the vehicle. Use of quick charge should be minimized in order to prolong Li-ion battery life.



WARNING:

- In order to avoid an electric shock or fire due to a short circuit, connect to GFI (Ground Fault Interrupter) circuit breaker and use a waterproof electrical ground socket.
- Do not use an extension cable or electrical plug adapter. If the electrical socket generates an abnormal amount of heat, this may cause a fire.











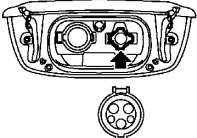
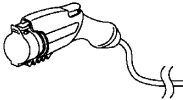
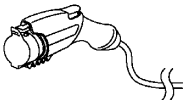

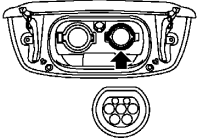
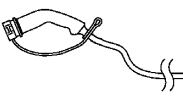
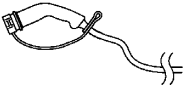

CAUTION:

Only charge using a dedicated electrical outlet (for example do not use an electric generator). Failure to do so may cause charging to fail and could cause damage to the Li-ion battery charging equipment due to power surges.

NOTE:

- Your NISSAN certified LEAF dealer can advise regarding availability of charge cables in your country.
- NISSAN highly recommends EVSE installed on a dedicated circuit in your home by a licensed professional electrician, certified by a NISSAN recommended Electro-Mobility Operator (EMO).
- Normal charging is performed using a dedicated electrical outlet using the EVSE provided with the vehicle.
- The genuine NISSAN EVSE charging equipment performs a communication function with the vehicle before Li-ion charging starts. If this communication does not occur because other equipment is used, the Li-ion battery will not charge.
- Immediate charge and charging timer can be performed in the normal charge mode. See "Charging methods" (P.CH-18).

Type of charging	Charge port	Charge connector	Control box	Power	Instructions
Normal charge (Type 1)		 <p>Normal charge connector</p>  <p>Normal charge connector</p>	<p>(for EVSE only)</p> 	 <p>Domestic plug</p>  <p>Electrical outlet</p>  <p>Wallbox type</p>  <p>Station type</p>	<p>Use the NISSAN EVSE (Electric Vehicle Supply Equipment) (if equipped). Use only dedicated outlets installed by an Electro-Mobility Operator (EMO).</p> <p>Wallbox type: Use Wallbox type (Mode3 Case B or Case C) that is installed in your home, office, as public charger, etc. Use only dedicated normal charger installed by an Electro-Mobility Operator (EMO).</p> <p>Station type: Use a charging cable of station type normal charger.</p>
Normal charge (Type 2)		 <p>Normal charge connector</p>  <p>Normal charge connector</p>	<p>(for EVSE only)</p> 	 <p>Domestic plug</p>  <p>Electrical outlet</p>  <p>Wallbox type</p>  <p>Station type</p>	<p>Use the NISSAN EVSE (Electric Vehicle Supply Equipment) (if equipped). Use only dedicated outlets installed by an Electro-Mobility Operator (EMO).</p> <p>Wallbox type: Use Wallbox type (Mode3 Case B or Case C) that is installed in your home, office, as public charger, etc. Use only dedicated normal charger installed by an Electro-Mobility Operator (EMO).</p> <p>Station type: Use a charging cable of station type normal charger.</p>

WBT0003X

NISSAN EVSE (if equipped)

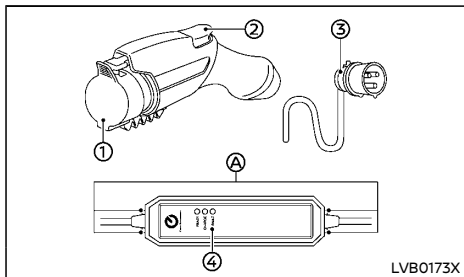

NISSAN EVSE (Type 1)

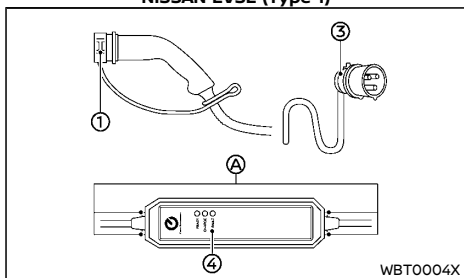

NISSAN EVSE (Type 2)

- ① Safety cap
- ② Release button (if equipped)
- ③ Domestic plug
- ④ Control box* (indicator lights)

*: You can pass a rope through the hole (A) on the control box in order to hang it up while the Li-ion battery is charging.

The NISSAN EVSE with domestic plug provides 10-16A* AC power (3.6kW max) to charge the Li-ion battery.

*: Max current rating depends on the countries.

Your NISSAN certified LEAF dealer can provide full details of our partner Electro-Mobility Operator (EMO) in your country who can give you guidance on the best way to charge your vehicle.

⚠ WARNING:

- Do not use any electrical outlet which does not comply with the latest National Regulations to charge your vehicle.
 - If your house's electrical system is old or has not been inspected recently we strongly recommend that you get your wiring and outlet inspected by a qualified electrician before charging.
- Do not use extension cables because most extension cables cannot carry the required current and might get hot.
- Do not use adapters as the NISSAN EVSE is not designed to be used with adapters and might get hot.
- Ensure that your vehicle is charged on a dedicated circuit.
 - A dedicated circuit is a line from the circuit breaker with no other electrical outlets.
 - Most detached garages will be supplied by a dedicated circuit but often outlets inside the house are on a ring main.
 - Ring main outlets can become overloaded from other electrical devices that are plugged in at the same time as the vehicle which will trip your electricity supply.
- If there are any signs of wear, damage or discoloration, do not use the outlet for charging.

- Inspect the outlet regularly and replace it if there are any signs of wear, damage or discoloration.
- If you have any doubt regarding the capacity of the outlet or wiring, do not charge your vehicle until you have confirmed the outlet's suitability by consulting your Electro-Mobility Operator (EMO) or a qualified electrician.
- Do not disassemble, repair or modify the EVSE.
- Do not use an extension cord or adapter for charging.
- Do not touch the plug with wet hands.
- Do not touch the electrical terminals of the EVSE.
- Do not touch a vehicle or the EVSE if you hear thunder.
- If you have a pacemaker or implantable cardioverter-defibrillator (ICD) implant, keep a distance of at least 15 cm (6 in) between you and the EVSE control box.
- Do not allow a child to handle or use the EVSE without adult supervision.

Precautions on handling the EVSE:

- Do not pull, twist, bend, step on, or drag the cable and/or cord.
- Do not wind the cable and/or cord around objects such as the normal charge connector and/or control box.
- Hold the main body of the domestic plug and securely insert it straight up as far as the base.
- Do not pull on the cord to disconnect the domestic plug.

- Do not use the EVSE when there is an abnormality or problem, such as a deep cut, crack, or damage, or if the domestic plug is corroded.
- If charging stops when you move the domestic plug or cord, this may be caused by a line breakage. When this happens, immediately stop using the EVSE.
- Immediately stop using the EVSE if you notice an abnormality or problem such as a strange smell, smoke, or unusual noises being emitted from the EVSE while charging.

Precautions on the electrical outlet:

- Use a grounded electrical outlet that complies with standards and regulations in your country or area.
 - Do not use an electrical outlet if the domestic plug is loose when inserted in the outlet or if there is damage or corrosion on the outlet side.
 - Ensure electrical supply is AC 220–240 volt, 50 or 60 Hz.
 - Before you connect the EVSE, be sure to check the rated current shown on the EVSE to ensure that the electrical outlet and circuit have enough current capacity to charge your vehicle safely.
 - The EVSE draws a constant 10-16A*, you must ensure that the electrical outlet and household wiring used for charging are rated at this level and comply with the latest electrical wiring standard and regulations in your country or area.
- *: Max current rating depends on the country.
- If in any doubt about the electrical outlet and circuit, consult a qualified electrician.



CAUTION:

Be sure to connect the EVSE to an electrical outlet with the rated voltage only.

Precautions on storing the EVSE:

- Do not store the EVSE in a place exposed to direct sunlight.
- Do not store the EVSE in a place exposed to wind and rain.
- Be sure to store the EVSE with the protective cap on to keep the terminal part of the normal charge connector away from dirt and dust.
- Do not store the EVSE with the cable and/or cord wound around the control box.
- Do not store the EVSE in a condition in which the cable and/or cord are twisted.
- The control box will become hot while the EVSE is charging. This is not a malfunction.

Normal charger (if equipped)

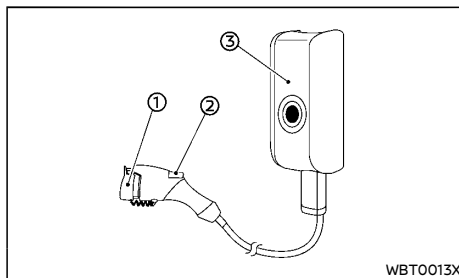

Wallbox type normal charger (Type 1)

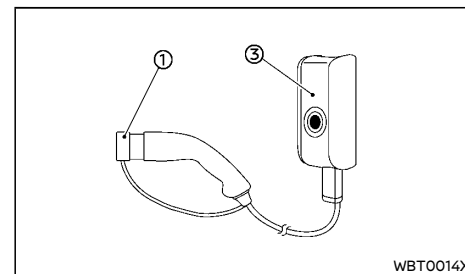

Wallbox type normal charger (Type 2)

- ① Safety cap
- ② Release button (if equipped)
- ③ Normal charger (example)

This vehicle can be charged with a compatible public normal charger (Wallbox type or Station type) or some versions of the home charging units.



WARNING:

Before starting the charge with a normal charger, carefully read the instructions provided on the normal charger (Wallbox type or Station type).

How to start a normal charge

1. Push the P position switch to place the vehicle in the P (Park) position, and apply the parking brake.
2. Place the power switch in the OFF position. Otherwise charging will not start.

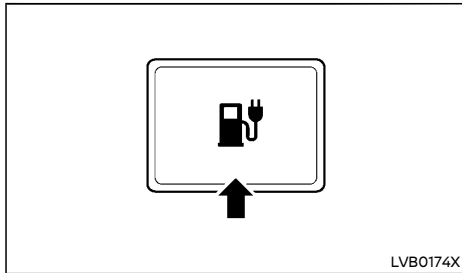

Charge port lid opener switch

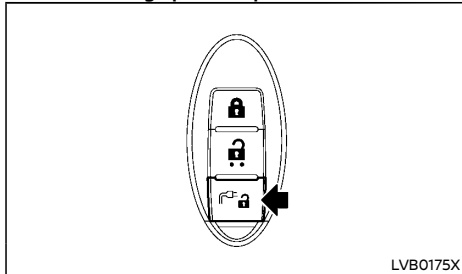

Charge port lid opener button (example)

3. When opening the charge port lid, perform either of the following ways:

- Push the charge port lid opener switch located on the instrument panel, or
- Push and hold the charge port lid opener button on the Intelligent Key for more than 1 second.

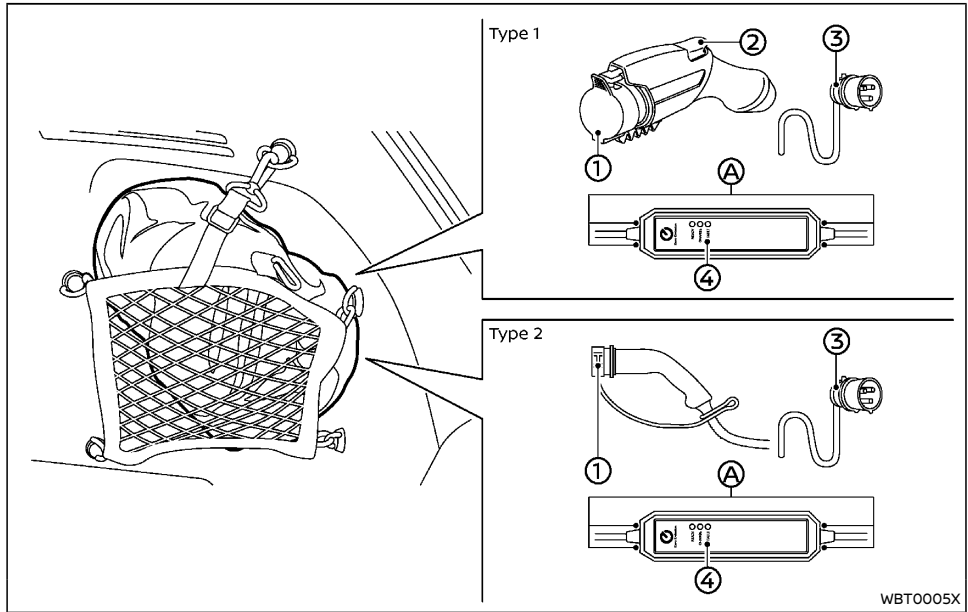

NISSAN EVSE (if equipped) located in the luggage compartment

- ① Safety cap
- ② Release button (if equipped)
- ③ Domestic plug
- ④ Control box* (indicator lights) (if equipped)

*: You can pass a rope through the hole **A** on the control box in order to hang it up while the Li-ion battery is charging.

4. Model with NISSAN EVSE: Connect the domestic plug to the dedicated electrical outlet.

If it is connected normally, the green light on the EVSE control box indicator light illuminates. See "NISSAN EVSE (Electric Vehicle Supply Equipment) control box indicator light" (P.CH-22).

5. Open the normal charge port cap. See "Charge port cap" (P.3-13).

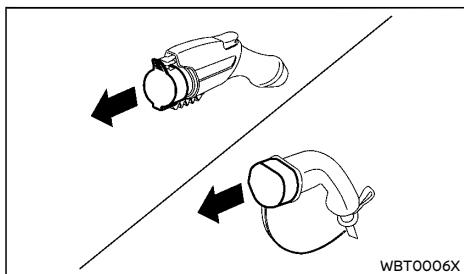

WBT0006X

- Remove the safety cap from the normal charge connector.

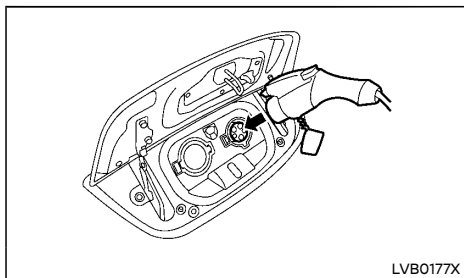

LVB0177X

Type 1

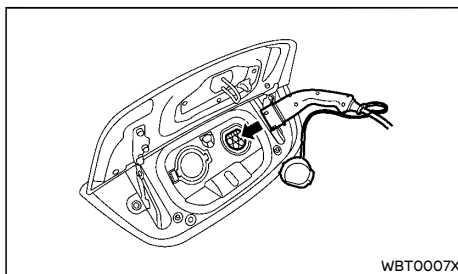

WBT0007X

Type 2

- Connect the charge connector to the charge port. If it is connected normally, a beep will sound once.
- If charging has started, or if the Li-ion battery is waiting for the charging timer to start, a beep will sound twice and the charging status indicator light display will change. See "Charging status indicator lights" (P.CH-20).

For Type 1: The charge connector can be locked using the charge connector lock. See "Charge connector lock" (P.CH-14).

NOTE:

When the vehicle detects that the charge connector is not connected correctly, an alarm sounds for 30 seconds.

In that case, insert the connector correctly or retry the connection. The alarm will stop after 30 seconds, even if the charge connector connection has not been made correctly, but the charging will not start.

How to stop a normal charge

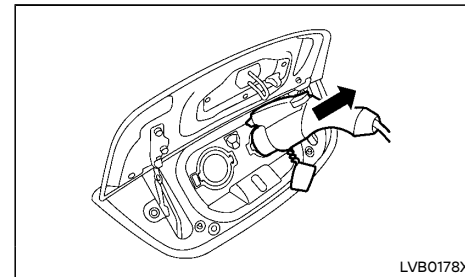

LVB0178X

Type 1

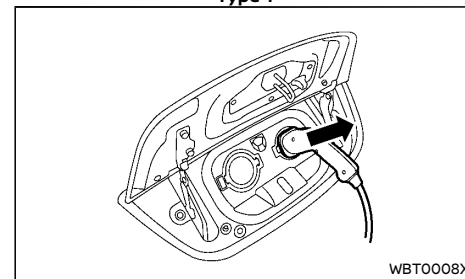

WBT0008X

Type 2

- Ensure that the charge connector lock is not engaged. If the charge connector lock operates, unlock the charge connector. For more information, see "Charge connector lock" (P.CH-14).
- Remove the charge connector from the charge port. (For Type 1: Push the release button on the charge connector to release the lock.)
- Attach the safety cap to the normal charge connector.

- Model with NISSAN EVSE: Remove the domestic plug from the dedicated electrical outlet.

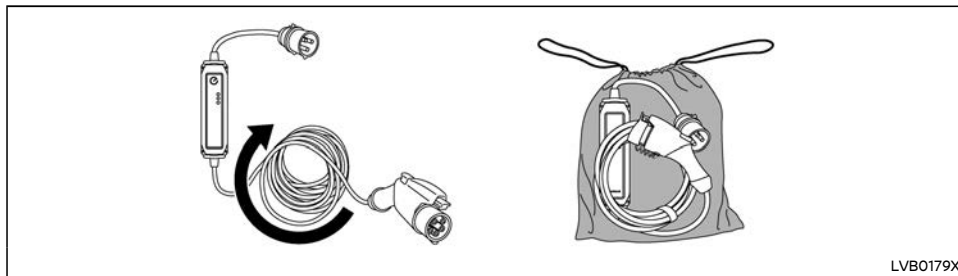

LVB0179X

Example (Type 1)

- Model with NISSAN EVSE: Store the EVSE in its pouch.

NOTE:

To store the NISSAN EVSE in the pouch: Wind the charge cable clockwise against the control box (approximately 30 cm (12 in) in diameter).



WARNING:

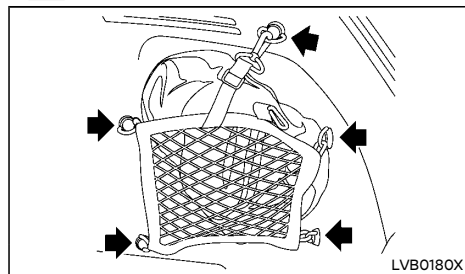

LVB0180X

store it in the storage pouch and secure it firmly with the storage net in the luggage compartment. Otherwise, it may become a projectile and cause a personal injury during sudden braking or in a collision.

- Close the normal charge port cap.
- Close the charge port lid.

CHARGE CONNECTOR LOCK

The normal charge connector can be locked to the normal charge port.

Charge connector lock system (if equipped)

The charge connector lock mode can be selected on the vehicle information display using the buttons on the steering wheel.

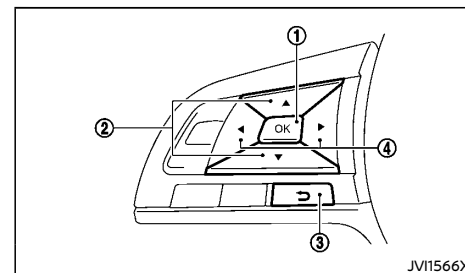

JV11566X

Steering wheel mounted control

- ① OK button
- ② ▲ / ▼ button
- ③ ⤴ Back button
- ④ ◀ / ▶ button

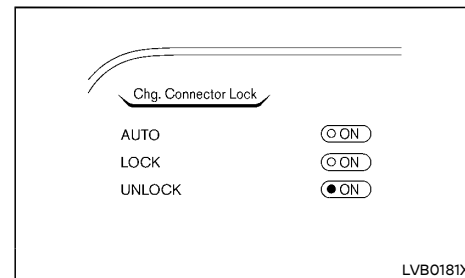

LVB0181X

Vehicle information display

- Push the ◀ / ▶ button to select "Settings" on the vehicle information display.
- Push the ▲ / ▼ button to select "EV settings" and then push the OK button.
- Push the ▲ / ▼ button until "Chg. Connector Lock" is selected and then push the OK button.

if you place the NISSAN EVSE in the vehicle,

4. Push the ▲ / ▼ button until the preferred mode (AUTO, LOCK or UNLOCK) is selected and then push the OK button.

To return to the previous screen, push the ↩ Back button.

NOTE:

The charge connector lock can be activated when the vehicle is in the P (Park) position and the charge connector is connected. The charge connector lock will not be activated if the charge connector is not properly connected.

AUTO mode:

To select the AUTO mode, push the ▲ / ▼ button until "AUTO" is selected and then push the OK button. The indicator light for "AUTO" will illuminate.

When the AUTO mode is selected, the charge connector is locked while charging is in process. The charge connector will be unlocked automatically when charging is complete.

LOCK mode:

To select the LOCK mode, push the ▲ / ▼ button until "LOCK" is selected and then push the OK button. The indicator light for "LOCK" will illuminate.

When the LOCK mode is selected, the charge connector will remain locked. The charge connector will be unlocked when the UNLOCK mode is selected or temporary unlock operation is performed.

UNLOCK mode:

To select the UNLOCK mode, push the ▲ / ▼ button until "UNLOCK" is selected and then push the OK button. The indicator light for "UNLOCK" will illuminate.

When the UNLOCK mode is selected, the charge

connector will remain unlocked.

Temporary unlock mode:

When the charge connector lock system is in the AUTO or LOCK mode, the charge connector lock can be unlocked temporarily by using the Intelligent Key or the charge port lid opener switch.

Unlock operation using Intelligent Key

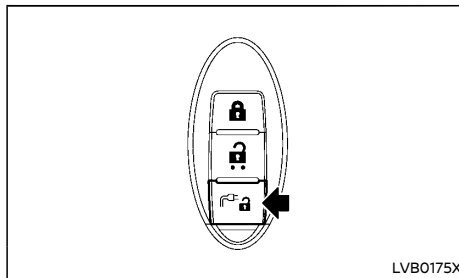

Example

1. Push the charge port lid opener button on the Intelligent Key for more than 1 second.
2. The charging status indicator light flashes three times and a beep sounds three times. The charge connector lock is unlocked for 30 seconds.
3. After 30 seconds, the charge connector lock is locked again.

For models with charge connector lock system:

The charge connector lock can also be unlocked for 30 seconds when unlocking a door or the rear hatch (in this case, the charging status indicator light does not operate). If the lock is operated again within 30 seconds after unlocking the door/rear hatch, the charge connector lock is locked again.

Unlock operation using charge port lid opener switch

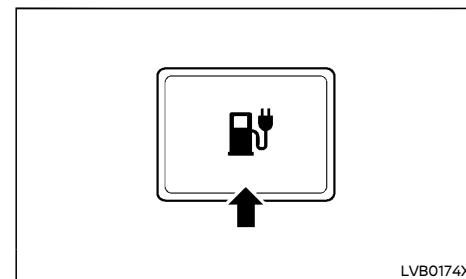

1. Push the charge port lid opener switch.
2. The charging status indicator light flashes three times and a beep sounds three times. The charge connector lock is unlocked for 30 seconds.
3. After 30 seconds, the charge connector lock is locked again.

NOTE:

- **Depending on the charging station, the lock mechanism established by local standards may not be compatible with your vehicle. It may not be possible for the charge connector to lock to your vehicle.**
- **For models with charge connector lock system:**
 - **When the power source is cut off while charging in the AUTO mode, the connector will be continuously locked for 5 minutes, then it will be released.**
 - **When charging timer is set with the AUTO mode, the connector will not lock until charging is started.**

- When the Climate Ctrl. Timer is operated or the 12-volt battery is being charged, the charge connector lock will not lock.

If the charge connector cannot be unlocked

Type 1:

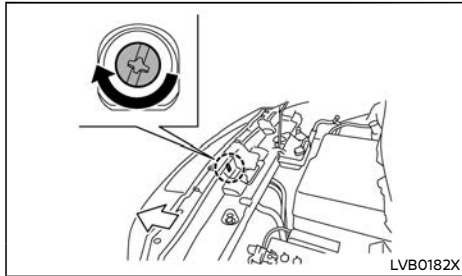

CAUTION:

Do not unlock the charge connector using the screw as illustrated when the charge connector lock is operated normally.

If the charge connector cannot be unlocked, proceed as follows:

1. Place the power switch in the OFF position.
2. Open the hood.
3. Insert a flat-blade screwdriver or suitable tool into the screw that is located on the front of the hood lock.
4. Turn the screw clockwise to release the charge connector lock.
5. Remove the charge connector from the charge port.

Type 2:

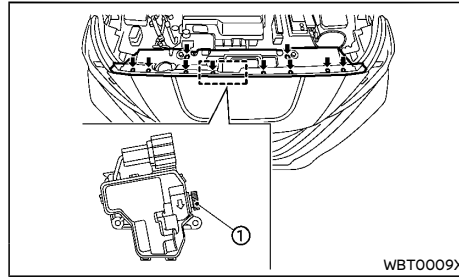

CAUTION:

- Do not unlock the charge connector using the knob ① when the charge connector lock is operated normally.
- Do not turn the knob ① clockwise. This may cause damage to the charge connector.

If the charge connector cannot be unlocked, proceed as follows:

1. Place the power switch in the OFF position.
2. Open the hood.
3. Remove the plastic holding clips from the cover and then remove the cover.
4. Turn the knob ① counterclockwise (about 4 turns) to release the charge connector lock.
5. Remove the charge connector from the charge port.

V2X CHARGE/DISCHARGE

V2X (Vehicle to Everything) enables the EV to supply electric power to a home or a building, etc. V2X encompasses the following features:

- Vehicle to Home (V2H)
- Vehicle to Building (V2B)
- Vehicle to Grid (V2G)
- Vehicle to Load (V2L)
- Vehicle to Vehicle (V2V)

V2X charge/discharge capability is only available on vehicles manufactured with the quick charge port option.

A vehicle fitted with a quick charge port is compatible with most CHAdeMO (Japanese industry standard) connectors on charging stations.

V2X charging/discharging is possible (even several times a day). If the battery temperature is near the red zone, in order to protect the battery, power for V2X charging/discharging will be limited.

For additional information, consult a V2X device manufacturer, or a V2X charging/discharging service provider.

V2X charge/discharge uses a V2X device.

WARNING:

- Always use a V2X device that is compatible with the LEAF. Using an incompatible V2X device may cause a fire or malfunction resulting in serious personal injury or death.
- Before starting the V2X charge/discharge, carefully read the instructions provided on the V2X device and make sure the V2X device is properly connected and locked to the vehicle. Failure to

connect or operate the V2X device correctly could cause damage to the vehicle or the charging equipment.

NOTE:

When the Li-ion battery available charge/discharge and Li-ion battery capacity are shown on the V2X device, the readings may differ from the actual Li-ion battery available charge/discharge capacity.

How to start V2X charging/discharging

1. Push the P position switch to place the vehicle in the P (Park) position, and apply the parking brake.
2. Place the power switch in the OFF position. When the power switch is in the ON position, the Li-ion battery will not start charging/discharging.
3. Open the charge port lid and the quick charge port cap. (See "Charge port cap" (P.3-13).)

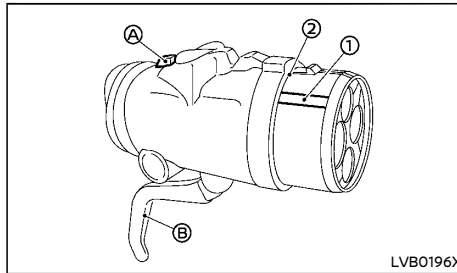
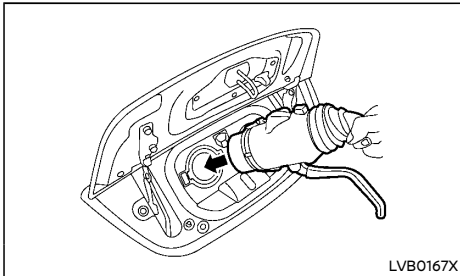

4. Align the groove on the charge connector ① with the quick charge port and insert the charge connector right up to the base ②. (A Release button, B Lock lever; There is no need to use them at this stage.)

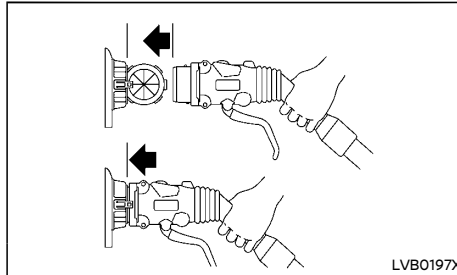

CAUTION:

Be sure to insert the charge connector straight into the quick charge port right up to the base. Failure to do so may result in the Li-ion battery not charging or could cause damage to the charging equipment.

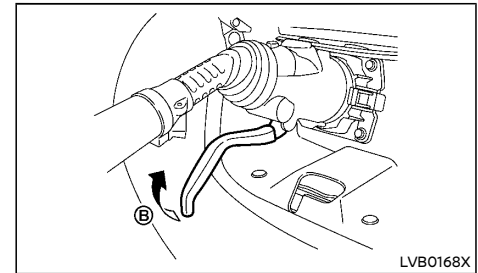

5. Pull the lock lever B up to lock the charge connector.
6. Confirm the lock lever is fixed in the lever holder.
7. Follow the instructions on the V2X device to start charging/discharging. When the equipment is properly installed and ready to charge/discharge, a beep sounds twice and the charging status indicator light will change. See "Charging status indicator lights" (P.CH-20).

Charging/discharging ends in the following situations:

- When charging/discharging is complete.
- When the possible charge/discharge time set for the V2X device is exceeded.

NOTE:

- Charging/discharging may automatically stop even if it is not completed.
- If charging/discharging stops mid-charge/discharge, you can restart charging/discharging by starting operation of the V2X device again.
- The charge connector is locked to the charge port during charging/discharging and cannot be disconnected. Follow the

instructions on the V2X device to stop charging/discharging. Confirm charging/discharging is stopped by looking at the charging status indicator lights on the instrument panel. The charge connector can be disconnected from the vehicle when charging/discharging has stopped.

How to stop V2X charging/discharging

1. Confirm charging/discharging is stopped by looking at the charging status indicator lights on the instrument panel. The charge connector can be disconnected from the vehicle when charging/discharging is stopped.

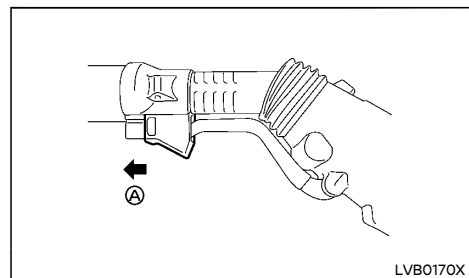

2. Slide back the lever holder (A).

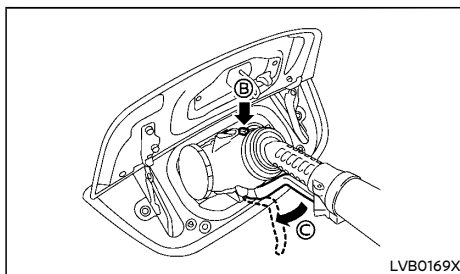

3. Push the release button (B) on the charge connector to release the lock lever (C).
4. Remove the charge connector from the vehicle and store it away properly.
5. Close the quick charge port cap.
6. Close the charge port lid.

CHARGING METHODS

CHARGING TIMER

Use the charging timer to schedule when the Li-ion battery will be charged. The vehicle automatically starts charging at the scheduled times once the charge connector is connected to the vehicle. The timers do not need to be reset each time the Li-ion battery needs to be charged.

The charging timer can save two timer settings that include the charging start time and end time.

The charging timer settings can be changed on the vehicle information display using the buttons on the steering wheel.

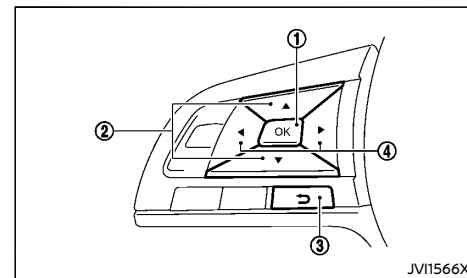

- Steering wheel mounted control**
- ① OK button
 - ② ▲ / ▼ button
 - ③ ⏪ Back button
 - ④ ◀ / ▶ button

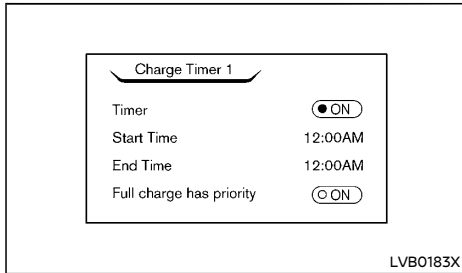

Vehicle information display

1. Push the ◀ / ▶ button to select "Settings" on the vehicle information display.
2. Push the ▲ / ▼ button to select "EV Settings" and then push the OK button.
3. Push the ▲ / ▼ button until the "Charge Timer1" or "Charge Timer2" is selected and then push the OK button.
4. Push the ▲ / ▼ button to select "Timer" and then push the OK button. The indicator light will turn on when the timer setting is turned on.
5. Push the ▲ / ▼ button until the "Start Time" is selected and then push the OK button.
6. Push the ▲ / ▼ button to set the hour and then push the OK button (models without NissanConnect System) or push the ◀ / ▶ button (models with NissanConnect System).
7. Push the ▲ / ▼ button to set the minute and then push the OK button.
8. Push the ▲ / ▼ button until the "End Time" is selected and then push the OK button.

9. Push the ▲ / ▼ button to set the hour and then push the OK button (models without NissanConnect System) or push the ◀ / ▶ button (models with NissanConnect System).
10. Push the ▲ / ▼ button to set the minute and then push the OK button.
11. After the setting is complete, place the power switch in the OFF position, and then connect the charge connector to the vehicle.

To return to the previous screen, push the ⏪ Back button.

Full charge has priority

If "Full charge has priority" is turned on, the charge start time will be advanced in the case that the fully charged condition of the Li-ion battery cannot be achieved during the time from the start time to end time. If the fully charged battery condition is not achieved, the charging continues until the Li-ion battery is fully charged.

NOTE:

- If "Full charge has priority" is turned on, it is possible that the battery is not charged fully by the charge end time due to the operating condition of the Climate Ctrl. Timer and the tolerance of charging time, etc. In that case, the charging continues until the Li-ion battery is fully charged.
- Always place the power switch in the OFF position after setting the charging time. When the power switch is in the ON position, the Li-ion battery will not start charging.
- If the current time passes the charge start time by too much, it is possible that the actual charging amount may be

smaller than the expected level.

- The Li-ion battery will not charge when the charge connector is connected to the vehicle until the next scheduled charge start time, when the charging timer is active. If necessary, use immediate charge to charge the Li-ion battery.
- Some charging stations used to perform normal charge are equipped with timer functions. If both the charger timer function and the vehicle's charge timer are set, and the two timers are not set to operate at the same time, it is possible that the charger will not start or the Li-ion battery will not be charged to the expected level.
- Charging timer is performed according to the current time setting of the clock on the vehicle information display. When setting the charging timer function, be sure to check that the current time displayed is correct.
- To turn off the charging timer function, select "Timer" on the charge timer setting screen (both "Charge Timer1" and "Charge Timer2") and push the OK button to turn off the indicator light.

Immediate charge

When the charging timer is not turned on, charging automatically starts when a normal charge connector is connected to the vehicle.

Use the immediate charge mode any time you need to start charging immediately while a charging timer is turned on.

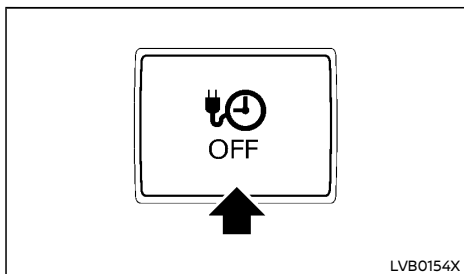

- If the charge cable is already connected, push the immediate charge switch to start performing an immediate charge.

To perform the immediate charge:

1. Place the power switch in the OFF position.
2. Push the immediate charge switch.
3. Connect the normal charge cable when the charging status indicator light changes to indicate immediate charge mode.

NOTE:

- You have 15 minutes to connect a normal charge connector to the vehicle after the immediate charge switch is pushed. If a charge connector is not connected to the vehicle within 15 minutes, the vehicle automatically returns to the previous setting.
- To cancel the immediate charge mode, push the immediate charge switch again before connecting the charge cable.
- If the charge cable is disconnected in the immediate charge mode, the immediate charge stops and the charge mode automatically switches to charging timer. To perform an immediate charge again, push the immediate charge switch and connect the charge cable.

CHARGING RELATED INDICATOR LIGHTS

CHARGING STATUS INDICATOR LIGHTS

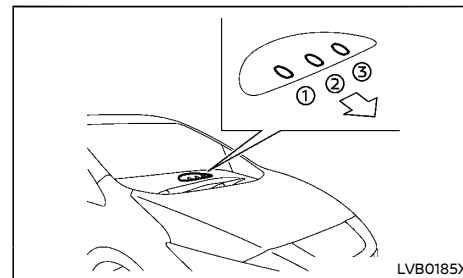

The charging status indicator lights ① to ③ primarily indicate the charging status, and are visible from both inside and outside the vehicle.

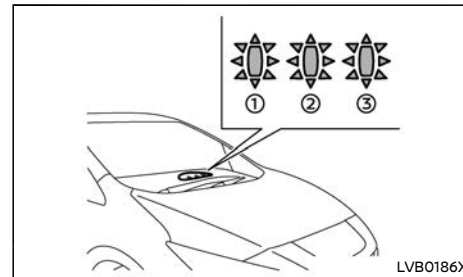

When the normal charge connector lock is unlocked

All of the indicator lights, ① to ③, will flash and a beep will sound three times when the charge port lid opener button on the Intelligent Key or the charge port lid opener switch is pushed.

When the normal charge connector is connected incorrectly

All of the indicator lights, ① to ③, will flash and a

beep will sound three times within 30 seconds when the charge connector is connected incorrectly to the normal charge port.

The charging cannot be performed in this condition.

Ready for charging timer

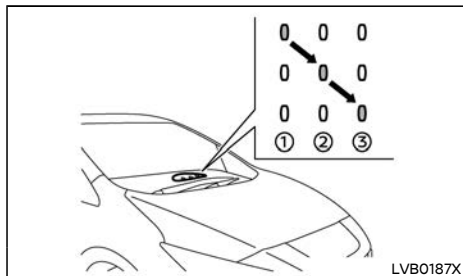

If the charging timer is set, the indicator lights illuminate, in order from ① to ③. The indicator lights turn off after approximately 5 minutes.

Ready for immediate charge

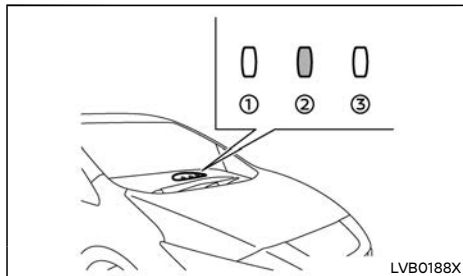

When the power switch is in the OFF position and if the immediate charge switch is pushed while the charge cable is not connected, the

indicator light ② illuminates, indicating the vehicle is ready for immediate charge.

You then have 15 minutes to connect the charge connector to the vehicle. If the charge connector is not connected within 15 minutes, the indicator light ② turns off and you must start the immediate charge mode again to charge the Li-ion battery.

When charging

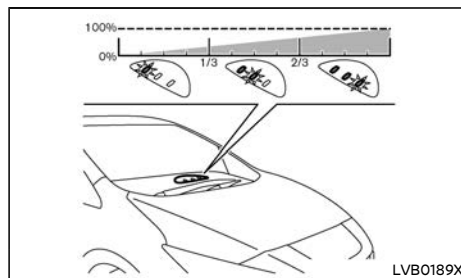

When the Li-ion battery is being charged, the charging status indicator lights will change depending on the amount the Li-ion battery is charged.

The amount the Li-ion battery is charged is also displayed by the illumination of the Li-ion battery available charge gauge on the vehicle information display.

When fully charged

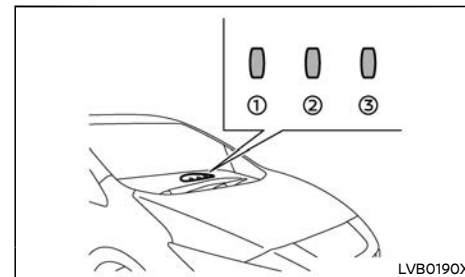

All of the indicator lights, ① to ③, illuminate when the Li-ion battery is fully charged.

The indicator lights turn off after approximately 5 minutes or when the charge connector is removed.

When the indicator light ③ flashes

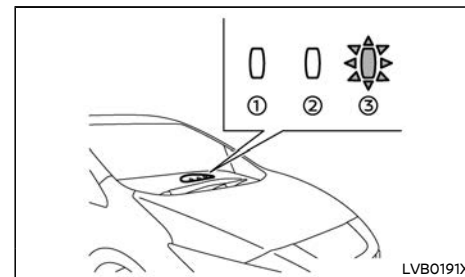

The indicator light ③ flashes when the 12-volt battery is being charged. See "Charging the 12-volt battery" (P.EV-4).

The indicator light will also flash for up to 5 minutes if the electrical power from the normal charge device is interrupted during charging.

Charging will restart automatically when the electrical power from the normal charge device is restored if the normal charge device is connected. The charge start beep will not sound when charging restarts.

The indicator light will also flash when the Climate Ctrl. Timer is operating.

When not charging

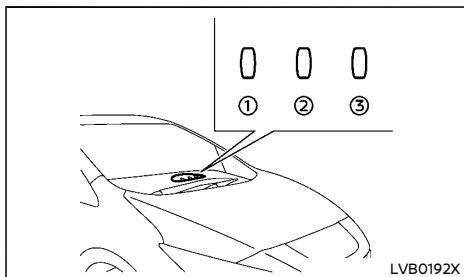

None of the lights are illuminated when the Li-ion battery and 12-volt battery are not charging.

NISSAN EVSE (Electric Vehicle Supply Equipment) CONTROL BOX INDICATOR LIGHT (if equipped)

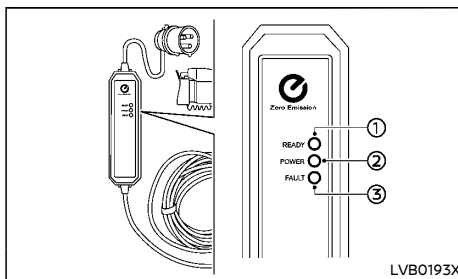

- ① READY: GREEN
- ② POWER: ORANGE
- ③ FAULT: RED

When a normal charge is being performed using the NISSAN EVSE (Electric Vehicle Supply Equipment), the charging status as well as any EVSE malfunction can be checked with the indicator lights on the EVSE control box.

READY	POWER	FAULT	Status and action to be taken
●	●	●	All indicator lights will illuminate for a 0.5 second check when the EVSE is first connected to the outlet socket.
●	OFF	OFF	The EVSE is connected to the outlet socket. If the normal charge connector is connected to the vehicle normal charge port, charging is complete or the charge timer is set (refer to "Charging timer" (P.CH-18)).
●	●	OFF	The EVSE is charging the vehicle.
OFF	OFF	OFF	No power is detected by the EVSE from the outlet socket. Check the outlet supply breaker. If the outlet supply is OK and all the indicator lights do not illuminate for 0.5 seconds, the EVSE may be broken. Stop use and immediately contact a NISSAN certified LEAF dealer.
○	●	OFF	The EVSE could not detect sufficient outlet socket earth grounding for reliable EV charging. Contact a NISSAN certified LEAF dealer.
○	OFF	OFF	
○	○	●	
○	OFF	●	The temperature detection circuit in the domestic plug of the EVSE is malfunctioning. Indicator light status: Light OFF = Charge is stopped, Flashing = Charge current is reduced. The EVSE is restricting the charging current. Contact a NISSAN certified LEAF dealer.
○	○	○	The EVSE detected excessive heat in the domestic plug. Indicator light status: Light OFF = Charge is stopped, Flashing = Charge current is reduced.
○	OFF	○	The EVSE is restricting the charging current for safety. This may be caused by a malfunction in the outlet. Stop using the outlet and contact a NISSAN certified LEAF dealer. If the same indication continues after checking the outlet, contact a NISSAN certified LEAF dealer for further advice.
●	○	●	The EVSE internal circuits malfunction. Stop use immediately and contact a NISSAN certified LEAF dealer.
●	OFF	●	
●	OFF	○	The EVSE detected leakage current or PWM signal error. Stop using the EVSE immediately. Contact a NISSAN certified LEAF dealer and check EVSE and vehicle.

Meaning	Light ON	Flashing	Light OFF
Symbol	●	○	OFF

CHARGING TROUBLESHOOTING GUIDE

Symptom	Possible cause	Possible solution
Charging cannot be performed.	The vehicle power switch is in the ON position.	Before charging, place the power switch in the OFF position.
	Both the normal charge connector and the quick charge connector are connected at the same time.	The normal charge and the quick charge cannot be operated at the same time.
	The Li-ion battery is already fully charged.	Confirm the available Li-ion battery power remaining by checking Li-ion battery available charge gauge. If the gauge indicates full, the Li-ion battery is already fully charged and cannot be charged. Charging automatically turns off if the Li-ion battery is fully charged.
	The temperature of the Li-ion battery is too high or too low to charge.	Confirm the Li-ion battery temperature by checking the Li-ion battery temperature gauge. If the gauge indicates the Li-ion battery is too hot (red zone) or too cold (blue zone), charging may not be possible. Allow the Li-ion battery to cool down or warm up before charging. See "3. Li-ion battery temperature gauge" (P.2-28).
	The 12-volt battery is discharged.	The Li-ion battery cannot be charged if the vehicle electrical systems cannot be turned on. If the 12-volt battery is discharged, charge or jump start the 12-volt battery. See "Jump starting" (P.6-9).
	The vehicle has a malfunction.	The vehicle or charger may have a malfunction. Confirm if the warning light on the meter is illuminated. Confirm if the indicator on the charger is indicating a malfunction. If a warning is displayed, stop charging and contact a NISSAN certified LEAF dealer.
Normal charge cannot be performed.	There is no electrical power coming from the normal charging station or electrical outlet.	Confirm that there has not been a power failure. Make sure the circuit breaker is active. If an electrical outlet or charging station with a timer device installed is used, power will only be available at the time set by the timer.
	The domestic plug is not connected correctly.	Confirm the domestic plug is connected correctly.
	There is no electrical power coming from the normal charging station.	Confirm operation procedure of the charging station.
	The charge connector is not connected correctly.	Confirm the charge connector is connected correctly.
Immediate charge cannot be performed.	Charging timer has been set.	Push the immediate charge switch or turn off the charging timer. See "Charging methods" (P.CH-18).

Symptom	Possible cause	Possible solution
Timer charging cannot be performed.	The charge cable is not connected.	Connect the charge cable.
	The time on the clock is wrong.	The charging timer does not start charging based on the clock located on the vehicle information display. Adjust the time. (See "Clock" (P.2-19).) If the 12-volt battery is discharged or if the Li-ion battery is disconnected, the time setting must be updated.
	The immediate charge switch has been pushed.	Charging timer does not operate when immediate charge is selected.
	Charging timer has not been set.	Set the charging timer schedule. See "Charging timer" (P.CH-18).
	Charging does not start because the charging timer start time and end time are set and the current time is before the set start time.	Confirm when the charging timer time is set to start charging. Change the charging timer setting to the desired charge time or push the immediate charge switch. See "Charging methods" (P.CH-18).
Normal charge stops during charging.	There is no electrical power coming from the normal charging station or electrical outlet.	There may have been an electrical power failure, or the circuit breaker may have failed. Charging will resume when the power source is reset.
	The charge cable has been disconnected.	Check that the charge cable has not been disconnected.
	Both the normal charge connector and the quick charge connector were connected at the same time.	If the normal charge connector and the quick charge connector are connected at the same time, charging will be stopped.
	Charging timer end time has been reached.	When the charging timer is set and the charge end time is reached, charging will be stopped, even if the Li-ion battery is not fully charged.
	The electrical power supply from the normal charging station was stopped.	Confirm operation procedure of the charging station.
	The temperature of the Li-ion battery is too high or too low to charge.	Confirm the Li-ion battery temperature by checking the Li-ion battery temperature gauge. If the gauge indicates the Li-ion battery is too hot (red zone) or too cold (blue zone), charging may not be possible. Allow the Li-ion battery to cool down or warm up before charging. See "3. Li-ion battery temperature gauge" (P.2-28).
Normal charge connector cannot be removed.	The charge connector lock is locked.	Unlock the charge connector lock. See "Unlock operation using Intelligent Key" (P.CH-15) or "Unlock operation using charge port lid opener switch" (P.CH-15).
	The vehicle has a malfunction.	If the normal charge connector cannot be removed by using Intelligent Key or charge port lid opener switch, follow the unlocking steps. See "If the charge connector cannot be unlocked" (P.CH-16).

Symptom	Possible cause	Possible solution
Quick charge cannot be performed.	The quick charge connector is not connected correctly.	Check that the charge connector is connected correctly and that it is locked.
	The self-diagnostic function of the quick charge device returns a negative result.	There is a possibility that the vehicle has a malfunction. Stop charging and contact a NISSAN certified LEAF dealer.
	The power switch of the quick charger is off.	Check the power switch of the quick charger.
Quick charge stops during charging.	Charging is stopped by the quick charge timer.	Charging will stop depending on the timer function setting of the quick charge device. If you need to charge the Li-ion battery more, start the charging procedure again.
	The power supply for the quick charger is off.	Check whether the power supply for the quick charger is off.
	Both the normal charge connector and the quick charge connector were connected at the same time.	If the normal charge connector and the quick charge connector are connected at the same time, charging will be stopped.
	The temperature of the Li-ion battery is too high or too low to charge.	Confirm the Li-ion battery temperature by checking the Li-ion battery temperature gauge. If the gauge indicates the Li-ion battery is too hot (red zone) or too cold (blue zone), charging may not be possible. Allow the Li-ion battery to cool down or warm up before charging. See "3. Li-ion battery temperature gauge" (P.2-28).

1 Safety—Seats, seat belts and supplemental restraint system

Seats	1-2	Child restraints	1-11
Front seats	1-2	Precautions on child restraint	1-11
Rear seats	1-4	Universal child restraints for front and rear seats	1-12
Head restraints	1-5	ISOFIX child restraint system	1-15
Adjustable head restraint components	1-5	Child restraint anchorage	1-15
Non-adjustable head restraint components	1-5	Child restraint installation using ISOFIX	1-16
Remove	1-5	Child restraint installation using three-point type seat belt	1-18
Install	1-6	Supplemental Restraint System (SRS)	1-22
Adjust	1-6	Precautions on Supplemental Restraint System (SRS)	1-22
Seat belts	1-7	Supplemental air bag systems	1-26
Precautions on seat belt usage	1-7	SRS air bag deployment conditions	1-28
Child safety	1-8	Pre-tensioner seat belt system	1-30
Pregnant women	1-9	Repair and replacement procedure	1-30
Injured persons	1-9		
Three-point type seat belts	1-9		
Seat belt maintenance	1-11		

SEATS

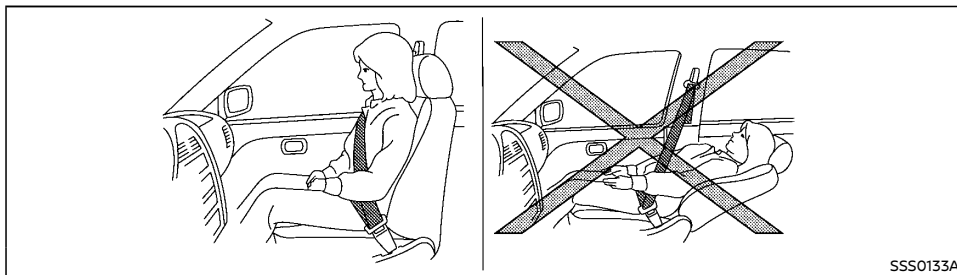

WARNING:

- Do not ride in a moving vehicle when the seatback is reclined. This can be dangerous. The shoulder belt will not be against your body. In an accident, you could be thrown into it and receive neck or other serious injuries. You could also slide under the lap belt and receive serious internal injuries.
- For the most effective protection when the vehicle is in motion, the seat should be upright. Always sit well back and upright in the seat with both feet on the floor and adjust the seat properly. See "Precautions on seat belt usage" (P.1-7).
- Do not leave children unattended inside the vehicle. They could unknowingly activate switches or controls. Unattended children could become involved in serious accidents.
- To help avoid risk of injury or death through unintended operation of the vehicle and/or its systems, do not leave children, people who require the assistance of others or pets unattended in

your vehicle. Additionally, the temperature inside a closed vehicle on a warm day can quickly become high enough to cause a significant risk of injury or death to people and pets.

- The seatback should not be reclined any more than needed for comfort. Seat belts are most effective when the passenger sits well back and straight up in the seat. If the seatback is reclined, the risk of sliding under the lap belt and being injured is increased.

CAUTION:

When adjusting the seat positions, be sure not to contact any moving parts to avoid possible injuries and/or damage.

FRONT SEATS

WARNING:

Do not adjust the driver's seat while driving so that full attention may be given to vehicle operation.

Front manual seat adjustment

WARNING:

After adjusting a seat, gently shake the seat to confirm that the seat is locked securely. If the seat is not locked securely, it may move suddenly and could cause the loss of control of the vehicle.

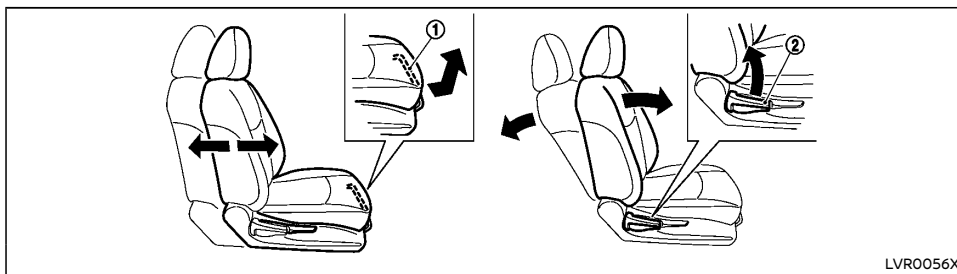

LVR0056X

Forward and backward:

Pull the lever ① up and hold it while sliding the seat forward or backward to the preferred position. Release the lever to lock the seat in position.

Reclining:

To recline the seatback, pull the lever ② up and lean back. To bring the seatback forward, pull the lever up and lean your body forward. Release the lever to lock the seatback in position.

The reclining feature allows adjustment of the seatback for occupants of different sizes for added comfort and to help obtain proper seat belt fit. See "Precautions on seat belt usage" (P.1-7). Also, the seatback can be reclined to allow occupants to rest when the vehicle is stopped and the vehicle is in the P (Park) position or N (Neutral) position with the parking brake applied.

Seat lifter (for driver's seat):

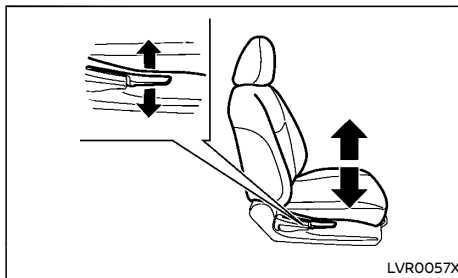

LVR0057X

Pull up or push down the lever to adjust the seat height to the preferred position.

Heated seats



WARNING:

Do not use or allow occupants to use the seat heater if you or the occupants cannot monitor elevated seat temperatures or have an inability to feel pain in those body parts in contact with the seat. Use of the seat heater by such people could result in serious injury.



CAUTION:

- Do not use the seat heater for extended periods or when no one is using the seat.
- Do not put anything on the seat which insulates heat, such as a blanket, cushion, seat cover, etc. Otherwise, the seat may become overheated.
- Do not place anything hard or heavy on the seat or pierce it with a pin or similar object. This may result in damage to the heater.
- Any liquid spilled on the heated seat should be removed immediately with a dry cloth.
- When cleaning the seat, never use gasoline, thinner, or any similar materials.
- If any malfunctions are found or the heated seat does not operate, turn the switch off and have the system checked by a NISSAN certified LEAF dealer.

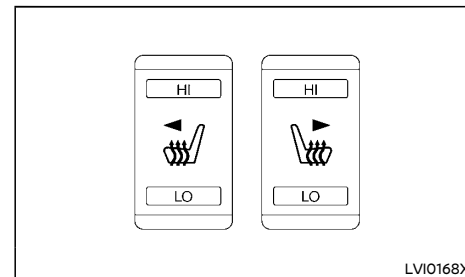

LVI0168X

The front seats can be warmed by built-in heaters. The switches located on the lower of the instrument panel can be operated independently of each other.

1. Place the power switch in the ON position.
2. Push the LO or HI position of the switch, as desired, depending on the temperature. The indicator light on the switch will illuminate.
3. To turn off the heater, return the switch to the level position. Make sure the indicator light goes off.

The heater is controlled by a thermostat, automatically turning the heater on and off. The indicator light will remain on as long as the switch is on.

When the vehicle's interior is warmed, or before you leave the vehicle, be sure to turn the switch off.

NOTE:

The heated seats consume less power than the heater and can be used to either help extend driving range by reducing heater use or to maximize comfort by supplementing the heater.

REAR SEATS

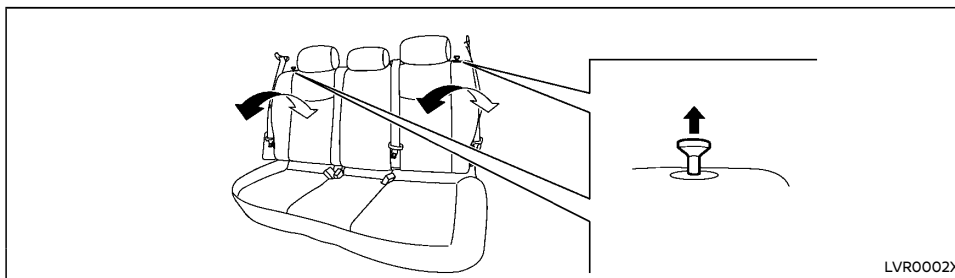

Folding

Before folding the rear seats:

- Secure the seat belts on the seat belt hooks located on the side wall. See "Seat belt hooks" (P.1-10).

To fold down the seatback, pull the release knob.

To return the seatback to the seating position, lift up each seatback and push it to the upright position until it is latched.



WARNING:

- **Do not fold down the rear seats when occupants are in the rear seat area or any objects are on the rear seats.**
- **Never allow anyone to ride in the cargo area or on the rear seats when they are in the folded-down position. Use of these areas by passengers without proper restraints could result in serious injury in an accident or sudden stop.**
- **Properly secure all cargo with ropes or straps to help prevent it from sliding or**

shifting. Do not place cargo higher than the seatbacks. In a sudden stop or collision, unsecured cargo could cause personal injury.

- **When returning the seatbacks to the upright position, be certain they are completely secured in the latched position. If they are not completely secured, passengers may be injured in an accident or sudden stop.**

HEAD RESTRAINTS



WARNING:

Head restraints supplement the other vehicle safety systems. They may provide additional protection against injury in certain rear end collisions. Adjustable head restraints must be adjusted properly, as specified in this section. Check the adjustment after someone else uses the seat. Do not attach anything to the head restraint stalks or remove the head restraint. Do not use the seat if the head restraint has been removed. If the head restraint was removed, reinstall and properly adjust the head restraint before an occupant uses the seating position. Failure to follow these instructions can reduce the effectiveness of the head restraint. This may increase the risk of serious injury or death in a collision.

- Your vehicle is equipped with a head restraint that may be integrated, adjustable or non-adjustable.
- Adjustable head restraints have multiple notches along the stalk to lock them in a desired adjustment position.
- The non-adjustable head restraints have a single locking notch to secure them to the seat frame.
- Proper Adjustment:
 - For the adjustable type, align the head restraint so the center of your ear is approximately level with the center of the head restraint.
 - If your ear position is still higher than the recommended alignment, place the head restraint at the highest position.
- If the head restraint has been removed, ensure that it is reinstalled and locked in place before riding in that designated

seating position.

ADJUSTABLE HEAD RESTRAINT COMPONENTS

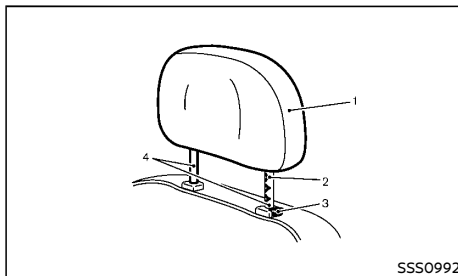

1. Removable head restraint
2. Multiple notches
3. Lock knob
4. Stalks

NON-ADJUSTABLE HEAD RESTRAINT COMPONENTS

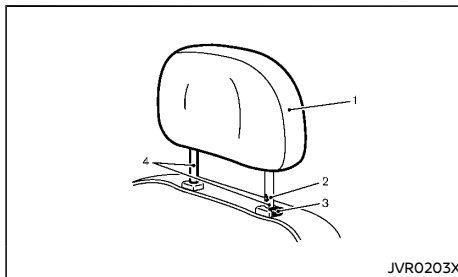

1. Removable head restraint

2. Single notch
3. Lock knob
4. Stalks

REMOVE

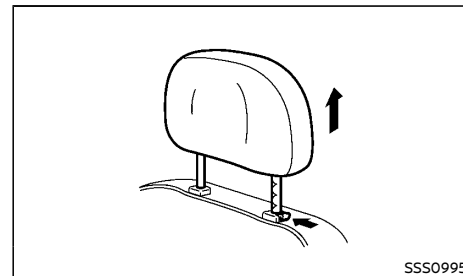

Use the following procedure to remove the adjustable head restraints.

1. Pull the head restraint up to the highest position.
2. Push and hold the lock knob.
3. Remove the head restraint from the seat.
4. Store the head restraint properly in a secure place so it is not loose in the vehicle.
5. Reinstall and properly adjust the head restraint before an occupant uses the seating position.

INSTALL

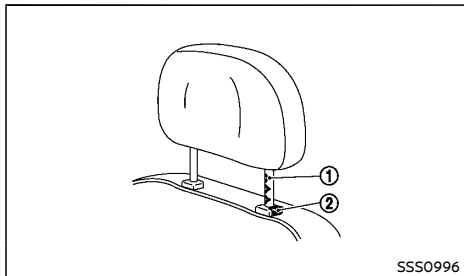

1. Align the head restraint stalks with the holes in the seat. Make sure that the head restraint is facing the correct direction. The stalk with the adjustment notch ① must be installed in the hole with the lock knob ②.
2. Push and hold the lock knob and push the head restraint down.
3. Properly adjust the head restraint before an occupant uses the seating position.

ADJUST

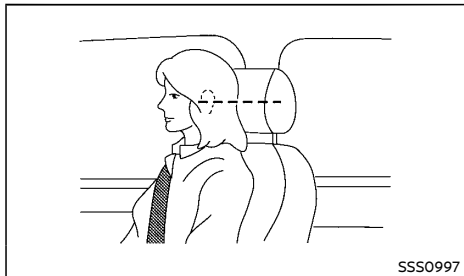

For adjustable head restraint

Adjust the head restraint so the center is level with the center of your ears. If your ear position is still higher than the recommended alignment, place the head restraint at the highest position.

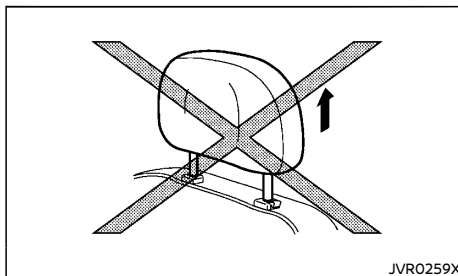

For non-adjustable head restraint

Make sure the head restraint is positioned from the stored position or any non-latch position so the lock knob is engaged in the notch before riding in that designated seating position.

Raise

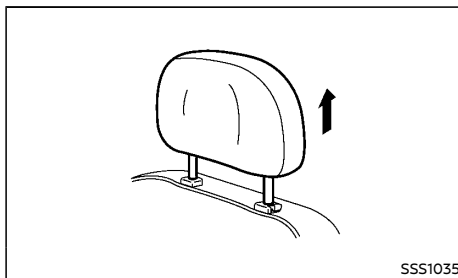

To raise the head restraint, pull it up.

Make sure the head restraint is positioned from the stored position or any non-latch position so the lock knob is engaged in the notch before riding in that designated seating position.

Lower

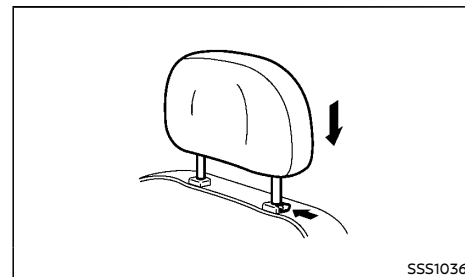

To lower, push and hold the lock knob and push the head restraint down.

Make sure the head restraint is positioned so the lock knob is engaged in the notch before riding in that designated seating position.

SEAT BELTS

PRECAUTIONS ON SEAT BELT USAGE

If you are wearing the seat belt properly adjusted and sitting upright and well back in the seat, chances of being injured or killed in an accident and/or the severity of injury may be greatly reduced. NISSAN strongly encourages you and all of your passengers to buckle up every time you drive, even if your seating position includes the supplemental air bag systems.

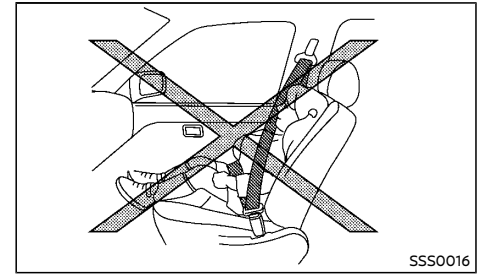
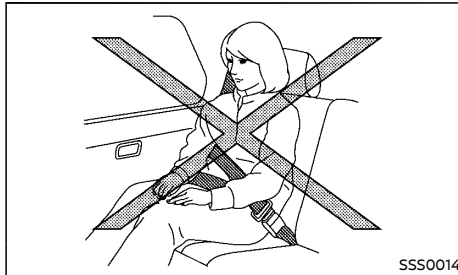
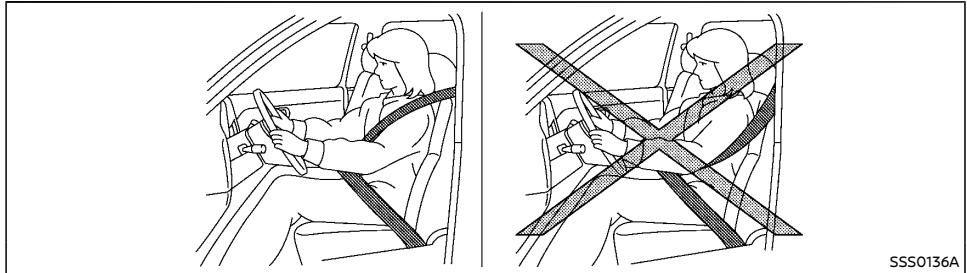
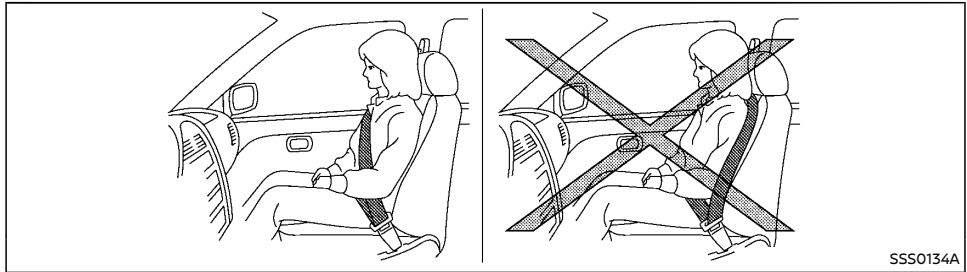



WARNING:

- Seatbelts are designed to bear upon the bony structure of the body, and should be worn low across the front of the pelvis or the pelvis, chest and shoulders, as applicable; wearing the lap section of the belt across the abdominal area must be avoided. Serious injury may occur if a seat belt is not worn properly.
- Position the lap belt as low and snug as possible around the hips, not the waist. A lap belt worn too high could increase the risk of internal injuries in an accident.
- Do not allow more than one person to use the same seat belt. Each belt assembly must only be used by one occupant; it is dangerous to put a belt around a child being carried on the occupant's lap.
- Never carry more people in the vehicle than there are seat belts.
- Never wear seat belts inside out. Belts should not be worn with straps twisted. Doing so may reduce their effectiveness.
- Seatbelts should be adjusted as firmly as possible, consistent with comfort, to provide the protection for which they have been designed. A slack belt will greatly reduce the protection afforded to the wearer.
- Every person who drives or rides in this vehicle should use a seat belt at all times. Children should be properly restrained in the rear seat and, if appropriate, in a child restraint system.
- Do not put the belt behind your back or under your arm. Always route the shoulder belt over your shoulder and across your chest. The belt should be

away from your face and neck, but not falling off your shoulder. Serious injury may occur if a seat belt is not worn properly.

- No modifications or additions should be made by the user which will either prevent the seat belt adjusting devices from operating to remove slack, or prevent the seat belt assembly from being adjusted to remove slack.
- Care should be taken to avoid contamination of the webbing with polishes, oils and chemicals, and particularly battery acid. Cleaning may safely be carried out using mild soap and water. The belt should be replaced if webbing becomes frayed, contaminated or damaged.
- It is essential to replace the entire assembly after it has been worn in a severe impact even if damage to the assembly is not obvious.
- All seat belt assemblies including retractors and attaching hardware should be inspected after any collision by a NISSAN certified LEAF dealer. NISSAN recommends that all seat belt assemblies in use during a collision be replaced unless the collision was minor and the belts show no damage and continue to operate properly. Seat belt assemblies not in use during a collision should also be inspected and, when necessary, replaced if either damage or improper operation is noted.
- Once the pre-tensioner seat belt has activated, it cannot be reused. It must be replaced together with the retractor. Contact a NISSAN certified LEAF dealer.

- Removal and installation of the pre-tensioner seat belt system components should be done by a NISSAN certified LEAF dealer.

CHILD SAFETY



WARNING:

- Infants and children need special protection. The vehicle's seat belts may not fit them properly. The shoulder belt may come too close to the face or neck. The lap belt may not fit over their small hipbones. In an accident, an improperly fitted seat belt could cause serious or fatal injury.
- Always use an appropriate child restraint system.

Children need adults to help protect them. They need to be properly restrained. The proper restraint depends on the child's size.

Infants and small children

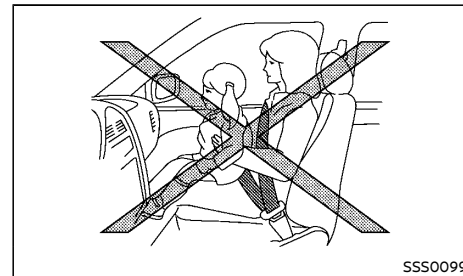

SSS0099

NISSAN recommends that infants and small children be seated in a child restraint system. You should choose a child restraint system that

fits your vehicle and the child, and always follow the manufacturer's instructions for installation and use.

Larger children



WARNING:

- **Never allow children to stand or kneel on any seats.**
- **Never allow children in the luggage area while the vehicle is moving. A child could be seriously injured in an accident or sudden stop.**

Children who are too large for a child restraint system should be seated and restrained by the seat belts that are provided.

If the child's seating position has a shoulder belt that fits close to the face or neck, the use of a booster seat (commercially available) may help overcome this. The booster seat should raise the child so that the shoulder belt is properly positioned across the top, middle portion of the shoulder and the lap belt is low on the hips. The booster seat should also fit the vehicle seat. Once the child has grown so that the shoulder belt is no longer on or near the face or neck of the child, use the shoulder belt without the booster seat. In addition, there are many types of child restraint systems available for larger children that should be used for maximum protection.

PREGNANT WOMEN

NISSAN recommends that pregnant women use seat belts. The seat belt should be worn snug, and always position the lap belt as low as possible around the hips, not the waist. Place the shoulder belt over your shoulder and across your chest. Never put the lap/shoulder belt over your abdominal area. Contact your doctor for specific recommendations.

INJURED PERSONS

NISSAN recommends that injured persons use seat belts. Contact your doctor for specific recommendations.

THREE-POINT TYPE SEAT BELTS

Fastening the seat belts

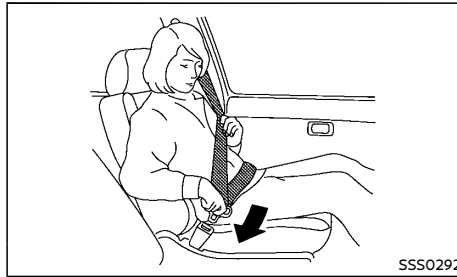

WARNING:

The seatback should not be in a reclined position any more than needed for comfort. Seat belts are most effective when the passenger sits well back and straight up in the seat.

1. Adjust the seat. (See "Seats" (P.1-2).)
2. Slowly pull the seat belt out of the retractor and insert the tongue into the buckle until you hear and feel the latch engage.
 - **The retractor is designed to lock during a sudden stop or on impact. A slow pulling motion permits the belt to move, and allows you some freedom of movement in the seat.**
 - **If the seat belt cannot be pulled from its fully retracted position, firmly pull the belt and release it. Then smoothly pull the belt out of the retractor.**

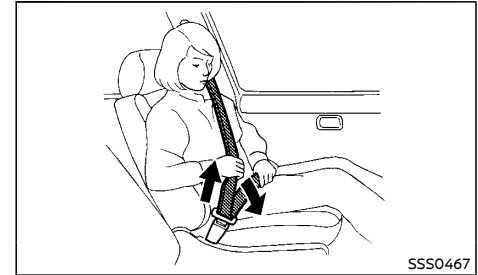

3. Position the lap belt portion low and snug on the hips as shown.
4. Pull the shoulder belt portion toward the retractor to take up extra slack. Be sure the shoulder belt is routed over your shoulder and is snug across your chest.

Shoulder belt height adjustment (for front seats)

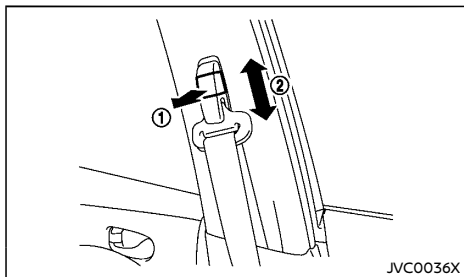

The shoulder belt anchor height should be adjusted to the position that is best for you. See "Precautions on seat belt usage" (P.1-7).

To adjust, pull the adjustment button ①, and then move the shoulder belt anchor to the preferred position ② so that the belt passes over the center of the shoulder. The belt should be away from your face and neck, but not falling off of your shoulder. Release the adjustment button to lock the shoulder belt anchor into position.



WARNING:

- After adjustment, release the adjustment button and then try to move the shoulder belt anchor up and down to make sure that it is securely fixed in position.
- The shoulder belt anchor height should be adjusted to the position that is best for you. Failure to do so may reduce the effectiveness of the entire restraint system and increase the chance or severity of injury in an accident.

Seat belt hooks

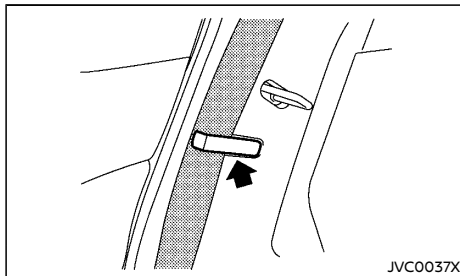

When the rear seat belts are not in use and when folding down the rear seats, hook the rear outer seat belts on the seat belt hooks.

Unfastening the seat belts

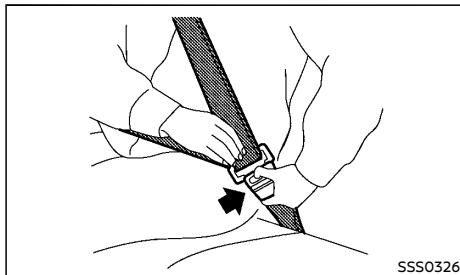

To unfasten the seat belt, push the button on the buckle. The seat belt automatically retracts.

Checking seat belt operation

Seat belt retractors are designed to lock seat belt movement by two separate methods:

- When the belt is pulled quickly from the retractor.
- When the vehicle slows down rapidly.

To increase your confidence in the seat belts, check the operation as follows:

- Grasp the shoulder belt and pull forward quickly. The retractor should lock and restrict further belt movement.

If the retractor does not lock during this check or if you have any questions about seat belt operation, see a NISSAN certified LEAF dealer.

Center of rear seat

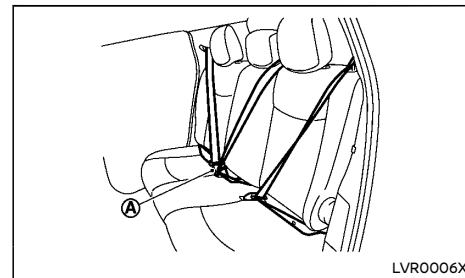

Selecting correct set of seat belts:

The center seat belt buckle is identified by the CENTER mark (A). The center seat belt tongue can be fastened **only** into the center seat belt buckle.

CHILD RESTRAINTS

SEAT BELT MAINTENANCE

- **To clean the seat belt webbing**, apply a mild soap solution or any solution recommended for cleaning upholstery or carpets. Then wipe with a cloth and allow the seat belts to dry in the shade. Do not allow the seat belts to retract until they are completely dry.
- **If dirt builds up in the shoulder belt guide** of the seat belt anchors, the seat belts may retract slowly. Wipe the shoulder belt guide with a clean, dry cloth.
- **Periodically check to see that the seat belt and the metal components**, such as buckles, tongues, retractors, flexible wires and anchors, work properly. If loose parts, deterioration, cuts or other damage on the webbing is found, the entire seat belt assembly should be replaced.

PRECAUTIONS ON CHILD RESTRAINT

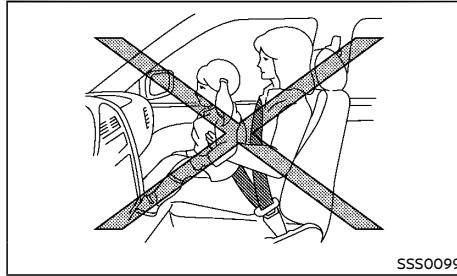

WARNING:

- **Infants and small children should always be placed in an appropriate child restraint while riding in the vehicle.** Failure to use a child restraint can result in serious injury or death.
 - **Infants and small children should never be carried on your lap.** It is not possible for even the strongest adult to resist the forces of a severe accident. The child could be crushed between the adult and parts of the vehicle. Also, do not put the same seat belt around both your child and yourself.
 - **NISSAN recommends that the child restraints be installed in the rear seat.** According to accident statistics, children are safer when properly restrained in the rear seat than in the front seat.
 - **Improper use or improper installation of a child restraint can increase the risk or severity of injury for both the child and other occupants of the vehicle and can lead to serious injury or death in an accident.**
- **Follow all of the child restraint manufacturer's instructions for installation and use.** When purchasing a child restraint, be sure to select one which will fit your child and vehicle. It may not be possible to properly install some types of child restraint in your vehicle.
 - **The direction of the child restraint, either front-facing or rear-facing, depends on the type of the child restraint and the size of the child.** Refer to the child restraint manufacturer's instructions for details.
 - **Adjustable seatbacks should be positioned to ensure full contact between child restraint and seatback.**
 - **After attaching a child restraint, test it before you place the child in it.** Push it from side to side and tug it forward to make sure that it is held securely in place. The child restraint should not move more than 25 mm (1 in). If the restraint is not secure, tighten the seat belt as necessary, or install the restraint in another seat and test it again.
 - **When the child restraint is not in use, keep it secured with the ISOFIX child restraint system or a seat belt to prevent it from being thrown around in case of a sudden stop or accident.**
 - **Never install a rear-facing child restraint on the front passenger's seat when the front passenger's air bag is available.** Supplemental front-impact air bags inflate with great force. A rear-facing child restraint could be struck by the supplemental front-impact air bags in an accident and could seriously injure or kill your child.

- If the seat belt in the position where a child restraint is installed requires a locking device and if it is not used, injuries could result from a child restraint tipping over during normal vehicle braking or cornering.



CAUTION:

Remember that a child restraint left in a closed vehicle can become very hot. Check the seating surface and buckles before placing your child in a child restraint.

NISSAN recommends that infants and small children be seated in a child restraint. You should choose a child restraint that fits your vehicle and always follow the manufacturer's instructions for installation and use. In addition, there are many types of child restraints available for larger children that should be used for maximum protection.

UNIVERSAL CHILD RESTRAINTS FOR FRONT AND REAR SEATS

NOTE:

Universal child restraints approved to UN Regulation No. 44 (UN R44) or UN Regulation No. 129 (UN R129) are clearly marked "Universal".

When selecting any child restraint, keep the following points in mind:

- Choose a child restraint that complies with the UN R44 or UN R129.
- Place your child in the child restraint and check the various adjustments to be sure the child restraint is compatible with your child. Always follow all of the recommended procedures.
- Check the child restraint in your vehicle to be sure it is compatible with vehicle's seat belt system.
- Refer to the tables later in this section for a list of the recommended fitment positions.

Mass group of child seat

Mass group	Child's weight
Group 0	up to 10 kg
Group 0+	up to 13 kg
Group I	9 to 18 kg
Group II	15 to 25 kg
Group III	22 to 36 kg

Kind of child seats (example):

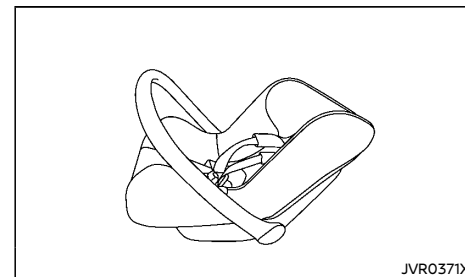

JVR0371X

Child safety seat categories 0 and 0+

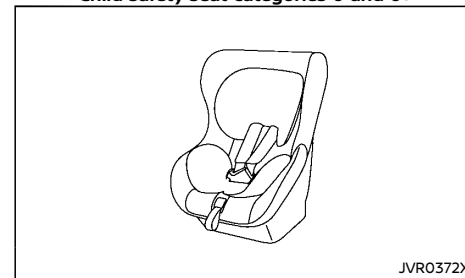

JVR0372X

Child safety seat categories 0+ and I

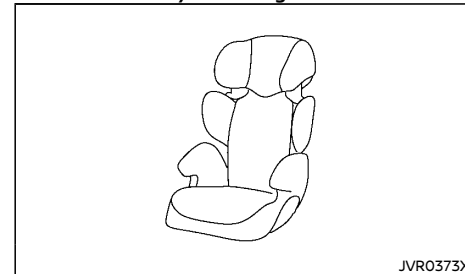

JVR0373X

Child safety seat categories II and III

Selecting the child restraint system for each seating position

A child restraint system that can be used differs according to the seating position.

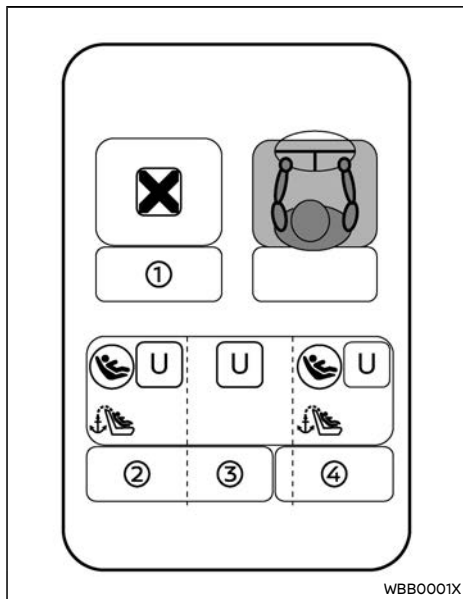

	Suitable for universal category child restraint system (CRS) fixed with the seat belt of the vehicle
	Suitable for ISOFIX child restraint system (CRS)
	Top tether anchorage equipment seats
	Not suitable for attaching a child restraint system

Detailed information for child restraint system installation:

Seat position number	Seating position			
	①	②	③	④
Seating position suitable for universal belted (yes/no)	No	Yes	Yes	Yes
i-Size seating position (yes/no)	No	No	No	No
Seating position suitable for lateral fixture (L1/L2)	—	—	—	—
Largest suitable rearward facing fixture (R1/R2X/R2/R3)	—	R3	—	R3
Largest suitable forward facing fixture (F2X/F2/F3)	—	F3	—	F3
Largest suitable booster fixture (B2/B3)	—	B3	—	B3

Size grade and fixture for ISOFIX child restraints:

Size grade is a classification symbol displayed on a child restraint system. The relationship between size grade and fixture is shown in the following table.

Mass group	Size grade	Fixture	Description
0 (<10 kg)	F	L1	Left lateral facing position child restraint system (Carry-cot*)
	G	L2	Right lateral facing position child restraint system (Carry-cot*)
	E	R1	Rearward facing infant child restraint system
0+ (<13 kg)	E	R1	Rearward facing infant child restraint system
	D	R2	Reduced-size rearward facing toddler child restraint system
	D2	R2X	Reduced-size rearward facing toddler child restraint system (Different shape from R2)
	C	R3	Full-size rearward facing toddler child restraint system
I (9 - 18 kg)	D	D2	Reduced-size rearward facing toddler child restraint system
	D2	R2X	Reduced-size rearward facing toddler child restraint system (Different shape from R2)
	C	R3	Full-size rearward facing toddler child restraint system
	B	F2	Reduced-height forward facing toddler child restraint system
	B1	F2X	Reduced-height forward facing toddler child restraint system (Different shape from F2)
	A	F3	Full-height forward facing toddler child restraint system
II (15 - 25 kg)	—	—	—
III (22 - 36 kg)	—	—	—

*: Carry-cot is one of the child restraint system for infant that can be installed sideways with the child laid.
For details, consult your child restraint system manufacturer or NISSAN certified LEAF dealer.

ISOFIX CHILD RESTRAINT SYSTEM

Your vehicle is equipped with special anchor points that are used with ISOFIX child restraint systems.

ISOFIX lower anchor point locations

The ISOFIX anchor points are provided to install child restraints in the rear outboard seating positions only. **Do not attempt to install a child restraint in the center position using the ISOFIX anchors.**

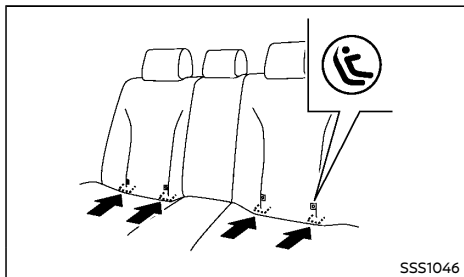

ISOFIX label location

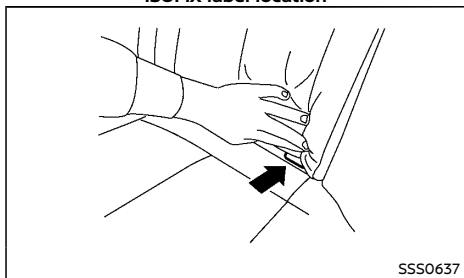

ISOFIX lower anchor location

The ISOFIX anchors are located at the rear of the seat cushion near the seatback. A label is

attached to the seatback to help you locate the ISOFIX anchors.

ISOFIX child restraint anchor attachments

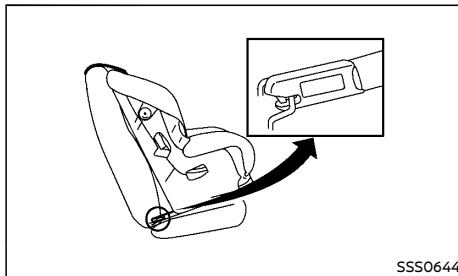

Anchor attachment

ISOFIX child restraints include two rigid attachments that can be connected to two anchors located in the seat. With this system, you do not have to use a vehicle seat belt to secure the child restraint. Check your child restraint for a label stating that it is compatible with the ISOFIX child restraints. This information may also be in the instructions provided by the child restraint manufacturer.

ISOFIX child restraints generally require the use of a top tether strap or other anti-rotation devices such as support legs. When installing ISOFIX child restraints, carefully read and follow the instructions in this manual and those supplied with the child restraints. See "Child restraint installation using ISOFIX" (P.1-16).

CHILD RESTRAINT ANCHORAGE

Your vehicle is designed to accommodate a child restraint system on the rear seat. When installing a child restraint system, carefully read and follow the instructions in this manual and those supplied with the child restraint system.

⚠ WARNING:

- Child restraint anchorages are designed to withstand only those loads imposed by correctly fitted child restraints. Under no circumstances are they to be used for adult seat belts, harnesses or for attaching other items or equipment to the vehicle. Doing so could damage the child restraint anchorages. The child restraint will not be properly installed using the damaged anchorage, and a child could be seriously injured or killed in a collision.
- The child restraint top tether strap may be damaged by contact with the cargo cover (if equipped) or items in the luggage area. Remove the cargo cover from the vehicle or secure it and any luggage. Your child could be seriously injured or killed in a collision if the top tether strap is damaged.

Anchorage location

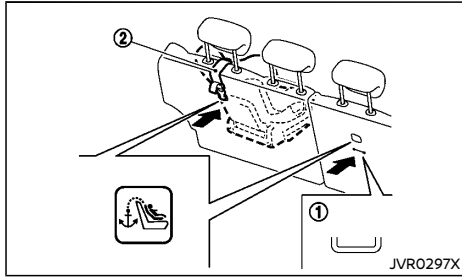

The anchor points ① are located on the back side of the seatbacks for the right and left outboard seating positions of the rear seat.

The child restraint top tether strap ② must be used when installing child restraints with the ISOFIX lower anchor attachments or seat belts.

CHILD RESTRAINT INSTALLATION USING ISOFIX



WARNING:

- **Attach ISOFIX child restraints only at the specified locations. For the ISOFIX lower anchor locations, see "ISOFIX child restraint system" (P.1-15). If a child restraint is not secured properly, your child could be seriously injured or killed in an accident.**
- **Do not install child restraints that require the use of a top tether strap to seating positions that do not have a top tether anchor.**
- **Do not secure a child restraint in the center rear seating position using the ISOFIX lower anchors. The child restraint**

will not be secured properly.

- **Inspect the lower anchors by inserting your fingers into the lower anchor area and feeling to make sure there are no obstructions over the ISOFIX anchors, such as seat belt webbing or seat cushion material. The child restraint will not be secured properly if the ISOFIX anchors are obstructed.**
- **Child restraint anchorages are designed to withstand only those loads imposed by correctly fitted child restraints. Under no circumstances are they to be used for adult seat belts, harnesses or for attaching other items or equipment to the vehicle. Doing so could damage the child restraint anchorages. The child restraint will not be properly installed using the damaged anchorage, and a child could be seriously injured or killed in a collision.**

Installation on rear outboard seats

Front-facing:

Be sure to follow the manufacturer's instructions for the proper use of your child restraint. Follow these steps to install a front-facing child restraint on the rear outboard seats using ISOFIX:

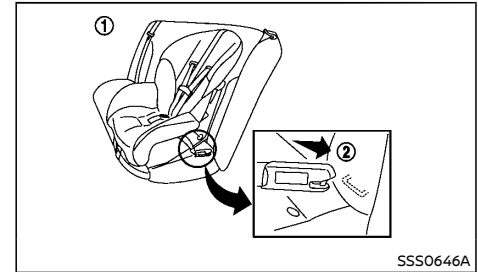

Front-facing: Steps 1 and 2

1. Position the child restraint on the seat ①.
2. Secure the child restraint anchor attachments to the ISOFIX lower anchors ②.
3. The back of the child restraint should be secured against the vehicle seatback. If necessary, adjust or remove the head restraint to obtain the correct child restraint fit. See "Head restraints" (P.1-5). If the head restraint is removed, store it in a secure place. Be sure to install the head restraint when the child restraint is removed. If the seating position does not have an adjustable head restraint and it is interfering with the proper child restraint fit, try another seating position or a different child restraint.

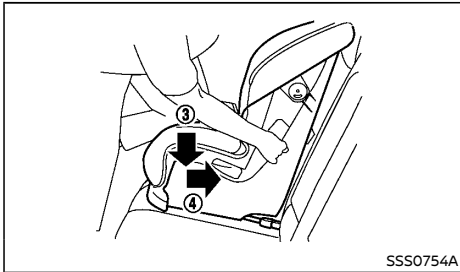

Front-facing: Step 4

4. Shorten the rigid attachment to have the child restraint firmly tightened; press downward ③ and rearward ④ firmly in the center of the child restraint with your knee to compress the vehicle seat cushion and seatback.
5. If the child restraint is equipped with a top tether strap, route the top tether strap and secure the tether strap to the tether anchor point. See "Child restraint anchorage" (P.1-15).
6. If the child restraint is equipped with other anti-rotation devices such as support legs, use them instead of the top tether strap following the child restraint manufacturer's instructions.

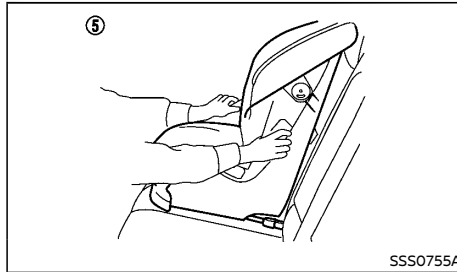

Front-facing: Step 7

7. Test the child restraint before you place the child in it ⑤. Push the child restraint from side to side and tug it forward to make sure that it is held securely in place.
8. Check to make sure that the child restraint is properly secured prior to each use. If the child restraint is loose, repeat steps 3 through 7.

Rear-facing:

Be sure to follow the manufacturer's instructions for the proper use of your child restraint. Follow these steps to install a rear-facing child restraint on the rear outboard seats using ISOFIX:

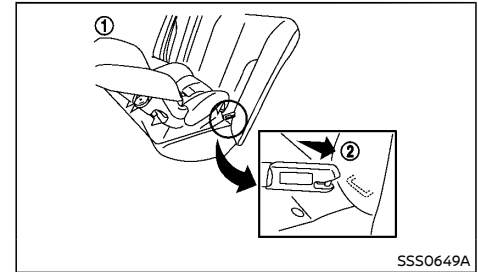

Rear-facing: Steps 1 and 2

1. Position the child restraint on the seat ①.
2. Secure the child restraint anchor attachments to the ISOFIX lower anchors ②.

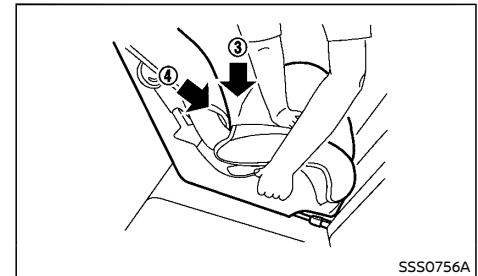

Rear-facing: Step 3

3. Shorten the rigid attachment to have the child restraint firmly tightened; press downward ③ and rearward ④ firmly in the center of the child restraint with your hand to compress the vehicle seat cushion and seatback.
4. If the child restraint is equipped with a top tether strap, route the top tether strap and secure the tether strap to the tether anchor point. See "Child restraint anchorage" (P.1-15).

- If the child restraint is equipped with other anti-rotation devices such as support legs, use them instead of the top tether strap following the child restraint manufacturer's instructions.

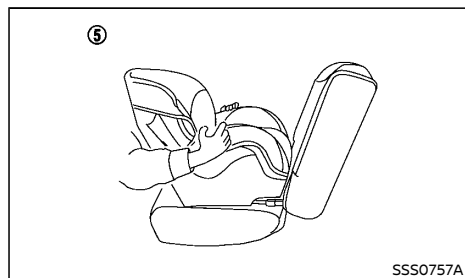

Rear-facing: Step 6

SSS0757A

- Test the child restraint before you place the child in it ⑤. Push the child restraint from side to side and tug it forward to make sure that it is held securely in place.
- Check to make sure that the child restraint is properly secured prior to each use. If the child restraint is loose, repeat steps 3 through 6.

CHILD RESTRAINT INSTALLATION USING THREE-POINT TYPE SEAT BELT

Installation on rear seats

Be sure to follow the manufacturer's instructions for the proper use of your child restraint. Follow these steps to install a front-facing child restraint on the rear seats using three-point type seat belt without automatic locking mode:

Front-facing:

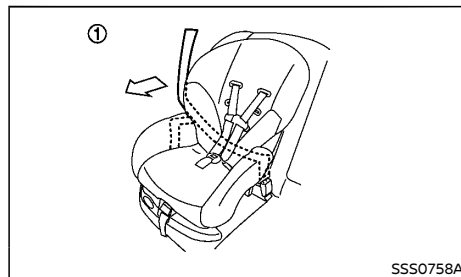

Front-facing: Step 1

SSS0758A

- Position the child restraint on the seat ①.

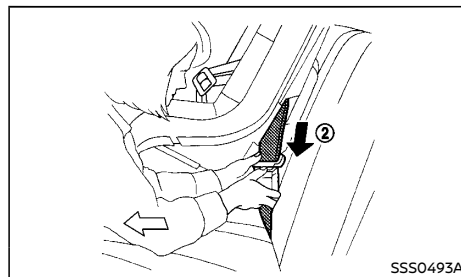

Front-facing: Step 2

SSS0493A

- Route the seat belt tongue through the child restraint and insert it into the buckle ② until you hear and feel the latch engage.
- To prevent slack in the seat belt webbing, it is necessary to secure the seat belt in place with locking devices attached to the child restraint.

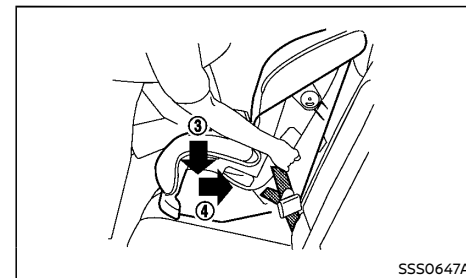

SSS0647A

Front-facing: Step 4

- Remove any additional slack from the seat belt; press downward ③ and rearward ④ firmly in the center of the child restraint with your knee to compress the vehicle seat cushion and seatback while pulling up on the seat belt.

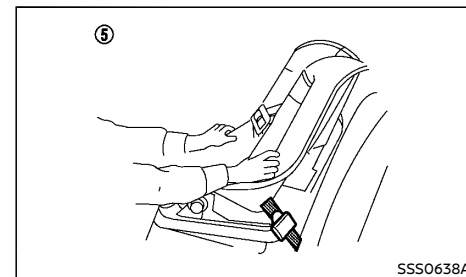

Front-facing: Step 5

SSS0638A

5. Test the child restraint before you place the child in it ⑤. Push the child restraint from side to side and tug it forward to make sure that it is held securely in place.
6. Check to make sure that the child restraint is properly secured prior to each use. If the child restraint is loose, repeat steps 3 through 5.

Rear-facing:

Be sure to follow the manufacturer's instructions for the proper use of your child restraint. Follow these steps to install a rear-facing child restraint on the rear seats using three-point type seat belt without automatic locking mode:

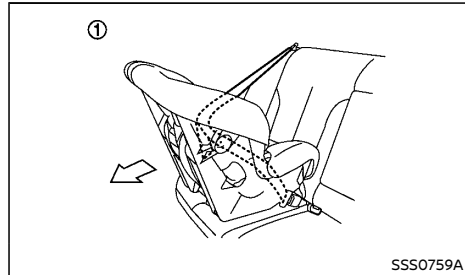

Rear-facing: Step 1

1. Position the child restraint on the seat ①.

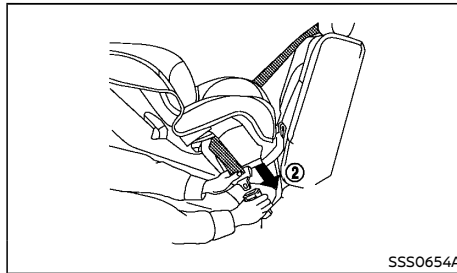

Rear-facing: Step 2

2. Route the seat belt tongue through the child restraint and insert it into the buckle ② until you hear and feel the latch engage.
3. To prevent slack in the seat belt webbing, it is necessary to secure the seat belt in place with locking devices attached to the child restraint.

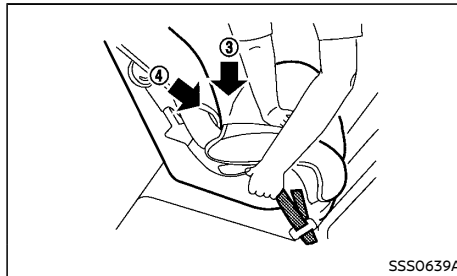

Rear-facing: Step 4

4. Remove any additional slack from the seat belt; press downward ③ and rearward ④ firmly in the center of the child restraint with your hand to compress the vehicle seat cushion and seatback while pulling up on the seat belt.

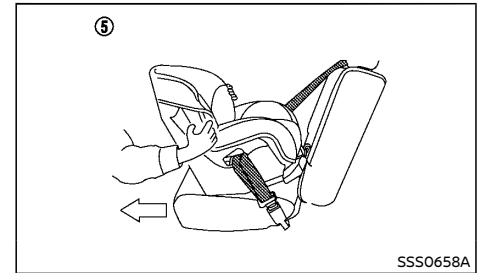

Rear-facing: Step 5

5. Test the child restraint before you place the child in it ⑤. Push the child restraint from side to side and tug it forward to make sure that it is held securely in place.
6. Check to make sure that the child restraint is properly secured prior to each use. If the child restraint is loose, repeat steps 3 through 5.

Installation on front passenger's seat

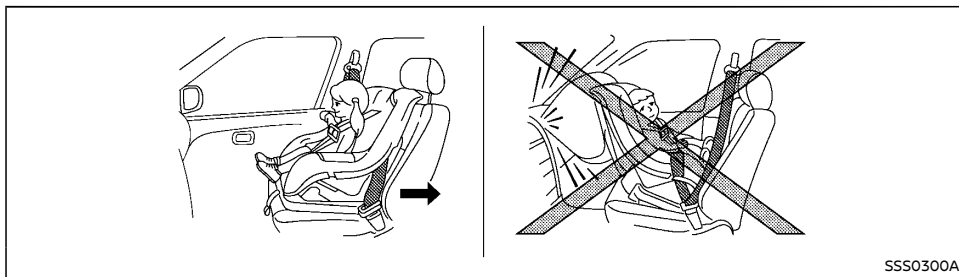

WARNING:

- Never install a rear-facing child restraint on the front passenger's seat when the front passenger's air bag is available. Supplemental front-impact air bags inflate with great force. A rear-facing child restraint could be struck by the supplemental front-impact air bags in an accident and could seriously injure or kill your child.
- Never install a child restraint with a top tether strap on the front seat.
- NISSAN recommends that a child restraint be installed on the rear seat. However, if you must install a child restraint on the front passenger's seat, move the passenger's seat to the rearmost position.
- Child restraints for infants must be used in the rear-facing direction and therefore must not be used on the front passenger's seat when the front passenger's air bag is available.

- Failure to use the seat belts will result in the child restraint not being properly secured. It could tip over or otherwise be unsecured and cause injury to the child in a sudden stop or collision.

Front-facing:

Be sure to follow the manufacturer's instructions for the proper use of your child restraint. Follow these steps to install a front-facing child restraint on the front passenger's seat using three-point type seat belt without automatic locking mode:

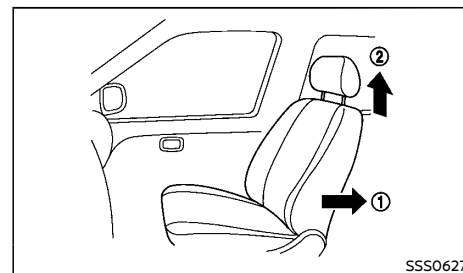

Steps 1 and 2

1. Move the seat to the rearmost position ①.
2. Adjust the head restraint to its highest position ②.
3. Position the child restraint in the seat.

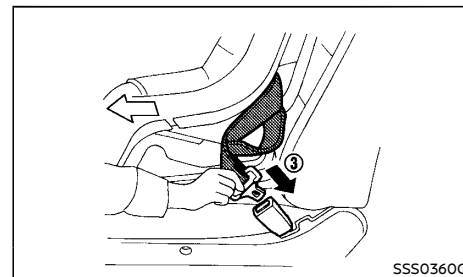

Step 4

4. Route the seat belt tongue through the child restraint and insert it into the buckle ③ until you hear and feel the latch engage.
5. To prevent slack in the seat belt webbing, it is necessary to secure the seat belt in place with locking devices attached to the child restraint.

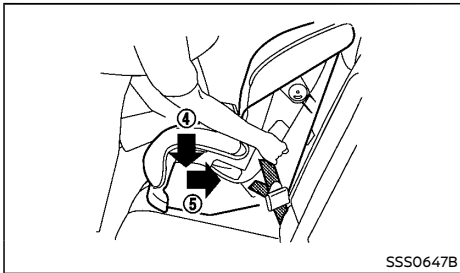

Step 6

6. Remove any additional slack from the seat belt; press downward ④ and rearward ⑤ firmly in the center of the child restraint with your knee to compress the vehicle seat cushion and seatback while pulling up on the seat belt.

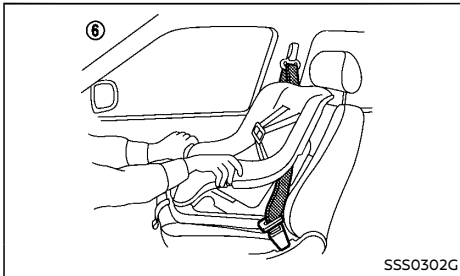

Step 7

7. Test the child restraint before you place the child in it ⑥. Push the child restraint from side to side and tug it forward to make sure that it is held securely in place.
8. Check to make sure that the child restraint is properly secured prior to each use. If the child restraint is loose, repeat steps 5 through 7.

SUPPLEMENTAL RESTRAINT SYSTEM (SRS)

PRECAUTIONS ON SUPPLEMENTAL RESTRAINT SYSTEM (SRS)

This Supplemental Restraint System (SRS) section contains important information concerning the driver's and passenger's supplemental front impact air bags, supplemental side-impact air bags, supplemental curtain side-impact air bags and pre-tensioner seat belts.

Supplemental front-impact air bag system

This system can help cushion the impact force to the head and chest area of the driver and/or front passenger in certain frontal collisions. The supplemental front-impact air bag is designed to inflate on the front where the vehicle is impacted.

Supplemental side-impact air bag system (if equipped)

This system can help cushion the impact force to the chest and pelvis areas of the driver and front passenger in certain side-impact collisions. The supplemental side-impact air bag is designed to inflate on the side where the vehicle is impacted.

Supplemental curtain side-impact air bag system (if equipped)

This system can help cushion the impact force to the head of the driver and passengers in front and rear outboard seating positions in certain side-impact collisions. The supplemental curtain side-impact air bag is designed to inflate on the side where the vehicle is impacted.

The SRS is designed to **supplement** the accident protection provided by the driver's and passenger's seat belts and **is not** designed to

substitute for them. The SRS can help save lives and reduce serious injuries. However, inflating air bags may cause abrasions or other injuries. Air bags do not provide protection to the lower body. Seat belts should always be correctly worn and the occupants should always be seated a suitable distance away from the steering wheel and instrument panel. (See "Seat belts" (P.1-7).) The air bags inflate quickly in order to help protect the occupants. The force of the air bags inflating can increase the risk of injury if the occupants are too close to, or are against, the air bag modules during inflation.

The air bags will deflate quickly after deployment.

The SRS operates only when the power switch is in the ON position.

When the power switch is in the ON position, the SRS air bag warning light illuminates for about 7 seconds and then turns off. This indicates that the SRS is operational. (See "SRS air bag warning light" (P.1-26).)

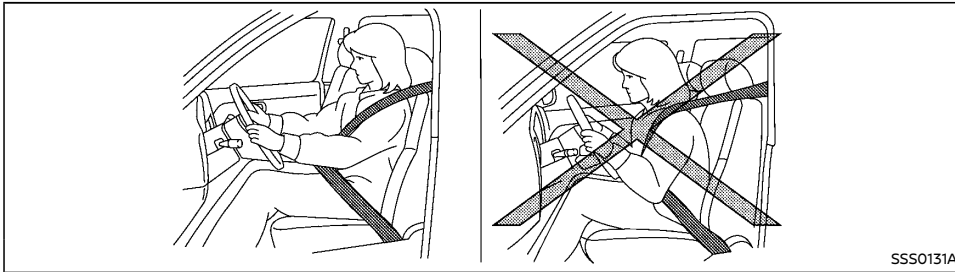

SSS0131A

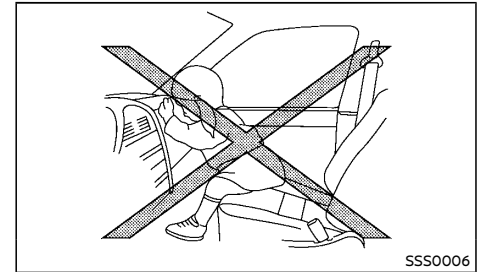

SSS0006

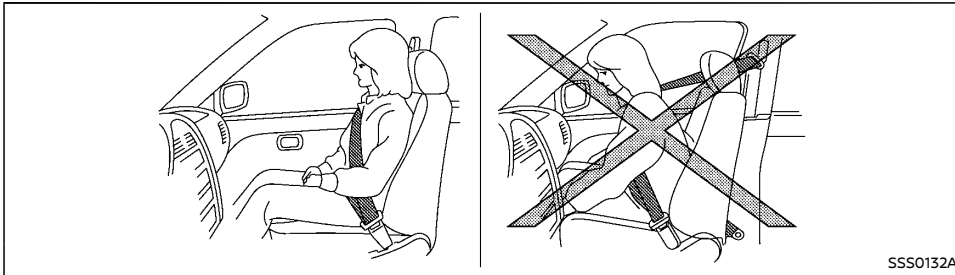

SSS0132A

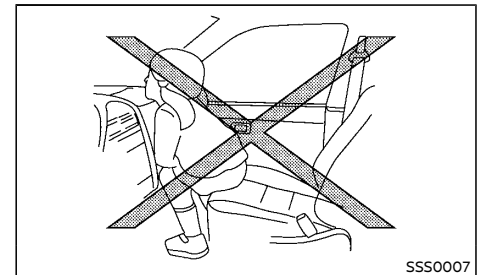

SSS0007



WARNING:

- The supplemental front-impact air bags ordinarily will not inflate in the event of a side impact, rear impact, rollover, or lower severity frontal collision. Always wear the seat belts to help reduce the risk or severity of injury in accidents.
- The seat belts and the supplemental front-impact air bags are most effective when you are sitting well back and upright in the seat. The front-impact air bags inflate with great force. If you and your passengers are unrestrained, leaning forward, sitting sideways, or out of

position in any way, you and your passengers are at greater risk of injury or death in an accident. You and your passengers may also receive serious or fatal injuries from the supplemental front-impact air bag if you are up against it when it inflates. Always sit back against the seatback and as far away as practical from the steering wheel or instrument panel. Always use the seat belts.

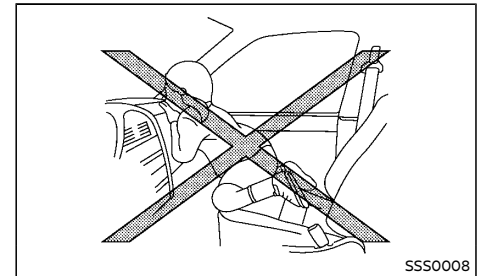

SSS0008

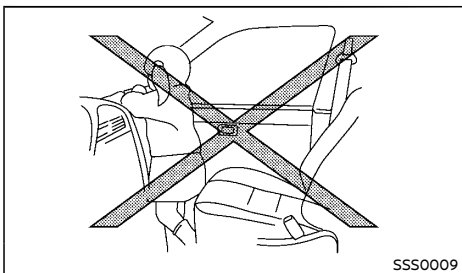

⚠ WARNING:

- Never let children ride unrestrained or extend their hands or face out of the window. Do not attempt to hold them in your lap or arms. Some examples of dangerous riding positions are shown in the illustrations.
- Children may be severely injured or killed when the air bags inflate if they are not properly restrained.
- Never install a rear-facing child restraint system in the front seat. An inflating supplemental front-impact air bag could seriously injure or kill your child. (See "Child restraints" (P.1-11).)

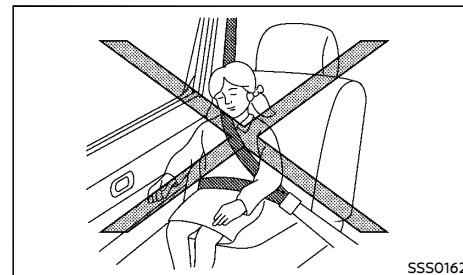
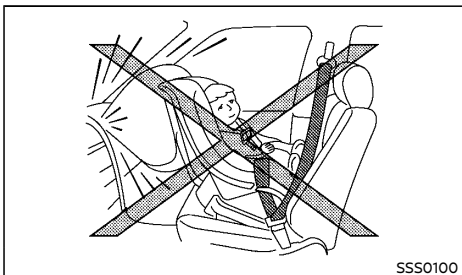
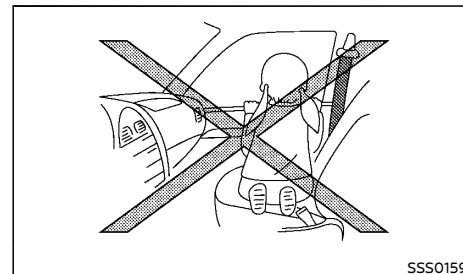
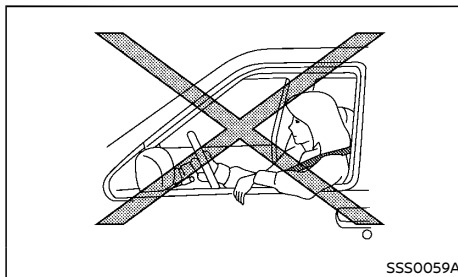
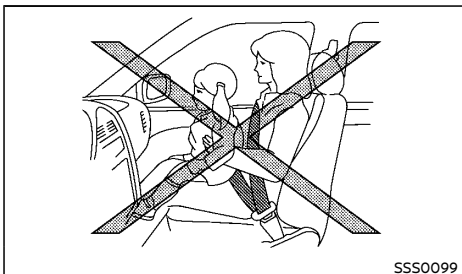
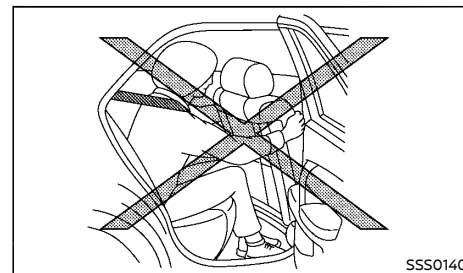



WARNING:

- The supplemental side-impact air bags (if equipped) and supplemental curtain side-impact air bags (if equipped) ordinarily will not inflate in the event of a front impact, rear impact, rollover, or lower severity side collision. Always wear the seat belts to help reduce the risk or severity of injury in accidents.
- The seat belts and the supplemental side-impact air bags and supplemental curtain side-impact air bags are most effective when you are sitting well back and upright in the seat. The supplemental side-impact air bags and supplemental curtain side-impact air bags inflate with great force. If you and your passengers are unrestrained, leaning forward, sitting sideways, or out of position in any way, you and your passengers are at greater risk of injury or death in an accident.
- Do not allow anyone to place their hands, legs, or face near the supplemental side-impact air bags and supplemental curtain side-impact air bags on the sides of the seatback of the front seats or near the side roof rails. Do not allow anyone sitting in the front seats or rear outboard seats to extend their hands out of the windows or lean against the doors. Some examples of dangerous riding positions are shown in the illustrations.
- When sitting in the rear seats, do not hold onto the seatback of the front seats. If the supplemental side-impact air bags and supplemental curtain side-impact air bags inflate, you may be seriously injured. Be especially careful with children, who should always be properly re-

strained.

- Do not use seat covers on the front seatbacks. They may interfere with the supplemental side-impact air bag inflations.

Pre-tensioner seat belt system

The pre-tensioner seat belt system may activate with the supplemental air bag system in certain types of collisions.

Working with the seat belt retractor and anchor (driver's side), it helps tighten the seat belt the instant the vehicle becomes involved in certain types of collisions, helping to restrain the occupants. (See "Pre-tensioner seat belt system" (P.1-30).)

Air bag warning label

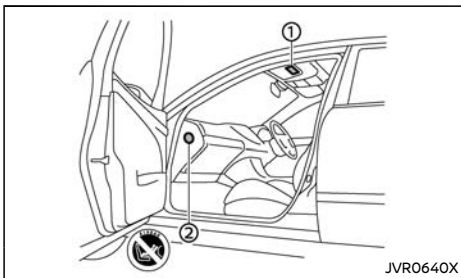

Warning labels about the supplemental front-impact air bag system are placed in the vehicle as shown in the illustration.

SRS air bag:

The warning label ① is located on the surface of the passenger's sun visor.

SRS front-impact passenger air bag:

The warning label ② is located on the side of the passenger's side instrument panel.

This label warns you not to fit a rear-facing child restraint system on the front passenger seat as such a restraint system used in this position could cause serious injury to the infant in case of air bag deployment during a collision.



① Air bag warning label

The label warns:

"NEVER use a rearward facing child restraint on a seat protected by an ACTIVE AIRBAG in front of it, DEATH or SERIOUS INJURY to the CHILD can occur."

In vehicles equipped with a front-impact passenger air bag system, use a rear-facing child restraint system only on the rear seats.

When installing a child restraint system in your vehicle, always follow the child restraint system manufacturer's instructions for installation. For additional information, see "Child restraints" (P.1-11).

SRS air bag warning light



The SRS air bag warning light, displaying  in the instrument panel, monitors the circuits for the air bag systems, pre-tensioner seat belt systems and all related wiring.

When the power switch is in the ON or READY to drive position, the SRS air bag warning light illuminates for about 7 seconds and then turns off. This indicates that the SRS air bag systems are operational.

If any of the following conditions occur, the air bag and/or pre-tensioner seat belt systems need servicing:

- The SRS air bag warning light remains on after approximately 7 seconds.
- The SRS air bag warning light does not illuminate at all.

Under these conditions, the air bag systems and/or pre-tensioner seat belt systems may not operate properly. They must be checked and repaired. Contact a NISSAN certified LEAF dealer immediately.

SUPPLEMENTAL AIR BAG SYSTEMS

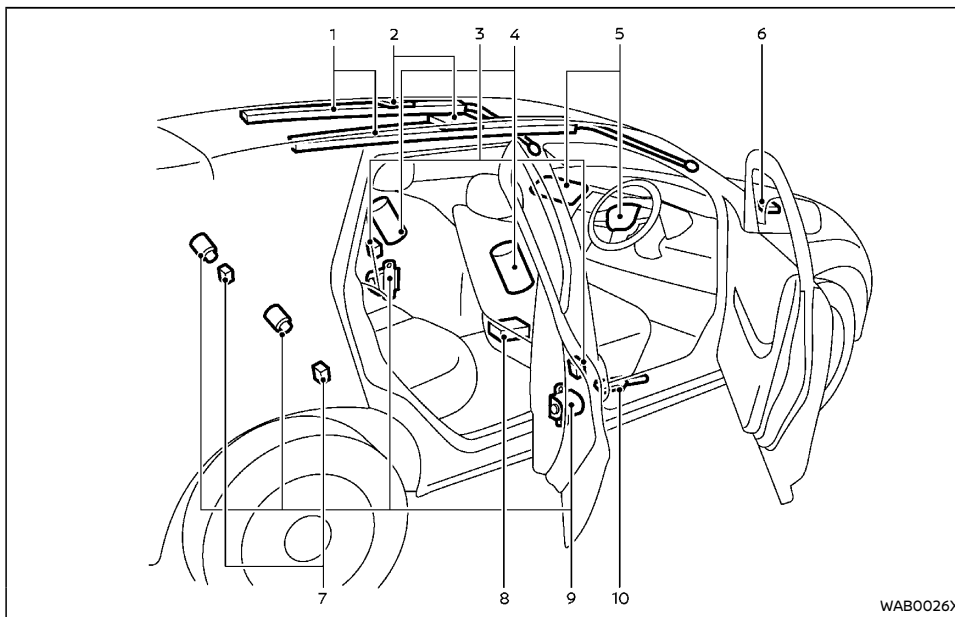

1. Supplemental curtain side-impact air bag modules (if equipped)
2. Supplemental curtain side-impact air bag inflators (if equipped)
3. Satellite sensors
4. Supplemental side-impact air bag modules
5. Supplemental front-impact air bag modules
6. Crash zone sensor
7. Satellite sensors (if equipped)
8. Air bag Control Unit (ACU)
9. Pre-tensioner seat belt retractors
10. Lap outer pre-tensioner (driver's side)



WARNING:

- Do not place any objects on the steering wheel pad or on the instrument panel, and near the front door finishers or the front seats. Such objects may become dangerous projectiles and cause injury if a supplemental air bag inflates.
- Do not place any objects between any occupant and the steering wheel or instrument panel. Also, do not place any objects between the front door finishers and the front seats. Such objects may become dangerous projectiles and cause injury if a supplemental air bag inflates.
- Immediately after inflation, several supplemental air bag system components will be hot. Do not touch them: you may severely burn yourself.
- No unauthorized changes should be made to any components or wiring of the supplemental air bag systems. This is to prevent accidental inflation of the supplemental air bags or damage to the supplemental air bag systems.
- Do not make unauthorized changes to your vehicle's electrical system, suspension system, front end structure or side panels. This could affect proper operation of the supplemental air bag systems.
- Tampering with the supplemental air bag systems may result in serious personal injury. Tampering includes changes to the steering wheel and the instrument panel by placing materials over the steering wheel pad and above, around or on the instrument panel or by installing additional trim materials around the supplemental air bag systems.

- Work around and on the supplemental air bag systems should be done by a NISSAN certified LEAF dealer. The SRS wiring should not be modified or disconnected. Unauthorized electrical test equipment and probing devices should not be used on the supplemental air bag systems.
- The SRS wiring harness connectors are yellow and/or orange for easy identification.

When the air bags inflate, a fairly loud noise may be heard, followed by the release of smoke. This smoke is not harmful and does not indicate a fire. Care should be taken not to inhale it, as it may cause irritation and choking. Those with a history of a breathing condition should get fresh air promptly.

Supplemental front-impact air bag system

The driver's supplemental front-impact air bag is located at the center of the steering wheel. The passenger's supplemental front-impact air bag is located at the instrument panel above the glove box.

The supplemental front-impact air bag system is designed to inflate in higher severity frontal collisions, although it may inflate if the forces in another type of collision are similar to those of a higher severity frontal impact. It may not inflate in certain frontal collisions. Vehicle damage (or lack of it) is not always an indication of proper supplemental front-impact air bag system operation.

Supplemental side-impact air bag system (if equipped)

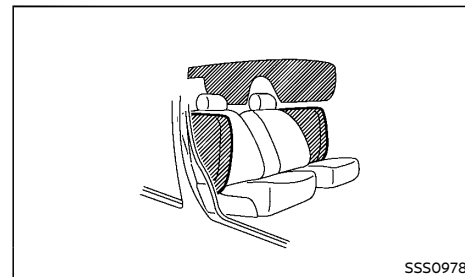

The supplemental side-impact air bag is located at the outside of the front seats' seat-backs.

The supplemental side-impact air bag system is designed to inflate in higher severity side collisions, although it may inflate if the forces in another type of collision are similar to those of a higher severity side impact. It may not inflate in certain side collisions. Vehicle damage (or lack of it) is not always an indication of proper supplemental side-impact air bag system operation.

Supplemental curtain side-impact air bag system (if equipped)

The supplemental curtain side-impact air bag is located at the roof rails.

The supplemental curtain side-impact air bag system is designed to inflate in higher severity side collisions, although it may inflate if the forces in another type of collision are similar to those of a higher severity side impact. It may not inflate in certain side collisions. Vehicle damage (or lack of it) is not always an indication of proper supplemental curtain side-im-

pact air bag system operation.

SRS AIR BAG DEPLOYMENT CONDITIONS

The SRS air bags activate in the event of a front or side impact in which the vehicle occupants may be severely injured even if they are wearing the seat belts properly.

They may not activate when the crash energy is absorbed and/or distributed by the vehicle body. Vehicle damage (or lack of it) is not always an indication of proper SRS air bag system operation.

When the SRS air bag will deploy

Supplemental front-impact air bag system:

The supplemental front-impact air bag system is designed to inflate in higher severity frontal collisions. Some examples are shown in the following illustrations.

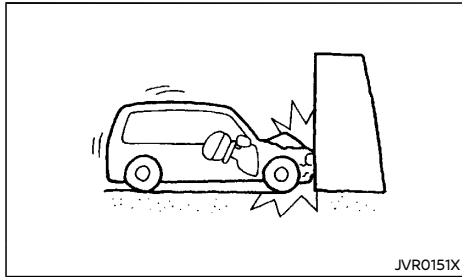

The supplemental front-impact air bag system will deploy in the event of an impact which exceeds a 25 km/h (16 MPH) frontal collision with a solid wall that does not move or deform. The supplemental front-impact air bag system may also deploy when the vehicle receives

severe damage to the undercarriage.

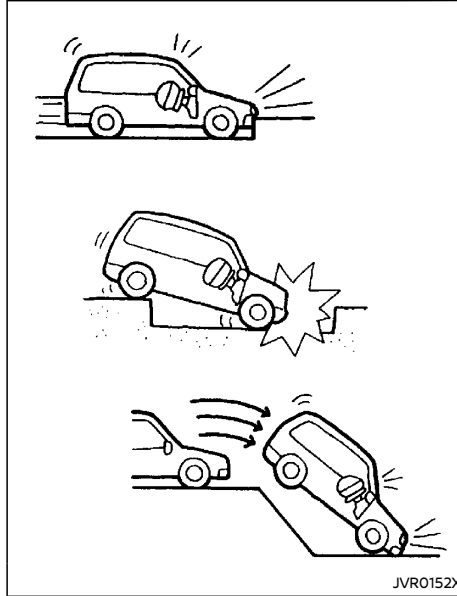

- Hitting a curb, pavement edge or hard surface at high speed
- Falling into a deep hole or ditch
- Landing hard on the ground after jumping

Supplemental side-impact and curtain side-impact air bags (if equipped):

The supplemental side-impact and curtain side-impact air bag systems are designed to inflate in higher severity side collisions. Some examples are shown in the following illustrations.

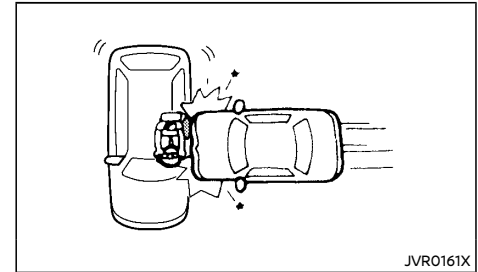

(supplemental side-impact air bag system)

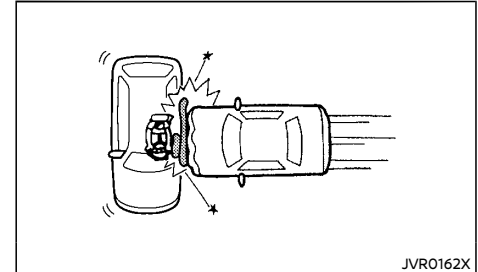

(supplemental curtain side-impact air bag system)

- The supplemental side-impact and curtain side-impact air bags will deploy in the event of a side impact with a normal passenger vehicle that exceeds at a speed of 25 km/h (16 MPH).

When the SRS air bag is unlikely to deploy

The SRS air bags may not deploy in cases where the impact is not forceful enough to inflate the SRS air bags.

For example, if the vehicle strikes an object, such as a parked vehicle or sign pole, which can move or deform on impact, the SRS air bags are

unlikely to deploy.

Supplemental front-impact air bag system:

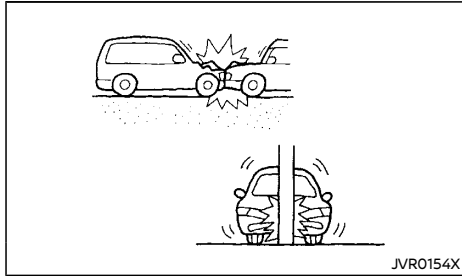

- Striking a vehicle of the same class that is parked
- Crashing into a solid utility pole

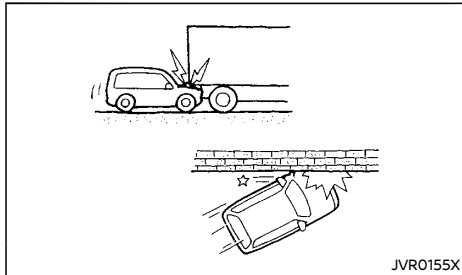

- Running under the tail gate of a truck
- A frontal offset impact to the guard rails

Supplemental side-impact and curtain side-impact air bags (if equipped):

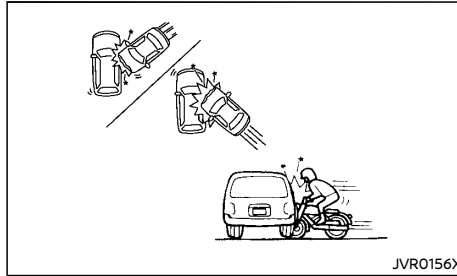

- A collision from the side at an angle
- A side impact with a two-wheeled vehicle

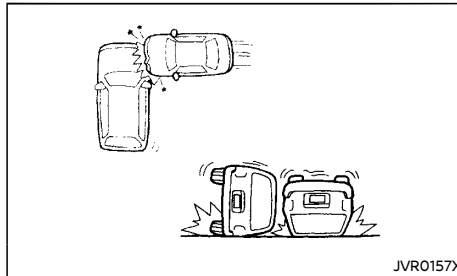

- A collision from the side impacting the vehicle motor room (luggage room)
- Vehicle rollover

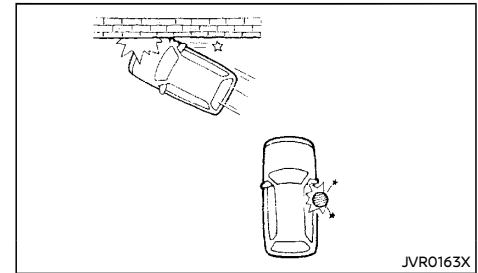

- A frontal offset impact to the guard rails
- A collision with a pole

When the SRS air bag will not deploy

Once the SRS air bag has inflated, the air bag module will not function again if your vehicle collides with another vehicle or an object.

Other examples where the SRS air bag will not deploy are shown in the following illustrations.

Supplemental front-impact air bag system:

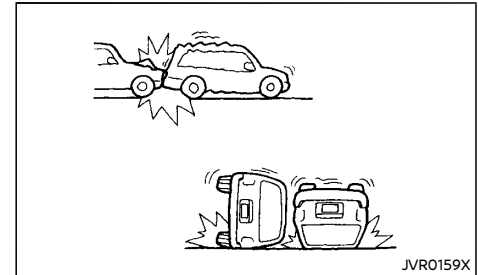

- A collision from the side or rear
- Vehicle rollover

Supplemental side-impact and curtain side-impact air bags (if equipped):

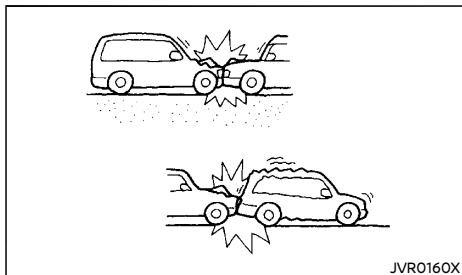

- A frontal collision with a parked or moving vehicle
- A rear collision

PRE-TENSIONER SEAT BELT SYSTEM

WARNING:

- **The pre-tensioner seat belt cannot be reused after activation. It must be replaced together with the retractor and buckle as a unit.**
- **If the vehicle becomes involved in a collision but the pre-tensioner is not activated, be sure to have the pre-tensioner system checked and, if necessary, replaced by a NISSAN certified LEAF dealer.**
- **No unauthorized changes should be made to any components or wiring of the pre-tensioner seat belt system. This is to prevent accidental activation of the pre-tensioner seat belt or damage to the pre-tensioner seat belt system.**

- **Work around or on the pre-tensioner seat belt system should be done by a NISSAN certified LEAF dealer. The SRS wiring should not be modified or disconnected. Unauthorized electrical test equipment and probing devices should not be used on the pre-tensioner seat belt system.**
- **If you need to dispose of the pre-tensioner seat belt system, or scrap the vehicle, contact a NISSAN certified LEAF dealer. Correct pre-tensioner disposal procedures are set forth in the appropriate NISSAN Service Manual. Incorrect disposal procedures could cause personal injury.**

The pre-tensioner seat belt system may activate with the supplemental air bag system in certain types of collisions.

Working with the seat belt retractor, it helps tighten the seat belt when the vehicle becomes involved in certain types of collisions, helping to restrain front seat occupants.

The pre-tensioner is encased with the front seat belt's retractor and anchor. These seat belts are used the same as conventional seat belts.

When the pre-tensioner seat belt activates, a fairly loud noise may be heard, followed by the release of smoke. This smoke is not harmful and does not indicate a fire. Care should be taken not to inhale it, as it may cause irritation and choking. Those with a history of a breathing condition should get fresh air promptly.

REPAIR AND REPLACEMENT PROCEDURE

WARNING:

- **Once the air bags have been inflated, the air bag modules will not function and must be replaced. The air bag modules must be replaced by a NISSAN certified LEAF dealer. The inflated air bag modules cannot be repaired.**
- **The air bag systems should be inspected by a NISSAN certified LEAF dealer if there is any damage to the front end or side portion of the vehicle.**
- **If you need to dispose of the SRS or scrap the vehicle, contact a NISSAN certified LEAF dealer. Correct disposal procedures are set forth in the appropriate NISSAN Service Manual. Incorrect disposal procedures could cause personal injury.**

The air bags are designed to activate on a one-time-only basis. As a reminder, unless the SRS air bag warning light is damaged, the SRS air bag warning light remains illuminated after inflation has occurred. The repair and replacement of the SRS should be done only by a NISSAN certified LEAF dealer.

When maintenance work is required on the vehicle, information about the air bags and related parts should be pointed out to the person performing the maintenance. The power switch should always be in the LOCK position when working under the hood or inside the vehicle.

2 Instruments and controls

Cockpit	2-2	Headlight aiming control	2-32
Instrument panel	2-3	Battery saver system	2-33
Meters and gauges	2-4	Turn signal switch	2-33
Speedometer	2-4	Emblem light (if equipped)	2-33
Odometer/Twin trip odometer	2-5	Fog light switch (if equipped)	2-34
Power meter	2-5	Front fog lights (if equipped)	2-34
Driving range	2-6	Rear fog light (if equipped)	2-34
Li-ion battery available charge gauge	2-6	Wiper and washer switch	2-34
Shift position indicator	2-6	Windshield wiper and washer switch	2-34
ECO mode indicator	2-7	Rear window wiper and washer switch	2-35
e-Pedal system indicator	2-7	Defogger switch	2-36
Outside air temperature	2-7	Horn	2-36
Clock	2-7	Windows	2-36
Instrument brightness control	2-7	Power windows	2-36
Warning lights, indicator lights and audible reminders	2-8	Power outlet	2-38
Checking lights	2-9	Storage	2-38
Warning lights	2-9	Glove box	2-38
Indicator lights	2-12	Cup holders	2-38
Audible reminders	2-14	Console box	2-39
Vehicle information display	2-15	Cargo cover (if equipped)	2-39
How to use the vehicle information display	2-15	Stowing golf bags	2-40
Startup display	2-15	EVSE (Electric Vehicle Supply Equipment) (if equipped) storage net	2-41
Settings	2-15	Sun visors	2-41
Vehicle information display warnings and indicators	2-21	Interior lights	2-41
Trip computer	2-26	Map lights	2-41
Timer display	2-29	Map light control switch	2-42
ECO Drive Report	2-30	Room light	2-42
Headlight and turn signal switch	2-30	Cargo light	2-42
Headlight switch	2-30	Battery saver system	2-42

COCKPIT

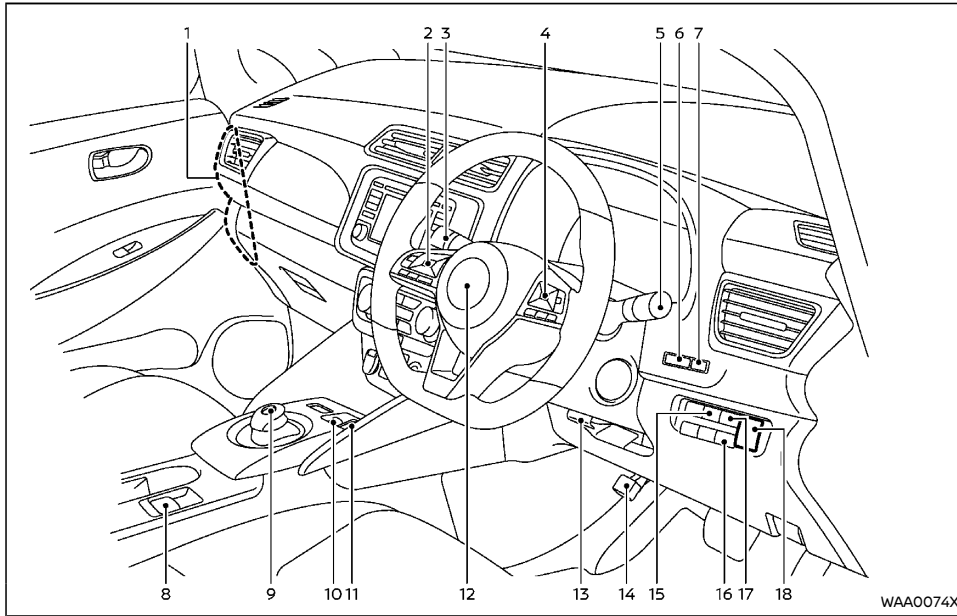

1. Fuse box cover
2. Steering-wheel-mounted controls (left side)
 - Vehicle information display control
 - Audio control*
3. Wiper and washer switch
4. Steering-wheel-mounted controls (right side)
 - Bluetooth® Hands-Free Phone System control*
 - Voice recognition system switch*
5. Headlight and turn signal switch/Fog light switch*
6. Instrument brightness control switch
7. TRIP/RESET switch for twin trip odometer
8. Parking brake (switch type)*
9. Shift lever/P position switch
10. e-Pedal switch

11. ECO mode switch
 12. Steering wheel
 - Electric power steering
 - Horn
 - Driver's supplemental front-impact air bag
 13. Tilting steering wheel lock lever
 14. Parking brake (pedal type)*
 15. Immediate charge switch
 16. Intelligent Lane intervention switch*
 17. Charge port lid opener switch
 18. Headlight aiming control*
- *: if equipped

INSTRUMENT PANEL

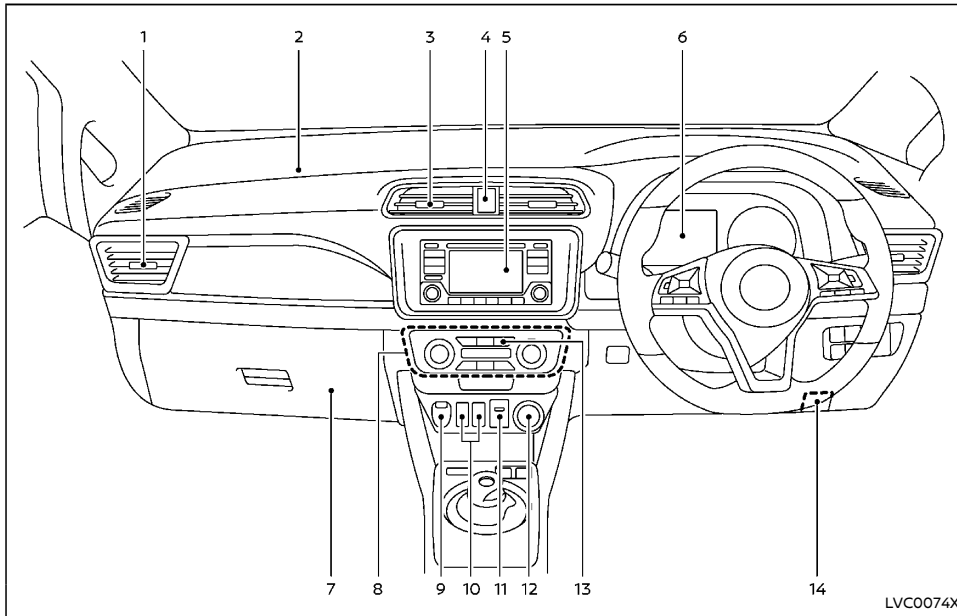

- | | |
|--|---|
| 1. Side ventilator | 6. Meters and gauges |
| 2. Front passenger's supplemental front-impact air bag | 7. Glove box |
| 3. Center ventilator | 8. Climate control (heater and air conditioner control) |
| 4. Hazard warning flasher switch | 9. Power outlet |
| 5. Audio system* | 10. Front heated seat switches |
| – Intelligent Around View Monitor* | 11. USB connection port*/Auxiliary input jack* |
| – Bluetooth® Hands-Free Phone System* | 12. Power switch |

13. Rear window defogger switch

14. Hood lock release handle

*: if equipped

METERS AND GAUGES

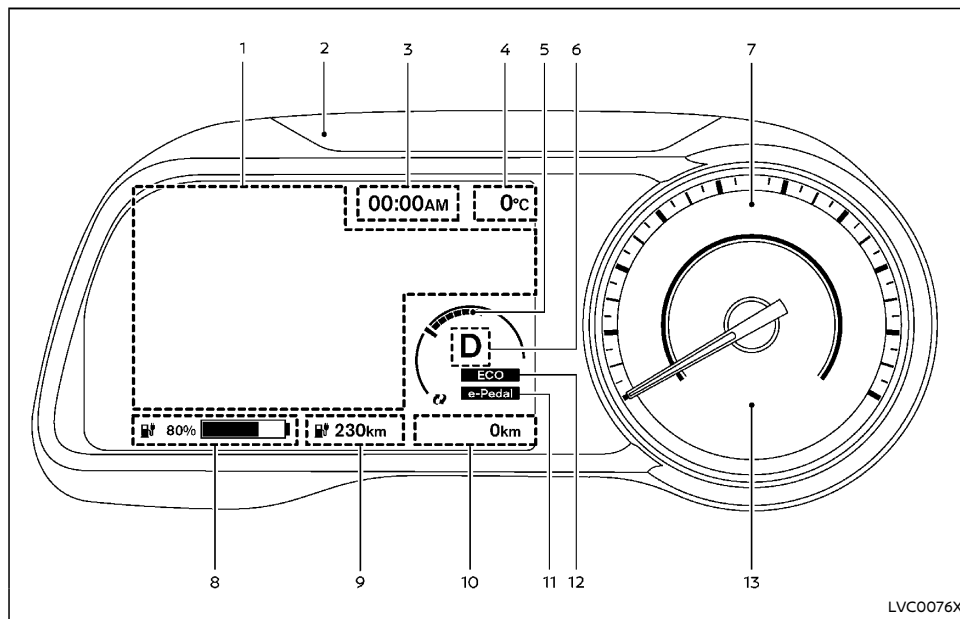

1. Vehicle information display
 - Trip computer
 - Timer display
 - ECO Drive Report
2. Warning and indicator lights
 - Master warning light
3. Clock
4. Outside air temperature
5. Power meter
6. Shift position indicator
7. Speedometer
8. Li-ion battery available charge gauge
9. Driving range
10. Odometer/twin trip odometer
11. ECO mode indicator
12. Rear seat belt warning*

12. e-Pedal system indicator
 13. Warning and indicator lights
 - READY to drive indicator light
- *: if equipped

SPEEDOMETER

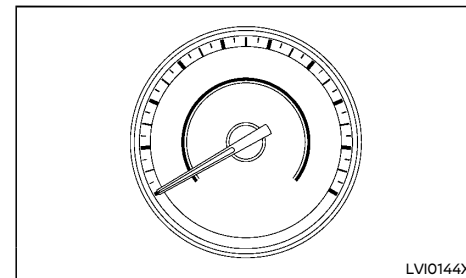

The speedometer indicates the vehicle speed (km/h).

ODOMETER/TWIN TRIP ODOMETER

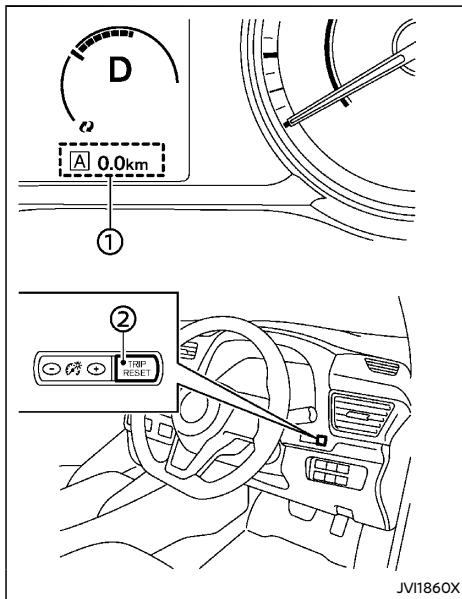

The odometer/twin trip odometer ① is displayed in the vehicle information display:

- when the power switch is in the ON or READY to drive position
- for a period of time after the power switch was placed in the OFF position

The odometer displays the total distance the vehicle has been driven.

The twin trip odometer displays the distance of individual trips.

Changing odometer/twin trip odometer display

Push the TRIP RESET switch ② on the right side of the instrument panel to change the display as follows:

Odometer → TRIP A → TRIP B → Odometer

Resetting twin trip odometer

Push the TRIP RESET switch ② for more than 1 second to reset the trip odometer to zero.

POWER METER

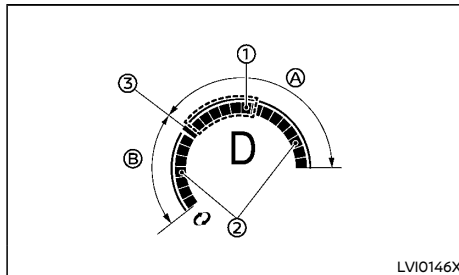

The power meter displays the traction motor power level when the accelerator pedal is depressed, as well as the level of power regeneration provided to the Li-ion battery by the regenerative brake.

This meter displays the actual traction motor power consumption A and the regenerative brake power provided to the Li-ion battery B. The white illuminated part ① in the display moves right or left depending on demand.

The power meter is in a neutral state ③.

The white illuminated part moves to the right when power is provided to the traction motor (Li-ion battery discharges).

The white illuminated part moves to the left when power is generated and provided to the Li-ion battery by the regenerative brake system (Li-ion battery charging).

The power meter also indicates if the power provided to the motor is limited or if regenerative braking is limited. When power or regenerative braking is limited, the illuminated segments on the display are narrowed ②.

Regenerative braking is automatically reduced when the Li-ion battery is fully charged to prevent the Li-ion battery from becoming overcharged. Regenerative braking is also automatically reduced when the Li-ion battery temperature is high/low (indicated by the red/blue zones on the Li-ion battery temperature gauge) to prevent Li-ion battery damage.

The more regenerative braking is reduced, the more illuminated segments on the display are narrowed ②.

If the Li-ion battery charge is low, power provided to the traction motor is reduced. Motor output is also limited if the Li-ion battery temperature is high/low (indicated by the red/blue zones on the Li-ion battery temperature gauge).

The more power provided to the traction motor is reduced, the more illuminated segments on the display are narrowed ②.

DRIVING RANGE

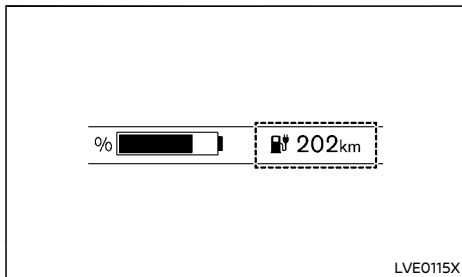

The driving range (km or miles) provides an estimated distance that the vehicle can be driven before recharging is necessary. The driving range is constantly being calculated, based on the amount of available Li-ion battery charge and the actual power consumption average.

The displayed driving range is the distance calculated based on the current driving style.

NOTE:

- The driving range display will flash when the low battery charge warning light illuminates. Additionally, if you continue to drive the vehicle in this state and the Li-ion battery is close to being completely discharged, “---” will be displayed. Charge the Li-ion battery as soon as possible. When the Li-ion battery is charged, the original display will be restored.
- After the Li-ion battery is charged, the displayed driving range is calculated based on the actual average energy consumption of previous journeys. The displayed driving range will vary every time the Li-ion battery is fully charged.

- The driving range will increase or decrease when the climate control system is turned on or off, or the ECO mode is selected, or when any other accessory is turned on or off based on driving.
- When the power meter is selected on the trip computer, the driving range is displayed on the trip computer.

LI-ION BATTERY AVAILABLE CHARGE GAUGE

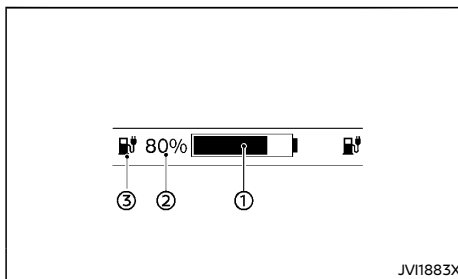

- ① The gauge indicates the approximate remaining Li-ion battery charge available to drive the vehicle (blue bar).
- ② This figure shows the current state of charge (%) of the Li-ion battery.
- ③ Low battery charge warning light illuminates in yellow when the available Li-ion battery charge is getting low.

Charge the Li-ion battery before the blue bar of the gauge disappears.

When the low battery charge warning light  illuminates in yellow, charge as soon as it is convenient, preferably before the blue bar of the gauge disappears. When the blue bar disappears and the low battery charge warning light (yellow) illuminates, there is a very small

reserve of Li-ion battery charge remaining.

NOTE:

- The length of the blue bar of the gauge is determined by the available charge and the amount of charge the Li-ion battery is capable of storing at the current temperature.
- Temperature affects the amount of charge the Li-ion battery is capable of storing. The Li-ion battery is capable of storing less power when the Li-ion battery temperature is cold. The Li-ion battery is capable of storing more power when the Li-ion battery is warm. The length of the blue bar of the gauge can change based on the amount of power the Li-ion battery is capable of storing. For example, when the Li-ion battery becomes colder, a longer blue bar is shown because the available charge is a greater percentage of the Li-ion battery's capability of storing power. When the Li-ion battery becomes warmer, a shorter blue bar is shown because the remaining energy is a lower percentage of the Li-ion battery's capability of storing power.

SHIFT POSITION INDICATOR

The shift position indicator indicates the shift lever position when the power switch is in the ON or READY to drive position. (See “Electric shift control system” (P.5-6).)

ECO MODE INDICATOR

The ECO mode indicator illuminates in the vehicle information display when the ECO mode has been activated. The ECO mode is used to help extend the range that the vehicle can be driven by consuming less power.

For additional information, see "ECO mode" (P.5-31).

e-Pedal SYSTEM INDICATOR

The e-Pedal indicator in the vehicle information display shows the status of the e-Pedal system. When the e-Pedal system is turned on, the indicator is blue and displays "e-Pedal". When the e-Pedal system is turned off, the indicator changes to gray and displays "e-Pedal OFF".

For additional information, see "e-Pedal system" (P.5-8).

OUTSIDE AIR TEMPERATURE

The outside air temperature can be displayed in °C or °F. To change the temperature unit between °C and °F, see "Settings" (P.2-15).

The temperature displayed may differ from the (actual) outside temperature as displayed on various signs or billboards.

CLOCK

Adjust the clock on the setting screen of the vehicle information display. See "Settings" (P.2-15).

If the 12-volt battery power supply is disconnected, the clock will not indicate the correct time after reconnecting the power supply. Adjust the time accordingly.

INSTRUMENT BRIGHTNESS CONTROL

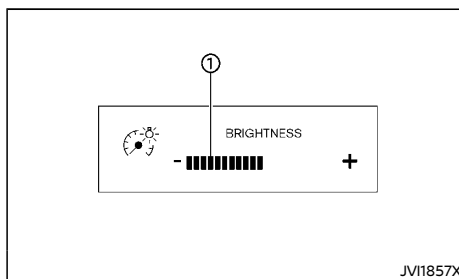
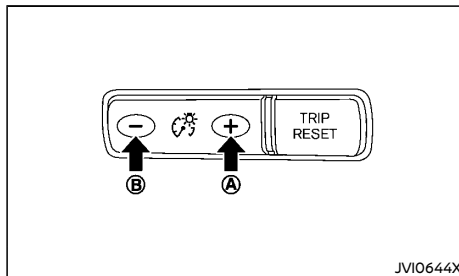

The instrument brightness control switch can be operated when the power switch is in the ON position.

When the switch is operated, the vehicle information display switches to the brightness adjustment mode.

Push the + side of the switch (A) to brighten the meter panel lights. The bar ① moves to the + side.



























Push the - side of the switch (B) to dim the lights. The bar ① moves to the - side.

When the brightness level reaches the max-

imum or minimum, a beep will sound.

The vehicle information display returns to the normal display when the instrument brightness control switch is not operated for more than 5 seconds.





WARNING LIGHTS, INDICATOR LIGHTS AND AUDIBLE REMINDERS

	12-volt battery charge warning light		Low battery charge warning light		Plug in indicator light
	Anti-lock Braking System (ABS) warning light		Master warning light (red/yellow)		Power limitation indicator light
	Approaching Vehicle Sound for Pedestrians (VSP) warning light		Seat belt warning light		READY to drive indicator light
	Brake system warning light (yellow)		Supplemental air bag warning light		Rear fog light indicator light*
	Brake warning light (red)		Electronic parking brake indicator light*		Security indicator light
	Electric power steering warning light		Electronic Stability Program (ESP) OFF indicator light		Small light indicator light
	Electric shift control system warning light		Front fog light indicator light*		Turn signal/hazard indicator lights
	Electronic Stability Program (ESP) warning light		High beam indicator light		
	EV system warning light		High beam assist indicator light*		
	Intelligent Emergency Braking system warning light*		Low beam indicator light		

*: if equipped





CHECKING LIGHTS

With all doors closed, apply the parking brake, fasten the seat belts and place the power switch in the ON position. The following lights (if equipped) will come on.

 ,  ,  ,  ,  (red)*1

*1: models not equipped with electronic parking brake system

The following lights (if equipped) will come on briefly and then go off:

 (yellow) ,  ,  ,  ,  ,  ,  ,  ,  ,  (red)*2

*2: models equipped with electronic parking brake system

If any light does not come on or operates in a way other than described, it may indicate a burned-out bulb and/or a system malfunction. Have the system checked by a NISSAN certified LEAF dealer.

Some indicators and warnings are also displayed on the vehicle information display. (See "Vehicle information display" (P.2-15).)

WARNING LIGHTS

 12-volt battery charge warning light

The DC/DC converter in the Power Delivery Module (PDM) converts 400 volt Li-ion battery voltage to charge the 12-volt battery.

When the power switch is in the ON position, the 12-volt battery charge warning light illuminates. The light will turn off when the power switch is placed in the READY to drive position.

When this warning light illuminates, a chime sounds and the following warning lights also illuminate.

- Master warning light (red)
 - EV system warning light
- The following messages also appear on the vehicle information display.

If the vehicle is being driven: "Stop safely" and if the vehicle is stopped: "Apply parking brake". When these messages appear, immediately stop the vehicle in a safe location, apply the parking brake and push the P position switch on the shift lever to place the vehicle in the P (Park) position. The warning and the chime stop when the parking brake is operated or the vehicle is in the P (Park) position. Contact a NISSAN certified LEAF dealer for support.



CAUTION:

- **The DC/DC converter system may not be functioning properly if the 12-volt battery charge warning light illuminates continuously when the power switch is in the READY to drive position. Immediately stop the vehicle in a safe location and contact a NISSAN certified LEAF dealer.**
- **If the 12-volt battery charge warning light illuminates continuously when the power switch is in the READY to drive position, do not charge the 12-volt battery. It may lead to a malfunction of the DC/DC converter system. Contact a NISSAN certified LEAF dealer.**

NOTE:

- **If the vehicle does not go into the READY to drive position (when the power switch is pushed with the brake pedal is depressed), jump-start the vehicle to place the power switch in the READY to drive position. See "Jump starting" (P.6-9).**

- **Do not jump-start the vehicle and contact a NISSAN certified LEAF dealer for inspection:**

- **If the 12-volt battery charge warning light turns off when the vehicle is in the READY to drive mode, the 12-volt battery may be discharged or there may be a malfunction in the 12-volt battery related system.**
- **If the 12-volt battery charge warning light continues to illuminate when the vehicle is in the READY to drive mode, there may be a malfunction in the Power Delivery Module (PDM). Contact a NISSAN certified LEAF dealer for inspection.**



Anti-lock Braking System (ABS) warning light

When the power switch is in the ON or READY to drive position, the Anti-lock Braking System (ABS) warning light illuminates and then turns off. This indicates the ABS is operational.

If the ABS warning light illuminates while the power switch is in the READY to drive position, or while driving, it may indicate the ABS is not functioning properly. Have the system checked by a NISSAN certified LEAF dealer.

If an ABS malfunction occurs, the anti-lock function is turned off. The brake system then operates normally, but without anti-lock assistance. (See "Brake system" (P.5-34).)



Approaching Vehicle Sound for Pedestrians (VSP) warning light

The Approaching Vehicle Sound for Pedestrians (VSP) warning light illuminates when a malfunction occurs in the VSP system.

Have the VSP system checked by a NISSAN certified LEAF dealer.

See "Approaching Vehicle Sound for Pedestrians (VSP) system" (P.EV-15).



Brake system warning light (yellow)

The brake system warning light functions for both the cooperative regenerative brake and the electronically driven intelligent brake systems. When the power switch is placed in the ON position or in the READY to drive position, the light remains illuminated for about a few seconds. If the light illuminates at any other time, it may indicate that the cooperative regenerative brake and/or the electronically driven intelligent brake systems are not functioning properly. Have the system checked by a NISSAN certified LEAF dealer. If the brake warning light (red) also illuminates, stop the vehicle immediately and contact a NISSAN certified LEAF dealer. For additional information, see "Brakes" (P.8-7).



WARNING:

- **Depressing the brake pedal when the power switch position is not in the ON or READY to drive position and/or low brake fluid level may increase the stopping distance and braking will require greater pedal effort as well as pedal travel.**

- **If the brake fluid level is below the minimum or MIN mark on the brake fluid reservoir, do not drive until the brake system has been checked at a NISSAN certified LEAF dealer.**
- **The cooperative regenerative brake system may not be working properly if the brake system warning light illuminates when the READY to drive indicator light is ON. If you judge it to be safe, drive carefully to the nearest service station for repairs. Otherwise, have your vehicle towed because driving could be dangerous.**



Brake warning light (red)

When the power switch is placed in the ON position or in the READY to drive position, the brake warning light remains illuminated for about a few seconds. If the brake warning light illuminates at any other time, it may indicate that the hydraulic brake system is not functioning properly. If the brake warning light illuminates, stop the vehicle immediately and contact a NISSAN certified LEAF dealer.

Parking brake warning indicator (models not equipped with electronic parking brake system):

When the power switch is placed in the ON position with the parking brake applied, the brake warning light illuminates. When the parking brake is released, the brake warning light turns off.

If the parking brake is not fully released, the brake warning light remains on. Be sure that the brake warning light has turned off before driving. See "Parking brake" (P.3-19).

Low brake fluid warning light:

When the power switch is placed in the ON position, the brake warning light illuminates and then turns off (models equipped with electronic parking brake system).

When the power switch is in the ON position, the light warns of a low brake fluid level. If this warning light illuminates, the Electronic Stability Program (ESP) warning light and the brake system warning light (yellow) also illuminate.

If the light illuminates while the power switch is in the READY to drive position with the parking brake not applied, stop the vehicle and perform the following items.

1. Check the brake fluid level. If brake fluid is necessary, add fluid and have the system checked by a NISSAN certified LEAF dealer. See "Brake fluid" (P.8-7).
2. If the brake fluid level is correct, have the warning system checked by a NISSAN certified LEAF dealer.



WARNING:

- **Your brake system may not be working properly if the warning light is on. Driving could be dangerous. If you judge the brake system to be safe, drive carefully to the nearest service station for repairs. Otherwise, have your vehicle towed because driving it could be dangerous.**
- **Depressing the brake pedal with the power switch position is other than ON or READY to drive position and/or low brake fluid level may increase the stopping distance and braking will require greater pedal effort as well as pedal travel.**

- **If the brake fluid level is below the minimum or MIN mark on the brake fluid reservoir, do not drive until the brake system has been checked at a NISSAN certified LEAF dealer.**

Electric power steering warning light

When the power switch is in the ON position, the electric power steering warning light illuminates and turns off when the power switch is placed in the READY to drive position. This indicates the electric power steering is operational.

If the electric power steering warning light illuminates while the READY to drive indicator light is ON, it may indicate the electric power steering is not functioning properly and may need servicing. Have the electric power steering checked by a NISSAN certified LEAF dealer.

When the electric power steering warning light illuminates while the READY to drive indicator light illuminates, the power assist to the steering will cease operation but you will still have control of the vehicle. At this time, greater steering efforts are required to operate the steering wheel, especially in sharp turns and at low speeds.

See "Electric power steering" (P.5-34).

Electric shift control system warning light

When the power switch is in the ON position, the electric shift control system warning light illuminates and then turns off.

This light illuminates to warn when a malfunction occurs in the electric shift control system.

When the master warning light illuminates, the chime sounds and the message, "When parked apply parking brake", is displayed on the vehicle information display.

When the power switch is in the OFF position, the chime sounds continuously. Make sure the parking brake is applied. If the parking brake is applied, the master warning light illuminates and the warning message on the vehicle information display turns off and the chime stops.

If the power switch cannot be placed in the OFF position, apply the parking brake and then place the power switch in the OFF position.

Have the system checked by a NISSAN certified LEAF dealer.

Electronic Stability Program (ESP) warning light

When the power switch is in the ON position, the Electronic Stability Program (ESP) warning light illuminates and then turns off.

When the warning light blinks while driving, the driving condition is slippery and the vehicle's traction limit is about to be exceeded.

When the ESP warning light illuminates with ESP system turned on, this light alerts the driver to the fact that the ESP system's fail-safe mode is operating, for example the ESP system may not be functioning properly. Have the system checked by a NISSAN certified LEAF dealer. If a malfunction occurs in the system, the ESP system function will be canceled but the vehicle is still drivable. For additional information, see "Electronic Stability Program (ESP) system" (P.5-11).

EV system warning light

When the power switch is in the ON position, the EV system warning light illuminates and then turns off.

This light illuminates if there is a malfunction in the following systems. Contact a NISSAN certified LEAF dealer.

- Traction motor and inverter system
- Charge port or on board charger
- Li-ion battery system
- Cooling system
- Electric shift control system
- Emergency shut off system is activated. See "Emergency shut-off system" (P.EV-6).

Intelligent Emergency Braking system warning light (if equipped)

When the power switch is in the "ON" position, the Intelligent Emergency Braking system warning light illuminates. After starting the EV system, the warning light turns off.

This light illuminates when the Intelligent Emergency Braking system is set to OFF on the vehicle information display.

If the light illuminates when the Intelligent Emergency Braking system is ON, it may indicate that the system is unavailable. See "Intelligent Emergency Braking system" (P.5-25).



Low battery charge warning light

The low battery charge warning light illuminates when the available Li-ion battery charge is getting low. Charge as soon as it is possible, preferably before the Li-ion battery available charge gauge reaches the bottom line.

NOTE:

The low battery charge warning light turns off immediately before the Li-ion battery is completely discharged and the vehicle will stop. If the Li-ion battery becomes completely discharged, the vehicle must be charged in order to be driven.



Master warning light (red/yellow)

The master warning light (red or yellow) illuminates when a warning message appears in the vehicle information display.

Yellow master warning light:

The yellow master warning light illuminates when a warning message (yellow) appears on the vehicle information display.

Red master warning light:

The red master warning light illuminates when a warning message (red) appears on the vehicle information display.



Seat belt warning light

For driver and front passenger:

When the power switch is in the ON position, the seat belt warning light illuminates. The light will continue to illuminate until the front seat belts are fastened. (See "Seat belts" (P.1-7).)

When the vehicle speed exceeds 15 km/h (10 MPH), the light will blink and the chime will

sound unless the front seat belts are securely fastened. The chime will continue to sound for about 95 seconds or until the front seat belts are fastened. (See "Seat belts" (P.1-7).)

For rear passengers (if equipped):

The seat belt warning light for the rear passengers will illuminate whenever the power switch is placed in the ON position, and will remain illuminated for approximately 65 seconds unless the rear seat belts are fastened.

If a rear passenger seat belt is fastened then unfastened at a vehicle speed less than approximately 15 km/h (10 MPH), the warning light will illuminate. When the vehicle speed exceeds approximately 15 km/h (10 MPH), the warning light will blink and the chime will sound. The warning will turn off when a rear passenger seat belt is fastened or automatically turn off approximately 65 seconds after the seat belt is unfastened.

For precautions on seat belt usage, see "Seat belts" (P.1-7).



Supplemental Restraint System (SRS) air bag warning light

When the power switch is in the ON position, the Supplemental Restraint System (SRS) air bag warning light illuminates for about 7 seconds and then turns off. This indicates the SRS air bag system is operational.

If any of the following conditions occur, the SRS air bag system and/or pre-tensioner seat belt need servicing. Have the system checked, and if necessary repaired, by a NISSAN certified LEAF dealer promptly.

- The SRS air bag warning light remains illuminated after about 7 seconds.

- The SRS air bag warning light does not come on at all.

Unless checked and repaired, the SRS air bag system and/or pre-tensioner seat belt may not function properly. (See "Supplemental Restraint System (SRS)" (P.1-22).)

INDICATOR LIGHTS



Electronic parking brake indicator light (if equipped)

The electronic parking brake indicator light indicates that the electronic parking brake system is operating.

If the parking brake is not fully released, the electronic parking brake indicator light remains on. Be sure that the electronic parking brake indicator light has turned off before driving. (See "Parking brake" (P.3-19).)



Electronic Stability Program (ESP) off indicator light

When the power switch is in the ON position, the Electronic Stability Program (ESP) off indicator light illuminates and then turns off.

The ESP off indicator light illuminates when the ESP system is turned off in the vehicle information display. This indicates that the ESP system is not operating.

For details, see "Electronic Stability Program (ESP) system" (P.5-11).

 Front fog light indicator light (if equipped)

The front fog light indicator light illuminates when the front fog lights are on. (See "Fog light switch" (P.2-34).)

 High beam indicator light

The high beam indicator light illuminates when the headlight high beam is on. The indicator light turns off when the low beam is selected. (See "Headlight and turn signal switch" (P.2-30).)

 High beam assist indicator light (if equipped)

The high beam assist indicator light illuminates when the headlights come on while the headlight switch is in the "AUTO" position with the high beam selected. This indicates that the high beam assist system is operational. (See "High beam assist" (P.2-31).)

 Low beam indicator light

The low beam indicator light illuminates when the headlight low beam is on. The indicator light turns off when either the  position or the high beam is selected. (See "Headlight and turn signal switch" (P.2-30).)

 Plug in indicator light

When the power switch is in the ON position, the plug in indicator light illuminates and then turns off.

This light illuminates while charge connector is connected to the vehicle and blinks during charging.

NOTE:

If the charge connector is connected to the vehicle, the power switch cannot be placed in the READY to drive position.

 Power limitation indicator light

When the power switch is in the ON position, the power limitation indicator light illuminates and then turns off.

When the power limitation indicator light is illuminated with the power switch in the READY to drive position, the power provided to the traction motor is reduced. Therefore the vehicle is not as responsive when the accelerator is depressed while the power limitation indicator light is illuminated.

When this light illuminates and any message appears on the vehicle information display, follow the instructions.

This light illuminates in the following conditions.

- Li-ion battery available charge is extremely low
- Li-ion battery temperature is very low.
- When the temperature of EV system is high (motor, inverter, coolant system, Li-ion battery etc.)

- When the EV system has a malfunction. If the low battery charge warning light is illuminated, charge the Li-ion battery as soon as possible.

If this light illuminates because the Li-ion battery is cold due to low outside temperatures, move the vehicle to a warmer location. The Li-ion battery temperature may be increased by charging the Li-ion battery.

If the light illuminates when the EV system becomes hot due to continuous hill climbing either continue driving at a slower safe speed, or stop the vehicle in a safe location. If this light does not turn off, contact a NISSAN certified LEAF dealer.

If the light illuminates in a situation other than those described above, or if it does not turn off, there may be a system malfunction. Contact a NISSAN certified LEAF dealer.



WARNING:

Power limitation mode can result in reduced power and vehicle speed. The reduced speed may be lower than other traffic, which could increase the chance of a collision. Be especially careful when driving. If the vehicle cannot maintain a safe driving speed, pull to the side of the road in a safe area. Charge the Li-ion battery if the charge is low or allow the Li-ion battery to cool.

NOTE:

You can reduce charging time and keep the Li-ion battery temperature lower if you:

- Charge more frequently in smaller amounts, and
- Keep the battery at a higher level of charge.

READY to drive indicator light

The READY to drive indicator light illuminates when the EV (Electric Vehicle) system is powered and the vehicle may be driven.

The READY to drive indicator light will turn off in the following conditions.

- Certain EV (Electric Vehicle) system malfunctions.
- The READY to drive indicator light turns off immediately before the Li-ion battery is completely discharged. If the Li-ion battery becomes completely discharged, the vehicle must be charged in order to be driven. See "If the Li-ion battery becomes completely discharged" (P.6-11).

Rear fog light indicator light (if equipped)

The rear fog light indicator light illuminates when the rear fog light is on. (See "Fog light switch" (P.2-34).)

Security indicator light

The security indicator light blinks when the power switch is in the LOCK, OFF or ACC position. This function indicates the security system equipped on the vehicle is operational.

If the security system is malfunctioning, this light will remain on while the power switch is in the ON position. (See "Security system" (P.3-10) for additional information.)

Small light indicator light

The small light indicator light illuminates when the headlight switch is turned to the  position.

Turn signals/hazard indicator lights

The turn signals/hazard indicator lights blink when the turn signal switch or hazard indicator flasher switch is turned on. (See "Headlight and turn signal switch" (P.2-30) or "Hazard warning flasher switch" (P.6-2).)

AUDIBLE REMINDERS

12-volt battery charge warning chime

If the 12-volt battery charge warning light illuminates, the chime will sound when a warning message is displayed on the vehicle information display.

When the chime sounds, immediately stop the vehicle in a safe location and push the P position switch on the shift lever and apply parking brake. The 12-volt battery charge warning light turns off and the chime will stop when the parking brake is applied or the vehicle is placed in the P (Park) position. Contact a NISSAN certified LEAF dealer for support.

Brake pad wear warning

The disc brake pads have audible wear warnings. When a brake pad requires replacement, it will make a high pitched scraping sound when the vehicle is in motion. This scraping sound will first occur only when the brake pedal is depressed. After more wear of the brake pad, the sound will always be heard even if the brake pedal is not depressed. Have the brakes checked as soon as possible if the wear warning sound is heard.

Have the system checked, and if necessary repaired, by a NISSAN certified LEAF dealer promptly. (See "Brakes" (P.8-7).)

Electric shift control system reminder chime



If an improper shift operation is performed, for safety reasons a chime will sound and at the same time, depending on the conditions, the operation will be cancelled or the shift position will switch to the N (Neutral) position.

For more details, see "Driving vehicle" (P.5-6).

Door lock warning chime

When the chime sounds, be sure to check both the vehicle and the Intelligent Key. (See "Troubleshooting guide" (P.3-8).)

Light reminder chime

The light reminder chime will sound if the driver's side door is opened while the headlight switch is in either the  or  position and the power switch is in the ACC, OFF or LOCK position.

Be sure to turn the light switch to the "OFF" or "AUTO" position when you leave the vehicle.

VEHICLE INFORMATION DISPLAY

Parking brake reminder chime

The parking brake reminder chime will sound if the vehicle is driven at speeds more than 7 km/h (4 MPH) (models not equipped with electronic parking brake) or 4 km/h (2 MPH) (models equipped with electronic parking brake) with the parking brake applied. Stop the vehicle and release the parking brake.

Power switch reminder chime

The power switch reminder chime will sound when the driver's door is opened while the power switch is in the ON or READY to drive position. Push the power switch to the OFF position.

Seat belt warning chime

For driver and front passenger:

When the vehicle speed exceeds 15 km/h (9 MPH), the chime will sound unless the front seat belts are securely fastened. The chime will continue to sound for about 95 seconds until the seat belt is fastened.

For rear passengers (if equipped):

If a rear passenger seat belt is fastened then unfastened at a vehicle speed exceeds approximately 15 km/h (10 MPH), the chime will sound. The warning will turn off when a rear passenger seat belt is fastened or automatically turn off approximately 65 seconds after the seat belt is unfastened.

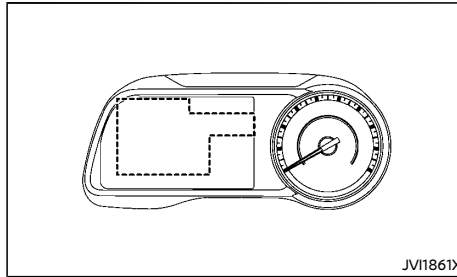

The vehicle information display is located on the left of the speedometer. It displays such items as:

- Vehicle settings
- Trip computer information
- Driver Assistance
- Cruise control system information
- Intelligent Key operation information
- Indicators and warnings

HOW TO USE THE VEHICLE INFORMATION DISPLAY

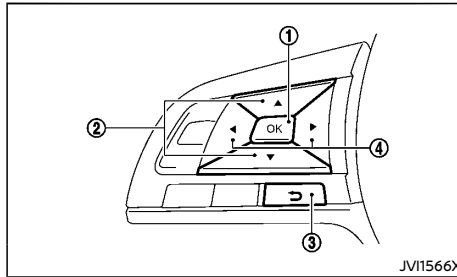

The vehicle information display can be changed using the switches OK ①, \updownarrow ②, $\leftarrow \rightarrow$ ③,

and $\blacktriangleleft \blacktriangleright$ ④ located on the steering wheel.

- ① OK - change or select an item in the vehicle information display
- ② \updownarrow - navigate through the items in vehicle information display
- ③ \curvearrowright - go back to the previous menu
- ④ $\blacktriangleleft \blacktriangleright$ - change from one display screen to the next (i.e. trip, energy economy)

STARTUP DISPLAY

When the power switch is placed in the ON position, the screens that display in the vehicle information display include:

- Battery information
- Audio (if equipped)
- Energy Economy
- Trip computer
- Warnings
- Settings

Warnings will only appear if there are any present. For more information on warnings and indicators, see "Vehicle information display warnings and indicators" (P.2-21).

To control what items are displayed in the vehicle information display, see "Settings" (P.2-15).

SETTINGS

The setting mode allows you to change the information displayed in the vehicle information display:

- ESP Setting
- Driver Assistance
- Customise Display
- Vehicle Settings

- EV Settings
- Maintenance
- Clock
- Unit/Language
- Factory Reset

ESP Setting

To change the setting, use the  button ② to select and push the OK button ①.

-  System

This allows you to turn the Electronic Stability Program (ESP) system ON or OFF. By default the ESP system will be turned ON. If the ESP system is turned off, the ESP OFF indicator light will illuminate.

NOTE:

The vehicle should be driven with the ESP system ON for most driving conditions. (See "Electronic Stability Program (ESP) system" (P.5-11).)

Driver Assistance

To change the status, warnings or turn on or off any of the systems/warnings displayed in the "Driver Assistance" menu, use the  button ② to select and the OK button ① to change a menu item:

- Lane (if equipped)
- Emergency Brake (if equipped)
- Parking Aids (if equipped)
- Driver Attention Alert (if equipped)
- Timer Alert
- Low Temperature Alert
- Chassis Control
- e-Pedal

Lane (if equipped):

This setting allows the customer to enable/disable the Lane Departure Warning (LDW) system.

- Lane Departure Warning
Push the OK button ① to turn the Lane Departure Warning (LDW) system ON/OFF.

For additional information, see "Lane Departure Warning (LDW) system" (P.5-16).

Emergency Brake (if equipped):

This setting allows the customer to activate or deactivate the Intelligent Emergency Braking system.

1. Use the  button ② to select "Emergency Brake" and then push the OK button ①.
2. Select "System" and push the OK button ① to turn ON/OFF the system.

For more information, see "Intelligent Emergency Braking system" (P.5-25).

Parking Aids (if equipped):

This setting allows the customer to enable/disable the Moving Object Detection (MOD) system.

1. Use the  button ② to select "Parking Aids" and then push the OK button ①.
2. Select "Moving Object" and push the OK button ① to turn ON/OFF the system.

For more information, see "Moving Object Detection (MOD)" (P.4-10).

Driver Attention Alert (if equipped):



This setting allows the customer to enable/disable the Intelligent Driver Alertness system.

1. Use the  button ② to select "Driver Attention Alert".
2. Push the OK button ① to turn ON/OFF the system.

For more information, see "Intelligent Driver Alertness" (P.5-23).

Timer Alert:

This setting allows the customer to set an alert to notify the driver that the set time has been reached.

1. Use the  button ② to select "Timer Alert" and push the OK button ①.
2. To change the timer amount, use the  button ② and the OK button ① to save the selected time amount.

Low Temperature Alert:

This setting allows the customer to enable/disable the alert for outside temperature in the vehicle information display.

1. Use the  button ② to select "Low Temperature Alert".
2. Push the OK button ① to turn ON/OFF the alert.

Chassis Control:





This setting allows the customer to activate or deactivate the Intelligent Trace Control.

1. Use the  button ② to select "Chassis Control" and then push the OK button ①.
2. Select "Active Trace Control" and push the OK button ① to turn ON/OFF the function.

For more information, see "Chassis control" (P.5-12).

e-Pedal:

This setting allows the customer to activate or deactivate the "Mode Memory" of the e-Pedal system.



1. Use the  button  to select "e-Pedal" and then push the OK button .
2. Select "Mode Memory" and push the OK button  to turn ON/OFF the function.

For more information, see "e-Pedal system" (P.5-8).



Customise Display

The Customise Display setting allows the customer to choose from the various meter selections.

- Main Menu Selection
- ECO Info Settings
- Welcome Effect

The display settings can be changed using the   and the OK  buttons.

Main Menu Selection:



The items that are displayed when the power switch is placed in the ON position can be enabled/disabled. To change some items that are displayed, use the  button  to scroll and the OK button  to select a menu item.

The following items are available in the "Main Menu Selection" menu:

- Safety Shield (if equipped)
Shows the status of safety shield system.
- Status
Shows the audio information. (if equipped)
- Drive Computer 1
Shows first set of trip computer information.

- Drive Computer 2
Shows second set of trip computer information.
- Chassis Control
Shows the status for all chassis control systems.

ECO Info Settings:

Use the  button  until "ECO Info Settings" is selected, and push the OK button .







This provides access to sub-menus with the following options:

- ECO Drive Report
Activate or deactivate the ECO Drive Report. For more information, see "ECO Drive Report" (P.2-30).
- View History
You can view the ECO Drive Report history. This will show the current and best ECO Drive Report.

Welcome Effect:

You can choose whether or not to display the welcome screen when the power switch is placed in the ACC or ON position. You can also choose the following items to define how the welcome screen looks:



- Gauges
- Animation

Select "Welcome Effect" using the  button  and push the OK button  to select this menu. Use the  button  to navigate between the menu options and push the OK button  to turn each function ON/OFF.

Vehicle Settings





The vehicle settings allows the customer to change settings for the following settings.

- Lighting
- Locking
- Wipers
- Auto-fold (if equipped)

The vehicle settings can be changed using the   and the OK  buttons.

Lighting:

The "Lighting" menu has the following options:

- Auto Room Lamp
The interior light timer can be set to be ON or OFF. Use the OK button  to turn this feature ON or OFF.
- Light Sensitivity
The sensitivity of the Intelligent Auto Headlights can be adjusted. Use the  button  and the OK button  to select the required sensitivity. The following options are available:

- Earliest
- Earlier
- Standard
- Later

Locking:

The "Locking" menu has the following item:

- Ext. Door Switch
When this item is turned on, the request switch on the door is activated. Use the OK  button to activate or deactivate this function.

Wipers:

The "Wipers" menu has the following item:

- Speed Dependent
The "Speed Dependent" feature can be activated or deactivated. Use the OK button ① to turn this feature ON or OFF.

Auto-fold (if equipped):

When this item is turned ON, the outside rearview mirrors automatically fold when the doors are locked, and unfold when the doors are unlocked and the power switch is placed in the ACC or ON position. Use the OK ① button to activate or deactivate this function.

EV Settings

Use the \blacktriangle button ②, and the OK button ① to change the status and settings displayed in the "EV Settings" menu. The following menu options, each leading to a further sub-menu, are available:

Chg. Connector Lock (if equipped):

You can choose the charge connector lock mode from the following:

- AUTO
- LOCK
- UNLOCK

For more information, see "Charge connector lock" (P.CH-14).

Charge Timer1:

The following menu options are available.

- Timer
When this item is turned on, the first charge timer is activated.
- Start Time
When this item is selected, the time at which the charge timer activates can be

set.

- End Time
When this item is selected, the time at which the charge timer finishes can be set.
- Full charge has priority
If this item is turned on, the charge start timer will be advanced in case the fully charged condition of the Li-ion battery cannot be achieved during the time from the start time to end time.
If the fully charged battery condition is not achieved, the charge continues until the Li-ion battery is fully charged even if the "End Time" has been reached.

For more information, see "Charging methods" (P.CH-18).

Charge Timer2:

The following menu options are available.

- Timer
When this item is turned on, the first charge timer is activated.
- Start Time
When this item is selected, the time at which the charge timer activates can be set.
- End Time
When this item is selected, the time at which the charge timer finishes can be set.
- Full charge has priority
If this item is turned on, the charge start timer will be advanced in case the fully charged condition of the Li-ion battery cannot be achieved during the time from the start time to end time.
If the fully charged battery condition is not achieved, the charge continues until the Li-ion battery is fully charged even if the "End Time" has been reached.

For more information, see "Charging methods" (P.CH-18).

Charge Time Screen:

The displayed charging time displayed on the Estimated Charge Time screen is calculated based on the electrical power (supplied to the charger) selected from the following:

- 6.0 kW (AC 200-240V) (if equipped)
- 3.0 kW (AC 200-240V)
- 50 kW (Quick Charge)

For more information, see "2. Estimated charge time" (P.2-27).

Climate Ctrl. Timer1:

The following menu options are available:

- Timer
When this item is turned on, the first climate control timer is activated.
- Departure Time
When this item is selected, the time at which the climate control timer finishes can be set.
- Climate Temperature
When this item is selected, the temperature to which the cabin will be heated/cooled can be set.
- Battery Operation OK
If this item is turned on, the climate control timer will be activated even if only battery power is available.

For more information, see "Climate Ctrl. Timer" (P.4-17).

Climate Ctrl. Timer2:

The following menu options are available:

- **Timer**
When this item is turned on, the first climate control timer is activated.
- **Departure Time**
When this item is selected, the time at which the climate control timer finishes can be set.
- **Climate Temperature**
When this item is selected, the temperature to which the cabin will be heated/cooled can be set.
- **Battery Operation OK**
If this item is turned on, the climate control timer will be activated even if only battery power is available.

For more information, see "Climate Ctrl. Timer" (P.4-17).

Maintenance

The maintenance mode allows you to set alerts for the reminding of maintenance intervals.

- Tyre
- Other

Use the  button ② and push the OK button ① to change the settings of each item.

Tyre:

This indicator appears when the customer set distance comes for replacing tires. You can set or reset the distance for replacing tires.



WARNING:

The tire replacement indicator is not a substitute for regular tire checks, including tire pressure checks. See "Changing tires and wheels" (P.8-22). Many factors including tire

inflation, alignment, driving habits and road conditions affect tire wear and when tires should be replaced. Setting the tire replacement indicator for a certain driving distance does not mean your tires will last that long. Use the tire replacement indicator as a guide only and always perform regular tire checks. Failure to perform regular tire checks, including tire pressure checks could result in tire failure. Serious vehicle damage could occur and may lead to a collision, which could result in serious personal injury or death.

Other:

This indicator appears when the customer set distance comes for checking or replacing maintenance items other than the tires. Other maintenance items can include such things as wiper blades or tire rotation. You can set or reset the distance for checking or replacing the items.

Clock

Use the  button ② to select "Clock" and push the OK button ①.

For models with NissanConnect System:

Set Clock Manually:

The clock setting can be changed using the  ② and the OK ① buttons.

Clock Format

The time setting can be selected from 12 hour and 24 hour formats.

The clock settings can also be changed on the touch screen display. See the separate Nissan-Connect Owner's Manual.

For models without audio system:

Set Clock:

The clock setting can be changed using the  ② and the OK ① buttons.

12H/24H

The time setting can be selected from 12 hour and 24 hour formats.

For models with audio system (except for NissanConnect System):

When this item is selected, a message will prompt you to set the clock on the central display (audio system).

To set the clock, see "FM-AM radio with Compact Disc (CD) player" (P.4-25).

Unit/Language

Use the  button ② to select "Unit/Language" and push the OK button ①.

The following items are available:

- Distance/Energy
- Temperature
- Language

The settings can be changed using the  button ② and the OK button ①.

Distance/Energy:

The unit for the distance and power consumption that are shown in the vehicle information display can be changed to:

- km, kWh/100km
- km, km/kWh
- miles, miles/kWh

Temperature:

The temperature that is shown in the vehicle information display can be changed from:

- °C (Celsius)
- °F (Fahrenheit)

Use the OK button ① to toggle choices.

Language:

The language of the vehicle information display can be changed to one of the available languages.

Factory Reset











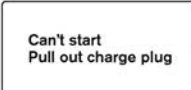

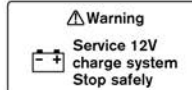
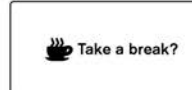
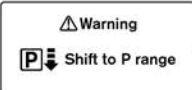
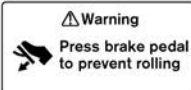
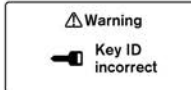
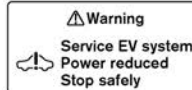

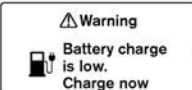
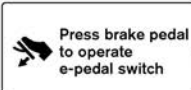

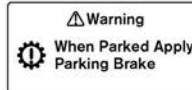
The settings in the vehicle information display can be reset back to the factory default. To reset the vehicle information display:

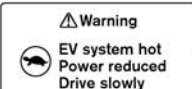
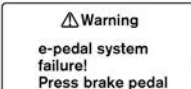
1. Select "Factory Reset" using the  button ② and push the OK button ①.
2. Select "Yes" to return all settings back to default by pushing the OK button ①.

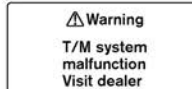
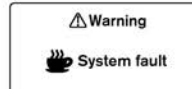
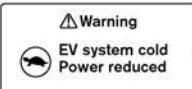
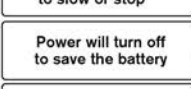
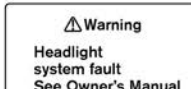
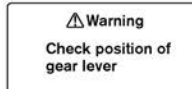
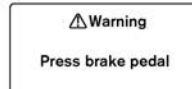
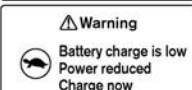
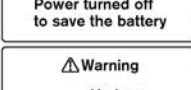
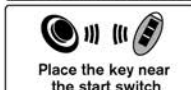
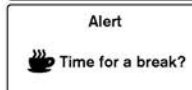
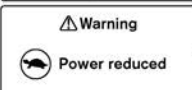
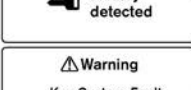
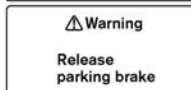
To cancel the reset operation select "Cancel" or push the  button ③.

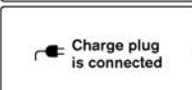
The settings under the "EV Settings" menu ("Charging Timer" and "Climate Ctrl. Timer") are not reset by this operation.

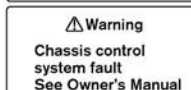
VEHICLE INFORMATION DISPLAY WARNINGS AND INDICATORS

 <p>1</p>	 <p>9</p>	 <p>17</p>	 <p>25</p>	 <p>33</p>
 <p>2</p>	 <p>10</p>	 <p>18</p>	 <p>26</p>	 <p>34</p>
 <p>3</p>	 <p>11</p>	 <p>19</p>	 <p>27</p>	 <p>35</p>
 <p>4</p>	 <p>12</p>	 <p>20</p>	 <p>28</p>	 <p>36</p>
 <p>5</p>	 <p>13</p>	 <p>21</p>	 <p>29</p>	 <p>37</p>
 <p>6</p>	 <p>14</p>	 <p>22</p>	 <p>30</p>	
 <p>7</p>	 <p>15</p>	 <p>23</p>	 <p>31</p>	
 <p>8</p>	 <p>16</p>	 <p>24</p>	 <p>32</p>	

WBC0001X

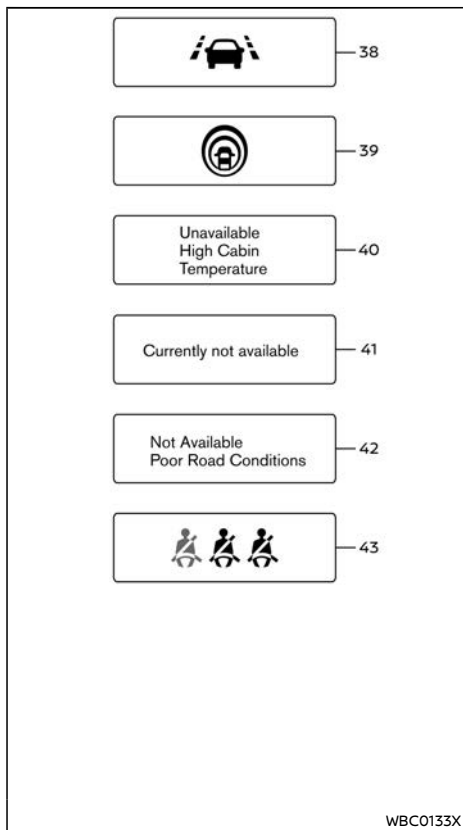

1. READY to drive position operation indicator

This indicator appears while the vehicle is in the P (Park) position.

This indicator means that the EV system will start when the power switch is pushed with the brake pedal depressed.

2. Shift to P range warning

This warning appears alternately with door/rear hatch open warning when the driver's door is opened with the shift position in any position other than the P (Park) position.

If this warning appears, shift to the P (Park) position.

3. Li-ion battery low charge warning

This warning appears when the Li-ion battery charge is getting low. The low battery charge warning light and the master warning light also illuminate. Charge the Li-ion battery as soon as possible.

4. Power limitation (hot) warning

This warning appears when the temperature of the traction motor, Li-ion battery, etc. becomes extremely high due to driving in high outside air temperatures, continuous driving at high speed or on uphill climbs, etc. when the power limitation indicator illuminates. If this warning appears, vehicle speed will not increase due to the power limitation even if the accelerator pedal is depressed.

5. Power limitation (cold) warning

This warning appears when the temperature of Li-ion battery becomes extremely low under extremely low outside air temperatures, etc. when the power limitation indicator illuminates. If this warning appears, vehicle speed will not increase due to the power limitation even if the accelerator pedal is depressed.

6. Power limitation (low charge) warning

This warning appears when the remaining capacity of Li-ion battery becomes extremely low when the power limitation indicator illuminates. If this warning appears, vehicle speed will not increase due to the power limitation even if the accelerator pedal is depressed.

If the warning appears due to the extremely low remaining capacity of Li-ion battery, stop the vehicle in a safe location and contact a NISSAN certified LEAF dealer.

7. Power limitation (other) warning

This warning appears due to reasons other than above power limitation warnings (hot, cold or low charge). If this warning appears, vehicle speed will not increase due to the power limitation even if the accelerator pedal is depressed.

8. Plug-in indicator

This indicator appears when the charge connector is connected. If the charge connector is connected to the vehicle, the power switch cannot be placed in the READY to drive position.

Depending on the warnings and indicators, you need to push the OK button located on the steering wheel to turn off the message.

9. Remove charge connector warning

This warning appears when the power switch is in the ACC or ON position and if the power switch is pushed to the READY to drive position with the brake pedal depressed, while the charge connector is inserted to the vehicle. Remove the charge connector.

10. Press brake pedal to prevent rolling warning

This warning appears if the vehicle starts to move while it is stopped by the e-Pedal system on a slope. The warning message continues to be displayed until the brake pedal is depressed.

11. Press brake pedal to operate e-pedal switch indicator

This indicator appears when trying to turn the e-Pedal off without depressing the brake pedal when the vehicle is stopped. Depress the brake pedal before pulling the e-Pedal switch.

12. e-Pedal system fault warning

This warning appears when the e-Pedal system is malfunctioning. Have the system checked soon at a NISSAN certified LEAF dealer.

13. Power will turn off to save the battery warning

This warning appears after a period of time if the shift lever has not been moved from the P (Park) position.

14. Power turned off to save the battery warning

This warning appears after the power switch is automatically placed in the OFF position to save the 12-volt battery.

15. No key detected warning

This warning appears in either of the following conditions:

No key inside the vehicle:

This warning appears when the door is closed with the Intelligent Key left outside the vehicle and the power switch in the ACC or ON position. Make sure that the Intelligent Key is inside the vehicle.

Unregistered Intelligent Key:

This warning appears when the power switch is placed in the ON, ACC or READY to drive position and the Intelligent Key cannot be recognized by the system. You cannot place the power switch in the READY to drive position with an unregistered key. Use an Intelligent Key that has been registered.

16. Intelligent Key system warning

This warning appears if there is a malfunction in the Intelligent Key system.

If this warning appears while the traction motor is stopped, the power switch cannot be switched to the READY to drive position. If this warning appears while the power switch is in the READY to drive position, the vehicle can be driven. However, contact a NISSAN certified LEAF dealer.

17. Intelligent Key battery discharge indicator

This indicator appears when the Intelligent Key battery is running out of power.

If this indicator appears, replace the battery with a new one.

18. Key ID incorrect warning

This warning appears when the power switch is pushed from the LOCK position and the Intelligent Key cannot be recognized by the system. You cannot start the EV system with an unregistered key. Use the registered Intelligent Key. See "Intelligent Key system" (P.3-4).

19. Door/rear hatch open warning

This warning appears if any of the doors and/or the rear hatch are open or not closed securely. The vehicle icon indicates which door, or the rear hatch, is open on the display. Make sure that all of the doors and the rear hatch are closed.

20. Light reminder warning

This warning appears when the driver's door is opened with the headlight switch is left ON and the power switch is placed in the OFF or LOCK position. Turn the headlight switch to the OFF or AUTO position.

21. Headlight system fault warning (if equipped)

This warning appears if the LED headlights are malfunctioning. Have the system checked by a NISSAN certified LEAF dealer.

22. EV system operation for Intelligent Key system indicator

This indicator appears when the Intelligent Key battery is running out of power and when the Intelligent Key system and vehicle are not communicating normally.

If this indicator appears, touch the power switch with the Intelligent Key while depressing the brake pedal. (See "Intelligent Key battery discharge" (P.5-5).)

23. Release parking brake warning

This warning appears when the vehicle speed is above 7 km/h (4 MPH) (models not equipped with electronic parking brake) or 4 km/h (2 MPH) (models equipped with electronic parking brake) and the parking brake is applied. Stop the vehicle and release the parking brake.

24. Chassis control system fault warning

This warning appears if the chassis control is not functioning properly. Have the system checked as soon as possible. It is recommended that you visit a NISSAN certified LEAF dealer for this service. (See "Chassis control" (P.5-12).)

25. Service 12V charge system warning

This warning appears if the DC/DC converter system is not functioning properly. The 12-volt battery charge warning light also illuminates. Stop the vehicle in a safe location and contact a NISSAN certified LEAF dealer.

The message will vary depending on the condition of the system malfunction. Be sure to follow the displayed instruction.

26. Service EV System power reduced warning

This warning appears if there is a malfunction in the EV system and the power provided to the traction motor is reduced.

The message will vary depending on the condition of the system malfunction. Be sure to follow the displayed instruction.

27. When Parked Apply Parking Brake warning

This warning appears if there is malfunction in the electric shift control system. This warning appears when the parking brake is not applied, even after the vehicle has been parked. Depending on the conditions, the chime also sounds at the same time.

If the power switch cannot be placed in the OFF position, apply the parking brake and then place the power switch in the OFF position. The message on the vehicle information display turns off and the chime stops. Have the system checked by a NISSAN certified LEAF dealer.

28. T/M system malfunction warning

This warning appears if there is a malfunction in the electric shift control system but operation of the electric shift control is still possible. Depending on the conditions, the chime also sounds at the same time. When this occurs, check the shift position indicator near the shift lever or on the vehicle information display to make sure that shifting has been performed properly. Contact a NISSAN certified LEAF dealer as soon as possible.

29. Check position of gear lever warning

This warning appears if the system cannot detect the shift position. Make sure that the shift lever is placed in a position properly. Depending on the conditions, the chime also sounds at the same time. Check the position of the shift lever.

30. Time for a break? alert

This indicator appears when the set "Timer Alert" indicator activates. You can set the time for up to 6 hours. See "Settings" (P.2-15).

31. Low outside temperature alert

This warning appears if the outside temperature is below 3 °C (37 °F). The warning can be turned on or off in the "Low Temperature Alert" menu. See "Settings" (P.2-15).

32. Cruise control indicator

This indicator shows the cruise control system status. The status is shown by the color.

See "Cruise control" (P.5-14).

33. Take a break? warning (if equipped)

This warning appears when the Intelligent Driver Alertness system detects that driver attention is decreasing. For more details, see "Intelligent Driver Alertness" (P.5-23).

34. Not Available Front Radar Blocked warning (if equipped)

This warning appears when the Intelligent Emergency Braking system becomes unavailable due to an obstruction of the front radar. For more details, see "Intelligent Emergency Braking system" (P.5-25).

35. System fault warning (if equipped)

This warning appears if the following systems (if equipped) are malfunctioning.

- Lane Departure Warning (LDW) system
- Intelligent Lane Intervention system
- Intelligent Emergency Braking system

The displayed icon varies according to each system.

For more details, see "Lane Departure Warning (LDW) system" (P.5-16), "Intelligent Lane Intervention system" (P.5-19) and "Intelligent Emergency Braking system" (P.5-25).

36. System fault warning (if equipped)

This warning appears if the Intelligent Driver Alertness system is malfunctioning. For more details, see "Intelligent Driver Alertness" (P.5-23).

37. Press brake pedal warning (if equipped)

This message may appear in the following situations:

- The driver tries to release the electronic parking brake manually without depressing the brake pedal.
- The vehicle is stopped on a steep hill; and there is a possibility of moving backwards, even if the electronic parking brake is applied.

38. Lane Departure Warning (LDW)/ Intelligent Lane Intervention indicator (if equipped)

This indicator appears when the Lane Departure Warning (LDW) and/or the Intelligent Lane Intervention systems are engaged. See "Lane Departure Warning (LDW) system" (P.5-16) or "Intelligent Lane Intervention system" (P.5-19).

39. Intelligent Lane Intervention ON indicator (if equipped)

This indicator appears when the Intelligent Lane Intervention system is turned on. See "Intelligent Lane Intervention system" (P.5-19).

40. Unavailable High Cabin Temperature warning (if equipped)

This warning appears if the interior temperature of the vehicle has reached such a high temperature that the sensor for the following systems (if equipped) can no longer function reliably.

- Lane Departure Warning (LDW)
- Intelligent Lane Intervention

Once the interior temperature has reached normal levels, the warning should disappear. If the warning continues to appear, have the system checked by a NISSAN certified LEAF dealer.

For additional information, refer to "Lane Departure Warning (LDW) system" (P.5-16), "Intelligent Lane Intervention system" (P.5-19) or "Intelligent Emergency Braking system" (P.5-25).

41. Currently not available warning (if equipped)

This message may appear when the Intelligent Lane Intervention system is engaged.

Under the following condition, the Intelligent Lane Intervention system is automatically canceled:

- When the Vehicle Dynamic Control (VDC) system is turned off

The Intelligent Lane Intervention system cannot be used when the VDC system is off.

42. Not Available Poor Road Conditions warning (if equipped)

This message may appear when the Intelligent Lane Intervention system is engaged.

Under the following condition, the Intelligent Lane Intervention system is automatically canceled:

- When the Vehicle Dynamic Control (VDC) or the Anti-lock Braking System (ABS) operates

The Intelligent Lane Intervention system cannot be used when the VDC or ABS operates.

43. Rear Seat Belt warning (if equipped)

This warning appears for 65 seconds after the power switch is placed in the "ON" position.



This warning shows the status of the three rear seat belts. When one of the rear seat belts is buckled, the corresponding rear seat belt indicator will appear white. When one of the rear seat belts is buckled and becomes unbuckled, the corresponding rear seat belt indicator will appear in red. If this occurs while the vehicle speed exceeds approximately 15 km/h (10 MPH), a buzzer will sound.

For precautions on seat belt usage, see "Seat belts" (P.1-7).

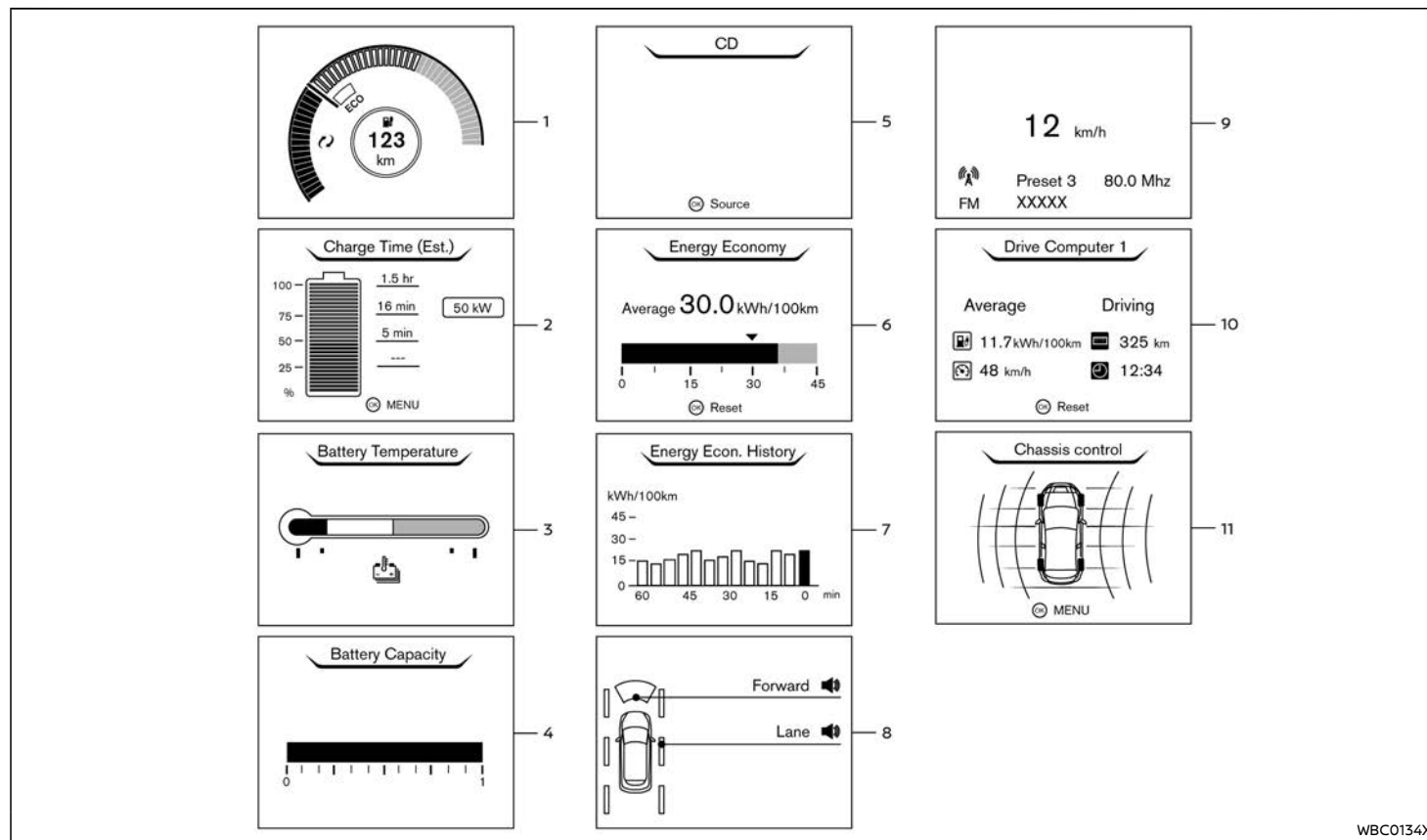
TRIP COMPUTER



WBC0134X

The trip computer display can be changed using the  ② and   ④ switches located on the steering wheel. (See "How to use the vehicle information display" (P.2-15).)

1. Power meter

The power meter displays the actual traction motor power consumption and the regenerative brake power provided to the Li-ion battery while driving. For more information, see "Power meter" (P.2-5).

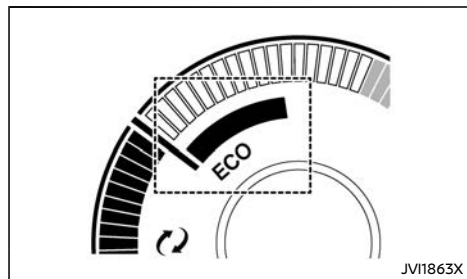

Driving with the power meter gauge in the ECO zone helps reduce the energy consumption and extend the driving range. (The ECO zone varies depending on the vehicle speed.) The ECO zone is not related to the ECO mode which is activated by the ECO mode switch. For more information, see "ECO mode" (P.5-31).

2. Estimated charge time

The Estimated Charge Time mode shows the estimated time to charge the Li-ion battery to a full level.

Immediately after the power switch is placed in the ON position, longer charging time may be displayed than the actual time required.

How to read the display:

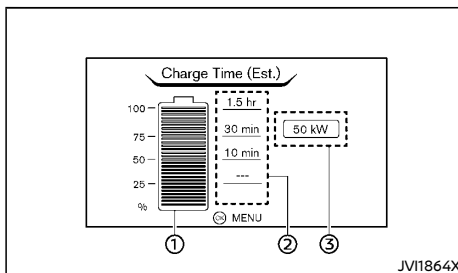

Not charging/While normal charging

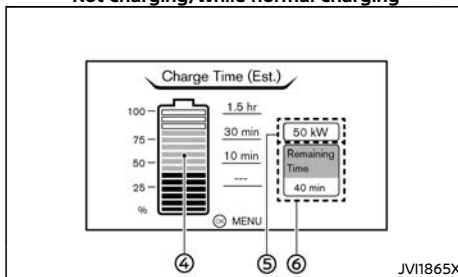

While quick charging

The displayed charging time is calculated based on the electrical power (supplied to the charger), which is selected in the "Charge Time Screen" setting under the EV Settings menu.

The display shows:

- ① The currently remaining Li-ion battery charge level.
- ② The estimated charging time to reach each percentage (25%, 50%, 75%, and 100%) of the Li-ion battery level.

NOTE:

- If the estimated charging time is longer than 24 hours, "Over 24hr" is displayed.
- When the currently remaining Li-ion battery level exceeds each percentage level, the charging time will be displayed as "----".
- When the Li-ion battery was fully charged, all the charging time information will be displayed as "----".

- ③ The currently selected electrical power (supplied to the battery).
- ④ The estimated charge level of the Li-ion battery to be reached when the remaining charging time has passed.
- ⑤ The electrical power that is actually supplied while quick charging.
- ⑥ The remaining charging time before the quick charger is shut off.

When charging is not performed, pushing the OK button on the steering wheel will switch the display to the "Charge Time Screen" menu. Select the electrical power that you wish to show in the Estimated Charge Time display.

While charging, the OK button on the steering wheel cannot be operated to switch to the "Charge Time Screen" menu.

NOTE:

- While charging, the estimated charging time is calculated based on the electrical power that is currently supplied to the charger.
- The electrical power for the normal charging is displayed at a fixed value. Therefore, the displayed electrical power may differ from the one that is actually supplied.

- For the quick charging, the electrical power display will change to the actual electrical power while charging. If the charging is stopped or the power supply is stopped (unplugged, etc.), the displayed electrical power returns to the selected electrical power.
- The displayed charging time on each percentage level is the current estimation, and the actual charging time will vary depending on the conditions of the vehicle or the state of charge.
- Right after starting or stopping charge, the estimated charging time may be differ from the actual charging time. The actual charging time will be displayed after a while.

3. Li-ion battery temperature gauge

The Li-ion battery temperature gauge indicates the temperature of the Li-ion battery.

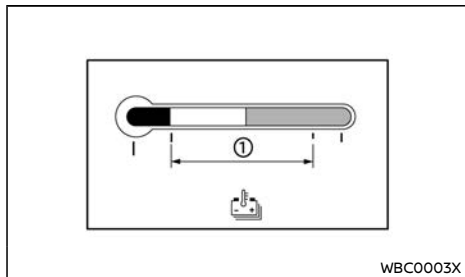

If the indicator is over the normal range ①, the power limitation indicator light  may illuminate and the power provided to the traction motor may be reduced. This is not a malfunction. Pull off the road to a safe location and stop the vehicle (preferably in a cool location).

Wait until the temperature of the Li-ion battery is reduced.

- The temperature of the Li-ion battery is more likely to rise in the following conditions:
 - When driving at high speed continuously.
 - When climbing hills continuously.
 - After performing the quick charging repeatedly.
 - When the outside temperature is high.
- If the outside temperature is extremely low, the Li-ion battery temperature gauge may not display a temperature reading. The vehicle may not switch to the READY to drive mode.
- When the temperature of the Li-ion battery is higher or lower, it may take more time to charge the Li-ion battery using a quick charger.

4. Li-ion battery capacity level gauge

The Li-ion battery capacity level gauge indicates the amount of charge the Li-ion battery is capable of storing.

When the capacity of the Li-ion battery decreases with age and usage, the level of the gauge will also decrease.

5. Audio (if equipped)

The audio mode shows the status of audio information.

6. Energy economy

The Energy Economy mode shows the instant energy economy and the average energy economy.

Instant energy economy:

The display changes when the energy is consumed or regenerated energy is being stored in the Li-ion battery while driving.

Average energy economy:

The display shows the average energy economy since the last reset. Resetting the average energy economy is done by pushing the OK button.

7. Energy economy history

The Energy Economy History mode shows the energy economy from the past hour by bar graph. The graph is updated every 5 minutes. The graph continues to be updated after the power switch is placed in the OFF position and will be reset after 65 minutes.

8. Safety shield (if equipped)

The Safety Shield mode shows the operating condition for the following systems (if equipped).

- Lane Departure Warning (LDW)
- Intelligent Lane Intervention
- Intelligent Emergency Braking system

See “Lane Departure Warning (LDW) system” (P.5-16), “Intelligent Lane Intervention system” (P.5-19) or “Intelligent Emergency Braking system” (P.5-25).

9. Status

This mode shows vehicle speed and audio information (if equipped).

10. Drive computer

The Drive Computer mode shows the following information:

- Average energy consumption
- Average speed
- Trip odometer
- Elapsed time

To reset each item or all items, push the OK button to switch to the Reset Menu and select a which item(s) to reset.

11. Chassis Control

When the Intelligent Trace Control is operated, it shows the operating condition.

For more information, see "Chassis control" (P.5-12).

TIMER DISPLAY

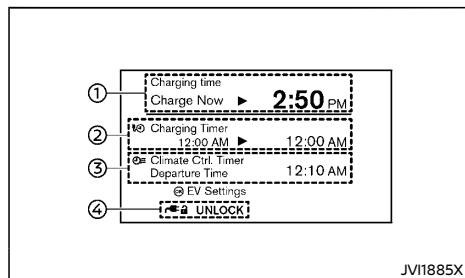

Charging timer ON/Climate Ctrl. timer ON

The timer display appears for approximately 30 seconds when the power switch is placed in the OFF position.

① Charging time

The estimated time of charging the Li-ion battery (start time and end time) is displayed.

- When the charging timer is set, the charging system calculates the estimated time to charge the Li-ion battery based on the electrical power supplied in the last charging using the timer, and the start time and end time are displayed.
- The estimated time may be recalculated depending on the actual electrical power after the charge cable is connected. Although the estimated time may be different from the time that was displayed when the power switch was placed in the OFF position. This is not a malfunction.
- When the charging timer is set to OFF, the estimated end time to charge the Li-ion battery to a full level in the case of performing the immediate charge. The end time is calculated based on the electrical power selected in the "Charge Time Screen" menu.
- When the Li-ion battery was fully charged, the charging time will be displayed as "--:--".

② Charging timer setting status

When the charging timer is set, the start time and end time of the charging using the timer are displayed. (For the charging timer operation, see "Charging timer" (P. CH-18).)

③ Climate Ctrl. timer setting status

When the Climate Ctrl. timer is set, the departure time (end time) set for the Climate Ctrl. Timer is displayed. (For the Climate Ctrl. timer operation, see "Climate Ctrl. Timer" (P.4-17).)

④ Charge connector lock setting status (if

equipped)

The current mode of the charge connector lock (AUTO, LOCK or UNLOCK) is displayed. For the charge connector lock operation, see "Charge connector lock" (P. CH-14).

When the OK button on the steering wheel is pushed, the display will be switched to the "EV Settings" menu. In the EV Settings, the setting of the charging timer, Climate Ctrl. timer and Charge connector lock mode (if equipped) can be changed. (See "Settings" (P.2-15).)

When the  button on the steering wheel is pushed while the timer display is shown, the display is switched to the ECO Drive Report (if the vehicle was driven).

Either display will continue to be displayed for another 30 seconds when the button is operated. If the doors are locked after the power switch was placed in the OFF position, the display will turn off before the preset time.

In addition to the above, note the following conditions for the charging time information:

- The charging time is displayed by the 10 minutes. If the estimated charging time is longer than 24 hours, "Over 24hr" is displayed.
- When the charging is set to start immediately after connecting the charge connector to the vehicle, the start time is displayed as "Charge Now".
- While being charged, the time when the charging has actually started is displayed as the start time. The end time is displayed according to the estimated charging time that was calculated based on the electrical power being supplied.

- When "Full charge has priority" is set to ON in the EV Settings and the Li-ion battery cannot be charged to a full level within the hours between the scheduled start time and end time of the charging timer, the charging time shows the time that exceeds the scheduled hours in the charging timer.
- If you need to confirm the estimated charging time depending on the available electrical power (supplied to the charger), see the Estimated Charge Time display. (See "Trip computer" (P.2-26).)

NOTE:

- **The displayed end time of charging is estimation. The Li-ion battery may not be charged to a full level by the estimated end time.**
- **If the charging timer and the Climate Ctrl. timer are set to operate at the same time, longer charging time will be displayed or the Li-ion battery may not be charged to a full level at the scheduled end time.**

ECO DRIVE REPORT

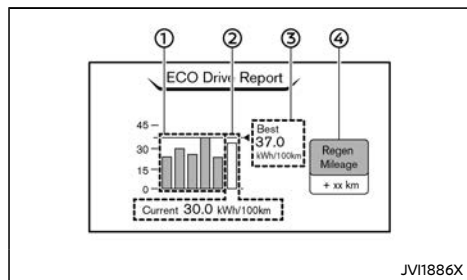

Example

- ① Previous 5 times (History)
The average energy economy for the previous 5 times will be displayed.

- ② Current energy economy
The most recent average energy economy will be displayed.
- ③ Best energy economy
The best energy economy in the history will be displayed.
- ④ Regenerated energy (mileage)
The amount of regenerated energy stored in the Li-ion battery in one trip will be displayed in terms of distance.

If the vehicle has been driven mostly on down-hill roads, more energy is regenerated. This may cause the regenerated energy (mileage) ④ to show longer distance than the vehicle was driven, or the current energy economy ② to show smaller value.

When the button on the steering wheel is pushed while the ECO Drive Report is shown, the display will be switched to the timer display. Either display will continue to be displayed for another 30 seconds when the button is operated. If the doors are locked after the power switch was placed in the OFF position, the display will turn off before the preset time.

In the Settings menu, you can set the ECO Drive Report not to appear when the power switch is placed in the OFF position. See "Settings" (P.2-15).

HEADLIGHT AND TURN SIGNAL SWITCH

HEADLIGHT SWITCH

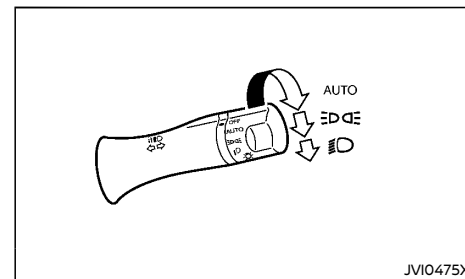

Type A

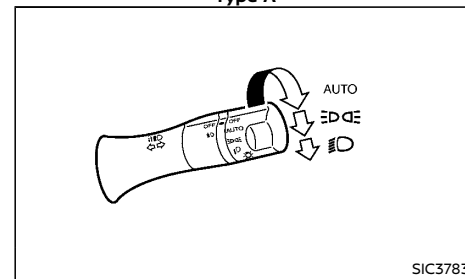

Type B

NISSAN recommends that you consult the local regulations concerning the use of lights.

position

The position turns on the front clearance, tail and license plate lights.

☾ position

The ☾ position turns on the headlights in addition to the other lights.

AUTO position

When the power switch is in the ON position and the headlight switch is in the "AUTO" position, the headlights, front clearance lights, instrument panel lights, rear combination lights and other lights turn on automatically depending on the brightness of the surroundings.

The headlights will turn on automatically at twilight or in rainy weather (when the windshield wiper is operated continuously).

When the power switch is placed in the LOCK or OFF position, the lights will turn off automatically.

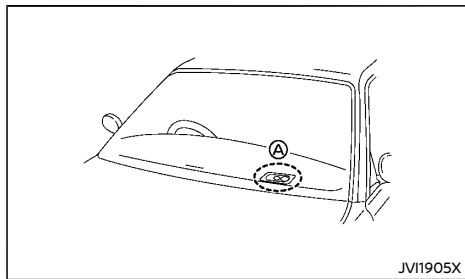

CAUTION:

Do not place any objects on top of the sensor **A**. The sensor senses the brightness level and controls the Intelligent Auto Headlight function. If the sensor is covered, it reacts as if it is dark, and the headlights will illuminate.

Headlight beam

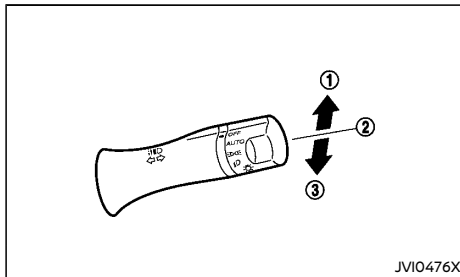

To turn on the high beam, push the lever towards the front position **1**.

To turn off the high beam, return the lever to the neutral position **2**.

To flash the headlights, pull the lever towards the rearmost position **3**. The headlights can be flashed even when the headlights are not on.

High beam assist (if equipped)

The high beam assist system will operate when the vehicle is driven at speeds of approximately 25 km/h (16 MPH) and above. If an oncoming vehicle or leading vehicle appears in front of your vehicle when the headlight high beam is on, the headlight will be switched to the low beam automatically.

Precautions on high beam assist:



WARNING:

- The high beam assist system is a convenience but it is not a substitute for safe driving operation. The driver should remain alert at all times, ensure safe driving practices and switch the high beam and low beam manually when necessary.

- The high beam or low beam may not switch automatically under the following conditions. Switch the high beam and low beam manually.

– During bad weather (rain, fog, snow, wind, etc.).

– When a light source similar to a headlight or tail light is in the vicinity of the vehicle.

– When the headlights of the oncoming vehicle or the leading vehicle are turned off, when the color of the light is affected due to foreign materials on the lights, or when the light beam is out of position.

– When there is a sudden, continuous change in brightness.

– When driving on a road that passes over rolling hills, or a road that has level differences.

– When driving on a road with many curves.

– When a sign or mirror-like surface is reflecting intense light towards the front of the vehicle.

– When the container, etc. being towed by a leading vehicle is reflecting intense light.

– When a headlight on your vehicle is damaged or dirty.

– When the vehicle is leaning at an angle due to a punctured tire, being towed, etc.

- The timing of switching the low beam and high beam may change under the following situations.

- The brightness of the headlights of the oncoming vehicle or leading vehicle.
- The movement and direction of the oncoming vehicle and the leading vehicle.
- When only one light on the oncoming vehicle or the leading vehicle is illuminated.
- When the oncoming vehicle or the leading vehicle is a two-wheeled vehicle.
- Road conditions (incline, curve, the road surface, etc.).
- The number of passengers and the amount of luggage.

High beam assist operations:

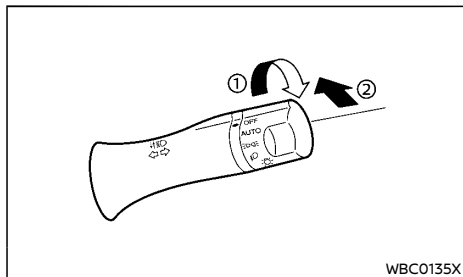

To activate the high beam assist system, turn the headlight switch to the "AUTO" position ① and push the lever forward ② (high beam position). The high beam assist indicator light in the meter will illuminate while the headlights are turned on.

If the high beam assist indicator light does not illuminate in the above condition, it may

indicate that the system is not functioning properly. Have the system checked by a NISSAN certified LEAF dealer.

When the vehicle speed lowers to less than approximately 15 km/h (9 MPH), the headlight remains the low beam.

To turn off the high beam assist system, turn the headlight switch to the position or select the low beam position by placing the lever in the neutral position.

Ambient image sensor maintenance:

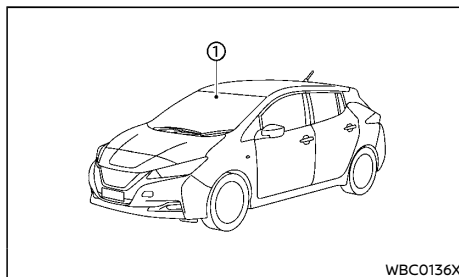

The ambient image sensor ① for the high beam assist system is located in front of the inside rearview mirror. To keep the proper operation of the high beam assist system and prevent a system malfunction, be sure to observe the following:

- Always keep the windshield clean.
- Do not attach a sticker (including transparent material) or install an accessory near the ambient image sensor.
- Do not strike or damage the areas around the ambient image sensor. Do not touch the sensor lens that is located on the ambient image sensor.

If the ambient image sensor is damaged due to

an accident, contact a NISSAN certified LEAF dealer.

Daytime running light system (if equipped)

Even if the headlight switch is off, the daytime running lights will illuminate after starting the EV system.

When the light switch is turned to the position, the daytime running lights will turn off.

HEADLIGHT AIMING CONTROL

Manual type (models with halogen headlights)

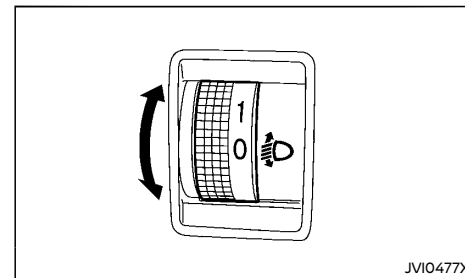

The headlight aiming control operates when the power switch is in the ON position and the headlight is on to allow the headlight axis to be adjusted according to the driving conditions.

When driving with no heavy load/luggage or driving on a flat road, select the normal position "0".

If the number of occupants and load/luggage in the vehicle changes, the headlight axis may become higher than normal.

If the vehicle is traveling on a hilly road, the

headlights may directly shine on the rearview and outside mirrors of a vehicle ahead or the windshield of an oncoming vehicle, which may obscure other drivers' vision.

To adjust to the proper aiming height, turn the switch accordingly. The higher the number, designated on the switch, the lower the headlight axis.

For Malaysia and Hong Kong:

Select the switch position by referring to the following samples.

Switch position	Number of front seat occupants	Number of rear seat occupants	Weight of load in luggage compartment
0	1 or 2	No occupants	No load
1	2	3	No load
2	2	3	Approximately 30 kg (66 lb)
3	1	No occupants	Approximately 280 kg (617 lb)

Automatic type (models with LED headlights)

The headlights are equipped with the automatic leveling system. Headlight axis is controlled automatically.

BATTERY SAVER SYSTEM



CAUTION:

Do not leave the lights on when the power switch is in the OFF, ACC or ON position for extended periods of time to prevent the 12-volt battery from being discharged.

The light reminder chime will sound if the headlight switch is in either the OFF or LOCK position and when the driver's door is opened with the power switch in the ACC, OFF or LOCK

position.

If the doors are closed and locked using the door handle request switch or the Intelligent Key, while the headlight switch is in either the OFF or LOCK position, the battery saver function will turn off the lights to prevent the 12-volt battery from being discharged. The lights will turn on when the doors are unlocked.

TURN SIGNAL SWITCH

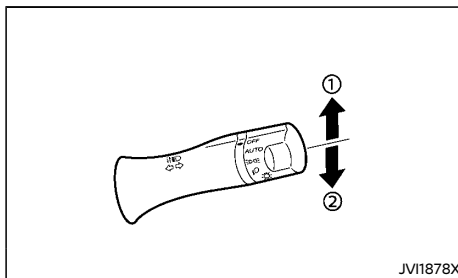

CAUTION:

The turn signal switch will not be cancelled automatically if the steering wheel turning angle does not exceed the preset amount. After the turn or lane change, make sure that the turn signal switch is returned to its original position.

Turn signal

To turn on the turn signals, move the lever up ① or down ② to the point where the lever latches. When the turn is completed, the turn signal cancels automatically.

Lane change signal

To turn on the lane change signals, move the lever up ① or down ② to the point where the light begins to flash.

If the lever is moved back right after moving up ① or down ②, the light will flash 3 times.

To cancel the flashing, move the lever to the opposite direction.

EMBLEM LIGHT (if equipped)

The emblem light illuminates when the front clearance lights are on or the power switch is in the READY to drive position.

FOG LIGHT SWITCH (if equipped)

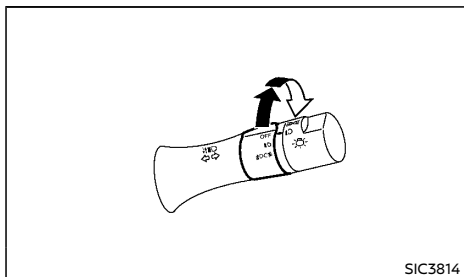

Type A (with front and rear fog lights)

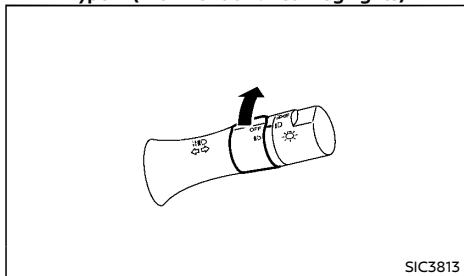

Type B (with front fog lights)

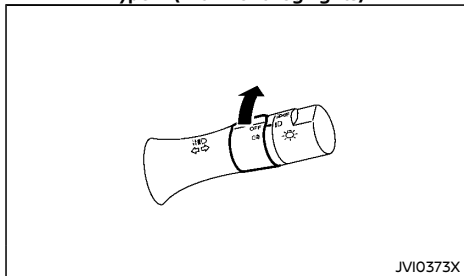

Type C (with rear fog light)

FRONT FOG LIGHTS (if equipped)

To turn on the front fog lights, turn the fog light switch to the **F** position with the headlight switch in the **ON** or **OFF** position.

To turn off the fog lights, turn the fog light switch to the "OFF" position.

REAR FOG LIGHT (if equipped)

The rear fog light should be used only when visibility is seriously reduced. [Generally, to less than 100 m (328 ft)]

For Type A: To turn on the rear fog light, turn the fog light switch to the **R** position with the headlight switch in the **ON** or **OFF** position. The switch returns to the **OFF** position automatically, and the rear fog light will illuminate with the front fog lights. Make sure the **R** indicator light on the instrument panel illuminates.

To turn off the rear fog light, turn the fog light switch to the **OFF** position again. Make sure the **R** indicator light on the instrument panel turns off.

To turn off both the front and rear fog lights, turn the fog light switch to the "OFF" position.

For Type C: To turn on the rear fog light, turn the headlight switch to the **ON** position, then turn the fog light switch to the **R** position. The switch returns to the "OFF" position automatically, and the rear fog light will illuminate. Make sure the **R** indicator light on the instrument panel illuminates.

To turn off the rear fog light, turn the fog light switch to the **OFF** position again. Make sure the **R** indicator light on the instrument panel turns off.

WIPER AND WASHER SWITCH

WARNING:

In freezing temperatures, the washer fluid may freeze on the windshield and obscure your vision. Warm the windshield with the defogger before you wash the windshield.

CAUTION:

- Do not operate the washer continuously for longer than 30 seconds.
- Do not operate the washer if the window washer reservoir is empty.

WINDSHIELD WIPER AND WASHER SWITCH

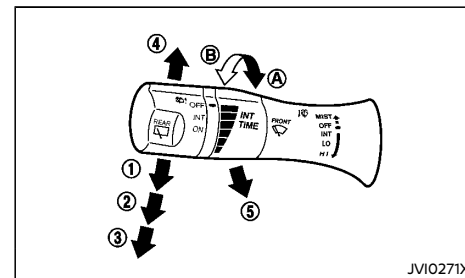

Type A

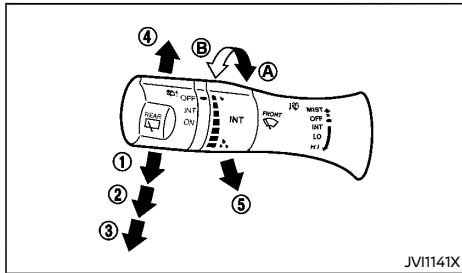

Type B

The windshield wiper and washer operate when the power switch is in the ON position.

Wiper operation

The lever position "INT" ① operates the wiper intermittently.

- The intermittent operation can be adjusted by turning the adjustment control knob, (longer) ④ or (shorter) ⑤.
- The speed of the intermittent operation varies depending on the vehicle speed. This function can be turned on or off. See "Vehicle Settings" (P.2-17).

The lever position "LO" ② operates the wiper at low speed.

The lever position "HI" ③ operates the wiper at high speed.

To stop the wiper operation, move the lever up to the "OFF" position.

The lever position "MIST" ④ operates the wiper one sweep. The lever automatically returns to its original position.

If the windshield wiper operation is interrupted by snow or ice, the wiper may stop moving to protect its motor. If this occurs, turn the wiper switch to the "OFF" position

and remove the snow or ice on and around the wiper arms. In approximately 1 minute, turn the switch on again to operate the wiper.

Washer operation

To operate the washer, pull the lever toward the rear of the vehicle ⑤ until the desired amount of washer fluid is spread on the windshield. The wiper will automatically operate several times.

Wiper drip wipe system:

The wiper will also operate once about 3 seconds after the washer and wiper are operated. This operation is to wipe washer fluid that has dripped on the windshield.

REAR WINDOW WIPER AND WASHER SWITCH

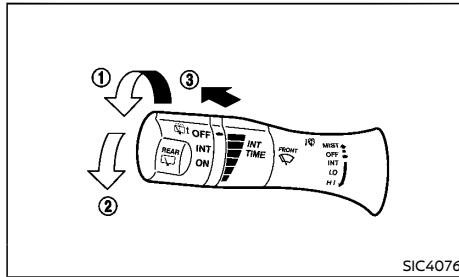

Type A

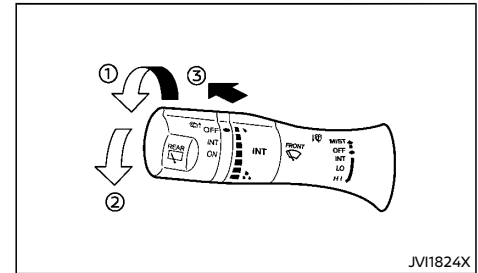

Type B

The rear window wiper and washer operates when the power switch is in the ON position.

Wiper operation

The switch position "INT" ① operates the wiper intermittently.

The switch position "ON" ② operates the wiper continuously.

If the rear window wiper operation is interrupted by snow or ice, the wiper may stop moving to protect its motor. If this occurs, turn the wiper switch to the "OFF" position and remove the snow or ice on and around the wiper arms. In approximately 1 minute, turn the switch on again to operate the wiper.

Washer operation

To operate the washer, push the lever toward the front of the vehicle ③ until the desired amount of washer fluid is spread on the windshield. The wiper will automatically operate several times.

DEFOGGER SWITCH

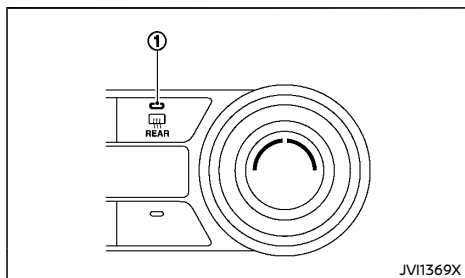

The defogger switch operates when the power switch is in the ON position.

The defogger is used to reduce the moisture, fog or frost on the rear window surface to improve the rear view.

When the defogger switch is pushed, the indicator light ① illuminates and the rear window defogger operates for approximately 15 minutes. After the preset time has passed, the defogger will turn off automatically.

To turn off manually, push the defogger switch again.

CAUTION:

- When operating the defogger continuously, be sure to start the EV system. Otherwise, it may cause the 12-volt battery to discharge.
- When cleaning the inner side of the window, be careful not to scratch or damage the electrical conductors on the surface of the window.

HORN

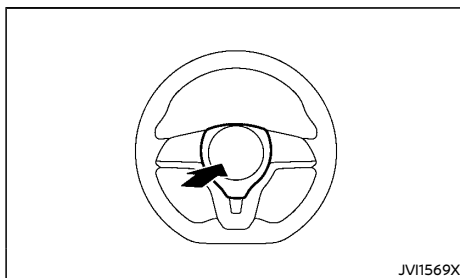

The horn switch operates regardless of the power switch position except when the 12-volt battery is discharged.

When the horn switch is pushed and held, the horn will sound. Releasing the horn switch will cease the horn sound.

WINDOWS

POWER WINDOWS

WARNING:

- Make sure that all passengers have their hands, etc. inside the vehicle before operating the power windows.
- To help avoid risk of injury or death through unintended operation of the vehicle and or its systems, including entrapment in windows or inadvertent door lock activation, do not leave children, people who require the assistance of others or pets unattended in your vehicle. Additionally, the temperature inside a closed vehicle on a warm day can quickly become high enough to cause a significant risk of injury or death to people and pets.

The power windows operate when the power switch is in the ON position.

To open a window, push down the power window switch.

To close a window, pull up the power window switch.

Driver's window switch

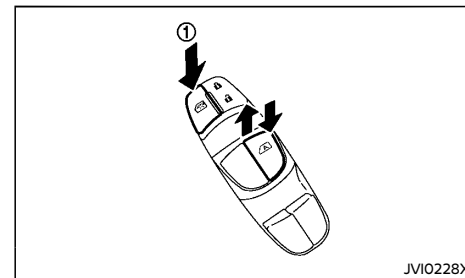

The driver's switch, the main switch, can control all windows.

Locking passenger's windows:

When the lock button ① is pushed in, the passenger's windows cannot be operated.

To cancel the passenger's windows lock, push the lock button ① again.

Passenger's window switch

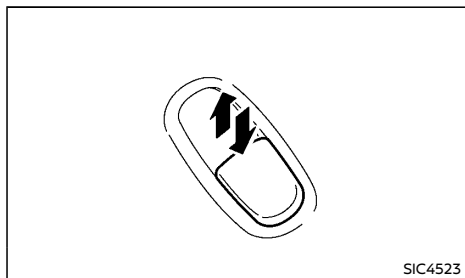

The passenger's switch can control its corresponding window.

When the passenger's windows lock button on the driver's switch is pushed in, the passenger's switch cannot be operated.

Automatic function

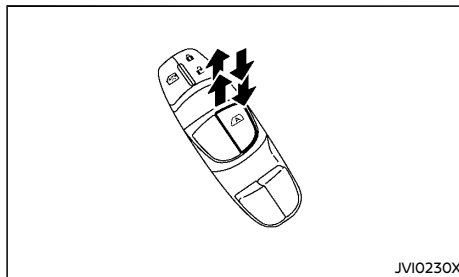

The automatic function is available for the switch that has an **A** mark on its surface.

The automatic function enables a window to fully open or close without holding the switch down or up.

To fully open the window, push the power window switch down to the second detent and release the switch. To fully close the window, pull the power window switch up to the second detent and release the switch. The switch does not have to be held during window operation.

To stop the window open/close operation during the automatic function, push down or pull up the switch in opposite directions.

Auto-reverse function:



WARNING:

There is a small distance just before the closed position which cannot be detected. Make sure that all passengers have their hands, etc. inside the vehicle before closing the windows.

The auto-reverse function enables a window to automatically reverse when something is

caught in the window as it is closing by the automatic function. When the control unit detects an obstacle, the window will be lowered immediately.

Depending on the environment or driving conditions, the auto-reverse function may activate if an impact or load similar to something being caught in the window occurs.

If the window does not close automatically

If the power window automatic function (closing only) does not operate properly, perform the following procedure to initialize the power window system.

1. Push the power switch to start the EV (Electric Vehicle) system.
2. Close the door.
3. After starting the EV system, open the window completely by operating the power window switch.
4. Pull the power window switch and hold it to close the window, and then hold the switch more than 3 seconds after the window is closed completely.
5. Release the power window switch. Operate the window by the automatic function to confirm the initialization is complete.

If the power window automatic function does not operate properly after performing the procedure above, have your vehicle checked by a NISSAN certified LEAF dealer.

POWER OUTLET

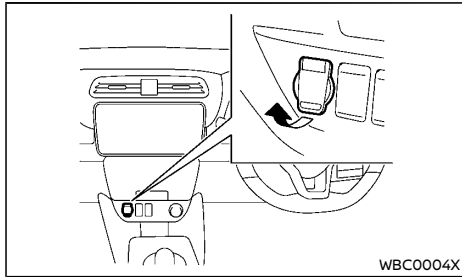

The power outlet is located in the instrument panel.

To use the power outlet, pull up the cover as illustrated.

CAUTION:

- The outlet and plug may be hot during or immediately after use.
- This power outlet is not designed for use with a cigarette lighter unit.
- Do not use with accessories that exceed a 12 volt, 120W (10A) power draw. Do not use double adapters or more than one electrical accessory.
- Use the power outlet with the power switch in the ON or READY to drive position to avoid discharging the 12-volt battery.
- Avoid using the power outlet when the air conditioner, headlights or rear window defogger is on.
- Push the plug in as far as it will go. If good contact is not made, the plug may overheat or the internal temperature fuse may blow.

- Before inserting or disconnecting a plug, be sure that the electrical accessory being used is turned OFF.
- When not in use, be sure to close the cap.
- Do not allow water or any liquid to contact the outlet.

STORAGE

WARNING:

- The storages should not be used while driving so that the full attention may be given to vehicle operation.
- Keep the storage lids closed while driving to help prevent injury in an accident or sudden stop.

GLOVE BOX

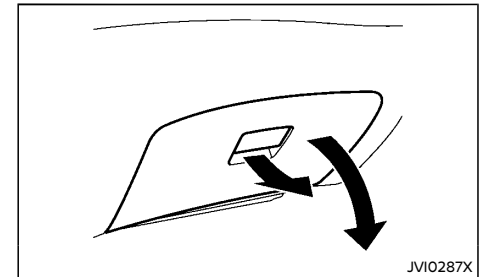

To open the glove box, pull the handle.

To close, push the lid in until the lock latches.

CUP HOLDERS

CAUTION:

- Avoid abrupt starting and braking when the cup holder is being used to prevent spilling the drink. If the liquid is hot, it can scald you or your passenger.
- Use only soft cups in the cup holder. Hard objects can injure you in an accident.

Front

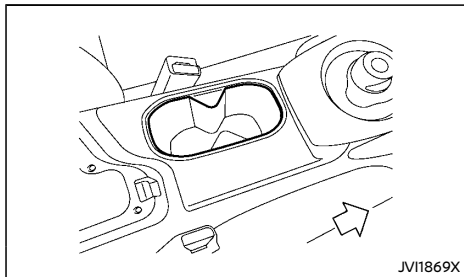

Soft bottle holders

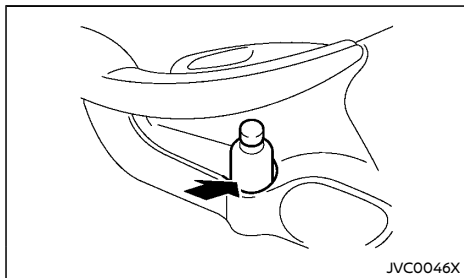

CAUTION:

- Do not use the bottle holder for any other objects that could be thrown about in the vehicle and possibly injure people during sudden braking or an accident.
- Do not use the bottle holder for open liquid containers.

CONSOLE BOX

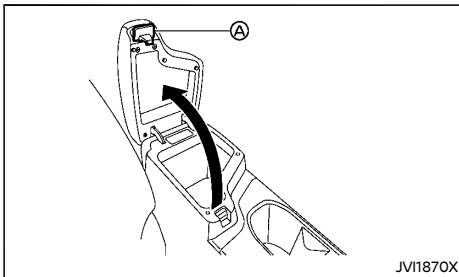

To open the console box, push up the knob **A** and pull up the lid. To close, push the lid down until it is latched.

CARGO COVER (if equipped)

WARNING:

- Never put anything on the cargo cover, no matter how small. Any object on it could cause an injury in an accident or sudden stop.
- Do not leave the cargo cover in the vehicle with it disengaged from the holder.
- Properly secure all cargo with ropes or straps to help prevent it from sliding or shifting. Do not place cargo higher than the seatbacks. In a sudden stop or collision, unsecured cargo could cause personal injury.
- Your child could be seriously injured or killed in a collision if the child restraint top tether strap is damaged.

- If the cargo cover contacts the top tether strap when it is attached to the top tether anchor, remove the cargo cover from the vehicle or secure it on the cargo floor below its attachment location. If the cargo cover is not removed, it may damage the top tether strap during a collision.
- Do not allow cargo to contact the top tether strap when it is attached to the top tether anchor. Properly secure the cargo so it does not contact the top tether strap. Cargo that is not properly secured or that contacts the top tether strap may damage the top tether strap during a collision.

The cargo cover keeps the luggage compartment contents hidden from the outside.

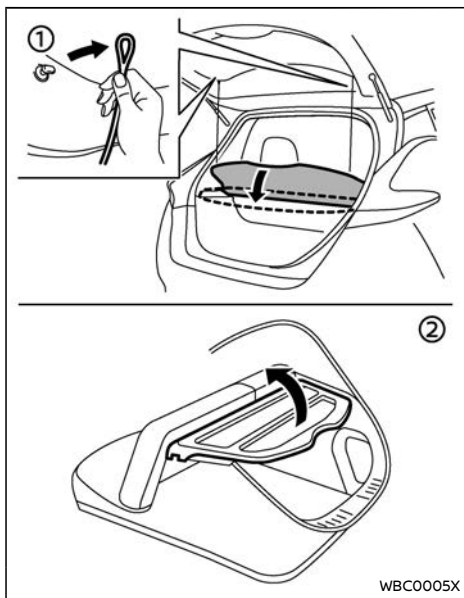

To remove the cargo cover:

1. Remove the straps from the rear hatch.
2. Pull up the cargo cover.
3. Remove the cargo cover holders from the rear pillar.

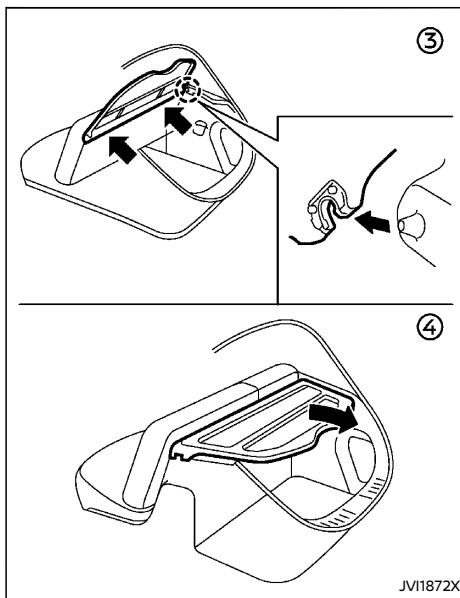

4. Remove the cargo cover by pulling backward.

STOWING GOLF BAGS

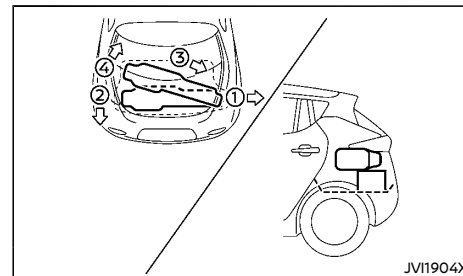

Normally, two standard golf bags can be stowed in the cargo area. Insert the top of the first golf bag into right side of the cargo area ① then rotate the bag backward ②. Insert the top of the second golf bag into right side of the cargo area ③ and stow the bottom of golf bag forward all the way ④.

In some cases, you may not be able to stow two golf bags in your vehicle, depending on their sizes or types.

NOTE:

When the EVSE (Electric Vehicle Supply Equipment) (if equipped) storage net is in the way, remove the net. See "EVSE (Electric Vehicle Supply Equipment) storage net" (P.2-41).

SUN VISORS

EVSE (Electric Vehicle Supply Equipment) (if equipped) STORAGE NET

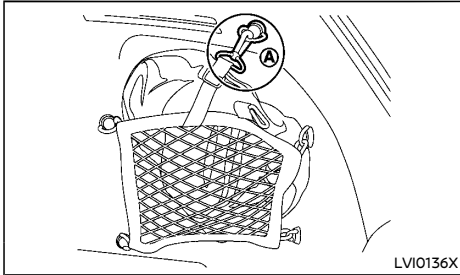

CAUTION:

The load capacity for cargo is 3.1 kg (6.8 lb). If cargo that weighs more than 3.1 kg (6.8 lb) is loaded, the storage net may break in a collision, or when the brakes are applied suddenly. If this occurs, there is a danger of the cargo becoming a projectile in the passenger compartment, which could cause a personal injury.

When taking out or putting away the storage bag, remove hook **A** from anchor. When the EVSE (Electric Vehicle Supply Equipment) (if equipped) is stored, be sure to fasten all hooks in place securely.

When you need to remove the storage net, such as for stowing a golf bag or similar item, remove all of the hooks from the anchors.

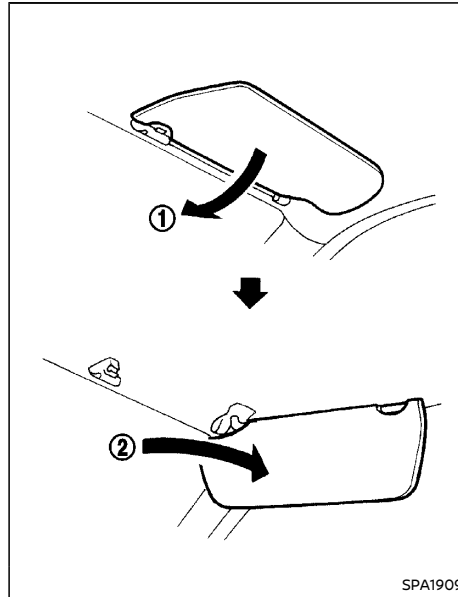

1. To block out glare from the front, swing down the sun visor ①.
2. To block glare from the side, remove the sun visor from the center mount and swing it to the side ②.

INTERIOR LIGHTS



CAUTION:

- Do not use for extended periods of time with the power switch in the OFF position. This could result in a discharged 12-volt battery.
- Turn off the lights when you leave the vehicle.

MAP LIGHTS

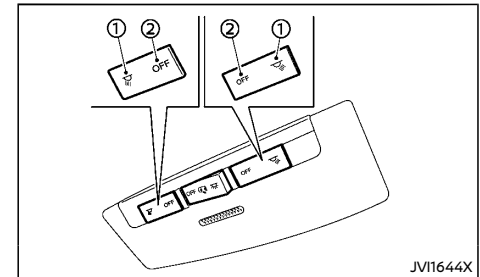

Operate the map light switch to turn the map light on or off.

- ① : ON position
② : OFF position

MAP LIGHT CONTROL SWITCH

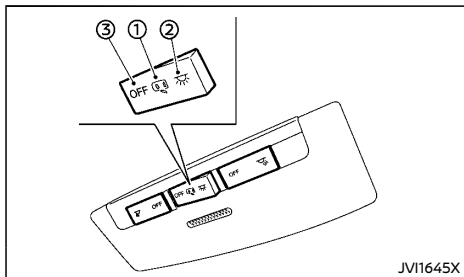

The map light control switch has three positions: DOOR ①, ON ② and OFF ③.

DOOR position

When the switch is in the door position ①, the map lights will illuminate under the following conditions:

- power switch is placed in the OFF or LOCK position
 - remain on for about 15 seconds.
- doors are unlocked by pushing the UN-LOCK  button (on the Intelligent Key) or the request switch, with the power switch in the OFF or LOCK position
 - remain on for about 15 seconds.
- any door is opened and then closed with the power switch in the OFF or LOCK position
 - remain on for about 15 seconds.
- any door is opened with the power switch in the ACC or ON position
 - remain on while the door is opened. When the door is closed, the lights go off.

ON position

When the switch is in the ON position ②, the map lights will illuminate.

OFF position

When the switch is in the OFF position ③, the map lights will not illuminate, regardless of any other condition.

ROOM LIGHT

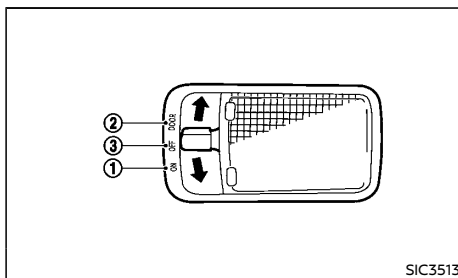

The room light switch has three positions: ON ①, DOOR ② and OFF ③.

ON position

When the switch is in the ON position ①, the room light will illuminate.

DOOR position

When the switch is in the DOOR position ②, the room light will illuminate under the following conditions:

- the power switch is placed in the OFF or LOCK position.
 - remains on for about 15 seconds.
- doors are unlocked by pushing the UN-LOCK  button or the request switch, with the power switch in the OFF or LOCK

position

- remains on for about 15 seconds.
- any door is opened and then closed with the power switch in the OFF or LOCK position
 - remains on for about 15 seconds.
- any door is opened with the power switch in the ACC or ON position
 - remains on while the door is opened. When the door is closed, the light turns off.

OFF position

When the switch is in the OFF position ③, the room light will not illuminate, regardless of the condition.

CARGO LIGHT

The cargo light will illuminate when the rear hatch is opened. When the rear hatch is closed, the light will turn off.

BATTERY SAVER SYSTEM

The interior lights will automatically turn off after a period of time when the lights remain illuminated to prevent the 12-volt battery from becoming discharged.

3 Pre-driving checks and adjustments

Keys	3-2	Rear hatch	3-11
Intelligent Keys	3-2	Opening rear hatch	3-12
Doors	3-3	Closing rear hatch	3-12
Locking with mechanical key	3-3	Rear hatch release lever	3-12
Locking with inside lock knob	3-3	Charge port lid	3-13
Locking with power door lock switch	3-4	Opening charge port lid	3-13
Child safety rear door lock	3-4	Charge port cap	3-13
Intelligent Key system	3-4	Steering wheel	3-14
Intelligent Key operating range	3-5	Tilt operation	3-14
Using Intelligent Key system	3-6	Mirrors	3-14
12-volt battery saver system	3-7	Inside rearview mirror	3-14
Warning signals	3-7	Outside rearview mirrors	3-18
Troubleshooting guide	3-8	Vanity mirror	3-19
Using remote keyless entry function	3-9	Parking brake	3-19
Security system	3-10	Pedal type	3-19
NISSAN Anti-Theft System (NATS)	3-10	Switch type (model with electronic parking brake system)	3-20
Hood	3-10		

KEYS

Your vehicle can only be driven with the keys specific to your vehicle. A key number plate is supplied with your key. Record the key number and keep the key number plate in a safe place, except in the vehicle, in case of the need to duplicate the keys.

The key can only be duplicated using an original key or the original key number. The key number is required when you have lost all of the keys and do not have the original key to duplicate from. If the key is lost, or you need extra keys, provide an original key or the key number to a NISSAN certified LEAF dealer.



CAUTION:

Do not leave the keys inside the vehicle when leaving the vehicle.

INTELLIGENT KEYS

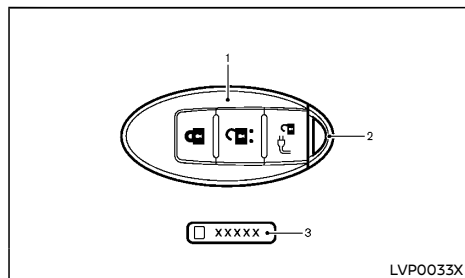

Type A (without panic alarm)

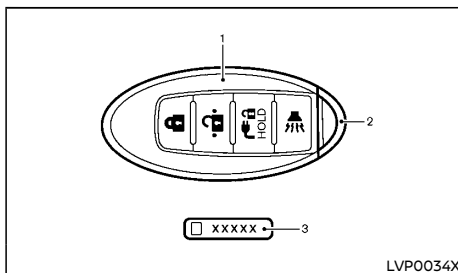

Type B (with panic alarm)

1. Intelligent Key (2)
2. Mechanical key (inside Intelligent Key) (2)
3. Key number plate (1)

Your vehicle can only be driven with the Intelligent Keys which are registered to your vehicle's Intelligent Key system components and NISSAN Anti-Theft System (NATS*) components. As many as 4 Intelligent Keys can be registered and used with one vehicle. The new keys must be registered by a NISSAN certified LEAF dealer prior to use with the Intelligent Key system and NATS of your vehicle. Since the registration process requires erasing all memory in the Intelligent Key components when registering new keys, be sure to take all Intelligent Keys that you have to the NISSAN certified LEAF dealer. It is possible that the Intelligent Key functions became canceled. Contact a NISSAN certified LEAF dealer.

*:Immobilizer



CAUTION:

- **Be sure to carry the Intelligent Key with you when driving. The Intelligent Key is a precision device with a built-in transmitter. To avoid damaging it, please note the**

following.

- **The Intelligent Key is water resistant; however, wetting may damage the Intelligent Key. If the Intelligent Key gets wet, immediately wipe until it is completely dry.**
- **Do not bend, drop or strike it against another object.**
- **If the outside temperature is below -10°C (14°F), the battery of the Intelligent Key may not function properly.**
- **Do not place the Intelligent Key for an extended period in a place where temperatures exceed 60°C (140°F).**
- **Do not change or modify the Intelligent Key.**
- **Do not use a magnet key holder.**
- **Do not place the Intelligent Key near an electric appliance such as a television set, personal computer or cellular phone.**
- **Do not allow the Intelligent Key to come into contact with water or salt water, and do not wash it in a washing machine. This could affect the system function.**
- **If an Intelligent Key is lost or stolen, NISSAN recommends erasing the ID code of that Intelligent Key. This will prevent the Intelligent Key from unauthorized use to unlock the vehicle. For information regarding the erasing procedure, please contact a NISSAN certified LEAF dealer.**

DOORS

Mechanical key

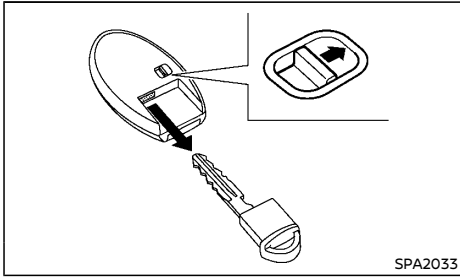

To remove the mechanical key, release the lock knob at the back of the Intelligent Key.

To install the mechanical key, firmly insert it into the Intelligent Key until the lock knob returns to the lock position.

Use the mechanical key to lock or unlock the driver's side door. (See "Doors" (P.3-3).)



WARNING:

- Always look before opening any doors, to avoid an accident with oncoming traffic.
- To help avoid risk of injury or death through unintended operation of the vehicle and or its systems, including entrapment in windows or inadvertent door lock activation, do not leave children, people who require the assistance of others or pets unattended in your vehicle. Additionally, the temperature inside a closed vehicle on a warm day can quickly become high enough to cause a significant risk of injury or death to people and pets.

LOCKING WITH MECHANICAL KEY

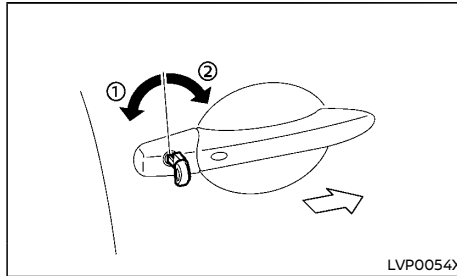

To lock the door, insert the key into the door key cylinder located on the driver's side door, and turn the key to the rear of the vehicle ①. The driver's side door will lock.

To unlock the door, turn the key to the front of the vehicle ②. The driver's side door will unlock.

To lock or unlock the other doors, use the power door lock switch, the "LOCK"  or

"UNLOCK"  button on the Intelligent Key or any request switch.

LOCKING WITH INSIDE LOCK KNOB

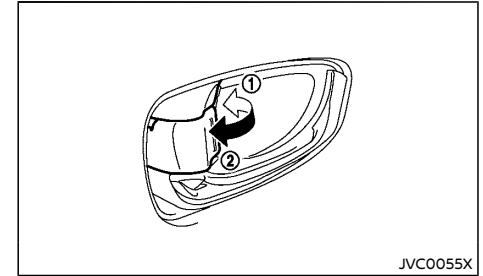

CAUTION:

When locking the door using the inside lock knob, be sure not to leave the key inside the vehicle.

To lock the front doors without key, move the inside lock knob to the lock position ①, and then close the door while pulling the door handle.

To lock the rear doors without the key, move the inside lock knob to the lock position ① then close the door.

To unlock, move the inside lock knob to the unlock position ②.

When the front door is locked, pulling the front door handle will unlock the front door.

LOCKING WITH POWER DOOR LOCK SWITCH



CAUTION:

When locking the doors using the power door lock switch, be sure not to leave the key in the vehicle.

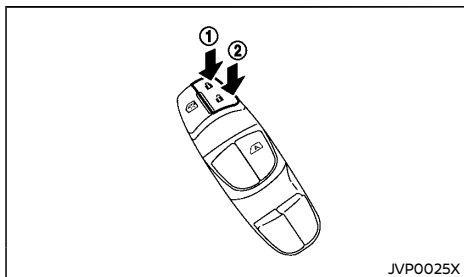

Operating the power door lock switch will lock or unlock all the doors.

To lock the doors, push the power door lock switch to the lock position ① with the driver's door open, then close the door while pulling the outside door handle.

To unlock the doors, push the power door lock switch to the unlock position ②.

CHILD SAFETY REAR DOOR LOCK

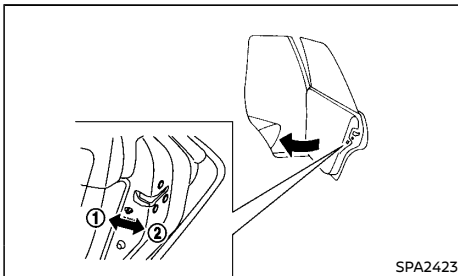

Child safety rear door locks help prevent the rear doors from being opened accidentally, especially when small children are in the vehicle.

When the levers are in the lock position ①, the rear doors can be opened only from the outside.

To disengage, move the levers to the unlock position ②.

INTELLIGENT KEY SYSTEM



WARNING:

- Radio waves could adversely affect electric medical equipment. Those who use a pacemaker should contact the electric medical equipment manufacturer for the possible influences before use.
- The Intelligent Key transmits radio waves when the buttons are pushed. The radio waves may affect aircraft navigation and communication systems. Do not operate the Intelligent Key while on an airplane. Make sure the buttons are not operated unintentionally when the unit is stored during a flight.

The Intelligent Key system can operate all the door and the rear hatch locks by using the remote controller function or pushing the request switch on the vehicle without taking the key out from a pocket or purse. The operating environment and/or conditions may affect the Intelligent Key system operation.

Be sure to read the following items before using the Intelligent Key system.



CAUTION:

- Be sure to carry the Intelligent Key with you when operating the vehicle.
- Never leave the Intelligent Key in the vehicle when you leave the vehicle.

The Intelligent Key is always communicating with the vehicle because it receives radio waves. The Intelligent Key system transmits weak radio waves. Environmental conditions may interfere with the operation of the Intelligent Key system under the following operating conditions.

- When operating near a location where strong radio waves are transmitted, such as a TV tower, power station or broadcasting station.
- When in possession of wireless equipment, such as a cellular phone, transceiver or CB radio.
- When the Intelligent Key is in contact with or covered by metallic materials.
- When any type of radio wave remote control is used nearby.
- When the Intelligent Key is placed near an electric appliance such as a personal computer.
- When the vehicle is parked near a parking meter.

In such cases, correct the operating conditions before using the Intelligent Key function or use the mechanical key.

Although the life of the battery varies depending on the operating conditions, the battery's life is approximately 2 years. If the battery is discharged, replace it with a new one.

When the Intelligent Key battery is almost discharged, see "Intelligent Key battery discharge" (P.5-5) to start the EV (Electric Vehicle) system.

Since the Intelligent Key is continuously receiving radio waves, if the key is left near equipment that transmits strong radio waves, such as signals from a TV or personal computer, the battery life may become shorter.

For information regarding replacement of a battery, see "Intelligent Key battery replacement" (P.8-12).

As many as 4 Intelligent Keys can be registered and used with one vehicle. For information about the purchase and use of additional Intelligent Keys, contact a NISSAN certified LEAF dealer.

dealer.



CAUTION:

- **Do not allow the Intelligent Key, which contains electrical components, to come into contact with water or salt water. This could affect the functioning of the system.**
- **Do not drop the Intelligent Key.**
- **Do not strike the Intelligent Key sharply against another object.**
- **Do not change or modify the Intelligent Key.**
- **The Intelligent Key may be damaged if it gets wet. If the Intelligent Key gets wet, immediately wipe until it is completely dry.**
- **If the outside temperature is below -10°C (14°F), the battery of the Intelligent Key may not function properly.**
- **Do not place the Intelligent Key for an extended period in an area where temperatures exceed 60°C (140°F).**
- **Do not attach the Intelligent Key to a key holder that contains a magnet.**
- **Do not place the Intelligent Key near equipment that produces a magnetic field, such as a TV, audio equipment, personal computer or cellular phone.**

If an Intelligent Key is lost or stolen, NISSAN recommends erasing the ID code of that Intelligent Key from the vehicle. This may prevent the unauthorized use of the Intelligent Key to operate the vehicle. For information regarding the erasing procedure, contact a NISSAN certified LEAF dealer.

The Intelligent Key function can be disabled.

For information about disabling the Intelligent Key function, contact a NISSAN certified LEAF dealer.

INTELLIGENT KEY OPERATING RANGE

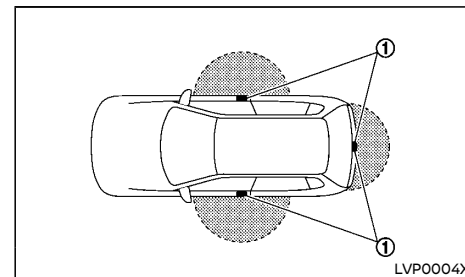

The Intelligent Key functions can only be used when the Intelligent Key is within the specified operating range from the request switch ①.

When the Intelligent Key battery is discharged or strong radio waves are present near the operating location, the Intelligent Key system's operating range becomes narrower, and the Intelligent Key may not function properly.

The operating range is within 80 cm (31.50 in) from each request switch ①.

If the Intelligent Key is too close to the door glass, handle or rear bumper, the request switches may not function.

When the Intelligent Key is within the operating range, it is possible for anyone who does not carry the Intelligent Key to push the request switch to lock/unlock the doors including the rear hatch.

USING INTELLIGENT KEY SYSTEM

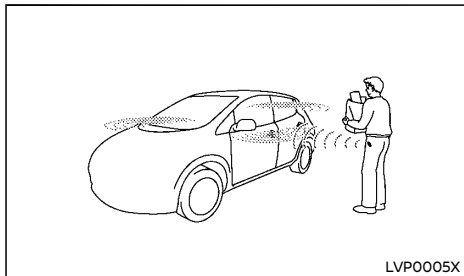

The request switch will not function under the following conditions:

- When the Intelligent Key is left inside the vehicle
- When the Intelligent Key is not within the operational range
- When any door is open or not closed securely
- When the Intelligent Key battery is discharged
- When the power switch is in the ON position

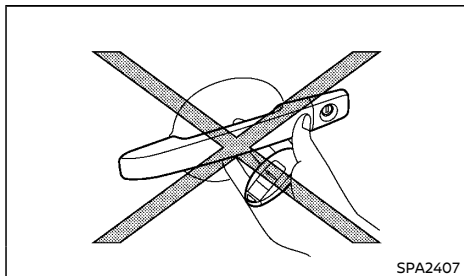

- Do not push the door handle request switch with the Intelligent Key held in your hand as illustrated. The close distance to the door handle will cause the Intelligent Key system to have difficulty recognizing that the Intelligent Key is outside the vehicle.
- After locking with the door handle request switch, make sure that the doors have been securely locked by operating the door handles.
- When locking the doors using the door handle request switch, make sure to have the Intelligent Key in your possession before operating the door handle request switch to prevent the Intelligent Key from being left in the vehicle.
- The door handle request switch is operational only when the Intelligent Key has been detected by the Intelligent Key system.
- Do not pull the door handle before pushing the door handle request switch. The door will be unlocked but will not open. Release the door handle once and pull it again to open the door.

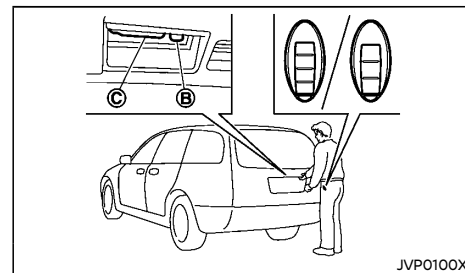
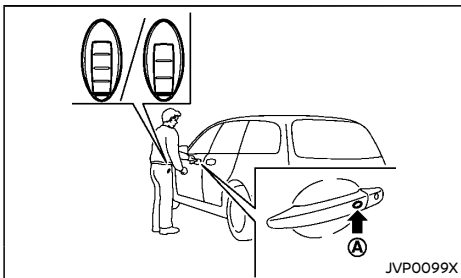

You can lock or unlock the doors without taking the key out from your pocket or bag.

When you carry the Intelligent Key with you, you can lock or unlock all doors by pushing the door handle request switch (driver's or front passenger's) **A** or rear hatch request switch **B** within the range of operation.

When you lock or unlock the doors or the rear hatch, the hazard indicator will flash as a confirmation.

Welcome light and farewell light function (if equipped)

When you lock or unlock the doors, the emblem light, front clearance lights, tail lights and the license plate lights will illuminate for a period of time.

Locking doors

1. Push the power switch to the OFF position.
2. Carry the Intelligent Key with you.
3. Close all the doors and the rear hatch.
4. Push the door handle request switch (driver's or front passenger's) **A** or the rear hatch request switch **B** while carrying the Intelligent Key with you.

5. All the doors and the rear hatch will lock.

Lockout protection:

To prevent the Intelligent Key from being accidentally locked in the vehicle, lockout protection is equipped with the Intelligent Key system.

- When the Intelligent Key is left in the vehicle and you try to lock the door using the power door lock switch or the driver's inside lock knob after getting out of the vehicle, all the doors will unlock automatically and a chime will sound after the door is closed.
- When the Intelligent Key is left in the vehicle while the driver's door is opened and you try to lock the door using the power door lock switch after getting out of the vehicle, all the doors will unlock automatically after the power door lock switch is operated.



CAUTION:

The lockout protection may not function under the following conditions:

- When the Intelligent Key is placed on top of the instrument panel.
- When the Intelligent Key is placed on the cargo cover (if equipped).
- When the Intelligent Key is placed inside of the glove box.
- When the Intelligent Key is placed inside of the door pockets.
- When the Intelligent Key is placed inside or near metallic materials.

The lockout protection may function when the Intelligent Key is outside the vehicle but is too close to the vehicle.

Unlocking doors

1. Carry the Intelligent Key.
2. Push the door handle request switch (driver's or front passenger's) (A) or the rear hatch request switch (B) once while carrying the Intelligent Key with you.
3. All doors and the rear hatch will be unlocked.
4. Operate the door handles to open the doors.

Automatic relock:

All doors will be locked automatically unless one of the following operations is performed within 30 seconds after pushing the request switch while the doors are locked.

- Opening any door.
- Pushing the power switch.

If during the preset time period the "UNLOCK" button on the Intelligent Key is pushed, all doors will be locked automatically after the next preset time.

Opening rear hatch

1. Carry the Intelligent Key.
2. Push the rear hatch opener switch (C).
3. The rear hatch will unlock and open.

12-VOLT BATTERY SAVER SYSTEM

When all the following conditions are met for a period of time, the battery saver system will cut off the power supply to prevent 12-volt battery discharge.

- The power switch is in the ACC position,
- All doors are closed, and
- The vehicle is in the P (Park) position.

WARNING SIGNALS

To help prevent the vehicle from moving unexpectedly by erroneous operation of the Intelligent Key listed on the following chart or to help prevent the vehicle from being stolen, chime or beep sounds inside and outside the vehicle and a warning displays in the vehicle information display.

When a chime or beep sounds or the warning displays, be sure to check the vehicle and Intelligent Key.

See "Troubleshooting guide" (P.3-8) and "Vehicle information display warnings and indicators" (P.2-21).

TROUBLESHOOTING GUIDE

Symptom		Possible cause	Action to take
When opening the driver's door to get out of the vehicle	The inside warning chime sounds continuously.	The power switch is pushed to the OFF position while the driver's door is open.	Close the driver's door.
		The power switch is in the ACC position.	Push the power switch to the OFF position then close the driver's door.
When closing the door after getting out of the vehicle	The KEY is not detected warning appears on the display, the outside chime sounds 3 times and the inside warning chime sounds for a few seconds.	The power switch is in the ACC or ON position.	Push the power switch to the OFF position.
	The outside chime sounds continuously.	The power switch is in the ACC or OFF position, the electric shift control system has malfunctioned and the vehicle cannot be placed in the P (Park) position when the parking brake is not applied.	Make sure the parking brake is applied.
When closing the door with the inside lock knob turned to LOCK	The outside chime sounds for a few seconds and all the doors unlock.	The Intelligent Key is inside the vehicle or cargo area.	Carry the Intelligent Key with you.
When pushing the request switch or the "LOCK"  button on the Intelligent Key to lock the door	The outside chime sounds for a few seconds.	The Intelligent Key is inside the vehicle or a cargo area.	Carry the Intelligent Key with you.
		A door is not closed securely.	Close the door securely.
When pushing the power switch in the READY to drive position	The Intelligent Key battery discharge indicator appears on the display.	The Intelligent Key battery charge is low.	Replace the battery with a new one. See "Intelligent Key battery replacement" (P.8-12).
	The Key is not detected warning appears on the display and the inside warning chime sounds for a few seconds.	The Intelligent Key is not in the vehicle.	Carry the Intelligent Key with you.
When pushing the power switch	The Intelligent Key system warning indicator appears on the display.	It warns of a malfunction with the Intelligent Key system.	Contact a NISSAN certified LEAF dealer.

USING REMOTE KEYLESS ENTRY FUNCTION

Operating range

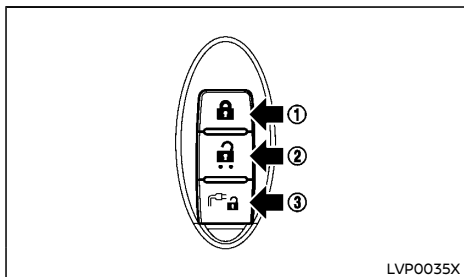

Type A (without panic alarm)

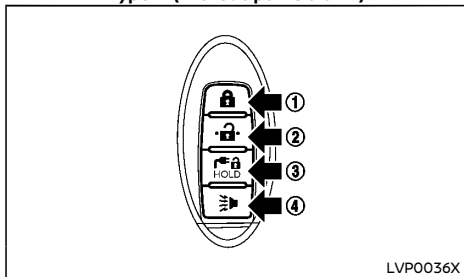

Type B (with panic alarm)

It is possible to lock/unlock all doors including the rear hatch using the remote keyless entry system. The operating distance depends upon the conditions around the vehicle. To securely operate the lock and unlock buttons, approach the vehicle to about 1 m (3.3 ft) from the door. The remote keyless entry system will not function under the following conditions:

- When the Intelligent Key is not within the operational range.
- When the Intelligent Key battery is discharged.

For information regarding the replacement of a battery, see "Intelligent Key battery replacement" (P.8-12).

Locking doors

1. Place the power switch in the OFF position and carry the Intelligent Key.
2. Close all doors and the rear hatch.
3. Push the "LOCK"  button ① on the Intelligent Key.
4. All doors and the rear hatch will be locked.
5. Operate the door handles to confirm that the doors have been securely locked.



CAUTION:

After locking the doors using the Intelligent Key, be sure that the doors have been securely locked by operating the door handles.

Unlocking doors

1. Push the "UNLOCK"  button ② on the Intelligent Key.
2. All doors and the rear hatch will be unlocked.

Automatic relock:

All doors will be locked automatically unless one of the following operations is performed within 30 seconds after pushing the "UNLOCK"  button ② on the Intelligent Key while the doors are locked. If during this 30-second time period, the UNLOCK button on the Intelligent Key is pushed, all doors will be locked auto-

matically after another 30 seconds.

- Opening any door or rear hatch.
- Pushing the power switch.



Opening charge port lid

The charge port lid may be opened by pushing and holding the charge port lid opener button ③.

For additional information, see "Charge port lid" (P.3-13).



Using panic alarm (if equipped)

If you are near your vehicle and feel threatened, you may activate the alarm to call attention as follows:

1. Push the PANIC  button ④ on the Intelligent Key for **more than 1 second**.
2. The theft warning alarm will stay on for 25 seconds.
3. The panic alarm stops when:
 - It has run for 25 seconds, or
 - Any of the buttons on the Intelligent Key is pushed. (Note: the PANIC  button must be pushed for more than 1 second.)

Sleep mode

In the sleep mode, you cannot lock or unlock the doors by using the door handle request switch and start the EV system.

- Push the "UNLOCK"  button ② twice while pushing and holding the "LOCK"  button ①. After approximately 1 second, the buzzer will sound and the hazard indicator will flash when the sleep mode is activated.
- To cancel the sleep mode, push any button on the Intelligent Key.

SECURITY SYSTEM

Your vehicle is equipped with NISSAN Anti-Theft System (NATS).

The security condition will be shown by the security indicator light.

(* immobilizer)

NISSAN ANTI-THEFT SYSTEM (NATS)

The NISSAN Anti-Theft System (NATS) will not allow the EV (Electric Vehicle) system to start without the use of the registered NATS key.

If the power switch cannot be placed in the READY to drive position using the registered NATS key, it may be due to interference caused by:

- Another NATS key.
- Other devices that transmit similar signals.

Place the power switch in the READY to drive position using the following procedure:

1. Remove any items that may be causing the interference away from the NATS key.
2. Leave the power switch in the ON position for approximately 5 seconds.
3. Place the power switch in the OFF position, and wait approximately 10 seconds.
4. Repeat steps 2 and 3 again.
5. Place the power switch in the READY to drive position.
6. Repeat the steps above until all possible interference is eliminated.

If this procedure allows the power switch to be placed in the READY to drive position, NISSAN recommends placing the registered NATS key separate from other devices to avoid interference.

Security indicator light

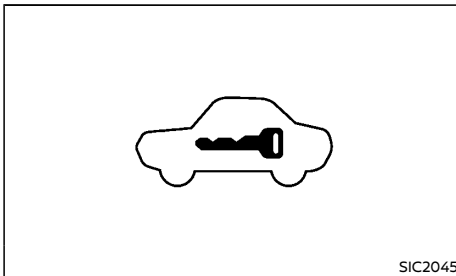

The security indicator light is located on the meter panel. It indicates the status of NATS.

The light operates whenever the power switch is in the LOCK, OFF or ACC position. The security indicator light indicates that the security systems on the vehicle are operational.

If NATS is malfunctioning, this light will remain on while the power switch is in the ON position.

NOTE:

If the light remains on and/or the power switch cannot be placed in the READY to drive position, contact a NISSAN certified LEAF dealer for NATS service as soon as possible. Be sure to bring all NATS keys that you have when visiting a NISSAN certified LEAF dealer for service.

HOOD



WARNING:

- **Make sure that the hood is completely closed and latched before driving. Failure to do so could cause the hood to open during driving and result in an accident.**
- **If steam or smoke is emitting from the motor compartment, do not open the hood. Doing so could cause an injury.**

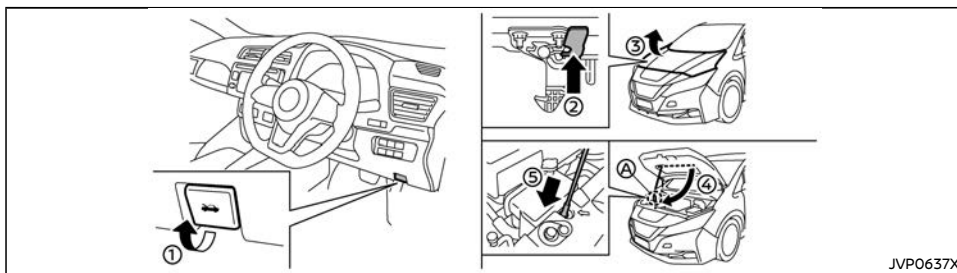

JVP0637X

When opening the hood:

1. Pull the hood release handle ① located below the instrument panel. The hood will then spring up slightly.
2. Locate the lever ② in between the hood and charge port lid, and push the lever upward with your fingertips.
3. Raise the hood ③.
4. Remove the support rod ④ from the hood and insert it into the slot ⑤.

Hold the coated part A when removing or resetting the support rod. Avoid direct contact with the metal parts because they may be hot immediately after the EV (Electric Vehicle) system has been stopped.

When closing the hood:

1. While supporting the hood, return the support rod to its original position.
2. Slowly lower the hood to about 20 to 30 cm (8 to 12 in) above the hood lock, then let it drop.
3. Make sure it is securely latched.

REAR HATCH

! WARNING:

- Always make sure that the rear hatch has been closed securely to prevent it from opening while driving.
- Do not drive with the rear hatch open.
- Make sure that all passengers have their hands, etc. inside the vehicle before closing the rear hatch.

! CAUTION:

- Before opening the rear hatch, be sure to clear away snow, ice or dust that may be stuck to the rear hatch. If the rear hatch is opened while materials are still stuck to it, it may suddenly close again due to the weight of these materials.
- Always be sure to fully open the rear hatch. If it is not fully opened, it may suddenly shut.
- Be especially careful when opening the rear hatch in strong wind. The rear hatch could be caught by a gust of wind and may close suddenly.

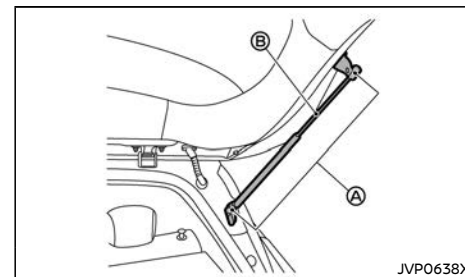

JVP0638X

CAUTION:

- The rear hatch gas stays **A** are installed in order to support the weight of the rear hatch. In order to prevent the gas stays being damaged or not operating properly, be sure to observe the following points.
 - Do not insert hands or cords into the gas stays **A** or apply any force to them laterally.
 - Do not attach any adhesive foreign materials such as pieces of plastic or stickers to the rod **B** portion.
- Do not close the rear hatch while holding the gas stays or hang anything on them. Doing so may lead to hands or arms becoming trapped in the rear hatch and could result in an injury.

OPENING REAR HATCH

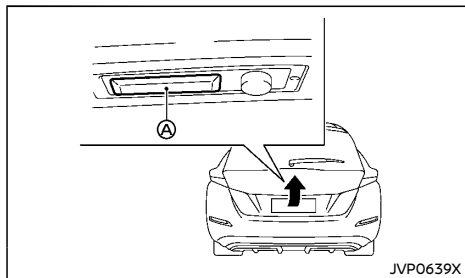

To open the rear hatch, unlock it and push the rear hatch opener switch **A**. Pull up the rear hatch to open.

The rear hatch can be unlocked by:

- pushing the UNLOCK  button on the Intelligent Key. (See "Intelligent Key system" (P.3-4).)
- pushing the rear hatch request switch with the Intelligent Key carried with you. (See "Intelligent Key system" (P.3-4).)
- pushing the power door lock switch to the unlock position.

CLOSING REAR HATCH

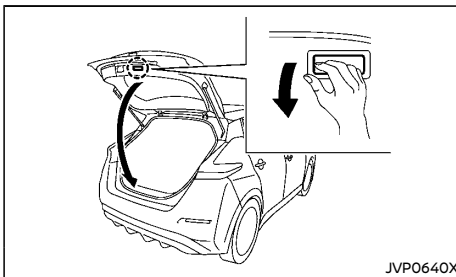

WARNING:

- Do not shut the rear hatch with one hand and the other hand remaining on the rear hatch or vehicle body. Doing so may lead to your hand becoming trapped and could result in an injury.
- When closing the rear hatch, do not place your hands near the edge of the rear hatch. Always be sure to close the rear hatch from the outside.
- After closing the rear hatch, be sure to check that it has been closed securely. If the rear hatch opens while the vehicle is being driven, this could result in a serious accident.

To close the rear hatch, hold the door grip to pull down the door and then push it down securely.

REAR HATCH RELEASE LEVER

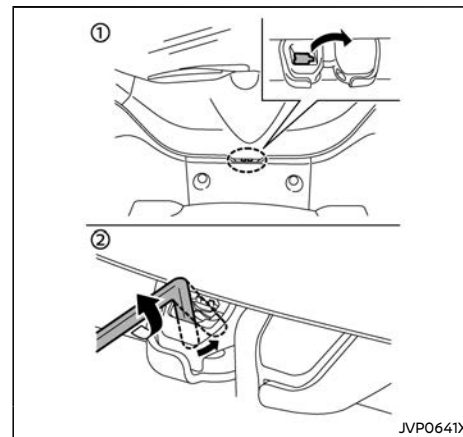

If the rear hatch cannot be unlocked due to a discharged 12-volt battery, follow these steps.

1. Fold the rear seats down. (See "Rear seats" (P.1-4).)
2. Remove the cover inside of the rear hatch with a suitable tool.
3. Move the lever toward the direction as illustrated to open the rear hatch.

Contact a NISSAN certified LEAF dealer as soon as possible for repair.

CHARGE PORT LID

OPENING CHARGE PORT LID



CAUTION:

Make sure that the charge port lid is completely closed and latched before driving. Failure to do so could cause the lid to open suddenly during driving.

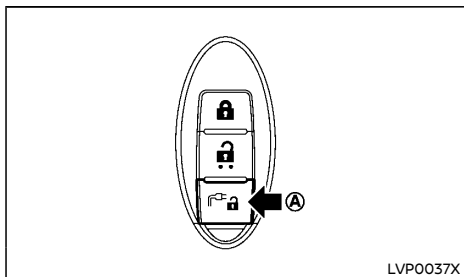

Type A (without panic alarm)

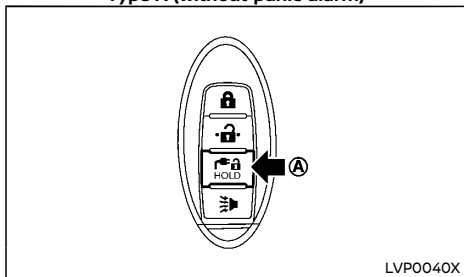

Type B (with panic alarm)

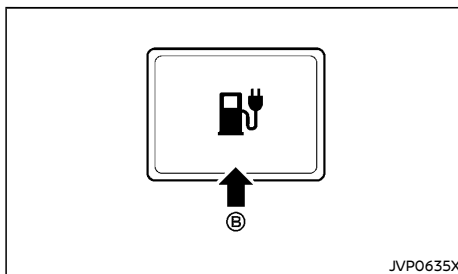

When opening the charge port lid:

1. To open the charge port lid, perform one of the following operations:
 - Push and hold the charge port lid opener button (A) on the Intelligent Key for more than 1 second, or
 - Push the charge port lid opener switch (B) located on the instrument panel.

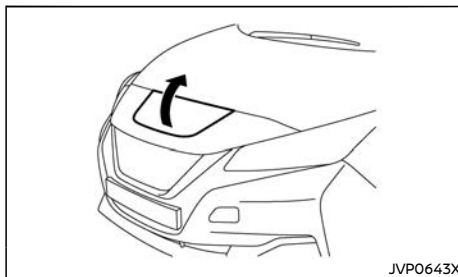

2. Put your hand into the under side of the lid and open until it is in the fully open position.

When closing the charge port lid:

1. Slowly move the lid down.

2. Lock it securely into place.

CHARGE PORT CAP

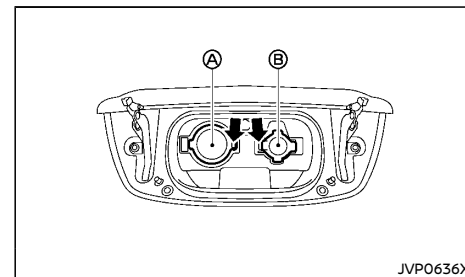

Type 1

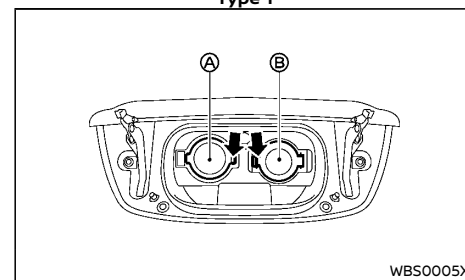

Type 2

(A): Quick charge port

(B): Normal charge port

When opening the charge port cap, push the tab and open the cap.

When the charge port cap is closed to its previous position, it will lock automatically.

CAUTION:

- When charging is finished, be sure to close the charge port cap. If water or dust gets inside the charge port, this may cause a malfunction.
- Pay particular attention when using the normal charge port as the charge port lid can be closed even when the normal charge port cap is open.
- Close the quick charge port cap before closing the charge port lid. The quick charge port cap can be damaged if it is open when closing the charge port lid.

STEERING WHEEL

WARNING:

Never adjust the steering wheel while driving so that full attention may be given to vehicle operation.

TILT OPERATION

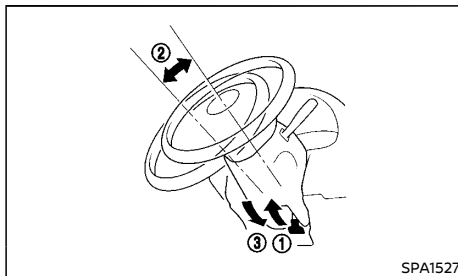

While pulling the lock lever up ①, adjust the steering wheel up or down ② until the desired position is achieved.

Push the lock lever down ③ firmly to lock the steering wheel in place.

MIRRORS

WARNING:

Adjust the position of all mirrors before driving. Do not adjust the mirror positions while driving so that full attention may be given to vehicle operation.

INSIDE REARVIEW MIRROR

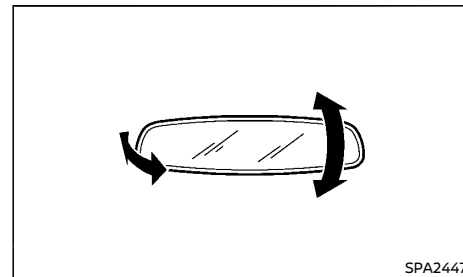

While holding the inside rearview mirror, adjust the mirror angles until the desired position is achieved.

Manual anti-glare type (if equipped)

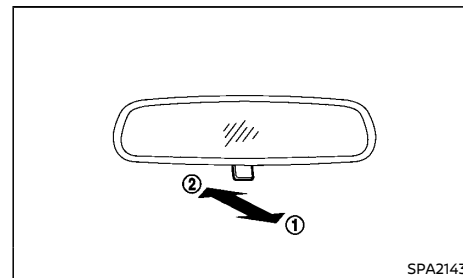

Pull the adjusting lever ① when the glare from

the headlights of the vehicle behind you obstructs your vision at night.

Push the adjusting lever ② during the day for the best rearward visibility.

Intelligent Rear View Mirror (if equipped)

WARNING:

Failure to follow the warnings and instructions for proper use of the Intelligent Rear View Mirror could result in serious injury or death.

- The Intelligent Rear View Mirror is a convenience feature but it is not a substitute for proper vehicle operation. The system has areas where objects cannot be viewed. Check the blind spot of the Intelligent Rear View Mirror before vehicle operation. The driver is always responsible for safe driving.
- Do not disassemble or modify the Intelligent Rear View Mirror, the camera unit or wirings. If you do, it may result in accidents or fire. In case you notice smoke or smell coming from the Intelligent Rear View Mirror, stop using the system immediately. See a NISSAN certified LEAF dealer for servicing.
- Do not operate the Intelligent Rear View Mirror while driving. Doing so can be a distraction and it could lose control of your vehicle and cause an accident or serious injury.
- Do not gaze into the Intelligent Rear View Mirror display during driving. It may cause a distraction and it could lose control of your vehicle and cause an accident or serious injury. Gazing into

the display screen during driving also can be a cause of carsick for passengers.

- Do not put a cigarette or flames to the Intelligent Rear View Mirror, the camera unit or wirings. It may cause a fire.
- Be sure to adjust the Intelligent Rear View Mirror before driving. Switch the system to the conventional rearview mirror mode and be properly seated on the driver's seat. Then adjust the rearview mirror so as to see the rear window properly. Driving without adjusting the rearview mirror may cause difficulty in watching the display at Intelligent Rear View Mirror mode (camera view mode) due to the reflection from the surface of the mirror.
- If the indicator light of the mirror turns off at the Intelligent Rear View Mirror mode (camera view mode), immediately switch the system to the conventional rearview mirror mode. If the indicator light does not illuminate after switching to the Intelligent Rear View Mirror mode again, the system may malfunction. Have the system checked by a NISSAN certified LEAF dealer.
- If the Intelligent Rear View Mirror malfunctions, immediately switch the system to the conventional rearview mirror mode. Have the system checked by a NISSAN certified LEAF dealer.
- When strong light (for example, sunlight or high beams from following vehicles) enters the camera, a light beam or a glaring light may appear on the display screen of the Intelligent Rear View Mirror. In that case, switch the system to the conventional rearview mirror mode appropriately.

- If dirt, rain or snow accumulates on the exterior glass surface covering the camera, the Intelligent Rear View Mirror may not display objects clearly. Use of the rear window wiper/washer may improve visibility, but if not, switch the Intelligent Rear View Mirror to the conventional rearview mirror mode until a time the glass covering the camera can be cleaned.

Components:

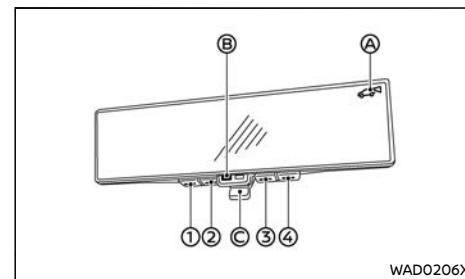

- ① MENU button
- ② Second button
- ③ Third button
- ④ Fourth button
- A Indicator
- B Indicator light
- C Mode select lever

Intelligent Rear View Mirror provides a clear rearview from a camera located on the rear of the vehicle. Intelligent Rear View Mirror has two modes: conventional rearview mirror mode and Intelligent Rear View Mirror mode (camera view mode). You can switch these two modes by the mode select lever C.

When the Intelligent Rear View Mirror mode is selected, the indicator ① is displayed, and the indicator light ② illuminates. (If a malfunction occurs in the Intelligent Rear View Mirror, the indicator ① will turn off or not appear when the Intelligent Rear View Mirror mode is selected.)

How to change the mode:

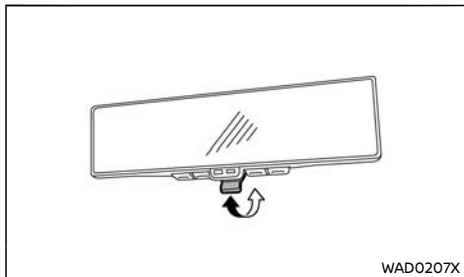

The mode can be switched when the power switch is in the "ON" position.

- Pull the mode select lever to switch to the Intelligent Rear View Mirror mode (camera view mode).
- Push the mode select lever to switch to the conventional rearview mirror mode.

How to make settings of Intelligent Rear View Mirror:

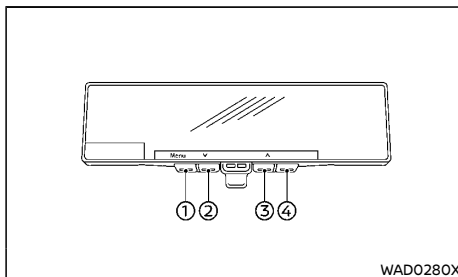

You can choose display settings of the Intelligent Rear View Mirror such as brightness, camera angle and textual indication ON or OFF.

When the Intelligent Rear View Mirror mode (camera view mode) is on, the setting menu is displayed by pushing the MENU button ①. Use the buttons ② and ③, then push the button ④ to select the item.

Brightness

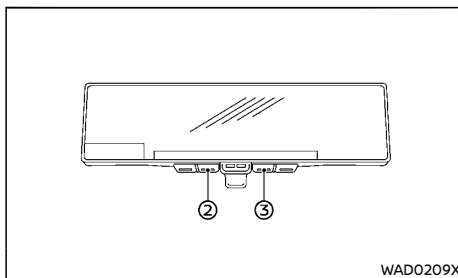

The brightness of the display screen can be adjusted.

- Push the button ② to dim the screen.
- Push the button ③ to brighten the screen.

Down/Up

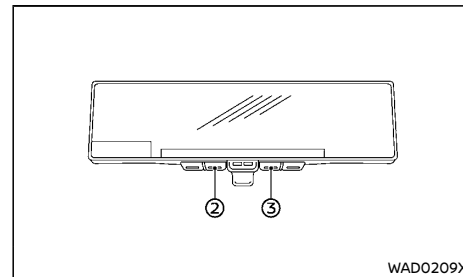

The vertical camera angle of the display screen can be adjusted.

- Push the button ② to down the camera angle.
- Push the button ③ to up the camera angle.

Left/Right

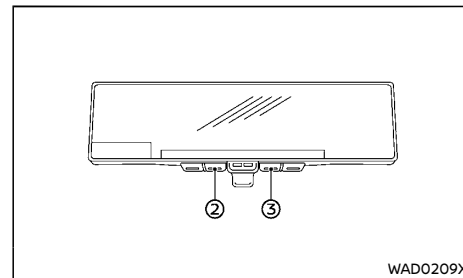

The horizontal camera angle of the display screen can be adjusted.

- Push the button ② to move the camera angle to the left.
- Push the button ③ to move the camera angle to the right.

Rotation

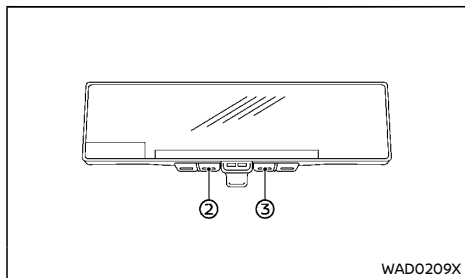

The camera angle of the display screen can be rotated.

- Push the button ② to rotate the camera angle to the left.
- Push the button ③ to rotate the camera angle to the right.

Indication

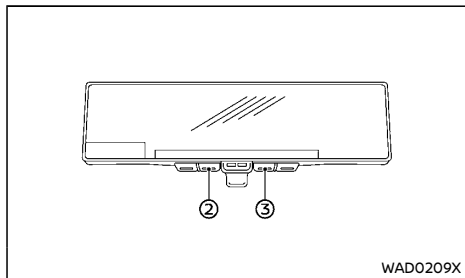

The textual indication can be turned on or off

on the Intelligent Rear View Mirror display screen.

- Push the button ② to disable the textual indication on the display screen.
- Push the button ③ to enable the textual indication on the display screen.

Language

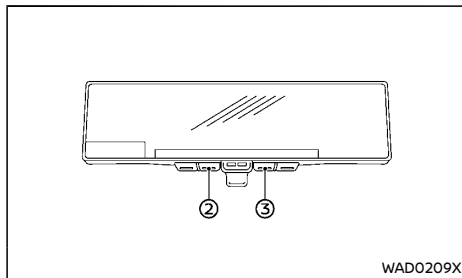

You can select the language of the textual indication on the Intelligent Rear View Mirror display screen.

Select the language by using the ② or ③ button. The language setting will be retained even if the EV system is restarted.

Switch Backlight

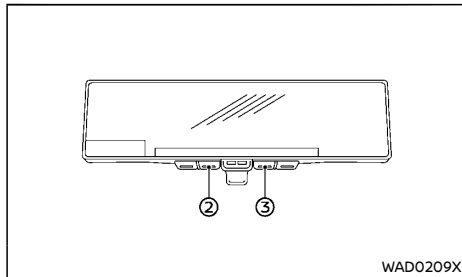

The illumination of the buttons can be turned on or off.

- Push the button ② to turn off the illumination.
- Push the button ③ to turn on the illumination.

License

The license information is displayed.

Intelligent Rear View Mirror system precautions:

NOTE:

- Long-term use of this system in stopping EV system may cause 12-volt battery to be discharged.
- Do not attach an antenna of wireless device near the Intelligent Rear View Mirror. Electric wave from wireless device may cause disturbed image in the Intelligent Rear View Mirror.
- Do not push the buttons excessively or operating the lever roughly may cause a system failure or the Intelligent Rear View Mirror itself to drop.
- Never turn the body of Intelligent Rear View Mirror horizontally by 20° or more, or vertically by 30° or more. It may damage the Intelligent Rear View Mirror.
- Do not apply strong shocks to the body of Intelligent Rear View Mirror. It may cause a system failure.
- Do not apply heavy load to the camera and camera-cover on the rear of the vehicle. It may cause the camera to be removed or may cause a system failure.
- If it is difficult to see the Intelligent Rear View Mirror display screen because of a strong external light, switch the mode to the conventional rearview mirror mode

for better use.

- When LED headlights are viewed on the Intelligent Rear View Mirror display, the images may flicker. This is normal.
- Due to diffused reflection from external environment, images on the screen may flicker. This is not a malfunction.
- A quick movement of a thing may not be able to display on the camera view screen. This is not a malfunction.
- Turn on the headlights at twilight or in a tunnel, etc. When headlights are turned on, the display and the camera systems automatically switched to the night mode, which can prevent dazzling.
- The Intelligent Rear View Mirror mode (camera view mode) display is different from the conventional rearview mirror. Objects in the display may differ from actual distance. Do not solely rely on the Intelligent Rear View Mirror. Always rely on your own operation to avoid accidents.
- Immediately after the Intelligent Rear View Mirror is switched from one mode to another, you may have difficulty in focusing on the image in the mirror/display screen with your eyes. Be cautious using the Intelligent Rear View Mirror until your eyes get accustomed to the selected mode. If it is necessary to correct eye focusing, the use of multifocal glasses, etc. is recommended.
- It may take time for you to focus on the camera view display depending on your condition.
- If the brightness of the camera view display is adjusted to excessive bright level, it may cause an eyestrain in the driving. Adjust the brightness properly.

- Use the rear window wiper when it rains. If the camera view image is still unclear when the rear window wiper is in operation, check the deterioration of the rear window wiper blade.
- When using the rear window wiper, images on the screen may flicker. This is not a malfunction.
- Defog the rear window with defogger when rear window is fogged. Use the conventional rearview mirror mode until the rear window is fully defogged.
- The display of the Intelligent Rear View Mirror may become hot. This is not a malfunction.
- The color of an object in the distance or in the dark may be difficult to be recognized. This is not a malfunction.
- When the temperature is high, the brightness may be decreased or image may not be displayed on the camera view display. This is not a malfunction.
- When the temperature is low, the image may be distorted on the camera view display. This is not a malfunction.

System maintenance (Intelligent Rear View Mirror):

- Always keep the mirror and camera area of the rear window clean.
- Clean the mirror and the camera lens with a dry soft cloth.
- When cleaning the camera area of the rear window, use a soft cloth dampened with water and a few neutral detergent. And after that, dry it up with dry soft cloth.
- If the image on the Intelligent Rear View Mirror display screen is still unclear even after cleaning the camera area of the rear window, an oil film may be adhering to the

rear window glass. Clean the rear window glass with an oil film remover.

- Never use alcohol, benzine, thinner, or any similar material to clean the mirror or camera lens. It will cause a discoloration, deterioration or a system malfunction.
- Do not cover the front of the mirror. It may interfere with brightness adjustment or switching images on the camera view display.
- Do not attach a sticker (including transparent material) on the camera area of the rear window.

OUTSIDE REARVIEW MIRRORS

Adjusting

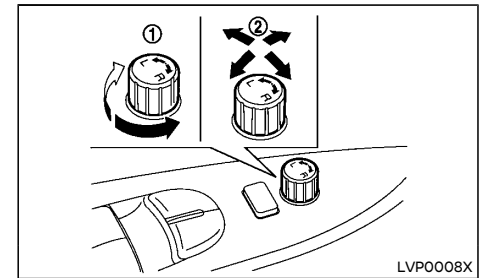

WARNING:

- Never touch the outside rearview mirrors while they are in motion. Doing so may pinch your fingers or damage the mirror.
- Never drive the vehicle with the outside rearview mirrors folded. This reduces rear view visibility and may lead to an accident.

- **Objects viewed in the outside mirror are closer than they appear.**
- **The picture dimensions and distance in the outside mirrors are not real.**

The outside rearview mirror control switch is located on the armrest.

The outside rearview mirror will operate only when the power switch is in the ACC or ON position.

1. Move the switch ① to select the right or left mirror.
2. Adjust each mirror until the desired position is achieved ②.

Folding

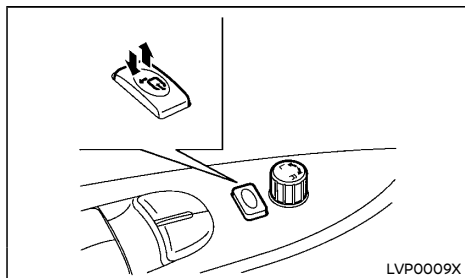

The outside rearview mirror remote control operates when the power switch is in the ACC or ON position.

The outside rearview mirrors automatically fold when the outside rearview mirror folding switch is pushed in. To unfold, push to the switch again.



CAUTION:

Continuously performing the fold/unfold operation of the outside rearview mirror may cause the switch to stop the operation.

Automatic fold (if equipped):

The outside rearview mirrors automatically fold when the doors are locked with the Intelligent Key or the request switch. The mirrors unfold when the doors are unlocked and the power switch is placed in the ACC or ON position. For information about disabling the automatic fold function, see "Vehicle Settings" (P.2-17).

VANITY MIRROR

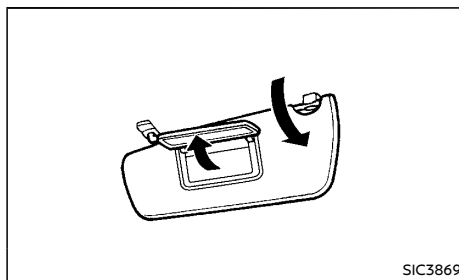

To use the vanity mirror, pull down the sun visor and pull up the cover.

PARKING BRAKE



WARNING:

- **Never drive the vehicle with the parking brake applied. The brake will overheat and fail to operate and will lead to an accident.**
- **Never release the parking brake from outside the vehicle. If the vehicle moves, it will be impossible to push the foot brake pedal and will lead to an accident.**
- **Never use the shift lever in place of the parking brake. When parking, be sure the parking brake is fully applied.**
- **To help avoid risk of injury or death through unintended operation of the vehicle and/or its systems, do not leave children, people who require the assistance of others or pets unattended in your vehicle. Additionally, the temperature inside a closed vehicle on a warm day can quickly become high enough to cause a significant risk of injury or death to people and pets.**

PEDAL TYPE

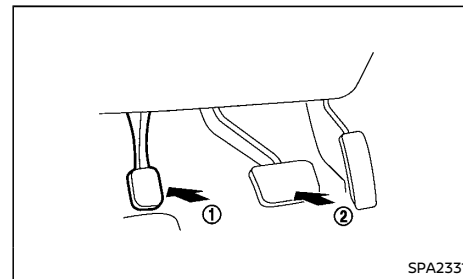

To apply the parking brake, firmly depress the parking brake pedal ①.

To release the parking brake, depress and hold the foot brake ② and then fully depress and release the parking brake pedal ①.

Before driving, be sure that the brake warning light has turned off.

SWITCH TYPE (model with electronic parking brake system)

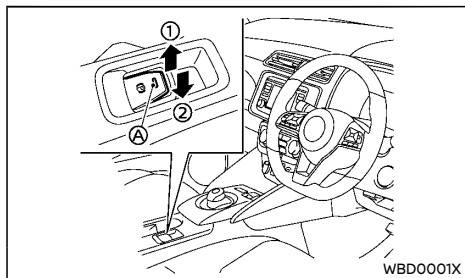

The electronic parking brake can be applied or released by operating the electronic parking brake switch.

To apply: Pull the switch up ①. The indicator light ④ will illuminate.

To release: With the power switch in the ON position, depress the brake pedal and push the switch down ②. The indicator light ④ will turn off.

Before driving, check that the electronic parking brake indicator light ④ turns off. For additional information, see "Warning lights, indicator lights and audible reminders" (P.2-8).



CAUTION:

When parking in an area where the outside temperature is below 0°C (32°F), the parking brake, if applied, may freeze in place and

may be difficult to release.

For safe parking, it is recommended that you place the vehicle in the P (Park) position and securely block the wheels.

NOTE:

- A buzzer will sound if the vehicle is driven without releasing the parking brake. See "Audible reminders" (P.2-14).
- While the electronic parking brake is applied or released, an operating sound is heard from the lower side of the rear seat. This is normal and does not indicate a malfunction.
- When the electronic parking brake is frequently applied and released in a short period of time, the parking brake may not operate in order to prevent the parking brake system from overheating. If this occurs, operate the electronic parking brake switch again after waiting approximately 1 minute.
- If the electronic parking brake must be applied while driving in an emergency, pull up and hold the electronic parking brake switch. When you release the electronic parking brake switch, the parking brake will be released.
- While pulling up the electronic parking brake switch during driving, the parking brake is applied and a chime sounds. The electronic parking brake indicator light in the meter and the parking brake switch indicator light illuminate. This does not indicate a malfunction. The electronic parking brake indicator light in the meter and in the electronic parking brake switch turn off when the parking brake is released.

- When pulling the electronic parking brake switch up with the power switch in the OFF or ACC position, the electronic parking brake switch indicator light will continue to illuminate for a short period of time.

4 Display screen, heater and air conditioner, and audio system

NissanConnect Owner's Manual (if equipped)	4-2	Climate control system	4-13
Safety precautions	4-2	Operating tips	4-14
Intelligent Around View Monitor (if equipped)	4-3	Automatic climate control system	4-15
Intelligent Around View Monitor		Air conditioner filter	4-19
system operation	4-4	Servicing climate control system	4-19
Difference between predictive and		Audio system (if equipped)	4-19
actual distances	4-5	Audio operation precautions	4-19
How to park with predictive course lines	4-7	Antenna	4-25
How to switch the display	4-8	FM-AM radio with Compact Disc (CD) player	4-25
How to adjust the screen	4-8	Steering wheel mounted controls for audio	4-30
Intelligent Around View Monitor		USB (Universal Serial Bus) connection port/	
system limitations	4-8	Auxiliary (AUX) input jack	4-30
System maintenance	4-10	CD/USB memory device care and cleaning	4-31
Moving Object Detection (MOD) (if equipped)	4-10	Car phone or CB radio	4-32
MOD system operation	4-11	Bluetooth® Hands-Free Phone System (if	
Turning the MOD system on or off	4-12	equipped)	4-32
MOD system limitations	4-12	Regulatory information	4-33
System maintenance	4-12	Control buttons and microphone	4-33
Ventilators	4-13	Using the system	4-33
Center ventilators	4-13	Bluetooth® settings	4-34
Side ventilators	4-13		

NISSANCONNECT OWNER'S MANUAL (if equipped)

For models with NissanConnect System, refer to the NissanConnect Owner's Manual that includes the following information.

Available functions may vary depending on the models, specifications and software version.

- Audio
- Hands-free phone
- Apple CarPlay
- Android Auto
- Voice recognition
- Information and settings viewable on NissanConnect

SAFETY PRECAUTIONS



WARNING:

- **Do not adjust the heater and air conditioner controls or audio controls while driving so that full attention may be given to vehicle operation.**
- **If you noticed any foreign objects entering the system hardware, spilled liquid on the system, or noticed smoke or fumes coming out from the system, or any other unusual operation is observed, stop using the system immediately and contact the nearest NISSAN certified LEAF dealer. Ignoring such conditions may lead to an accident, fire or electric shock.**
- **Do not disassemble or modify this system. If you do, it may lead to an accident, fire, or electric shock.**



CAUTION:

Do not use the system when the EV (Electric Vehicle) system is not running for extended periods of time to prevent 12-volt battery discharge.

INTELLIGENT AROUND VIEW MONITOR (if equipped)

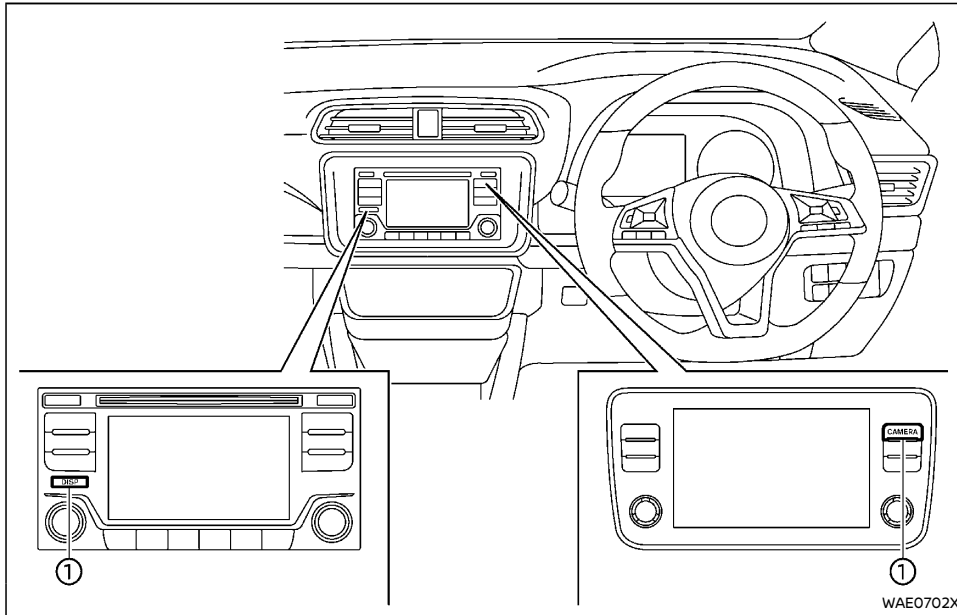

① DISP button or CAMERA button



WARNING:

Failure to follow the warnings and instructions for the proper use of the Intelligent Around View Monitor system could result in serious injury or death.

- The Intelligent Around View Monitor is a convenience feature but it is not a substitute for proper vehicle operation because it has areas where objects cannot

be viewed. The four corners of the vehicle in particular, are areas where objects do not always appear in the bird's-eye, front, or rear views. Always check your surroundings to be sure that it is safe to move before operating the vehicle. Always operate the vehicle slowly.

- The driver is always responsible for safety during parking and other maneuvers.



CAUTION:

Do not scratch the camera lens when cleaning dirt or snow from the front of the camera.

The Intelligent Around View Monitor system is designed as an aid to the driver in situations such as slot parking or parallel parking.

The monitor displays various views of the position of the vehicle in a split screen format. Not all views are available at all times.

Available views:

- Front view
An approximately 150-degree view of the front of the vehicle.
- Rear view
An approximately 150-degree view of the rear of the vehicle.
- Bird's-eye view
The surrounding views of the vehicle from above.
- Front-side view
The view around and ahead of the front passenger's side wheel.
- Full screen rear view
The view to the rear of the vehicle (which is a little wider than the standard rear view).

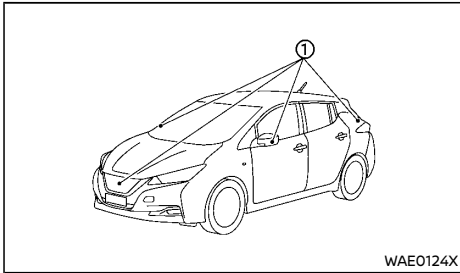

To display the multiple views, the Intelligent Around View Monitor system uses cameras ① located in the front grille, on the vehicle's outside mirrors and one just above the vehicle's license plate.

INTELLIGENT AROUND VIEW MONITOR SYSTEM OPERATION

With the power switch in the "ON" position, move the shift lever to the "R" (Reverse) position or push the DISP button/CAMERA button to operate the Intelligent Around View Monitor.

The screen displayed on the Intelligent Around View Monitor will automatically return to the previous screen 3 minutes after the DISP button/CAMERA button has been pushed with the shift lever in a position other than the "R" (Reverse) position.

Available views



WARNING:

- **The distance guide lines and the vehicle width lines should be used as a reference only when the vehicle is on a paved, level surface. The apparent distance viewed on the monitor may be different than the**

actual distance between the vehicle and displayed objects.

- Use the displayed lines and the bird's-eye view as a reference. The lines and the bird's-eye view are greatly affected by the number of occupants, cargo, vehicle position, road condition and road grade.
- If the tires are replaced with different sized tires, the predictive course lines and the bird's-eye view may be displayed incorrectly.
- When driving the vehicle up a hill, objects viewed in the monitor are farther than they appear. When driving the vehicle down a hill, objects viewed in the monitor are closer than they appear.
- Objects in the rear view will appear visually opposite compared to when viewed in the monitor and outside mirrors.
- Use the mirrors or actually look to properly judge distances to other objects.
- On a snow-covered or slippery road, there may be a difference between the predictive course lines and the actual course line.
- The vehicle width and predictive course lines are wider than the actual width and course.
- The displayed lines will appear slightly off to the right, because the rearview camera is not installed in the rear center of the vehicle.

Front and rear view:

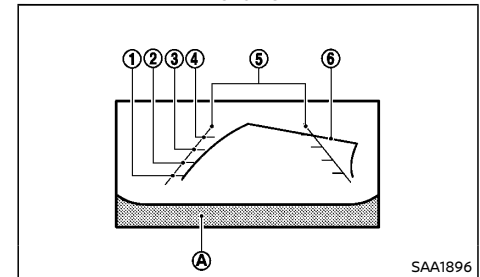
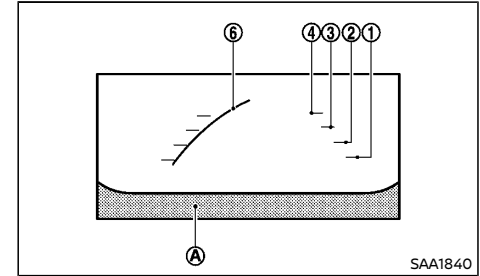

Guiding lines, which indicate the vehicle width and distances to objects with reference to the vehicle body line ④, are displayed on the monitor.

Distance guide lines:

Indicate distances from the vehicle body.

- Red line ① : approximately 0.5 m (1.5 ft)
- Yellow line ② : approximately 1 m (3 ft)
- Green line ③ : approximately 2 m (7 ft)
- Green line ④ : approximately 3 m (10 ft)

Vehicle width guide lines ⑤ :

Indicate the vehicle width when backing up.

Predictive course lines ⑥ :

Indicate the predictive course when operating the vehicle. The predictive course lines will be displayed on the monitor when the steering wheel is turned. The predictive course lines will move depending on how much the steering wheel is turned and will not be displayed while the steering wheel is in the neutral position.

The front view will not be displayed when the vehicle speed is above 10 km/h (6 MPH).

NOTE:

When the monitor displays the front view and the steering wheel turns about 90 degrees or less from the neutral position, both the right and left predictive course lines ⑥ are displayed. When the steering wheel turns about 90 degrees or more, the predictive course line is displayed only on the opposite side of the turn.

Bird's-eye view:

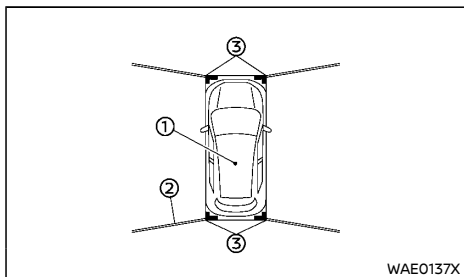

The bird's-eye view shows the overhead view of the vehicle which helps confirm the vehicle position.

The vehicle icon ① shows the position of the

vehicle. Note that the apparent distance between objects viewed in the bird's-eye view may differ somewhat from the actual distance to the vehicle.

The areas that the cameras cannot cover ② are indicated in black. The non-viewable area ② is highlighted in yellow for several seconds after the bird's-eye view is displayed. It will be shown only the first time after the power switch is placed in the ON position.

In addition, the non-viewable corners ③ are displayed in red and blink for the first 3 seconds to remind the driver to be cautious.



WARNING:

- **Objects in the bird's-eye view will appear farther than the actual distance.**
- **Tall objects, such as a curb or vehicle, may be misaligned or not displayed at the seam of the views.**
- **Objects that are above the camera cannot be displayed.**
- **The view for the bird's-eye view may be misaligned when the camera position alters.**
- **A line on the ground may be misaligned and is not seen as being straight at the seam of the views. The misalignment will increase as the line proceeds away from the vehicle.**

Front-side view:

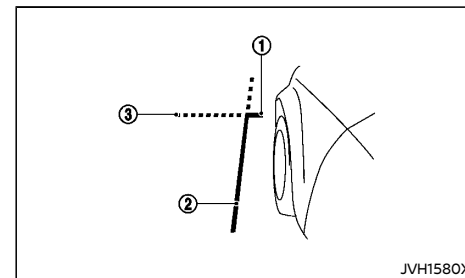

Guiding lines:

Guiding lines that indicate the approximate width and the front end of the vehicle are displayed on the monitor.

The front-of-vehicle line ① shows the front part of the vehicle.

The side-of-vehicle line ② shows the approximate vehicle width including the outside mirror.

The extensions ③ of both the front ① and side ② lines are shown with a green dotted line.

DIFFERENCE BETWEEN PREDICTIVE AND ACTUAL DISTANCES

The displayed guide lines and their locations on the ground are for approximate reference only. Objects on uphill or downhill surfaces or projecting objects will be actually located at distances different from those displayed in the monitor relative to the guide lines (refer to illustrations). When in doubt, turn around and view the objects as you are backing up, or park and exit the vehicle to view the positioning of objects behind the vehicle.

Backing up on a steep uphill

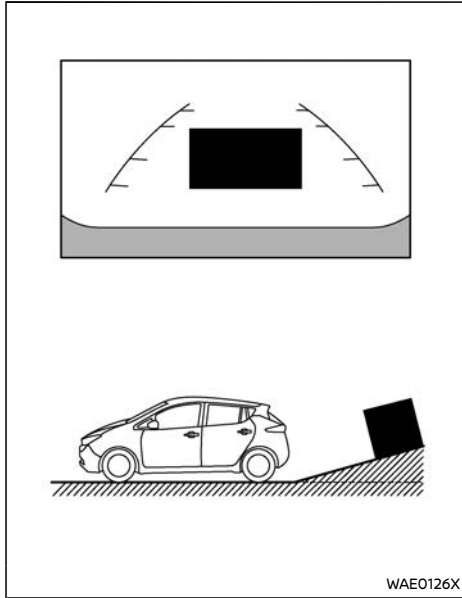

When moving the vehicle up a hill, the distance guide lines and the vehicle width guide lines are shown closer than the actual distance. Note that any object on the hill is farther than it appears on the monitor.

Backing up on a steep downhill

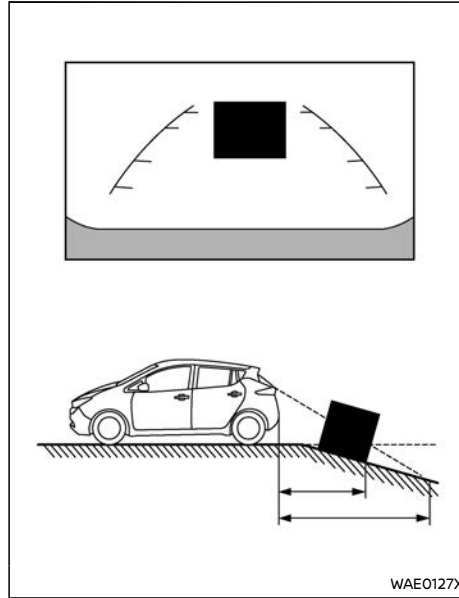

When moving the vehicle down a hill, the distance guide lines and the vehicle width guide lines are shown farther than the actual distance. Note that any object on the hill is closer than it appears on the monitor.

Backing up near a projecting object

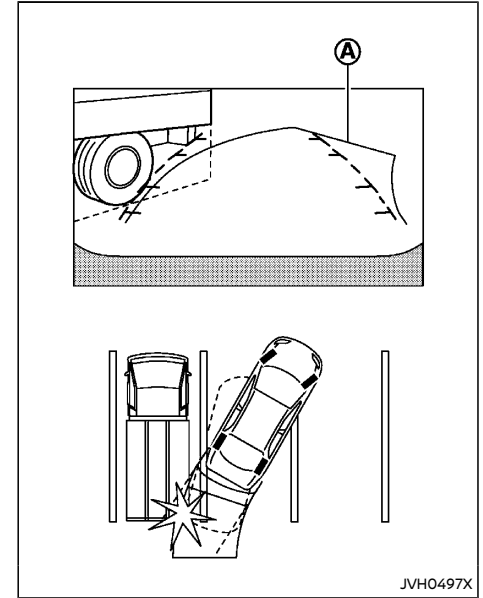

The predictive course lines ① do not touch the object in the display. However, the vehicle may hit the object if it projects over the actual moving course.

Backing up behind a projecting object

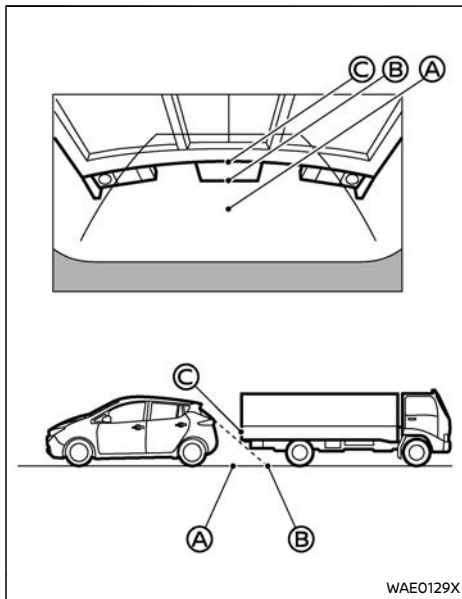

The position ③ is shown farther than the position ② in the display. However, the position ③ is actually at the same distance as the position ①. The vehicle may hit the object when backing up to the position ② if the object projects over the actual backing up course.

HOW TO PARK WITH PREDICTIVE COURSE LINES

WARNING:

- If the tires are replaced with different sized tires, the predictive course lines may be displayed incorrectly.
- On a snow-covered or slippery road, there may be a difference between the predictive course lines and the actual course line.
- If the 12-volt battery is disconnected or becomes discharged, the predictive course lines may be displayed incorrectly. If this occurs, please perform the following procedures:
 - Turn the steering wheel from lock to lock while the EV system is running.
 - Drive the vehicle on a straight road for more than 5 minutes.
- When the steering wheel is turned with the power switch in the ACC position, the predictive course lines may be displayed incorrectly.

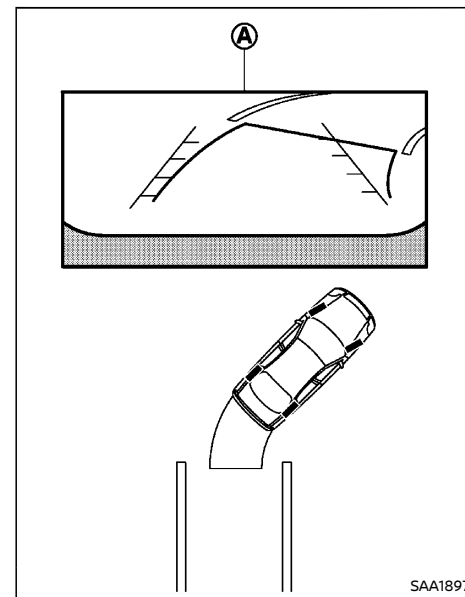

1. Visually check that the parking space is safe before parking your vehicle.
2. The rear view of the vehicle is displayed on the screen ① as illustrated when the shift lever is moved to the "R" (Reverse) position.

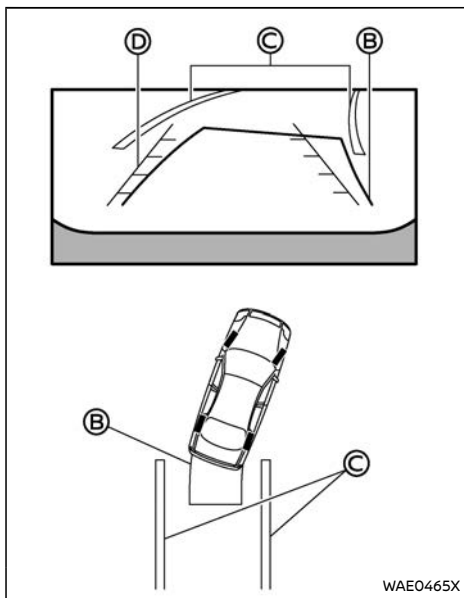

HOW TO SWITCH THE DISPLAY

With the power switch in the "ON" position, push the DISP button/CAMERA button or move the shift lever to the "R" (Reverse) position to operate the Intelligent Around View Monitor.

The Intelligent Around View Monitor displays different split screen views depending on the position of the shift lever. Push the DISP button/CAMERA button to switch between the available views.

If the shift lever is in the "R" (Reverse) position, the available views are:

- Rear view/bird's-eye view split screen
- Rear view/front-side view split screen
- Full screen rear view

If the shift lever is in the "P" (Park) or "D" (Drive) position, the available views are:

- Front view/bird's-eye view split screen
- Front view/front-side view split screen

The display will switch from the Intelligent Around View Monitor screen when:

- The shift lever is in the "D" (Drive) position and the vehicle speed increases above approximately 10 km/h (6 MPH).
- A different screen is selected.

HOW TO ADJUST THE SCREEN

Models with NissanConnect System:

1. Push the MENU button.
2. Touch the "Settings" key.
3. Touch the "Camera" key.
4. Touch the "Display Settings" key.
5. Touch the "Brightness", "Contrast", "Tint", "Color" or "Black Level" key.

6. Adjust the item by touching the "+" or "-" key on the touch screen display.

Models without NissanConnect System:

1. Push the ENTER/SETTING dial.
2. Turn the ENTER/SETTING dial to highlight the "Brightness" or the "Contrast" key.
3. Push the ENTER/SETTING dial.
4. Adjust the level using the ENTER/SETTING dial.

NOTE:

Do not adjust any of the display settings of the Intelligent Around View Monitor while the vehicle is moving. Make sure the parking brake is applied.

INTELLIGENT AROUND VIEW MONITOR SYSTEM LIMITATIONS



WARNING:

Listed below are the system limitations for Intelligent Around View Monitor. Failure to operate the vehicle in accordance with these system limitations could result in serious injury or death.

- **Do not use the Intelligent Around View Monitor with the outside mirrors in the stored position, and make sure that the rear hatch is securely closed when operating the vehicle using the Intelligent Around View Monitor.**
- **The apparent distance between objects viewed on the Intelligent Around View Monitor differs from the actual distance.**
- **The cameras are installed on the front grille, the outside mirrors and above the rear license plate. Do not put anything on the vehicle that covers the cameras.**

- When washing the vehicle with high pressure water, be sure not to spray it around the cameras. Otherwise, water may enter the camera unit causing water condensation on the lens, a malfunction, fire or an electric shock.
- Do not strike the cameras. They are precision instruments. Doing so could cause a malfunction or cause damage resulting in a fire or an electric shock.

The following are operating limitations and do not represent a system malfunction:

- There may be a delay when switching between views.
- When the temperature is extremely high or low, the screen may not display objects clearly.
- When strong light directly shines on the camera, objects may not be displayed clearly.
- The screen may flicker under fluorescent light.
- The colors of objects on the Intelligent Around View Monitor may differ somewhat from the actual color of objects.
- Objects on the Intelligent Around View Monitor may not be clear and the color of the object may differ in a dark environment.
- There may be differences in sharpness between each camera view of the bird's-eye view.
- Do not use wax on the camera lens. Wipe off any wax with a clean cloth that has been dampened with a diluted mild cleaning agent, then wipe with a dry cloth.

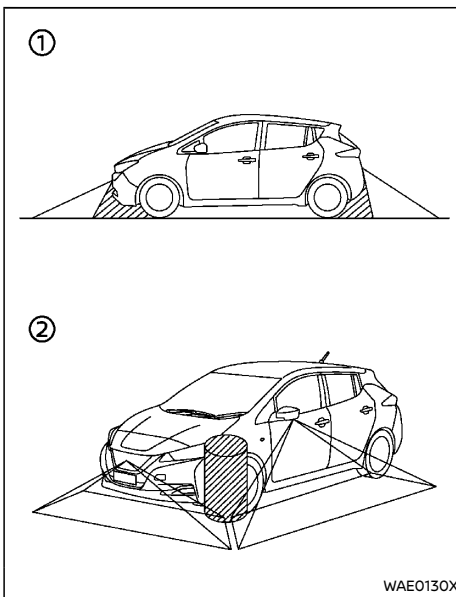

There are some areas where the system will not show objects and the system does not warn of moving objects. When in the front or rear view display, an object below the bumper or on the ground may not be viewed ①. When in the bird's-eye view, a tall object near the seam ② of the camera viewing areas will not appear in the monitor.

System temporarily unavailable

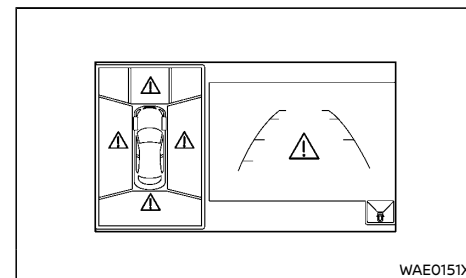

When the "⚠" icon is displayed on the screen, there are abnormal conditions in the Intelligent Around View Monitor. This will not hinder normal driving operation but the system should be inspected by a NISSAN certified LEAF dealer.

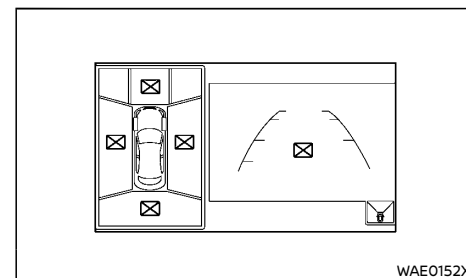

When the "⊠" icon is displayed on the screen, the camera image may be receiving temporary electronic disturbances from surrounding devices. This will not hinder normal driving operation but the system should be inspected by a NISSAN certified LEAF dealer if it occurs frequently.

MOVING OBJECT DETECTION (MOD) (if equipped)

SYSTEM MAINTENANCE

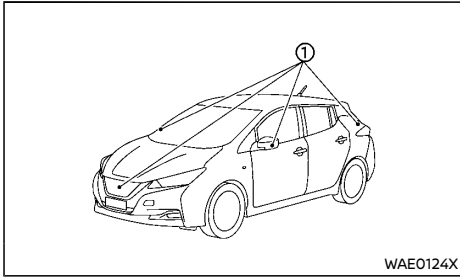

CAUTION:

- Do not use alcohol, benzine or thinner to clean the camera. This will cause discoloration.
- Do not damage the cameras as the monitor screen may be adversely affected.

If dirt, rain or snow accumulates on any of the cameras ①, the Intelligent Around View Monitor may not display objects clearly. Clean the camera by wiping with a cloth dampened with a diluted mild cleaning agent and then wiping with a dry cloth.

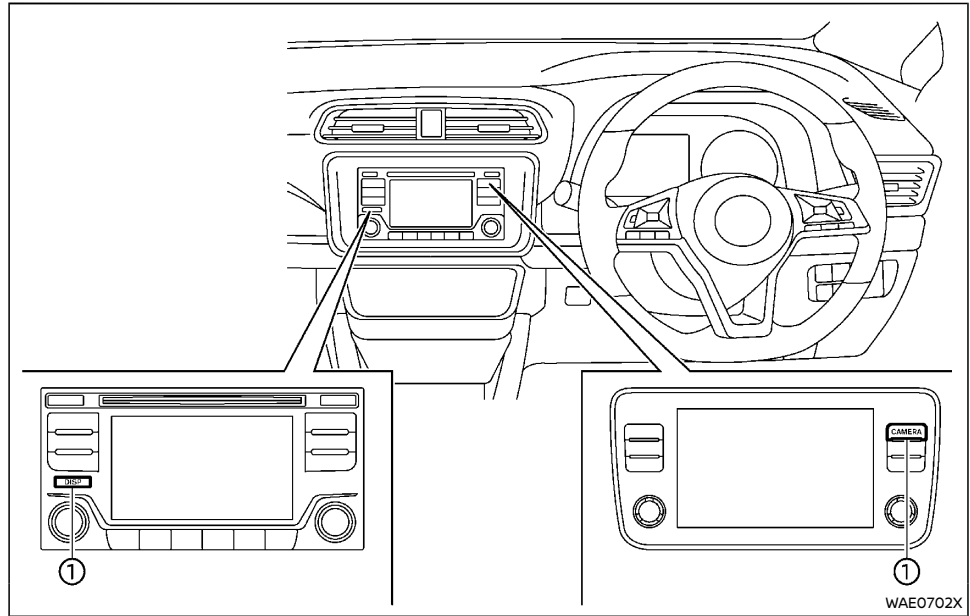

① DISP button or CAMERA button

WARNING:

Failure to follow the warnings and instructions for proper use of the Moving Object Detection (MOD) system could result in serious injury or death.

- The MOD system is not a substitute for proper vehicle operation and is not designed to prevent contact with the objects surrounding the vehicle. When

maneuvering, always use the outside mirror and inside rearview mirror and turn and look to check the surroundings to make sure it is safe to maneuver.

- The system is deactivated at speeds above 8 km/h (5 MPH). It is reactivated at lower speeds.
- The MOD system is not designed to detect surrounding stationary objects.

The MOD system can inform the driver of moving objects surrounding the vehicle when

driving out of garages, maneuvering in parking lots and in other such instances.

The MOD system detects moving objects by using image processing technology on the image shown in the display.

MOD SYSTEM OPERATION

The MOD system will turn on automatically under the following conditions:

- When the shift lever is in the "R" (Reverse) position.
- When the DISP button/CAMERA button is pushed to activate the Intelligent Around View Monitor on the display.
- When vehicle speed decreases below approximately 8 km/h (5 MPH) and the camera view is displayed.

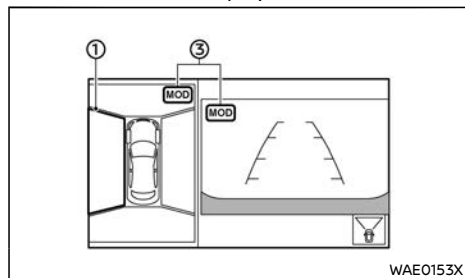

Front and bird's-eye views

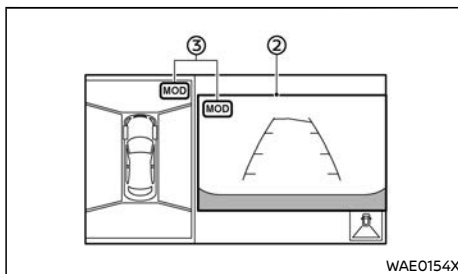

Rear and bird's-eye views

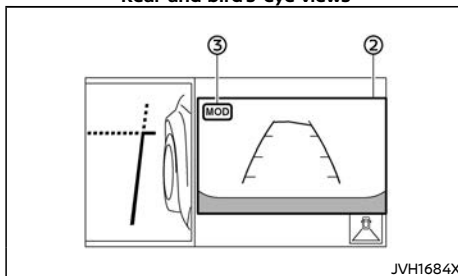

Rear and front-side views

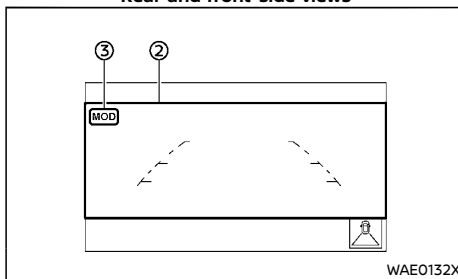

Full screen rear view

The MOD system operates in the following

conditions when the camera view is displayed:

- When the shift lever is in the "P" (Park) or "N" (Neutral) position and the vehicle is stopped, the MOD system detects moving objects in the bird's-eye view. The MOD system may not operate if the outside rearview mirrors are moving in or out, in the stowed position, or if either front door is opened.
- When the shift lever is in the "D" (Drive) position and the vehicle speed is below approximately 8 km/h (5 MPH), the MOD system detects moving objects in the front view.
- When the shift lever is in the "R" (Reverse) position and the vehicle speed is below approximately 8 km/h (5 MPH), the MOD system detects moving objects in the rear view.

The MOD system will not operate if the rear hatch is opened.

The MOD system does not detect moving objects in the front-side view. The MOD icon is not displayed on the screen when in this view.

When the MOD system detects moving objects near the vehicle, a chime will be heard and a yellow frame will be displayed on the view where the objects are detected. While the MOD system continues to detect moving objects, the yellow frame continues to be displayed.

In the bird's-eye view, the yellow frame ① is displayed on each camera image (front, rear, right, left) depending on where moving objects are detected.

The yellow frame ② is displayed on each view in the front view, rear view and full screen rear view modes.

A blue MOD icon ③ is displayed in the view where the MOD system is operative. A gray

MOD icon ③ is displayed in the view where the MOD system is not operative.

If the MOD system is turned off, the MOD icon ③ is not displayed.

TURNING THE MOD SYSTEM ON OR OFF

1. Use the ◀ / ▶ button on the steering wheel until "Settings" appears in the vehicle information display.
2. Use the ▲ / ▼ button to select "Driver Assistance" and push the OK button.
3. Select "Parking Aids" and push the OK button.
4. Toggle ON or OFF "Moving Object" using the OK button.

MOD SYSTEM LIMITATIONS



WARNING:

Listed below are the system limitations for the MOD. Failure to operate the vehicle in accordance with these system limitations could result in serious injury or death.

- Excessive noise (for example, audio system volume or open vehicle window) will interfere with the chime sound, and it may not be heard.
- The MOD system performance will be limited according to environmental conditions and surrounding objects such as:
 - When there is low contrast between background and the moving objects.
 - When there is a blinking source of light.
 - When strong light such as another vehicle's headlight or sunlight is present.

– When camera orientation is not in its usual position, such as when the outside mirror is folded.

– When there is dirt, water drops or snow on the camera lens.

– When the position of the moving objects in the display is not changed.

- The MOD system might detect flowing water droplets on the camera lens or moving shadows, etc.
- The MOD system may not function properly depending on the speed, direction, distance or shape of the moving objects.
- If your vehicle sustains damage to the parts where the camera is installed, leaving it misaligned or bent, the sensing zone may be altered and the MOD system may not detect objects properly.
- When the temperature is extremely high or low, the screen may not display objects clearly. This is not a malfunction.

NOTE:

The blue MOD icon will change to orange if one of the following has occurred:

- When the system is malfunctioning.
- When the component temperature reaches a high level (icon will blink).
- When the rear view camera has detected a blockage (icon will blink).

If the icon light continues to illuminate orange, have the MOD system checked. It is recommended that you visit a NISSAN certified LEAF dealer for this service.

SYSTEM MAINTENANCE

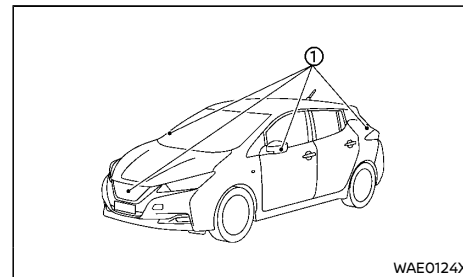

WAE0124X



CAUTION:

- Do not use alcohol, benzine or thinner to clean the camera. This will cause discoloration.
- Do not damage the cameras as the monitor screen may be adversely affected.

If dirt, rain or snow accumulates on any of the cameras ①, the MOD system may not operate properly. Clean the camera by wiping with a cloth dampened with a diluted mild cleaning agent and then wiping with a dry cloth.

VENTILATORS

CENTER VENTILATORS

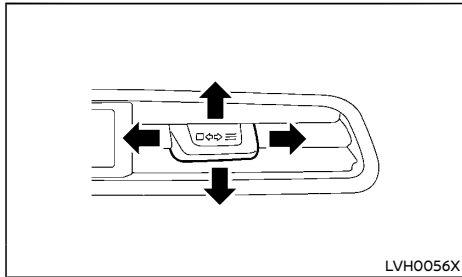

Open/close the ventilators by moving the center knob to either direction.

- ☒ : This symbol indicates that the vents are closed. Moving the center knob to this direction will close the ventilators.
- ☐ : This symbol indicates that the vents are open. Moving the center knob to this direction will open the ventilators.

Adjust the air flow direction of the ventilators by moving the center knob (up/down, left/right) until the desired position is achieved.

SIDE VENTILATORS

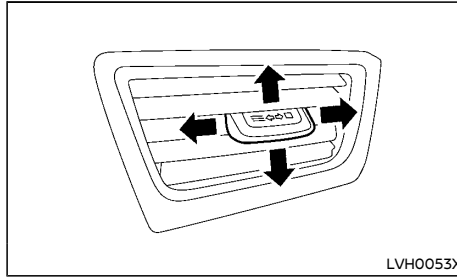

Open/close the ventilators by moving the center knob to either direction.

- ☒ : This symbol indicates that the vents are closed. Moving the center knob to this direction will close the ventilators.
- ☐ : This symbol indicates that the vents are open. Moving the center knob to this direction will open the ventilators.

Adjust the air flow direction of the ventilators by moving the center knob (up/down, left/right) until the desired position is achieved.

CLIMATE CONTROL SYSTEM



WARNING:

- The air conditioning cooling function operates only when the power switch is in the ON position or when the READY to drive indicator light is ON.
- Do not leave children or adults who would normally require the support of others alone in your vehicle. Pets should not be left alone either. On hot, sunny days, temperatures in a closed vehicle could quickly become high enough to cause severe or possibly fatal injuries to people or animals.
- Do not use the recirculation mode for long periods as it may cause the interior air to become stale and the windows to fog up.

NOTE:

- Odors from inside and outside the vehicle can build up in the climate control system. Odor can enter the passenger compartment through the vents.
- When parking, set the climate control system to turn off air recirculation to allow fresh air into the passenger compartment. This should help reduce odors inside the vehicle.

The climate control system (air conditioner and heater functions) can be operated when the READY to drive indicator light is illuminated. However, while charging, the climate control system can be used when the power switch is in the ON position.

The fan, heater and air conditioning can be turned on manually using the timer function.

These functions operate in the following conditions.

Power switch position	LOCK/OFF	ACC	ON	READY to drive
Fan	-	-	Available	Available
Heater and air conditioner	-	-	Available*	Available
Timer (Climate Ctrl. Timer)	Available	Available	-	-

*: The climate control system will only start when charging is being performed. After charging is complete, it will continue to operate if the EVSE (Electric Vehicle Supply Equipment) (if equipped) is connected.

NOTE:

- A series of operation sounds may be heard immediately after climate control system ON/OFF operation. This is not a malfunction.
- Condensation forms inside the climate control system unit when the climate control system is running, and is safely discharged underneath your vehicle. Traces of water on the ground are therefore normal.
- Compressor and motor fan may suddenly start to operate during charging operation. This is not a malfunction.
- If the READY to drive indicator light is illuminated and the EVSE (if equipped) is connected to the vehicle, the power switch will change to the ON position. At the same time, the climate control system will stop operating. However, the fan will continue to operate. If you want to turn on climate control system again, place the power switch in the OFF position and then place it in the ON position again after confirming that the vehicle has started charging.
- When the power switch is in the ON position, if the power supply from the EVSE (if equipped) is interrupted due to an electrical outage, etc., the system will

operate in the following ways.

- If it occurs while charging is being performed:

The climate control system will stop once. If the power supply is restored within approximately 5 minutes, the climate control system will restart. However, if more than 5 minutes have elapsed, the climate control system will not restart.

- If it occurs after charging has finished:

The climate control system will stop.

OPERATING TIPS

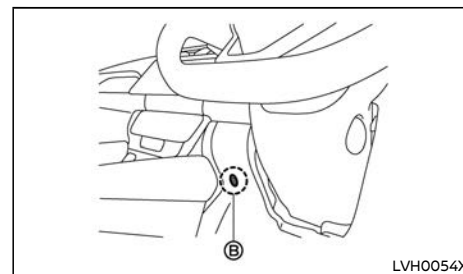
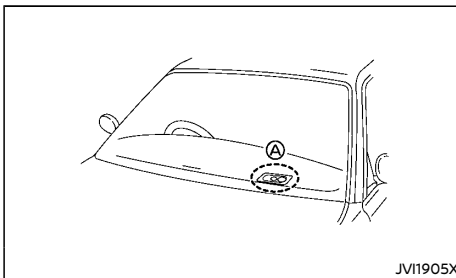



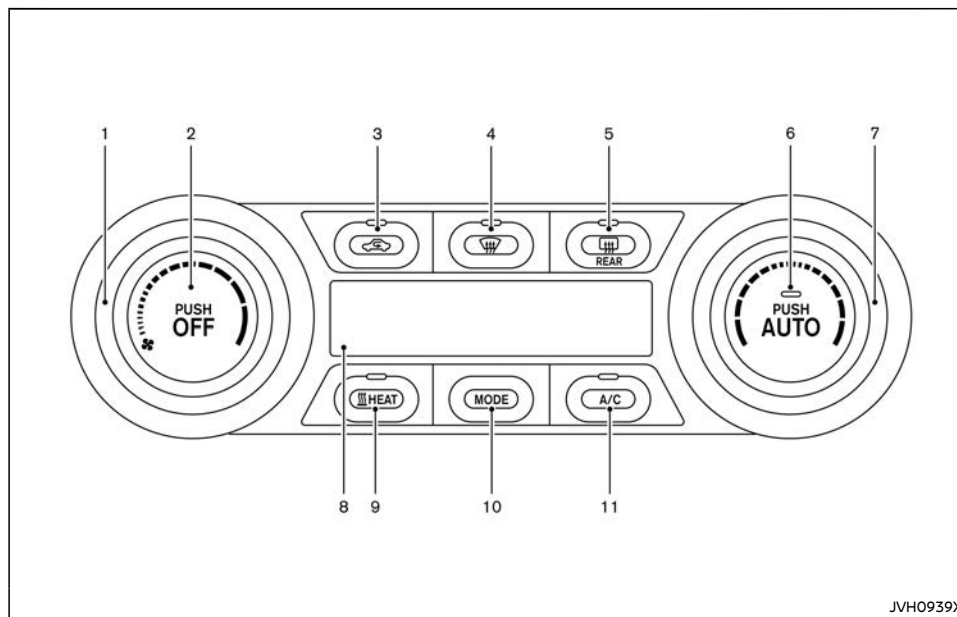

- The automatic climate control system is equipped with sensors as illustrated. The sensors ① and ② help maintain a constant temperature. Do not put anything on or around these sensors.
- Using the AUTO mode will help reduce the power consumption of the climate control system.
- When the AUTO button is pushed, the AUTO indicator illuminates. The HEAT indicator light or the A/C indicator light illuminates according to the operation of the climate control system.
- If any of the MODE button, A/C button, HEAT button, fan speed control knob, front defogger button, intake air control button is pushed when the AUTO indicator is illuminated, the AUTO indicator will be turned off.
- Power consumption of the climate control system varies depending on the outside temperature and the temperature set for the climate control system. Power consumption increases if the interior temperature is cooled down too much in summer or if it is warmed up too much in winter. This reduces driving range.

- If the charger is connected to the vehicle when the vehicle is in the READY to drive mode and the air conditioner or heater is on, the power switch automatically changes to the ON position. The climate control system automatically turns off the heater or air conditioner and switches to the ventilation mode. Place the power switch in the OFF position to begin charging. Turn on the desired climate control system function.
- For normal charge, the climate control system is operative when charging operation is complete. For quick charge, however, the climate control system stops operating when charging operation stops.
- The Climate Ctrl. Timer may fog up windows depending on the outside temperature.
- When turning on the seat heater prior to operating the Climate Ctrl. Timer, the seat heater will also turn on automatically when the outside temperature is low.

AUTOMATIC CLIMATE CONTROL SYSTEM



- | | |
|--|-----------------|
| 1. Fan speed control  knob | 8. Display |
| 2. A/C-Heater ON-OFF button | 9. HEAT button |
| 3. Intake air control  button | 10. MODE button |
| 4. Front defogger  button | 11. A/C button |
| 5. Rear window defogger  button (See "Defogger switch" (P.2-36).) | |
| 6. AUTO button | |
| 7. Temperature control knob | |

Automatic operation (AUTO)

The AUTO mode may be used year-round as the system automatically controls constant temperature, air flow distribution, intake air and fan speed.



1. Push the AUTO button. The AUTO indicator will be illuminated.
2. Turn the temperature control knob to set the desired temperature.

When any of the following functions are operated, the AUTO indicator will turn off.

- The HEAT button or A/C button is pushed.
- The fan speed control or ventilator air flow control is operated.
- The intake air control is switched.

However, the functions that were not operated continue operating in AUTO mode.

NOTE:

- **If the fan speed control  knob, MODE button, or intake air control  button is operated while AUTO mode is in use, all the other buttons operate in AUTO mode.**
- **While the AUTO indicator is illuminated, electric power consumption of the climate control system can be economized compared to the amount consumed while the AUTO indicator is not illuminated.**

The HEAT indicator light and the A/C indicator light illuminate according to the operation modes of the climate control system.

Operation mode	A/C indicator	HEAT indicator
Cooling	ON	OFF
Heating (A/C off)	OFF	ON

Manual operation

The manual mode can be used to control the heater and air conditioner to your desired setting.

The HEAT indicator light and the A/C indicator light illuminates according to the operation modes of the climate control system.

Operation mode	A/C indicator	HEAT indicator
Cooling	ON	OFF
Dehumidified heating	ON	ON
Heating (A/C off)	OFF	ON
Ventilation	OFF	OFF

Cooling:

1. Push the A/C button to illuminate the A/C indicator light.
 2. Push the HEAT button to turn off the HEAT indicator light.
- Do not set the temperature higher than the outside air temperature. Doing so may prevent the temperature from being controlled properly.
 - A visible mist may be seen coming from the ventilators in hot, humid conditions as the air is cooled rapidly. This does not indicate a malfunction.

Dehumidified heating:

1. Push the A/C button to illuminate the A/C indicator light.
2. Push the HEAT button to illuminate the HEAT indicator light.

NOTE:

Electric power consumption of climate control system increases while A/C indicator light and HEAT indicator light simultaneously illuminate. As a result, the driving range may be decreased.

Heating (A/C off):

1. Push the HEAT button to illuminate the HEAT indicator light.
 2. Push the A/C button to turn off the A/C indicator light.
- Do not set the temperature lower than the outside air temperature. Doing so may prevent the temperature from being controlled properly.
 - If the windows fog up, use dehumidified heating instead of the A/C off heating.

Ventilation:



Push the HEAT button and A/C button if the indicator lights are on so that both indicator lights turn off.

NOTE:

- **The ventilation mode requires a lower power consumption, so driving range will increase.**
- **In ventilation mode, temperature is not indicated on the climate control system display.**

Dehumidified defrosting/defogging:

Push the front defogger  button. (The indicator light will illuminate.)

- To remove moisture or fog on the front window quickly, set the temperature to the high temperature and the fan speed to their maximum level.
- After the windshield is cleared, push the front defogger  button again. (The indicator light will turn off.)
- When the front defogger  button is pushed, the climate control system will automatically turn on to defog the windshield. The outside air circulation mode will be selected to improve the defogging performance.





Fan speed control:

Turn the fan speed control  knob to manually control the fan speed.

Push the AUTO button to change the fan speed to the automatic mode.

Air flow control:



Push the MODE button to change the air flow mode.

-  — Air flows from the center and side ventilators.
-  — Air flows from the center and side ventilators and foot outlets.
-  — Air flows mainly from the foot outlets.
-  — Air flows from the defogger outlets and foot outlets.
-  — Air flows mainly from the defogger outlets.

Temperature control:

Turn the temperature control knob to set the desired temperature.

Air intake control:

- Push the intake air control  button to change the air circulation mode. When the indicator light illuminates, the air recirculates inside the vehicle.
- Push the intake air control  button to change the air circulation mode. When the indicator light does not illuminate, the outside air is drawn from outside the vehicle.
- To set the automatic control mode, push and hold the intake air control  button. The indicator light will blink twice and the inside/outside circulation will then be controlled automatically. When in automatic mode, the indicator light will come on when inside air recirculation is active.

To turn the system off

To turn off the climate control system, push the A/C-Heater ON-OFF button. The same operating mode (Heater or A/C) that was active when the system is turned off is active when system is turned back on.

Climate Ctrl. Timer

This function pre-heats or pre-cools the passenger compartment of the vehicle to the temperature before driving. This helps reduce power consumption from the Li-ion battery while driving.

The Climate Ctrl. Timer operates the climate control system using power from the charger or the Li-ion battery. While the charging connector is connected to the vehicle, electric power from the Li-ion battery is not used.

The Climate Ctrl. Timer function allows two

timer settings.

Once the Climate Ctrl. Timer is set, it will complete air conditioning by the time that is set. It is not necessary to set the Climate Ctrl. Timer everyday.



WARNING:

Even if the Climate Ctrl. Timer is set, the temperature in the passenger compartment may become high or low if the system automatically stops. Do not leave children or adults who would normally require the support of others alone in your vehicle. Pets should not be left alone either. On hot, sunny days, temperatures in a closed vehicle could quickly become high enough to cause severe or possibly fatal injuries to people or animals. Also on cold days, temperature in a vehicle could become low enough to cause severe or possible fatal injuries to people or animals.

How to set Climate Ctrl. Timer:

The Climate Ctrl. Timer settings can be changed on the vehicle information display using buttons on the steering wheel.

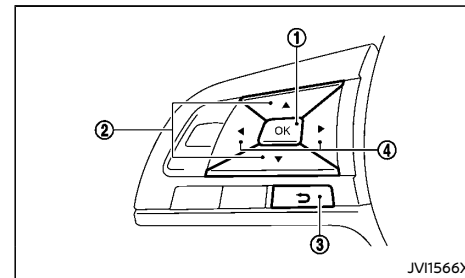

Steering wheel mounted control

JV11566X

- ① OK button
- ② ▲ / ▼ button
- ③ ↶ Back button
- ④ ◀ / ▶ button

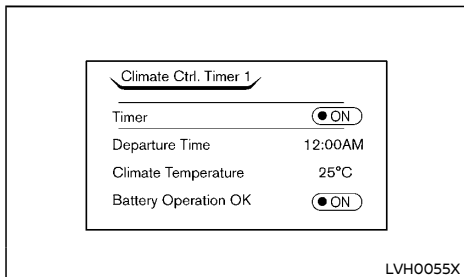

Vehicle information display

1. Push the ◀ / ▶ button to select “Settings” on the vehicle information display.
2. Push the ▲ / ▼ button to select “EV Settings” and then push the OK button.
3. Push the ▲ / ▼ button to select “Climate Ctrl. Timer1” or “Climate Ctrl. Timer2” and then push the OK button.
4. Push the ▲ / ▼ button to select “Timer” and then push the OK button and turn on the setting. The indicator light will turn on when the timer setting is turned on.
5. Push the ▲ / ▼ button to select “Departure Time” and then push the OK button.
6. Push the ▲ / ▼ button to set the hour and then push the OK button (models without NissanConnect System) or push the ◀ / ▶ button (models with NissanConnect System).
7. Push the ▲ / ▼ button to set the minute and then push the OK button. The setting can be changed with an increment

step of 10 minutes.

8. Push the ▲ / ▼ button to select “Climate Temperature” and then push the OK button.
9. Push the ▲ / ▼ button to set the temperature and then push the OK button.
10. After the setting is complete, place the power switch in the OFF position, and then connect the charge connector to the vehicle.

To return to the previous screen, push the ↶ Back button.

NOTE:

- With “Battery Operation OK” setting turned off, the Climate Ctrl. Timer does not activate if the charge connector is not connected to the vehicle. When “Battery Operation OK” is turned on and the charging connector is not connected to the vehicle, the Climate Ctrl. Timer will activate for 15 minutes.

When the outside temperature is high, the interior temperature may not reach the set temperature within the 15 minutes.

- Turn “Battery Operation OK” to off when it is not necessary to operate the Climate Ctrl. Timer in order to prevent the Li-ion battery from discharging.
- The Climate Ctrl. Timer operates repeatedly every day once it is turned on.

Operating tips for using Climate Ctrl. Timer:

- The Climate Ctrl. Timer will only start when the power switch is in the LOCK, OFF or ACC position.

- To turn off the Climate Ctrl. Timer function, turn off the “Climate Ctrl. Timer1” and “Climate Ctrl. Timer2” setting in the vehicle information display using the ▲ / ▼ button on the steering wheel. The start and stop time settings will not be deleted even if the Climate Ctrl. Timer function is turned off.
- If the Climate Ctrl. Timer starts operating while the vehicle is being charged, the time required for charging will be longer.
- Operating the Climate Ctrl. Timer in an environment where the temperature is low may decrease the rate of battery charge.
- Timer setting can also be changed while Climate Ctrl. Timer is operated. When the power switch is in the OFF position, the climate control system starts or enters waiting mode depending on the new timer settings.
- When the difference in temperature between the Climate Ctrl. Timer setting temperature and the temperature outside the vehicle is large, the temperature inside the vehicle may not be maintained at the setting temperature.
- The temperature in the passenger compartment may not be comfortable if entering the vehicle too soon before or too long after the scheduled time of departure.
- The climate control system operation is limited to the capacity of the electric power when the charge connector is connected to the vehicle. Therefore, the temperature may not reach the set temperature due to limitations in climate control system performance, if ambient temperature is excessively high or low.

- The Climate Ctrl. Timer operates the climate control system function so that a comfortable temperature is provided in the passenger compartment at the scheduled time of departure. The climate control system is set to stop at the scheduled time of departure.
- Depending on the facilities of charging station, there may be time when it is not available for charging. Confirm the availability of the charging facility before setting the Climate Ctrl. Timer. Be sure that the power switch of the charger is turned on when setting the Climate Ctrl. Timer.
- When the power switch is placed in the OFF position after changing the setting, the new setting will be applied.

AIR CONDITIONER FILTER

The air conditioner system is equipped with an air conditioner filter which collects and neutralizes dirt, pollen, dust, etc. To make sure that the air conditioner heats, defogs and ventilates efficiently, replace the filter in accordance with the specified maintenance intervals listed in the separate maintenance booklet. To replace the filter, contact a NISSAN certified LEAF dealer.

The filter should be replaced if the air flow decreases significantly or if windows fog up easily when operating the heater or air conditioner.

SERVICING CLIMATE CONTROL SYSTEM

The climate control system in your NISSAN is charged with a refrigerant designed with the environment in mind. **This refrigerant will not harm the earth's ozone layer.** Special charging equipment and lubricant are required when servicing your NISSAN climate control system. Using improper refrigerants or lubricants will cause severe damage to your climate control system. See "Recommended fluids/lubricants and capacities" (P.9-2).

A NISSAN certified LEAF dealer will be able to service your environmentally friendly climate control system.



WARNING:

The system contains refrigerant under high pressure. To avoid personal injury, any climate control system service should be done only by an experienced technician with the proper equipment.

AUDIO SYSTEM (if equipped)

For models with NissanConnect System:

Refer to the separate NissanConnect Owner's Manual for the audio system operations.

AUDIO OPERATION PRECAUTIONS



WARNING:

Do not adjust the audio system while driving so that full attention may be given to vehicle operation.

The audio system operates when the power switch is in the ACC or ON position.

Radio

- Radio reception is affected by station signal strength, distance from radio transmitter, buildings, bridges, mountains and other external influences. Intermittent changes in reception quality normally are caused by these external influences.
- Using a cellular phone in or near the vehicle may influence radio reception quality.

Compact Disc (CD) player

- During cold weather or rainy days, the player may malfunction due to the humidity. If this occurs, remove the CD from CD player and dehumidify or ventilate the player completely.
- The player may skip while driving on rough roads.
- The CD player sometimes may not function when the passenger compartment temperature is extremely high. Lower the temperature before use.
- Do not expose the CD to direct sunlight.
- CDs that are of poor quality, or are dirty, scratched, covered with fingerprints, or that have pin holes may not work properly.

- The following CDs may not work properly.
 - Copy control compact discs (CCCD)
 - Recordable compact discs (CD-R)
 - Rewritable compact discs (CD-RW)

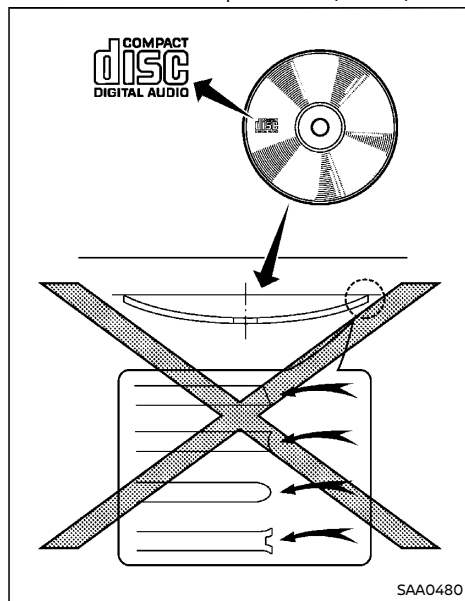

- Do not use the following CDs as they may cause the CD player to malfunction.
 - 8 cm (3.1 in) discs
 - CDs that are not round
 - CDs with a paper label
 - CDs that are warped, scratched or have unusual edges.

- CD lens cleaner discs
- This audio system can only play pre-recorded CDs. It has no capabilities to record or burn CDs.
- If the CD cannot be played, one of the following messages will be displayed.

Error CD:

- Confirm that the CD is inserted correctly (the label side is facing up, etc.).
- Confirm that the CD is not bent or warped and it is free of scratches.
- Confirm that the disc is a CD and not a DVD.
- Confirm that the disc contains audio files.

Eject CD:

This is a malfunction due to the temperature inside the player is too high. Remove the CD by pushing the CD eject button, and after a short time reinsert the CD. The CD can be played when the temperature of the player returns to normal.

USB (Universal Serial Bus) Connection Port



WARNING:

Do not connect, disconnect or operate the USB device while driving. Doing so can be a distraction. If distracted you could lose control of your vehicle and cause an accident or serious injury.



CAUTION:

- **Do not force the USB device into the USB connection port. Depending on the USB connection port, inserting the USB device tilted or upside down may damage the port. Make sure that the USB device is**

connected correctly into the USB connection port.

- **Do not grab the USB connection port cover (if equipped) when pulling the USB device out of the port. This could damage the port and the cover.**
- **Do not leave the USB cable in a place where it can be pulled unintentionally. Pulling the cable may damage the port.**

Refer to your device manufacturer's owner information regarding the proper use and care of the device.

The vehicle is not equipped with a USB device. USB devices should be purchased separately as necessary.

This system cannot be used to format USB devices. To format a USB device, use a personal computer.

In some states/area, the USB device for the front seats plays only sound without images for regulatory reasons, even when the vehicle is parked.

This system supports various USB memory devices, USB hard drives and iPod players. Some USB devices may not be supported by this system.

- Partitioned USB devices may not be played correctly.
- Some characters used in other languages (Chinese, Japanese, etc.) are not displayed properly on display. Using English language characters with a USB device is recommended.

General notes for USB use:

Refer to your device manufacturer's owner information regarding the proper use and care of the device.

Notes for iPod use:

“Made for iPod”, “Made for iPhone”, and “Made for iPad” mean that an electronic accessory has been designed to connect specifically to iPod, iPhone, or iPad, respectively, and has been certified by the developer to meet Apple performance standards.

Apple is not responsible for the operation of this device or its compliance with safety and regulatory standards.

Please note that the use of this accessory with iPod, iPhone, or iPad may affect wireless performance.

iPad, iPhone, iPod, iPod classic, iPod nano, iPod shuffle, and iPod touch are trademarks of Apple Inc., registered in the U.S. and other countries.

Lightning is a trademark of Apple Inc.

- Improperly plugging in the iPod may cause a checkmark to be displayed on and off (flickering). Always make sure that the iPod is connected properly.
- An iPod nano (1st Generation) may remain in fast forward or rewind mode if it is connected during a seek operation. In this case, please manually reset the iPod.
- An iPod nano (2nd Generation) will continue to fast forward or rewind if it is disconnected during a seek operation.
- An incorrect song title may appear when the Play Mode is changed while using an iPod nano (2nd Generation).
- Audiobooks may not play in the same order as they appear on an iPod.
- Large video files cause slow responses in an iPod. The vehicle center display may momentarily black out, but will soon recover.
- If an iPod automatically selects large video files while in the shuffle mode, the vehicle center display may momentarily black out,

but will soon recover.

Bluetooth® audio player

- Wireless LAN (Wi-Fi) and the Bluetooth® functions share the same frequency band (2.4 GHz). Using the Bluetooth® and the wireless LAN functions at the same time may slow down or disconnect communication and cause undesired noise. It is recommended that you turn off the wireless LAN (Wi-Fi) when using the Bluetooth® functions.
- Some Bluetooth® audio devices may not be used with this system. For detailed information about Bluetooth® audio devices that are available for use with this system, contact a NISSAN certified LEAF dealer.
- Before using a Bluetooth® audio system, the initial registration process for the audio device is necessary.
- Operation of the Bluetooth® audio system may vary depending on the audio device that is connected. Confirm the operation procedure before use.
- The playback of Bluetooth® audio will be paused under the following conditions. The playback will be resumed after the following conditions are completed.
 - while using a hands-free phone
 - while checking a connection with a cellular phone
- The in-vehicle antenna for Bluetooth® communication is built in the system. Do not place the Bluetooth® audio device in an area surrounded by metal, far away from the system or in a narrow space where the device closely contacts the body or the seat. Otherwise, sound degradation or connection interference may occur.

- While a Bluetooth® audio device is connected through the Bluetooth® wireless connection, the battery power of the device may discharge quicker than usual.
- This system is compatible with the Bluetooth® AV profile (A2DP and AVRCP).



Bluetooth® is a trademark owned by Bluetooth SIG, Inc., and licensed to Visteon Corporation.

Compact Disc (CD)/USB memory with MP3 or WMA

Terms:

- MP3 – MP3 is short for Moving Pictures Experts Group Audio Layer 3. MP3 is the most well known compressed digital audio file format. This format allows for near “CD quality” sound, but at a fraction of the size of normal audio files. MP3 conversion of an audio track from CD can reduce the file size by approximately 10:1 ratio with virtually no perceptible loss in quality. MP3 compression removes the redundant and irrelevant parts of a sound signal that the human ear does not hear.
- WMA – Windows Media Audio (WMA)* is a compressed audio format created by Microsoft as an alternative to MP3. The WMA codec offers greater file compression than the MP3 codec, enabling storage of more digital audio tracks in the same amount of space when compared to MP3s at the same level of quality.

This product is protected by certain intellectual property rights of Microsoft Corporation and third parties. Use or distribution of such technology outside of this product is prohibited without a license from Microsoft or an authorized Microsoft

subsidiary and third parties.

- Bit rate — Bit rate denotes the number of bits per second used by a digital music files. The size and quality of a compressed digital audio file is determined by the bit rate used when encoding the file.
- Sampling frequency — Sampling frequency is the rate at which the samples of a signal are converted from analog to digital (A/D conversion) per second.
- Multisession — Multisession is one of the methods for writing data to media. Writing data once to the media is called a single session, and writing more than once is called a multisession.
- ID3/WMA Tag — The ID3/WMA tag is the part of the encoded MP3 or WMA file that contains information about the digital music file such as song title, artist, album title, encoding bit rate, track time duration, etc. ID3 tag information is displayed on the Album/Artist/Track title line on the display.

* Windows® and Windows Media® are registered trademarks and/or trademarks of Microsoft Corporation in the United States of America and/or other countries.

Playback order:

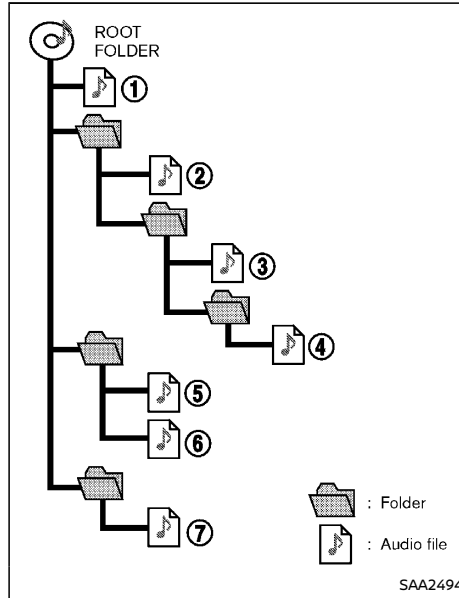

Music playback order of the CD with MP3 or WMA is as illustrated above.

- The names of folders not containing MP3/WMA files are not shown in the display.
- If there is a file in the top level of the disc, "Root" is displayed.
- The playback order is the order in which the files were written by the writing software, so the files might not be played in the desired order.

Specification chart:

Supported media			CD, CD-R, CD-RW, USB2.0
Supported file systems			CD, CD-R, CD-RW: ISO9660 LEVEL1, ISO9660 LEVEL2, Romeo, Joliet * ISO9660 Level 3 (packet writing) is not supported. * Files saved using the Live File System component (on a Windows Vista-based computer) are not supported.
			USB memory device: FAT16, FAT32
Supported versions*1	MP3	Version	MPEG1 Audio Layer 3
		Sampling frequency	32 kHz - 48 kHz
		Bit rate	32 kbps - 320 kbps, VBR*4
	WMA*2	Version	WMA7, WMA8, WMA9
		Sampling frequency	32 kHz - 48 kHz
		Bit rate	32 kbps - 192 kbps, VBR4, 32 kbps - 320 kbps (WMA9 only)
Tag information (Song title and Artist name)			ID3 tag VER1.0, VER1.1, VER2.2, VER2.3, VER2.4 (MP3 only)
			WMA tag (WMA only)
Folder levels		CD, CD-R, CD-RW	Folder levels: 8, Folders: 255, Files: 999 (Max. 255 files for one folder)
		USB	Folder levels: 8, Folders 255, Files: 2500 (Max. 255 files for one folder) Storage size: 4GB
Displayable character codes*3			01: ASCII, 02: ISO-8859-1, 03: UNICODE (UTF-16 BOM Big Endian), 04: UNICODE (UTF-16 Non-BOM Big Endian), 05: UNICODE (UTF-8)

*1 Files created with a combination of 48 kHz sampling frequency and 64 kbps bit rate cannot be played.

*2 Protected WMA files (DRM) cannot be played.

*3 Available codes depend on what kind of media, versions and information are going to be displayed.

*4 When VBR files are played, the playback time may not be displayed correctly.

Troubleshooting guide:

Symptom	Cause and Countermeasure
Cannot play	Check if the disc or USB device was inserted correctly.
	Check if the disc is scratched or dirty.
	Check if there is condensation inside the player, and if there is, wait until the condensation is gone (about 1 hour) before using the player.
	If there is a temperature increase error, the player will play correctly after it returns to the normal temperature.
	If there is a mixture of music CD files (CD-DA data) and compressed audio files on a CD, only the music CD files (CD-DA data) will be played.
	Files with extensions other than ".MP3", ".WMA", ".mp3" or ".wma" cannot be played. In addition, the character codes and number of characters for folder names and file names should be in compliance with the specifications.
	Check if the disc or the file is generated in an irregular format. This may occur depending on the variation or the setting of compressed audio writing applications or other text editing applications.
	Check if the finalization process, such as session close and disc close, is done for the disc.
Poor sound quality	Check if the disc is scratched or dirty.
It takes a relatively long time before the music starts playing.	If there are many folder or file levels on the disc or USB device, some time may be required before the music starts playing.
Music cuts off or skips	The writing software and hardware combination might not match, or the writing speed, writing depth, writing width, etc., might not match the specifications. Try using the slowest writing speed.
Skipping with high bit rate files	Skipping may occur with large quantities of data, such as for high bit rate data.
Move immediately to the next song when playing.	If an unsupported compressed audio file has been given a supported extension like .MP3, or when play is prohibited by copyright protection, the player will skip to the next song.
The songs do not play back in the desired order.	The playback order is the order in which the files were written by the writing software, so the files might not play in the desired order.
	Random/Shuffle may be active on the audio system or on a USB device.

ANTENNA

Removing antenna

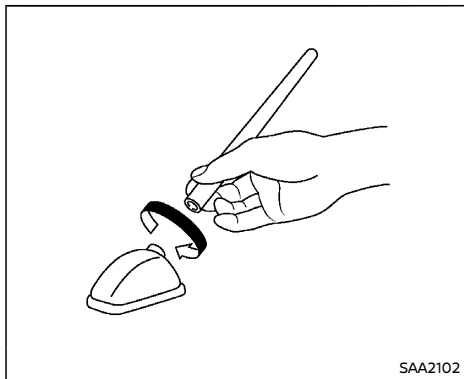

You can remove the antenna if necessary.

Hold the bottom of the antenna and remove it by turning counterclockwise.

To install the antenna, turn the antenna clockwise and tighten.



CAUTION:

To avoid damaging or deforming the antenna, be sure to remove the antenna under the following conditions.

- The vehicle enters an automatic car wash.
- The vehicle enters a garage with a low ceiling.
- The vehicle is covered with a car cover.

FM-AM RADIO WITH COMPACT DISC (CD) PLAYER

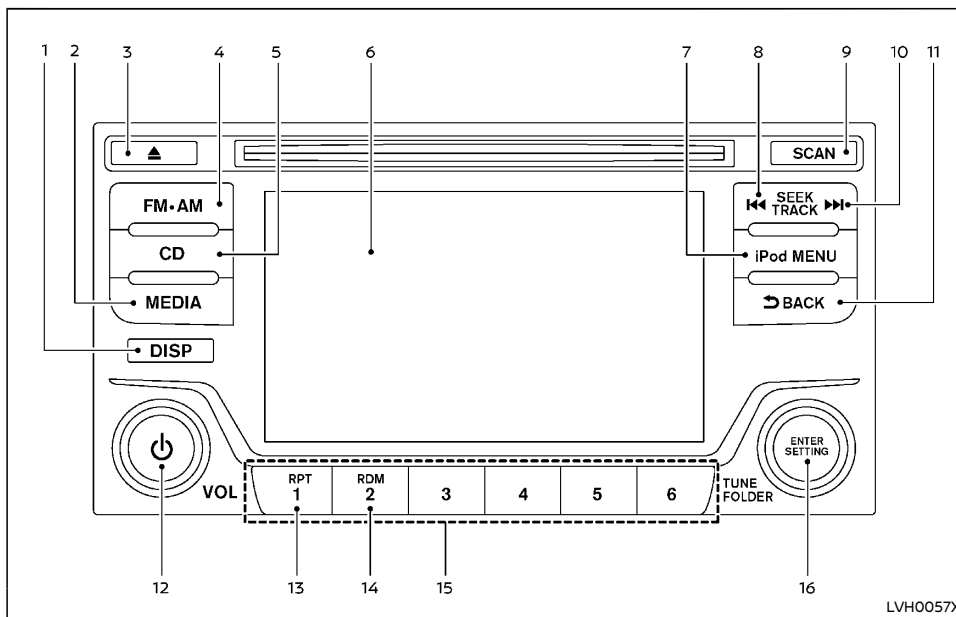

1. DISP (display) button
2. MEDIA button
3. CD eject button
4. FM-AM button
5. CD button
6. Color display
7. iPod MENU button
8. SEEK TRACK (rewind) button
9. SCAN button
10. SEEK TRACK (forward) button
11. BACK button
12. Power/VOL (Volume) dial
13. RPT (repeat) button
14. RDM (random) button
15. Radio memory buttons
16. ENTER/SETTING dial

Audio main operation

Head unit:

The auto loudness circuit enhances the low and high frequency ranges automatically in both radio reception and CD playback.



Power/VOL dial:

Push the Power/VOL dial to turn the audio system on and off while the power switch is placed in the ON or ACC position.

Turn the Power/VOL dial to adjust the volume.

Audio settings:

The settings screen will appear when the ENTER/SETTING dial is pushed. Select a preferred item by turning the ENTER/SETTING dial and then pushing the ENTER/SETTING dial.

The following items are available in the settings screen.

- **Bluetooth**
It is possible to set the Bluetooth® settings. See "Bluetooth® settings" (P.4-34).
- **Bass, Treble, Balance and Fade**
Controls the sound of the audio system. Balance adjusts the sound between the left and right speakers. Fade adjusts the sound between the front and rear speakers.
Select the "Bass", "Treble", "Balance" or "Fade" by turning the ENTER/SETTING dial and then push the ENTER/SETTING dial. Turn the ENTER/SETTING dial to adjust the Bass, Treble, Balance and Fade to the preferred level.
- **Brightness and Contrast**
Adjust the brightness and contrast of the screen.
Select "Brightness" or "Contrast" by turning

the ENTER/SETTING dial and then push the ENTER/SETTING dial. Turn the ENTER/SETTING dial to adjust the brightness and contrast of the screen to the preferred level.

- **Clock Adjust**
Adjust the clock according to the following procedure.
 - 1) Select "Clock Adjust" by turning the ENTER/SETTING dial and then push the ENTER/SETTING dial.
 - 2) Adjust the hour with the ENTER/SETTING dial and then push the ENTER/SETTING dial.
 - 3) Adjust the minute with the ENTER/SETTING dial and then push the ENTER/SETTING dial.24-hour clock is not available.
- **On-Screen Clock**
When this item is turned on, a clock is always displayed in the upper right corner of the screen.
Select "On-Screen Clock" by turning the ENTER/SETTING dial and then push the ENTER/SETTING dial. You can toggle between ON and OFF by using the ENTER/SETTING dial.
- **RDS Display**
RDS (radio data system) information can be shown on the display.
Select "RDS Display" by turning the ENTER/SETTING dial and then push the ENTER/SETTING dial. You can toggle between ON and OFF using the ENTER/SETTING dial.
- **Speed Sensitive Vol.**
To change the Speed Sensitive Volume level from off (0) to 5, turn the ENTER/SETTING dial.

- **AUX Vol.**
Controls the volume level of incoming sound when an auxiliary device is connected to the system. Choose a setting between 1 and 3 or choose 0 to disable the feature entirely.
- **Language Select**
The language settings can be changed.
Select "Language Select" by turning the ENTER/SETTING dial and then push the ENTER/SETTING dial. Use the ENTER/SETTING dial to select the preferred language.
- **Auto Source Change**
When this item is turned on, connecting the USB memory device or iPod to the USB connection port will automatically switch the system to the USB/iPod mode.
Select "Auto Source Change" by turning the ENTER/SETTING dial and then push the ENTER/SETTING dial. You can toggle between ON and OFF using the ENTER/SETTING dial.

DISP button:

- **Models without the Intelligent Around View Monitor**
Display of the screen can be turned off by pushing the DISP button. You can still listen to music that is being played back even while the screen display is off. If you want to display the screen again, push the DISP button once more. Pushing some of the audio source buttons will also turn the screen back on and display the screen of the corresponding audio source.
- **Models with the Intelligent Around View Monitor**
The Intelligent Around View Monitor can be displayed by pushing the DISP button. (See

"Intelligent Around View Monitor" (P.4-3) for details.) You can still listen to music that is being played back even while the audio screen is off. If you want to display the audio screen again, push the DISP button repeatedly. Pushing some of the audio source buttons will also display the screen of the corresponding audio source.

MEDIA button:

Pushing the MEDIA button will switch the displays as follows:

Bluetooth → AUX → USB/iPod → Bluetooth

BACK button:

When the BACK button is pushed, the display will return to the previous screen.

Radio operation

FM-AM button:

Push the FM-AM button to change the band as follows:

AM → FM1 → FM2 → AM

TUNE (Tuning):

Turn the ENTER/SETTING dial for manual tuning.

Radio Data System (RDS) :



RDS stands for Radio Data System, and is a data information service transmitted by some radio stations on the FM band (not AM band) encoded within a regular radio broadcast. Currently, most RDS stations are in large cities, but many stations are now considering broadcasting RDS data.

RDS can display:

- Station name, such as "The Groove".

- Music or programming type such as "Classical", "Country" or "Rock".

SEEK TRACK buttons:

Push the  or  button to tune from low to high or high to low frequencies and to stop at the next broadcasting station.

The radio will mute while seeking for available stations. When an available station is detected, it will stop at the frequency and start playing the station.





SCAN buttons:

Push the SCAN button to tune from low to high frequencies and stop at each broadcasting station for 5 seconds. Pushing the button again during this 5-second period will stop SCAN tuning and the radio will remain tuned to that station.

If the SCAN button is not pushed within 5 seconds, SCAN tuning moves to the next station.

to **Radio memory buttons:**

Up to 12 stations can be set for the FM band (6 each for FM1 and FM2) and 6 stations can be set for the AM band.

1. Choose the radio band using the FM-AM button.
2. Tune to the desired station using the   buttons or the ENTER/SETTING dial.
3. Push and hold the desired radio memory button  to .
4. The station indicator will then come on. The station is now set to the button memory.
5. Other buttons can be set in the same manner.

If the battery cable is disconnected, or if the

fuse opens, the station memory will be erased. In that case, reset the desired stations.

CD player operation

Place the power switch in the ON or ACC position, and insert a CD into the slot with the label side facing up. The CD will be guided automatically into the slot and start playing.

After loading the CD, the number of tracks on the CD and the play time will appear on the display.

If the radio is already operating, it will automatically turn off and the CD will play.



If the system was turned off while the CD was playing, pushing the Power/VOL dial will start the CD.



CD button:

When the CD button is pushed with the system off and the CD loaded, the system will turn on and the CD will start to play.

When the CD button is pushed with the CD loaded and the radio playing, the radio will automatically be turned off and the CD will start to play.

SEEK TRACK (rewind/forward) buttons:

When the  or  button is pushed and held while the CD is being played, the CD will play while fast forwarding or rewinding. When the button is released, the CD will return to normal play speed.

When the  or  button is pushed for less than 1.5 seconds while the CD is being played, the next track or the beginning of the current track on the CD will be played.

RPT (REPEAT) button:

When the RPT button is pushed while the CD is played, the play pattern can be changed.

The selected play pattern will be displayed on the screen.

RDM (RANDOM) button:

When the RDM button is pushed while a CD is being played, the play pattern can be changed.

The selected play pattern will be displayed on the screen.

**CD eject button:**

When the CD eject button is pushed with the CD loaded, the CD will be ejected.

When this button is pushed while the CD is being played, the CD will be ejected.

If the CD comes out and is not removed, it will be pulled back into the slot to protect it.

USB (Universal Serial Bus) connection port**USB main operation:**

The USB connection port is located on the lower part of the instrument panel. See "USB (Universal Serial Bus) connection port/Auxiliary (AUX) input jack" (P.4-30). Connect a USB memory device into the connection port.

When the "Auto Source Change" is turned on, connecting the USB memory device to the connection port will automatically switch the system to the USB mode. See "Audio main operation" (P.4-26).

If the system was turned off while the USB memory device was playing, pushing the Power/VOL dial will start the USB memory device.

The following operations are identical to the audio main operation of the CD player. For details, see "CD player operation" (P.4-27).

-  
- RDM (Random play)
- RPT (Repeat track)

MEDIA button:

To change to the USB mode, push the MEDIA button with a USB memory device connected until the USB mode is selected.

iPod player operation**Connecting iPod:**

The USB connection port is located on the lower part of the instrument panel. Connect the iPod to the USB connection port using a cable. See "USB (Universal Serial Bus) connection port/Auxiliary (AUX) input jack" (P.4-30). The battery of the iPod is charged while the cable is connected to the vehicle.

Depending on the version of the iPod, the display on the iPod shows a NISSAN or Accessory Attached screen when the connection is completed. When the iPod is connected to the vehicle, the iPod music library can only be operated by the vehicle audio controls.

* iPod and iPhone are a trademark of Apple Inc., registered in the U.S. and other countries.

Refer to your device manufacturer's owner information regarding the proper use and care of the device.

Compatibility:

The following models are supported:

- iPod nano 1G (Firmware version 1.3.1 -)
- iPod nano 2G (Firmware version 1.1.3 -)

- iPod nano 3G (Firmware version 1.0.0 -)
- iPod nano 4G (Firmware version 1.0.2 -)
- iPod nano 5G (Firmware version 1.0.1 -)
- iPod nano 6G (Firmware version 1.0 -)
- iPod nano 7G (Firmware version 1.0.0 -)
- iPod classic (Firmware version 1.0.0 -)
- iPod Touch (iOS 1.1 -)
- iPod Touch 2G (iOS 2.1.1 -)
- iPod Touch 3G (iOS 3.1 -)
- iPod Touch 4G (iOS 4.1 -)
- iPod Touch 5G (iOS 6.0.0 -)
- iPhone 3G (iOS 2.1 -)
- iPhone 3GS (iOS 3.0 -)
- iPhone 4/4S (iOS 4.0 -)
- iPhone 5 (iOS 6.0.0 -)

The system may not support operations attributable to Apple firmware updates.

iPod main operation:

The system operates when the power switch is in the ON or ACC position. Push the MEDIA button repeatedly or push the iPod MENU button to switch to the iPod mode.

When "Auto Source Change" is turned on, connecting the iPod to the connection port will automatically switch the system to the iPod mode. See "Audio main operation" (P.4-26).

If the system was turned off while the iPod was playing, pushing the Power/VOL dial will start the iPod.

If another audio source is playing and the iPod is connected with "Auto Source Change" turned off, pushing the MEDIA button repeatedly or pushing the iPod MENU button will change the system to the iPod mode.

When the iPod MENU button is pushed while the iPod is connected, the interface for iPod operation is shown on the audio display. The

items on the menu list can be scrolled by turning the ENTER/SETTING dial while the iPod is operating. To select an item, push the ENTER/SETTING dial. Items in the iPod menu appear on the display in the following order.

- Now playing
- Playlists
- Artists
- Albums
- Songs
- Podcasts
- Genres
- Composers
- Audiobooks
- Shuffle Songs

For more information about each item, see the iPod owner's manual.

The following operations are identical to the audio main operation of the CD player. For details, see "CD player operation" (P.4-27).

-  
- RDM (Random play)
- RPT (Repeat track)

Bluetooth® audio player operation

If you have a compatible Bluetooth® audio device that is capable of playing audio files, the device can be connected to the vehicle's audio system so that the audio files on the device play through the vehicle's speakers.

Regulatory information:

Bluetooth® trademark:



Bluetooth® is a trademark owned by Bluetooth SIG, Inc. and licensed to Visteon Corporation.

Connecting Bluetooth® device:

To connect your Bluetooth® device to the vehicle, follow the procedure below:

1. Push the ENTER/SETTING dial.

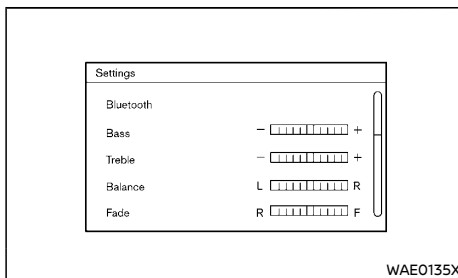

2. Select "Bluetooth". This same screen can be accessed to remove, replace or select a different Bluetooth® device.
3. Select "Add Phone" using the ENTER/SETTING dial.
4. The system acknowledges the command and asks you to initiate a connection from the Bluetooth® device. The procedure for connecting a Bluetooth® device varies according to the cellular phone model. See the owner's manual of the Bluetooth® device for details.

Bluetooth® audio main operation:

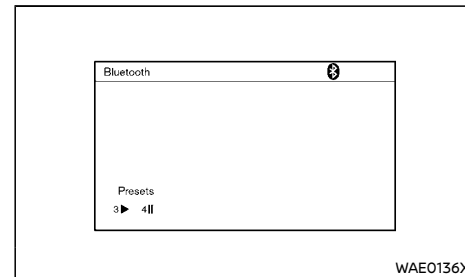

To switch to the Bluetooth® audio mode, push the MEDIA button repeatedly until the Bluetooth® audio mode is displayed on the screen.

The controls for the Bluetooth® audio are displayed on the screen. Use the radio memory **3** button to play and use the radio memory **4** button to pause.

The following operations are identical to the audio main operation of the CD player. For details, see "CD player operation" (P.4-27).

-  
- RDM (Random play)
- RPT (Repeat track)

AUX device player operation

The AUX input jack is located on the lower part of the instrument panel. See "USB (Universal Serial Bus) connection port/Auxiliary (AUX) input jack" (P.4-30). The AUX input jack accepts any standard analog audio input such as from a portable cassette tape/CD player, MP3 player or laptop computer.

To play a compatible device, push the MEDIA button repeatedly until the AUX mode is selected.

NISSAN strongly recommends using a stereo mini plug cable when connecting your music device to the audio system. Music may not play properly when a monaural cable is used.

STEERING WHEEL MOUNTED CONTROLS FOR AUDIO

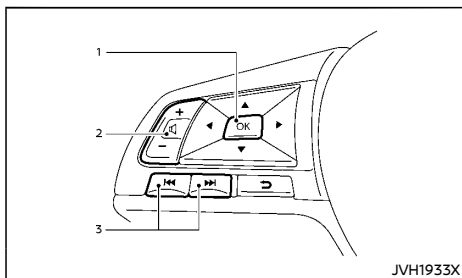

1. OK button
2. Volume control buttons
3. Tuning buttons



OK button

When audio screen is displayed on the vehicle information display, Push the OK button to switch audio source.

Volume control buttons





Push the + or - button to increase or decrease the volume.

Tuning buttons





Push the  /  buttons to select a station or track.

Depending on the status of the vehicle information display, the tuning buttons cannot be used for audio control.





RADIO:

- Pushing  /  shorter
Next or previous preset station
- Pushing  /  longer
Next or previous station



CD with MP3/WMA or USB device:

- Pushing  /  shorter
Next track or the beginning of the current track (the previous track if the button is pushed immediately after the current track starts playing)
- Pushing  /  longer
Next or previous folder

CD or Bluetooth® audio:

- Pushing  /  shorter
Next track or the beginning of the current track (the previous track if the button is pushed immediately after the current track starts playing)
- Pushing  /  longer
Fast forward or rewind

iPod:

- Pushing  /  shorter
Next track or the beginning of the current track (the previous track if the button is pushed immediately after the current track starts playing)

USB (Universal Serial Bus) CONNECTION PORT/AUXILIARY (AUX) INPUT JACK

The USB connection port/AUX input jack are located on the lower part of the instrument panel.

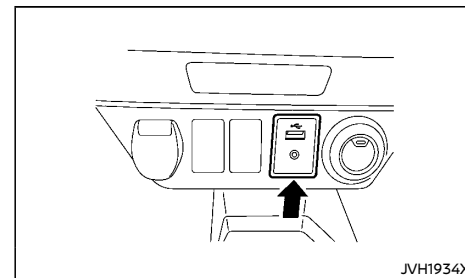

USB connection port:

Insert a USB device or an iPod connector into this port.

Refer to your device manufacturer's owner's manual regarding the proper use and care of the device.



WARNING:

Do not connect, disconnect or operate the USB device while driving. Doing so can be a distraction. If distracted you could lose control of your vehicle and cause an accident or serious injury.



CAUTION:

- **Do not force the USB device into the USB connection port. Depending on the USB connection port, inserting the USB device tilted or upside down may damage the**

port. Make sure that the USB device is connected correctly into the USB connection port.

- Do not grab the USB connection port cover (if equipped) when pulling the USB device out of the port. This could damage the port and the cover.
- Do not leave the USB cable in a place where it can be pulled unintentionally. Pulling the cable may damage the port.

AUX input jack:

Compatible audio devices, such as some MP3 players, can be connected to the system through the AUX input jack.

Before connecting a device to the jack, turn off the power of the portable device.

With a compatible device connected to the jack, push the MEDIA button repeatedly until the display switches to the AUX mode.

NISSAN strongly recommends using a stereo mini plug cable when connecting your music device to the audio system. Music may not play properly when a monaural cable is used.



WARNING:

Do not allow the cable or an external device connected to the AUX terminal to affect your driving.

NOTE:

- Depending on the external device, the volume may be louder or quieter than that of the external device.
- When the AUX contacts the plug of the connector cable, noise may be heard.
- The connected external device cannot be operated with the main audio system. The volume and sound quality can be

adjusted.

- The song title in the external device cannot be displayed on the audio display.
- For the power source of the external device, use the special battery. The external device cannot be charged with the AUX terminal. Noise may be heard if the CD, radio, etc. is operated while charging the battery with the power socket of the vehicle.

CD/USB MEMORY DEVICE CARE AND CLEANING

CD

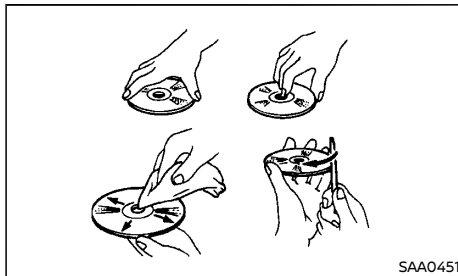

- Handle a disc by its edges. Never touch the surface of the disc. Do not bend the disc.
- Always place disc in their storage case when they are not being used.
- To clean a disc, wipe the surface from the center to the outer edge using a clean, soft cloth. Do not wipe the disc using a circular motion.
Do not use a conventional record cleaner or alcohol intended for industrial use.

- A new disc may be rough on the inner and outer edges. Remove the rough edges by rubbing the inner and outer edges with the side of a pen or pencil as illustrated.

USB memory device

- Do not touch the terminal portion of the USB memory device.
- Do not place heavy objects on the USB memory device.
- Do not store the USB memory device in highly humid locations.
- Do not expose the USB memory device to direct sunlight.
- Do not spill any liquids on the USB memory device.

Refer to the USB memory device owner's manual for the details.

CAR PHONE OR CB RADIO

When installing a CB, ham radio or a car phone in your vehicle, be sure to observe the following cautions, otherwise the new equipment may adversely affect the electronic control modules and electronic control system harness.

CAUTION:

- Keep the antenna as far away as possible from the electronic control modules.
- Keep the antenna wire at least 20 cm (8 in) away from the electronic control system harnesses. Do not route the antenna wire next to any harnesses.
- Adjust the antenna standing wave ratio as recommended by the manufacturer.
- Connect the ground wire from the radio chassis to the body.
- For details, consult a NISSAN certified LEAF dealer.

Bluetooth® HANDS-FREE PHONE SYSTEM (if equipped)

For models with NissanConnect System:

Refer to the separate NissanConnect Owner's Manual for the hands-free phone system operations.

WARNING:

- Use a phone after stopping your vehicle in a safe location. If you have to use a phone while driving, exercise extreme caution at all times so full attention may be given to vehicle operation.
- If you find yourself unable to devote full attention to vehicle operation while talking on the phone, pull off the road to a safe location and stop your vehicle before doing so.

CAUTION:

To avoid draining the vehicle battery, use a phone after starting the EV (Electric Vehicle) system.

Your vehicle is equipped with the Bluetooth® Hands-Free Phone System. If you have a compatible Bluetooth® enabled cellular phone, you can set up the wireless connection between your cellular phone and the in-vehicle phone module. With Bluetooth® wireless technology, you can make or receive a hands-free telephone call with your cellular phone in the vehicle.

Once your cellular phone is connected to the in-vehicle phone module, no other phone connecting procedure is required. Your phone is automatically connected with the in-vehicle phone module when the power switch is placed in the ON position with the previously connected cellular phone turned on and carried in the vehicle.

NOTE:

Some devices require the user to accept connections to other Bluetooth® devices. If your phone does not connect automatically to the system, consult the phone's owner's manual for details on device operation.

You can connect up to 5 different Bluetooth® cellular phones to the in-vehicle phone module. However, you can talk on only one cellular phone at a time.

Before using the Bluetooth® Hands-Free Phone System, refer to the following notes.

- Set up the wireless connection between a compatible cellular phone and the in-vehicle phone module before using the hands-free phone system.
- Some Bluetooth® enabled cellular phones may not be recognized or work properly. For details, consult a NISSAN certified LEAF dealer.
- You will not be able to use a hands-free phone under the following conditions:
 - Your vehicle is outside of the cellular service area.
 - Your vehicle is in an area where it is difficult to receive a cellular signal; such as in a tunnel, in an underground parking garage, near a tall building or in a mountainous area.
 - Your cellular phone is locked to prevent it from being dialed.
- When the radio wave condition is not ideal or ambient sound is too loud, it may be difficult to hear the other person's voice during a call.
- Do not place the cellular phone in an area surrounded by metal or far away from the in-vehicle phone module to prevent tone quality degradation and wireless connec-

tion disruption.

- While a cellular phone is connected through the Bluetooth® wireless connection, the battery power of the cellular phone may discharge quicker than usual. The Bluetooth® Hands-Free Phone System cannot charge cellular phones.
- Some cellular phones or other devices may cause interference or a buzzing noise to come from the audio system speakers. Storing the device in a different location may reduce or eliminate the noise.
- Refer to the cellular phone owner's manual regarding the telephone charges, cellular phone antenna and body, etc.

REGULATORY INFORMATION

Bluetooth® Trademark



Bluetooth® is a trademark owned by Bluetooth SIG, Inc. and licensed to Visteon Corporation.

CONTROL BUTTONS AND MICROPHONE

Steering wheel mounted control:

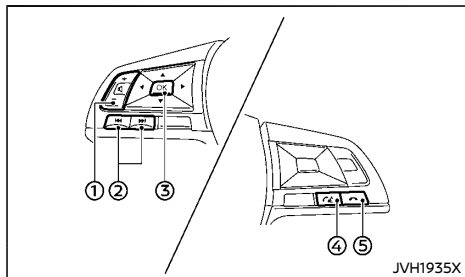

1. Volume control button
Increases or decreases the volume from the system.
2. Tuning / buttons
3. OK button
4. PHONE SEND button
5. PHONE END button

Microphone:

Microphone is located on the map light.

USING THE SYSTEM

The hands-free mode can be operated using the button on the steering wheel.

Choosing a language

You can interact with the Bluetooth® Hands-Free Phone System using several languages that are available. For operations to change the language, see "Audio main operation" (P.4-26).

Changing voice feedback volume

If you want to adjust the volume of the voice feedback, push the volume control button (+ or - side of the volume control button) while being provided with feedback. You can also use the Power/VOL dial on the audio unit.

Initialization

When the power switch is placed in the ON position, the Bluetooth® Hands-Free Phone System is initialized which takes a few seconds. If the button is pushed before the initialization completes, the system will announce that the hands-free phone system is not ready.

Connecting procedure

You can register up to 5 different Bluetooth® cellular phones in the in-vehicle phone module. However, you can talk on only one cellular phone at a time.





To connect a phone to the Bluetooth® Hands-Free Phone System:

1. Push the ENTER/SETTING dial.
2. Turn the ENTER/SETTING dial to select "Bluetooth" and then push the ENTER/SETTING dial.
3. Select "Add Phone" and then push the ENTER/SETTING dial.
4. When a message with a PIN appears on the screen, operate the Bluetooth® phone to enter the PIN.
5. The connecting procedure varies according to each phone. See the phone's owner's manual for details.

Making a call from the phonebook



1. Push the button on the steering wheel and then use the / buttons and OK button on the steering wheel to select "Phonebook".
2. Use the / buttons and OK button on the steering wheel to select "List Names".
3. Use the / buttons and OK button on the steering wheel to select the person you wish to call.
4. Push the button on the steering wheel to accept the selection. The system acknowledges the selection and starts dialing.

Redialing

1. Use the  button on the steering wheel and then push the / buttons and OK button on the steering wheel to select "Call".
2. Use the / buttons and OK button on the steering wheel and select "Redial" to call the last number dialed.

Receiving a call

When a call is received by the phone connected to the vehicle's Bluetooth® Hands-Free Phone System, the call information is displayed.



Push the  button to accept the call. Push the  button to reject the call.

Received call notification setting can be changed. See "Bluetooth® settings" (P.4-34) for detail.

During a call



While a call is active, push the  button to access additional options. Select one of the following commands:

- "Mute On"/ "Mute Off"
Select the command to mute or unmute the system.
- "Transfer Call"
Select this command to transfer the call to the handset. To transfer the call back from the handset to the Bluetooth® Hands-Free Phone System, push the  button and confirm when prompted.

If supported by the phone, the Bluetooth® Hands-Free Phone System allows for call waiting functionality. If a call is received while another call is already active, a message will be displayed on the screen. Push the  button to hold the active call and switch to the second call. Push the  button to reject the second call.

While the second call is active, pushing the  button will allow the same commands that are available during any call as well as two additional commands:

- "Switch Call"
Select this command to hold the second call and switch back to the original call.
- "End Other Call"
Select this command to stay with the second call and end the original call.

Push the  button to accept the call. Push the  button to reject the call.

Ending a call

To end an active call, push the  button.

Bluetooth® SETTINGS

To access and adjust the settings for the Bluetooth® Hands-Free Phone System:

1. Push the ENTER/SETTING dial.
2. Turn the ENTER/SETTING dial to select "Bluetooth" and then push the ENTER/SETTING dial.

Available setting items:

- Bluetooth
Select "ON" or "OFF" to turn the vehicle's Bluetooth® system on or off.
- Add Phone
For operation to connect a phone to the system, see "Connecting procedure" (P.4-33).
- Delete Phone
Select to delete a phone from the displayed list. The system will ask to confirm before deleting the phone.

NOTE:

When you delete a phone, the associated phonebook for the phone will also be deleted.

- Replace Phone
Select to replace a phone from the displayed list. When a selection is made, the system will ask to confirm before proceeding. The recorded phonebook for the phone being deleted will be saved as long as the new phone's phonebook is the same as the old phone's phonebook.
- Select Phone
Select to connect to a previously connected phone from the displayed list.
- Phonebook Download
Select to turn on or off the automatic download of a connected phone's phonebook.
- Show Incoming Calls
Select "Driver Only" to have incoming call information displayed only in the vehicle information display. Select "Both" to have incoming call information displayed in both the vehicle information display and the center display screen.
Depending on the models, vehicle information display may not show the incoming call information.

5 Starting and driving

Before starting the EV (Electric Vehicle) system	5-3	System temporarily unavailable	5-18
Precautions when starting and driving	5-3	System malfunction	5-18
Care when driving	5-3	System maintenance	5-18
Loading luggage	5-3	Intelligent Lane Intervention system (if equipped)	5-19
Driving in wet conditions	5-3	Intelligent Lane Intervention system operation	5-20
Driving in winter conditions	5-3	Intelligent Lane Intervention system limitations	5-20
Push-button power switch	5-4	System temporarily unavailable	5-21
Intelligent Key system	5-4	System malfunction	5-22
Power switch operation	5-4	System maintenance	5-22
Power switch positions	5-5	Intelligent Driver Alertness (if equipped)	5-23
Emergency EV (Electric Vehicle) system shut off	5-5	Intelligent Driver Alertness system operation	5-23
Intelligent Key battery discharge	5-5	How to enable/disable the Intelligent Driver Alertness system	5-24
Starting the EV (Electric Vehicle) system	5-6	Intelligent Driver Alertness system limitations	5-24
Driving vehicle	5-6	System malfunction	5-25
Electric shift control system	5-6	Intelligent Emergency Braking system (if equipped)	5-25
e-Pedal system	5-8	Intelligent Emergency Braking system operation	5-26
e-Pedal system operation	5-9	Turning the Intelligent Emergency Braking system ON/OFF	5-27
e-Pedal system limitations	5-10	Intelligent Emergency Braking system limitations	5-28
e-Pedal system malfunction	5-11	System temporarily unavailable	5-29
Electronic Stability Program (ESP) system	5-11	System malfunction	5-30
How to turn off the ESP system	5-12	System maintenance	5-30
Chassis control	5-12	ECO mode	5-31
Intelligent Trace Control	5-12	Increasing power economy	5-31
Intelligent Ride Control	5-13	Parking	5-32
Hill start assist system	5-13	Trailer towing	5-33
Cruise control	5-14	Electric power steering	5-34
Precautions on cruise control	5-14	Brake system	5-34
Lane Departure Warning (LDW) system (if equipped)	5-16	Braking precautions	5-34
LDW system operation	5-16		
How to enable/disable the LDW system	5-17		
LDW system limitations	5-17		

Anti-lock Braking System (ABS)	5-35
Vehicle security	5-36
Cold weather driving	5-37
12-volt battery	5-37
Coolant	5-37

Tire equipment	5-37
Special winter equipment	5-37
Parking brake	5-37
Corrosion protection	5-38
Freeing a frozen charge port lid	5-38

BEFORE STARTING THE EV (Electric Vehicle) SYSTEM



WARNING:

The driving characteristics of your vehicle will change remarkably by any additional load and its distribution, as well as by adding optional equipment (trailer coupling, roof racks, etc.). Your driving style and speed must be adjusted according to the circumstances. Especially when carrying heavy loads, your speed must be reduced adequately.

- Make sure the area around the vehicle is clear.
- Visually inspect tires for their appearance and condition. Measure and check the tire pressure for proper inflation.
- Check that all windows and lights are clean.
- Adjust the seat and head restraint positions.
- Adjust the inside and outside rearview mirror positions.
- Fasten your seat belt and ask all passengers to do the same.
- Check that all doors are closed.
- Check the operation of the warning lights when the power switch is placed in the ON position.
- Maintenance items in the "8. Maintenance and do-it-yourself" section should be checked periodically.

PRECAUTIONS WHEN STARTING AND DRIVING



WARNING:

- **Never leave children or adults who would normally require the support of others alone in your vehicle. Pets should not be left alone either. They could unknowingly activate switches or controls and inadvertently become involved in a serious accident and injure themselves. On hot, sunny days, temperatures in a closed vehicle could quickly become high enough to cause severe or possibly fatal injuries to people or animals.**
- **Properly secure all cargo to help prevent it from sliding or shifting. Do not place cargo higher than the seatbacks. In a sudden stop or collision, unsecured cargo could cause personal injury.**

NOTE:

During the first few months after purchasing a new vehicle, if you smell strong odors of Volatile Organic Compounds (VOCs) inside the vehicle, ventilate the passenger compartment thoroughly. Open all the windows before entering or while in the vehicle. In addition, when the temperature in the passenger compartment rises, or when the vehicle is parked in direct sunlight for a period of time, turn off the air recirculation mode of the air conditioner and/or open the windows to allow sufficient fresh air into the passenger compartment.

CARE WHEN DRIVING

Driving your vehicle to fit the circumstances is essential for your safety and comfort. As a driver, you should be the one who knows best how to drive in the given circumstances.

LOADING LUGGAGE

Loads and their distribution and the attachment of equipment (coupling devices, roof baggage carriers, etc.) will considerably change the driving characteristics of the vehicle. Your driving style and speed must be adjusted according to the circumstances.

DRIVING IN WET CONDITIONS

- Avoid accelerating or stopping suddenly.
- Avoid sharp turning or lane changing suddenly.
- Avoid following too close to the vehicle in front.

When water covers the road surface with water puddles, small water streams, etc., reduce speed to prevent hydroplaning which can cause skidding and loss of control. Worn tires will increase this risk.

DRIVING IN WINTER CONDITIONS

- Drive cautiously.
- Avoid accelerating or stopping suddenly.
- Avoid sharp turning or lane changing suddenly.
- Avoid sudden steering.
- Avoid following too close to the vehicle in front.

PUSH-BUTTON POWER SWITCH

WARNING:

Do not operate the power switch while driving the vehicle except in an emergency. (The EV system shuts down when the power switch is pushed 3 consecutive times or the power switch is pushed and held for more than 2 seconds.) If the EV system stops while the vehicle is being driven, this could lead to a crash and serious injury.

Before operating the power switch, make sure the vehicle is in the P (Park) position.

INTELLIGENT KEY SYSTEM

The Intelligent Key system can be used to operate the power switch without taking the key out from your pocket or bag. The operating environment and/or conditions may affect the Intelligent Key system operation.

Some indicators and warnings for operation are displayed on the vehicle information display. See "Vehicle information display" (P.2-15).

CAUTION:

- Be sure to carry the Intelligent Key with you when operating the vehicle.
- Never leave the Intelligent Key inside the vehicle when you leave the vehicle.
- If the 12-volt battery is discharged, the power switch cannot be switched from the LOCK position, and if the steering lock is engaged, the steering wheel cannot be moved. Charge the 12-volt battery as soon as possible. See "Jump starting" (P.6-9).

Operating range

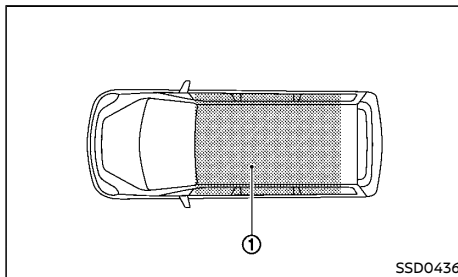

The Intelligent Key function can only be used for starting the EV (Electric Vehicle) system when the Intelligent Key is within the specified operating range ①.

When the Intelligent Key battery is almost discharged or strong radio waves are present near the operating location, the Intelligent Key system's operating range becomes narrower and it may not function properly.

If the Intelligent Key is within the operating range, it is possible for anyone, even someone who does not carry the Intelligent Key, to push the power switch to start the EV system.

- The cargo area is not included in the operating range but the Intelligent Key may function.
- If the Intelligent Key is placed on the instrument panel, inside the glove box or door pocket, the Intelligent Key may not function.
- If the Intelligent Key is placed near a door or window outside the vehicle, the Intelligent Key may not function.

POWER SWITCH OPERATION

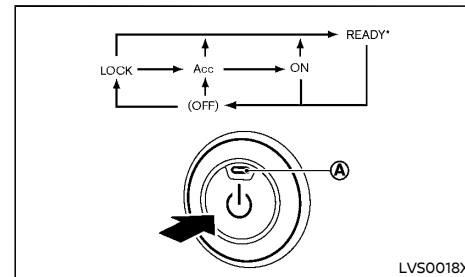

*: Push while the brake pedal is depressed.

When the power switch is pushed without depressing the brake pedal, the power switch position will change as follows.

- Push once to change to ACC.
- Push two times to change to ON.
- Push three times to change to OFF.
- Push four times to return to ACC.
- Open or close any door to return to LOCK while in the OFF position.

The indicator light ① on the power switch illuminates when the power switch is in the ACC or ON position.

The power lock is designed so that the power switch position cannot be switched to LOCK until the vehicle is into the P (Park) position.

When the power switch cannot be switched to the LOCK position, proceed as follows.

1. Push the P position switch on the shift lever to place the vehicle in the P (Park) position.
2. Push the power switch to the OFF position. The power switch position indicator ① will not illuminate.

3. Open the door. The power switch will change to the LOCK position.

POWER SWITCH POSITIONS

LOCK (Normal parking position)

The power switch can only be locked in this position.

The power switch will be unlocked when it is pushed to the ACC position while the driver is carrying the Intelligent Key.

ACC (Accessories)

This position activates electrical accessories, such as the radio, when the EV (Electric Vehicle) system is OFF.

ON

This position turns on the EV system and electrical accessories.

READY (Normal operating position)

This position (READY to drive) turns on the EV system, electrical accessories and the vehicle can be driven.

OFF

The EV system can be turned off without locking the steering wheel.

The power switch cannot be placed in the LOCK position until the vehicle is in the P (Park) position.



CAUTION:

Do not leave the vehicle with the power switch in the ACC position for an extended period of time. This can discharge the 12-volt battery.

NOTE:

If the power switch is pushed quickly or is pushed twice quickly, the switch may not function even if a chime sound is heard. Push the switch again more slowly.

EMERGENCY EV (Electric Vehicle) SYSTEM SHUT OFF

To shut off the EV (Electric Vehicle) system in an emergency situation while driving, perform the following procedure.

- Rapidly push the power switch 3 consecutive times in less than 1.5 seconds, or
- Push and hold the power switch for more than 2 seconds.

INTELLIGENT KEY BATTERY DISCHARGE

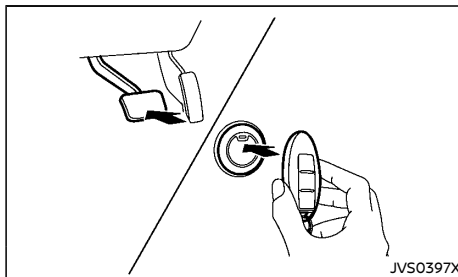

If the Intelligent Key battery is discharged, or environmental conditions interfere with the Intelligent Key operation, start the EV (Electric Vehicle) system in the READY to drive mode according to the following procedure:

1. Push the P position switch on the shift lever.
2. Firmly apply the foot brake.

3. Touch the power switch with the Intelligent Key as illustrated. (A chime will sound.)
4. Push the power switch while depressing the brake pedal within 10 seconds after the chime sounds. The power switch position changes to READY to drive.

After step 3 is performed, if the power switch is pushed without depressing the brake pedal, the power switch position will change to ACC.

NOTE:

- **When the power switch is pushed to the ACC or ON position or READY to drive position by the above procedure, the Intelligent Key battery discharge indicator appears on the vehicle information display even if the Intelligent Key is inside the vehicle. This is not a malfunction. To stop the warning indicator from blinking, touch the power switch with the Intelligent Key again.**
- **If the Intelligent Key battery discharge indicator appears on the vehicle information display, replace the battery as soon as possible. See "Intelligent Key battery replacement" (P.8-12).**

STARTING THE EV (Electric Vehicle) SYSTEM

1. Confirm the parking brake is applied.
2. Confirm that the vehicle is in the P (Park) position.

The EV (Electric Vehicle) is designed not to operate unless the shift position is in the P (Park) or N (Neutral) positions.

The Intelligent Key must be carried with you when operating the power switch.

3. Firmly depress the brake pedal and push the power switch to place the EV system in the READY to drive position.

To place the vehicle in the READY to drive position immediately, push and release the power switch while depressing the brake pedal with the power switch in any position. The READY to drive indicator light  in the meter illuminates.

4. To stop the EV system, push the P position switch on the shift lever, and push the power switch to the OFF position.

DRIVING VEHICLE

ELECTRIC SHIFT CONTROL SYSTEM

This vehicle is electronically controlled to produce maximum available power and smooth operation.

The recommended operating procedures for this vehicle are shown on the following pages.

Starting vehicle

1. After placing the vehicle in the READY to drive position, fully depress the foot brake pedal before moving the shift lever to the D (Drive) position.

The shift lever of this vehicle is designed so that the foot brake pedal must be depressed before shifting from the P (Park) position to any driving position while the power switch is in the ON position.

The shift position cannot be moved out of the P (Park) position and into any of the other positions if the power switch is placed in the LOCK, OFF or ACC position.

2. Keep the foot brake pedal depressed, and move the shift lever to the D (Drive) position.
3. Release the parking brake and foot brake pedal, and then gradually start the vehicle in motion.



WARNING:

- **Do not depress the accelerator pedal while shifting from P (Park) or N (Neutral) to R (Reverse) or D (Drive) position. Always depress the brake pedal until shifting is completed. Failure to do so could cause you to lose control, which could result in an accident.**

- **Never shift to either the "P" (Park) or "R" (Reverse) position while the vehicle is moving forward and "P" (Park), "D" (Drive) position while the vehicle reversing. This could cause an accident or damage the transmission.**



CAUTION:

- **When stopping the vehicle on an uphill slope, do not hold the vehicle by depressing the accelerator pedal. The foot brake should be used for this purpose.**
- **Do not hang items on the shift lever. This may cause an accident due to a sudden start.**
- **Do not shift to the B position abruptly on slippery roads. This may cause a loss of control.**

Shifting

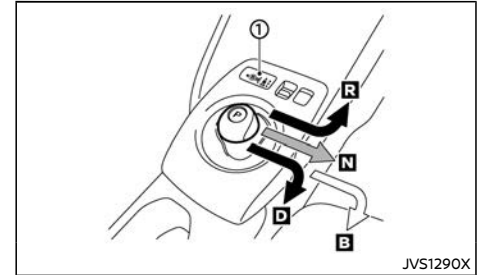

To move the shift lever,

- ➡: Slide along the gate while the brake pedal is depressed.
- 👉: After sliding, maintain it in the same position until the vehicle is placed in the N (Neutral) position.
- ➡: When in the D (Drive) position, slide along the gate.

NOTE:

- **Confirm that the vehicle is in the desired shift position by checking the shift indicator ① located near the shift lever or on the vehicle information display.**
- **To place the vehicle into the D (Drive) position from the B position, move the shift lever into the D (Drive) position.**

After placing the power switch in the READY to drive position, fully depress the brake pedal, and move the shift lever to any of the preferred shift positions.

If the power switch is placed in the OFF or ACC position for any reason while the shift position is in any position other than the P (Park) position, the power switch cannot be placed in the LOCK position.

If the power switch cannot be placed in the LOCK position, perform the following steps.

1. Apply the parking brake when the vehicle is stopped.
2. Place the power switch in the ON position while depressing the foot brake pedal.
3. Push the P position switch and place the vehicle in the P (Park) position.
4. Place the power switch in the OFF position.

NOTE:

The vehicle automatically applies the P (Park) position when the power switch is in the OFF position.



WARNING:

- **The shift lever is always in the center position when released. When the power switch is placed in the READY to drive position, the driver needs to confirm that the vehicle is in the P (Park) position. The indicator next to the "P" by the shift lever is illuminated and the "P" is displayed on the vehicle information display. If the vehicle is in the D (Drive) or R (Reverse) position when the power switch is placed in the READY to drive position, this may cause a sudden start which could result in an accident.**
- **On a hilly road, do not allow the vehicle to roll backwards while in the D (Drive) position or B position, or allow the vehicle to roll forward while in the R (Reverse) position. This may cause an accident.**



CAUTION:

- **Do not slide the shift lever while pushing the P position switch. This may also damage the electric motor.**
- **When switching to the preferred position by operating the shift lever, check that the shift lever returns to the central position by releasing your hand from the lever. Holding the shift lever in a mid-way position may also damage the shift control system.**
- **Do not operate the shift lever while the accelerator pedal is depressed, except when switching to the B position. This**

may cause a sudden start which could result in an accident.

- **The following operations are not allowed because excessive force would be applied to the traction motor and this may result in damage to the vehicle:**
 - Moving the shift lever to the R (Reverse) position when driving forward
 - Moving the shift lever to the D (Drive) or B position when reversing

If these operations are attempted, a chime sounds and the vehicle shifts to the N (Neutral) position.

P (Park):

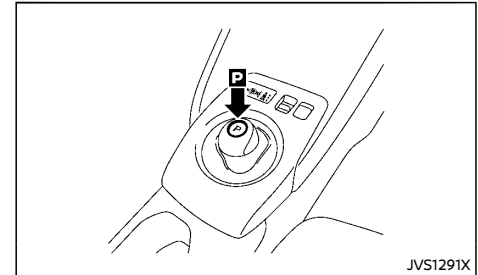

Use this position when the vehicle is parked or when placing the vehicle in the READY to drive position. Make sure that the vehicle is completely stopped. **In order to switch to the P (Park) position, push the P position switch as shown in the illustration once the vehicle has come to a complete stop. If the P position switch is pushed while the vehicle is in motion, a chime sounds and the current shift position is maintained.** After switching to the P (Park) position, apply the parking brake. When parking

on a hill, apply the parking brake first while keeping the foot brake pedal depressed then push the P position switch and place the vehicle in the P (Park) position. See "Parking brake" (P.3-19).

NOTE:

- **While the vehicle is stationary, if the shift position is placed in any position other than the P (Park) position when the power switch is set to OFF, it will automatically switch to the P (Park) position.**
- **If the P position switch is pushed while sliding the shift lever, the shift position will not switch to the P (Park) position. When pushing the P position switch, be sure to first allow the shift lever to return to its center position.**

R (Reverse):

Use this position to back up. Make sure that the vehicle is completely stopped before selecting the R (Reverse) position. **If the vehicle is placed in the D (Drive) position while reversing, the chime will sound and the vehicle will switch into the N (Neutral) position.**

N (Neutral):

Neither forward nor reverse gear is engaged. The vehicle can be placed in READY to drive position in this position.

Do not shift to the N (Neutral) position while driving. The regenerative brake system does not operate in the N (Neutral) position. However, the vehicle brakes will still stop the vehicle.

D (Drive):

Use this position for all normal forward driving. **If the vehicle is placed in the D (Drive) position while reversing, the chime will sound and the vehicle will switch into the N (Neutral) position.**

B:

Use the B position for downhill driving. When the B position is used, more regenerative brake is applied when the accelerator pedal is released in comparison to the D (Drive) position. Less deceleration is provided by the regenerative brake system when the Li-ion battery is fully charged or the battery temperature is low.

e-Pedal SYSTEM



WARNING:

Never rely solely on the e-Pedal system, as there is a performance limit to the system function. Always drive carefully and attentively. The brake pedal should be operated to slow or stop the vehicle, depending on traffic or road conditions.

The e-Pedal system enables the driver to slow or stop the vehicle, or to keep the vehicle stopped, by operating only the accelerator pedal. This helps assist the driver to save the steps of changing his/her foot on between the accelerator pedal and the brake pedal.

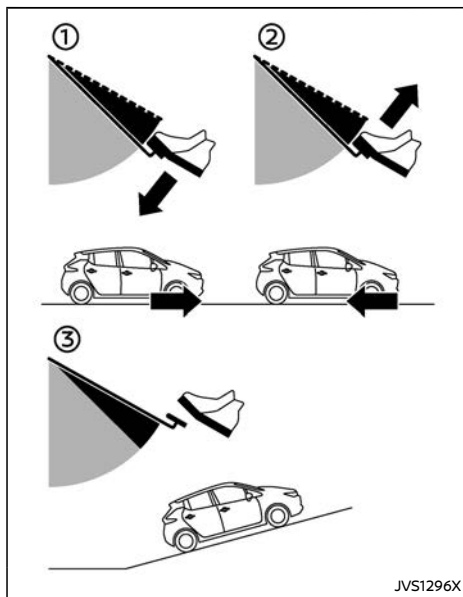

- ① Acceleration
- ② Deceleration (instead of brake pedal)
- ③ Making a stop (instead of brake pedal)

e-Pedal SYSTEM OPERATION

When the e-Pedal system is activated, the regenerative brake is enhanced and the driver can adjust the vehicle speed by only depressing or returning the accelerator pedal. When you release (take your foot off) the accelerator pedal, the vehicle slows down and comes to a stop smoothly without depressing the brake pedal. After a stop, the vehicle is held stationary automatically.

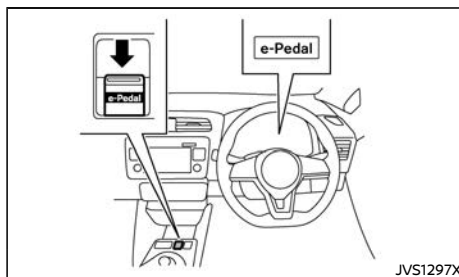

The e-Pedal system will be turned ON or OFF each time the e-Pedal switch is pulled. (The e-Pedal indicator in the vehicle information display shows the status of the e-Pedal system.)

When the e-Pedal system is activated, the characteristics of the accelerator pedal change significantly and the accelerator pedal operates differently than a conventional one operates. Be sure to confirm the status of the e-Pedal system (ON or OFF) in the vehicle information display before driving.

System Activation

To activate the e-Pedal system, place the power switch in the READY to drive or ON position and pull the e-Pedal switch located on the center console.

System deactivation

To deactivate the e-Pedal system, with the power switch in the READY to drive or ON position, depress the brake pedal and pull the e-Pedal switch.

To turn the e-Pedal system OFF while the vehicle is kept stopped by the e-Pedal system, depress the brake pedal and then pull the e-Pedal switch.

If the brake pedal is not depressed when the e-Pedal switch is operated, a reminder message will be shown in the vehicle information display.

NOTE:

- **When the e-Pedal system is switched to ON or OFF, the degree of vehicle deceleration will change.**
- **The e-Pedal system is automatically turned OFF when the EV system is restarted.**
- **To keep the e-Pedal system activated even if the EV system is restarted, turn the "Mode Memory" ON in the "Settings" menu of the vehicle information display. (See "Settings" (P.2-15).)**
- **The "Mode Memory" setting is not reset by using the "Factory Reset" setting.**

e-Pedal driving features

The e-Pedal system provides the following driving features:

When driving and stopping the vehicle:

- Depressing or returning the accelerator pedal will change the degree of acceleration and deceleration accordingly.
- Returning the accelerator pedal generates more deceleration than normal. (The maximum deceleration changes according to the vehicle speed.)
- Releasing (taking your foot off) the accelerator pedal reduces the vehicle speed until the vehicle comes to a stop.
- The vehicle's stop lights illuminate when the deceleration level reaches an ordinary braking operation.

If the deceleration is not sufficient when the accelerator pedal is returned or released, depress the brake pedal. The brake pedal can be operated to reduce the vehicle speed in the same way as normal even when the e-Pedal system is activated.

When restarting the vehicle:

- After the vehicle has come to a stop by the e-Pedal system function, the vehicle is kept stopped as long as releasing (taking your foot off) the accelerator pedal.
- The vehicle's stop lights remain illuminated while the vehicle is kept stopped by the e-Pedal system.
- Depress the accelerator pedal to start the vehicle again from a stop.

When the vehicle needs to be stopped for a certain period of time, place the vehicle in the P (Park) position and apply the parking brake.



CAUTION:

When the e-Pedal system is turned OFF, remember to depress the brake pedal firmly to prevent the vehicle from moving with the shift position in other than P (Park).

When backing up the vehicle:

With the shift position in the R (Reverse), operating the accelerator pedal can adjust the vehicle speed (acceleration, deceleration and a stop) in the same way as in the D (Drive) position.

Other driving tips for the e-Pedal system:

- For smooth deceleration when the e-Pedal system is activated, it is recommended to adjust the accelerator pedal while driving with your foot on it (depressing or returning, but not releasing).
- Shifting the shift position from D (Drive) to B or from B to D will not affect the e-Pedal system feature.
- The e-Pedal system will not function under the following conditions:
 - When the vehicle is placed in the P (Park) position.
 - When the cruise control system is operated.

e-Pedal SYSTEM LIMITATIONS



WARNING:

Listed below are the system limitations for the e-Pedal system. Failure to operate the vehicle in accordance with these system limitations could result in serious injury or death.

- If "Press brake pedal to prevent rolling" warning message appears in the vehicle information display, depress the brake pedal. The vehicle may start moving.
- If the deceleration force provided by the e-Pedal system is not sufficient, depress the brake pedal.
- If the vehicle starts to move while it is stopped by the e-Pedal system, depress the brake pedal immediately.
- Under the following conditions, place the vehicle in the P (Park) position and make sure the parking brake is securely applied. The vehicle may start moving suddenly.
 - When getting in and out of the vehicle.
 - When loading and unloading the vehicle.
 - When stopping the vehicle for a long period of time.
- Under the following conditions the e-Pedal system may not decelerate or may not stop the vehicle sufficiently. Depress the brake pedal whenever necessary.
 - When excessively heavy baggage is loaded in the vehicle.
 - When driving on steep downhill roads.
 - When driving on icy roads.
- On a slope, the e-Pedal system may not stop the vehicle completely or may not keep the vehicle stopped. Depress the brake pedal whenever necessary.

ELECTRONIC STABILITY PROGRAM (ESP) SYSTEM



CAUTION:





- Turn the e-Pedal system OFF and place the vehicle in the N (Neutral) position under the following conditions:
 - When the vehicle enters an automatic car wash.
 - When the vehicle is towed.
- Be careful not to operate the e-Pedal switch mistakenly or unintentionally.

e-Pedal SYSTEM MALFUNCTION

If the e-Pedal system malfunctions, "e-Pedal system failure! Press brake pedal to slow or stop" warning message appears on the vehicle information display. When the warning message appears, the e-Pedal system will be turned off automatically. Have the system checked as soon as possible by a NISSAN certified LEAF dealer.



WARNING:

- The Electronic Stability Program (ESP) system is designed to help the driver maintain driving stability but does not prevent accidents due to abrupt steering operation at high speeds or by careless or dangerous driving techniques. Reduce vehicle speed and be especially careful when driving and cornering on slippery surfaces and always drive carefully.
- Do not modify the vehicle's suspension. If suspension parts such as shock absorbers, struts, springs, stabilizer bars, bushings and wheels are not NISSAN recommended parts for your vehicle or are extremely deteriorated the ESP system may not operate properly. This could adversely affect vehicle handling performance, and the ESP warning light  may illuminate.
- If brake related parts such as brake pads, rotors and calipers are not NISSAN recommended or are extremely deteriorated, the ESP system may not operate properly and the ESP warning light  may illuminate.
- If traction motor control related parts are not NISSAN recommended or are extremely deteriorated, the ESP warning light  may illuminate.
- When driving on extremely inclined surfaces such as higher banked corners, the ESP system may not operate properly and the ESP warning light  may illuminate. Do not drive on these types of roads.
- When driving on an unstable surface such as a turntable, ferry, elevator or ramp, the

ESP warning light  may illuminate. This is not a malfunction. Restart the EV (Electric Vehicle) system after driving onto a stable surface.

- The ESP system was designed by NISSAN to work with wheels or tires recommended by NISSAN. Accordingly, to ensure proper operation of the ESP system, NISSAN recommends the use of wheels or tires that are recommended by NISSAN.
- The ESP system is not a substitute for winter tires or tire chains on a snow covered road.

The Electronic Stability Program (ESP) system uses various sensors to monitor driver inputs and vehicle motion. Under certain driving conditions, the ESP system helps to perform the following functions.

- Controls brake pressure to reduce wheel slip on one slipping drive wheel so power is transferred to a drive wheel on the same axle that is not slipping.
- Controls brake pressure and traction motor output to reduce drive wheel slip based on vehicle speed (traction control function).
- Controls brake pressure at individual wheels and traction motor output to help the driver maintain control of the vehicle in the following conditions.
 - understeer (vehicle tends to not follow the steered path despite increased steering input)
 - oversteer (vehicle tends to spin due to certain road or driving conditions).

The ESP system can help the driver to maintain control of the vehicle, but it cannot prevent loss of vehicle control in all driving situations.



When the ESP system operates, the ESP warning light  flashes. When the warning light

flashes, note the following items.

- The road may be slippery or the system may determine some action is required to help keep the vehicle on the steered path.
- You may feel a pulsation in the brake pedal and hear a noise or vibration from under the hood. This is normal and indicates that the ESP system is working properly.
- Adjust your speed and driving according to the road conditions.

See "Electronic Stability Program (ESP) warning light" (P.2-11) and "Electronic Stability Program (ESP) off indicator light" (P.2-12).

If a malfunction occurs in the system, the ESP warning light  illuminates. The ESP system automatically turns off when this warning light is illuminated.

The vehicle information display is used to turn off the ESP system. The ESP off indicator light  illuminates to indicate that the ESP system is off. When the ESP system is turned off, the ESP system still operates to prevent one drive wheel from slipping by transferring power to a drive wheel that is not slipping. The ESP warning light  flashes if this occurs. All other ESP functions are off and the ESP warning light  will not flash. The ESP system is automatically reset to ON when the power switch is placed in the OFF position then back in the ON position.





The computer has a built-in diagnostic feature that tests the system each time you start the EV (Electric Vehicle) system and move the vehicle forward or in reverse at a slow speed. When the self-test occurs, you may hear a "clunk" noise and/or feel a pulsation in the brake pedal. This is normal and is not an indication of a malfunction.

HOW TO TURN OFF THE ESP SYSTEM

The vehicle should be driven with the Electronic Stability Program (ESP) system on for most driving conditions.

When the vehicle is stuck in mud or snow, the ESP system reduces the traction motor output to reduce wheel spin. The vehicle speed will be reduced even if the accelerator is depressed to the floor. If maximum traction motor power is needed to free a stuck vehicle, turn the ESP system off.

To turn off the ESP system, perform the following steps in the vehicle information display.

1. Use the   button on the steering wheel until "Settings" is displayed.
2. Use the  button to select "ESP Setting" and then push the OK button.
3. Select " System" and push the OK button. The  indicator light will illuminate.

Turn "ESP Setting" back on in the vehicle information display or restart the EV system to turn on the ESP system.

CHASSIS CONTROL

The chassis control is an electric control module that includes the following functions:

- Intelligent Trace Control
- Intelligent Ride Control

INTELLIGENT TRACE CONTROL



WARNING:

The Intelligent Trace Control may not be effective depending on the driving condition. Always drive carefully and attentively.

The Intelligent Trace Control senses driving based on the driver's steering and acceleration/braking patterns, and controls brake pressure at individual wheels to aid tracing at corners and help smooth vehicle response.

The Intelligent Trace Control can be set to ON (enabled) or OFF (disabled) using the "Driver Assistance" settings in the vehicle information display. (See "Settings" (P.2-15).)

When the Electronic Stability Program (ESP) system is turned off, the Intelligent Trace Control is also turned off.

HILL START ASSIST SYSTEM

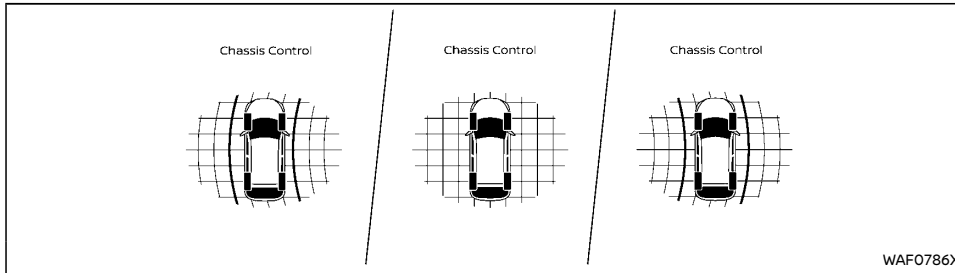

When the Intelligent Trace Control is operated and the "Chassis Control" is selected in the vehicle information display, the Intelligent Trace Control graphics are shown in the vehicle information display. (See "Trip computer" (P.2-26).)

If the chassis control warning message appears in the vehicle information display, it may indicate that the Intelligent Trace Control is not functioning properly. Have the system checked as soon as possible. It is recommended that you visit a NISSAN certified LEAF dealer for this service. (See "Vehicle information display warnings and indicators" (P.2-21).)

When the Intelligent Trace Control is operating, you may feel a pulsation in the brake pedal and hear a noise. This is normal and indicates that the Intelligent Trace Control is operating properly. You may also feel deceleration when the Intelligent Trace Control is operating. However, this is not a malfunction.

Even if the Intelligent Trace Control is set to OFF, some functions will remain on to assist the driver (for example, avoidance scenes).

INTELLIGENT RIDE CONTROL

The Intelligent Ride Control senses upper body motion (based on wheel speed information) and controls motor torque. This will enhance ride comfort in an effort to restrain uncomfortable upper body movement when passing over undulated road surfaces.

When the Electronic Stability Program (ESP) system is turned off, the Intelligent Ride Control is also turned off.

If the chassis control warning message appears in the vehicle information display, it may indicate that the Intelligent Ride Control is not functioning properly. Have the system checked as soon as possible. It is recommended that you visit a NISSAN certified LEAF dealer for this service. (See "Vehicle information display warnings and indicators" (P.2-21).)

When the Intelligent Ride Control is operating, you may hear noise and sense slight deceleration. This is normal and indicates that the Intelligent Ride Control is operating properly.



WARNING:

- **Never rely solely on the hill start assist system to prevent the vehicle from moving backward on a hill. Always drive carefully and attentively. Depress the brake pedal when the vehicle is stopped on a steep hill. Be especially careful when stopped on a hill on frozen or muddy roads. Failure to prevent the vehicle from rolling backwards may result in a loss of control of the vehicle and possible serious injury or death.**
- **The hill start assist system is not designed to hold the vehicle at a standstill on a hill. Depress the brake pedal when the vehicle is stopped on a steep hill. Failure to do so may cause the vehicle to roll backwards and may result in a collision or serious personal injury.**
- **The hill start assist system may not prevent the vehicle from rolling backwards on a hill under all load or road conditions. Always be prepared to depress the brake pedal to prevent the vehicle from rolling backwards. Failure to do so may result in a collision or serious personal injury.**

The hill start assist system automatically keeps the brakes applied to help prevent the vehicle from rolling backwards in the time it takes the driver to release the brake pedal and apply the accelerator when the vehicle is stopped on a hill.

The hill start assist system will operate automatically under the following conditions:

- The shift lever is shifted into D (Drive), B or R (Reverse) position.

CRUISE CONTROL

- The vehicle is stopped completely on a hill by applying the brake.

The maximum holding time is 2 seconds. After 2 seconds the vehicle will begin to roll back and the hill start assist system will stop operating completely.

Hill start assist system will not operate when the shift lever is shifted into P (Park) or N (Neutral) position or on a flat and level road.

When the Electronic Stability Program (ESP) warning light illuminates, the hill start assist system will not operate. (See "Electronic Stability Program (ESP) warning light" (P.2-11).)



WARNING:

- **Always observe the posted speed limits and do not set the speed over them.**
- **Do not use the cruise control when driving under the following conditions. Doing so could cause a loss of vehicle control and result in an accident.**
 - **When it is not possible to keep the vehicle at a constant speed**
 - **When driving in heavy traffic**
 - **When driving in traffic that varies speed**
 - **When driving in windy areas**
 - **When driving on winding or hilly roads**
 - **When driving on slippery (rain, snow, ice, etc.) roads**

PRECAUTIONS ON CRUISE CONTROL

- The cruise control system will be automatically cancelled when there is a malfunction. Have the system checked by a NISSAN certified LEAF dealer.
- Even if the ECO mode is turned on, the driving range cannot be extended while operating the cruise control.
- If the motor coolant temperature becomes excessively high, the cruise control system will be cancelled automatically.
- To properly set the cruise control system, use the following procedures.

Cruise control operations

The cruise control allows driving at speeds above 40 km/h (25 MPH) without keeping your foot on the accelerator pedal.

The cruise control will automatically be canceled if the vehicle slows down more than approximately 13 km/h (8 MPH) below the set speed.

Moving the shift lever to the N (Neutral) position will cancel the cruise control and the cruise control indicator will turn off.

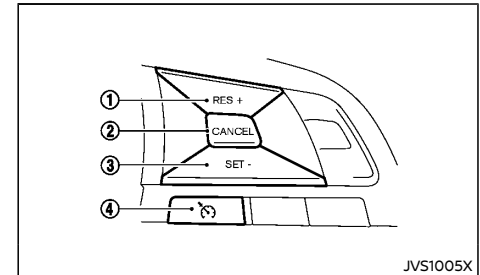

- ① RES/+ switch
- ② CANCEL switch
- ③ SET/- switch
- ④ Cruise control MAIN switch

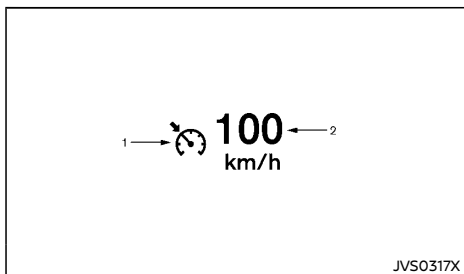

The cruise control operating condition is shown on the vehicle information display.

- 1 Cruise control indicator
- 2 Set speed indicator

The cruise control indicator indicates the status of the cruise control system by the color.

Turning on cruise control

Push the cruise control MAIN switch ④. The cruise control indicator (white) appears together with the last set speed value (or ---) on the vehicle information display.

Setting cruising speed

1. Accelerate to the desired speed.
2. Push the SET/- switch ③ and release it.
3. The cruise control indicator (green) appears together with the set speed value (desired cruising speed) on the vehicle information display.
4. Take your foot off the accelerator pedal.

The vehicle will maintain the set speed.

The speed unit can be converted between "km/h" and "MPH". (See "Settings" (P.2-15).)

Passing another vehicle:

Depress the accelerator pedal to accelerate. After releasing the accelerator pedal, the vehicle will return to the previously set speed.

The vehicle may not maintain the set speed when going up or down steep hills. In such cases, drive without the cruise control.

Resetting to slower speed:

Use any one of the following methods to reset to a slower speed.

- Lightly tap the foot brake pedal. When the vehicle reaches the desired speed, push and release the SET/- switch ③.
- Push and hold the SET/- switch ③. When the vehicle reaches the desired speed, release the SET/- switch ③.
- Quickly push and release the SET/- switch ③. This will reduce the vehicle speed by about 1 km/h or 1 MPH.

Resetting to faster speed:

Use any one of the following methods to reset to a faster speed.

- Depress the accelerator pedal. When the vehicle reaches the desired speed, push and release the SET/- switch ③.
- Push and hold the RES/+ switch ①. When the vehicle reaches the desired speed, release the RES/+ switch ①.
- Quickly push and release the RES/+ switch ①. This will increase the vehicle speed by about 1 km/h or 1 MPH.

Resuming at preset speed:

Push and release the RES/+ switch ①.

The vehicle will resume the last set cruising speed when the vehicle speed is over 40 km/h (25 MPH).

Canceling cruising speed

Use any one of the following methods to cancel the set speed.

- Push the CANCEL switch ②. The cruise control indicator will change to white.
- Tap the foot brake pedal. The cruise control indicator will change to white.
- Push the cruise control MAIN switch ④. The cruise control indicator and the set speed indicator will turn off.

LANE DEPARTURE WARNING (LDW) SYSTEM (if equipped)

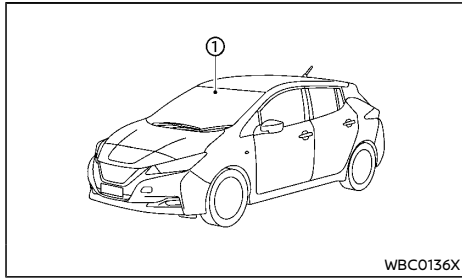

WARNING:

Failure to follow the warnings and instructions for proper use of the LDW system could result in serious injury or death.

This system is only a warning device to inform the driver of a potential unintended lane departure. It will not steer the vehicle or prevent loss of control. It is the driver's responsibility to stay alert, drive safely, keep the vehicle in the traveling lane, and be in control of the vehicle at all times.

The LDW system will operate when the vehicle is driven at speeds of approximately 60 km/h (37 MPH) and above, and only when the lane markings are clearly visible on the road.

The LDW system monitors the lane markers on the traveling lane using the multi-sensing front camera unit ① located above the inside rear-view mirror.

The LDW system warns the driver that the vehicle is beginning to leave the driving lane with an indicator and a steering wheel vibration. For additional information, refer to "LDW system operation" (P.5-16).

LDW SYSTEM OPERATION

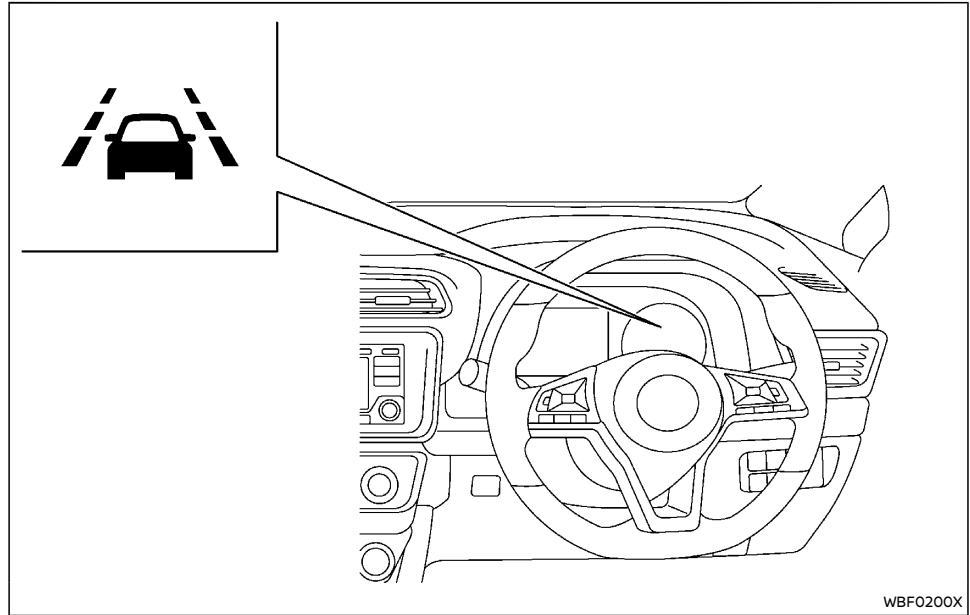

The LDW system provides a lane departure warning function when the vehicle is driven at speeds of approximately 60 km/h (37 MPH) and above and the lane markings are clear.

When the vehicle approaches either the left or the right side of the traveling lane, the steering wheel will vibrate and the LDW indicator on the vehicle information display will blink to alert the driver.

The warning function will stop when the vehicle

returns inside of the lane markers.

HOW TO ENABLE/DISABLE THE LDW SYSTEM

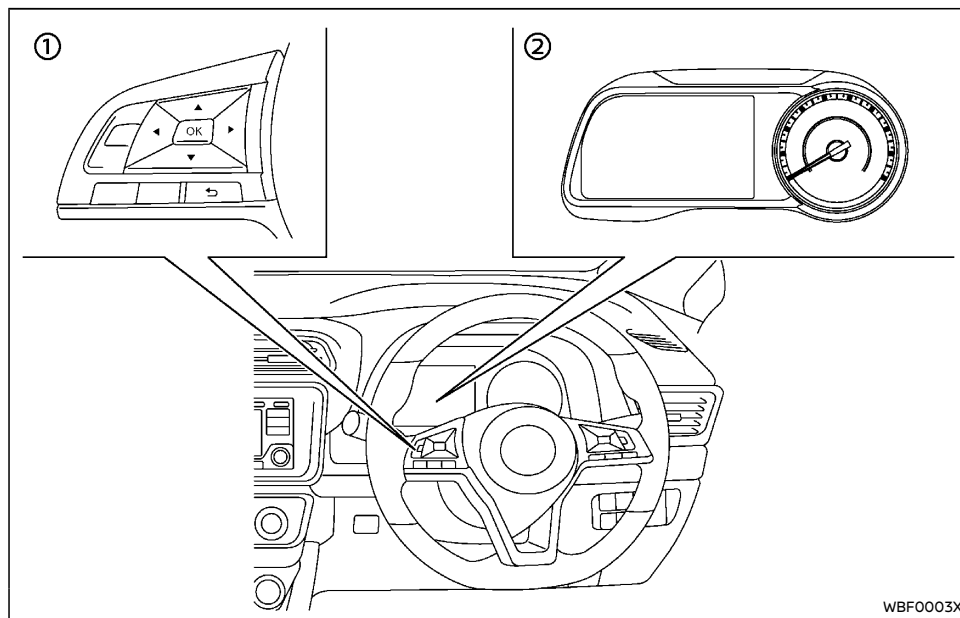

① Steering-wheel-mounted controls (left side)

② Vehicle information display

Perform the following steps to enable or disable the LDW system.

1. Push the ◀ ▶ button until "Settings" appears in the vehicle information display. Then push the OK button.

2. Use the ⬆ button to select "Driver Assistance". Then push the OK button.

3. Select "Lane" and push the OK button.

4. Select "Lane Departure Warning" and push the OK button.

NOTE:

When enabling/disabling the system, the system will retain current settings even if the EV system is restarted.

LDW SYSTEM LIMITATIONS



WARNING:

Listed below are the system limitations for the LDW system. Failure to follow the warnings and instructions for proper use of the LDW system could result in serious injury or death.

- The system will not operate at speeds below approximately 60 km/h (37 MPH) or if it cannot detect lane markers.
- Do not use the LDW system under the following conditions as it may not function properly:
 - During bad weather (rain, fog, snow, etc.).
 - When driving on slippery roads, such as on ice or snow.
 - When driving on winding or uneven roads.
 - When there is a lane closure due to road repairs.
 - When driving in a makeshift or temporary lane.
 - When driving on roads where the lane width is too narrow.
 - When driving without normal tire conditions (for example, tire wear, low tire pressure, installation of tire chains, non-standard wheels).

- When the vehicle is equipped with non-original brake parts or suspension parts.
- The system may not function properly under the following conditions:
 - On roads where there are multiple parallel lane markers; lane markers that are faded or not painted clearly; yellow painted lane markers; non-standard lane markers; or lane markers covered with water, dirt, snow, etc.
 - On roads where the discontinued lane markers are still detectable.
 - On roads where there are sharp curves.
 - On roads where there are sharply contrasting objects, such as shadows, snow, water, wheel ruts, seams or lines remaining after road repairs. (The LDW system could detect these items as lane markers.)
 - On roads where the traveling lane merges or separates.
 - When the vehicle's traveling direction does not align with the lane marker.
 - When traveling close to the vehicle in front of you, which obstructs the multi-sensing front camera unit detection range.
 - When rain, snow, dirt or object adheres to the windshield in front of the multi-sensing front camera unit.
 - When the headlights are not bright due to dirt on the lens or if the aiming is not adjusted properly.

- When strong light enters the multi-sensing front camera unit. (For example, the light directly shines on the front of the vehicle at sunrise or sunset.)
- When a sudden change in brightness occurs. (For example, when the vehicle enters or exits a tunnel or under a bridge.)

SYSTEM TEMPORARILY UNAVAILABLE

If the vehicle is parked in direct sunlight under high temperature conditions (over approximately 40°C (104°F)) and then started, the LDW system may be deactivated automatically and the message "Unavailable High Cabin Temperature" will appear in the vehicle information display.

When the interior temperature is reduced, the LDW system will resume operating automatically.

The LDW system is not designed to warn under the following conditions:

- When you operate the lane change signal and change traveling lanes in the direction of the signal. (The LDW system will become operable again approximately 2 seconds after the lane change signal is turned off.)
- When the vehicle speed lowers to less than approximately 60 km/h (37 MPH).

After the above conditions have finished and the necessary operating conditions are satisfied, the LDW system will resume.

SYSTEM MALFUNCTION

If the LDW system malfunctions, it will cancel automatically and "System fault See Owner's Manual" warning message will appear in the vehicle information display. If the warning message appears, pull off the road to a safe location and stop the vehicle. Place the power switch in the "OFF" position and restart the EV system. If the warning message continues to appear, have the system checked by a NISSAN certified LEAF dealer.

SYSTEM MAINTENANCE

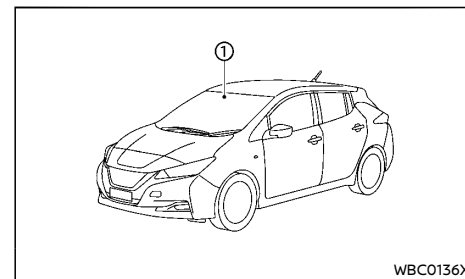

The multi-sensing front camera unit ① the LDW system is located above the inside rearview mirror.

To keep the proper operation of the LDW system and prevent a system malfunction, be sure to observe the following:

- Always keep the windshield clean.
- Do not attach a sticker (including transparent material) or install an accessory near the camera unit.
- Do not place reflective materials, such as white paper or a mirror, on the instrument panel. The reflection of sunlight may adversely affect the camera unit's capability

INTELLIGENT LANE INTERVENTION SYSTEM (if equipped)

- of detecting the lane markers.
- Do not strike or damage the areas around the camera unit. Do not touch the camera lens or remove the screw located on the camera unit. If the camera unit is damaged due to an accident, contact a NISSAN certified LEAF dealer.

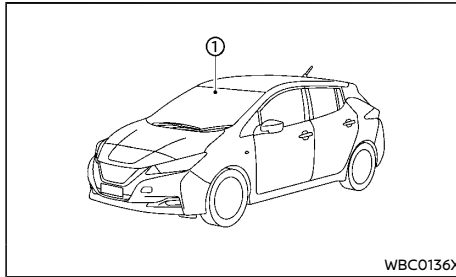

The Intelligent Lane Intervention system warns the driver when the vehicle has left the center of the traveling lane with an indicator and a steering wheel vibration. The system helps assist the driver to return the vehicle to the center of the traveling lane by applying the brakes to the left or right wheels individually (for a short period of time).

The Intelligent Lane Intervention system monitors the lane markers on the traveling lane using the multi-sensing front camera unit ① located above the inside rearview mirror.



WARNING:

Failure to follow the warnings and instructions for proper use of the [REDACTED] could result in serious injury or death.

- **The Intelligent Lane Intervention system will not steer the vehicle or prevent loss of control. It is the driver's responsibility to stay alert, drive safely, keep the vehicle in the traveling lane, and be in control of the vehicle at all times.**
- **The Intelligent Lane Intervention system is primarily intended for use on well-developed freeways or highways. It may not detect the lane markers in certain road, weather, or driving conditions.**

The Intelligent Lane Intervention system must be turned on with the Intelligent Lane Intervention switch every time the power switch is placed in the "ON" position.

The Intelligent Lane Intervention system will operate when the vehicle is driven at speeds of approximately 60 km/h (37 MPH) and above, and only when the lane markings are clearly visible on the road.

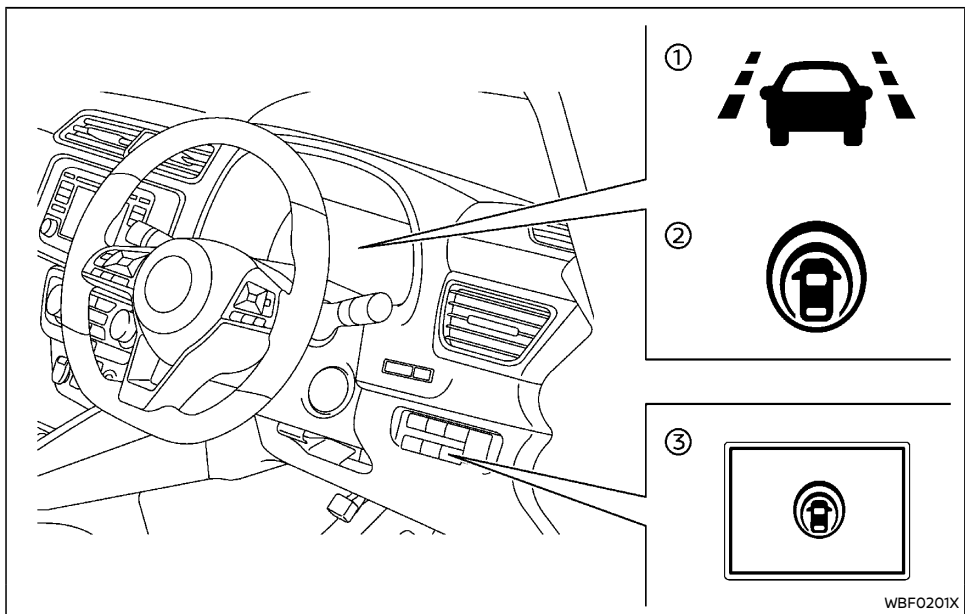

- ① Intelligent Lane Intervention indicator
- ② Intelligent Lane Intervention ON indicator
- ③ Intelligent Lane Intervention switch

INTELLIGENT LANE INTERVENTION SYSTEM OPERATION

The Intelligent Lane Intervention system operates at above approximately 60 km/h (37 MPH). When the vehicle approaches either the left or the right side of the traveling lane, the steering wheel will vibrate and the Intelligent Lane Intervention indicator (orange) on the vehicle information display will blink to alert the driver. Then, the Intelligent Lane Intervention system will automatically apply the brakes for a short period of time to help assist the driver to return

the vehicle to the center of the traveling lane.

To turn on the Intelligent Lane Intervention system, push the Intelligent Lane Intervention switch after starting the EV system. The Intelligent Lane Intervention ON indicator on the vehicle information display will illuminate. Push the Intelligent Lane Intervention switch again to turn off the Intelligent Lane Intervention system. The Intelligent Lane Intervention ON indicator will turn off.

INTELLIGENT LANE INTERVENTION SYSTEM LIMITATIONS

WARNING:

Listed below are the system limitations for the Intelligent Lane Intervention system. Failure to follow the warnings and instructions for proper use of the Intelligent Lane Intervention system could result in serious injury or death.

- The Intelligent Lane Intervention system may activate if you change lanes without first activating your turn signal or, for example, if a construction zone directs traffic to cross an existing lane marker. If this occurs you may need to apply corrective steering to complete your lane change.
- Because the Intelligent Lane Intervention system may not activate under the road, weather, and lane marker conditions described in this section, it may not activate every time your vehicle begins to leave its lane and you will need to apply corrective steering.
- When the Intelligent Lane Intervention system is operating, avoid excessive or sudden steering maneuvers. Otherwise,

- you could lose control of the vehicle.
- The Intelligent Lane Intervention system will not operate at speeds below approximately 60 km/h (37 MPH) or if it cannot detect lane markers.
 - Do not use the Intelligent Lane Intervention system under the following conditions as it may not function properly:
 - During bad weather (rain, fog, snow, etc.).
 - When driving on slippery roads, such as on ice or snow.
 - When driving on winding or uneven roads.
 - When there is a lane closure due to road repairs.
 - When driving in a makeshift or temporary lane.
 - When driving on roads where the lane width is too narrow.
 - When driving without normal tire conditions (for example, tire wear, low tire pressure, installation of tire chains, non-standard wheels).
 - When the vehicle is equipped with non-original brake parts or suspension parts.
 - On roads where there are multiple parallel lane markers; lane markers that are faded or not painted clearly; yellow painted lane markers; non-standard lane markers; or lane markers covered with water, dirt, snow, etc.
 - On roads where discontinued lane markers are still detectable.

- On roads where there are sharp curves.
- On roads where there are sharply contrasting objects, such as shadows, snow, water, wheel ruts, seams or lines remaining after road repairs. (The Intelligent Lane Intervention system could detect these items as lane markers.)
- On roads where the traveling lane merges or separates.
- When the vehicle's traveling direction does not align with the lane marker.
- When traveling close to the vehicle in front of you, which obstructs the multi-sensing front camera unit detection range.
- When rain, snow or dirt adheres to the windshield in front of the multi-sensing front camera unit.
- When the headlights are not bright due to dirt on the lens or if the aiming is not adjusted properly.
- When strong light enters the multi-sensing front camera unit. (For example, the light directly shines on the front of the vehicle at sunrise or sunset.)
- When a sudden change in brightness occurs. (For example, when the vehicle enters or exits a tunnel or under a bridge.)

While the Intelligent Lane Intervention system is operating, you may hear a sound of brake operation. This is normal and indicates that the Intelligent Lane Intervention system is operating properly.

SYSTEM TEMPORARILY UNAVAILABLE

Condition A

The warning and assist functions of the Intelligent Lane Intervention system are not designed to work under the following conditions:

- When you operate the lane change signal and change the traveling lanes in the direction of the signal. (The Intelligent Lane Intervention system will be deactivated for approximately 2 seconds after the lane change signal is turned off.)
- When the vehicle speed lowers to less than approximately 60 km/h (37 MPH).

After the above conditions have finished and the necessary operating conditions are satisfied, the warning and assist functions will resume.

Condition B

The assist function of the Intelligent Lane Intervention system is not designed to work under the following conditions (warning is still functional):

- When the brake pedal is depressed.
- When the steering wheel is turned as far as necessary for the vehicle to change lanes.
- When the vehicle is accelerated during the Intelligent Lane Intervention system operation.
- When the hazard warning flashers are operated.
- When driving on a curve at high speed.

After the above conditions have finished and the necessary operating conditions are satisfied, the Intelligent Lane Intervention system application of the brakes will resume.

Condition C

If the following messages appear in the vehicle information display, the Intelligent Lane Intervention system will be turned off automatically.

- "Not Available Poor Road Conditions":
When the VDC system (except Traction Control System [TCS] function) or ABS operates.
- "Currently not available":
When the VDC system is turned off.

Action to take:

When the above conditions no longer exist, turn off the Intelligent Lane Intervention system. Push the Intelligent Lane Intervention switch again to turn the Intelligent Lane Intervention system back on.

Temporary disabled status at high temperature:

If the vehicle is parked in direct sunlight under high temperature conditions (over approximately 40°C (104°F)) and then the Intelligent Lane Intervention system is turned on, the Intelligent Lane Intervention system may be deactivated automatically and the following message will appear on the vehicle information display: "Unavailable High Cabin Temperature." When the interior temperature is reduced, the system will resume operating automatically.

SYSTEM MALFUNCTION

If the Intelligent Lane Intervention system malfunctions, it will cancel automatically. The Intelligent Lane Intervention indicator (orange) will illuminate and the "System fault See Owner's Manual" warning message will appear in the vehicle information display.

If the Intelligent Lane Intervention indicator (orange) illuminates, pull off the road to a safe location and stop the vehicle. Turn the EV system off and restart the EV system. If the Intelligent Lane Intervention indicator (orange) continues to illuminate, have the Intelligent Lane Intervention system checked by a NISSAN certified LEAF dealer.

SYSTEM MAINTENANCE

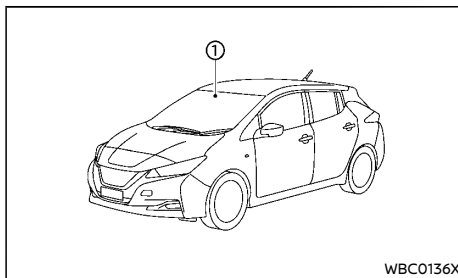

The multi-sensing front camera unit ① for the Intelligent Lane Intervention system is located above the inside rearview mirror. To keep the proper operation of the Intelligent Lane Intervention system and prevent a system malfunction, be sure to observe the following:

- Always keep the windshield clean.
- Do not attach a sticker (including transparent material) or install an accessory near the camera unit.

- Do not place reflective materials, such as white paper or a mirror, on the instrument panel. The reflection of sunlight may adversely affect the camera unit's capability of detecting the lane markers.
- Do not strike or damage the areas around the camera unit. Do not touch the camera lens or remove the screw located on the camera unit. If the camera unit is damaged due to an accident, contact a NISSAN certified LEAF dealer.

INTELLIGENT DRIVER ALERTNESS (if equipped)



WARNING:

Failure to follow the warnings and instructions for proper use of the Intelligent Driver Alertness system could result in serious injury or death.

- The Intelligent Driver Alertness system is only a warning to inform the driver of a potential lack of driver attention or drowsiness. It will not steer the vehicle or prevent loss of control.
- The Intelligent Driver Alertness system does not detect and provide an alert of the driver's lack of attention or fatigue in every situation.
- It is the driver's responsibility to:
 - stay alert,
 - drive safely,
 - keep the vehicle in the traveling lane,
 - be in control of the vehicle at all times,
 - avoid driving when tired,
 - avoid distractions (texting, etc.).

The Intelligent Driver Alertness system helps alert the driver if the system detects a lack of attention or driving fatigue.

The system monitors driving style and steering behavior over a period of time, and it detects changes from the normal pattern. If the system detects that driver attention is decreasing over a period of time, the system uses audible and visual warnings to suggest that the driver take a break.

INTELLIGENT DRIVER ALERTNESS SYS- TEM OPERATION

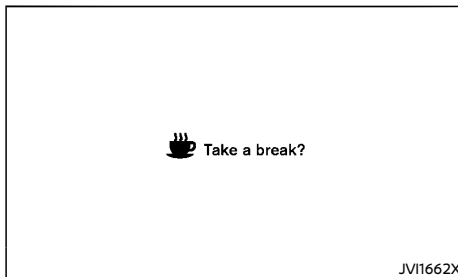

If the system detects driver fatigue or that driver attention is decreasing, the message "Take a break?" appears in the vehicle information display and a chime sounds when the vehicle is driven at speeds above 60 km/h (37 MPH).

The system continuously monitors driver attention and can provide multiple warnings per trip. The system resets and starts reassessing driving style and steering behavior when the power switch is cycled from the ON to the OFF position and back to the ON position.

HOW TO ENABLE/DISABLE THE INTELLIGENT DRIVER ALERTNESS SYSTEM

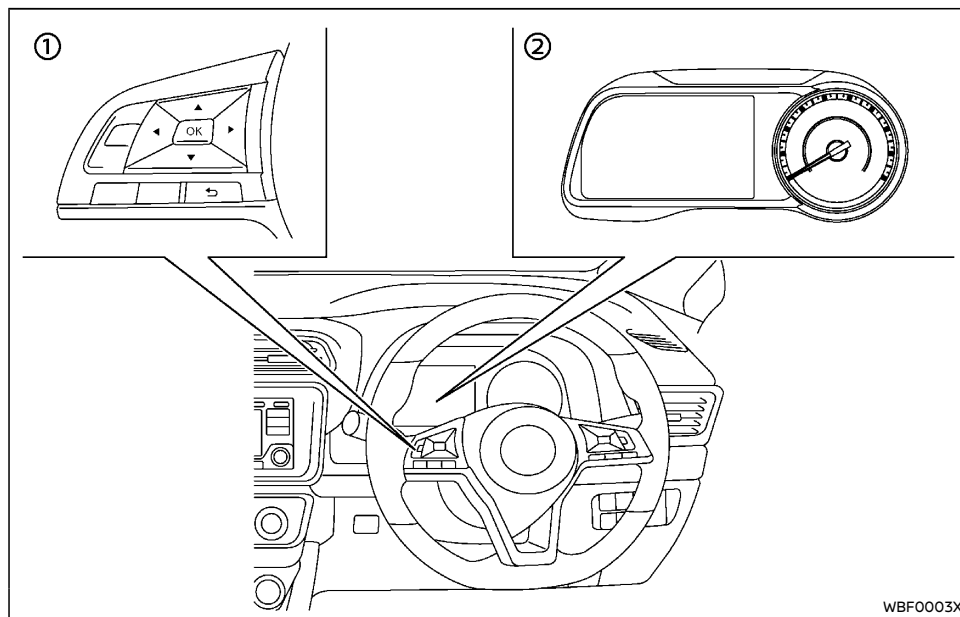

① Steering-wheel-mounted controls (left side)

② Vehicle information display

Perform the following steps to enable or disable the Intelligent Driver Alertness system.

1. Push the ◀ ▶ button until "Settings" appears in the vehicle information display.
2. Use the ⬇ button to select "Driver Assistance". Then push the OK button.

3. Select "Driver Attention Alert" and push the OK button to turn the system on or off.

NOTE:

The setting will be retained even if the EV system is restarted.

INTELLIGENT DRIVER ALERTNESS SYSTEM LIMITATIONS

⚠ WARNING:

Listed below are the system limitations for the Intelligent Driver Alertness system. Failure to operate the vehicle in accordance with these system limitations could result in serious injury or death.

- The Intelligent Driver Alertness system may not operate properly and may not provide an alert in the following conditions:
 - Poor road conditions such as an uneven road surface or pot holes.
 - Strong side wind.
 - If you have adopted a sporty driving style with higher cornering speeds or higher rates of acceleration.
 - Frequent lane changes or changes to vehicle speed.
- The Intelligent Driver Alertness system may not provide an alert in the following conditions:
 - Vehicle speeds lower than 60 km/h (37 MPH).
 - Short lapses of attention.
 - Instantaneous distractions such as dropping an object.

INTELLIGENT EMERGENCY BRAKING SYSTEM (if equipped)

SYSTEM MALFUNCTION



If the Intelligent Driver Alertness system malfunctions, the "System fault" warning message will appear in the vehicle information display and the function will be stopped automatically.

Action to take:

Stop the vehicle in a safe location, and then turn off and restart the EV system. If the warning message continues to appear, have the Intelligent Driver Alertness system checked by a NISSAN certified LEAF dealer.

WARNING:

Failure to follow the warnings and instructions for proper use of the Intelligent Emergency Braking system could result in serious injury or death.

- The Intelligent Emergency Braking system is a supplemental aid to the driver. It is not a replacement for the driver's attention to traffic conditions or responsibility to drive safely. It cannot prevent accidents due to carelessness or dangerous driving techniques.
- The Intelligent Emergency Braking system does not function in all driving, traffic, weather and road conditions.

The Intelligent Emergency Braking system can assist the driver when there is a risk of a forward collision with the vehicle ahead in the traveling lane.

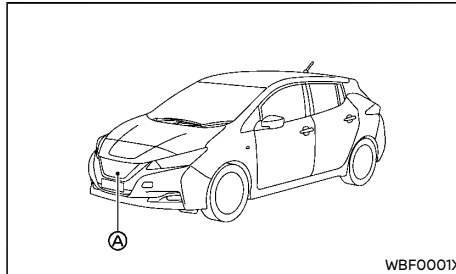

The Intelligent Emergency Braking system uses a radar sensor  located on the front of the vehicle to measure the distance to the vehicle ahead in the same lane.

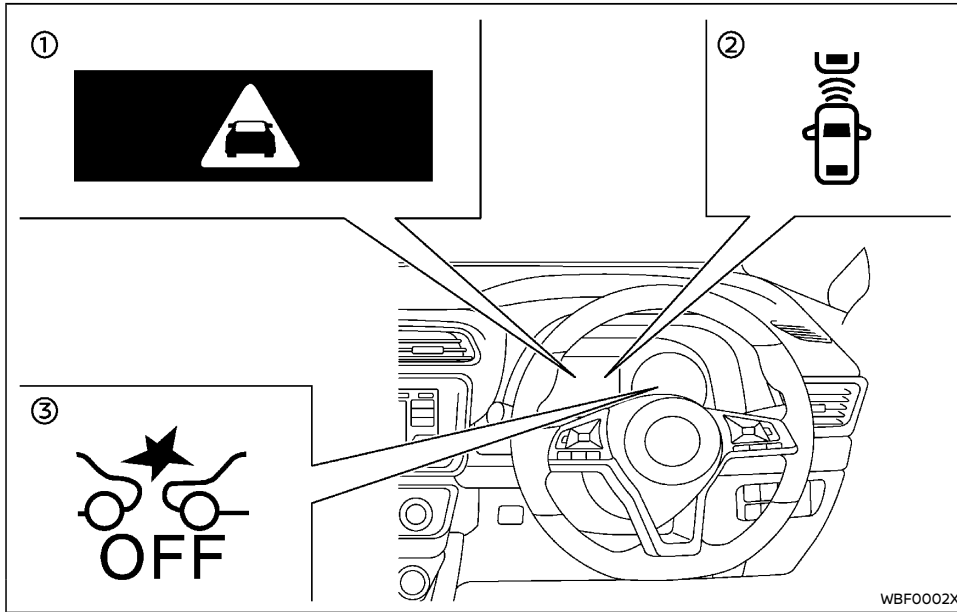

- ① Intelligent Emergency Braking emergency warning indicator
- ② Vehicle ahead detection indicator
- ③ Intelligent Emergency Braking system warning light (on the meter panel)

INTELLIGENT EMERGENCY BRAKING SYSTEM OPERATION

The Intelligent Emergency Braking system will function when your vehicle is driven at speeds above approximately 5 km/h (3 MPH).

If a risk of a forward collision is detected, the Intelligent Emergency Braking system will firstly provide the warning to the driver by flashing the vehicle ahead detection indicator (yellow) in the vehicle information display and providing an audible alert.

If the driver applies the brakes quickly and

forcefully after the warning, and the Intelligent Emergency Braking system detects that there is still the possibility of a forward collision, the system will automatically increase the braking force.

If the driver does not take action, the Intelligent Emergency Braking system issues the second warning to the driver by flashing the Intelligent Emergency Braking emergency warning indicator (red) and audible warning. If the driver releases the accelerator pedal, then the system applies partial braking.

If the risk of a collision becomes imminent, the Intelligent Emergency Braking system applies harder braking automatically.

While the Intelligent Emergency Braking system is operating, you may hear the sound of brake operation. This is normal and indicates that the Intelligent Emergency Braking system is operating properly.

NOTE:

The vehicle's stop lights come on when braking is performed by the Intelligent Emergency Braking system.

Depending on vehicle speed and distance to the vehicle ahead, as well as driving and roadway conditions, the system may help the driver avoid a forward collision or may help mitigate the consequences of a collision should one be unavoidable.

If the driver is handling the steering wheel, accelerating or braking, the Intelligent Emergency Braking system will function later or will not function.

The automatic braking will cease under the following conditions:

- When the steering wheel is turned as far as necessary to avoid a collision.
- When the accelerator pedal is depressed.
- When there is no longer a vehicle detected ahead.

If the Intelligent Emergency Braking system has stopped the vehicle, the vehicle will remain at a standstill for approximately 2 seconds before the brakes are released.

TURNING THE INTELLIGENT EMERGENCY BRAKING SYSTEM ON/OFF

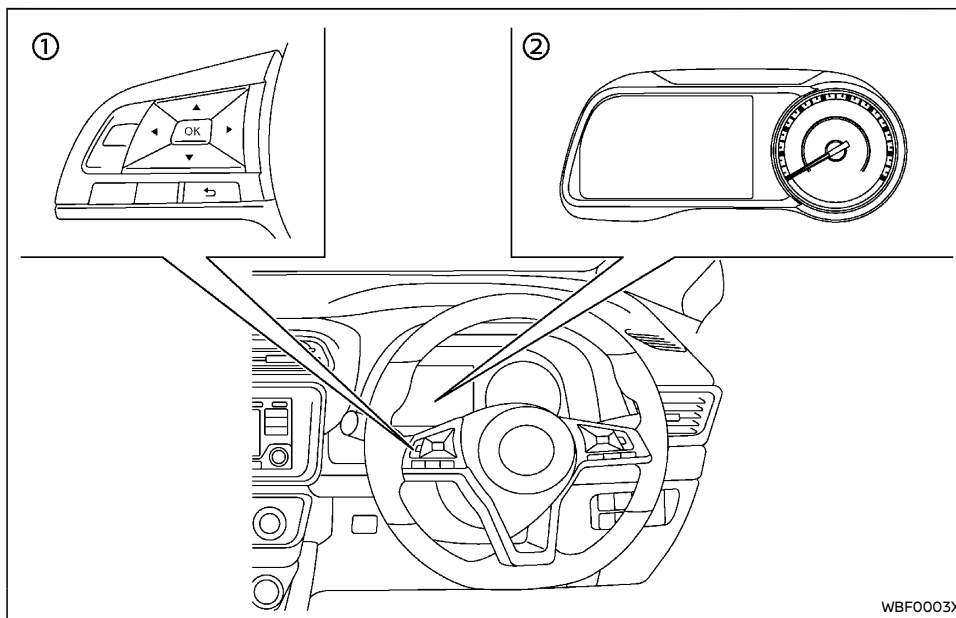

① Steering-wheel-mounted controls (left side)

② Vehicle information display

Perform the following steps to enable or disable the Intelligent Emergency Braking system.

1. Push the ◀ ▶ button until "Settings" appears in the vehicle information display.

2. Use the ⬆ button to select "Driver Assistance". Then push the OK button.

3. Select "Emergency Brake" and push the OK button.

4. Select "System" and push the OK button to enable or disable the Intelligent Braking system.

When the Intelligent Emergency Braking system is turned off, the Intelligent Emergency Braking system warning light illuminates.

WBF0003X

NOTE:

- The Intelligent Emergency Braking system will be automatically turned ON when the EV system is restarted.
- When the Electronic Stability Program (ESP) system is turned off, the Intelligent Emergency Braking system is also turned off. For details about the ESP system, see “Electronic Stability Program (ESP) system” (P.5-11).

INTELLIGENT EMERGENCY BRAKING SYSTEM LIMITATIONS



WARNING:

Listed below are the system limitations for the Intelligent Emergency Braking system. Failure to operate the vehicle in accordance with these system limitations could result in serious injury or death.

- The Intelligent Emergency Braking system cannot detect all vehicles under all conditions.
- The radar sensor does not detect the following objects:
 - Pedestrians, animals or obstacles in the roadway
 - Animals of any size
 - Obstacles (for example, cargo or debris) on the roadway or roadside
 - Oncoming or crossing vehicles
 - Vehicles where the tires are difficult to see or the shape of the rear of the vehicle is unclear or obstructed
 - Parked vehicles

- The radar sensor has some performance limitations. If a stationary vehicle is in the vehicle's path, the Intelligent Emergency Braking system will not function when the vehicle is driven at speeds over approximately 80 km/h (50 MPH).
- The radar sensor may not detect a vehicle ahead in the following conditions:
 - In poor visibility conditions (such as rain, snow, fog, dust storms, sand storms, smoke, and road spray from other vehicles).
 - If dirt, ice, snow, fog or other material is covering the radar sensor area.
 - When driving on a steep downhill slope, on roads with sharp curves, and/or bumpy or dirt roads.
 - If there is interference by other radar sources.
 - When your vehicle's position or movement is changed quickly or significantly (for example, lane change, turning vehicle, abrupt steering, sudden acceleration or deceleration).
 - When your vehicle or the vehicle ahead moves quickly or significantly such that the system cannot detect and react in time (for example, vehicle cutting in, changing lanes, making a turn, steering abruptly, sudden acceleration or deceleration).
 - When the vehicle is offset from the vehicle's forward path.
 - If the speed difference between the two vehicles is small.
 - For approximately 15 seconds after starting the EV system.

- If the vehicle ahead has a unique or unusual shape, extremely low or high clearance heights, or unusual cargo loading or is narrow (for example, a motorcycle).

- The system performance may be degraded in the following conditions:
 - The vehicle is driven on a slippery road.
 - The vehicle is driven on a slope.
 - Excessively heavy baggage is loaded in the rear seat or the cargo area of your vehicle.
- The system is designed to automatically check the sensor's functionality, within certain limitations. The system may not detect some forms of obstruction of the sensor area such as ice, snow, stickers, for example. In these cases, the system may not be able to warn the driver properly. Be sure that you check, clean and clear the sensor area regularly.
- In some road or traffic conditions, the Intelligent Emergency Braking system may unexpectedly apply partial braking. When acceleration is necessary, continue to depress the accelerator pedal to override the system.
- The system may keep operating when the vehicle ahead is turning right or left.
- The system may operate when your vehicle is approaching and passing a vehicle ahead.
- Depending on the road shape (curved road, entrance and exit of the curve, winding road, lane regulation, under construction, etc.), the system may operate temporarily for the oncoming vehicle in

front of your vehicle.

- The Intelligent Emergency Braking system may react to:
 - objects on the roadside (traffic sign, guardrail, vehicle, etc.)

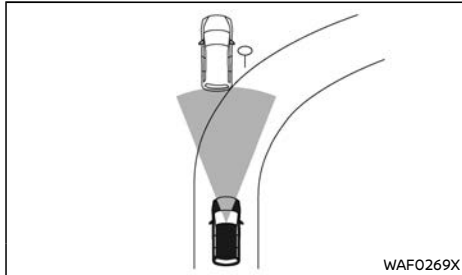

- objects above road (low bridge, traffic sign, etc.)
- objects on the road surface (railroad track, grate, steel plate, etc.)
- objects in the parking garage (beam, pillar, etc.)
- vehicles or objects in adjacent lane or close to the vehicle
- objects on the road (such as trees)
- Braking distances increase on slippery surfaces.
- Excessive noise will interfere with the warning chime sound, and the chime may not be heard.

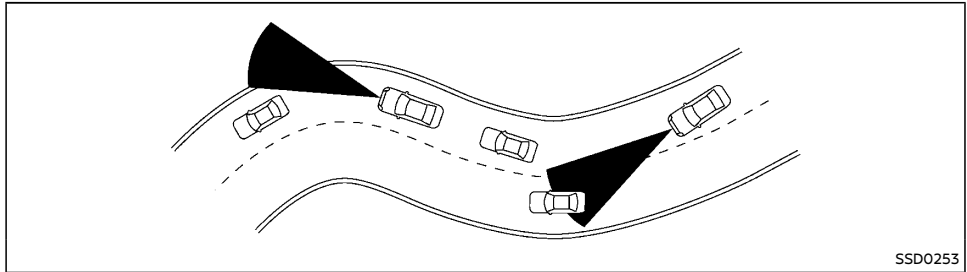

When driving on some roads, such as winding, hilly, curved, narrow roads, or roads which are under construction, the sensor may detect vehicles in a different lane, or may temporarily not detect a vehicle traveling ahead. This may cause the system to work inappropriately.

The detection of vehicles may also be affected by vehicle operation (steering maneuver or traveling position in the lane, etc.) or vehicle condition. **If this occurs, the system may warn you by blinking the system indicator and sounding the chime unexpectedly. You will have to manually control the proper distance away from the vehicle traveling ahead.**

SYSTEM TEMPORARILY UNAVAILABLE

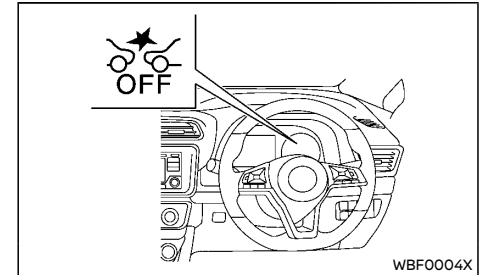

Condition A

When the radar sensor picks up interference from another radar source, making it impossible to detect a vehicle ahead, the Intelligent Emergency Braking system is automatically turned off.

The Intelligent Emergency Braking system warning light (orange) will illuminate.

Action to take:

When the above conditions no longer exist, the Intelligent Emergency Braking system will resume automatically.

Condition B

In the following conditions, the “Not Available: Front Radar Blocked” warning message will appear in the vehicle information display.

- The sensor area on the front of the vehicle is covered with dirt or is obstructed.

Action to take

If the message appears, stop the vehicle in a safe place and turn the EV system off. Clean the radar cover on the front of the vehicle with a soft cloth, and restart the EV system. If the warning message continues to illuminate, have the Intelligent Emergency Braking system checked by a NISSAN certified LEAF dealer.

- When driving on roads with limited road structures or buildings (for example, long bridges, deserts, snow fields, driving next to long walls).

Action to take

When the above conditions no longer exist, the Intelligent Emergency Braking system will resume automatically.

Condition C

When the Electronic Stability Program (ESP) system is OFF, the Intelligent Emergency Braking system brake will not operate. In this case only visible and audible warning operates. The Intelligent Emergency Braking system warning light (orange) will illuminate.

Action to take:

When the ESP system is ON, the Intelligent Emergency Braking system will resume automatically.

SYSTEM MALFUNCTION

If the Intelligent Emergency Braking system malfunctions, it will be turned off automatically, a chime will sound, the Intelligent Emergency Braking system warning light (orange) will illuminate and the “System fault” warning message will appear in the vehicle information display.

Action to take:

If the warning light (orange) comes on, stop the vehicle in a safe location. Turn the EV system off and restart the EV system. If the warning light continues to illuminate, have the Intelligent Emergency Braking system checked by a NISSAN certified LEAF dealer.

SYSTEM MAINTENANCE

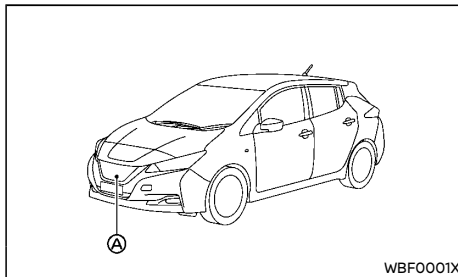

The radar sensor ① is located on the front of the vehicle.

To keep the Intelligent Emergency Braking system operating properly, be sure to observe the following:

- Always keep the sensor area on the front of the vehicle clean.

- Do not strike or damage the areas around the sensor.
- Do not cover or attach stickers or similar objects on the front of the vehicle near the sensor area. This could cause failure or malfunction.
- Do not attach metallic objects near the radar sensor area (brush guard, etc.). This could cause failure or malfunction.
- Do not alter, remove or paint the front of the vehicle near the sensor area. Contact a NISSAN certified LEAF dealer before customizing or restoring the sensor area.

ECO MODE

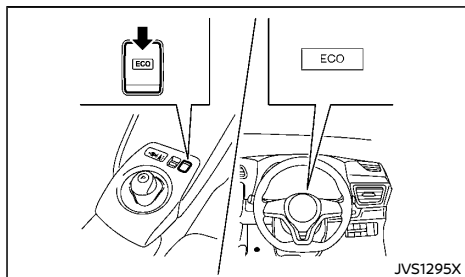

The ECO mode helps reduce power consumption by reducing acceleration when compared to the same accelerator pedal position in the D (Drive) position. Use the ECO mode for maximum driving range and for city driving.

To turn on the ECO mode, push the ECO mode switch. The ECO mode indicator appears on the vehicle information display.

To turn off the ECO mode, push the ECO mode switch again. The ECO mode indicator will turn off.

- The selection of the ECO mode (ON or OFF) is retained even when the EV system is restarted.
- When the ECO mode is turned off, driving performance is changed. Before turning off the ECO mode, ensure it is safe to do so, release the accelerator pedal and operate the ECO mode switch.
- Turn off the ECO mode when acceleration is required, such as when:
 - driving with a heavy load of passengers or cargo in the vehicle.
 - driving on a steep uphill slope.
- When the cruise control is operated, the vehicle makes it a priority to maintain a constant speed. The driving range will not

be extended even if the ECO mode indicator appears.

INCREASING POWER ECONOMY

The actual driving range will vary depending upon:

- speed
- vehicle load
- electrical load from vehicle accessories
- traffic and road conditions

NISSAN recommends the following driving habits to help maximize driving range:

Before driving:

- Follow recommended scheduled maintenance.
- Keep tires inflated to the correct pressure.
- Keep wheels in correct alignment.
- Pre-heat or pre-cool the interior cabin while the vehicle is charging.
- Remove unnecessary cargo from the vehicle.

While driving:

- Drive in ECO mode
 - The ECO mode helps reduce power consumption by reducing acceleration when compared to the same accelerator pedal position in the D (Drive) position (normal mode).
- Drive at a constant speed. Maintain cruising speeds with constant accelerator pedal positions or use the cruise control system when appropriate.
- Accelerate slowly and smoothly. Gently depress and release the accelerator pedal for acceleration and deceleration.
- Drive at moderate speeds on the highway.
- Avoid frequent stopping and braking. Maintain a safe distance behind other vehicles.
- Turn off the climate control system when it is not necessary.

PARKING



WARNING:

- Select a moderate temperature setting for heating or cooling to help reduce power consumption.
 - Use only the fan to help reduce power consumption.
 - In cold weather, use the heated seats as a substitute for the climate control system to help reduce power consumption.
 - Use the climate control system and close windows to reduce drag when cruising at highway speed.
 - Release the accelerator pedal to slow down and do not apply the brakes when traffic and road conditions allow.
 - This vehicle is equipped with a regenerative brake system. The primary purpose of regenerative brake system is to provide some power to recharge the Li-ion battery and extend driving range. A secondary benefit is “engine braking” that operates based on Li-ion battery conditions. In the D (Drive) or B position, when the accelerator pedal is released, the regenerative brake system provides some deceleration and some power to the Li-ion battery.
- **Do not stop or park the vehicle over flammable materials such as dry grass, waste paper or rags. They may ignite and cause a fire.**
 - **Never leave the vehicle in the READY to drive mode while the vehicle is unattended.**
 - **Do not leave children unattended inside the vehicle. They could unknowingly activate switches or controls. Unattended children could become involved in serious accidents.**
 - **To help avoid risk of injury or death through unintended operation of the vehicle and/or its systems, do not leave children, people who require the assistance of others or pets unattended in your vehicle. Additionally, the temperature inside a closed vehicle on a warm day can quickly become high enough to cause a significant risk of injury or death to people and pets.**
 - **Safe parking procedures require that both the parking brake be applied and the vehicle placed in the P (Park) position. Failure to do so could cause the vehicle to move unexpectedly or roll away and result in an accident.**

TRAILER TOWING

Your vehicle was designed to be used to carry passengers and luggage. NISSAN does not recommend trailer towing, because it places additional loads on your EV system, drivetrain, steering, braking, and other systems.



CAUTION:

Vehicle damage resulting from towing a trailer is not covered by the warranties.

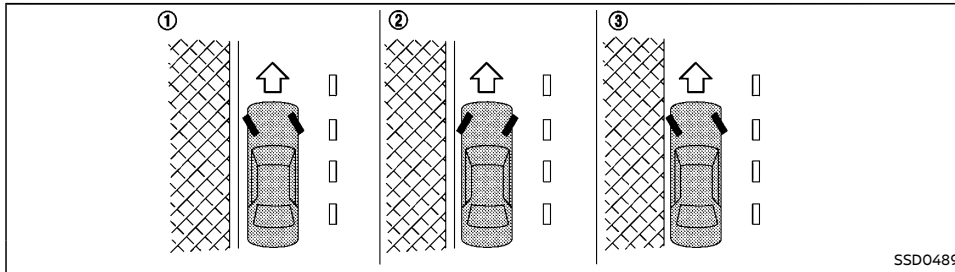

SSD0489

1. Firmly apply the parking brake.
2. Push the P position switch on the shift lever.
3. To help prevent the vehicle from rolling into the street when parked on a slope, it is a good practice to turn the wheels as illustrated.
 - HEADED DOWNHILL WITH CURB: ①
Turn the wheels into the curb and move the vehicle forward until the curb side wheel gently touches the curb.
 - HEADED UPHILL WITH CURB: ②
Turn the wheels away from the curb and move the vehicle back until the curb side wheel gently touches the curb.
 - HEADED UPHILL OR DOWNHILL, NO CURB: ③
Turn the wheels toward the side of the road so the vehicle will move away from the center of the road if it moves.
4. Place the power switch in the OFF position.

ELECTRIC POWER STEERING



WARNING:

- If the **READY to drive indicator light is OFF while driving, the power assist for the steering will not work. Steering will be harder to operate.**
- When the electric power steering warning light illuminates while the **READY to drive indicator light ON, the power assist for the steering will cease operation. You will still have control of the vehicle but the steering will be harder to operate.**

The electric power steering is designed to provide power assistance while driving to operate the steering wheel with less effort.

When the steering wheel is operated repeatedly or continuously while parking or driving at a very low speed, the power assist for the steering wheel will be reduced. This is to prevent overheating of the electric power steering and help protect it from getting damaged. While the power assistance is reduced, steering wheel operation will become harder. When the temperature of the electric power steering goes down, the power assistance level will return to normal. Avoid repeating such steering wheel operations that could cause the electric power steering to overheat.

You may hear a noise when the steering wheel is operated quickly. However, this is not a malfunction.

If the electric power steering warning light  illuminates while the **READY to drive indicator light is ON**, it may indicate the electric power steering is not functioning properly and may need servicing. Have the electric power steering checked by a NISSAN certified LEAF dealer. (See "Electric power steering warning light" (P.2-11).)

The power assist for steering stops operating when both the electric power steering warning light and **READY to drive indicator light** are illuminated. You will still have control of the vehicle. However, greater steering effort is needed, especially in sharp turns and at low speeds.

BRAKE SYSTEM

BRAKING PRECAUTIONS

This vehicle is equipped with two braking systems:

1. Hydraulic brake system
2. Regenerative brake system

Hydraulic brake system

The hydraulic brake system is similar to the brakes used on conventional vehicles.

The brake system has two separate hydraulic circuits. If one circuit malfunctions, you will still have braking at two wheels.

Regenerative brake system

The primary purpose of regenerative brake system is to provide some power to help recharge the Li-ion battery and extend driving range. A secondary benefit is "engine braking" that operates based on battery conditions.

In the D (Drive) position, when the accelerator is released, the regenerative brake system provides some deceleration and generates power for the Li-ion battery. Power is also generated when the brake pedal is applied.

When you put the shift lever in the B position and take your foot off the accelerator pedal, more regenerative brake is applied than in the D (Drive) position. However, during high-speed driving you may feel that regenerative brake provides less deceleration than the engine braking in an ordinary vehicle. This is normal.

Less deceleration is provided by the regenerative brake system when the Li-ion battery is fully charged. Regenerative brake is automatically reduced when the Li-ion battery is fully charged to prevent the Li-ion battery from becoming overcharged. Regenerative brake is also automatically reduced when the battery

temperature is high/low (indicated by the red/blue zones on the battery temperature gauge) to prevent Li-ion battery damage.

The brake pedal should be used to slow or stop the vehicle depending on traffic or road conditions. The vehicle brakes are not affected by regenerative brake system operation.

NOTE:

- When applying the regenerative brakes, you may hear a sound coming from the regenerative brake system. This is a normal operating characteristic of an EV (Electric vehicle).
- If the power switch position is in a position other than ON or READY to drive, you can stop the vehicle by depressing the brake pedal. However, greater foot pressure on the brake pedal will be required to stop the vehicle, and the stopping distance will be longer.
- When depressing the brake pedal, the braking pedal feel will not be smooth or may change when the cooperative regenerative brake system activates. However, the electronically controlled brake system is operating normally and this does not indicate a malfunction.

Using brakes

Avoid resting your foot on the brake pedal while driving. This will cause overheating of the brakes, wearing out the brake pads and shoes faster and will reduce driving range.

To help reduce brake wear and to prevent the brakes from overheating, reduce speed and select the B position before going down a slope or long grade. Overheated brakes may reduce braking performance and could result in loss of vehicle control.



WARNING:

- While driving on a slippery surface, be careful when braking or accelerating. Abrupt braking or accelerating could cause the wheels to skid, which could result in an accident.
- If the brake pedal is depressed with the EV (Electric Vehicle) system OFF, you may feel an increased brake pedal effort and a decreased pedal stroke. If the brake warning light (red) does not illuminate and the brake pedal feels like it has returned to its normal state after the EV system is started, this indicates that there is no malfunction and the vehicle can be operated normally.

Wet brakes

When the vehicle is washed or driven through water, the brakes may get wet. As a result, the braking distance will be longer and the vehicle may pull to one side during braking.

To dry brakes, drive the vehicle at a safe speed while lightly tapping the brake pedal to heat up the brakes. Do this until the brakes return to normal. Avoid driving the vehicle at high speeds until the brakes have dried.

Parking brake break-in

Break in the parking brake shoes whenever the holding effect of the parking brake is weakened or whenever the parking brake shoes and/or drums are replaced, in order to maintain optimum braking performance.

This procedure is described in the vehicle Service Manual, and it can be performed by a NISSAN certified LEAF dealer.

ANTI-LOCK BRAKING SYSTEM (ABS)



WARNING:

- The Anti-lock Braking System (ABS) is a sophisticated device, but it cannot prevent accidents resulting from careless or dangerous driving techniques. It can help maintain vehicle control during braking on slippery surfaces. Remember that stopping distances on slippery surfaces will be longer than on normal surfaces even with ABS. Stopping distances may also be longer on rough, gravel or snow covered roads, or if you are using tire chains. Always maintain a safe distance from the vehicle in front of you. Ultimately, the driver is responsible for safety.
- Tire type and condition may also affect braking effectiveness.
 - When replacing tires, install the specified size of tires on all four wheels.
 - When installing a spare tire (if equipped), make sure that it is the proper size and type as specified on the tire placard. (See “Tire placard” (P.9-6).)
 - For detailed information, see “Wheels and tires” (P.8-21).

The Anti-lock Braking System (ABS) controls the brakes so the wheels do not lock during hard braking or when braking on slippery surfaces. The system detects the rotation speed at each wheel and varies the brake fluid pressure to prevent each wheel from locking and sliding. By preventing each wheel from locking, the system helps the driver maintain steering control and helps to minimize swerving and spinning on slippery surfaces.

Using the system

Depress the brake pedal and hold it down. Depress the brake pedal with firm steady pressure, but do not pump the brakes. The ABS will operate to prevent the wheels from locking up. Steer the vehicle to avoid obstacles.



WARNING:

Do not pump the brake pedal. Doing so may result in increased stopping distances.

Self-test feature

The ABS includes electronic sensors, electric pumps, hydraulic solenoids and a computer. The computer has a built-in diagnostic feature that tests the system each time you push the power switch in the READY to drive position and move the vehicle at a low speed in forward or reverse. When the self-test occurs, you may hear a “clunk” noise and/or feel a pulsation in the brake pedal. This is normal and does not indicate a malfunction. If the computer senses a malfunction, it switches the ABS off and illuminates the ABS warning light on the instrument panel. The brake system then operates normally, but without anti-lock assistance.

If the ABS warning light illuminates during the self-test or while driving, have the vehicle checked by a NISSAN certified LEAF dealer.

Normal operation

The ABS operates at speeds above 5 to 10 km/h (3 to 6 MPH). The speed varies according to road conditions.

When the ABS senses that one or more wheels are close to locking up, the actuator rapidly applies and releases hydraulic pressure. This action is similar to pumping the brakes very quickly. You may feel a pulsation in the brake pedal and hear a noise from under the hood or feel a vibration from the actuator when it is operating. This is normal and indicates that the ABS is operating properly. However, the pulsation may indicate that road conditions are hazardous and extra care is required while driving.

VEHICLE SECURITY

When leaving your vehicle unoccupied:

- Always take the key with you - even when leaving the vehicle in your own garage.
- Close all windows completely and lock all doors.
- Always park your vehicle where it can be seen. Park in a well lit area during the night.
- If the security system is equipped, use it - even for a short period.
- Never leave children or pets in the vehicle unattended.
- Never leave valuables inside the vehicle. Always take valuables with you.
- Never leave the vehicle documents in the vehicle.
- Never leave articles on a roof rack. Remove them from the rack and keep and lock them inside the vehicle.
- Never leave the spare key in the vehicle.

COLD WEATHER DRIVING



WARNING:

- Whatever the condition, drive with caution. Accelerate and decelerate with great care. If accelerating or decelerating too fast, the drive wheels will lose even more traction.
- Allow more stopping distance in cold weather driving. Braking should be started sooner than on dry pavement.
- Keep at a greater distance from the vehicle in front of you on slippery roads.
- Wet ice (0°C, 32°F and freezing rain), very cold snow and ice can be slick and very difficult to drive on. The vehicle will have a lot less traction or grip under these conditions. Try to avoid driving on wet ice until the road is salted or sanded.
- Watch for slippery spots (glaring ice). These may appear on an otherwise clear road in shaded areas. If a patch of ice is seen ahead, brake before reaching it. Try not to brake while actually on the ice, and avoid any sudden steering maneuvers.
- Do not use cruise control on slippery roads.



CAUTION:

To prevent damage to the Li-ion battery: Do not store a vehicle in temperatures below -25°C (-13°F) for over seven days. If the outside temperature is -25°C (-13°F) or less, the Li-ion battery may freeze and it cannot be charged or provide power to drive the vehicle. Move the vehicle to a warm location.

NOTE:

- Driving range may be substantially reduced in extremely cold conditions (for example under -20°C (-4°F)).
- Using the climate control system to heat the cabin when outside temperature is below 0°C (32°F) uses more electricity and affects driving range more than when using the heater when the temperature is above 0°C (32°F).

12-VOLT BATTERY

If the 12-volt battery is not fully charged during extremely cold weather conditions, the 12-volt battery fluid may freeze and damage the 12-volt battery. To maintain maximum efficiency, the 12-volt battery should be checked regularly. For details, see "12-volt battery" (P.8-11).

COOLANT

If the vehicle is to be left outside without anti-freeze, drain the cooling system. Refill before operating the vehicle. For details, see "Cooling system" (P.8-6).

TIRE EQUIPMENT

1. If you have snow tires installed on the front/rear wheels of your vehicle, they should be of the same size, loading range, construction and type (bias, bias-belted or radial) as the rear/front tires.
2. If the vehicle is to be operated in severe winter conditions, snow tires should be installed on all four wheels.
3. For additional traction on icy roads, studded tires may be used. However, some countries, provinces and states prohibit their use. Check local, state and provincial laws before installing studded tires.

Skid and traction capabilities of studded

snow tires, on wet or dry surfaces, may be poorer than that of non-studded snow tires.

4. Snow chains may be used if desired. Make sure they are the proper size for the tires on your vehicle and are installed according to the chain manufacturer's instructions. Use chain tensioners when recommended by the tire chain manufacturer to ensure a tight fit. Loose end links of the tire chains must be secured or removed to prevent the possibility of whipping action damage to the fenders or underbody. In addition, drive at a reduced speed, otherwise, your vehicle may be damaged and/or vehicle handling and performance may be adversely affected.

SPECIAL WINTER EQUIPMENT

It is recommended that the following items be carried in the vehicle during the winter:

- A scraper and stiff-bristled brush to remove ice and snow from the windows.
- A sturdy, flat board to be placed under the jack to give it firm support.
- A shovel to dig the vehicle out of snow-drifts.

PARKING BRAKE

When parking in the area where the outside temperature is below 0°C (32°F), do not apply the parking brake to prevent it from freezing. For safe parking:

- Push the P position switch to place the vehicle in the P (Park) position.
- Securely block the wheels.

CORROSION PROTECTION

Chemicals used for road surface deicing are extremely corrosive and will accelerate corrosion and the deterioration of underbody components such as the brake lines, brake cables, floor pan and fenders.

In the winter, the underbody must be cleaned periodically. For additional information, see "Corrosion protection" (P.7-5).

For additional protection against rust and corrosion, which may be required in some areas, consult a NISSAN certified LEAF dealer.

FREEING A FROZEN CHARGE PORT LID

When the charge port is frozen, melt the ice.

6 In case of emergency

Hazard warning flasher switch	6-2	Jump starting	6-9
Emergency EV (Electric Vehicle) system shut off	6-2	If the Li-ion battery becomes completely discharged	6-11
Flat tire	6-2	Push starting	6-12
Stopping the vehicle	6-2	Towing your vehicle	6-12
Preparing tools	6-3	Towing precautions	6-12
Changing flat tire (models with spare tire)	6-4	Towing recommended by NISSAN	6-13
Repairing flat tire (models with emergency tire puncture repair kit)	6-6		

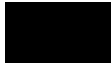

HAZARD WARNING FLASHER SWITCH

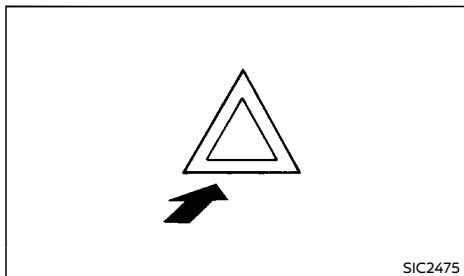

The hazard indicator flasher switch operates regardless of the power switch position except when the 12-volt battery is discharged.

The hazard indicator flasher is used to warn other drivers when you have to stop or park under emergency conditions.

When the hazard indicator flasher switch is pushed, all turn signal lights will flash. To turn off the hazard indicator flasher, push the hazard indicator flasher switch again.

When an impact that could activate the supplemental air bags is detected, the hazard warning flasher lights blink automatically. If the hazard warning flasher switch is pushed, the hazard warning flashers will turn off.



WARNING:

Do not turn the hazard warning flasher switch to off until you can make sure that it is safe to do so. Also, the hazard flasher warning may not blink automatically depending on the force of impact.

EMERGENCY EV (Electric Vehicle) SYSTEM SHUT OFF

To shut off the EV (Electric Vehicle) system in an emergency situation while driving, perform the following procedure.

- Rapidly push the power switch 3 consecutive times in less than 1.5 seconds, or
- Push and hold the power switch for more than 2 seconds.

FLAT TIRE

STOPPING THE VEHICLE



WARNING:

- **Make sure the parking brake is securely applied and the vehicle is placed into the P (Park) position.**
 - **Never change or repair tires when the vehicle is on a slope, ice or slippery areas. This is hazardous.**
 - **Never change or repair tires if oncoming traffic is close to your vehicle. Wait for professional road assistance.**
1. Safely move the vehicle off the road and away from traffic.
 2. Turn on the hazard warning flashers.
 3. Park on a level surface and apply the parking brake.
 4. Push the P position switch on the shift lever to the P (Park) position.
 5. Turn off the EV (Electric Vehicle) system.
 6. Open the hood and place the triangle reflector (if equipped).
 - To warn other traffic.
 - To signal professional road assistance personnel that you need assistance.
 7. Have all passengers get out of the vehicle and stand in a safe place, away from traffic and clear of the vehicle.

PREPARING TOOLS

This vehicle is equipped with either a spare tire or an emergency tire puncture repair kit. Carefully read the instructions provided in the appropriate section.

For models with spare tire: See "Changing flat tire (models with spare tire)" (P.6-4).

For models with emergency tire puncture repair kit: See "Repairing flat tire (models with emergency tire puncture repair kit)" (P.6-6).

Jacking tools

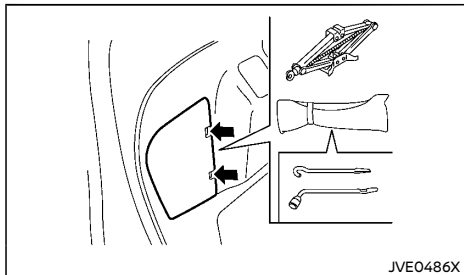

Jacking tools

Open the rear hatch.

Open the lid located inside the cargo area as illustrated.

Spare tire (if equipped)

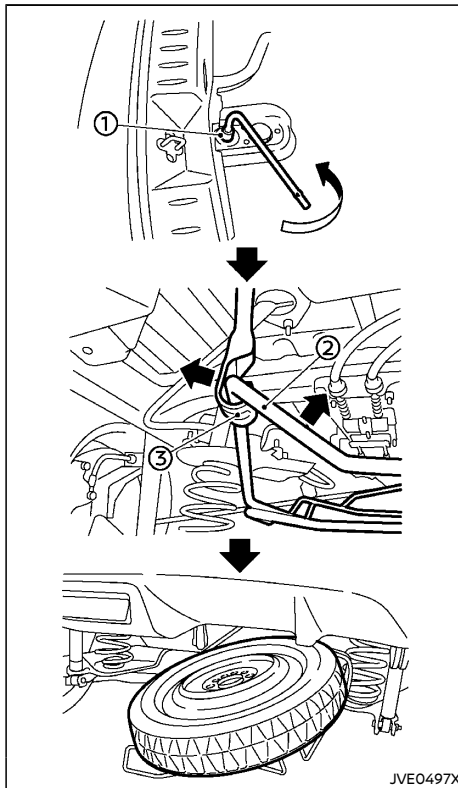

Spare tire

The spare tire is located under the rear of the vehicle.

To remove the spare tire, perform the following

procedures.

1. Open the rear hatch.
 2. Fold the outer end of the luggage floor board.
 3. Loosen the bolt ① counterclockwise approximately 25 turns using the wheel nut wrench to lower the spare tire.
 4. Stop turning the bolt when the tire is lowered to the place where the tire basket ② can be removed from the hook ③.
- Do not loosen the bolt excessively, otherwise the basket may fall suddenly.**
5. Hold the tire basket and remove it from the hook by pushing the basket upward.
 6. Lower the tire basket slowly to the ground, and then take out the spare tire.

WARNING:

Properly stow the spare tire basket after use. Driving without properly stowing the spare tire basket can cause contact with the road and cause sparks or scatter rocks/road debris resulting in vehicle damage or serious personal injury.

Spare tire basket bolt tightening torque:
64 to 86 N·m (6.6 to 8.7 kg·m, 48 to 63 ft·lb)

CHANGING FLAT TIRE (models with spare tire)

Blocking wheels

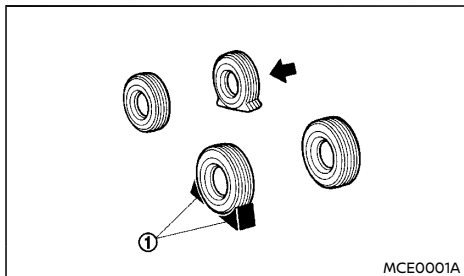

Place suitable blocks ① at both the front and back of the wheel diagonally opposite the flat tire to prevent the vehicle from moving when it is jacked up.



WARNING:

Be sure to block the wheel as the vehicle may move and result in personal injury.

Removing wheel cover (if equipped)

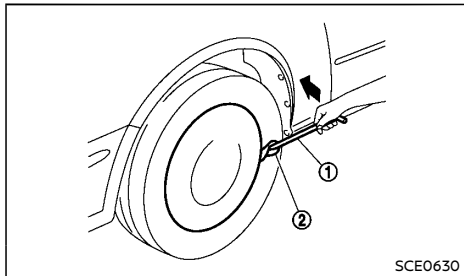

WARNING:

Never use your hands to remove the wheel cover. This may cause personal injury.

To remove the wheel cover, use the jack rod ① as illustrated.

Apply cloth ② between the wheel and jack rod to prevent damaging the wheel and wheel cover.

Jacking up vehicle

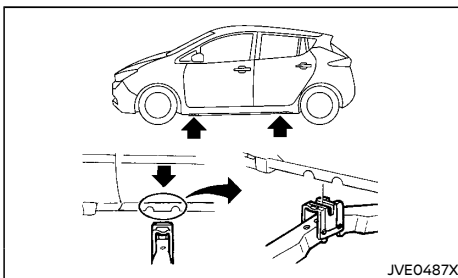

Jack-up points

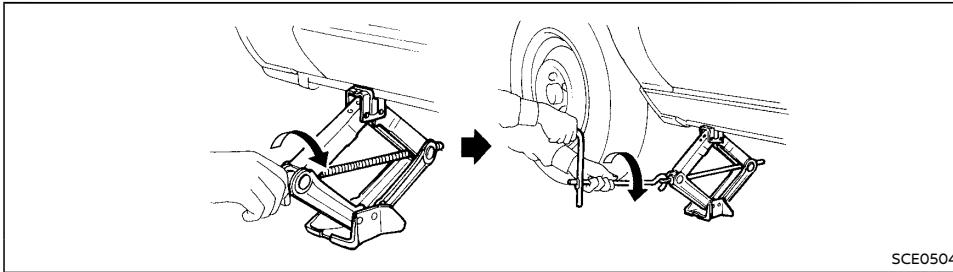

SCE0504

WARNING:

- Be sure to read and follow the instructions in this section.
- **DO NOT GET UNDER A VEHICLE THAT IS SUPPORTED BY A JACK.**
- Never use a jack which is not provided with your vehicle.
- The jack, which is provided with your vehicle, is designed only to lift your vehicle during a tire change. Do not use the jack provided with your vehicle on other vehicles.
- Never jack up the vehicle at a location other than the jack-up point that is specified.
- Never lift the vehicle more than necessary.
- Never use blocks on or under the jack.
- Never place the power switch in the **READY to drive mode** while the vehicle is on the jack. The vehicle may move suddenly, and this may cause an accident.

- Never allow passengers to remain in the vehicle while the tire is off the ground.
- Be sure to read the caution label attached to the jack body before using.

1. Place the jack directly under the jack-up point as illustrated so that the top of the jack contacts the vehicle at the jack-up point.

The jack should be placed on firm level ground.

2. Align the jack head between the two notches located at the jack-up point of either the front or the rear section.
3. Fit the groove of the jack head between the notches as shown.
4. Loosen each wheel nut, counterclockwise, one or two turns with the wheel nut wrench.

Do not remove the wheel nuts until the tire is off the ground.

5. Carefully raise the vehicle until the clearance between the tire and ground is achieved.

6. To lift the vehicle, securely hold the jack lever and rod with both hands and turn the jack lever.

Removing tire

1. Remove the wheel nuts.
2. Remove the damaged tire.



CAUTION:

The tire is heavy. Be sure that your feet are clear from the tire and use gloves as necessary to avoid injury.

Installing spare tire



WARNING:

- Never use wheel nuts which are not provided with your vehicle. Incorrect wheel nuts or improperly tightened wheel nuts may cause the wheel to become loose or come off. This could cause an accident.
- Never use oil or grease on the wheel studs or nuts. This may cause the wheel nuts to become loose.
- The T-type spare tire is designed for emergency use only.

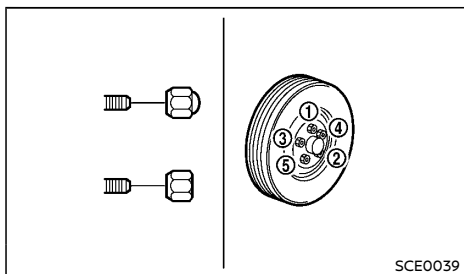

SCE0039

1. Clean any mud or dirt from the surface between the wheel and hub.
2. Carefully put the spare tire on and tighten the wheel nuts with your fingers. Check that all the wheel nuts contact the wheel surface horizontally.
3. Tighten the wheel nuts alternately and evenly in the sequence illustrated (① - ⑤), more than 2 times with the wheel nut wrench, until they are tight.
4. Lower the vehicle slowly until the tire touches the ground.
5. Tighten the wheel nuts securely, with the wheel nut wrench, in the sequence illustrated.
6. Lower the vehicle completely.

Tighten the wheel nuts to the specified torque with a torque wrench as soon as possible.

**Wheel nut tightening torque:
108 N·m (11 kg·m, 80 ft·lb)**

The wheel nuts must be kept tightened to specification at all times. It is recommended that the wheel nuts be tightened to specification at each lubrication interval.

⚠ WARNING:

Retighten the wheel nuts when the vehicle has been driven for 1,000 km (600 miles) (also in cases of a flat tire, etc.).

Stowing the damaged tire and the tools

Securely store the jack and tools in the storage area.

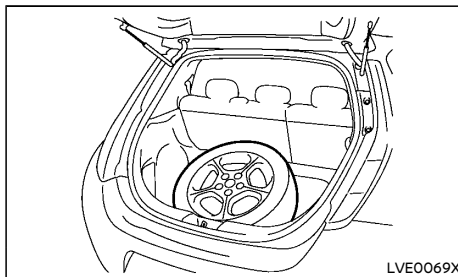

Securely store the damaged tire in the cargo area as illustrated.

The spare tire basket cannot be used for the conventional tire.

Return the spare tire basket to its original position in the reverse order of removal. (See "Preparing tools" (P.6-3).)

**Spare tire basket bolt tightening torque:
64 to 86 N·m (6.6 to 8.7 kg·m, 48 to 63 ft·lb)**

⚠ WARNING:

- Always make sure that the spare tire and jacking equipment are properly secured after use. Such items can become dangerous projectiles in an accident or sud-

den stop.

- Make sure that the spare tire basket is properly secured in its original position after removing the spare tire.
- The T-type spare tire is designed for emergency use only.

REPAIRING FLAT TIRE (models with emergency tire puncture repair kit)

The emergency tire puncture repair kit is supplied with the vehicle instead of a spare tire. This repair kit must be used for temporarily fixing a minor tire puncture. After using the repair kit, see a NISSAN certified LEAF dealer as soon as possible for tire inspection and repair/replacement.

⚠ CAUTION:

- NISSAN recommends using only Genuine NISSAN Emergency Tire Sealant provided with your vehicle. Other tire sealants may damage the valve stem seal which can cause the tire to lose air pressure.
- Do not use the emergency tire puncture repair kit provided with your vehicle on other vehicles.
- Do not use the emergency tire puncture repair kit for a purpose other than to inflate and check the tire pressure for the vehicle.
- Use the emergency tire puncture repair kit only on DC12V.
- Keep water and dust off the emergency tire puncture repair kit.
- Do not disassemble or modify the emergency tire puncture repair kit.

- Do not galvanize the emergency tire puncture repair kit.
- Do not use the emergency tire puncture repair kit under the following conditions. Contact a NISSAN certified LEAF dealer or professional road assistance.
 - when the sealant has passed its expiration date (shown on the label attached to the bottle)
 - when the cut or the puncture is approximately 6 mm (0.25 in) or longer
 - when the tire sidewall is damaged
 - when the vehicle has been driven with extremely low tire pressure
 - when the tire has come off the inside or the outside of the wheel
 - when the tire wheel is damaged
 - when two or more tires are flat

Removing wheel cover (if equipped)

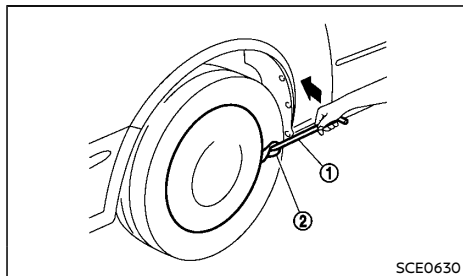

⚠ WARNING:

Never use your hands to remove the wheel cover. This may cause personal injury.

To remove the wheel cover, use the jack rod ① as illustrated.

Apply cloth ② between the wheel and jack rod to prevent damaging the wheel and wheel cover.

Getting emergency tire puncture repair kit

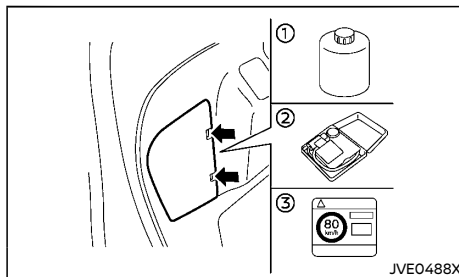

Take out the emergency tire puncture repair kit located under the cargo area. The repair kit consists of the following items:

- ① Tire sealant bottle
- ② Air compressor*
- ③ Speed restriction sticker

*: The compressor shape may differ depending on the models.

Before using emergency tire puncture repair kit

- If any foreign object (for example, a screw or nail) is embedded in the tire, do not remove it.
- Check the expiration date of the sealant (shown on the label attached to the bottle). Never use a sealant whose expiration date has passed.

Repairing tire

⚠ WARNING:

Observe the following precautions when using the tire repair compound.

- Swallowing the compound is dangerous. Immediately drink as much water as possible and seek prompt medical assistance.
- Rinse well with lots of water if the compound comes into contact with skin or eyes. If irritation persists, seek prompt medical attention.
- Keep the repair compound out of the reach of children.

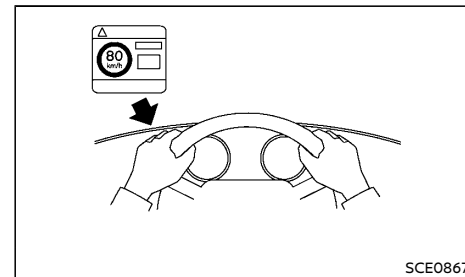

1. Take out the speed restriction sticker from the air compressor*, then put it in a location where the driver can see it while driving.

*: The compressor shape may differ depending on the models.



CAUTION:

Do not put the speed restriction label on the steering wheel pad, the speedometer or the warning light locations.

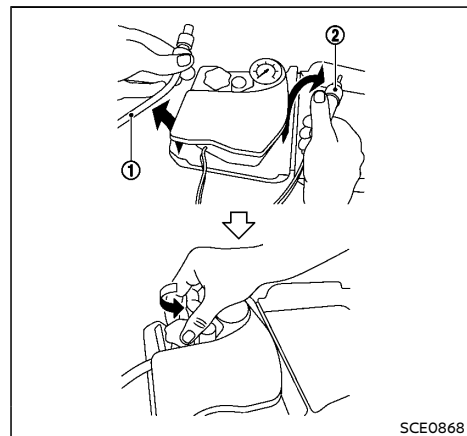

2. Take the hose ① and the power plug ② out of the air compressor. Remove the cap of the bottle holder from the air compressor.

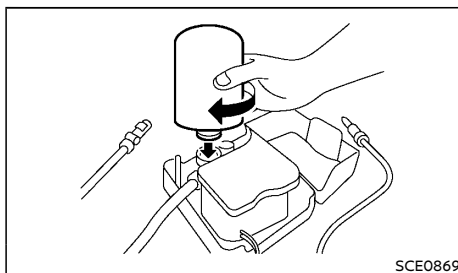

3. Remove the cap from the tire sealant bottle, and screw the bottle clockwise onto the bottle holder. (Leave the bottle seal intact. Screwing the bottle onto the bottle holder will pierce the seal of the bottle.)
4. Remove the cap from the tire valve on the flat tire.

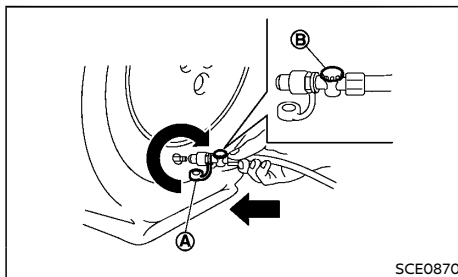

5. Remove the protective cap ① of the hose and screw the hose securely onto the tire valve. Make sure that the pressure release valve ② is securely tightened. Make sure that the air compressor switch is in the OFF (O) position, and then insert its power plug into the power outlet in the vehicle.

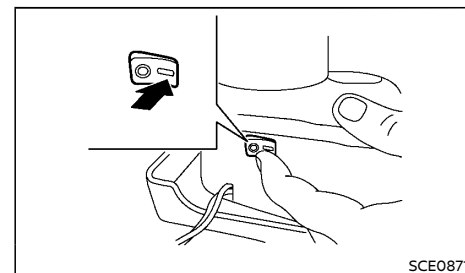

6. Push the power switch to the ACC position. Then turn the compressor switch to the ON (-) position and inflate the tire up to the pressure that is specified on the tire placard affixed to the driver's side center pillar if possible, or to the minimum of 180 kPa (26 psi). Turn the air compressor off briefly in order to check the tire pressure with the pressure gauge.

If the tire is inflated to higher than the specified pressure, adjust the tire pressure by releasing air with the pressure release valve. The cold tire pressures are shown on the tire placard affixed to the driver's side center pillar.



CAUTION:

- **An incomplete connection between the hose and tire valve causes air leakage or sealant scatter.**
- **Do not stand directly beside the damaged tire while it is being inflated because of the risk of the rupture. If there are any cracks or bumps, turn the compressor off immediately.**

- **There is a possibility that the pressure reaches 600 kPa while the tire is being inflated, but it is normal condition. Usually the pressure will drop in about 30 seconds.**
- **Do not operate the compressor for more than 10 minutes.**

If the tire pressure does not increase to **180 kPa (26 psi) within 10 minutes**, the tire may be seriously damaged and **the tire cannot be repaired with this tire repair kit**. Contact a NISSAN certified LEAF dealer.

7. When the tire pressure is reaching the specified pressure or is at the minimum of 180 kPa (26 psi), turn the air compressor off. Remove the power plug from the power outlet and quickly remove the hose from the tire valve. Attach the protective cap and valve cap.



CAUTION:

Leave the tire sealant bottle on the bottle holder in order to prevent sealant from spilling out.

8. Immediately drive the vehicle for 10 minutes or 3 km (2 miles) at a speed of 80 km/h (50 MPH) or less.
9. After driving, make sure that the air compressor switch is in the OFF (○) position, then screw the hose securely onto the tire valve. Check the tire pressure with the pressure gauge.

If the tire pressure drops under 130 kPa (19 psi):

The tire cannot be repaired with this tire puncture repair kit. Contact a NISSAN certified LEAF dealer.

If the tire pressure is 130 kPa (19 psi) or more but less than the specified pressure:

Turn the compressor switch to the ON (-) position and inflate the tire up to the specified pressure. Then repeat the steps from 8.

If the pressure drops again, **the tire cannot be repaired with this tire puncture repair kit**. Contact a NISSAN certified LEAF dealer.

When the tire pressure is the specified pressure:

The temporary repair is completed.

See a NISSAN certified LEAF dealer for tire repair/replacement as soon as possible.



CAUTION:

Do not reuse the tire sealant bottle or the hose.

For a new tire sealant bottle and hose, see a NISSAN certified LEAF dealer.

After repairing tire

See a NISSAN certified LEAF dealer for tire repair/replacement as soon as possible.

JUMP STARTING

To start your EV (Electric Vehicle) system with a booster battery, the instructions and precautions below must be followed.

Jump starting provides power to the 12-volt system to allow the electrical systems to operate. The electrical systems must be operating to allow the Li-ion battery to be charged. Jump starting does not charge the Li-ion battery. The Li-ion battery must be charged before the vehicle can be driven.



WARNING:

- **Incorrect jump starting can lead to a 12-volt battery explosion. The 12-volt battery explosion may result in severe injury or death. It may also result in damage to the vehicle. Be sure to follow the instructions in this section.**
- **Explosive hydrogen gas is always present in the vicinity of the 12-volt battery. Keep all sparks and flames away from the 12-volt battery.**
- **Always wear suitable eye protection and remove rings, bracelets, and any other jewelry whenever working on or near a 12-volt battery.**
- **Never lean over the 12-volt battery while jump starting.**
- **Never allow battery fluid to come into contact with eyes, skin, clothes or the vehicle's painted surfaces. Battery fluid is a corrosive sulfuric acid which can cause severe burns. If the fluid comes into contact with anything, immediately flush the contacted area with plenty of water.**
- **Keep the 12-volt battery out of the reach of children.**

- The booster battery must be rated at 12 volts. Use of an incorrectly rated battery will damage your vehicle.
- Never attempt to jump start a frozen battery. It could explode and cause serious injury.
- Your vehicle has an automatic cooling fan. It could come on at any time. Keep hands and other objects away from it.
- Always follow the instructions below. Failure to do so could result in damage to the Power Delivery Module (PDM) and cause personal injury.

CAUTION:

- Do not attempt to perform a jump start on the 12-volt battery at the same time that the Li-ion battery is being charged. Doing so may damage the vehicle or charging equipment and could cause an injury.
- LEAF cannot be used as a booster vehicle because it cannot supply enough power to start a gasoline engine. However, a gasoline engine vehicle can be used to supply power to the 12-volt battery of LEAF.

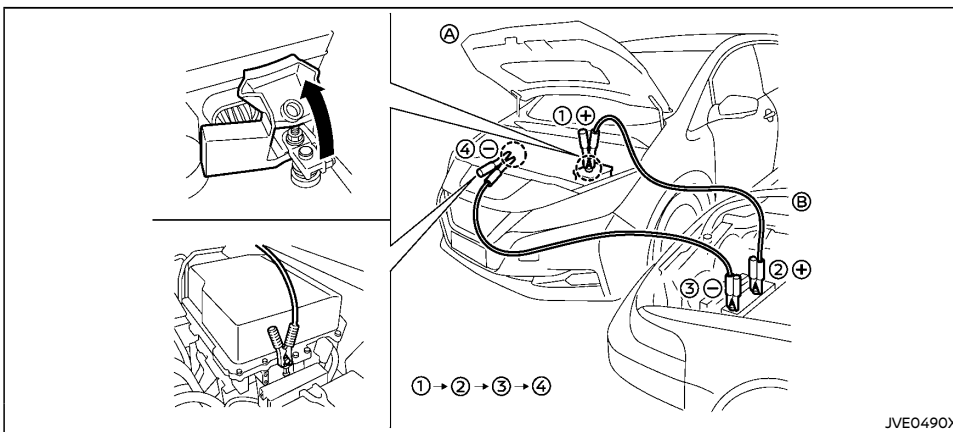

1. If the booster battery is in another vehicle ②, position the two vehicles (A and ②) to bring their 12-volt batteries into close proximity to each other.
Do not allow the two vehicles to touch.
2. Apply the parking brake.
3. Push the P position switch to place the vehicle in the P (Park) position.
4. Switch off all unnecessary electrical systems (headlights, heater, air conditioner, etc.).
5. Place the power switch in the OFF position.
6. Remove the vent caps (if equipped) on the 12-volt battery. Cover the battery with a firmly wrung out moist cloth to reduce the hazard of an explosion.
7. Connect jumper cables in the sequence as illustrated (① → ② → ③ → ④).

CAUTION:

- If the 12-volt battery is discharged, the power switch cannot be moved from the OFF position. Connect the jumper cables to the booster vehicle ② before pushing the power switch.
 - Always connect positive (+) to positive (+) and negative (-) to body ground (for example, as illustrated), not to the 12-volt battery.
 - Make sure the jumper cables do not touch moving parts in the motor compartment and that the cable clamps do not contact any other metal.
8. Start the engine of the booster vehicle ②.
 9. While the booster vehicle ② engine is running, place the power switch in the READY to drive position.

**CAUTION:**

If the system does not start right away, push the power switch to the OFF position and wait 10 seconds before trying again.

10. After starting your EV system, carefully disconnect the negative cable and then the positive cable (④ → ③ → ② → ①) and keep the READY to drive position over 20 minutes to charge the 12-volt battery.
11. Replace the vent caps (if equipped). Be sure to dispose of the cloth used to cover the vent holes because it may be contaminated with corrosive acid.
12. If necessary connect the vehicle to a charging station or EVSE (Electric Vehicle Supply Equipment) (if equipped) to charge the Li-ion battery. (See "CH. Charging" section.) The vehicle cannot be driven until the Li-ion battery is charged.

NOTE:

If it is not possible to turn the system ON by following this procedure, contact a NISSAN certified LEAF dealer immediately.

IF THE LI-ION BATTERY BECOMES COMPLETELY DISCHARGED

If the power limitation indicator light  illuminates, the traction motor output is limited resulting in reduced vehicle speed. Stop the vehicle in a safe location before the Li-ion battery becomes completely discharged and no power is available to drive the vehicle.

If possible, place the power switch in the OFF position while waiting for assistance to prevent discharging the 12-volt battery.

NOTE:

If the Li-ion battery becomes completely discharged:

- **The vehicle is automatically placed in the ON position and it will not be possible to switch to the READY to drive position.**
- **The vehicle is automatically switched to the N (Neutral) position and it will not be possible to drive the vehicle.**

**WARNING:**

If the vehicle is in the N (Neutral) position and the Li-ion battery and the 12-volt battery become completely discharged, the vehicle cannot be placed in the P (Park) position. If this occurs, apply the parking brake securely.

To place the vehicle in the READY to drive position so the vehicle can be driven, charge the Li-ion battery until the driving range on the instrument panel changes from "---" to a numeric distance.

NOTE:

- **Some vibration may occur when the vehicle is stopped in case the Li-ion battery becomes completely discharged. This is not a malfunction.**
- **If the Li-ion battery is completely discharged, it is required to charge until the low battery charge warning light (yellow)**

turns off (white).

PUSH STARTING

Do not attempt to start the system by pushing the vehicle.



CAUTION:

An EV (Electric Vehicle) cannot be push-started or tow-started. Attempting to do so may cause traction motor damage.

TOWING YOUR VEHICLE

When towing your vehicle, local regulations for towing must be followed. Incorrect towing equipment could damage your vehicle. Towing instructions are available from a NISSAN certified LEAF dealer. Local service operators are familiar with the applicable laws and procedures for towing. To assure proper towing and to prevent accidental damage to your vehicle, NISSAN recommends that you have a service operator tow your vehicle. It is advisable to have the service operator carefully read the following precautions.

TOWING PRECAUTIONS

- Be sure that the transmission, steering system and powertrain are in working condition before towing. If any units are damaged, the vehicle must be towed using a dolly or flatbed tow truck.
- NISSAN recommends that your vehicle be towed with the driving wheels off the ground.
- Always attach safety chains before towing.
- Never ride in a vehicle that is being towed.
- Never get under your vehicle after it has been lifted by a tow truck.

TOWING RECOMMENDED BY NISSAN

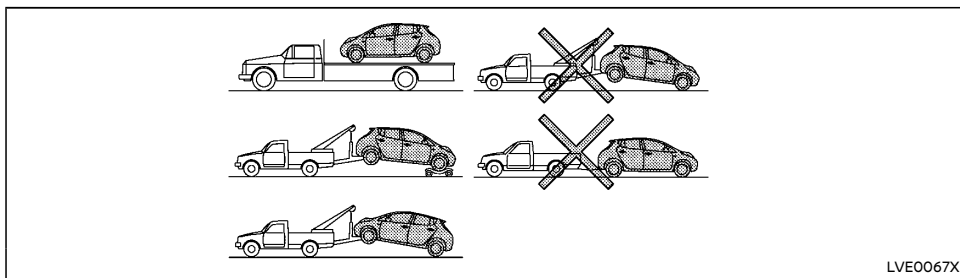

NISSAN recommends that towing dollies be used under the front wheels when towing your vehicle or the vehicle be placed on a flatbed tow truck as illustrated.

Front wheels on the ground

CAUTION:

Never tow your vehicle with the front wheels on the ground. Doing so will cause serious and expensive damage to the drivetrain.

Rear wheels on the ground

1. Place the power switch in the OFF position.
2. Secure the steering wheel in a straight-ahead position with rope or a similar device.
3. Move the shift lever to the "N" (Neutral) position.
4. Release the parking brake.
5. Attach safety chains whenever towing.

All four wheels on the ground

NISSAN recommends that the vehicle be placed on a flatbed tow truck as illustrated.

CAUTION:

Never tow your vehicle with all four wheels on the ground. Doing so will cause serious and expensive damage to the transmission.

Freeing trapped vehicle

WARNING:

- **Never allow anyone to stand near the towing line during the pulling operation.**
- **Never spin the tires at high speed. This could cause them to explode and result in serious injury. Parts of the vehicle could also overheat and be damaged.**
- **Do not pull the vehicle using the rear hook (except for Indonesia). The rear hook is not designed to pull the vehicle out in the event that the vehicle becomes trapped.**

In the event that your vehicle's tires become trapped in sand, snow, or mud, and the vehicle is unable to free itself without being pulled, use the recovery hook.

- Use the recovery hooks only. Do not attach the pulling device to any other part of the vehicle body. Otherwise, the vehicle body may be damaged.
- Use the recovery hooks to free a vehicle only.
- The recovery hooks are under tremendous stress when used to free a trapped vehicle. Always pull the pulling device straight out from the vehicle. Never pull on the recovery hooks at an angle.

Front:

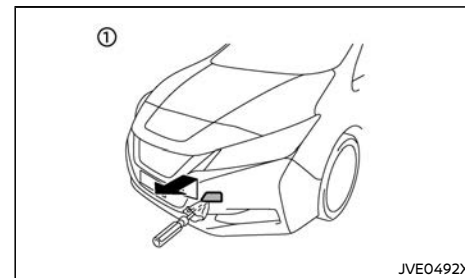

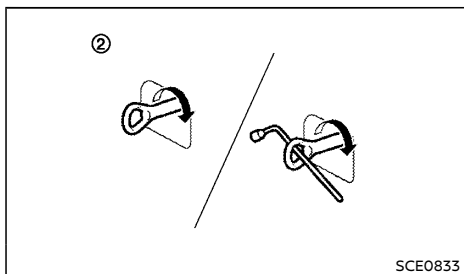

1. Using a suitable tool wrapped with a cloth, remove the hook cover from the bumper.
2. Securely install the recovery hook as illustrated. (The hook is stored in the left side of the cargo area.)

Make sure that the hook is properly secured in its original position after use.

Rear (except for Indonesia):

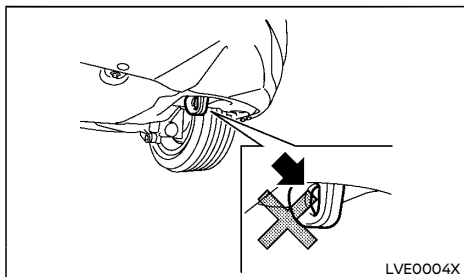

Do not use the rear hook to pull the vehicle.

7 Appearance and care

Cleaning exterior	7-2	Floor mats	7-4
Washing	7-2	Seat belts	7-4
Waxing	7-2	EVSE (Electric Vehicle Supply Equipment) (if equipped)	7-4
Removing spots	7-2	Corrosion protection	7-5
Underbody	7-2	Most common factors contributing to vehicle corrosion	7-5
Glass	7-2	Environmental factors influence the rate of corrosion	7-5
Wheels	7-3	To protect your vehicle from corrosion	7-5
Chrome parts	7-3		
Cleaning interior	7-3		
Air fresheners	7-4		



CLEANING EXTERIOR

In order to maintain the appearance of your vehicle, it is important to take proper care of it.

To protect the paint surfaces, wash your vehicle as soon as you can:

- after a rainfall to prevent possible damage from acid rain
 - after driving on coastal roads
 - when contaminants such as soot, bird droppings, tree sap, metal particles or bugs get on the paint surface
 - when dust or mud builds up on the surface
- Whenever possible, store or park your vehicle inside a garage or in a covered area.

When it is necessary to park outside, park in a shady area or protect the vehicle with a body cover.

Be careful not to scratch the paint surface when putting on or removing the body cover.

WASHING

Wash dirt off the vehicle with a wet sponge and plenty of water. Clean the vehicle thoroughly using a mild soap, a special vehicle soap or general purpose dishwashing liquid mixed with clean, lukewarm (never hot) water.



CAUTION:

- **Do not use car washes that use acid in the detergent. Some car washes, especially brushless ones, use some acid for cleaning. The acid may react with some plastic vehicle components, causing them to crack. This could affect their appearance, and also could cause them not to function properly. Always check with your car wash to confirm that acid is not used.**

- **Do not wash the vehicle with strong household soap, strong chemical detergents, gasoline or solvents.**
- **Do not wash the vehicle in direct sunlight or while the vehicle body is hot, as the surface may become water-spotted.**
- **Avoid using tight-napped or rough cloths, such as washing mitts. Care must be taken when removing caked-on dirt or other foreign substances so the paint surface is not scratched or damaged.**

Rinse the vehicle thoroughly with plenty of clean water.

Inside flanges, seams and folds on the doors, hatches and hood are particularly vulnerable to the effects of road salt. Therefore, these areas must be regularly cleaned. Make sure that the drain holes in the lower edge of the door are open. Spray water under the body and in the wheel wells to loosen the dirt and wash away road salt.

Avoid leaving water spots on the paint surface by using a damp chamois to dry the vehicle.

WAXING

Regular waxing protects the paint surface and helps retain new vehicle appearance. Polishing is recommended to remove built-up wax residue and to avoid a weathered appearance before reapplying wax.

A NISSAN certified LEAF dealer can assist you in choosing the proper product.

- Wax your vehicle only after a thorough washing. Follow the instructions supplied with the wax.
- Do not use a wax containing any abrasives, cutting compounds or cleaners that may damage the vehicle finish.

Machine compound or aggressive polishing on a base coat/clear coat paint finish may dull the finish or leave swirl marks.

REMOVING SPOTS

Remove tar and oil spots, industrial dust, insects, and tree sap as quickly as possible from the paint surface to avoid lasting damage or staining. Special cleaning products are available at a NISSAN certified LEAF dealer or any automotive accessory stores.

UNDERBODY

In areas where road salt is used in winter, the underbody must be cleaned regularly. This will prevent dirt and salt from building up and causing the acceleration of corrosion on the underbody and suspension. Before the winter period and again in the spring, the underseal must be checked and, if necessary, re-treated.

GLASS

Use glass cleaner to remove smoke and dust film from the glass surfaces. It is normal for glass to become coated with a film after the vehicle is parked in the hot sun. Glass cleaner and a soft cloth will easily remove this film.



CAUTION:

When cleaning the inside of the windows, do not use sharp-edged tools, abrasive cleaners or chlorine-based disinfectant cleaners. They could damage the electrical conductors, radio antenna elements or rear window defogger elements.

WHEELS

Wash the wheels when washing the vehicle to maintain their appearance.

- Clean the inner side of the wheels when the wheel is changed or the underside of the vehicle is washed.
- Inspect wheel rims regularly for dents or corrosion. Such damage may cause loss of pressure or poor seal at the tire bead.
- NISSAN recommends that the road wheels be waxed to protect against road salt in areas where it is used during winter.



CAUTION:

Do not use abrasive cleaners when washing the wheels.

Aluminum alloy wheels (if equipped)

Wash regularly with a sponge dampened in a mild soap solution, especially during winter months in areas where road salt is used. Salt could discolor the wheels if not removed.



CAUTION:

Follow the directions below to avoid staining or discoloring the wheels:

- **Do not use a cleaner that uses strong acid or alkali contents to clean the wheels.**
- **Do not apply wheel cleaners to the wheels when they are hot. The wheel temperature should be the same as ambient temperature.**
- **Rinse the wheel to completely remove the cleaner within 15 minutes after the cleaner is applied.**

CHROME PARTS

Clean chrome parts regularly with a non-abrasive chrome polish to maintain the finish.

CLEANING INTERIOR

Occasionally remove loose dust from the interior trim, plastic parts and seats using a vacuum cleaner or soft bristled brush. Wipe the vinyl and leather surfaces with a clean, soft cloth dampened in mild soap solution, then wipe clean with a dry soft cloth.

Regular care and cleaning is required in order to maintain the appearance of the leather.

Before using any fabric protector, read the manufacturer's recommendations. Some fabric protectors contain chemicals that may stain or bleach the seat material.

Use a cloth dampened only with water, to clean the meter and gauge lens.



CAUTION:

- **Never use benzine, thinner, or any similar material.**
- **Small dirt particles can be abrasive and damaging to the leather surfaces and should be removed promptly. Do not use saddle soap, car waxes, polishes, oils, cleaning fluids, solvents, detergents or ammonia-based cleaners as they may damage the leather's natural finish.**
- **Never use fabric protectors unless recommended by the manufacturer.**
- **Do not use glass or plastic cleaner on meter or gauge lens covers. It may damage the lens cover.**
- **Do not use the chlorine-based cleaning liquid such as chlorine dioxide and hypochlorous acid, which may cause the paint peeling, corrosion, etc. If it is unavoidable to clean or sterilize interior surfaces, use less than 75% ethanol. Wipe the interior parts with a dry cloth dampened with ethanol. Wipe off ethanol completely. If**

you leave it uncleaned, it may cause paint peeling, discoloration, etc. Since ethanol is flammable, be careful of fire.

AIR FRESHENERS

Most air fresheners use a solvent that could affect the vehicle interior. If you use an air freshener, take the following precautions:

- Hanging-type air fresheners can cause permanent discoloration when they contact vehicle interior surfaces. Place the air freshener in a location that allows it to hang free and not contact an interior surface.
- Liquid-type air fresheners typically clip on the vents. These products can cause immediate damage and discoloration when spilled on interior surfaces.

Carefully read and follow the manufacturer's instructions before using air fresheners.

FLOOR MATS

The use of genuine NISSAN floor mats (if equipped) can extend the life of your vehicle carpet and make it easier to clean the interior. Regardless of what mats are used, be sure they are fitted for your vehicle and are properly positioned in the foot well to prevent interference with pedal operation. Mats should be maintained with regular cleaning and replaced if they become excessively worn.

Floor mat positioning aid (driver's side only)

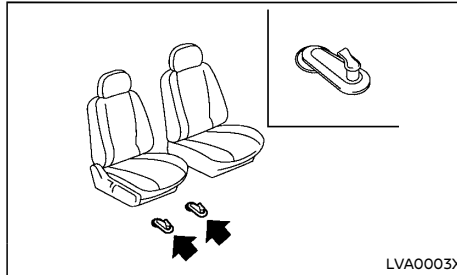

This vehicle includes front floor mat brackets to act as floor mat positioning aid. NISSAN floor mats have been specially designed for your vehicle model.

Position the mat by placing the floor mat bracket hook through the floor mat grommet hole while centering the mat in the floorwell.

Periodically check to make certain the mats are properly positioned.

SEAT BELTS

The seat belts can be cleaned by wiping them with a sponge dampened in a mild soap solution. Allow the belts to dry completely in the shade before using them.

See "Seat belts" (P.1-7).



WARNING:

Do not allow wet seat belts to roll up in the retractor. NEVER use bleach, dye, or chemical solvents to clean the seat belts, since these materials may severely weaken the seat belt webbing.

EVSE (Electric Vehicle Supply Equipment) (if equipped)

The Electric Vehicle Supply Equipment (EVSE) can be cleaned by wiping gently with a soft cloth dampened in a 3% mild soap solution. Wipe and rinse the soap solution off with a cloth dampened with water and allow the EVSE to dry in a shady and well-ventilated place.

CORROSION PROTECTION

MOST COMMON FACTORS CONTRIBUTING TO VEHICLE CORROSION

- The accumulation of moisture-retaining dirt and debris in body panel sections, cavities, and other areas.
- Damage to paint and other protective coatings caused by gravel and stone chips or minor traffic accidents.

ENVIRONMENTAL FACTORS INFLUENCE THE RATE OF CORROSION

Moisture

Accumulation of sand, dirt and water on the vehicle body underside can accelerate corrosion. Wet floor coverings will not dry completely inside the vehicle, and should be removed for drying to avoid floor panel corrosion.

Relative humidity

Corrosion will be accelerated in areas of high relative humidity, especially those areas where the temperatures stay above freezing, where atmospheric pollution exists, or where road salt is used.

Temperature

A temperature increase will accelerate the rate of corrosion to those parts which are not well ventilated.

Air pollution

Industrial pollution, the presence of salt in the air in coastal areas, or heavy road salt use will accelerate the corrosion process. Road salt will also accelerate the disintegration of paint surfaces.

TO PROTECT YOUR VEHICLE FROM CORROSION

- Wash and wax your vehicle often to keep the vehicle clean.
- Always check for minor damage to the paint and repair it as soon as possible.
- Keep drain holes at the bottom of the doors open to avoid water accumulation.
- Check the underbody for accumulation of sand, dirt or salt. If present, wash with water as soon as possible.



CAUTION:

- **NEVER remove dirt, sand or other debris from the passenger compartment by washing it out with a hose. Remove dirt with a vacuum cleaner.**
- **Never allow water or other liquids to come in contact with electronic components inside the vehicle as this may damage them.**

Chemicals used for road surface deicing are extremely corrosive. They accelerate corrosion and deterioration of underbody components such as the brake lines, brake cables, floor pan and fenders.

In winter, the underbody must be cleaned periodically.

For additional protection against rust and corrosion, which may be required in some areas, consult a NISSAN certified LEAF dealer.

MEMO

8 Maintenance and do-it-yourself

Maintenance requirement	8-2	Jump starting	8-12
Scheduled maintenance	8-2	Intelligent Key battery replacement	8-12
General maintenance	8-2	Fuses	8-13
Where to go for service	8-2	Motor compartment	8-13
General maintenance	8-2	Passenger compartment	8-15
Explanation of maintenance items	8-2	Lights	8-15
Maintenance precautions	8-4	Headlights	8-15
Motor compartment check locations	8-5	Exterior and interior lights	8-17
Cooling system	8-6	Light locations	8-18
Checking coolant level	8-6	Wheels and tires	8-21
Changing coolant	8-6	Tire inflation pressure	8-21
Brakes	8-7	Types of tires	8-21
Checking parking brake	8-7	Tire chains	8-21
Brake pad wear warning	8-7	Tire rotation	8-21
Brake fluid	8-7	Tire wear and damage	8-22
Reduction gear fluid	8-8	Tire age	8-22
Wiper blades	8-8	Changing tires and wheels	8-22
Windshield wiper blades	8-8	Wheel balance	8-22
Rear window wiper blade	8-9	Spare tire (if equipped)	8-22
Window washer fluid	8-10	Emergency tire puncture repair kit (if equipped)	8-23
12-volt battery	8-11		
Checking 12-volt battery fluid level	8-12		

MAINTENANCE REQUIREMENT

Some day-to-day and regular maintenance is essential to maintain your vehicle's good mechanical condition, as well as its EV (Electric Vehicle) system performance.

It is the owner's responsibility to make sure that the specified maintenance, as well as general maintenance, is performed.

As the vehicle owner, you are the only one who can ensure that your vehicle receives the proper maintenance care.

SCHEDULED MAINTENANCE

For your convenience, the required scheduled maintenance items are described and listed in a separate Warranty Information and Maintenance booklet. You must refer to that booklet to ensure that necessary maintenance is performed on your vehicle at regular intervals.

GENERAL MAINTENANCE

General maintenance includes those items which should be checked during normal day-to-day operation of the vehicle. They are essential if your vehicle is to continue to operate properly. It is your responsibility to perform these procedures regularly as prescribed.

Performing general maintenance checks requires minimal mechanical skill and only a few general automotive tools.

These checks or inspections can be done by yourself, a qualified technician or, if you prefer, a NISSAN certified LEAF dealer.

WHERE TO GO FOR SERVICE

If maintenance service is required or your vehicle appears to malfunction, have the systems checked and serviced by a NISSAN certified LEAF dealer.

GENERAL MAINTENANCE

During the normal day-to-day operation of the vehicle, general maintenance should be performed regularly as prescribed in this section. If you detect any unusual sounds, vibrations or smells, be sure to check for the cause or have a NISSAN certified LEAF dealer do it promptly. In addition, you should notify a NISSAN certified LEAF dealer if you think that repairs are required.

When performing any checks or maintenance work, closely observe "Maintenance precautions" (P.8-4).

EXPLANATION OF MAINTENANCE ITEMS

Additional information on the following items with "" is found later in this section.

Outside vehicle

The maintenance items listed here should be performed from time to time, unless otherwise specified.

Doors and hood:

Check that all doors and the hood operate smoothly as well as the back door, trunk lid and hatch. Also make sure that all latches lock securely. Lubricate if necessary. Make sure that the secondary latch keeps the hood from opening when the primary latch is released. When driving in areas using road salt or other corrosive materials, check lubrication frequently.

Lights*:

Clean the headlights on a regular basis. Make sure that the headlights, stop lights, tail lights, turn signal lights, and other lights are all operating properly and installed securely. Also check the aim of the headlights.

Tires*:

Check the pressure with a gauge often and always prior to long distance trips. Adjust the pressure in all tires, including the spare, to the pressure specified. Check carefully for damage, cuts or excessive wear.

Tire rotation*:

In the case that Two-Wheel Drive (2WD) and front and rear tires are same size; tires should be rotated every 10,000 km (6,000 miles). Tires marked with directional indicators can only be rotated between front and rear. Make sure that the directional indicators point in the direction of wheel rotation after the tire rotation is completed.

In the case that Four-Wheel Drive and All Wheel Drive (4WD/AWD) and front and rear tires are same size; tires should be rotated every 5,000 km (3,000 miles). Tires marked with directional indicators can only be rotated between front and rear. Make sure that the directional indicators point in the direction of wheel rotation after the tire rotation is completed.

In the case that front tires are different size from rear tires; tires cannot be rotated.

The timing for tire rotation may vary according to your driving habits and the road surface conditions.

Tire Pressure Monitoring System (TPMS) transmitter components (if so equipped):

Replace the TPMS transmitter grommet seal, valve core and cap when the tires are replaced due to wear or age.

Wheel alignment and balance:

If the vehicle should pull to either side while driving on a straight and level road, or if you detect uneven or abnormal tire wear, there may be a need for wheel alignment. If the steering wheel or seat vibrates at normal highway speeds, wheel balancing may be needed.

Windshield:

Clean the windshield on a regular basis. Check the windshield at least every six months for cracks or other damage. Repair as necessary.

Wiper blades*:

Check for cracks or wear if not functioning correctly. Replace as necessary.

Inside vehicle

The maintenance items listed here should be checked on a regular basis, such as when performing periodic maintenance, cleaning the vehicle, etc.

Accelerator pedal:

Check the pedal for smooth operation and make sure that the pedal does not catch or require uneven effort. Keep the floor mats away from the pedal.

Brake pedal*:

Check the pedal for smooth operation and make sure that it is the proper distance from the floor mat when depressed fully. Be sure to keep the floor mats away from the pedal.

Parking brake*:

Check the parking brake operation regularly. Check that the lever (if so equipped) or the pedal (if so equipped) has the proper travel. Also make sure that the vehicle is held securely on a fairly steep hill when only the parking brake is applied.

Seat belts:

Check that all parts of the seat belt system (for example, buckles, anchors, adjusters and retractors) operate properly and smoothly, and are installed securely. Check the belt webbing for cuts, fraying, wear or damage.

Steering wheel:

Check for changes in the steering condition, such as excessive play, hard steering or strange noises.

Warning lights and chimes:

Make sure that all warning lights and chimes are operating properly.

Windshield defogger:

Check that the air comes out of the defogger outlets properly and in good quantity when operating the heater or air conditioner.

Windshield wiper and washer*:

Check that the wipers and washer operate properly and that the wipers do not streak.

Under hood and vehicle

The maintenance items listed here should be checked periodically.

MAINTENANCE PRECAUTIONS

12-volt Battery (except for maintenance free batteries)*:

Check the fluid level in each cell. It should be between the UPPER and LOWER lines. Vehicles operated in high temperatures or under severe conditions require frequent checks of the battery fluid level.

Brake fluid level*:

Make sure that the brake fluid level is between the MAX and MIN lines on the reservoir.

Coolant level*:

Check the coolant level when the high voltage parts are cold. Make sure that the coolant level is between the MAX and MIN lines on the reservoir.

Fluid leaks:

Check under the vehicle for oil, water or other fluid leaks after the vehicle has been parked for a while. Water dripping from the air conditioner after use is normal. If you should notice any leaks, check for cause and have it corrected immediately.

Windshield washer fluid*:

Check that there is adequate fluid in the reservoir.

When performing any inspection or maintenance work on your vehicle, always take care to prevent serious accidental injury to yourself or damage to the vehicle. The following are general precautions that should be closely observed.



WARNING:

- The EV (Electric Vehicle) system uses high voltage up to approximately DC 400 volt. The system can be hot during and after starting and when the vehicle is shut off. Be careful of both the high voltage and the high temperature. Obey the labels that are attached to the vehicle.
- Never disassemble, remove or replace high-voltage parts and cables as well as their connectors. High-voltage cables are colored orange.
- Disassembling, removing or replacing those parts or cables can cause severe burns or electric shock that may result in serious injury or death. The vehicle high voltage system has no user serviceable parts. Take your vehicle to the NISSAN certified LEAF dealer for any necessary maintenance.
- Park the vehicle on a level surface, apply the parking brake securely and chock the wheels to prevent the vehicle from moving. Push the P position switch on the shift lever or place the vehicle into the N (Neutral) position.
- If you must work with the EV (Electric vehicle) system is turned on, keep hands, clothing, hair and tools away from moving fans and any other moving parts.

- Make sure that the power switch is in the OFF or LOCK position when performing any part replacement or repairs.
- It is advisable to secure or remove any loose clothing and remove any jewelry, such as rings, watches, etc. before working on your vehicle.
- Always wear eye protection whenever you work on your vehicle.
- Never get under the vehicle while it is supported by a jack.
- Keep smoking materials, flames and sparks away from the 12-volt battery.



CAUTION:

- Do not work under the hood while the motor compartment is hot. Push the power switch in the OFF position and wait until it cools down.
- Avoid direct contact with used coolant. Improperly disposed coolant and/or other vehicle fluids can damage the environment. Always conform to local regulations for the disposal of vehicle fluids.
- Never connect or disconnect the battery or any transistorized component while the power switch is in the ON position.
- Your vehicle is equipped with an automatic cooling fan. It may come on at any time without warning, even if the power switch is not in the ACC, ON or READY to drive position. To avoid injury, always disconnect the negative 12-volt battery cable before working near the fan.
- Before performing any electrical maintenance work on the vehicle such as the battery, fuses or bulb replacement, con-

MOTOR COMPARTMENT CHECK LOCATIONS

firm the following:

- The charge connector is removed from the vehicle.
- The Climate Ctrl. Timer is not active or operating. See "Climate Ctrl. Timer" (P.4-17).
- The 12-volt battery is not being charged by the Li-ion battery and that all charging status indicator lights are off, see "Charging the 12-volt battery" (P.EV-4) and "Charging status indicator lights" (P.CH-20).
- The power switch is in the OFF position. Place the power switch in the ON position and then in the OFF position to prevent the 12-volt battery automatically being charged by the Li-ion battery. See "Charging the 12-volt battery" (P.EV-4).

This "8. Maintenance and do-it-yourself" section gives instructions regarding only those items that are relatively easy for an owner to perform.

You should be aware that incomplete or improper servicing may result in operating difficulties and could affect your warranty coverage. **If in doubt about any servicing, we recommend that it be done by a NISSAN certified LEAF dealer.**

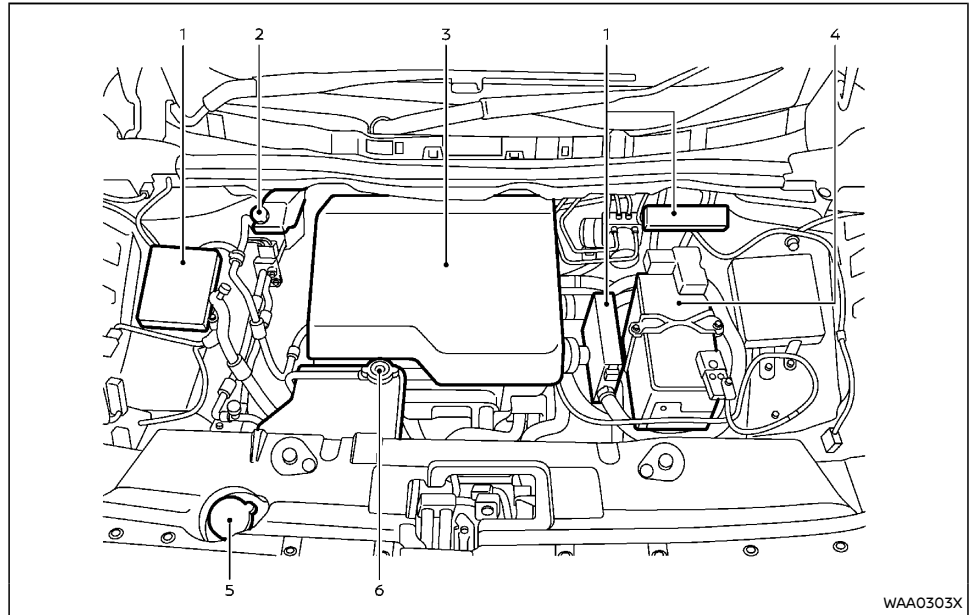

WAA0303X

1. Fuse/fusible link holders
2. Brake fluid reservoir
3. Power Delivery Module (PDM)
4. 12-volt battery
5. Window washer fluid reservoir
6. Coolant tank cap

COOLING SYSTEM

WARNING:

- Never remove the coolant tank cap when the motor compartment is hot. Wait until the motor compartment cools down.
- Coolant is poisonous and should be stored carefully in marked containers out of the reach of children.

The cooling system is filled at the factory with a high-quality, year-round, anti-freeze coolant solution. The anti-freeze solution contains rust and corrosion inhibitors, therefore additional cooling system additives are not necessary.

CAUTION:

- Never use any additives in the coolant such as radiator sealer in the cooling system. This may cause damage to electrical equipment such as the motor and inverter.
- When adding or replacing coolant be sure to use only a Genuine NISSAN Coolant or equivalent with the proper mixture ratio of 50% antifreeze and 50% demineralized or distilled water. The use of other types of coolant solutions may damage the high voltage parts cooling system.

Use Genuine NISSAN Coolant or equivalent in its quality. Genuine NISSAN Coolant is a pre-mixed (mixture ratio 50%) type coolant.

The coolant tank is equipped with a special type coolant tank cap. To minimize the risk of damage to the motor compartment, NISSAN recommends the use of genuine NISSAN coolant tank cap.

CHECKING COOLANT LEVEL

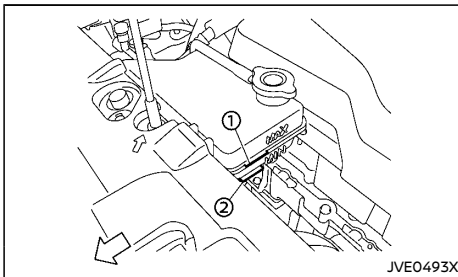

Check the coolant level in the reservoir when the high voltage parts are cold. If the coolant level is below the MIN level ②, open the reservoir cap and add coolant up to the MAX level ①. If the reservoir is empty, check the coolant level in the coolant tank when the high voltage parts are cold. If there is insufficient coolant in the coolant tank, fill the coolant tank with coolant up to the reservoir cap opening and also add it to the reservoir up to the MAX level ①.

Tighten the cap securely after adding coolant.

If the cooling system frequently requires coolant, have it checked by a NISSAN certified LEAF dealer.

CHANGING COOLANT

Contact a NISSAN certified LEAF dealer if replacement is required.

Major cooling system repairs should be performed by a NISSAN certified LEAF dealer. The service procedures can be found in the appropriate NISSAN Service Manual.

Improper servicing can result in reduced heater performance.

WARNING:

- To avoid the danger of being scalded, never change the coolant when the motor compartment is hot.
- Never remove the coolant tank cap when the motor compartment is hot. Serious burns could be caused by high-pressure fluid escaping from the tank.
- Avoid direct skin contact with used coolant. If skin contact is made, wash thoroughly with soap or hand cleaner as soon as possible.
- Keep coolant out of reach of children and pets.

Coolant must be disposed of properly. Check your local regulations.

BRAKES

If the brakes do not operate properly, have the brakes checked by a NISSAN certified LEAF dealer.

WARNING:

Do not adjust the height of the brake pedal. Doing so could alter the effectiveness of the brakes, which could result in a serious accident and personal injury. If adjustment is required, contact a NISSAN certified LEAF dealer.

CHECKING PARKING BRAKE

Pedal type

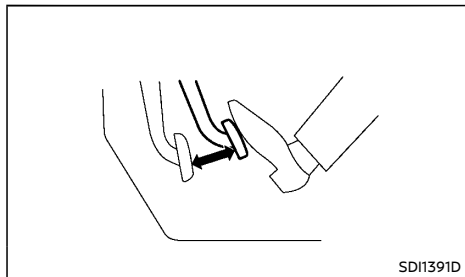

From the released position, depress the parking brake pedal slowly and firmly. If the number of clicks is out of the range listed, see a NISSAN certified LEAF dealer.

6 to 7 clicks under a depressing force of 196 N (20 kg, 44 lb)

Switch type

Periodically check the holding ability of the parking brake by parking on a steep hill and restraining the vehicle by using only the parking brake. If it does not hold satisfactorily, see a NISSAN certified LEAF dealer.

BRAKE PAD WEAR WARNING

The disc brake pads have audible wear warnings. When a brake pad requires replacement, it will make a high pitched scraping sound when the vehicle is in motion. This scraping sound will first occur only when the brake pedal is depressed. After more wear of the brake pad, the sound will always be heard even if the brake pedal is not depressed. Have the brakes checked as soon as possible if the wear warning sound is heard.

Under some driving or climate conditions, occasional brake squeak, squeal or other noise may be heard. Occasional brake noise during light to moderate stops is normal and does not affect the function or performance of the brake system.

Proper brake inspection intervals should be followed. For additional information, see a separate maintenance booklet.

BRAKE FLUID

WARNING:

- **Use only new fluid from a sealed container. Old, inferior or contaminated fluid may damage the brake system. The use of improper fluids can damage the brake system, and affect the vehicle's stopping ability.**
- **Clean the filler cap before removing.**
- **Brake fluid is poisonous and should be stored carefully in marked containers out of the reach of children.**
- **Do not overfill the brake fluid reservoir. Overfilling can damage the brake system.**

CAUTION:

Do not spill the fluid on any painted surfaces. This will damage the paint. If fluid is spilled, immediately wash the surface with water.

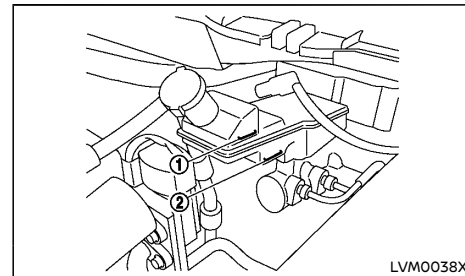

Check the fluid level in the reservoir. If the fluid is below the MIN line ②, the brake warning light will illuminate. Add fluid up to the MAX line ①. (See "Recommended fluids/lubricants and capacities" (P.9-2) for recommended types of fluid.)

REDUCTION GEAR FLUID

If fluid must be added frequently, the system should be thoroughly checked by a NISSAN certified LEAF dealer.

When checking or replacement is required, we recommend a NISSAN certified LEAF dealer for servicing.



CAUTION:

- **Use only Genuine NISSAN Matic S ATF. Do not mix with other fluids.**
- **Using reduction gear fluid other than Genuine NISSAN Matic S ATF will cause deterioration in driveability and reduction gear durability, and may damage the reduction gear, which is not covered by the warranty.**

WIPER BLADES

WINDSHIELD WIPER BLADES

Cleaning

If the windshield does not become clear after using the windshield washer or if the wiper blades chatter when operating the windshield wipers, wax or other materials may be on the windshield and/or wiper blades.

Clean the outside of the windshield surface with a washer solution or mild detergent. Your windshield is clean if beads do not form when rinsing with water.

Clean the blade by wiping it with a cloth soaked in a washer solution or a mild detergent. Rinse the blade with water. If your windshield is still not clear after cleaning the blades and using the wipers, replace the blades.

Be careful not to clog the washer nozzle. This may cause improper windshield washer operation. If the nozzle is clogged, contact a NISSAN certified LEAF dealer.

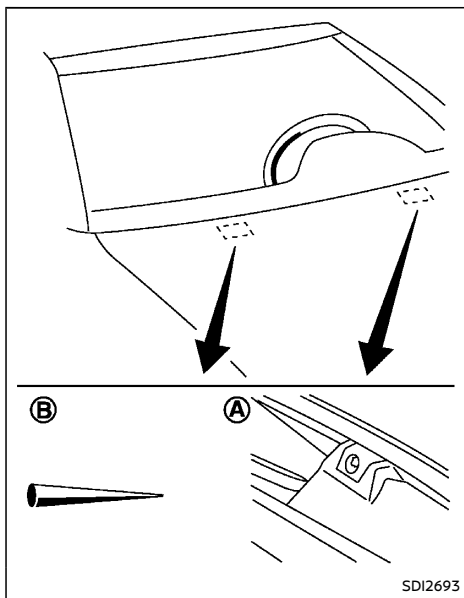

SDI2693

Be careful not to clog the washer nozzle (A). This may cause improper windshield washer operation. If the nozzle is clogged, remove any objects with a needle or small pin (B). Be careful not to damage the nozzle.

Replacing

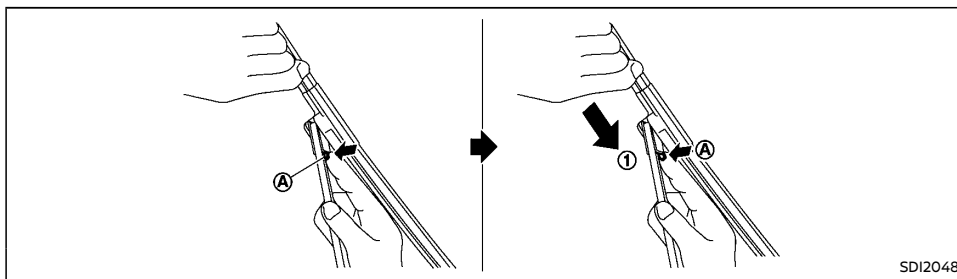

SDI2048

1. Lift the wiper arm away from the windshield.
2. Push the release tab (A), and move the wiper blade down the wiper arm (1) while pushing the release tab to remove.
3. Insert the new wiper blade onto the wiper arm until a click sounds.
4. Rotate the wiper blade so that the dimple is in the groove.

REAR WINDOW WIPER BLADE

Contact a NISSAN certified LEAF dealer if checking or replacement is required.



CAUTION:

- **After wiper blade replacement, return the wiper arm to its original position. Otherwise the wiper arm or the hood may be scratched and may cause damage when the hood is opened.**
- **Worn windshield wiper blades can damage the windshield and impair driver vision.**

WINDOW WASHER FLUID

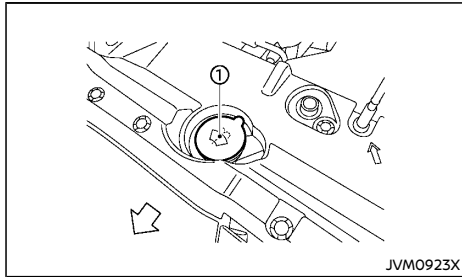

WARNING:

Anti-freeze is poisonous and should be stored carefully in marked containers out of the reach of children.







To check the fluid level, use your finger to plug the center hole ① of the cap/tube assembly, then remove it from the reservoir. If there is no fluid in the tube, add fluid.

To fill the window washer fluid reservoir, lift the cap and pour the window washer fluid into the reservoir opening.

Add a washer solvent to the washer for better cleaning. In the winter season, add a windshield washer anti-freeze. Follow the manufacturer's instructions for the mixture ratio.

Fill the window washer fluid reservoir periodically.

12-VOLT BATTERY

Caution symbols for battery		⚠ WARNING	
①		No smoking, No exposed flames, No sparks	Never smoke around battery. Never expose battery to open flames or electrical sparks.
②		Shield eyes	Handle the battery cautiously. Always wear eye protection glasses to protect against explosion or battery acid.
③		Keep away from children	Never allow children to handle battery. Keep the battery out of the reach of children.
④		Battery acid	Do not allow battery fluid to contact your skin, eyes, fabrics, or painted surfaces. After handling the battery or battery cap, immediately wash your hands thoroughly. If the battery fluid gets into your eyes, or onto your skin or clothing, flush with water immediately for at least 15 minutes and seek medical attention. Battery fluid is acid. If the battery fluid gets into your eyes or onto your skin, it could cause loss of your eyesight or burns.
⑤		Note operating instructions	Before handling the battery, read this instruction carefully to ensure correct and safe handling.
⑥		Explosive gas	Hydrogen gas, generated by battery fluid, is explosive.

SD11573



WARNING:

Do not operate the vehicle if the fluid in the 12-volt battery is low. Low 12-volt battery fluid can cause a higher load on the 12-volt battery which can generate heat, reduce 12-volt battery life, and in some cases lead to an explosion.

CHECKING 12-VOLT BATTERY FLUID LEVEL

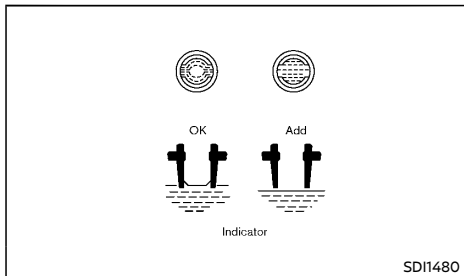
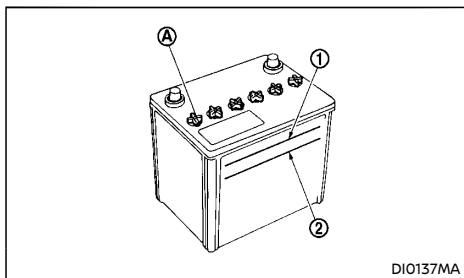

Check the fluid level in each cell. The 12-volt battery fluid level should be between the UPPER LEVEL ① and LOWER LEVEL ② lines.

If it is necessary to add fluid, add only demineralized/distilled water to bring the level to the indicator in each filler opening. Do not overfill.

1. Remove the cell plugs ①, if equipped.
2. Add demineralized/distilled water up to the UPPER LEVEL ① line.

3. Replace and tighten the cell plugs.
 - Vehicles operated in high temperatures or under severe conditions require frequent checks of the 12-volt battery fluid level.
 - Keep the 12-volt battery surface clean and dry. Clean the 12-volt battery with a solution of baking soda and water.
 - Make certain the terminal connections are clean and securely tightened.
 - If the vehicle is not to be used for more than 30 days, disconnect the negative (-) 12-volt battery terminal cable to prevent 12-volt battery discharge.

JUMP STARTING

Jump starting provides power to the 12 volt system to allow the electrical systems to operate. The electrical systems must be operating to allow the Li-ion battery to be charged. Jump starting does not charge the Li-ion battery. The Li-ion battery must be charged before the vehicle can be driven.

If jump starting is necessary, see "Jump starting" (P.6-9). If the power switch does not switch to READY to drive position by jump starting, the 12-volt battery may have to be replaced. Contact a NISSAN certified LEAF dealer.

INTELLIGENT KEY BATTERY REPLACEMENT



CAUTION:

- Be careful not to allow children to swallow the battery and removed parts.
- An improperly disposed battery can harm the environment. Always confirm local regulations for battery disposal.
- When changing batteries, do not let dust or oil get on the components.
- There is danger of explosion if the lithium battery is incorrectly replaced. Replace only with the same or equivalent type.

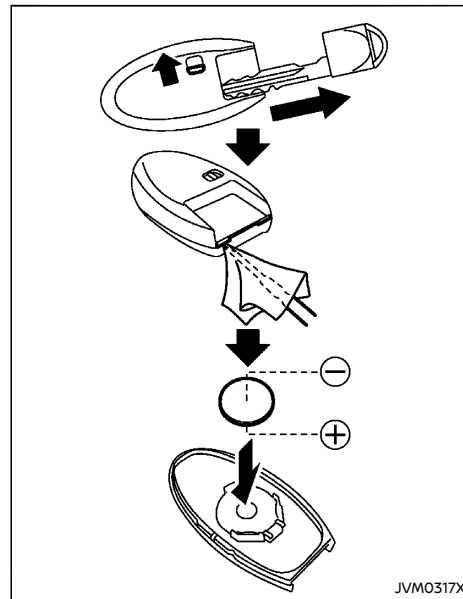

Replace the battery in the Intelligent Key as follows:

1. Remove the mechanical key from the Intelligent Key.
2. Insert a small screwdriver into the slit of the corner and twist it to separate the upper part from the lower part. Use a cloth to protect the casing.
3. Replace the battery with a new one.

Recommended battery:

CR2025 or equivalent

- Do not touch the internal circuit and electric terminals as doing so could cause a malfunction.
- Hold the battery by the edges. Holding the battery across the contact points will seriously deplete the storage capacity.
- Make sure that the ⊕ side faces the bottom of the case.

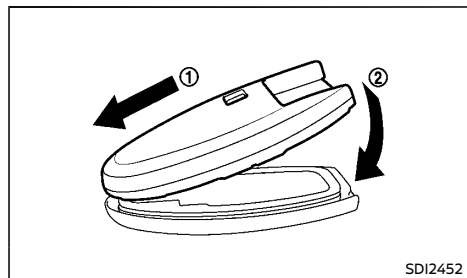

4. Align the tips of the upper and lower parts ①, and then push them together ② until it is securely closed.
5. Operate the buttons to check that it is functioning properly.

See a NISSAN certified LEAF dealer if you need

any assistance for replacement.

FUSES

MOTOR COMPARTMENT

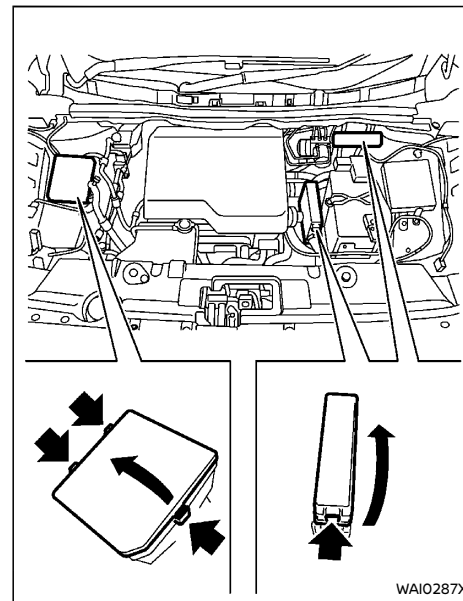

WARNING:

- Never touch, disassemble, remove or replace the high-voltage parts and cables, as well as their connectors. High-voltage cables are colored orange. Touching, disassembling, removing or replacing those parts and cables can cause severe burns or electric shock that may result in serious injury or death.



CAUTION:

Never use a fuse of a higher or lower amperage rating than that specified on the fuse box cover. This could damage the electrical system or cause a fire.

If any electrical equipment does not operate, check for an open fuse.

1. Confirm that the power switch and the headlight switch are turned off.
2. Open the hood.
3. Remove the fuse/fusible link holder cover by pushing the tab and lifting the cover.
4. Locate the fuse that needs to be replaced.
5. Remove the fuse using the fuse puller located in the passenger compartment fuse box.

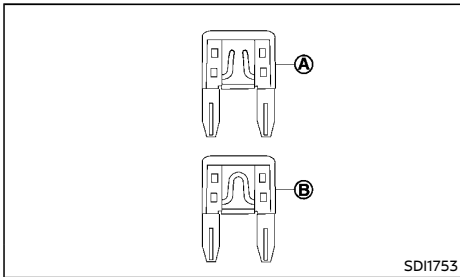

Type A

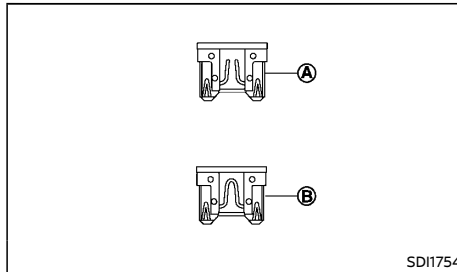

Type B

6. If the fuse is open (A), replace it with a new fuse (B).
7. If a new fuse also opens, have the electrical system checked, and if necessary repaired, by a NISSAN certified LEAF dealer.

Fusible links

If any electrical equipment does not operate and the fuses are in good condition, check the fusible links in the fuse/fusible link holders. If any of these fusible links are melted, replace with new parts.

For checking and replacing the fusible links in the holders, contact a NISSAN certified LEAF dealer.

PASSENGER COMPARTMENT

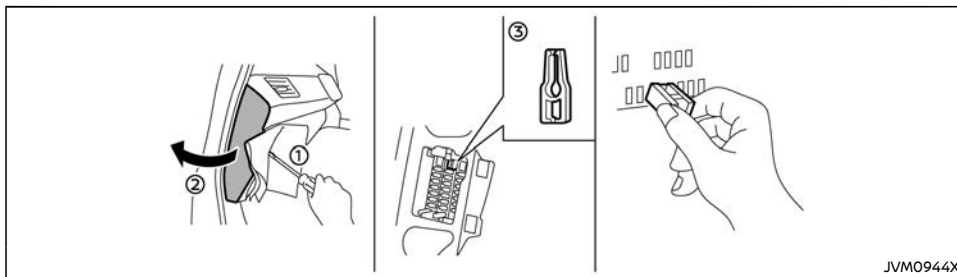

CAUTION:

Never use a fuse of a higher or lower amperage rating than that specified on the fuse box cover. This could damage the electrical system or cause a fire.

If any electrical equipment does not operate, check for an open fuse.

1. Make sure that the power switch and the headlight switch are turned off.
2. Insert a screwdriver wrapped with the cloth into the slit ①.
Use a cloth to protect the fuse box cover.
3. Then pull to remove the fuse box cover ②.
4. Remove the fuse with the fuse puller ③.

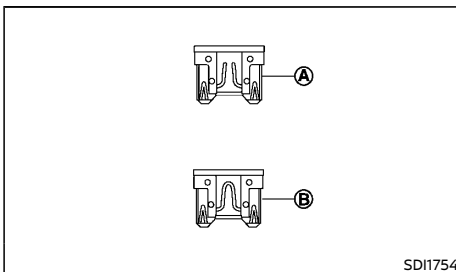

5. If the fuse is open ①, replace it with a new fuse ②.
6. If a new fuse also opens, have the electrical system checked, and if necessary repaired, by a NISSAN certified LEAF dealer.

LIGHTS

Fog may temporarily form inside the lens of the exterior lights in the rain or in a car wash. A temperature difference between the inside and the outside of the lens causes the fog. This is not a malfunction. If large drops of water collect inside the lens, contact a NISSAN certified LEAF dealer.

HEADLIGHTS

Replacing LED headlights (if equipped)

If replacement is necessary, see a NISSAN certified LEAF dealer.

Replacing halogen headlights (if equipped)

The halogen headlight is a semi-sealed beam type that uses a replaceable bulb.



CAUTION:

- Do not leave the bulb out of the headlight reflector for a long period of time. Dust, moisture, smoke, etc. entering the headlight body may affect bulb performance.
- High-pressure halogen gas is sealed inside the halogen bulb. The bulb may break if the glass envelope is scratched or the bulb is dropped.
- Only touch the base when handling the bulb. Never touch the glass envelope. Touching the glass envelope could significantly affect bulb life and/or headlight performance.
- Aiming is not necessary after replacing the bulb. When aiming adjustment is necessary, contact a NISSAN certified LEAF dealer.

Use the same number and wattage as originally installed as shown in the chart.

Low-beam:

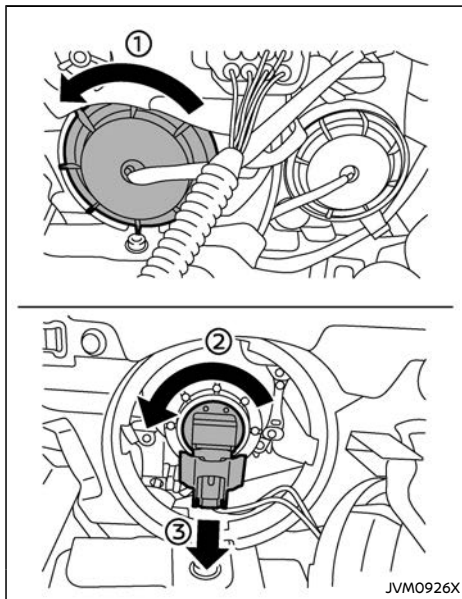

Disconnect the battery negative cable before replacing bulbs.

1. Turn the cover counterclockwise ① and remove it.
2. Remove the headlight bulb by turning it counterclockwise ②. Do not shake or rotate the bulb when removing it.
3. Disconnect the electrical connector ③ from the rear end of the bulb.

4. Install the new bulb in the reverse order of removal.

If any assistance is required, contact a NISSAN certified LEAF dealer.

High-beam:

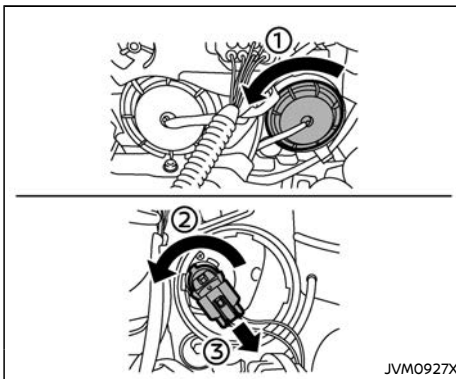

Disconnect the battery negative cable before replacing bulbs.

1. Turn the cover counterclockwise ① and remove it.
2. Remove the headlight bulb by turning it counterclockwise ②. Do not shake or rotate the bulb when removing it.
3. Disconnect the electrical connector ③ from the rear end of the bulb.
4. Install the new bulb in the reverse order of removal.

If any assistance is required, contact a NISSAN certified LEAF dealer.

EXTERIOR AND INTERIOR LIGHTS

Item	Wattage (W)
Headlight low beam (models with LED headlights)*	LED
Headlight high beam (models with LED headlights)*	LED
Headlight low beam (models with halogen headlights)	55
Headlight high beam (models with halogen headlights)	60
Front turn signal light	21
Front fog light* (if equipped)	35
Clearance light (models with halogen headlights)	5
Clearance light/Daytime running lights (models with LED headlights)*	LED
Charge port lid light*	LED
Emblem light* (if equipped)	LED
Side turn signal light	
Fender type	5
Outside rearview mirror type*	LED
Rear combination light	
turn signal	21
stop/tail*	LED
back-up	16
Rear fog light (if equipped)	21
License plate light* (if equipped)	5
High-mounted stop light*	LED
Map light	10
Room light	8
Cargo light	5
Grove box light*	1.4

*: Contact a NISSAN certified LEAF dealer for replacement.

LIGHT LOCATIONS

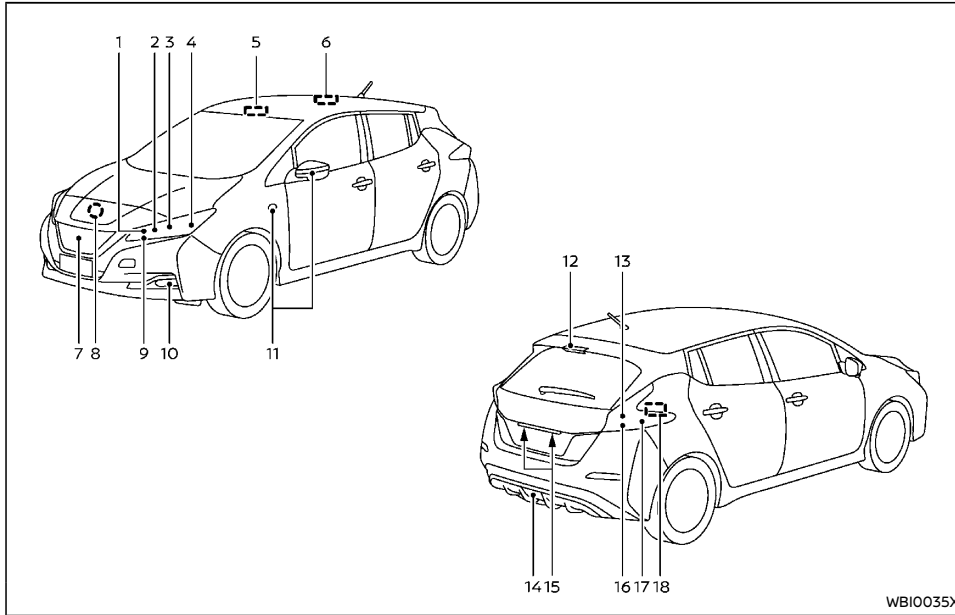

1. Clearance light *1
2. Clearance light *2/Daytime running light (if equipped)
3. Headlight (high-beam)
4. Headlight (low-beam)
5. Map light
6. Room light
7. Emblem light (if equipped)
8. Charge port lid light
9. Front turn signal light
10. Front fog light (if equipped)
11. Side turn signal light (on the front fender or the outside rearview mirror)
12. High-mounted stop light

13. Stop/tail light
14. Rear fog light (if equipped)
15. License plate light
16. Reverse light
17. Rear turn signal light
18. Cargo light

*1: Models with halogen headlights

*2: Models with LED headlights

Replacement procedures

All other lights are either type A, B, C, D or E.
When replacing a bulb, first remove the lens and/or cover.

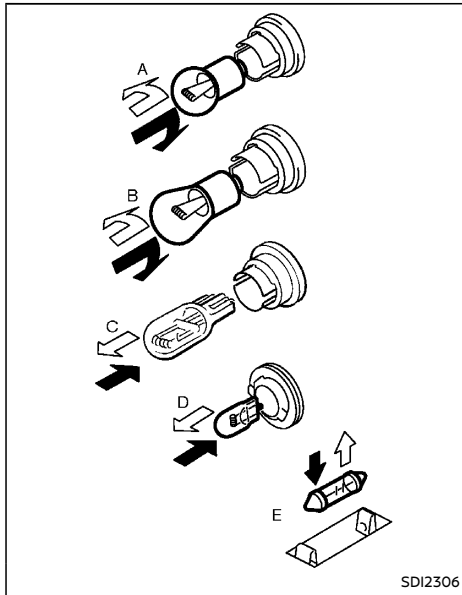

SDI2306

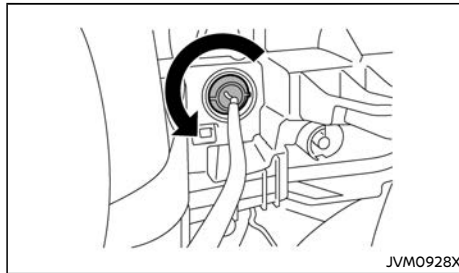

JVM0928X

Front turn signal light

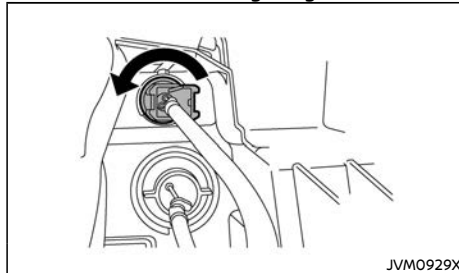

JVM0929X

Clearance light (models with halogen headlights)

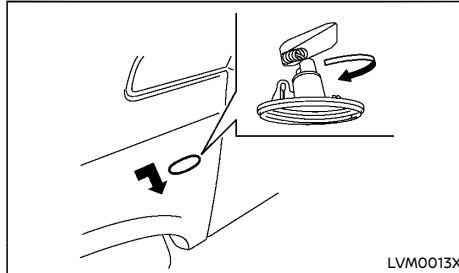

LVM0013X

Side turn signal light (fender type)

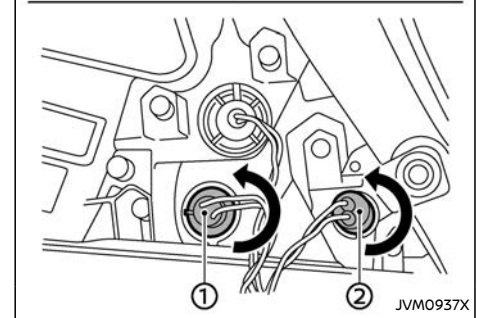
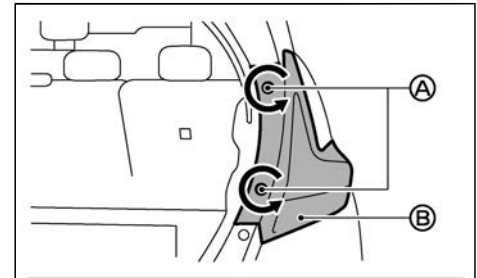

JVM0937X

Rear combination light

1. Open the rear hatch.
2. Remove the bolts A.
3. Pull the rear combination light assembly B straight toward rear of the vehicle.
4. Turn the bulb socket and then remove the bulb (1 turn signal light, 2 reverse light).
5. Install the new bulb and the rear combination light assembly in the reverse order of removal.

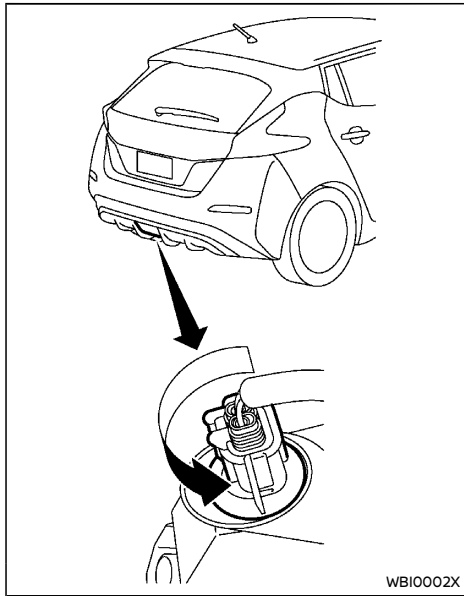

Rear fog light (if equipped)

WBI0002X

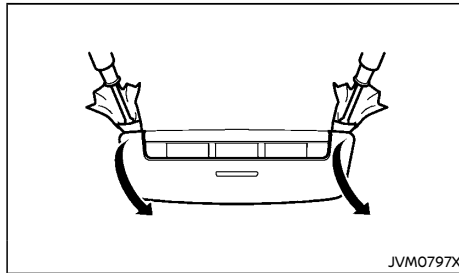

Map light

JVM0797X

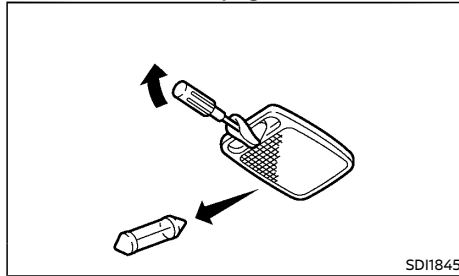

Room light

SD11845

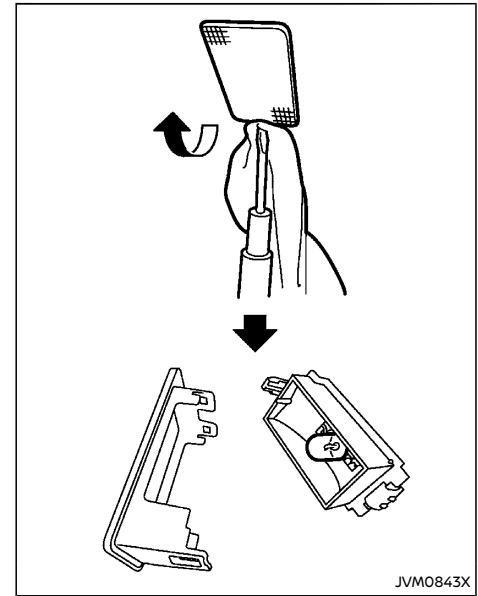

Cargo light

JVM0843X

WHEELS AND TIRES

If you have a flat tire, see "Flat tire" (P.6-2).

TIRE INFLATION PRESSURE

Periodically check the pressure of the tires. An incorrect tire pressure may adversely affect tire life and vehicle handling. The tire pressure should be checked when tires are COLD. Tires are considered COLD after the vehicle has been parked for 3 or more hours, or driven less than 1.6 km (1 mile). COLD tire pressures are shown on the tire placard.

Insufficient pressure can lead to an overheating of the tire and subsequent internal damage. At high speeds, this could result in tread separation and even bursting of the tire.

TYPES OF TIRES



WARNING:

When changing or replacing tires, be sure all four tires are of the same type (Example: Summer, All Season or Snow) and construction. A NISSAN certified LEAF dealer may be able to help you with information about tire type, size, speed rating and availability.

Replacement tires may have a lower speed rating than the factory equipped tires, and may not match the potential maximum vehicle speed. Never exceed the maximum speed rating of the tire.

All season tires

NISSAN specifies all season tires on some models to provide good performance all year, including snowy and icy road conditions. All Season tires are identified by ALL SEASON and/or M&S (Mud and Snow) on the tire sidewall. Snow tires have better snow traction than All Season tires and may be more appropriate in some areas.

Summer tires

NISSAN specifies summer tires on some models to provide superior performance on dry roads. Summer tire performance is substantially reduced in snow and ice. Summer tires do not have the tire traction rating M&S on the tire sidewall.

If you plan to operate your vehicle in snowy or icy conditions, NISSAN recommends the use of SNOW tires or ALL SEASON tires on all four wheels.

Snow tires

If snow tires are needed, it is necessary to select tires equivalent in size and load rating to the original equipment tires. If you do not, it can adversely affect the safety and handling of your vehicle.

If you install snow tires, they must be the same size, brand, construction and tread pattern on all four wheels.

For additional traction on icy roads, studded tires may be used. However, some states and provinces prohibit their use. Check local, state and provincial laws before installing studded tires. Skid and traction capabilities of studded snow tires, on wet or dry surfaces, may be poorer than that of non-studded snow tires.

TIRE CHAINS

Use of tire chains may be prohibited according to location. Check the local laws before installing tire chains. When installing tire chains, make sure they are the proper size for the tires on your vehicle and are installed according to the chain manufacturer's suggestions.

Use chain tensioners when recommended by the tire chain manufacturer to ensure a tight fit. Loose end links of the tire chain must be

secured or removed to prevent the possibility of whipping action damage to the fenders or underbody. If possible, avoid fully loading your vehicle when using tire chains. In addition, drive at a reduced speed. Otherwise, your vehicle may be damaged and/or vehicle handling and performance may be adversely affected.

Tire chains must be installed only on the front wheels and not on the rear wheels.

Never install tire chains on a T-type spare tire (TEMPORARY USE ONLY) (if equipped).

Do not use tire chains on dry roads. Driving with tire chains in such conditions can cause damage to the various mechanisms of the vehicle due to some overstress.

TIRE ROTATION

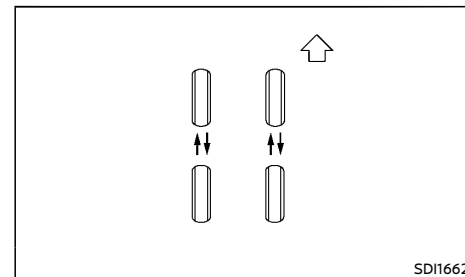

NISSAN recommends that tires be rotated every 10,000 km (6,000 miles). However, the timing for tire rotation may vary according to your driving habits and the road surface conditions. (See "Flat tire" (P.6-2) for the tire replacement.)

WARNING:

- After rotating the tires, check and adjust the tire pressure.
- Retighten the wheel nuts when the vehicle has been driven for 1,000 km (600 miles) (also in cases of a flat tire, etc.).
- Do not include the T-type spare tire (if equipped) in tire rotation.
- Incorrect tire selection, fitting, care or maintenance can affect vehicle safety with risk of accident and injury. If in doubt, consult a NISSAN certified LEAF dealer or the tire manufacturer.

TIRE WEAR AND DAMAGE

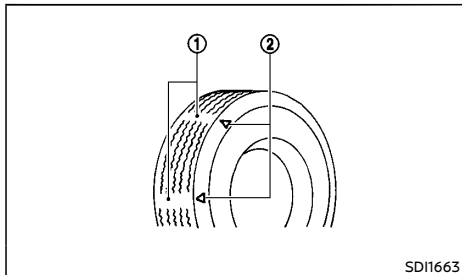

- ① Wear indicator
- ② Wear indicator location marks. The locations are shown by "Δ", "TWI", etc. depending on tire types.

Tires should be periodically inspected for wear, cracking, bulging or objects caught in the tread. If excessive wear, cracks, bulging or deep cuts are found, the tire should be replaced immediately.

The original tires have a built-in tread wear

indicator. When the wear indicator is visible, the tire should be replaced.

Improper service of a spare tire (if equipped) may result in serious personal injury. If it is necessary to repair the spare tire, contact a NISSAN certified LEAF dealer.

TIRE AGE

Never use a tire over six years old, regardless of whether it has been used or not.

Tires degrade with age as well as with the vehicle usage. Have your tires checked and balanced often by a repair shop or, if you prefer, a NISSAN certified LEAF dealer.

CHANGING TIRES AND WHEELS

WARNING:

Do not install a deformed wheel or tire even if it has been repaired. Such wheels or tires could have structural damage and could fail without warning.

When replacing a tire, use the same size, tread design, speed rating and load carrying capacity as originally equipped. See "Specifications" (P.9-4) for recommended by NISSAN types and sizes of tires and wheels. The use of tires other than those that match the quality of those recommended or the mixed use of tires of different brands, construction (bias, bias-belted or radial), or tread patterns can adversely affect the ride, braking, handling, ground clearance, body-to-tire clearance, tire chain clearance, speedometer calibration, headlight aim and bumper height. Some of these effects may lead to accidents and could result in serious personal injury.

If the wheels are changed for any reason, always replace with wheels which have the

same off-set dimension. Wheels of a different off-set could cause premature tire wear, degrade vehicle handling characteristics and/or interference with the brake discs/drums. Such interference can lead to decreased braking efficiency and/or early brake pad/shoe wear. See "Wheels and tires" (P.9-5) for wheel off-set dimensions.

WHEEL BALANCE

Unbalanced wheels may affect vehicle handling and tire life. Even with regular use, wheels can get out of balance. Therefore, they should be balanced as required.

SPARE TIRE (if equipped)

Temporary-use (T-type) spare tire

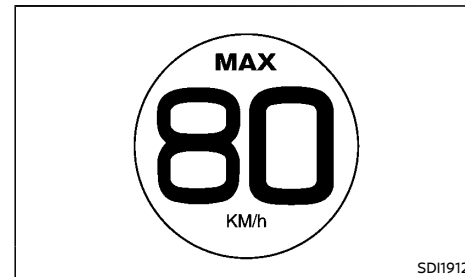

Spare tire label (if equipped)

Observe the following precautions if the T-type spare tire must be used, otherwise your vehicle could be damaged or involved in an accident.

CAUTION:

- The T-type spare tire should be used only for emergency. It should be replaced by the standard tire at the first opportunity.

- **Drive carefully while the T-type spare tire is installed.**
- **Avoid sharp turns and abrupt braking while driving.**
- **Periodically check the T-type spare tire inflation pressure, and always keep it at 420 kPa (4.2 bar, 60 psi).**
- **Do not drive your vehicle at speeds faster than 80 km/h (50 MPH).**
- **Do not use tire chains on a T-type spare tire. Tire chains will not fit properly on the T-type spare tire and may cause damage to the vehicle.**
- **Tire tread of the T-type spare tire will wear at a faster rate than the original tire. Replace the T-type spare tire as soon as the tread wear indicators appear.**
- **Because the T-type spare tire is smaller than the original tire, ground clearance is reduced. To avoid damage to the vehicle do not drive over obstacles. Also do not drive the vehicle through an automatic car wash since it may get caught.**
- **Do not use the T-type spare tire on other vehicles.**
- **Do not use more than one T-type spare tire at the same time.**

EMERGENCY TIRE PUNCTURE REPAIR KIT (if equipped)

The emergency tire puncture repair kit is supplied to the vehicle instead of a spare tire. The kit must be used for temporarily fixing a minor tire puncture. After using the repair kit, see a NISSAN certified LEAF dealer as soon as possible for tire inspection and repair/replacement.

See "Flat tire" (P.6-2) for more details.

MEMO

9 Technical information

Recommended fluids/lubricants and capacities	9-2	Vehicle Identification Number (VIN)	9-6
Air conditioner system refrigerant and lubricant recommendations	9-3	Traction motor serial number	9-6
Specifications	9-4	Tire placard	9-6
Charging system	9-4	Air conditioner specification label	9-7
Motor	9-5	Installation of an RF-transmitter	9-7
Wheels and tires	9-5	Radio approval number and information	9-8
Dimensions	9-5	For Thailand	9-8
When travelling or registering in another country	9-6	For Malaysia	9-8
Vehicle identification	9-6	For Singapore	9-9
Vehicle identification plate	9-6	For Indonesia	9-10
		For Mauritius	9-11



RECOMMENDED FLUIDS/ LUBRICANTS AND CAPACITIES

The following are approximate capacities. The actual refill capacities may be slightly different. When refilling, follow the procedure that is described in the "8. Maintenance and do-it-yourself" section to determine the proper refill capacity.

Fluid type		Capacity (approximate)			Recommended Fluids/Lubricants
		Metric Measure	US Measure	Imperial Measure	
Cooling system coolant	With reservoir	4.6 L	4-7/8 qt	4 qt	<ul style="list-style-type: none"> · Genuine NISSAN Coolant (blue) or equivalent · Use Genuine NISSAN Coolant or equivalent in its quality, in order to avoid possible aluminum corrosion within the cooling system caused by the use of non-genuine coolant. Note that any repairs for the incidents within the cooling system while using non-genuine coolant may not be covered by the warranty even if such incidents occurred during the warranty period.
	Reservoir	0.5 L	1/2 qt	1/2qt	
Reduction gear fluid		1.4 L	1-1/2 qt	1-1/4 qt	<ul style="list-style-type: none"> · Genuine NISSAN Matic S ATF · Using reduction gear fluid other than Genuine NISSAN Matic S ATF will cause deterioration in driveability and reduction gear durability, and may damage the reduction gear, which is not covered by the warranty.
Brake fluid		Refill to the proper oil level according to the instructions in the "8. Maintenance and do-it-yourself" section.			<ul style="list-style-type: none"> · Genuine NISSAN Brake Fluid or equivalent DOT 3
Multi-purpose grease		—	—	—	<ul style="list-style-type: none"> · NLGI No. 2 (Lithium soap base)
Air conditioning system refrigerant		—	—	—	<ul style="list-style-type: none"> · HFC-134a (R-134a)
Air conditioning system lubricants		—	—	—	<ul style="list-style-type: none"> · Compressor Oil AE10 or equivalent

AIR CONDITIONER SYSTEM REFRIGERANT AND LUBRICANT RECOMMENDATIONS

The air conditioner system of your vehicle must be charged with the refrigerant HFC-134a (R134a) and the lubricant AE10 or equivalents.

The release of refrigerants into the atmosphere is prohibited in many countries and regions. The refrigerant HFC-134a (R-134a) in your vehicle will not harm the Earth's ozone layer. However, it may contribute in a small part to the global warming effect. NISSAN recommends that the refrigerant be appropriately recovered and recycled. Contact a NISSAN certified LEAF dealer when servicing the air conditioner system.

SPECIFICATIONS

CHARGING SYSTEM

Rated input voltage	AC220V - AC240V (single phase)
Rated input frequency	50Hz
Maximum rated current	18A or 30A (if equipped)
Sensitive current of GFI (Ground Fault Interrupter) circuit breaker in NISSAN Genuine portable type EVSE (Electric Vehicle Supply Equipment) (if equipped)	15mA
Charging modes / Type of connection	Mode 2 / Case B (Normal charge with NISSAN Genuine portable type EVSE - if equipped) Mode 3 / Case B/C (Normal charge with public charging station, etc.) Mode 4 / Case C (Quick charge, V2X charge/discharge)
Required installation (over current protection)	The methods of protection against over current and over voltage shall be in accordance with national codes. Suitable over current protection devices for the wiring of houses or buildings shall be installed.
IP Degree	IP44: When the NISSAN EVSE (if equipped) is connected to the normal charge port.
Operating temperature	Same as vehicle operating temperature
Storage temperature	Same as vehicle storage temperature
Altitude	Up to 3,000 m (9,843 ft)
Applicable standard	EN61851-1:2011 EN61851-21:2002 IEC61851-1:2010 IEC61851-21:2001 EM62752 EN61000-6-1:2007 EN61000-6-2:2005 EN61000-6-3:2007 EN61000-6-4:2007 IEC62196-1:2011 IEC62196-2:2011 IEC62196-3:2011
Adaptors	Do not use an extension cable or electrical adaptor.

MOTOR

Model	EM57
-------	------

WHEELS AND TIRES

Road wheel

Type		Size	Offset mm (in)
Conventional	Steel	16 × 6.5JJ	40 (1.57)
	Aluminum	17 × 6.5J	45 (1.77)
Spare (if equipped)	Steel	16 × 4T	40 (1.57)

Tire

Type	Size
Conventional	205/55R16 91V
	215/50R17 91V
Spare (if equipped)	T125/90D16 98M

DIMENSIONS

Overall length	mm (in)	4,480 (176.4)
Overall width	mm (in)	1,790 (70.5)
Overall height	mm (in)	1,540 (60.5)*1
		1,550 (61.0)*2
Front tread	mm (in)	1,540 (60.5) *3
		1,530 (60.2) *4
Rear tread	mm (in)	1,555 (61.2) *3
		1,545 (60.8) *4
Wheelbase	mm (in)	2,700 (106.3)

*1: Except for Indonesia

*2: For Indonesia

*3: 16-inch wheel model

*4: 17-inch wheel model

WHEN TRAVELLING OR REGISTERING IN ANOTHER COUNTRY

When planning to travel in another country, you should first find out if the charging equipment is compatible with that country's electrical system.

When transferring the registration of your vehicle to another country, state, province or district, contact the appropriate authorities to find out that the vehicle complies with the local legal requirements.

The laws and regulations for motor vehicle safety standards vary according to the country, state, province or district; therefore, vehicle specifications may differ.

When any vehicle is to be taken into another country, state, province or district and registered, its modifications, transportation, and registration are the responsibility of the user. NISSAN is not responsible for any inconvenience that may result.

VEHICLE IDENTIFICATION

It is prohibited to cover, paint, weld, cut, drill, alter or remove Vehicle Identification Number (VIN).

VEHICLE IDENTIFICATION PLATE

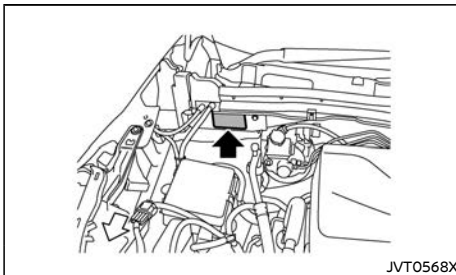

The vehicle identification plate is affixed shown.

VEHICLE IDENTIFICATION NUMBER (VIN)

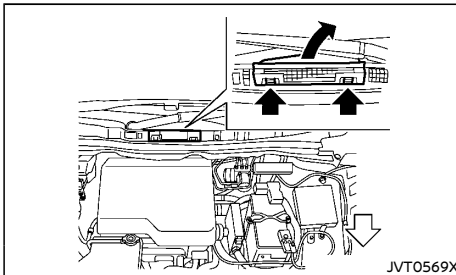

The vehicle identification number is located as shown.

Remove the cover to access the number.

TRACTION MOTOR SERIAL NUMBER



The serial number of the traction motor is stamped on the traction motor as shown.

TIRE PLACARD

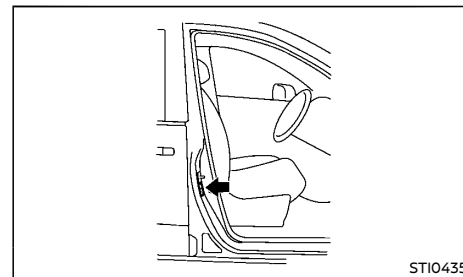

The cold tire pressure is shown on the tire placard affixed to the driver's side center pillar as shown.

INSTALLATION OF AN RF-TRANSMITTER

AIR CONDITIONER SPECIFICATION LABEL

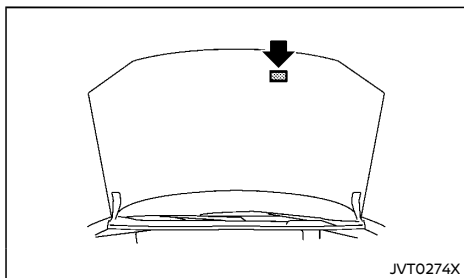

The air conditioner specification label is attached to the underside of the hood as shown.

For countries conforming to UN regulation No.10 or equivalent:

The installation of an RF transmitter in your vehicle could affect electric equipment systems. Be sure to check with your NISSAN certified LEAF dealer for precautionary measures or special instructions regarding installation. Upon request, your NISSAN certified LEAF dealer will provide the detailed information (frequency band, power, antenna position, installation guide, etc.) regarding installation.

RADIO APPROVAL NUMBER AND INFORMATION

FOR THAILAND

Body Control Module (BCM)

This telecommunication equipment is in compliance with NBTC requirements.

Front radar sensor (if equipped)

1) เครื่องโทรคมนาคมและอุปกรณ์ที่มีความสอดคล้องตามมาตรฐานหรือข้อกำหนดของ กสทช.

2) “เครื่องโทรคมนาคมที่มีอัตราการดูดกลืนพลังงานจำเพาะ (Specific Absorption Rate - SAR) อันเนื่องมาจากเครื่องโทรคมนาคมเท่ากับ .. W/kg ซึ่งสอดคล้องตามมาตรฐานความปลอดภัย ต่อสุขภาพของมนุษย์จากการใช้เครื่องโทรคมนาคมที่คณะกรรมการกิจการโทรคมนาคมแห่งชาติประกาศ

กำหนด”

3) เครื่องโทรคมนาคมมีระดัการแผ่คลื่นแม่เหล็กไฟฟ้าสอดคล้องตามมาตรฐานความปลอดภัยต่อสุขภาพของมนุษย์จากการใช้เครื่องโทรคมนาคมที่คณะกรรมการกิจการโทรคมนาคมแห่งชาติประกาศกำหนด

WBJ0003X

FOR MALAYSIA

Intelligent Key system

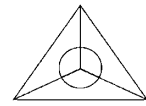

MCMC
HIDF20MTSFBTCT007

WAJ0434X

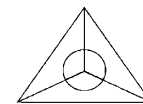

MCMC
HIDF14MTSFBTCT007

WAJ0435X

NISSAN Anti-Theft System (NATS)

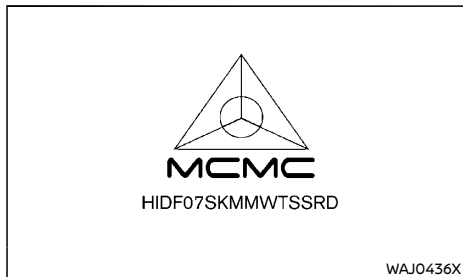

Front radar sensor (if equipped)

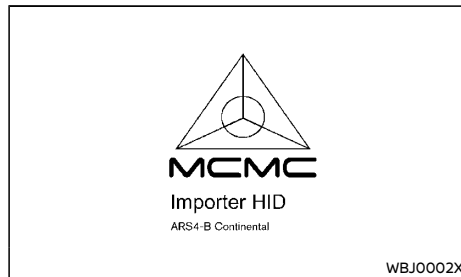

NISSAN Anti-Theft System (NATS)

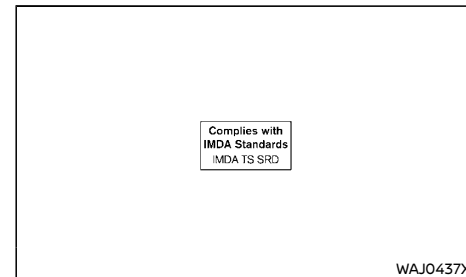

Body Control Module (BCM)

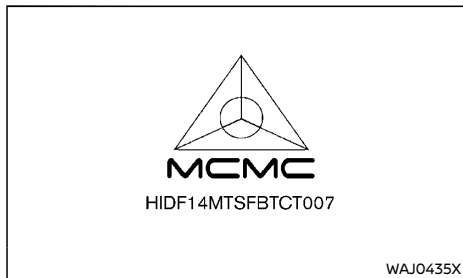

FOR SINGAPORE

Intelligent Key system

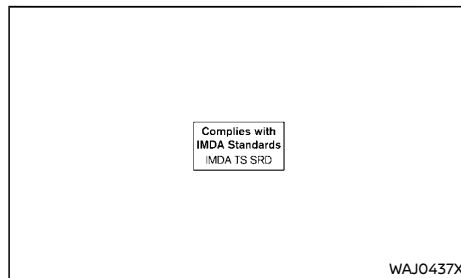

Body Control Module (BCM)

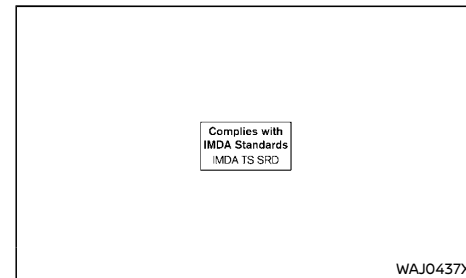

Front radar sensor (if equipped)

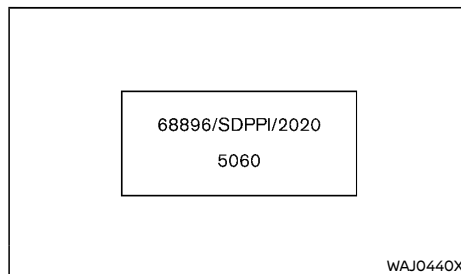
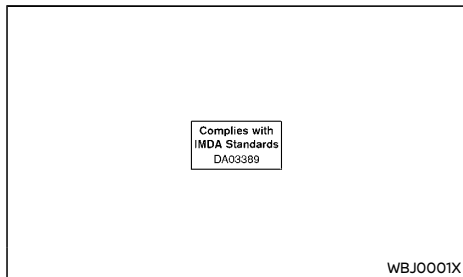

Passive Entry System(Tuner)

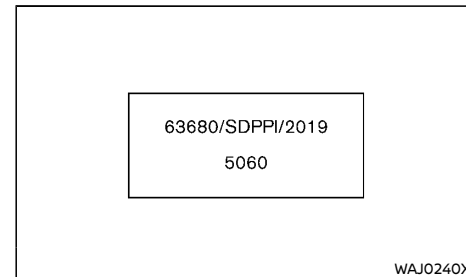

FOR INDONESIA

Intelligent Key system

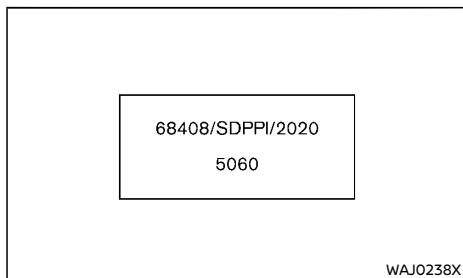

NISSAN Anti-Theft System (NATS)

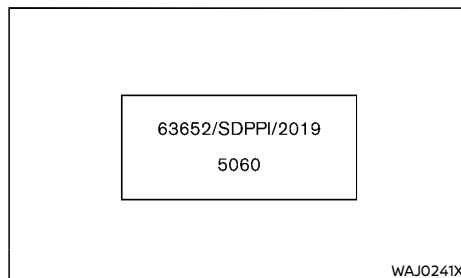

Body Control Module (BCM)

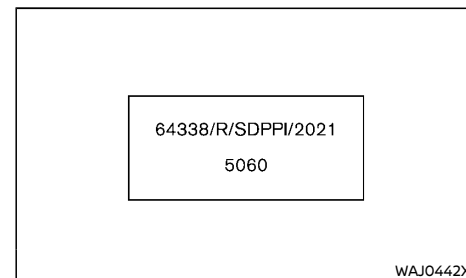

Front radar sensor (if equipped)



FOR MAURITIUS

Intelligent Key system

Hereby, ALPS ELECTRIC CO.,LTD., declares that the radio equipment type TWB1G0168/TWB1G0169 is in compliance with Directive 2014/53/EU.

The full text of the EU declaration of conformity is available at the following internet address:

<https://www.alps.com/products/common/pdf/HandUnit/TWB1G0169.pdf>

Manufacturing user's name:

ALPS ELECTRIC CO., LTD.

Manufacturer's registered trade name or registered trade mark:

ALPS

Manufacturer's postal address:

6-3-36, Furukawanakazato, Osaki-city, Miyagi-pref., JAPAN 989-6181

Importer name, address:

ABC MOTORS

Route Military, Abattoire road, Port Louis, Maur-

itius

Operating frequency band: 433.92 MHz

Maximum radio-frequency power: 80dBuV/m@3m

NISSAN Anti-Theft System (NATS)

Hereby, ALPS ELECTRIC CO.,LTD., declares that the radio equipment type TWK1A002 is in compliance with Directive 2014/53/EU.

The full text of the EU declaration of conformity is available at the following internet address: <https://www.alps.com/products/common/pdf/Immobilizer/TWK1A002.pdf>

Manufacturing user's name:

ALPS ELECTRIC CO., LTD.

Manufacturer's registered trade name or registered trade mark:

ALPS

Manufacturer's postal address:

6-3-36, Furukawanakazato, Osaki-city, Miyagi-pref., JAPAN 989-6181

Importer name, address:

ABC MOTORS

Route Military, Abattoire road, Port Louis, Mauritius

Operating frequency band: 125kHz

Maximum radio-frequency power: 55.4dBuV/m@10m

MEMO

MEMO

MEMO

10 Index

A

ABS (Anti-lock Braking System).....	5-35
Air bag system	
Supplemental curtain side-impact air bag system.....	1-22, 1-27
Supplemental front-impact air bag system.....	1-22, 1-27
Supplemental Restraint System (SRS).....	1-22
Supplemental side-impact air bag system.....	1-22, 1-27
Air conditioner	
Air conditioner specification label.....	9-7
Air conditioner system refrigerant and lubricant recommendations.....	9-3
Air conditioner filter.....	4-19
Antenna.....	4-25
Anti-lock Braking System (ABS).....	5-35
Anti-lock Braking System (ABS) warning light.....	2-9
Anti-theft system.....	3-10
Appearance care	
Exterior appearance care.....	7-2
Interior appearance care.....	7-3
Approaching Vehicle Sound for Pedestrians (VSP) system.....	EV-15
Audible reminders.....	2-14
Audio control steering wheel buttons.....	4-30
Audio operation precautions.....	4-19
Audio system.....	4-19
Automatic climate control system.....	4-15
Auxiliary input jack.....	4-30
Available views.....	4-4

B

Battery	
12-volt battery.....	8-11

Battery saver system.....	2-33, 2-42
Intelligent Key battery.....	5-5, 8-12
Li-ion battery.....	EV-2
Before starting the EV (Electric Vehicle) system.....	5-3
Bluetooth® Hands-Free Phone System....	4-32
Brake	
Anti-lock Braking System (ABS).....	5-35
Brake fluid.....	8-7
Brake system.....	5-34
Brake system warning light (yellow)....	2-10
Brakes.....	8-7
Checking parking brake.....	8-7
Parking brake.....	3-19
Brake system warning light (yellow).....	2-10

Brightness control	
Instrument panel.....	2-7
Bulb replacement.....	8-15

C

Camera	
Intelligent Around View Monitor.....	4-3
Car phone or CB radio.....	4-32
Care when driving.....	5-3
Cargo cover.....	2-39
Changing	
Changing tires and wheels.....	8-22
Changing odometer/twin trip odometer display.....	2-5
Charging	
Charge port lid.....	3-13
Charging methods.....	CH-18
Charging related indicator lights.....	CH-20
Charging status indicator lights.....	CH-20
Charging timer.....	CH-18
Charging troubleshooting guide.....	CH-24
Immediate charge.....	CH-19
NISSAN EVSE (Electric Vehicle Supply Equipment).....	CH-10

Normal charge.....	CH-7
Precautions on charging.....	CH-3
Quick charge.....	CH-5
Specifications.....	9-4
V2X charge/discharge.....	CH-16
Chassis control.....	5-12
Checking	
Checking coolant level.....	8-6
Checking lights.....	2-9
Checking parking brake.....	8-7
Child restraint anchorage.....	1-15
Child restraints.....	1-11
ISOFIX.....	1-16
Precautions on child restraints.....	1-11
Three-point type seat belt.....	1-18
Child safety.....	1-8
Child safety rear door lock.....	3-4
Chimes, Audible reminders.....	2-14
Circuit breaker, Fusible link.....	8-14
Cleaning exterior and interior.....	7-2, 7-3
Climate control	
Climate control system.....	4-13
Climate Ctrl. Timer.....	4-17
Climate control system	
Climate control service.....	4-19
Climate control system refrigerant and lubricant recommendations.....	4-19
Clock.....	2-7
Cockpit.....	2-2
Cold weather driving.....	5-37
Console box.....	2-39
Coolant	
Changing coolant.....	8-6
Checking coolant level.....	8-6
Cooling system.....	8-6
Corrosion protection.....	7-5
Cruise control.....	5-14
Cup holders.....	2-38
Curtain side-impact air bag system.....	1-22, 1-27

D

Daytime running light.....	2-32
Defogger switch.....	2-36
Dimensions.....	9-5
Display	
Vehicle information display.....	2-15
Driving	
Care when driving.....	5-3
Cold weather driving.....	5-37
Driving in wet conditions.....	5-3
Driving in winter conditions.....	5-3
Driving vehicle.....	5-6
Precautions when starting and driving.....	5-3
Driving range.....	2-6
Driving vehicle.....	5-6

E

e-Pedal system.....	5-8
e-Pedal system indicator.....	2-7
ECO Drive Report.....	2-30
ECO mode indicator.....	2-7
Efficient use of your vehicle.....	EV-12
Electric power steering.....	5-34
Electric power steering warning light.....	2-11
Electric shift control system warning light.....	2-11
Electronic parking brake system.....	3-20
Electronic Stability Program (ESP) system.....	5-11
Electronic Stability Program (ESP) warning light.....	2-11
Emergency brake (See Intelligent Emergency Braking system).....	5-25
Emergency EV (Electric Vehicle) system shut off.....	5-5, 6-2
Emergency shut-off system.....	EV-6
Emergency tire puncture repair kit....	6-7, 8-23

EV Characteristics.....	EV-7
EV system.....	EV-2
EV system warning light.....	2-11
EV unique information.....	EV-14
EVSE (Electric Vehicle Supply Equipment).....	CH-10
Cleaning.....	7-4
Control box indicator light.....	CH-22
Storage net.....	2-41

F

Flat tire.....	6-2
Floor mats.....	7-4
Fluid	
Brake fluid.....	8-7
Coolant.....	8-6
Reduction gear fluid.....	8-8
Window washer fluid.....	8-10
Fluids	
Recommended fluids/lubricants and capacities.....	9-2
FM-AM radio with Compact Disc (CD) player.....	4-25
Fog light switch.....	2-34
Front fog light.....	2-34
Front manual seat adjustment.....	1-2
Front seat, Front seat adjustment.....	1-2
Front-impact air bag system.....	1-22, 1-27
Fuses.....	8-13
Fusible links.....	8-14

G

Gauge.....	2-4
Glove box.....	2-38

H

Hands-Free Phone System, Bluetooth®....	4-32
Hazard indicator flasher switch.....	6-2

Head restraints.....	1-5
Headlight aiming control.....	2-32
Headlight and turn signal switch.....	2-30
Headlights	
Bulb replacement.....	8-15
Headlight switch.....	2-30
Heated seats.....	1-3
High beam assist.....	2-31
High voltage precautions.....	EV-5
Hill start assist system.....	5-13
Hood release.....	3-10
Horn.....	2-36

I

If the Li-ion battery becomes completely discharged.....	6-11
Immediate charge.....	CH-19
Indicator	
Vehicle information display.....	2-15
Indicator lights.....	2-12
Injured persons.....	1-9
Inside rearview mirror.....	3-14
Instrument brightness control.....	2-7
Instrument panel.....	2-3
Intelligent Around View Monitor.....	4-3
Intelligent Driver Alertness.....	5-23
Intelligent Emergency Braking system....	5-25
Intelligent Emergency Braking system warning light.....	2-11
Intelligent Key system.....	3-4, 5-4
Battery discharge.....	5-5
Key operating range.....	3-5
Remote keyless entry function.....	3-9
Intelligent Lane Intervention system.....	5-19
Intelligent Rear View Mirror.....	3-15
Intelligent Ride Control.....	5-13
Intelligent Trace Control.....	5-12
Interior light replacement.....	8-17
Interior lights.....	2-41
ISOFIX child restraint.....	1-15

J	
Jump starting.....	6-9
K	
Key	
Keys.....	3-2
Using Intelligent Key system.....	3-6
Keyless entry	
With Intelligent Key system (See Intelligent Key system).....	3-9
Keys	
For Intelligent Key system.....	3-4
L	
Labels	
Air conditioner specification label.....	9-7
Motor serial number.....	9-6
Tire placard.....	9-6
Vehicle identification number (VIN).....	9-6
Lane Departure Warning (LDW) system....	5-16
Li-ion battery.....	EV-2
Li-ion battery available charge gauge.....	2-6
Light	
Bulb replacement.....	8-15
Fog light switch.....	2-34
Front fog light.....	2-34
Headlight switch.....	2-30
Headlights bulb replacement.....	8-15
Indicator lights.....	2-12
Interior lights.....	2-41
Light locations.....	8-18
Map lights.....	2-41
Rear fog light.....	2-34
Replacement.....	8-15
Room light.....	2-42
Warning lights, indicator lights and audible reminders.....	2-8

Lights, Exterior and interior	
light replacement.....	8-17
Lithium ion (Li-ion) battery.....	EV-2
Loading luggage.....	5-3
Lock	
Door locks.....	3-3
Power door lock.....	3-3
Rear hatch lock.....	3-11
Locking doors.....	3-6
Low battery charge warning light.....	2-12

M	
Maintenance	
12-volt battery.....	8-11
General maintenance.....	8-2
Inside vehicle.....	8-3
Maintenance precautions.....	8-4
Maintenance requirements.....	8-2
Outside vehicle.....	8-2
Seat belt maintenance.....	1-11
Manual front seat adjustment.....	1-2
Map light control switch.....	2-42
Map lights.....	2-41
Master warning light.....	2-12
Mechanical key (Intelligent Key system).....	3-3
Meters and gauges.....	2-4
Instrument brightness control.....	2-7
Mirror	
Inside rearview mirror.....	3-14
Intelligent Rear View Mirror.....	3-15
Outside rearview mirrors.....	3-18
Vanity mirror.....	3-19
Motor.....	5-6, 9-5
Motor compartment.....	8-5
Moving Object Detection (MOD).....	4-10

N	
NISSAN Anti-Theft System (NATS).....	3-10
NissanConnect Owner's Manual.....	4-2

Normal charge.....	CH-7
--------------------	------

O	
Odometer/Twin trip odometer.....	2-5
Opening rear hatch.....	3-7
Outside air temperature.....	2-7
Outside rearview mirrors.....	3-18

P	
Panic alarm.....	3-9
Parking.....	5-32
Parking brake.....	3-19
Parking brake	
Electronic parking brake indicator light.....	2-12
Parking brake break-in.....	5-35
Phone	
Car phone or CB radio.....	4-32
Phone, Bluetooth® Hands-Free	
Phone System.....	4-32
Power	
Electric power steering.....	5-34
Power door lock.....	3-3
Power outlet.....	2-38
Power windows.....	2-36
Power economy.....	5-31
Power meter.....	2-5
Power switch.....	5-4
Precautions	
Audio operation.....	4-19
Braking precautions.....	5-34
Charging.....	CH-3
Child restraints.....	1-11
Cruise control.....	5-14
High voltage precautions.....	EV-5
Maintenance.....	8-4
Road accident precautions.....	EV-6
Seat belt usage.....	1-7
Supplemental restraint system.....	1-22

When starting and driving.....	5-3
Pregnant women.....	1-9
Push starting.....	6-12

Q

Quick charge.....	CH-5
-------------------	------

R

Radio.....	4-19
Car phone or CB radio.....	4-32
FM-AM radio with Compact Disc (CD) player.....	4-25
Radio approval number and information.....	9-8
Rear door lock, Child safety rear door lock.....	3-4
Rear fog light.....	2-34
Rear hatch.....	3-11
Rear seats.....	1-4
Rear window wiper and washer switch ...	2-35
Recommended fluids/lubricants and capacities.....	9-2
Reduction gear fluid.....	8-8
Remote keyless entry function, For Intelligent Key system.....	3-9
Repairing flat tire.....	6-6
Repairing tire.....	6-7
Resetting twin trip odometer.....	2-5
Road accident precautions.....	EV-6
Room light.....	2-42

S

Safety	
Child safety.....	1-8
Scene guide	
At home after driving.....	EV-12
Charging the Li-ion battery.....	EV-8
Driving the vehicle.....	EV-10
Parking the vehicle.....	EV-11

Starting your vehicle.....	EV-9
Seat adjustment	
Front manual seat adjustment.....	1-2
Front seats.....	1-2
Seat belt(s)	
Child safety.....	1-8
Injured persons.....	1-9
Pre-tensioner seat belt system.....	1-30
Precautions on seat belt usage.....	1-7
Pregnant women.....	1-9
Seat belt cleaning.....	7-4
Seat belt hooks.....	1-10
Seat belt maintenance.....	1-11
Seat belt warning light.....	2-12
Seat belts.....	1-7
Shoulder belt height adjustment.....	1-10
Three-point type.....	1-9
Seat(s), Seats.....	1-2
Security system (NISSAN Anti-Theft System).....	3-10
Servicing climate control system.....	4-19
Settings	
Vehicle information display.....	2-15
Shift position indicator.....	2-6
Shifting	
Electric shift control system.....	5-6
Shoulder belt height adjustment, For front seats.....	1-10
Side-impact air bag system.....	1-22, 1-27
Small light indicator light.....	2-14
Soft bottle holders.....	2-39
Spare tire.....	8-22
Starting.....	5-6
Before starting the EV (Electric Vehicle) system.....	5-3
Jump starting.....	6-9
Precautions when starting and driving.....	5-3
Push starting.....	6-12
Steering	
Electric power steering.....	5-34
Steering wheel.....	3-14

Stopping the vehicle.....	6-2
Storage.....	2-38
Storage net.....	2-41
Stowing golf bags.....	2-40
Sun visors.....	2-41
Supplemental air bag systems.....	1-26
Supplemental curtain side-impact air bag system.....	1-22, 1-27
Supplemental front-impact air bag system.....	1-22, 1-27
Supplemental restraint system.....	1-22
Precautions on supplemental restraint system.....	1-22
Supplemental Restraint System (SRS) air bag warning light.....	2-12
Supplemental side-impact air bag system.....	1-22, 1-27
Switch	
Fog light switch.....	2-34
Front fog light switch.....	2-34
Headlight switch.....	2-30
Immediate charge switch.....	CH-19
Intelligent Lane Intervention switch.....	5-19
Power door lock switch.....	3-4
Rear fog light switch.....	2-34
Turn signal switch.....	2-33

T

Theft (NISSAN Anti-Theft System).....	3-10
Timer	
Charging Timer.....	CH-18
Climate Ctrl. Timer.....	4-17
Tires	
Changing tires and wheels.....	8-22
Emergency tire puncture repair kit.....	6-7, 8-23
Flat tire.....	6-2
Spare tire.....	8-22
Tire chains.....	8-21
Tire placard.....	9-6
Tire rotation.....	8-3, 8-21

Tire wear and damage	8-22
Types of tires	8-21
Wheel/tire size	9-5
Wheels and tires	8-21
Towing	
Tow truck towing	6-12
Towing precautions	6-12
Towing recommended by NISSAN	6-13
Trailer towing	5-33
Traction motor	
Traction motor serial number	9-6
Trailer towing	5-33
Transmitter, With Intelligent Key system (See Intelligent Key system)	3-9
Trip computer	2-26
Turn signal switch	2-33

U

Underbody cleaning	7-2
Unlocking doors	3-7
USB connection port	4-30
Using Intelligent Key system	3-6

V

V2X charge/discharge	CH-16
Vanity mirror	3-19
Vehicle	
Dimensions	9-5
Identification number (VIN)	9-6
Recovery (freeing stuck vehicle)	6-13
Vehicle information display	2-15
How to use the vehicle information display	2-15
Settings	2-15
Startup display	2-15
Vehicle information display warnings and indicators	2-21
Vehicle security	5-36
Ventilators	4-13

VSP system	EV-15
------------------	-------

W

Warning	
Lane Departure Warning (LDW) system	5-16
Reminders	2-8
Vehicle information display	2-15
Warning light	
12-volt battery charge warning light	2-9
Anti-lock Braking System (ABS) warning light	2-9
Brake system warning light (yellow)	2-10
Brake warning light (red)	2-10
Electric power steering warning light	2-11
Electric shift control system warning light	2-11
Electronic Stability Program (ESP) warning light	2-11
EV system warning light	2-11
Intelligent Emergency Braking system warning light	2-11
Low battery charge warning light	2-12
Seat belt warning light	2-12
Supplemental Restraint System (SRS) air bag warning light	2-12
Warning lights	2-9
Washer switch	
Rear window wiper and washer switch	2-35
Windshield wiper and washer switch	2-34
Washing	7-2
Waxing	7-2
Wheel/tire size	9-5
Wheels and tires	8-21
Care of wheels	7-3
Cleaning aluminum alloy wheels	7-3
When traveling or registering your vehicle in another country	9-6

Window washer fluid	8-10
Window(s)	
Cleaning	7-2
Power windows	2-36
Windows	2-36
Windshield wiper and washer switch	2-34
Wiper	
Rear window wiper and washer switch	2-35
Rear window wiper blade	8-9
Replacing wiper blades	8-9
Windshield wiper and washer switch	2-34
Wiper blades	8-8
Wiper and washer switch	2-34

COLD TIRE PRESSURES

See the tire placard affixed to the driver's side center pillar.

QUICK REFERENCE

- In case of emergency ... "In case of emergency" (P.6-1)
(Flat tire, EV system will not start, overheating, towing)
- How to charge the EV ..."Charging" (P.CH-1)
- How to start the EV system ... "Starting and driving" (P.5-1)
- How to read the meters and gauges ... "Instruments and controls" (P.2-1)
- Maintenance and do-it-yourself ... "Maintenance and do-it-yourself" (P.8-1)
- Technical information ... "Technical information" (P.9-1)