

Foreword

Thank you for purchasing a NISSAN vehicle.

This user's manual is for NissanConnect System.

Operation instructions for the following systems are included in this manual.

- EV-specific functions
- Audio
- Hands-free phone
- Apple CarPlay
- Android Auto
- NissanConnect Services
- Navigation
- Voice recognition
- Information and settings viewable on NissanConnect

Please read this manual carefully to ensure safe operation of NissanConnect System.

- Because of possible specification changes and optional equipment, some sections of this manual may not apply to your vehicle.
- All information, specifications and illustrations in this manual are those in effect at the time of printing. NISSAN reserves the right to change specifications or design at any time without notice.

- Do not remove this manual from the vehicle when selling this vehicle. The next user of the system may need the manual.

© 2020 NISSAN MOTOR CO., LTD.

Table of Contents

0 Introduction

How to use this manual....	0-2
Safety information.....	0-3
Regulatory information ...	0-4
Trademarks.....	0-5
Licenses.....	0-5

IT System overview (if equipped)

System features	IT-2
-----------------------	------

1 Getting started

Control buttons and touch screen display	1-2
Starting system.....	1-6
Basic operation.....	1-6
System settings.....	1-14

2 Unique EV functions (models with navigation system)

EV Info menu screen	2-2
Displaying estimated driving range and charging station information.....	2-3
Energy usage information display	2-6
Unique EV function settings.....	2-7

3 Audio system

Audio operation precautions	3-2
Names and functions of audio control buttons	3-7
Audio operations.....	3-8
Audio settings.....	3-26
USB memory device care.....	3-27

4 Hands-Free Phone

Bluetooth® Hands-Free Phone System.....	4-2
---	-----

5 Information

Information menu.....	5-2
NissanConnect Services (if equipped).....	5-6
Apple CarPlay (if equipped).....	5-7
Android Auto™ (if equipped).....	5-11
Siri Eyes Free (if equipped).....	5-15

6 Navigation (if equipped)

Safety information.....	6-2
Navigation screen.....	6-2
Map operation	6-3
Setting destination.....	6-13
Route guidance.....	6-23
Viewing traffic information (if equipped).....	6-36

Storing a location/route.....	6-38
Navigation settings.....	6-45
General information for navigation system	6-48

Voice recognition (if equipped).....	8-27
--------------------------------------	------

7 Voice recognition (if equipped)

Voice recognition	7-2
-------------------------	-----

8 Troubleshooting guide

System unit.....	8-2
Unique EV functions (if equipped).....	8-3
Audio system.....	8-6
Bluetooth® Hands-Free Phone System.....	8-14
Apple CarPlay (if equipped).....	8-17
Android Auto (if equipped).....	8-18
Siri Eyes Free (if equipped).....	8-19
Navigation (if equipped).....	8-20

0 Introduction

How to use this manual	0-2
For safe operation	0-2
Reference symbols	0-2
Screen illustrations	0-2
Safety information	0-3
Regulatory information	0-4
Radio approval number and information	0-4
Trademarks	0-5
Licenses	0-5
Software Licenses	0-5
Telematic Control Unit (if equipped)	0-5



0. Introduction

HOW TO USE THIS MANUAL

This manual uses special words, symbols, icons and illustrations organized by function.

Please refer to the following items and familiarize yourself with them.

FOR SAFE OPERATION



This is used to indicate the presence of a hazard that could cause death or serious personal injury. To avoid or reduce the risk, the procedures must be followed precisely.



This is used to indicate the presence of a hazard that could cause minor or moderate personal injury or damage to your vehicle. To avoid or reduce the risk, the procedures must be followed carefully.



Indicates items that help you understand and maximize the performance of your vehicle. If ignored, they may lead to a malfunction or poor performance.

REFERENCE SYMBOLS



This indicates information that is necessary for efficient use of your vehicle or accessories.



This indicates the title and page that you should refer to.

< >:

This indicates a button on the control panel and steering wheel.

[]:

This indicates a key/item displayed on the screen.

SCREEN ILLUSTRATIONS

- The illustrations in this manual are representatives of various models and may not be identical with the design and specifications of your vehicle.
- Icons and menu items displayed on the screen may be abbreviated or omitted from the screen illustrations when appropriate. The omitted icons and menu items are described as dotted lines as illustrated.

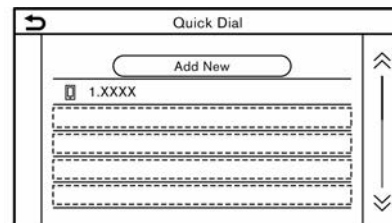

SAFETY INFORMATION

This system is primarily designed to help you support pleasant driving as outlined in this manual. However, you, the driver, must use the system safely and properly. Information and the availability of services may not always be up to date. The system is not a substitute for safe, proper and legal driving.

Before using the system, please read the following safety information. Always use the system as outlined in this manual.



WARNING

- **To operate the system, first park the vehicle in a safe location and set the parking brake. Operating the system while driving can distract the driver and may result in a serious accident.**
- **Exercise extreme caution at all times so full attention may be given to vehicle operation. If the system does not respond immediately, please be patient and keep your eyes on the road. Inattentive driving may lead to a crash resulting in serious injuries or death.**
- **Do not rely on route guidance alone. Always be sure that all driving maneuvers are legal and safe in order to avoid accidents.**

- **Do not disassemble or modify this system. If you do, it may result in accidents, fire or electrical shock.**
- **If you notice any foreign objects in the system hardware, spill liquid on the system or notice smoke or a smell coming from it, stop using the system immediately and contact a NISSAN dealer. Ignoring such conditions may lead to accidents, fire or electrical shock.**



CAUTION

- **Extreme temperature conditions [below -20°C (-4°F) and above 70°C (158°F)] could affect the performance of the system.**
- **The display screen may break if it is hit with a hard or sharp object. If the display screen breaks, do not touch it. Doing so could result in an injury.**



NOTE:

- **Do not keep the system running with the READY to drive indicator light OFF. Doing so may discharge the vehicle battery (12V battery). When you use this system, always make sure the READY to drive indicator light is ON.**

Models with NissanConnect Services: NissanConnect Services may not be available in some regions. Completing the NissanConnect Services registration is necessary to use NissanConnect Services related functions.

0. Introduction

REGULATORY INFORMATION

RADIO APPROVAL NUMBER AND INFORMATION

For Europe

Hereby, Robert Bosch Car Multimedia GmbH declares that the radio equipment type AIVIB12P0 is in compliance with Directive 2014/53/EU.

The full text of the EU declaration of conformity is available at the following internet address:

<http://cert.bosch-carmultimedia.net>



Frequency Band

2400 MHz - 2480 MHz

Radiated Power [EIRP]

Bluetooth < 10 mW

WLAN < 100 mW

Hints/Restrictions

Internal Antenna

Internal antenna not accessible by user. Any change of the user will violate the legal approval of this product.

For Brazil

Este equipamento opera em caráter secundário, isto é, não tem direito a proteção contra interferência prejudicial, mesmo de estações do mesmo tipo, e não pode causar interferência a sistemas operando em caráter primário.



For Taiwan

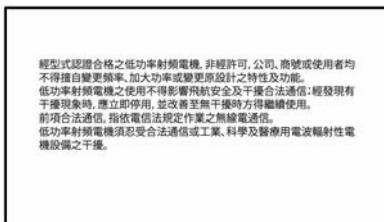

For Korea

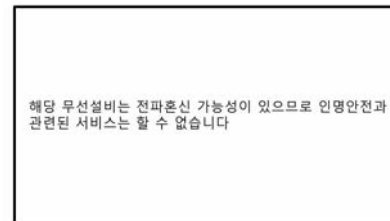

For Mexico

La operación de este equipo está sujeta a las siguientes dos condiciones:

- (1) es posible que este equipo o dispositivo no cause interferencia perjudicial y
- (2) este equipo o dispositivo debe aceptar cualquier interferencia, incluyendo la que pueda causar su operación no deseada.

Modelo: AIVIB12P0

Marca: Bosch

TRADEMARKS



Apple, iPhone, iPod, and iPod touch are trademarks of Apple Inc., registered in the U.S. and other countries. Apple CarPlay is a trademark of Apple Inc. Use of the Apple CarPlay logo means that a vehicle user interface meets Apple performance standards. Apple is not responsible for the operation of this vehicle or its compliance with safety and regulatory standards. Please note that the use of this product with iPhone or iPod may affect wireless performance.



Bluetooth® is a trademark owned by Bluetooth SIG, Inc. and licensed to Robert Bosch GmbH.

App Store

Apple and the Apple logo are trademarks of Apple Inc., registered in the U.S. and

other countries. App Store is a service mark of Apple Inc.

Siri

Siri is a trademark of Apple Inc., registered in the U.S. and other countries.

Google/Android/Google Play/Android Auto

Google, Android, Google Play, Android Auto, and other marks are trademarks of Google LLC.

LICENSES

SOFTWARE LICENSES

Open Source Software Licenses

<http://oss.bosch-cm.com/nissan.html>

TELEMATIC CONTROL UNIT (if equipped)

<http://opensourceautomotive.com/IC/tZ7T3eE6AiV4>

0. Introduction

MEMO

IT System overview (if equipped)

System features	IT-2
Unique EV functions (models with navigation system)	IT-2
Telematics service (if equipped)	IT-3



IT. System overview (if equipped)

SYSTEM FEATURES

Functions unique to EV are introduced here.

UNIQUE EV FUNCTIONS (models with navigation system)

In addition to the conventional navigation functions, the NissanConnect System for LEAF also offers specific support for driving an Electric Vehicle (EV).

Menus specific to EV can be accessed from the EV Info menu screen.

☞ "EV Info menu screen" (page 2-2)

CAUTION

Charging station information may not be detailed in all areas or reflect current charging station locations. For up-to-date information about charging stations, such as business hours or charging equipment, NISSAN recommends that you directly access the information on your own. Additionally, always check the remaining amount of Li-ion battery charge and set a reasonable driving schedule.

Driving range display

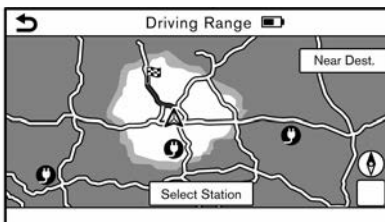

Touch [Driving Range] in the EV Info menu.

☞ "EV Info menu screen" (page 2-2)

You can display the estimated one way range that the vehicle can be driven from the current location based on the amount of remaining Li-ion battery charge. When a route is set, an estimated driving range from the destination or the waypoint can also be displayed.

☞ "Displaying estimated driving range" (page 2-3)

Charging stations located within the estimated driving range will also be displayed. You can set a charging station as a destination or waypoint.

☞ "Setting a charging station as destination" (page 2-5)

Charging station information

NOTE:

Charging stations that have been searched for using this function are not necessarily equipped with devices that can be used to charge an EV. Be sure to confirm this in advance before setting a charging station as the destination.

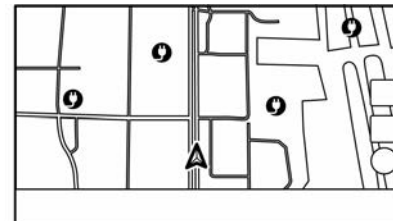

Icons for charging stations can be displayed on the map.

☞ "Displaying charging station icons on map" (page 2-5)

You can also search for charging stations near the current location, set a charging station as a destination or waypoint, and check detailed information about charging stations.

☞ "Finding charging station" (page 6-19)

INFO:

- Charging station information on map can be updated by updating the map data.

 "How to update map data"
(page 6-53)

- Models with NissanConnect Services:
This vehicle is equipped with a TCU (Telematics Control Unit), a communication device that enables communication with the Nissan Data Center for various telematics services.
Charging station information on map automatically updates periodically via TCU (Telematics Control Unit).

TELEMATICS SERVICE (if equipped)

Refer to NissanConnect Services app for available services.

Energy usage information display

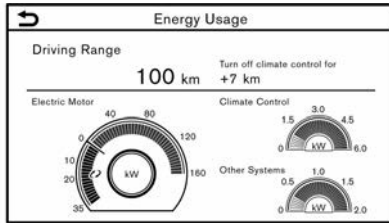

Example

Estimated driving range and energy usage of various systems are displayed. Also, variation of the estimated driving distances between the climate control ON and OFF is displayed.

 "Viewing energy usage information"
(page 2-6)

IT. System overview (if equipped)

MEMO

1 Getting started

Control buttons and touch screen display	1-2
Control panel	1-2
Liquid crystal display	1-3
Steering wheel switches	1-4
USB (Universal Serial Bus) connection port and AUX (auxiliary) input jack (if equipped)	1-5
Starting system	1-6
Start-up screen (if equipped)	1-6
Basic operation	1-6
Selecting menu from Launch Bar	1-6
Displaying EV Info menu screen (if equipped)	1-7
Touch panel operation	1-7
Main screen operations	1-8
Adjusting settings	1-9
How to input letters and numbers	1-9
How to view and operate HOME MENU screen	1-11
Functions disabled while driving (if equipped)	1-13
System settings	1-14
Settings menu	1-14
Connections settings	1-16
Volume and Beeps settings	1-19
Clock settings	1-20
Display settings	1-21
Language setting	1-21
Units settings (if equipped)	1-21
Keyboard type settings	1-22
Return all settings to default	1-22

1. Getting started

CONTROL BUTTONS AND TOUCH SCREEN DISPLAY

CONTROL PANEL

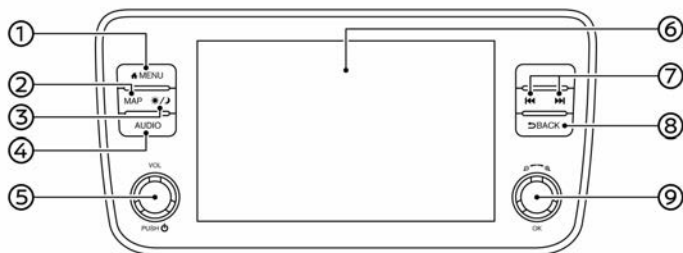

Models with navigation system

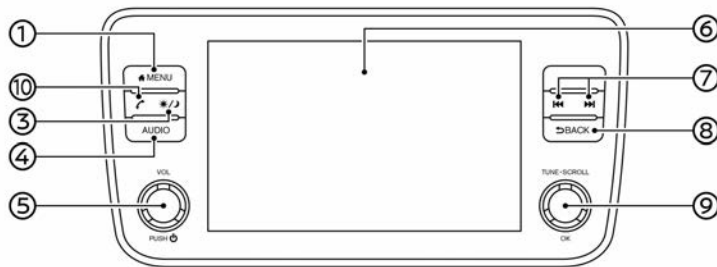

Models without navigation system

- ① **<MENU>**:
Push to display the HOME MENU screen.
☞ "How to view and operate HOME MENU screen" (page 1-11)
- ② **<MAP>** (models with navigation system):
Push to display the current location map.
☞ "Navigation screen" (page 6-2)
- ③ **<*/>**:
Push to switch between the day screen (bright) and the night screen (dark) and to adjust the level of screen brightness. Push and hold the button to turn off the display. Push the button again to turn on the display.
- ④ **<AUDIO>**:
Push to display the audio screen. When this button is pushed while the audio screen is displayed, a screen to select an audio source will be displayed.
☞ "Selecting audio source" (page 3-8)
- ⑤ **<VOL/ ⏻>**:
Push to turn the power of the audio system on and off. Turn to adjust the volume.
- ⑥ Touch screen display:
Various information and operation menus are displayed on the liquid crystal display. Touch keys and icons

on the screen for operation.

 "Touch panel operation"
(page 1-7)

⑦ <◀◀>/<▶▶>:

In audio operation, selecting and rewinding/fast-forwarding tracks as well as radio station tuning can be performed.

 "Audio operations" (page 3-8)

⑧ <BACK>:

Depending on the screen, pushing the button will display the previous screen.

Push and hold to quit the voice recognition session (if equipped).

 "7. Voice recognition"

⑨ <⏪ /OK> (models with navigation system):

When a menu screen is displayed, turn the dial to select items on the screen.

Push to confirm the selected item or setting.

On the map screen, turn to adjust the map scale.

The button can also be used for audio operations.

 "Audio operations" (page 3-8)

<TUNE-SCROLL/OK> (models without navigation system):

When a menu screen is displayed, turn the dial to select items on the screen.

Push to confirm the selected item or

setting.

The button can also be used for audio operations.

 "Audio operations" (page 3-8)

⑩ <📞> (models without navigation system):

Push to display the phone screen.

 "4. Hands-Free Phone"

INFO:

Depending on conditions, menu items may not be selected by turning <TUNE-SCROLL/OK>/<⏪ /OK>.

LIQUID CRYSTAL DISPLAY

The display on this unit is a liquid crystal display and should be handled with care.

WARNING

Never disassemble the display. Some parts utilize extremely high voltage. Touching them may result in serious personal injury.

Characteristics of liquid crystal display

- If the temperature inside the vehicle is especially low, the display will stay relatively dim or the movement of the images may be slow. These conditions are normal. The display will function normally when the interior of the

vehicle has warmed up.

- Some pixels in the display are darker or brighter than others. This condition is an inherent characteristic of liquid crystal displays, and it is not a malfunction.
- A remnant of the previous display image may remain on the screen. This screen burn is inherent in displays, and it is not a malfunction.
- The screen may become distorted by strong magnetic fields.
- Depending on the condition, brightness may be adjusted automatically to prevent the display from screen burning.

Maintenance of display

To clean the display screen, use a dry, soft cloth. If additional cleaning is necessary, use a small amount of neutral detergent with a soft cloth. Never spray the screen with water or detergent. Dampen the cloth first, then wipe the screen.

CAUTION

- **Clean the display with the power switch in the OFF position. If the display is cleaned while the power switch is placed in the ON position or when the READY to drive indicator light is on, unintentional operation may occur.**

1. Getting started

- To clean the display, never use a rough cloth, alcohol, benzene, thinner or any kind of solvent or paper towel with a chemical cleaning agent. They will scratch or deteriorate the panel.
- Do not splash any liquid, such as water or car fragrance, on the display. Contact with liquid will cause the system to malfunction.

STEERING WHEEL SWITCHES

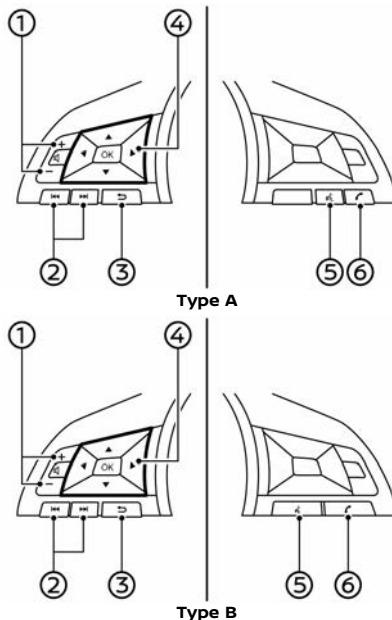

① < >:

Push the + or - side of the switch to adjust the volume.

② < > / < >:

This switch can be used for audio control.

"Audio operations" (page 3-8)

③ < > (Back):

Push to go back to the previous screen while operating the Voice Recognition System (if equipped). Push and hold to end a voice recognition session.

"7. Voice recognition"

④ < > / < > / < > / < > / < >:

Push < > / < > to select the voice command while operating the Voice Recognition menu screen (if equipped). Push < > to confirm the selected item.

Push < > / < > to switch to the previous or next page while operating the Voice Recognition menu screen (if equipped).

"7. Voice recognition"

⑤ < > (TALK):

Push to use the Voice Recognition System (if equipped). Push and hold to end the voice recognition session.

"Giving voice commands" (page 7-2)

When Apple CarPlay (if equipped) or Android Auto (if equipped) is active, pushing and holding this switch will start a Siri or Google Assistant voice control session.

"Siri operation" (page 5-8)

"Google Assistant™ operation" (page 5-12)

If your iPhone is connected to the in-vehicle system via Bluetooth®, Siri

Eyes Free (if equipped) can be activated by pushing and holding this switch without having to activate Apple CarPlay (if equipped).

 "Siri Eyes Free" (page 5-15)

⑥ <  >:

Push to answer a received call or to end an active call.

 "4. Hands-Free Phone"

When no call is received or when there is no active call, pushing this switch will display the phone screen.

 "Phone screen" (page 4-3)

Depending on models and conditions, pushing and holding this switch will start a voice recognition session for making a phone call.

INFO:

Steering wheel switches are mainly for the vehicle information display control and may not be able to operate the touch screen display depending on the conditions.

For details of the vehicle information display, refer to the LEAF Owner's Manual.

USB (Universal Serial Bus) CONNECTION PORT AND AUX (auxiliary) INPUT JACK (if equipped)



WARNING

Do not connect, disconnect or operate the USB device while driving. Doing so can be a distraction. If distracted you could lose control of your vehicle and cause an accident or serious injury.



CAUTION

- **Do not force the USB device into the USB connection port. Inserting the USB device tilted or up-side-down into the port may damage the port. Make sure that the USB device is connected correctly into the USB connection port.**
- **Do not grab the USB connection port cover (if equipped) when pulling the USB device out of the port. This could damage the port and the cover.**
- **Do not leave the USB cable in a place where it can be pulled unintentionally. Pulling the cable may damage the port.**

The vehicle is equipped with USB connection port(s) and an AUX input jack (if equipped). When connected, the in-vehicle audio system can play audio contents

from the compatible device.

The USB connection port(s) and the AUX input jack (if equipped) are located on the lower part of the instrument panel.

Type A:

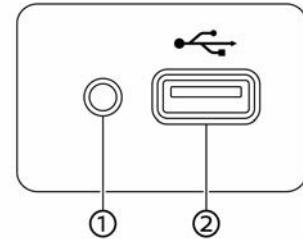

① AUX (Auxiliary) input jack:

Connect an audio player that accepts a 3.5 mm (1/8 in) TRS connector (such as an MP3 player etc.) to play music.

② USB connection port:

Connect a compatible device to play media such as an iPod or a USB memory device.

Connect an iPhone or an Android phone to use Apple CarPlay (if equipped) or Android Auto (if equipped).

Type B:

1. Getting started

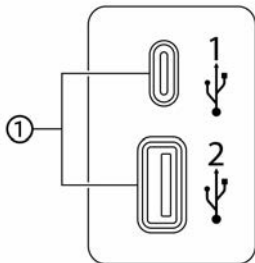

① USB connection port

Connect a compatible device to play media such as an iPod or a USB memory device.

Connect an iPhone or an Android phone to use Apple CarPlay (if equipped) or Android Auto (if equipped).

INFO:

- Refer to your AUX (if equipped) and USB device manufacturer's owner information regarding the proper use and care of the device.
- Cables made by Apple Inc. should be used to connect electronic devices marketed by Apple Inc.

STARTING SYSTEM

The system starts when the power switch is placed in the ACC or ON position.

START-UP SCREEN (if equipped)

The start-up screen is displayed when the power switch is placed in the ACC or ON position.

After an animated start-up screen is displayed, a message screen will be displayed. Touch [OK] after reading and agreeing to the message displayed on the screen. If you do not agree to the message, some of the functions on the system will be disabled.

NOTE:

Do not keep the system running with the EV system stopped. Doing so may discharge the vehicle battery (12V battery). When you use the system, always keep the EV system running.

BASIC OPERATION

The system can be operated with the touch panel as well as switches on the control panel and the steering wheel.

This manual mainly describes the touch panel operation.

SELECTING MENU FROM LAUNCH BAR

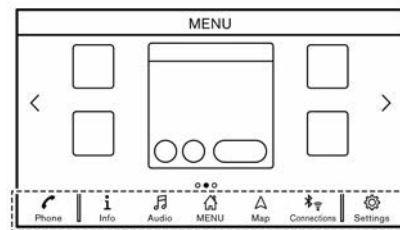

① Models with navigation system

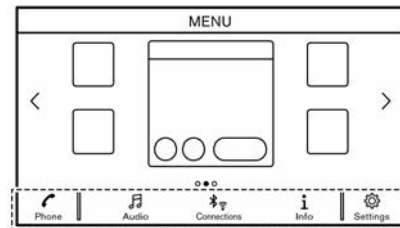

① Models without navigation system

Various system functions can be accessed

by touching the items on the Launch Bar ① which is displayed on most of the main menu screens. (The Launch Bar does not appear on some screens such as scrolled map screen (if equipped), keyboard screen, etc.)

Touch the item on the Launch Bar to display the corresponding screens.

The items on the Launch Bar differ according to which button on the control panel is pushed.

The following menus are available on the Launch Bar.

When pushing <MENU>:

Shortcuts for various functions are displayed.

Displayed items may vary depending on models and specifications.

- [Phone]*
☞ "Phone" (page 4-4)
- [Info]
☞ "Information menu" (page 5-2)
- [Audio]
☞ "Audio operations" (page 3-8)
- [MENU]
Touching [MENU] on the Launch Bar will display the center page of the HOME MENU screen.
- [Map]
☞ "Displaying navigation screen" (page 6-2)

- [Connections]
☞ "Connections settings" (page 1-16)
- [Settings]
☞ "System settings" (page 1-14)

*: [Phone] will be replaced by [CarPlay] when Apple CarPlay (if equipped) is active, and it will be replaced by [A] when Android Auto (if equipped) is active.

When pushing <AUDIO>:

Shortcuts mainly for the audio functions are displayed.

☞ "Selecting audio source" (page 3-8)

When pushing <MAP> (if equipped):

Shortcuts mainly for the navigation functions are displayed.

☞ "Launch Bar" (page 6-2)

DISPLAYING EV INFO MENU SCREEN (if equipped)

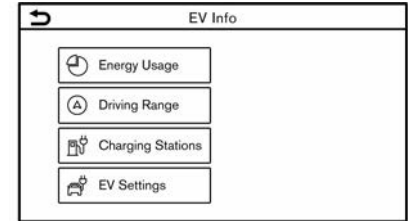

Touch [Info] on the Launch Bar and touch [EV Info] to display the menu screen where several useful functions for Electric Vehicle (EV) driving can be set. Select a preferred menu and touch an item to be set.

☞ "EV Info menu screen" (page 2-2)

TOUCH PANEL OPERATION

The system can be controlled mainly by the touch panel operation.

The following operations are examples of the touch panel operation.

The map operations are also available with touch panel operation.

☞ "Map operation" (page 6-3)

1. Getting started

- **Touch**

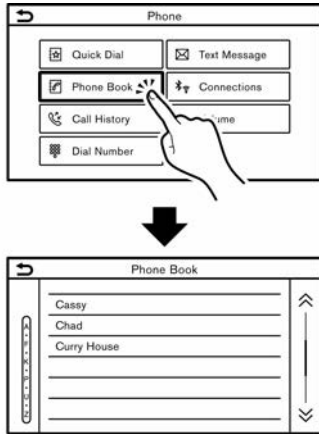

Example

Touch the item on the screen to display the corresponding screen.

- **INFO:**

Some keys function differently depending on whether the key is touched briefly or when it is being touched and held for a few seconds.

- **Swipe/Flick**

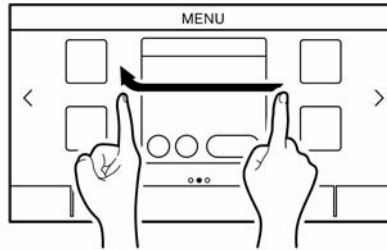

Menu screen pages will skip to the next page when swiped/flicked horizontally.

Some of the list screens can also be scrolled by swiping/flicking on the screen vertically.

MAIN SCREEN OPERATIONS

The following operations are generally available on the various screen.

- **Displaying previous screen**

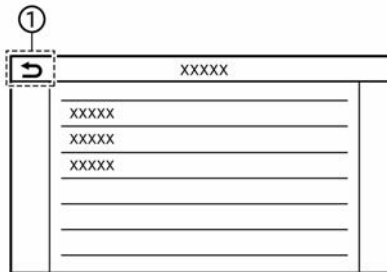

① Touch [↶] to return to the screen displayed previously.

- **Horizontal scrolling**

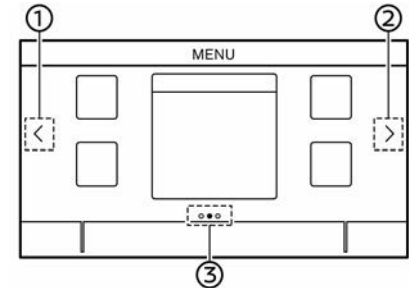

① Touch [◀] to scroll to the previous page.

② Touch [▶] to scroll to the next page.

③ Indicates the position of the currently displayed page.

• Vertical scrolling

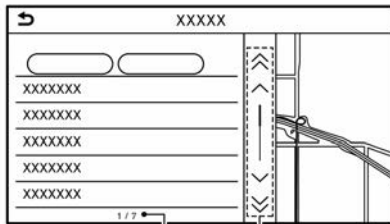

Example

- ① Touch [▲] or [▼] to skip to the previous or next page.
Touch [^] or [v] (if equipped) to scroll the message or list one item at a time.
- ② Indicates the total number of items in the list and the entry number of the selected item.

INFO:

Depending on the screens, swiping on the touch screen can scroll pages vertically or horizontally.

• Scrolling list by selecting alphabet

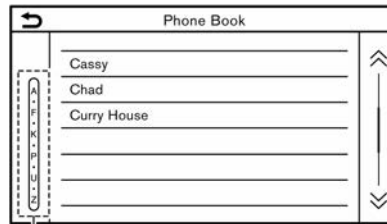

- ① Touch a preferred location within the alphabetical list.
The detailed alphabetical list will be shown. Touch to scroll the list items to the section that begins with the letter selected.

ADJUSTING SETTINGS

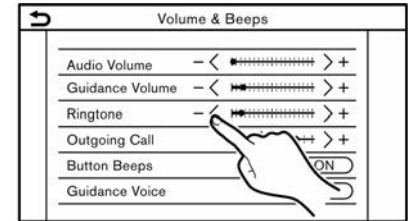

Example

Touch adjustment keys, such as [-]/[+], etc., to adjust each item. Each time a key is touched, the indicator moves along the bar.

For items with [ON] indicator, touch the menu item to turn on/off the setting. The indicator light will turn on when the setting is turned on.

HOW TO INPUT LETTERS AND NUMBERS

Basic operations to enter letters and numbers are explained here.

Character and number input screens vary depending on the conditions.

1. Getting started

English character input screen (if equipped)

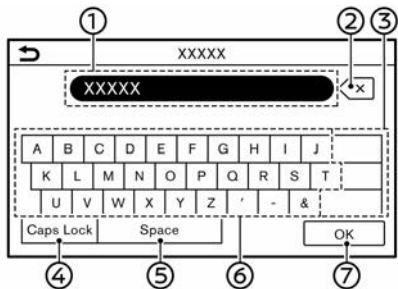

- ① Entered characters are displayed.
- ② Touch to delete the last character entered.
Touch and hold to delete all the characters entered.
- ③ Touch to change the type of keyboard.
- ④ Touch to switch between the uppercase and lowercase character input screen.
- ⑤ Touch to enter a space.
- ⑥ Touch to enter a character.
- ⑦ Touch to confirm the entry.

Taiwanese character input screen (if equipped)

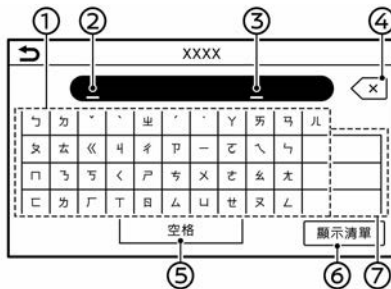

- ① Touch to enter Zhuyin characters.
- ② Entered characters are displayed.
- ③ Entered Zhuyin characters are displayed. Candidate Chinese characters are displayed above the entered Zhuyin characters. Touch to select a Chinese character. Touch [Show All] to display all of the candidate characters.
- ④ Touch to delete the last character entered. Touch and hold to delete all the characters entered.
- ⑤ Touch to enter a space.
- ⑥ Touch to confirm the entry.
- ⑦ Touch to change the type of keyboard.

[ABC]: Displays alphabet input screen.

[Zhuyin]: Displays Zhuyin input screen.

[123]: Displays number input screen.

Arabic character input screen (if equipped)

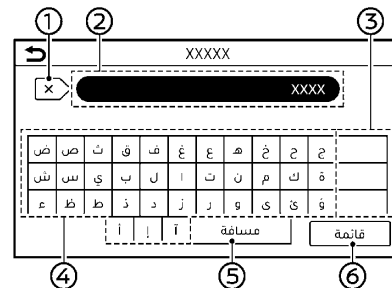

- ① Touch to delete the last character entered.
Touch and hold to delete all the characters entered.
- ② Entered characters are displayed.
- ③ Touch to change the type of keyboard.
- ④ Touch to enter a character.
- ⑤ Touch to enter a space.
- ⑥ Touch to confirm the entry.

Korean character input screen (if equipped)

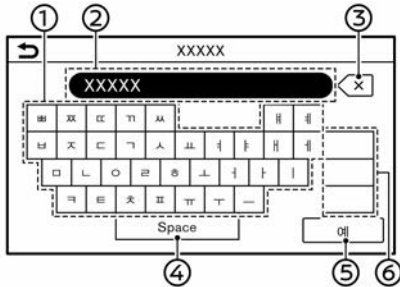

- ① Touch to enter a character.
- ② Entered characters are displayed.
- ③ Touch to delete the last character entered.
Touch and hold to delete all the characters entered.
- ④ Touch to enter a space.
- ⑤ Touch to confirm the entry.
- ⑥ Touch to change the type of keyboard.

Number input screen

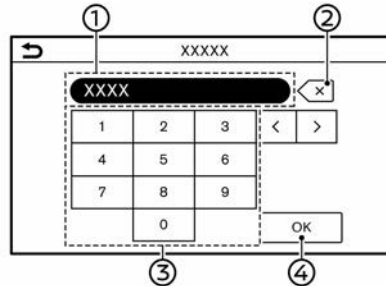

- ① Entered numbers are displayed.
- ② Touch to delete the last number entered.
Touch and hold to delete all the numbers entered.
- ③ Touch to enter a number.
- ④ Touch to confirm the entry.

HOW TO VIEW AND OPERATE HOME MENU SCREEN

Push **<MENU>** to display the HOME MENU screen.

The HOME MENU consists of 3 pages which can display preferred shortcuts and widgets.

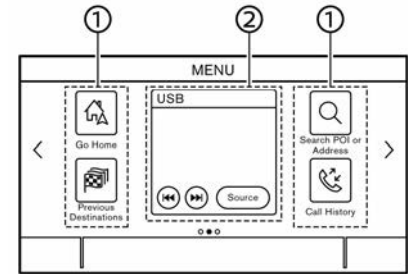

Example

- ① Shortcut icons:
Icons for frequently used menu items can be placed on the HOME MENU screens as shortcuts.
- ② Widget:
Useful information from primary menu functions can be displayed as widgets. Depending on the contents of the widget, keys may be available for operation of the function.

1. Getting started

Customizing HOME MENU screen

The HOME MENU screen can be personalized by selecting which shortcuts and widgets are to be displayed and where to place them on the screen.

Selecting shortcut or widget:

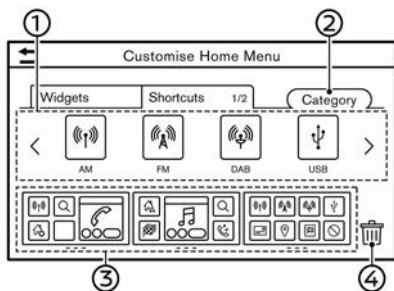

Example

1. Touch [Settings] on the Launch Bar.
2. Touch [Customise Home Menu].
3. Touch [Shortcuts] or [Widgets].
4. Drag the shortcut or widget icon ① to each page layout ③.

If a different shortcut or a widget is already located on the page layout ③, a message will be displayed. Touch [Yes] to replace the shortcut/widget. The page layout ③ can be changed by dragging the icons.

The categories of shortcuts can be changed by touching [Category] ②.

Dragging an icon into the [Delete] ④ can

delete the current shortcut or widget to create a blank spot.

INFO:

Touch [Delete] ④, and then a message will appear. While the message is displayed, touching any icon on the page layout ③ and [Delete] can delete the selected icon. To delete all icons, touch [Select All] and then [Delete].

Available shortcut/widget categories:

Available shortcut categories:

- Models with navigation system
 - [Audio]
 - [Route]
 - [Phone]
 - [Settings]
 - [Info]
 - [Voice Recognition]
 - [Destination]
- Models without navigation system
 - [Audio]
 - [Phone]
 - [Settings]
 - [Info]
 - [Voice Recognition]

Available widgets:

- Models with navigation system
 - [Phone]
 - [Audio]
 - [Map]
 - [Turn by Turn]
 - [Weather]
 - [Clock]
 - [Climate Control]
- Models without navigation system
 - [Phone]
 - [Audio]
 - [Clock]

INFO:

- Available items may vary depending on models and specifications. Items displayed on the screen may not function depending on various conditions.
- The HOME MENU screen can display up to 8 shortcuts on a page.
- Some widgets, such as [Audio], [Clock], etc., can be selected from 2 shortcut spot sizes and 4 shortcut spot sizes. All other widgets require 4 shortcut spot sizes to be displayed.

FUNCTIONS DISABLED WHILE DRIVING (if equipped)

To ensure safe driving, some functions cannot be operated while driving.

The on-screen functions that are not available while driving will be "grayed-out" or muted. In some cases, certain text will not be displayed on the screen.

To use these functions, first park the vehicle in a safe location and then operate the system.

1. Getting started

SYSTEM SETTINGS











The system settings can be changed for personal convenience.









SETTINGS MENU

Touch [Settings] on the Launch Bar and touch a setting item you wish to adjust.

Available setting items may vary depending on models and specifications.

Available setting items

Setting item	Result
[Connections]	Displays the Bluetooth®, Wi-Fi (if equipped), USB and Apps setting screen.  "Connections settings" (page 1-16)
[Phone]	Displays the Phone and text message settings screen.  "Phone and text message settings" (page 4-10)
[Navigation]	Displays the navigation settings screen.  "Navigation settings" (page 6-45)
[Sound]	Displays the audio settings screen.  "Audio settings" (page 3-26)
[Volume & Beeps]	Displays the volume adjustment screen.  "Volume and Beeps settings" (page 1-19)
[Clock]	Displays the clock adjustment screen.  "Clock settings" (page 1-20)
[Customise Home Menu]	Displays the HOME MENU editing screen.  "Customizing HOME MENU screen" (page 1-12)
[Customise Audio Sources]	Displays the editing screen for audio source menus on the Launch Bar.  "Selecting from Launch Bar" (page 3-9)
[NissanConnect Services]	Displays the NissanConnect Services settings screen.  "NissanConnect Services" (page 5-6)
[System Voice]	Displays the system voice settings screen.  "System Voice settings" (page 7-5)
[Camera]	Displays the camera settings screen. See the LEAF Owner's Manual for details of the monitor system.

[Parking]		Displays the ProPILOT Park settings screen. See the LEAF Owner's Manual for details of the monitor system.
[More Settings]	[Display]	Displays the display settings screen.  "Display settings" (page 1-21)
	[Language]	Displays the language settings screen.  "Language setting" (page 1-21)
	[Units]	Displays the units settings screen.  "Units settings" (page 1-21)
	[Keyboard Type]	Keyboard type can be selected.  "Keyboard type settings" (page 1-22)
	[Return All Settings to Default]	This resets all settings to default.  "Return all settings to default" (page 1-22)
[System Update]	[Version Information]	Displays the version information screen.
	[Software Update]	The system software can be updated.  "Updating system software" (page 5-5)
	[Map Update]	The map data can be updated.  "How to update map data" (page 6-53)
[Apps]	Device list	Displays recently connected Apple CarPlay or Android Auto devices.  "Apple CarPlay settings" (page 5-10)  "Android Auto settings" (page 5-14)



INFO:

The system software (if equipped) and map (if equipped) update menus can also be accessed from [System Information] on the information screen.

 "Information menu" (page 5-2)

1. Getting started

CONNECTIONS SETTINGS

Changing the settings and viewing information of Bluetooth®, Wi-Fi (if equipped), USB and Apps are available on the Connections settings screen.

Setting Bluetooth®

Your vehicle is equipped with the Bluetooth® Hands-Free Phone System and Bluetooth® audio device support. If you are an owner of a compatible Bluetooth® enabled cellular phone or Bluetooth® audio device, you can set up the wireless connection between your cellular phone and the in-vehicle phone module or Bluetooth® audio device and in-vehicle audio module. With Bluetooth® wireless technology, you can make or receive a telephone call with your cellular phone in your pocket and listen to Bluetooth® audio.

 "Bluetooth® audio" (page 3-21)

 "Bluetooth® Hands-Free Phone System" (page 4-2)

Connecting cellular phone/audio device:

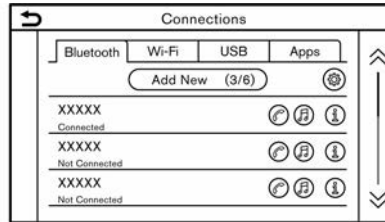

Example









To use the Bluetooth® device with the in-vehicle system for the first time, the device connection operation is required.

1. Touch [Settings] on the Launch Bar.
2. Touch [Connections].
3. Touch [Bluetooth] and touch [Add New]. A message is displayed.
4. Touch [Yes] to connect a cellular phone. Touch [No] to connect an audio device and operate as guided by the system. (Operations may differ depending on the device.)

NOTE:

Some cellular phones or other devices may cause interference or a buzzing noise to come from the audio system speakers. Storing the device in a different location may reduce or eliminate the noise.

INFO:

- The paired phone will be added to the list on the Bluetooth® connection screen.
- Touching name of the other device on the list will switch the connected device.
- Touching  will allow the device to be connected via Bluetooth® and be used on the Hands-Free Phone System.
- You can register a favorite hands-free phone. The  by the phone device name selected as a favorite will be marked with "★".
 "Bluetooth® settings" (page 1-17)
- Touching  will allow the device to be connected via Bluetooth® and be used for Bluetooth® audio.
- You can register a favorite Bluetooth® audio device. The  by the audio device name selected as a favorite will be marked with "★".
 "Bluetooth® settings" (page 1-17)
- Touching  will display the information of the Bluetooth® device.
- Touch  (if equipped) to use Bluetooth® tethering.
- Up to 6 Bluetooth® devices can be registered. If 6 devices are already registered, one of the devices must first be deleted before another device

can be registered.

- The pairing procedure of the cellular phone varies according to each cellular phone. See the cellular phone Owner's Manual for the details.
- Consult a NISSAN dealer for information regarding Bluetooth® device connection to your vehicle.

Bluetooth® settings:

The Bluetooth® settings can be changed according to your preference.

1. Touch [Settings] on the Launch Bar.
2. Touch [Connections].
3. Touch [Bluetooth].
4. Touch [⊗].

Available setting items

Setting item	Action
[Bluetooth]	Turns the Bluetooth® connection on/off.
[Allow 2 Phones Simultaneously]	When turned on, up to 2 Bluetooth® devices can be connected to the in-vehicle system simultaneously.
[Favourite Phone]	A Bluetooth® device can be registered as a favorite hands-free phone. If the hands-free phone device is within the range with Bluetooth® turned on, the device registered as favorite will automatically be connected to the in-vehicle system with priority upon the system activation.
[Favourite Audio]	A Bluetooth® device can be registered as a favorite audio device. If the Bluetooth® audio device is within the range with Bluetooth® turned on, the device registered as favorite will automatically be connected to the in-vehicle system with priority upon the system activation.
[Device Name]	The device name can be changed.

[PIN]	The PIN code can be changed.
-------	------------------------------



INFO:

With [Device Name], the device name that appears on the screen can be changed and be renamed from the name set as default to the preferred name (such as "Steve's Car" for example).

Deleting cellular phone/audio device:

Paired devices can be deleted from the list.

1. Touch [Settings] on the Launch Bar.
2. Touch [Connections].
3. Touch [Bluetooth].
4. Touch [⊗] by the cellular phone name you wish to delete.
5. Touch [Delete]. Touch [Yes] when a message appears.

Wi-Fi setting (if equipped)

A Wi-Fi connection can be made by using an available Wi-Fi network near the vehicle or tethering function of smartphone, etc. Wi-Fi connectivity is useful for updating map data (if equipped) and system software (if equipped), or using online services such as Online Search (if equipped) or Premium Traffic (if equipped).

"Updating system software" (page 5-5)

"How to update map data"

1. Getting started

(page 6-53)

📖 "Online Search" (page 6-15)

📖 "Premium Traffic information"

(page 6-36)

Connecting to a Wi-Fi network:

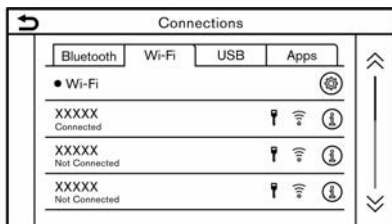

Example

To use the Wi-Fi connection for the first time, the following connecting procedures are required.

1. Touch [Settings] on the Launch Bar.
2. Touch [Connections].
3. Touch [Wi-Fi].
4. Touch the name of the device you wish to connect.

	Indicates that a password is set.
	Indicates the strength of the signal the Wi-Fi device is receiving.

5. Enter the network password and touch [OK]. The device will be connected.

If a listed device is in a status capable of making Wi-Fi connection, touching the device name on the list will start

the connection.

INFO:

- Enter the password correctly, including capitalization.
- Touching [ⓘ] will display the network information. Turning [Auto Connect] on will automatically connect the vehicle to the network if the network is available.
- Touch [Vehicle Hotspot] (if equipped) and turn on the indicator to activate the Wi-Fi hotspot communication. It enables devices such as smartphones to connect to a Wi-Fi network.
- Enabling the Wi-Fi hotspot functionality of your smartphone may incur additional charges from your cellular provider. Consult your cellular provider contract regarding the communication fee.
- System can connect to only WPA2 security network (not connect WEP, WPA1 network).
- Wi-Fi networks that require a web browser cannot be accessed through this unit.

Wi-Fi settings:

The Wi-Fi settings can be changed according to your preference.

1. Touch [Settings] on the Launch Bar.
2. Touch [Connections].
3. Touch [Wi-Fi].
4. Touch [ⓘ].
5. Touch a preferred item.

Available setting items

Available setting items may vary depending on models and specifications.

Setting item	Action
[Wi-Fi]	Turns the Wi-Fi connection on/off.
[Vehicle Hotspot]	Turns the vehicle hotspot on/off.
[Network Name (SSID)]	Displays the Wi-Fi network name.
[Password]	Displays the Wi-Fi network password.

Deleting Wi-Fi network:

The stored Wi-Fi network can be deleted from the list.

1. Touch [Settings] on the Launch Bar.
2. Touch [Connections].
3. Touch [Wi-Fi].
4. Touch [ⓘ] by the name of the network you wish to delete.

5. Touch [Delete]. Touch [Yes] when a message appears.

Displaying USB device information

The information of the connected USB device can be viewed.

 "USB memory device player" (page 3-15)

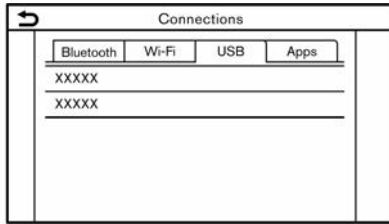

Example

1. Touch [Settings] on the Launch Bar.
2. Touch [Connections].
3. Touch [USB].
4. Touch the name of the device you wish to check. The name and the type of the device are displayed.

Apps settings

A list of devices that have been connected recently for Apple CarPlay (if equipped) or Android Auto (if equipped) is displayed, and settings for each device can be changed.

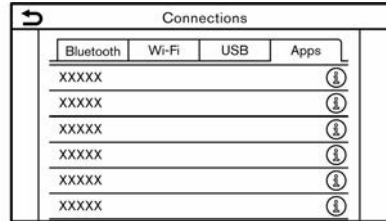



Example

The apps settings can be changed according to your preference.

1. Touch [Settings] on the Launch Bar.
2. Touch [Connections].
3. Touch [Apps].
4. Touch  by the name of the device you wish to change the setting.
5. Touch a preferred item.

INFO:

Displayed items may vary depending on the apps.

-  "Apple CarPlay settings" (page 5-10)
-  "Android Auto settings" (page 5-14)

VOLUME AND BEEPS SETTINGS

The volume of various functions including audio, phone, navigation voice guidance (if equipped), and system beeps can be adjusted.

1. Touch [Settings] on the Launch Bar.
2. Touch [Volume & Beeps].

Available setting items may vary depending on models and specifications.

Available setting items

Setting item	Action
[Audio Volume]	Adjusts the volume level of the audio system.
[Guidance Volume]	Adjusts the volume level of the navigation guidance voice.
[Ringtone]	Adjusts the volume level of the ringtone of incoming calls.
[Outgoing Call]	Adjusts the volume level of the outgoing calls.
[Button Beeps]	Turns on/off the button beep sound and alarm for prohibited operations.
[Guidance Voice]	Turns on/off the voice guidance.

1. Getting started

CLOCK SETTINGS

Clock settings of the system can be changed.

1. Touch [Settings] on the Launch Bar.
2. Touch [Clock].

Available setting items may vary depending on models and specifications.

Available setting items

Setting item 1	Setting item 2	Action
[On-Screen Clock]		Sets the clock display on/off. When this item is on, the clock display appears.
[Clock Mode]	[Auto]	Adjusts clock time automatically using Global Navigation Satellite System (GNSS).
	[Time Zone]	Adjusts clock time reflecting selected time zone.
	[Manual]	Reflects [Set Clock Manually] settings.
[Clock Format]	[12H]	The clock can be set to 12 hours or 24 hours.
	[24H]	
[Date Format]		The display format of the day, month and year display can be selected.
[Offset (hour)]		Adjusts the offset value (hour/minutes). [Clock Mode] must be set to [Auto] or [Time Zone] for this option.
[Offset (min.)]		
[Summer Time]		Turns on/off the summer time setting. This option becomes available only when [Clock Mode] is set to [Time Zone].
[Time Zone]		Select an appropriate time zone from the list. [Clock Mode] must be set to [Time Zone] for this option to be available.
[Set Clock Manually]		Adjusts the clock manually. Touch [+] or [-] to adjust the hours, minutes, day, month and year up or down. When [Clock Format] is set to [12H], [AM]/[PM] can be selected. Models with navigation system: [Clock Mode] must be set to [Manual] for this option to be available.



INFO:

- When the [On-Screen Clock] setting is turned on, the clock settings screen can also be displayed by touching the clock at the upper right corner of the screen.
- The clock setting of the vehicle information display will also change when the setting of the clock displayed on the touch screen display is changed.

DISPLAY SETTINGS

Display settings can be adjusted.

1. Touch [Settings] on the Launch Bar.
2. Touch [More Settings].
3. Touch [Display].
4. Touch a preferred item to adjust the setting.

Available setting items

Setting item	Action
[Display]	Turns the screen off. Pushing and holding <⌘/> will also turn off the screen. Push <⌘/> to turn the screen back on.
[Brightness]	Adjusts the brightness of the display.
[Contrast]	Adjusts the contrast of the display.
[Black Level]	Adjusts the black level of the display.

LANGUAGE SETTING

This changes the language used in the system.

1. Touch [Settings] on the Launch Bar.
2. Touch [More Settings].
3. Touch [Language].

Selects the preferred system language.

The language setting is applied to the touch screen display, voice announcements, and the Voice Recognition System (if equipped).



INFO:

- If the selected language is also supported by the vehicle information display, a confirmation message asking if you also wish to change the vehicle information display language is displayed. Select [Yes] to apply the language setting to the vehicle information display as well.
- Models with navigation system: If the language is not set to the standard language of the current vehicle position, the route guidance, etc. for map operation are not avail-

able.

- Do not change the position of the power switch while changing the language.

UNITS SETTINGS (if equipped)

This changes the units used in the system.

1. Touch [Settings] on the Launch Bar.
2. Touch [More Settings].
3. Touch [Units].

Available setting items may vary depending on models and specifications.

Setting item	Action
[Distance]	Select the distance unit.
[Temperature]	Select the temperature unit.



INFO:

- Do not change the position of the power switch while changing the units for distance or temperature.
- Depending on the models, the unit settings of the vehicle information display and the touch screen display are linked, and changing one of the

1. Getting started

unit settings will also change the unit setting of the other display.

KEYBOARD TYPE SETTINGS

The keyboard layout of the character input screens can be selected.

1. Touch [Settings] on the Launch Bar.
2. Touch [More Settings].
3. Touch [Keyboard Type]. The type of keyboard switches to available type.

RETURN ALL SETTINGS TO DEFAULT

This resets all settings to default.

1. Touch [Settings] on the Launch Bar.
2. Touch [More Settings].
3. Touch [Return All Settings to Default].
4. A confirmation message is displayed. Touch [Yes] to set the settings to default.

2 Unique EV functions (models with navigation system)





EV Info menu screen	2-2
Displaying estimated driving range and charging station information	2-3
Displaying estimated driving range	2-3
Displaying charging station icons on map	2-5
Energy usage information display	2-6
Viewing energy usage information	2-6
Unique EV function settings	2-7
Li-ion battery information guidance (if equipped)	2-9



2. Unique EV functions (models with navigation system)

EV INFO MENU SCREEN

Touch [Info] on the Launch Bar and touch [EV Info] to display the menu that includes useful functions for Electric Vehicle (EV) driving.

Setting items	Action
[Energy Usage]	Energy usage information is displayed on the screen.  "Energy usage information display" (page 2-6)
[Driving Range]	The estimated driving area within range, including the current position, is displayed on the map screen.  "Displaying estimated driving range" (page 2-3)
[Charging Stations]	Charging station information is displayed.  "Finding charging station" (page 6-19)
[EV Settings]	Various EV-specific settings can be adjusted from this menu.  "Unique EV function settings" (page 2-7)

2. Unique EV functions (models with navigation system)

DISPLAYING ESTIMATED DRIVING RANGE AND CHARGING STATION INFORMATION

The estimated driving range and charging station information are displayed on the map screen.



CAUTION

Charging station information may not be detailed in all areas or reflect current charging station locations. For up-to-date information about charging stations, such as business hours or charging equipment, NISSAN recommends that you directly access the information on your own. Additionally, always check the remaining amount of Li-ion battery available charge and set a reasonable driving schedule.

DISPLAYING ESTIMATED DRIVING RANGE

The estimated driving range including the current position or the destination is displayed on the map screen depending on the charging status of the vehicle. A destination or a waypoint can be set on this screen.



INFO:

The estimated driving range map shows the predicted area the vehicle can reach on the basis of the estimated driving range that is indicated in the vehicle information display. Driving habits, the actual road environment (hills, etc.), and traffic conditions (traffic jams, etc.) will affect the actual available range.

To display the estimated driving range, take the following procedure.

1. Push <MENU>.
2. Touch [Info] on the Launch Bar and then touch [EV Info].
3. Touch [Driving Range].
 "EV Info menu screen" (page 2-2)



INFO:

The estimated driving range will increase or decrease when the air conditioner, heater or Li-ion battery warmer (if equipped) is turned on or off, or the vehicle is shifted between D (Drive) and ECO, or when any other accessory is

turned on or off based on driving.

2. Unique EV functions (models with navigation system)

How to view driving range screen

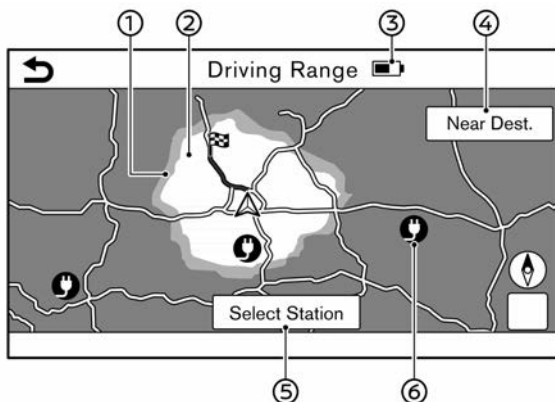

① Driving range (gray):

An estimated extended driving range when the climate control system is turned off is displayed.

② Driving range (light gray):

The estimated driving range based on the current charging condition is displayed.

③ Li-ion battery indicator:

Indicates the amount of remaining Li-ion battery charge.

④ [Near Dest.]/[Waypoint]:

[Near Dest.] is displayed when only one location is set as a destination. [Waypoint] is displayed when a desti-

nation and waypoint(s) are set.

Touching [Near Dest.] will show an estimated driving range from the destination, taking the estimated amount of remaining Li-ion battery charge at the destination into consideration.

Touching [Waypoint] will show an estimated driving range from the nearest waypoint, taking the estimated amount of remaining Li-ion battery charge at the waypoint into consideration.

Touch [↶] to return to the screen with an estimated driving range from the current vehicle position.

⑤ [Select Station]:

When touched, charging stations found within the estimated driving range are displayed and can be set as destination/waypoint(s).

☞ "Finding charging station" (page 6-19)

⑥ Charging station icons:

- 🔌 : Normal charging station
- ⚡ : Quick charging station

INFO:

- The estimated driving range is displayed in either gray or light gray, calculating the distance from the current position or the destination/waypoint. The area displayed in dark gray indicates that the area cannot be reached with the amount of remaining Li-ion battery charge.
- Note that the displayed ranges are estimations and should only be used as a reference.

2. Unique EV functions (models with navigation system)

Setting a charging station as destination

While the estimated driving range is displayed on the map screen, the spot where the cross pointer is placed by moving the map can be set for the destination.

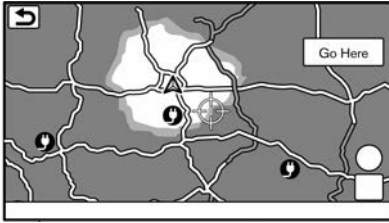

1. Scroll the map, place the cross pointer over the preferred location, and touch [Go Here].
2. When a message asking if you wish to set the location as a destination, touch [Yes].
3. The system sets the destination to the selected location and starts calculating a route.

INFO:

- You can also search for a charging station by touching [Select Station] on the driving range screen.
 "How to view driving range screen" (page 2-4)
- This procedure only allows you to set a destination or waypoint on the driving

range screen. The system does not automatically set a desired charging station as a destination or waypoint. When setting a charging station displayed on the map as a destination by moving the map, zoom in the map and set a point as a destination as precisely as possible. If the destination is not set precisely, the system may provide guidance to a location that is not a charging station.

DISPLAYING CHARGING STATION ICONS ON MAP

The charging station icons, as well as the other landmark icons, can be displayed on the map.

 "Displaying map icons" (page 6-11)

INFO:

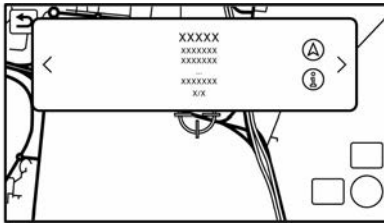

- Placing the cross pointer on the charging station icons will display the information in a pop-up window.



- When [△] is displayed on the pop-up window, the destination can be set by touching it. Touching [i] will

display the place information screen. On the place information screen, touch [Call] to call the selected place if the key is available. Touch [Go Here] to set the selected location as the destination.

- Touch [<] or [>] to scroll to the next or previous page.

- By changing the setting of [Filter for Map Icons], charging station icons to be displayed on the map can be filtered by availability status.
 "Unique EV function settings" (page 2-7)
- Map icons do not appear if the map is zoomed out above a certain level.
- Settings of the charging station icons registered in the Address Book cannot be changed with this procedure.
 "Editing stored location" (page 6-41)







Confirming charging station availability (for models with NissanConnect Services)

Availability of charging stations can be displayed in color coded icons by connecting to the Nissan Data Center. Perform the following procedure to turn on the setting.

1. Push <MENU>.
2. Touch [Info] on the Launch Bar.

2. Unique EV functions (models with navigation system)

3. Touch [EV Info].
4. Touch [EV Settings].
5. Touch [Charging Availability] to turn on the setting.

Icons	Charging station type	Availability
	Normal charging station icon	Green: Fully or partly vacant Red: Full
	Quick charging station icon	
	Normal charging station icon	Closed or out of service
	Quick charging station icon	
	Normal charging station icon	No information
	Quick charging station icon	

ENERGY USAGE INFORMATION DISPLAY

Energy usage information can be displayed.

VIEWING ENERGY USAGE INFORMATION

Estimated driving range and energy usage status of various systems, perform the following procedure.

1. Push **<MENU>**.
2. Touch [Info] on the Launch Bar and then touch [EV Info].
3. Touch [Energy Usage].

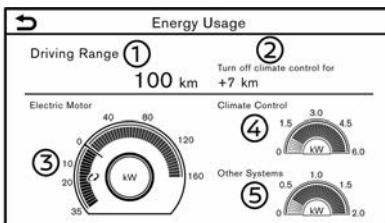

Example

- ① **Driving Range:**
The possible driving distance based on the current charging status is displayed.
- ② **Variable distance:**
When the climate control system is turned on, the additional distance the vehicle can drive by turning the climate control system off is displayed.

When the climate control system is turned off, the distance the vehicle can drive less if the climate control system is turned on is displayed.

- ③ **Electric Motor:**
Energy usage by the motor and regenerated energy are displayed.
- ④ **Climate Control:**
Energy usage by the climate control system is displayed.
- ⑤ **Other Systems:**
Energy usage by other equipment (headlights, windshield wiper, etc.) is displayed.

INFO:

Depending on the vehicle speed and the Li-ion battery status (remaining battery amount, temperature, etc.), the Electric Motor value displayed on this screen may be lower than the power meter value displayed on the vehicle information display.

2. Unique EV functions (models with navigation system)

UNIQUE EV FUNCTION SETTINGS

EV unique function settings can be changed.

An active NissanConnect Services (if equipped) subscription is needed to remotely check charging status and Li-ion battery status, use remote charging, remotely start heating and cooling and to receive e-mails/text messages.





1. Touch [EV Settings] in the EV Info menu or the Navigation Settings menu.

 "EV Info menu screen" (page 2-2)



 "Navigation settings" (page 6-45)

2. Touch the item you wish to set.

Available setting items may vary depending on models and specifications.

Setting items		Action
[Battery & Power Alerts]	[Use All Battery & Power Alerts]	Displays all battery alerts on the touch screen display.
	[Low Battery]	Displays the Low Battery message on the touch screen display to inform the driver that the Li-ion battery charge is low.  "Low Battery" (page 2-9)
	[Destination Out of Range]	Displays a message on the touch screen display to inform the driver that the Li-ion battery should be charged soon. The message will appear when the destination set in the navigation system is outside the estimated driving range.  "Destination out of range guidance" (page 2-9)
	[Out of Charging Range Alert]	Displays a message on the touch screen display to inform the driver that the Li-ion battery should be charged soon. The message will appear when no more than two charging stations are found within the estimated driving range.  "Out of charging range alert" (page 2-9)
[Email Notifications]		Sends a notification to a preset e-mail address. This notification includes the charge connector status and the charge completion.  "NissanConnect Services" (page 5-6)
[Show Charging Stations on Map]		Displays charging station icons on the map screen.  "Displaying charging station icons on map" (page 2-5)
[Filter for Map Icons]	[Closed Stations]	When this item is turned on, the charging stations that are out of business hours are displayed and shown as icons.

2. Unique EV functions (models with navigation system)

Setting items	Action
[Autosave New Charging Stations]	If charging station information you have used is not stored in the system, the location will be automatically registered in the Address Book. Turn this setting off if you do not want the charging location to be stored automatically. You can set charging stations that are automatically registered by type. Select from [Quick] and [Standard].
[Charging Availability]	Displays the current availability of charging stations in icons by connecting to the Nissan Data Center.  "Confirming charging station availability (for models with NissanConnect Services)" (page 2-5)
[Favourite Charging Locations]	Charging stations can be stored in the Address Book and reused to set destinations.  "Searching from Address Book" (page 6-18) The registration procedure is the same as the one for [Address Book].  "Storing location" (page 6-38)



2. Unique EV functions (models with navigation system)

LI-ION BATTERY INFORMATION GUIDANCE (if equipped)

Information notifying the driver of the Li-ion battery status can be displayed on the touch screen display.

For detail information about the warning/indicator lights, see the LEAF Owner's Manual.

Low Battery

When the low battery charge warning light  and the master warning light (yellow)  illuminate on the instrument panel, the system displays a message on the touch screen display that notices the driver that the Li-ion battery charge is low.

1. The notification is displayed on the upper side of the screen. Touch [Show] to display the detailed information screen.
2. The system displays a message screen to warn that the Li-ion battery charge is low. Check the message displayed on the screen.

Touch [Yes] to search for charging stations within the estimated driving range.

 "Finding charging station"
(page 6-19)

3. Touch [] or push <MAP> to return to the current location map screen.



INFO:

- The Low Battery message display setting can be turned off.
 "Unique EV function settings"
(page 2-7)
- When the Li-ion battery charge is low, the system automatically obtains charging station information.

Destination out of range guidance

If the remaining driving range is less than the distance to the destination that is entered while setting the route, the system displays a message on the touch screen display that recommends Li-ion battery charging.

1. The notification is displayed on the upper side of the screen. Touch [Show] to display the detailed information screen.
2. The system displays a message screen recommending Li-ion battery charging. Check the message displayed on the touch screen display.

Touch [Yes] to search for charging stations within the estimated driving range.

 "Finding charging station"
(page 6-19)

3. Touch [] or push <MAP> to return to the current location map screen.



INFO:

- The Destination Out of Range guidance display setting can be turned off.
 "Unique EV function settings"
(page 2-7)
- When the route is changed to avoid a traffic jam or the possible driving distance indicated in the vehicle information display is changed, the destination out of range guidance is displayed again.

Out of charging range alert

When no more than two charging stations are found within the estimated driving range, the system displays a message on the touch screen display recommending battery charging.

1. The notification is displayed on the upper side of the screen. Touch [Show] to display the detailed information screen.
2. The system displays a message screen recommending battery charging. Check the message displayed on the screen.

Touch [Yes] to search for charging stations within the estimated driving range.

 "Finding charging station"
(page 6-19)

3. Touch [] or push <MAP> to return to the current location map screen.

2. Unique EV functions (models with navigation system)



INFO:

- The Out of Charging Range Alert display setting can be turned off.
 - ☞ “Unique EV function settings”
(page 2-7)
- The guidance message may reappear when estimated driving range displayed on the vehicle information display has been changed by the change in the temperature setting on the heater/air conditioner, etc.

3 Audio system

Audio operation precautions	3-2
Radio	3-2
USB (Universal Serial Bus) connection port	3-3
Compressed Audio Files (MP3/WMA/AAC)	3-4
Bluetooth® audio	3-6
Names and functions of audio control buttons	3-7
Audio main buttons	3-7
Audio control steering wheel switches	3-7
Audio operations	3-8
Audio main operation	3-8
Radio	3-10
USB memory device player	3-15
iPod player	3-18
Bluetooth® audio	3-21
Auxiliary (AUX) devices (if equipped)	3-24
Smartphone audio (if equipped)	3-25
Audio settings	3-26
Audio adjustments with audio adjust bar	3-27
USB memory device care	3-27

3. Audio system

AUDIO OPERATION PRECAUTIONS

CAUTION

- Operate the audio system only when the vehicle EV system is running. Operating the audio system for extended periods of time with the EV system turned off can discharge the vehicle battery (12V battery).
- Do not allow the system to get wet. Excessive moisture such as spilled liquids may cause the system to malfunction.

RADIO

Place the power switch in the ACC or ON position before turning on the radio. If you listen to the radio with the EV system not running, the power switch should be placed in the ACC position.

Radio reception is affected by station signal strength, distance from radio transmitter, buildings, bridges, mountains and other external influences. Intermittent changes in reception quality normally are caused by these external influences.

Using a cellular phone in or near the vehicle may influence radio reception quality.

Radio reception

Your radio system is equipped with state-of-the-art electronic circuits to enhance radio reception. These circuits are designed to extend reception range, and to enhance the quality of that reception.

However there are some general characteristics of both FM and AM radio signals that can affect radio reception quality in a moving vehicle, even when the finest equipment is used. These characteristics are completely normal in a given reception area, and do not indicate any malfunction in your radio system.

Reception conditions will constantly change because of vehicle movement. Buildings, terrain, signal distance and interference from other vehicles can work against ideal reception. Described below are some of the factors that can affect your radio reception.

Some cellular phones or other devices may cause interference or a buzzing noise to come from the audio system speakers. Storing the device in a different location may reduce or eliminate the noise.

FM radio reception

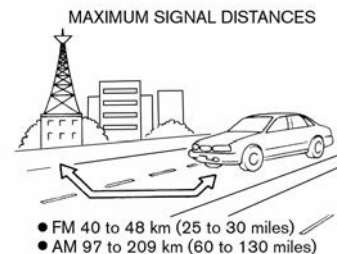

Range: FM range is normally limited to 40 to 48 km (25 to 30 miles), with monaural (single station) FM having slightly more range than stereo FM. External influences may sometimes interfere with FM station reception even if the FM station is within 40 km (25 miles). The strength of the FM signal is directly related to the distance between the transmitter and receiver. FM signals follow a line-of-sight path, exhibiting many of the same characteristics as light. For example they will reflect off objects.

Fade and drift: As your vehicle moves away from a station transmitter, the signals will tend to fade and/or drift.

Static and flutter: During signal interference from buildings, large hills or due to antenna position, usually in conjunction with an increased distance from the station transmitter, static or flutter can be heard. This can be reduced by lowering

the treble setting to reduce the treble response.

Multipath reception: Because of the reflective characteristics of FM signals, direct and reflected signals reach the receiver at the same time. The signals may cancel each other, resulting in momentary flutter or loss of sound.

AM radio reception

AM signals, because of their low frequency, can bend around objects and skip along the ground. In addition, the signals can bounce off the ionosphere and be bent back to earth. Because of these characteristics, AM signals are also subject to interference as they travel from transmitter to receiver.

Fading: Occurs while the vehicle is passing through motorway underpasses or in areas with many tall buildings. It can also occur for several seconds during ionospheric turbulence even in areas where no obstacles exist.

Static: Caused by thunderstorms, electrical power lines, electric signs and even traffic lights.

Digital Audio Broadcast (DAB) (if equipped)

The supported standards for this system are DAB and DAB+.

USB (Universal Serial Bus) CONNECTION PORT



WARNING

Do not connect, disconnect or operate the USB device while driving. Doing so can be a distraction. If distracted you could lose control of your vehicle and cause an accident or serious injury.



CAUTION

- **Do not force the USB device into the USB connection port. Inserting the USB device tilted or up-side-down into the port may damage the port. Make sure that the USB device is connected correctly into the USB connection port.**
- **Do not grab the USB connection port cover (if equipped) when pulling the USB device out of the port. This could damage the port and the cover.**
- **Do not leave the USB cable in a place where it can be pulled unintentionally. Pulling the cable may damage the port.**

The vehicle is not equipped with a USB device. USB devices should be purchased separately as necessary.

This system cannot be used to format

USB devices. To format a USB device, use a personal computer.

This system supports various USB memory devices, USB hard drives and iPod players. Some USB devices may not be supported by this system.

- Partitioned USB devices may not be played correctly.
- Some characters used in other languages (Chinese, Japanese, etc.) are not displayed properly on the display. Using English language characters with a USB device is recommended.

General notes for USB use:

Refer to your device manufacturer's owner information regarding the proper care of the device.

Notes for iPod use:

iPod is a trademark of Apple Inc., registered in the U.S. and other countries.

- Improperly plugging in the iPod may cause a checkmark to be displayed on and off (flickering). Always make sure that the iPod is connected properly.
- Audiobooks may not play in the same order as they appear on an iPod.

3. Audio system

COMPRESSED AUDIO FILES (MP3/WMA/AAC)

Explanation of terms

- MP3 — MP3 is short for Moving Pictures Experts Group Audio Layer 3. MP3 is the most well-known compressed digital audio file format. This format allows for near “CD quality” sound, but at a fraction of the size of normal audio files. MP3 conversion of an audio track can reduce the file size by approximately a 10:1 ratio (Sampling: 44.1 kHz, Bit rate: 128 kbps) with virtually no perceptible loss in quality. The compression reduces certain parts of sound that seem inaudible to most people.
- WMA — Windows Media Audio (WMA) is a compressed audio format created by Microsoft as an alternative to MP3. The WMA codec offers greater file compression than the MP3 codec, enabling storage of more digital audio tracks in the same amount of space when compared to MP3s at the same level of quality.
- Bit rate — Bit rate denotes the number of bits per second used by a digital music file. The size and quality of a compressed digital audio file is determined by the bit rate used when encoding the file.
- Sampling frequency — Sampling frequency is the rate at which the sam-

ples of a signal are converted from analog to digital (A/D conversion) per second.

- Multisession — Multisession is one of the methods for writing data to media. Writing data once to the media is called a single session, and writing more than once is called a multisession.
- ID3/WMA tag — The ID3/WMA tag is the part of the encoded MP3 or WMA file that contains information about the digital music file such as song title, artist, album title, encoding bit rate, track time duration, etc. ID3 tag information is displayed on the Album/Artist/Track title line on the display.
- AAC — Advanced Audio Coding (AAC) is a compressed audio format. AAC offers greater file compression than MP3 and enables music file creation and storage at the same quality as MP3.

Playback order

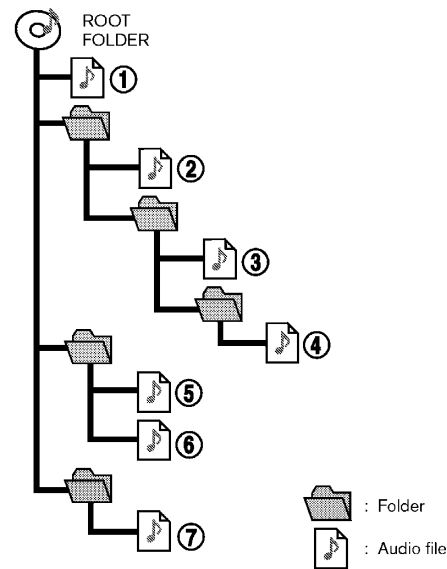

- Names of folders not containing compressed audio files are not shown on the display.
- The playback order is the order in which the files were written by the writing software, so the files might not play in the desired order.
- Music playback order of compressed audio files is as illustrated.

Specification chart for USB

Supported media	USB2.0
Supported file systems	FAT16, FAT32
Folder levels	Folder levels: 8, Files via folder: 255, Folders: 512 (including root folder), Files: 8000
Tag information (Song title, Artist name and Album name)	ID3 tag VER1.0, VER1.1, VER2.2, VER2.3, VER2.4 (MP3 only)
	WMA tag (WMA only)
	AAC tag (AAC only)

Format			Sampling frequency	Supported bitrate
MP3 *1	MPEG1	Layer-3	32, 44.1, 48 kHz	32-320 kbps
	MPEG2		16, 22.05, 24 kHz	8-160 kbps
WMA *2			8, 11.025, 16, 22.05, 32, 44.1, 48 kHz	12-192 kbps
AAC (MPEG4) *3 (Extension "m4a" only)			11.025, 16, 22.05, 32, 44.1, 48 kHz	8-320 kbps
FLAC			8-192 kHz	128-12,288 kbps
WAV			8-192 kHz	128-12,288 kbps

*1 MPEG2.5 is not supported.

*2 WMA7, WMA8, WMA9, WMA9.1, WMA9.2 are supported. (WMA9 Professional, Lossless, Voice are not supported.)

*3 Only AAC files encoded by iTunes are supported. HE-AAC (High-Efficiency) is not supported.

3. Audio system

BLUETOOTH® AUDIO

- Some Bluetooth® audio devices may not be recognized by the in-vehicle audio system.
- It is necessary to set up the wireless connection between a compatible Bluetooth® audio device and the in-vehicle Bluetooth® module before using the Bluetooth® audio.
- The Bluetooth® audio may stop playing when
 - receiving a hands-free call.
 - checking the connection to the hands-free phone.
 - connecting the hands-free phone or the audio device.
 - downloading the phonebook memory from the connected cellular phone.
- Do not place a Bluetooth® audio device in an area surrounded by metal or far away from the in-vehicle Bluetooth® module to prevent tone quality degradation and wireless connection disruption.
- While an audio device is connected through a Bluetooth® wireless connection, the battery of the device may discharge quicker than usual.
- This system supports the Bluetooth® Advanced Audio Distribution Profile (A2DP) and Audio/Video Remote Control Profile (AVRCP).
- Wireless LAN (Wi-Fi) and the Bluetooth® functions share the same frequency band (2.4 GHz). Using the Bluetooth® and the wireless LAN functions at the same time may slow down or disconnect the communication and cause undesired noise. It is recommended that you turn off the wireless LAN (Wi-Fi) when using the Bluetooth® functions.

NAMES AND FUNCTIONS OF AUDIO CONTROL BUTTONS

AUDIO MAIN BUTTONS

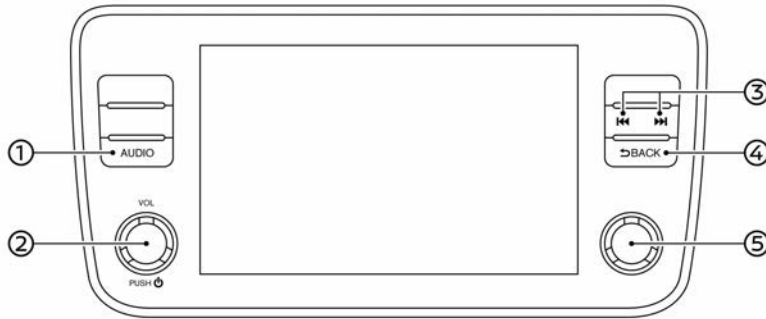

① **<AUDIO>:**

Push to display the audio screen.

Push again to display the audio source menu screen.

"Selecting audio source" (page 3-8)

② **<VOL/ >:**

Push to turn on/off the audio system.

The audio system can also be turned on if the button is turned when the system is turned off.

Turn to adjust the volume.

③ **< >/< >:**

Push to select and rewind/fast-forward tracks and to tune radio stations.

④ **<BACK>:**

Depending on the screen, pushing the button will display the previous screen.

⑤ **< >/ > (if equipped):**

Push to select the highlighted item when a menu screen is displayed. When this button is pushed when no item on the screen is highlighted, the

audio settings can be adjusted.

"Audio adjustments with audio adjust bar" (page 3-27)

<TUNE-SCROLL/OK> (if equipped):

Turn to manually tune AM/FM/DAB (if equipped) or to skip the tracks.

Push to select the highlighted item when a menu screen is displayed. When this button is pushed when no item on the screen is highlighted, the audio settings can be adjusted.

"Audio adjustments with audio adjust bar" (page 3-27)

AUDIO CONTROL STEERING WHEEL SWITCHES

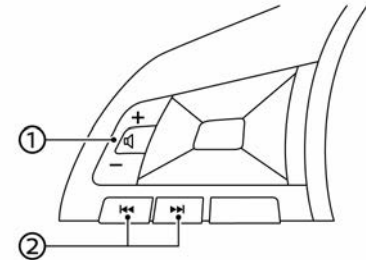

① **< > (Volume control):**

Push the + or - side of the switch to adjust the volume.

② **< >/< >:**

Use the switches for audio operations.

"Audio operations" (page 3-8)

3. Audio system

INFO:

Steering wheel switches are mainly for the vehicle information display control and may not be able to operate the touch screen display depending on the conditions.

AUDIO OPERATIONS

AUDIO MAIN OPERATION

Turning audio system on/off

The power switch must be in the ACC or ON position to turn on the audio system. Push **<VOL/ ⏪ >** or **<AUDIO>** to turn on the last audio source that was playing immediately before the system was turned off. To turn off the audio system, push **<VOL/ ⏪ >** again.

INFO:

The audio system can also be turned on by turning **<VOL/ ⏪ >** when the system is turned off.

Selecting audio source

Selecting from source menu screen:

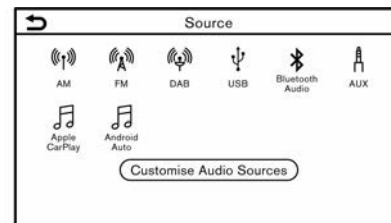

Example

1. Push **<AUDIO>** when the audio screen is displayed.
2. Select an audio source you prefer to play.

INFO:

- Touching [Source] on the upper left corner of the audio screen will also display the audio source menu screen.
- Depending on the models, the audio source can also be changed by operating the vehicle information display. Refer to the LEAF Owner's Manual for the detail of the vehicle information display.

Selecting from Launch Bar:

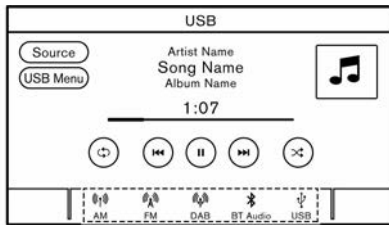

Example

The source icons are displayed on the Launch Bar. Touch the icon to select the preferred audio source.

Customizing Launch Bar:

The source icons displayed on the Launch Bar can be customized.

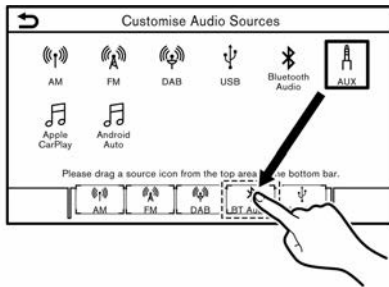

Example

1. Push **<AUDIO>** or touch [Source], while the Audio screen is displayed.
2. Touch [Customise Audio Sources].
3. Drag the preferred source icon to the Launch Bar.

4. Push **<BACK>** or touch [] to confirm the setting.

INFO:

[Customise Audio Sources] can also be accessed from [Settings] on the Launch Bar.

 "System settings" (page 1-14)

3. Audio system

RADIO

How to view radio screen

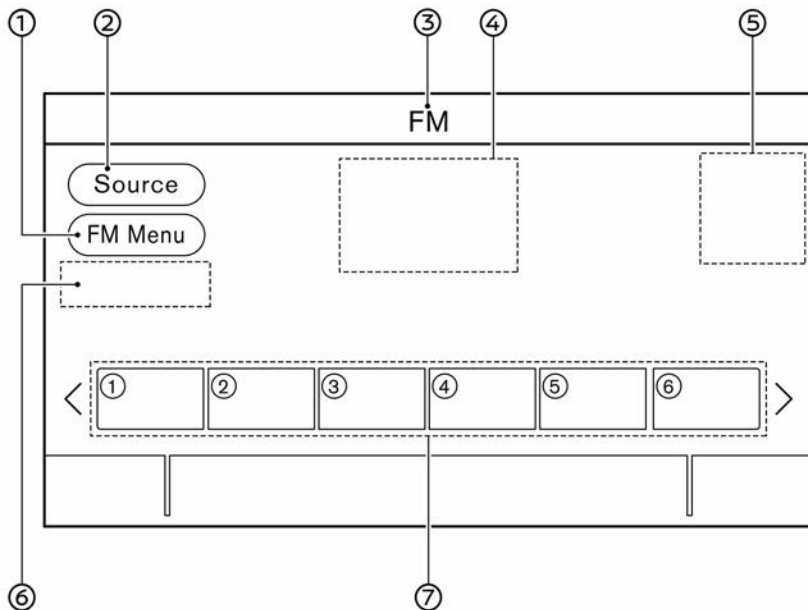

- ① [AM Menu]/[FM Menu]/[DAB Menu] (if equipped):
Touch to display the radio menu screen.

- ② [Source]:
Touch to switch to the source menu screen.

☞ "Selecting audio source"
(page 3-8)

- ③ Audio source indicator:
Indicates the currently selected audio source.
- ④ Reception information display:
Reception information currently available such as frequency, station name, etc. is displayed.
- ⑤ Turn direction indicator (if equipped):
When a navigation route is set, turning direction and the distance to the next turn are displayed.
- ⑥ [Tune] (if equipped):
Touch to select a station by entering a radio frequency.
☞ "Direct tuning" (page 3-11)
- ⑦ Preset list:
To listen to a preset station, touch the corresponding station from the preset list. If displayed, touch [<] or [>] to scroll the preset list.
Touch and hold one of the keys in the preset list to store the currently playing station to that key location.
☞ "Presetting" (page 3-12)

INFO:

- When TA (Traffic Announcement) setting (if equipped) is turned on, the TA indicator will be displayed.

 "Radio Menu" (page 3-13)

- TA indicator (if equipped) is also displayed on the screen of other audio sources.

Radio operation (models with fast tuning function)

Radio activation and band selection:

To listen to the radio, turn on the audio system and select a preferred radio band.

 "Selecting audio source" (page 3-8)

INFO:

When the stereo broadcast signal is weak, the radio will automatically change from stereo to monaural reception.

Tuning:

Tune to stations manually with the following operations.

- Control panel
 - Turn **<TUNE·SCROLL/OK>***

*: if equipped

Seek tuning:

Seek up/down to the next/previous receivable station with the following operations.

- Control panel
 - Push **<⏪>/<⏩>**

- Steering wheel switches
 - Push and hold **<⏪>/<⏩>**

Fast tuning:

Fast tune to stations with the following operation.

- Control panel
 - Push and hold **<⏪>/<⏩>**

Direct tuning (if equipped):

To directly tune to the preferred stations, touch [Tune] on the radio screen and then enter the radio frequency.

Presetting:

Up to 6 for AM, 12 for FM stations can be registered in the preset list.

1. Select a radio band (AM or FM).
2. Tune to the station you wish to store.
3. Touch and hold one of the preset numbers in the preset list.

Select preset stations with the following operations.

- Steering wheel switches
 - Push **<⏪>/<⏩>**
- Touch screen
 - Briefly touch a preferred station on the preset list on the radio screen

Radio operation (models without fast tuning function)

Radio activation and band selection:

To listen to the radio, turn on the audio system and select a preferred radio band.

 "Selecting audio source" (page 3-8)

INFO:

When the stereo broadcast signal is weak, the radio will automatically change from stereo to monaural reception.

Tuning:

AM/FM

Tune to stations manually with the following operations.

- Control panel
 - Push **<⏪>/<⏩>**
 - Turn **<TUNE·SCROLL/OK>***

*: if equipped

DAB*

Tune to your preferred service component with the following operations.

- Control panel
 - Push **<⏪>/<⏩>**
 - Turn **<TUNE·SCROLL/OK>***

*: if equipped

3. Audio system

Seek tuning:

AM/FM

Seek up/down to the next/previous receivable station with the following operations.

- Control panel
 - Push and hold < ⏪ > / < ⏩ >
- Steering wheel switches
 - Push and hold < ⏪ > / < ⏩ >

DAB*

Seek up/down to the next receivable station with the following operations.

- Control panel
 - Push and hold < ⏪ > / < ⏩ >
- Steering wheel switches
 - Push and hold < ⏪ > / < ⏩ >

*: if equipped

Presetting:

Up to 6 for AM, 12 for FM and DAB (if equipped) stations can be registered in the preset list.

1. Select a radio band (AM, FM or DAB).
2. Tune to the station you wish to store.
3. Touch and hold one of the preset numbers in the preset list.

Select preset stations with the following operations.

- Steering wheel switches

– Push < ⏪ > / < ⏩ >

- Touch screen

– Briefly touch a preferred station on the preset list on the radio screen

Radio Menu

Touch [FM Menu], [AM Menu], and [DAB Menu] (if equipped) on each radio screen to display the corresponding menu screen. Available menu items may vary depending on models and specifications.

[FM Menu]:

[TA]	When this item is turned on, received TA (Traffic Announcement) will interrupt the audio source that is playing.
[REG]	When this item is turned on, the system will switch to regional radio programs when detected.
[SCAN]	When touched, the stations will be tuned from low to high frequencies and stop at each broadcasting station for several seconds. Touching [SCAN] again during this period of several seconds will stop scan tuning and the radio will remain tuned to that station.
[Radio Text]	Displays the radio text information.
[Refresh]	Touch to update the station list displayed on the right side of the FM menu screen.
Station List	Displays the station list on the right side of the FM menu screen.

[AM Menu]:

[TA]	When this item is turned on, received TA (Traffic Announcement) will interrupt the audio source that is playing.
[SCAN]	When touched, the stations will be tuned from low to high frequencies and stop at each broadcasting station for several seconds. Touching [SCAN] again during this period of several seconds will stop scan tuning and the radio will remain tuned to that station.
[Radio Text]	Displays the radio text information.
[Refresh]	Touch to update the station list displayed on the right side of the AM menu screen.
Station List	Displays the station list on the right side of the AM menu screen.

3. Audio system

[DAB Menu] (if equipped):

[TA]	When this item is turned on, received TA (Traffic Announcement) will interrupt the audio source that is playing.
[Radio Text]	Touch to display the radio text information.
[Refresh]	Touch to update the station list displayed on the right side of the DAB menu screen.
[DAB-FM]	When this item is turned on, the system searches for and tunes to FM stations when DAB reception is poor.
Station List	Displays the station list on the right side of the DAB menu screen.

USB MEMORY DEVICE PLAYER

Connecting USB memory device



WARNING

Do not connect, disconnect or operate the USB device while driving. Doing so can be a distraction. If distracted you could lose control of your vehicle and cause an accident or serious injury.



CAUTION

- **Do not force the USB device into the USB connection port. Inserting the USB device tilted or up-side-down into the port may damage the port. Make sure that the USB device is connected correctly into the USB connection port.**
- **Do not grab the USB connection port cover (if equipped) when pulling the USB device out of the port. This could damage the port and the cover.**
- **Do not leave the USB cable in a place where it can be pulled unintentionally. Pulling the cable may damage the port.**

Refer to your device manufacturer's owner information regarding the proper use and care of the device.

When compatible storage devices are

plugged into the port, compatible audio files on the storage devices can be played through the vehicle's audio system.

For the location of the USB connection port(s):

- ☞ "USB (Universal Serial Bus) connection port and AUX (auxiliary) input jack" (page 1-5)

3. Audio system

How to view USB screen

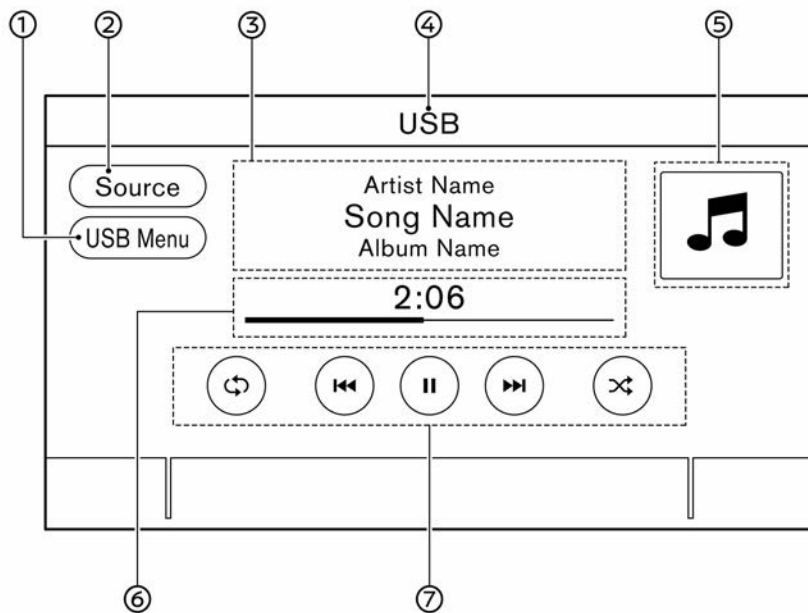

- ① [USB Menu]:
Touch to switch to the USB Menu screen.
☞ "USB Menu" (page 3-18)
- ② [Source]:
Touch to switch to the source menu screen.
☞ "Selecting audio source" (page 3-8)
- ③ Track information:
Track information such as the song name, artist name and album name are displayed.
- ④ Device name indicator:
Indicates the name of the USB device currently playing.
- ⑤ Album artwork/turn direction indicator (if equipped):
Image of an album artwork is displayed when available if the setting is turned on.
☞ "USB Menu" (page 3-18)
When the album artwork display setting is turned off, the turn direction and the distance to the next turn are displayed when a route is set (models with navigation system).
- ⑥ Play time and progress bar:
The play time of the track is displayed. The bar indicates the progress in playing a track.

⑦ USB operation keys:

Touch to control USB playback functions.

[↺]	Each time [↺] is touched, the repeat mode changes. ☞ "Changing play mode" (page 3-17)
[⏮]	Touch to return to the beginning of the current track. Touch again to select the previous track. Touch and hold to rewind the current track.
[▶]	Touch to play the track.
[⏸]	Touch to pause the track.
[⏭]	Touch to select the next track. Touch and hold to fast-forward the track.
[↻]	Each time [↻] is touched, the random mode changes. ☞ "Changing play mode" (page 3-17)

INFO:

When TA (Traffic Announcement) setting (if equipped) is turned on, the TA indicator will be displayed.

☞ "USB Menu" (page 3-18)

USB memory device player operation

Activation and playing:

USB memory device can be played by selecting the source on the audio source menu screen.

☞ "Selecting audio source" (page 3-8)

To pause playing the USB memory device, touch [⏸]. To resume playing, touch [▶].

Selecting search method:

A list of search methods is displayed in the USB menu.

☞ "USB Menu" (page 3-18)

Skipping tracks:

Skip the tracks with the following operations.

- Control panel
 - Push <⏮>/<⏭>
 - Turn <TUNE-SCROLL/OK>*
 - Steering wheel switches
 - Push <⏮>/<⏭>
 - Touch screen
 - Touch [⏮]/[⏭]
- *: if equipped

INFO:

Depending on the condition, skipping to the previous track may require pushing the button or touching the key twice. Pushing the button or touching the key once may only restart the current track from the beginning.

Rewinding/fast-forwarding:

Rewind or fast-forward the track with the following operations.

- Control panel
 - Push and hold <⏮>/<⏭>
- Steering wheel switches
 - Push and hold <⏮>/<⏭>
- Touch screen
 - Touch and hold [⏮]/[⏭]

Changing play mode:

Repeat mode

Touch [↺] on the USB screen to change the repeat mode. The following modes are available.

No text displayed: Repeat off

[All]: Repeat all

[Folder]: Repeat folder/sub-folder

[Track]: Repeat track

Random mode

Touch [↻] on the screen to change the random mode as follows.

No text displayed: Random off

3. Audio system

[Random]: Random play

USB Menu

Touch [USB Menu] on the USB screen to display the USB Menu screen.

Available menu items may vary depending on models and specifications.

[TA]	When this item is turned on, received TA (Traffic Announcement) will interrupt the audio source that is playing.
[Now Playing]	Touch to display the USB screen.
[Folder List] *	Touch to display the folder list. Touch an item on the list to select the folder. The sub-folder or track list will be displayed. Select a sub-folder or track from the list.
[Album Artwork]	Touch to turn on/off the album artwork display on the USB screen.
[Playlists]	Touch to display the list according to the selected item.
[Artists]	
[Albums]	
[Songs]	
[Genres]	
[Composers]	

*: Displayed only when available.

iPod PLAYER

Connecting iPod



WARNING

Do not connect, disconnect or operate the USB device while driving. Doing so can be a distraction. If distracted you could lose control of your vehicle and cause an accident or serious injury.



CAUTION

- **Do not force the USB device into the USB connection port. Inserting the USB device tilted or up-side-down into the port may damage the port. Make sure that the USB device is connected correctly into the USB connection port.**
- **Do not grab the USB connection port cover (if equipped) when pulling the USB device out of the port. This could damage the port and the cover.**
- **Do not leave the USB cable in a place where it can be pulled unintentionally. Pulling the cable may damage the port.**

Connect the iPod to the USB connection port.

 "USB (Universal Serial Bus) connection port and AUX (auxiliary) input jack" (page 1-5)

The battery of the iPod will be charged while the device is connected to the vehicle if the iPod supports charging via a USB connection.

Depending on the device and firmware version of the iPod, the display on the iPod shows a NISSAN or Accessory Attached screen when the connection is completed. When the iPod is connected to the vehicle, the iPod music library can only be operated by the vehicle audio controls.

iPod is a trademark of Apple Inc., registered in the U.S. and other countries.

Compatibility:

Made for

- iPhone 8 Plus
- iPhone 8
- iPhone 7 Plus
- iPhone 7
- iPhone SE
- iPhone 6s Plus
- iPhone 6s
- iPhone 6 Plus
- iPhone 6
- iPhone 5s
- iPod touch (6th generation)



INFO:

- Make sure that iOS is updated.
- The Lightning connector works with iPhone (5s through 8 Plus), iPod touch (6th generation).
USB works with iPhone (5s through 8 Plus), iPod touch (6th generation).
- Refer to your device manufacturer's owner information regarding the proper use and care of the device.

How to view iPod screen

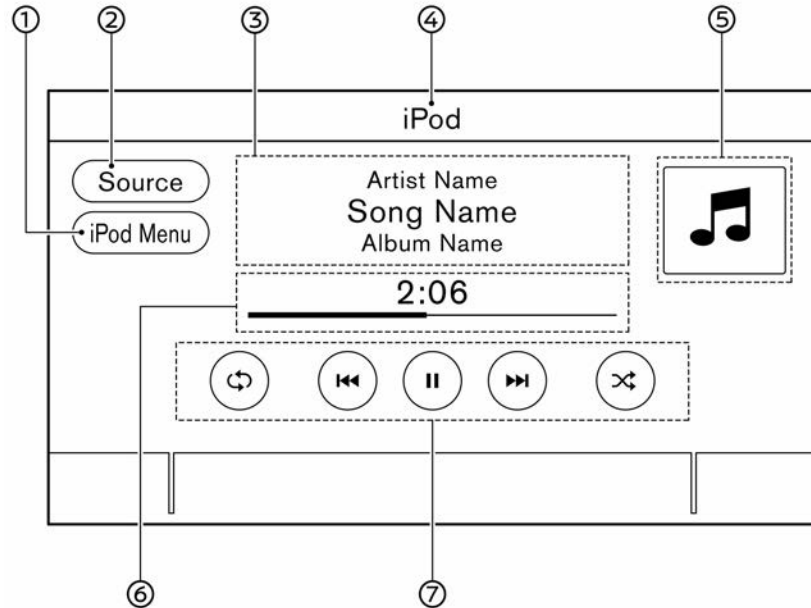

3. Audio system

① [iPod Menu]:

Touch to display the iPod Menu screen.

 "iPod Menu" (page 3-21)

② [Source]:

Touch to switch to the source menu screen.

 "Selecting audio source" (page 3-8)

③ Track information:

Track information such as the song name, artist name and album name are displayed.

④ Device name indicator:

Indicates the name of the iPod currently playing.

⑤ Album artwork/turn direction indicator (if equipped):

Image of an album artwork is displayed when available if the setting is turned on.

 "iPod Menu" (page 3-21)







When the album artwork display setting is turned off, the turn direction and the distance to the next turn are displayed when a route is set (models with navigation system).

⑥ Play time and progress bar:

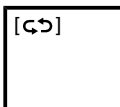
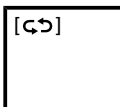
The play time of the track is displayed. The progress bar indicates the progress in playing the current track.

⑦ iPod operation keys:

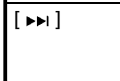
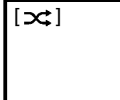
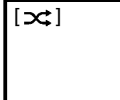
Touch to control iPod playback functions.

	Each time  is touched, the repeat mode changes.  "Changing play mode" (page 3-21)
	Touch to return to the beginning of the current track. Touch again to select the previous track. Touch and hold to rewind the current track.
	Touch to play the track.
	Touch to pause the track.
	Touch to select the next track. Touch and hold to fast-forward the track.
	Each time  is touched, the random mode changes.  "Changing play mode" (page 3-21)

 **INFO:**

When TA (Traffic Announcement) setting (if equipped) is turned on, the TA indicator will be displayed.

 "iPod Menu" (page 3-21)

iPod player operation

Depending on the connected device, some functions cannot be used.

Activation and playing:

The iPod can be played by selecting the source on the audio source menu screen.

 "Selecting audio source" (page 3-8)







Selecting search method:

A list of search methods is displayed in the iPod menu.

 "iPod Menu" (page 3-21)

Skipping tracks:

Skip the tracks with the following operations.

- Control panel
 - Push  
 - Turn **<TUNE-SCROLL/OK>***
- Steering wheel switches
 - Push  
- Touch screen
 - Touch  

*: if equipped

 **INFO:**

Depending on the condition, skipping to the previous track may require pushing the button or touching the key twice. Pushing the button or touching the key once may only restart the current track

from the beginning.

Rewinding/fast-forwarding:

Rewind or fast-forward the track with the following operations.

- Control panel
 - Push and hold < ⏮ > / < ⏭ >
- Steering wheel switches
 - Push and hold < ⏮ > / < ⏭ >
- Touch screen
 - Touch and hold [⏮] / [⏭]

Changing play mode:

Repeat mode

Touch [↺↻] on the iPod screen to change the repeat mode. The following modes are available.

No text displayed: Repeat off

[All]: Repeat all

[Track]: Repeat track

Random mode

Touch [⌘] on the screen to change the random mode as follows.

No text displayed: Random off

[Random]: Random play

iPod Menu

Touch [iPod Menu] on the iPod screen to display the iPod menu screen.

Available menu items may vary depending on models and specifications.

[TA]	When this item is turned on, received TA (Traffic Announcement) will interrupt the audio source that is playing.
[Now Playing]	Touch to display the iPod screen.
[Current List]	Touch to display the current list. A list of tracks in the currently selected category is displayed.
[Album Artwork]	Touch to turn on/off the album artwork display on the iPod screen.
[Playlists]	Touch to display the list according to the selected item.
[Artists]	
[Albums]	
[Songs]	
[Genres]	
[Composers]	
[Audiobooks]	
[Podcasts]	

BLUETOOTH® AUDIO

Your vehicle is equipped with Bluetooth® Audio.

If you have a compatible Bluetooth® device with streaming audio capability (A2DP profile), you can set up a wireless connection between your Bluetooth® device and the in-vehicle audio system. This connection allows you to listen to the audio from the Bluetooth® device using your vehicle speakers. It also may allow basic control of the device for playing and skipping audio files using the AVRCP Bluetooth® profile. Not all Bluetooth® devices have the same level of controls for AVRCP. Please consult the manual for your Bluetooth® device for more details.

Wireless LAN (Wi-Fi) and the Bluetooth® functions share the same frequency band (2.4 GHz). Using the Bluetooth® and the wireless LAN functions at the same time may slow down or disconnect the communication and cause undesired noise. It is recommended that you turn off the wireless LAN (Wi-Fi) when using the Bluetooth® functions.

Connecting Bluetooth® audio device

A Bluetooth® audio device must be connected to the vehicle before operation.

 "Setting Bluetooth®" (page 1-16)

3. Audio system

How to view Bluetooth® audio screen

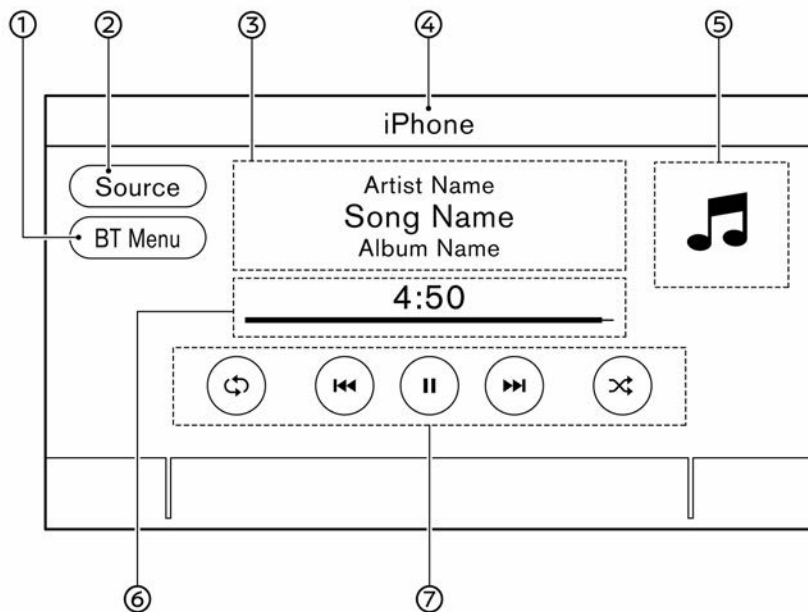

- ① [BT Menu]/[Connections]:
Depending on the connected device, either [BT Menu] or [Connections] is displayed.
Touch [BT Menu] to display the Bluetooth® audio menu screen.
👉 "BT Menu" (page 3-24)
Touch [Connections] to display the connection screen.
👉 "Setting Bluetooth®" (page 1-16)
- ② [Source]:
Touch to switch to the source menu screen.
👉 "Selecting audio source" (page 3-8)
- ③ Track information:
Track information such as the song name, artist name and album name are displayed.
- ④ Device name indicator:
Indicates the name of the Bluetooth® audio device currently playing.
- ⑤ Turn direction indicator (if equipped):
When a navigation route is set, the turning direction and the distance to the next turn are displayed.
- ⑥ Play time and progress bar:
The play time of the track is displayed. The progress bar indicates the progress in playing the current track.

- ⑦ Bluetooth® audio operation keys:
Touch to control the Bluetooth® audio playback function.

[↺]	Each time [↺] is touched, the repeat mode changes. "Changing play mode" (page 3-24)
[⏮]	Touch to return to the beginning of the current track. Touch again to select the previous track. Touch and hold to rewind the current track.
[▶]	Touch to play the track.
[⏸]	Touch to pause the track.
[⏭]	Touch to select the next track. Touch and hold to fast-forward the track.
[↻]	Each time [↻] is touched, the random mode changes. "Changing play mode" (page 3-24)

INFO:

- When TA (Traffic Announcement) setting (if equipped) is turned on, the TA indicator will be displayed.
 "BT Menu" (page 3-24)
- Depending on the audio device that is connected to the vehicle, track information may not be displayed.

Bluetooth® audio operation

The ability to pause, change tracks, fast-forward, rewind, randomize and repeat music may be different between devices. Some or all of these functions may not be supported on each device.

INFO:

Depending on the Bluetooth® audio device that is connected, it may not be possible to perform audio operations or a delay may occur before music is played back.

Activation and playing:

A Bluetooth® audio device can be played by selecting the source on the audio source menu screen.

"Selecting audio source" (page 3-8)

To pause playing the Bluetooth® audio, touch [⏸]. Touch [▶] to resume playing.

Skipping tracks:

Skip the tracks with the following operations.

- Control panel
 - Push <⏮>/<⏭>
 - Turn <TUNE-SCROLL/OK>*
- Steering wheel switches
 - Push <⏮>/<⏭>

- Touch screen
 - Touch [⏮]/[⏭]

*: if equipped

INFO:

Depending on the condition, skipping to the previous track may require pushing the button or touching the key twice. Pushing the button or touching the key once may only restart the current track from the beginning.

Changing folders:

To change folders, touch [BT Menu].
 "BT Menu" (page 3-24)

Rewinding/fast-forwarding:

Rewind or fast-forward the track with the following operations.

- Control panel
 - Push and hold <⏮>/<⏭>
- Steering wheel switches
 - Push and hold <⏮>/<⏭>
- Touch screen
 - Touch and hold [⏮]/[⏭]

3. Audio system

Changing play mode:

Repeat mode

Touch [] on the screen to change the repeat mode.

Random mode

Touch [] on the screen to change the random mode.



INFO:

Available repeat/random modes change depending on the connected device.

BT Menu (if equipped)

Touch [BT Menu] on the Bluetooth® audio screen to display the Bluetooth® audio menu screen.

Available menu items may vary depending on models and specifications.

[TA]	When this item is turned on, received TA (Traffic Announcement) will interrupt the audio source that is playing.
[Now Playing]	Touch to display the Bluetooth® audio screen.
[Current List]	Touch to display the current list. A list of tracks in the currently selected folder is displayed.
[Connections] *	Touch to display the connections screen.  "Connections settings" (page 1-16)
Folder list *	Touch an item on the list to select the folder.

*: Displayed only when available.



INFO:

Depending on the connected device, [BT Menu] may not be displayed.

AUXILIARY (AUX) DEVICES (if equipped)

Connecting auxiliary devices

Connect an AUX device to the AUX input jack.

AUX input jack location:

 "USB (Universal Serial Bus) connection port and AUX (auxiliary) input jack" (page 1-5)

The AUX input jack accepts any standard analog audio input such as from a portable cassette player, CD player or MP3 player.



INFO:

Insert a 3.5 mm (1/8 in) stereo mini plug in the audio input jack. If a cable with a mono plug is used, the audio output may not function normally.

AUX operation

Activation and playing:

Turn on an AUX device.

Connect an AUX cable to the AUX device and the AUX input jack. Select AUX mode from the audio source menu screen.

 "Selecting audio source" (page 3-8)

How to view AUX screen

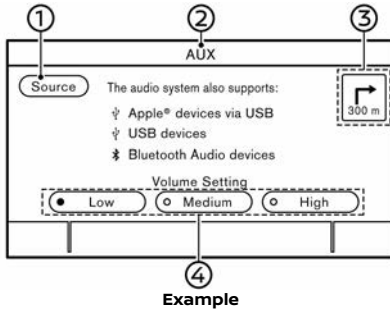

- ① [Source]:
Touch to switch to the source menu screen.
👉 "Selecting audio source" (page 3-8)
- ② Audio source indicator:
Indicates that the AUX source is currently playing.
- ③ Turn direction indicator (if equipped):
When a navigation route is set, the turn direction and the distance to the next turn are displayed.
- ④ Volume Setting keys:
Touch one of the keys to select the sound output gain from [Low], [Medium] and [High].

INFO:

Depending on the models, touching [TA] displayed on the upper left side of the AUX screen can turn on/off the TA (Traffic Announcement) setting. When [TA] setting is turned on, the TA indicator will be displayed and received TA information will interrupt the audio source that is playing.

SMARTPHONE AUDIO (if equipped)

You can also listen to music from your compatible smartphone using Apple CarPlay or Android Auto.

- 👉 "Apple CarPlay" (page 5-7)
- 👉 "Android Auto™" (page 5-11)

Connecting smartphone

Connect the iPhone or Android phone to the USB connection port.

- 👉 "USB (Universal Serial Bus) connection port and AUX (auxiliary) input jack" (page 1-5)

Smartphone audio operation

1. Connect the iPhone or Android phone to the USB connection port and activate Apple CarPlay or Android Auto.
👉 "Apple CarPlay operation" (page 5-8)
👉 "Android Auto operation" (page 5-12)
2. Push **<AUDIO>**.
3. Touch [Source].

4. Touch [Apple CarPlay] or [Android Auto] in the audio source menu screen, and the smartphone audio starts activating.

👉 "Selecting audio source" (page 3-8)

3. Audio system

AUDIO SETTINGS

Audio settings can be adjusted or audio related functions can be turned on/off with the following procedure.

1. Touch [Settings] on the Launch Bar.
2. Touch [Sound].

Available setting items may vary depending on models and specifications.

Setting items	Action
[Bass]	Adjust the speaker tone quality and sound balance by touching [-]/[+], [L]/[R] or [R]/[F].
[Mid]	
[Treble]	
[Balance]	
[Fader]	
[Bass Enhancer]	When this item is turned on, the system enhances bass sound.
[Speed-Sensitive Volume]	Automatically adjusts the volume depending on the vehicle speed. Touch [-]/[+] to change the sensitivity level.

AUDIO ADJUSTMENTS WITH AUDIO ADJUST BAR

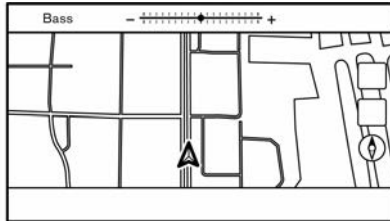

Example

Sound quality can be adjusted with the following buttons.

- **<TUNE-SCROLL/OK>***
- **<P / Q / OK>***

*: if equipped

When the list screen is not displayed, pushing any of the buttons listed above will display the audio adjustment bar. Each time the button is pushed, the menu will shift to the available setting items.

Turn the button to adjust the level of the selected setting item.

INFO:

This function may not be available when a menu is highlighted on the screen.

USB MEMORY DEVICE CARE

- Never touch the terminal portion of the USB memory device.
- Do not place heavy objects on the USB memory device.
- Do not store the USB memory device in highly humid locations.
- Do not expose the USB memory device to direct sunlight.
- Do not spill any liquids on the USB memory device.

Refer to the USB memory device Owner's Manual for the details.

3. Audio system

MEMO

4 Hands-Free Phone

Bluetooth® Hands-Free Phone System	4-2
Phone screen	4-3
Indicators	4-4
Phone	4-4
Hands-free text messaging assistant	4-6
Phone and text message settings	4-10



4. Hands-Free Phone

BLUETOOTH® HANDS-FREE PHONE SYSTEM



WARNING

- **Use a phone after stopping your vehicle in a safe location. If you have to use a phone while driving, exercise extreme caution at all times so full attention may be given to vehicle operation.**
- **If you find yourself unable to devote full attention to vehicle operation while talking on the phone, pull off the road to a safe location and stop your vehicle before doing so.**



CAUTION

To avoid draining the vehicle battery (12V battery), use a phone only after the READY to drive indicator light is illuminated.

Your vehicle is equipped with Bluetooth® Hands-Free Phone System. If you are an owner of a compatible Bluetooth® enabled cellular phone, you can set up the wireless connection between your cellular phone and the in-vehicle phone module. With Bluetooth® wireless technology, you can make or receive a phone call with your cellular phone in your pocket.

Once a cellular phone is connected to the in-vehicle phone module, the procedure for connecting the phone does not need to be performed again. Your phone is automatically selected with the in-vehicle phone module when the power switch is placed in the ACC or ON position with the selected cellular phone turned on and carried in the vehicle.

You can register up to 6 different Bluetooth® devices in the in-vehicle phone module. However, you can talk on only one cellular phone at a time.

The Voice Recognition System (if equipped) supports phone commands, so dialing a phone number using your voice is possible.

 "Voice recognition" (page 7-2)



Before using the Bluetooth® Hands-Free Phone System, refer to the following notes.

- Wireless LAN (Wi-Fi) and the Bluetooth® functions share the same frequency band (2.4 GHz). Using the Bluetooth® and the wireless LAN functions at the same time may slow down or disconnect the communication and cause undesired noise. It is recommended that you turn off the wireless LAN (Wi-Fi) when using the Bluetooth® functions.
- Set up the wireless connection between a compatible cellular phone and the in-vehicle phone module before using the Bluetooth® Hands-Free

Phone System.



- Some Bluetooth® enabled cellular phones may not be recognized by the in-vehicle phone module. Consult a NISSAN dealer for phone compatibility.
- You will not be able to use a hands-free phone under the following conditions:
 - Your vehicle is outside of the phone service area.
 - Your vehicle is in an area where it is difficult to receive radio waves; such as in a tunnel, in an underground parking garage, behind a tall building or in a mountainous area.
 - Your cellular phone is locked in order to prevent dialing.
- When the radio wave condition is not ideal or ambient sound is too loud, it may be difficult to hear the other person's voice during a call.
- Immediately after the power switch is placed in the ON position, it may be impossible to receive a call for a short period of time.
- Do not place the cellular phone in an area surrounded by metal or far away from the in-vehicle phone module to prevent tone quality degradation and wireless connection disruption.

- While a cellular phone is connected through the Bluetooth® wireless connection, the battery power of the cellular phone may discharge quicker than usual.
- Consult a NISSAN dealer if the Bluetooth® Hands-Free Phone System seems to be malfunctioning.
- Some cellular phones or other devices may cause interference or a buzzing noise to come from the audio system speakers. Storing the device in a different location may reduce or eliminate the noise.
- Refer to the cellular phone Owner's Manual regarding the phone pairing procedure specific to your phone, battery charging, cellular phone antenna, etc.
- The antenna display on the screen may not coincide with the antenna display of some cellular phones.
- The battery display on the screen may not coincide with the battery display of some cellular phones.
- The microphone is located near the map light.
- Keep the interior of the vehicle as quiet as possible to hear the caller's voice clearly as well as to minimize its echoes.
- If reception between callers is unclear, adjusting the incoming or outgoing

call volume may improve the clarity.
 "Control buttons and touch screen display" (page 1-2)
 "Volume settings" (page 4-12)







PHONE SCREEN

The phone screen can be displayed by the following operations.

- Push <  > on the control panel*
- Push <  > on the steering wheel
- Touch [Phone] on the Launch Bar

*: if equipped

Available items

Menu item	Action
[Quick Dial]	Displays the Quick Dial screen.  "Making a call" (page 4-4)
[Phone Book]	Displays the phone book screen.  "Making a call" (page 4-4)
[Call History]	Displays the call history screen.  "Making a call" (page 4-4)
[Dial Number]	Displays the phone number entry screen.  "Making a call" (page 4-4)
[Text Message]	Displays the received message list screen.  "Displaying received message list" (page 4-7)
[Connections]	Displays the connection screen.  "Bluetooth® settings" (page 1-17)
[Volume]	Displays the volume adjustment screen.  "Volume settings" (page 4-12)

4. Hands-Free Phone



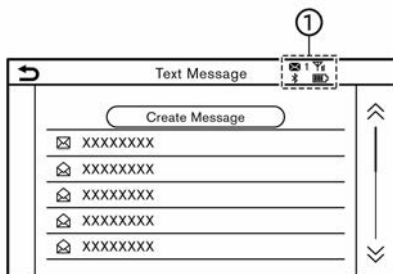

INFO:

Depending on the connected device, some functions cannot be used.

INDICATORS



When a cellular phone is connected through the Bluetooth® wireless connection, indicators ① for phone and text messaging are displayed on the top of the screen.

 1	Indicates the number of unread received messages.
	Indicates that Bluetooth® device(s) are connected.
	Indicates the strength of the signal the Bluetooth® device is receiving.
	Indicates the amount of remaining Bluetooth® device battery.

PHONE

Connecting Bluetooth® Hands-Free Phone

A cellular phone device must be connected to the Bluetooth® Hands-Free Phone System before operation. Up to 6 Bluetooth® devices can be registered to the system.

 "Setting Bluetooth®" (page 1-16)

Phone selection

Follow the instructions below to select a connected device for use with the Bluetooth® Hands-Free Phone System:

1. Touch [Phone] on the Launch Bar.
2. Touch [Connections] and touch [Bluetooth]. A list of the connected cellular phones is displayed.
3. Touch one of the connected cellular phones from the list.

When the connection is successful, "Connected" is displayed under the device name.

If  is displayed in gray, touch the icon to activate the connection.

 "Setting Bluetooth®" (page 1-16)

INFO:

To select a phone, the Bluetooth® of the cellular phone needs to be turned on.

Making a call

1. Touch [Phone] on the Launch Bar.
2. Select one of the following methods to make a call.

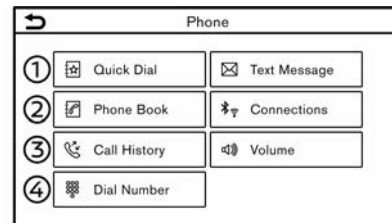

① [Quick Dial] :

Select a phone number registered as a Quick Dial number.

 "Quick Dial" (page 4-12)

② [Phone Book] :

Select a person and the phone number you wish to call from the phone-book.

Depending on the device, the phone-book will be downloaded from the cellular phone automatically when it is connected. If the automatic download does not take place, the phone number must be transferred to the hands-free phone system from the cellular phone prior to using this method.

 "Phone settings" (page 4-10)

③ [Call History] :

Select a phone number from recent

incoming, outgoing or missed calls.

④ [Dial Number] :

Enter the phone number manually using the keypad displayed on the screen.

👉 “How to input letters and numbers” (page 1-9)

INFO:

Either of the connected phone devices can be selected for dialing operation when [Allow 2 Phones Simultaneously] is turned on.

👉 “Bluetooth® settings” (page 1-17)

3. Dialing will start and the screen will change to the Call in Progress screen.

Receiving a call

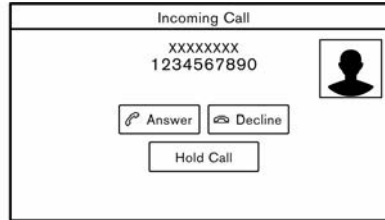

When you receive a phone call, the display switches to the Incoming Call screen and the ringtone is played through the vehicle's audio system.

Taking a call:

To answer the call, take one of the following actions.

- Push <  > on the steering wheel.
- Touch [Answer].

Rejecting a call:

To reject the call, take one of the following actions.

- Push and hold <  > on the steering wheel.
- Touch [Decline].

Holding a call:

To hold the call, touch [Hold Call].

INFO:

If [Allow 2 Phones Simultaneously] is turned on, two hands-free phone devices can be connected at the same time. If one of the connected devices receives an incoming call while the other device is already on line, a pop-up message will appear to inform that answering the call will hang up the line of the other connected device. Touch [Answer] to answer the call and hang up the line on the other device. Touch [Decline] to continue the conversation on the other device.

During a call

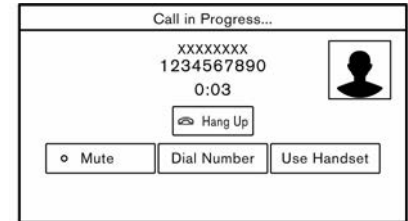

The Call in Progress screen will appear during a call.

To hang up the phone, touch [Hang Up].

Operations during a call:

There are some options available other than hanging up a call or answering/rejecting incoming calls.



Touch one of the following displayed keys on the screen to take action.

4. Hands-Free Phone

Available item	Action
[Use Handset]	Transfer the call to the cellular phone.
[Mute]	When muted, your voice will not be heard by the person on the other end of the line.
[Dial Number]	Using the touch tone, send digits to the connected party for using services such as voicemail.
[Switch Call]*	Answer another incoming call. The person you are talking to will be placed on hold. Touch once more to speak to the person on hold again.

*: Available when a call is received while on the line with another person. The availability of this function depends on the cellular phone.

INFO:

To adjust the person's voice to be louder or quieter, push <  > on the steering wheel or turn < VOL/  > on the control panel while talking on the phone.

Call from a second person:



When another phone call is received during a call, the Call Waiting screen will appear.

Answering call from a second person:

To answer the call from the second person and place the first caller on hold, take one of the following actions.

- Push <  > on the steering wheel.
- Touch [Answer].

Rejecting call from a second person:

To reject a call from the second person and continue the conversation with the first caller, touch [Decline].

During a call with a second person:



To hang up the phone and return to the conversation with the first caller, touch [Hang Up].

To switch between two calls on line, touch [Switch Call].

HANDS-FREE TEXT MESSAGING ASSISTANT

WARNING

- **Use the text messaging feature after parking your vehicle in a safe location. If you have to use the feature while driving, exercise extreme caution at all times so full attention may be given to vehicle operation.**
- **Laws in some jurisdictions may restrict the use of "Text-to-Speech." Check local regulations before using this feature.**
- **Laws in some jurisdictions may restrict the use of some of the applications and features, such as social networking and texting. Check local regulations for any requirements.**
- **If you are unable to devote full attention to vehicle operation while using the text messaging feature, pull off the road to a safe location and stop your vehicle.**

CAUTION

This feature is disabled if the connected device does not support it. See the phone's Owner's Manual for details and instructions.

The system allows for the sending and receiving of text messages through the vehicle interface.

The availability of the text message function may vary depending on the cellular phone.

Receiving a message

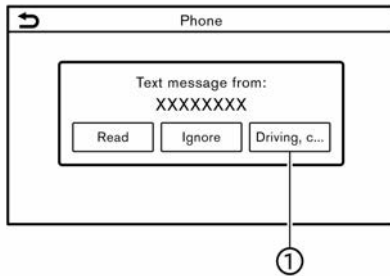

When the cellular phone connected to the vehicle receives a text message, a notification will appear on the touch screen display with a tone. (Depending on the models, the notification will also appear on the vehicle information display.)

To check the message, touch [Read]. Touch [Ignore] to save the message to

be checked later.

If you want to respond using a predefined message, touch the message for auto reply ①.

The text message for auto reply can be edited.

 "Phone settings" (page 4-10)

INFO:

- Depending on the cellular phone, the notification display setting may need to be activated on the cellular phone.
- Whether to read or ignore the message can be selected operating the switch on the steering wheel. Push < > to read the message. Push and hold the switch to ignore the message.

Displaying received message list

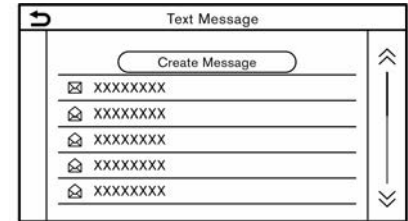

1. Touch [Phone] on the Launch Bar.
2. Touch [Text Message].
3. Touch an item on the list to read or reply to the message.

INFO:

- Up to 100 messages can be stored in the message list.
- Either of the connected phone devices can be selected for dialing operation when [Allow 2 Phones Simultaneously] is turned on.
 "Setting Bluetooth®" (page 1-16)

4. Hands-Free Phone

Received message screen



Touching [Read] on the new message notification screen or selecting a message from the message list will show the details of the received message on the display.

Available actions:

- [Prev]:
Touch to read the previous message.
- [Next]:
Touch to read the next message.
- [Play]/[Stop]:
Touch [Play] to have the hands-free phone system read out the received message. Touch [Stop] to stop reading.
- [Call]:
If the sender of the message is registered in the phonebook, touch this icon to make a call to the sender.
- [Reply]:
A reply message can be selected from the template.
 "Sending a text message"

(page 4-8)



INFO:

- Push < ▲ >/< ▼ > on the steering wheel to read the previous or next message.
- Depending on the language setting, the "Text-to-Speech" function may not be available.
- Available keys may vary depending on the situations and models.
- If the sender's name and phone number are registered in the phonebook, the name of the sender is displayed when a message is received.
- To adjust the message reading voice volume, push < 🔊 > on the steering wheel or turn < VOL/ 🔊 > on the control panel.

Sending a text message

This function may not be supported depending on the cellular phone.

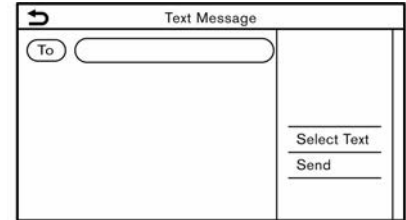

1. Touch [Phone] on the Launch Bar.
2. Touch [Text Message].
3. Touch [Create Message].



INFO:

Either of the connected phone devices can be selected for text messaging operation when [Allow 2 Phones Simultaneously] is turned on.

 "Bluetooth® settings" (page 1-17)

The following items are available.

Available item		Action
[To]	[Enter Number with Keypad]	Enter the phone number of the recipient using the keypad. Touch [OK] to confirm.
	[Quick Dial]	Select a recipient from the Quick Dial list.
	[Phone Book]	Select a recipient from the phonebook.
	[Call History]	Select a recipient/phone number from call history.
[Select Text]	[Fixed]	Touch to display a list of fixed text messages.
	[Customised]	Touch to display a list of custom text message templates. Custom text can be created or edited from the setting menu.  "Phone and text message settings" (page 4-10)
[Send]		Touch to send the message.

4. Hands-Free Phone

PHONE AND TEXT MESSAGE SETTINGS



Phone settings

Bluetooth® Hands-Free Phone System settings can be changed according to the user's preference.

1. Touch [Settings] on the Launch Bar.
2. Touch [Phone].

Available setting items may vary depending on models and specifications.

Available setting items

Setting item	Action
[Connections]	Displays the Connections screen. Phone connection, selection, deletion and other features are available.  "Connections settings" (page 1-16)
[Quick Dial]	[Edit] Entries in the Quick Dial can be edited. Touch [Add New] to register a new entry.  "Quick Dial" (page 4-12)
	[Delete All] Deletes all of the phone numbers in the Quick Dial.
[Phone Book]	[Download Entire Phone Book] All of the phone numbers that are stored in a phonebook of a cellular phone that is connected to the vehicle are downloaded at once.
	[Auto Download] Turns on/off automatic downloading of the phonebook from the connected cellular phone.
	[Sort Phone Book by] Changes the sorted order of contacts in the phonebook.
[Text Message]	[Text Message] Turns the text messaging function on/off.
	[Text Message Ringtone] Turns the incoming message sound on/off.
	[Signature] Turns the signature setting for the outgoing text message on/off.
	[Auto Reply] Turns on/off the automatic text message reply function.
	[Auto Reply Text Message] Selects the text message to be used for the automatic reply function.
	[Edit Custom Text] Creates or edits a customized text message reply.

4. Hands-Free Phone

[Notifications]	[Driver Only]	When this item is turned on, incoming call notification is displayed only in the vehicle information display.
	[Vehicle Ringtone]	Turns the vehicle ringtone on/off.
[Automatic Hold]		When this item is turned on, an incoming call will be put on hold automatically.



INFO:

The setting of [Driver Only] is unavailable while Apple CarPlay (if equipped) or Android Auto (if equipped) is active.

4. Hands-Free Phone

Volume settings

Volume settings can be adjusted.

1. Touch [Phone] on the Launch Bar.
2. Touch [Volume].

The following volume setting items are available.

Setting items	Action
[Ringtone]	Adjusts the volume level of the ringtone of incoming calls.
[Outgoing Call]	Adjusts the volume level of the outgoing calls.



INFO:

The volume settings can also be accessed from [Settings] on the Launch Bar.

“System settings” (page 1-14)

Quick Dial

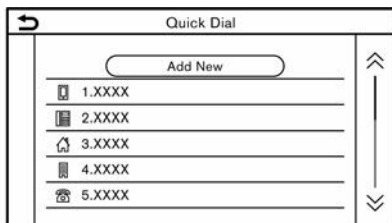

Up to 20 Quick Dial entries can be registered.

Quick Dial entries can be used to quickly make a call or send text messages.

Registration:

1. Touch [Phone] on the Launch Bar.
2. Touch [Quick Dial].
3. Touch [Edit].
4. Touch [Add New] to register a phone number to the Quick Dial list.
5. Select a method for registration.

Available methods:

- [Copy from Call History]:
A phone number can be selected from [All], [Incoming], [Outgoing], or [Missed] call history lists.
- [Copy from Phone Book]:
A phone number can be selected from the phonebook.
- [Enter Number with Keypad]:
A phone number can be entered

manually using keypad.



INFO:

- Available methods may vary depending on cellular phone support.
6. When a phone number has been selected, the registration screen is displayed. Enter the phone number and edit the entry information as necessary.
7. Touch [OK] to save the entry.



INFO:

- Quick Dial entries can also be registered by touching [Settings] on the Launch Bar and then selecting [Phone].
 “Phone settings” (page 4-10)

- Either of the connected phone devices can be selected for Quick Dial operation when [Allow 2 Phones Simultaneously] is turned on.

 "Bluetooth® settings"
(page 1-17)

Voice Tag (if equipped):

A voice tag can be recorded for each of the registered Quick Dial numbers and can be used to dial the number by speaking it.

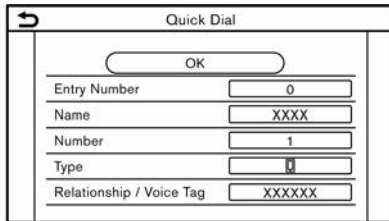

Quick Dial	
OK	
Entry Number	0
Name	XXXX
Number	1
Type	
Relationship / Voice Tag	XXXXXX

On the Quick Dial registration screen, select [Relationship / Voice Tag].

- Select a preferred relationship from the list.
- Touch [Customise] and touch [Record] to register your original voice tag.



INFO:

- Touch [Play] to play the recorded voice tag.
- Touch [Delete] to delete the voice tag.

4. Hands-Free Phone

MEMO

5 Information

Information menu	5-2
Updating system software (if equipped)	5-5
NissanConnect Services (if equipped)	5-6
Privacy policy NissanConnect Services	5-6
NissanConnect Services menus	5-6
NissanConnect Services settings	5-7
Apple CarPlay (if equipped)	5-7
Compatibility	5-8
Apple CarPlay operation	5-8
Apple CarPlay settings	5-10
Apple CarPlay system limitations	5-11
Android Auto™ (if equipped)	5-11
Compatibility	5-11
Initial Android Auto settings	5-12
Android Auto operation	5-12
Android Auto settings	5-14
Android Auto system limitations	5-15
Siri Eyes Free (if equipped)	5-15
Requirements	5-15
Siri Eyes Free activation	5-15
Operating Siri Eyes Free	5-15



5. Information

INFORMATION MENU

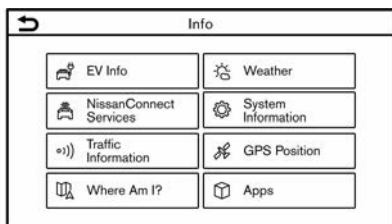

The information screen sets or displays various information.







Push **<MENU>** and then touch [Info] on the Launch Bar to display the Information menu.

Available items may vary depending on models and specifications. Items displayed on the screen may not function depending on various conditions.





Models with navigation system:

Menu item	Action
[EV Info]	Display the EV Info menu screen.  "EV Info menu screen" (page 2-2)
[NissanConnect Services]	Displays the NissanConnect Services menu screen.  "NissanConnect Services" (page 5-6)
[Traffic Information]/[Premium Traffic]	Displays the Traffic Information screen.  "Viewing traffic information" (page 6-36)
[Where Am I?]	The name and distance of the next/previous street, and other information that indicates the current vehicle location are displayed. Latitude and longitude of the current vehicle location are shown on the bottom right.

Menu item		Action
[Weather]	[Current Conditions]	Current, hourly or 5-day weather information is displayed.
	[Hourly Weather Forecast]	Weather information for nearby location, near the destination and your preferred city set as a Favorite City can be confirmed.
	[5-Day Weather Forecast]	Current, hourly or 5-day weather information can be changed by touching [Current], [Hourly] or [5-Day]. Nearby location, near the destination and your preferred city can be changed by touching [Nearby], [Near Dest.] or [Favourite City]. Favorite city can be changed by touching [Change City].
	[Communication Settings]	Turns the TomTom weather data transmission on/off.
[System Information]	[Version Information]	Displays the version information screen.
	[Software Update]	The system software can be updated.  "Updating system software" (page 5-5)
	[Map Update]	The map data can be updated.  "How to update map data" (page 6-53)
	[Licence Information]	Displays the Open Source Software licenses information.
[GPS Position]		Displays Global Navigation Satellite System (GNSS) information, such as number of satellites, latitude/longitude, and approximate altitude, etc.
[Apps]	[Apple CarPlay]	Displays the Apple CarPlay screen.  "Apple CarPlay" (page 5-7)
	[Android Auto]	Displays the Android Auto screen.  "Android Auto™" (page 5-11)

5. Information

Models without navigation system:

Menu item		Action
[NissanConnect Services]		Displays the NissanConnect Services menu screen.  "NissanConnect Services" (page 5-6)
[System Information]	[Version Information]	Displays the version information screen.
	[Software Update]	The system software can be updated.  "Updating system software" (page 5-5)
	[Licence Information]	Displays the Open Source Software licenses information.
[Apps]	[Apple CarPlay]	Displays the Apple CarPlay screen.  "Apple CarPlay" (page 5-7)
	[Android Auto]	Displays the Android Auto screen.  "Android Auto TM " (page 5-11)

UPDATING SYSTEM SOFTWARE (if equipped)



WARNING

TO AVOID RISK OF DEATH OR SERIOUS PERSONAL INJURY WHEN UPDATING THE SYSTEM SOFTWARE:

If you choose to park the vehicle within range of a Wi-Fi connection, park the vehicle in a secure and safe location.

1. **Apply the parking brake.**
2. **Remain with the vehicle while the update is in process.**
3. **Do not allow children, pets or people who may need assistance to remain in the vehicle while the software is updating.**



NOTE:

The vehicle is not required to be parked during the software update process. If the vehicle disconnects from the Wi-Fi connection, it will resume when the vehicle reconnects to a known Wi-Fi connection.



INFO:

- The system prioritizes Wi-Fi connection over TCU (Telematics Control Unit) when Wi-Fi network connection is available.

- You will be charged separately when the network communication is made via smartphones.
- The download data size of software updates can vary between 80 MB to 300 MB. If you use your smartphone as a Wi-Fi connection, you may incur data charges from your phone carrier. Please connect to a secure WPA2 Wi-Fi network to avoid potential phone carrier data charges.

How to update from the pop-up screen

When both of the following conditions are met, the system informs the driver with a pop-up on the screen when system software update is available.

- [Auto] is selected under [Update Method].
 - ☞ "How to update from the system menu" (page 5-5)
- Wi-Fi or TCU (Telematics Control Unit) network connection is available.
 - ☞ "Wi-Fi setting" (page 1-17)
 - ☞ "NissanConnect Services" (page 5-6)

1. When the pop-up appears and prompts the driver to perform the system software update, operate the system according to the guides shown on the screen to download the updates. Another pop-up will appear when downloading is complete.

2. After the system software update is complete, place the power switch in the OFF position and leave the system for 20 minutes without operating the switches on the control panel and the steering wheel. Place the power switch in the ON position and the updated software will be available.



INFO:

The update may not be reflected if the power switch is placed back in the ON position before the 20-minute period has passed.

How to update from the system menu



WARNING

To operate the system for software update, first park the vehicle in a safe location.

System software updates can be downloaded manually via Wi-Fi or TCU (Telematics Control Unit) from the system menu.

1. Connect to network via Wi-Fi if you wish to perform the software update via Wi-Fi connection.
 - ☞ "Wi-Fi setting" (page 1-17)
2. Push **<MENU>**.

5. Information

3. Touch [Info] on the Launch Bar and then touch [System Information].
4. Touch [Software Update].

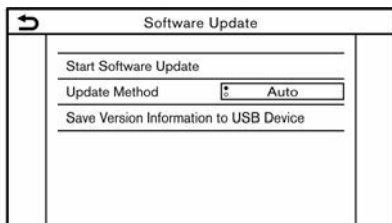

Example

5. Touch [Start Software Update]. The current software version and date of last check are displayed.



INFO:

When [Update Method] is set to [Auto], a notification is made in case that software can be updated.

6. To check manually for available updates, touch [Check for an Update]. A message is displayed when update availability is confirmed.
7. Touch [Download] to start downloading and updating the system software.
8. After the system software is complete, place the power switch in the OFF position and leave the system for 20 minutes without operating the switches on the control panel and the steering wheel. Place the power switch in the ON position and the updated software will be available.



INFO:

- The update may not be reflected if the power switch is placed back in the ON position before the 20-minute period has passed.
- If updating software is unnecessary, touch [OK] to return to the previous screen.
- [Save Version Information to USB Device] (if equipped) is not available on this system.
- The same operation can be performed by touching [Settings] on the Launch Bar and then touching [System Update].

NISSANCONNECT SERVICES (if equipped)

This vehicle incorporates a communication device that is called TCU (Telematics Control Unit). The communication connection between this unit and the Nissan Data Center allows for various services.

For details, refer to the NissanConnect Services app and YOU+Nissan Owners' Portal.

PRIVACY POLICY NISSANCONNECT SERVICES

The transferred personal data will be stored only for period necessary for the processing, and will be then deleted or anonymized. For any further information in relation to the retention period and the protection of your personal data, please refer to the Terms and Conditions available in the NissanConnect Services app and YOU+Nissan Owners' Portal.

NISSANCONNECT SERVICES MENU

With NissanConnect Services, various information can be received and displayed on the screen. The information can also be announced by the system.

NISSANCONNECT SERVICES SETTINGS

NissanConnect Services settings can be changed.

1. Touch [Info] on the Launch Bar.
2. Touch [NissanConnect Services].
3. Touch [NissanConnect Services Settings].

Available setting items may vary depending on models, specifications and software versions.



INFO:

[NissanConnect Services] can also be accessed from [Settings] on the Launch Bar.

Setting items	Action
[Information Channel Setting]	Displays the Information Channel Setting screen.
[Unit ID Information]	Displays the Unit ID Information screen.
[Reset all NissanConnect Svcs. Settings to Default]	All NissanConnect Services settings are returned to default.
[Privacy Mode Setting]	Allows you to accept or decline the privacy mode setting.



INFO:

What happens when Privacy Mode is ON?

When Privacy Mode is ON (by declining NissanConnect Services while switching on your vehicle or via the NissanConnect Services settings), your data will not be processed for purposes relating to NissanConnect Services. They might however be processed for the purpose of services other than NissanConnect Services which are (i) either mandatory (such as eCall in Europe, or Glonass in Russia), (ii) that you might have activated independently and manually (such as bCall, concierge service, co-pilot button), or (iii) relating to services that you have subscribed to and remains activated for your safety (SVT, theft/burglar notification).

Apple CarPlay (if equipped)



WARNING

- **Stop your vehicle in a safe location and apply the parking brake before connecting your iPhone to the vehicle or operating your connected iPhone for setup.**
- **If you are unable to devote full attention to vehicle operation while using Apple CarPlay, pull off the road to a safe location and stop your vehicle.**

You can use Apple CarPlay by connecting a compatible iPhone to your vehicle via a USB cable.

To connect your iPhone with the in-vehicle system, it is recommended to use the Apple Lightning cable (Mfi certified) that was provided with your iPhone.

With Apple CarPlay, your in-vehicle system can be used as a display and a controller for some of the iPhone functions. Apple CarPlay features Siri which enables operations via voice controls. Visit apple.com for information about the functions that are available and details about Apple's privacy policy.

Certain vehicle information (e.g. location and speed) may be shared with your device while Apple CarPlay is in use. Carrier charges may apply to use Apple

5. Information

CarPlay.

COMPATIBILITY

The following iPhone models support Apple CarPlay.

Model	Firmware version
iPhone 5 or later	iOS 8.4 or later

Refer to the Apple website for more information.



INFO:

- In some countries, iPhone in the market may not be supported by Apple CarPlay.
- For best results, always update your device to the latest software version.
- Apple CarPlay will take the place of your Bluetooth® audio and Bluetooth® hands-free phone functionality.
- Phone menu and access to the connected phone through Voice Recognition System (if equipped) will be disabled while Apple CarPlay is connected. To access your phone, use the Siri function or select the phone icon in the Apple CarPlay top menu screen.

Apple CarPlay OPERATION

1. Connect the iPhone to the USB connection port.
 - ✎ “USB (Universal Serial Bus) connection port and AUX (auxiliary) input jack” (page 1-5)
2. Depending on the setting, a Startup Information screen will appear. Touch [Yes] to use Apple CarPlay.



INFO:

If you do not wish to display the Startup Information screen each time you activate Apple CarPlay, turn on [Don't Ask Any More] on the Startup Information screen. The Startup Information screen will not be displayed from the next Apple CarPlay activation. The Startup Information screen can be set to appear again in the Apple CarPlay setting menu.

- ✎ “Apple CarPlay settings” (page 5-10)
3. The Apple CarPlay screen will appear. The iPhone functions displayed on the screen should now be operable using the in-vehicle system.
 4. To return to the Apple CarPlay top menu screen after detailed operation, touch on the lower corner of the Apple CarPlay screen.



INFO:

- Push the buttons such as **<MENU>** on the control panel to exit Apple CarPlay. The screen corresponding to the button is displayed.
- To return to the Apple CarPlay screen, take one of the following actions.
 - Touch [CarPlay] on the Launch Bar.
 - Touch [Apps] on the information screen, and then touch [Apple CarPlay].
- When your iPhone is locked, Apple CarPlay can still be activated by operating the iPhone and allowing Apple CarPlay activation when asked.

Siri operation

With Siri, some of the functions in your iPhone can be voice controlled.

Make sure that Siri on your iPhone is turned on.

Activation:

Perform one of the following operations to start a Siri session.

- Push and hold on the steering wheel.
- Touch and hold at the lower corner of the Apple CarPlay screen.



INFO:

- Push < > or touch to end Siri operation.
- Keep the interior of the vehicle as quiet as possible. Close the windows to eliminate the surrounding noises (traffic noises, vibration sounds, etc.), which may prevent the system from recognizing the voice commands correctly.
- For functions that can be used with Siri, please refer to the Apple website.

Phone operation

If you wish to use your phone with Apple CarPlay, follow the procedure below:

1. Touch [Phone] on the Apple CarPlay top menu.
2. Operate the screen displayed to make a call, etc.

5. Information

Apple CarPlay SETTINGS

1. Touch [Settings] on the Launch Bar.
2. Touch [Apps].
3. A list of devices is displayed.

Touch  by the name of the Apple CarPlay device you wish to change the setting.

Available items:

Setting item 1	Setting item 2	Action
[Enable after USB Connection:]	[Always]	Activates Apple CarPlay automatically when an iPhone is connected to the in-vehicle system.
	[Ask]	Displays the Apple CarPlay Startup Information screen when an iPhone is connected to the in-vehicle system.
	[Never]	Apple CarPlay will not activate even if an iPhone is connected to the in-vehicle system.
[Nissan's Help for Apple CarPlay]		Displays helpful tips for Apple CarPlay operation.
[Delete]		Deletes registered iPhone from the list.



INFO:

- Access to songs on your iPod via in-vehicle voice recognition system (if equipped) will not be available when connected to Apple CarPlay. To access to your iPod music, use the Siri function or select the music icon in the Apple CarPlay top menu screen.
- Apple CarPlay settings can also be accessed from the Connections screen.
 "Apps settings" (page 1-19)

Apple CarPlay SYSTEM LIMITATIONS

For all features of Apple CarPlay to operate correctly, it is necessary to have a compatible iPhone, a cellular connection and a data plan.

When Apple CarPlay is operating, system performance is affected by the strength of the cellular connection or performance of the phone itself. If performance of the system decreases:

- Disconnect and reconnect your phone
- Cycle phone power off/on to restart

Functionality of Apple CarPlay may decrease or be lost if there are changes to operating systems, hardware, software or other technologies central to supporting the system that are outside of NISSAN's control. Changing government regulations may also affect operation of Apple CarPlay.

Android Auto™ (if equipped)



WARNING

- **Stop your vehicle in a safe location and apply the parking brake before connecting your Android phone to the vehicle or operating your connected Android™ phone for setup.**
- **If you are unable to devote full attention to vehicle operation while using Android Auto, pull off the road to a safe location and stop your vehicle.**

You can use Android Auto by connecting a compatible Android phone to your vehicle via a USB cable. It is also recommended to use the Android phone OEM cable that was provided with your phone.

With Android Auto, your in-vehicle system can be used as a display and a controller for some of the Android phone functions. Voice control of some of the Android phone functions is also possible with Android Auto. Visit www.android.com for information about the functions that are available and details about Google's privacy policy.

Certain vehicle information (e.g. location and speed) may be shared with your device while Android Auto is in use. Carrier charges may apply to use Android Auto.

COMPATIBILITY

Only Android 5.0 (Lollipop) or later versions are compatible with Android Auto. Refer to the Android Auto website for more information.



INFO:

- In some countries, Android phone in the market may not be supported by Android Auto.
- Download the Android Auto App from Google Play to Android phone in advance.
- For best results, always update your device to the latest Android software and Android Auto App version. When you connect the Android phone to the in-vehicle system, it will automatically update the Android software and Android Auto App version.
- Android Auto will take the place of your Bluetooth® audio and Bluetooth® hands-free phone functionality.
- When setting a route with the navigation system (if equipped), if you set a destination with Android Auto, the route setting of the navigation system will be cancelled.
- The Phone menu and access to the connected phone through the Voice Recognition System (if equipped) will be disabled while Android Auto is connected. To access your phone,

5. Information

use the Google Assistant function or select the phone icon in the Android Auto top menu screen.

INITIAL Android Auto SETTINGS

Before using Android Auto, the Android Auto App must be downloaded on your Android phone.

For downloading the Android Auto App, refer to the Google Play website.

It may be necessary to operate the Android phone when connected first.

Depending on the selection, such as approval, some of the features of Android Auto are not available.

Android Auto OPERATION

Unlock your phone's screen before connecting your Android phone.

1. Connect your Android phone to USB connection port.

 "USB (Universal Serial Bus) connection port and AUX (auxiliary) input jack" (page 1-5)

2. Depending on the setting, a Startup Information screen will appear. Touch [Yes] to use Android Auto.



INFO:

- If you do not wish to display the Startup Information screen each time you activate Android Auto, turn on [Don't Ask Any More] on the Startup Information screen. The

Startup Information screen will not be displayed from the next Android Auto activation. The Startup Information screen can be set to appear again in the Android Auto setting menu.

 "Android Auto settings" (page 5-14)

- Your phone's Bluetooth® will be turned on automatically when Android Auto is activated. Keep the Bluetooth® turned on to use the phone functions.
 - Some functions of Android Auto are not available if the Bluetooth® is not connected.
3. The Android Auto top menu screen will appear. The Android phone functions displayed on the screen should now be operable using the in-vehicle system.
 4. To exit the Android Auto screen, touch  and then touch [Return to Nissan] on the Android Auto screen.



INFO:

- If [Return to Nissan] does not appear, touch  again.
 - When pushing the buttons, such as **<MENU>** on the control panel, the corresponding display to the button is displayed.
5. To return to the Android Auto screen, take one of the following actions.

- Touch  on the Launch Bar.
- Touch [Apps] on the information screen, and then touch [Android Auto].



INFO:



- While Android Auto is activated on the Android phone, the phone operations, such as making or receiving calls, can only be done with Android Auto.
- Depending on the device, an Android phone requires MTP mode to be selected in the USB transfer setting.

Google Assistant™ operation

Some of the functions on your Android phone can be voice controlled when Android Auto is active.



Activation:

Perform one of the following operations to start a Google Assistant session.

- Push and hold  on the steering wheel.
- Touch  on the Android Auto screen.



INFO:

- Push  or touch  to end voice operation.
- Keep the interior of the vehicle as quiet as possible. Close the windows to eliminate the surrounding noises (traf-

fic noises, vibration sounds, etc.), which may prevent the system from recognizing the voice commands correctly.

- For functions that can be used with the voice operation, refer to the Android Auto website.

Phone operation

If you wish to use your phone while Android Auto is activated, follow the procedure below:

1. Touch  on the Android Auto screen.
2. Operate the screen displayed to make a call, etc.

5. Information

Android Auto SETTINGS

1. Touch [Settings] on the Launch Bar.
2. Touch [Apps].
3. A list of devices is displayed.

Touch  by the name of the Android Auto device you wish to change the setting.

Available items:

Setting item 1	Setting item 2	Action
[Enable after USB Connection:]	[Always]	Activates Android Auto automatically when an Android phone is connected to the in-vehicle system.
	[Ask]	Displays the Android Auto Startup Information screen when an Android phone is connected to the in-vehicle system.
	[Never]	Android Auto will not activate even if an Android phone is connected to the in-vehicle system.
[Nissan's Help for Android Auto]		Displays helpful tips for Android Auto operation.
[Delete]		Deletes registered Android phone from the list.



INFO:

Android Auto settings can also be accessed from the Connections screen.

 "Apps settings" (page 1-19)

Android Auto SYSTEM LIMITATIONS

For all features of Android Auto to operate correctly, it is necessary to have a compatible Android phone, a cellular connection and a data plan.

When Android Auto is operating, system performance is affected by the strength of the cellular connection or performance of the phone itself. If performance of the system decreases:

- Disconnect and reconnect your phone
- Close all apps and restart them
- Cycle phone power off/on to restart

It should also be confirmed that the latest version of both Android OS and the Android Auto App are installed on the cellular phone.

Functionality of Android Auto may decrease or be lost if there are changes to operating systems, hardware, software or other technologies central to supporting the system that are outside of NISSAN's control. Changing government regulations may also affect the operation of Android Auto.

SIRI EYES FREE (if equipped)

Apple Siri Eyes Free personal assistant can be accessed from the vehicle. Siri Eyes Free can be accessed in Siri Eyes Free mode to reduce user distraction. In this mode, Siri Eyes Free is available for interaction by voice control. After connecting a compatible Apple device via Bluetooth®, Siri Eyes Free can be activated by using <  > on the steering wheel.

Siri is a trademark of Apple Inc., registered in the U.S. and other countries.



INFO:

- Some Siri Eyes Free functions, such as opening apps, may not be available during driving.
- For best results, always update your device to the latest software version.
- Keep the interior of the vehicle as quiet as possible. Close the windows to eliminate the surrounding noises (traffic noises, vibration sounds, etc.), which may prevent the system from recognizing the voice commands correctly.
- For functions that can be used in Siri Eyes Free, please refer to the Apple website.

REQUIREMENTS

Siri is available on the iPhone 4S or later. Devices released before iPhone 4S are not supported by the Siri Eyes Free system.



Visit Apple's website for details about device compatibility.

Siri must be enabled on the phone. Please check phone settings.

If the device has a lock screen, Siri must be accessible from the lock screen. Please check phone settings.

SIRI EYES FREE ACTIVATION

Siri Eyes Free function can be activated using <  > on the steering wheel.

1. Connect a Siri Eyes Free enabled iPhone to the vehicle.
 -  "Setting Bluetooth®" (page 1-16)
2. After the Bluetooth® connection is established, push and hold <  > on the steering wheel to activate the Siri Eyes Free function.

OPERATING SIRI EYES FREE

1. Push and hold <  > on the steering wheel.
2. Speak your command and then listen to the Siri Eyes Free reply.

After starting Siri Eyes Free, push <  > on the steering wheel again within five seconds of the end of the Siri Eyes Free announcement to extend the session.

5. Information

MEMO

6 Navigation (if equipped)

Safety information	6-2	Using Door-to-Door Navigation (if equipped)	6-21
Navigation screen	6-2	Options before starting the route guidance	6-22
Displaying navigation screen	6-2	Route guidance	6-23
Launch Bar	6-2	About route guidance	6-23
Map operation	6-3	Route menu	6-25
Map types	6-3	Canceling Route	6-28
Road color	6-5	Displaying Turn List	6-28
Moving map	6-5	Setting detour route	6-28
Changing scale of map	6-6	Route Preference	6-29
Changing map	6-6	Recalculating route	6-32
Map settings	6-8	Editing route	6-32
Setting information on map	6-11	Guidance settings	6-35
Traffic information on map (if equipped)	6-12	Viewing traffic information (if equipped)	6-36
Map Menu screen	6-12	RDS-TMC feature	6-36
Setting destination	6-13	Premium Traffic information	6-36
Basic operations	6-13	Viewing available traffic information	6-36
Free text search	6-15	Traffic information settings	6-38
Setting home or work location as destination	6-16	Storing a location/route	6-38
Finding address	6-16	Storing location	6-38
Finding points of interest	6-16	Storing route	6-39
Searching from Address Book	6-18	Storing avoid area	6-40
Searching from previous destinations	6-18	Editing stored information	6-40
Finding charging station	6-19	Deleting stored item	6-43
Setting by phone number (if equipped)	6-19	Navigation settings	6-45
Setting destinations by Google (if equipped)	6-20	General information for navigation system	6-48
Setting from saved routes	6-20	Current vehicle location	6-48
Setting point on map	6-20	Route calculation	6-51
Setting with latitude/longitude	6-21	Route guidance	6-52
		How to update map data (if equipped)	6-53

6. Navigation (if equipped)

SAFETY INFORMATION

The navigation system is primarily designed to help you reach your destination. However, you, the driver, must use the system safely and properly. Information concerning road conditions, traffic signs and the availability of services may not always be up to date. The system is not a substitute for safe, proper, and legal driving.



WARNING

Do not rely on route guidance alone. Always be sure that all driving maneuvers are legal and safe in order to avoid accidents.

NAVIGATION SCREEN

DISPLAYING NAVIGATION SCREEN

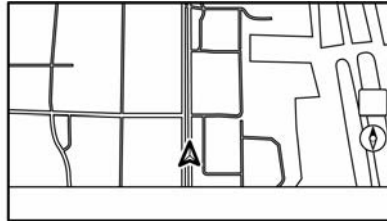

To display the current location map which can be operated, push **<MENU>** and then touch [Map] on the Launch Bar or push **<MAP>**.

Destination settings or other navigation operations are also available from the Launch Bar.

LAUNCH BAR

The Launch Bar related to operating the navigation system is displayed on the current location map screen. Displayed items vary depending on the route settings.

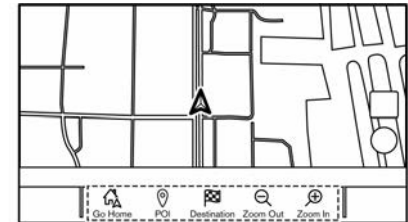

Before setting the destination

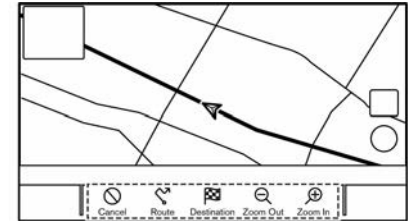

After setting the destination

Menu item	Action
[Add Home]/[Go Home]	<p>[Add Home]: When the home location is not stored, a home location can be stored in the system. ☞ "Storing home or work location" (page 6-38)</p> <p>[Go Home]: When the home location is stored, sets the home location as a destination. ☞ "Setting home or work location as destination" (page 6-16)</p>
[POI]	<p>Searches for a Points of Interest to set as a destination. ☞ "Finding points of interest" (page 6-16)</p>
[Destination]	<p>Displays the destination menu. ☞ "Setting destination" (page 6-13)</p>
[Zoom Out]	<p>Zoom out the map. ☞ "Changing scale of map" (page 6-6)</p>
[Zoom In]	<p>Zoom in the map. ☞ "Changing scale of map" (page 6-6)</p>
[Cancel]	<p>Cancels the route guidance. ☞ "Canceling Route" (page 6-28)</p>
[Route]	<p>Displays the route menu screen. ☞ "Route menu" (page 6-25)</p>

MAP OPERATION

MAP TYPES

Two types of map views are available: 2D and 3D.

2D map

The 2D map displays the map in a two-dimensional environment similar to a road map.

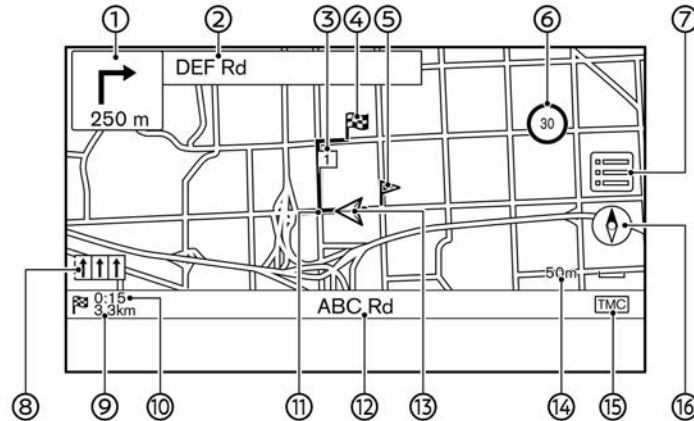

Screen information:

- ① Arrow and distance:

Indicates the distance to the next guide point and the turning direction at that guide point.

If the current vehicle position is off the road, an arrow indicating the direction to the nearest road may be displayed instead of displaying the

next turn arrow/distance.























- ② Next street name:

Displays the next street name during the route guidance.

- ③ Waypoint:

Displays the location of the waypoint that the vehicle will stop by before heading to the final destination. A maximum of 20 waypoints can be set.

6. Navigation (if equipped)

- ④  Destination:
Indicates the location of the final destination.
- ⑤  Stored location:
Displays the locations that are stored in the Address Book.
 "Storing location" (page 6-38)
The icons can be changed according to your preferences.
- ⑥  Speed limit indicator:
Displays the speed limit of the road which the vehicle is on.
When the vehicle speed exceeds the limit, the indicator flashes.
When the speed limit indicator is not displayed in the unit selected in the Unit settings screen (if equipped), a speed limit in the selected unit may be displayed below the speed limit indicator.
 "Units settings" (page 1-21)
The settings for the speed limit indicator can be changed.
 "Navigation settings" (page 6-45)
- ⑦ :
Touch to display the Map Menu.
 "Map Menu screen" (page 6-12)
- ⑧  Recommended lane indicator:
When a route is set, the arrow and the recommended driving lane may be displayed depending on the road.
- Blue: First recommendation
White: Secondary recommendation
Gray: Not recommended
- ⑨  Remaining distance to the destination:
Indicates the approximate remaining distance to the destination or the waypoint. This indicator will appear when a destination is set and route guidance is started.
- ⑩  Remaining time/Time of arrival:
Indicates the remaining time to the destination/waypoint, or it can be set to display the estimated arrival time. This indicator will appear when a destination is set and the route guidance is started.
The remaining time or arrival time display can be selected to your preference.
 "Route Preference" (page 6-29)
- ⑪  Suggested route:
Appears in bold blue during route guidance.
- ⑫  Street name:
Displays the name of the street that the vehicle is currently driving on.
- ⑬  Vehicle icon:
Indicates the current vehicle location and the direction that the vehicle is heading.
- ⑭  Scale indicator:
Indicates the scale of the map.
- ⑮  Traffic information reception status indicator (if equipped):
This indicator is displayed in a condition where traffic information can be received.
Touch to display the traffic information screen.
 "Viewing traffic events from list" (page 6-36)
[PREMIUM TRAFFIC]:
Displayed when [Use Premium Traffic] is turned on and the traffic information is available.
 "Traffic information settings" (page 6-38)
[TMC]:
Displayed when [Use Premium Traffic] is turned off and the traffic information is available.
 "Traffic information settings" (page 6-38)
- ⑯ :
Indicates the directional setting of the map.
Touch to change the map view and the map orientation.
 "Changing map view and map orientation" (page 6-6)

6. Navigation (if equipped)

3D map

The 3D map displays the map from an elevated perspective. In 3D map, it is easy to recognize an image of the route because it provides a panoramic view over a long distance.

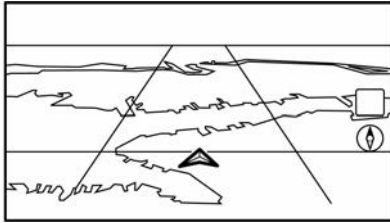

INFO:

The 3D map always appears with the current forward direction facing up.

Building graphics

Building graphics are stored in the map data for certain areas, and can be displayed when the map is zoomed in.

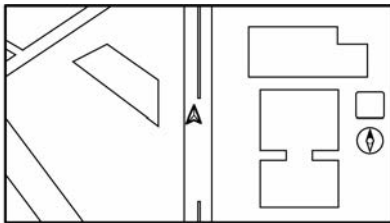

2D building graphics

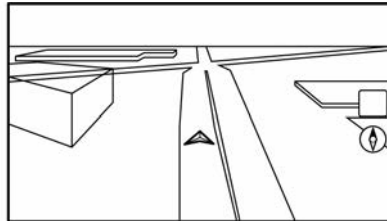

3D building graphics

INFO:

In an area where the building graphics are not stored in the map data, the normal map is displayed even when the map is zoomed in.

ROAD COLOR

The road types are differentiated by color.

Color	Road type
Yellow and red outline	Motorway
Red or orange	Main road
Yellow or white	Narrow street

MOVING MAP

The map can be scrolled by the touch panel operations. Map scrolling operations may be limited while driving.

Touch:

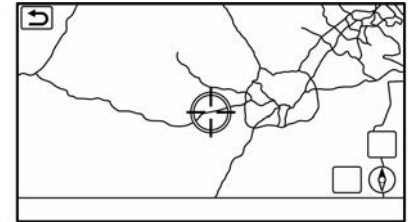

When a point on the map is touched, the cross pointer is displayed and the position touched is moved to the center of the screen.

After moving the map, touch [↻] on the map screen or push <MAP> to display the current location map screen.

Long touch:

Touch the direction to move to. The map continues to scroll while the screen is touched.

Drag:

Drag the screen to scroll the map.

Swipe/flick:

Swipe or flick the screen to scroll the map screen quickly.

6. Navigation (if equipped)

CHANGING SCALE OF MAP

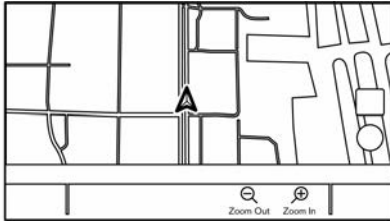

To change the map scale, touch [Zoom Out] or [Zoom In] on the Launch Bar.

Other operations:

- While the cross pointer is displayed, the scale bar can be displayed by touching the scale indicator on the map.
Touching [⊖] or [⊕] on the scale bar can change the map scale while the scale bar is displayed.
- Rotating <⊖> <⊕> /OK> can also change the map scale.

Free Zoom:

Depending on the setting, rotating <⊖> <⊕> /OK> to change the map scale may adjust the scale normally, or it may engage the free zoom (finer scale adjustment in smaller steps).

☞ "Map settings" (page 6-8)

Changing map scale while moving map

The map scale can also be changed by directly touching the map. Touch the map to display the cross pointer before performing the scale change.

Pinch-in



To view a wider area, pinch-in the map screen.

Pinch-out



To view the map in detail, pinch-out the map screen.

INFO:

Depending on the map scale, traffic information icons cannot be displayed on the map screen.

☞ "Traffic information on map" (page 6-37)

CHANGING MAP

Changing map view and map orientation

The map view and the map orientation can be changed by touching [Ⓛ] on the map screen.

The screen will change to North Up, Heading Up and 3D each time [Ⓛ] is touched.

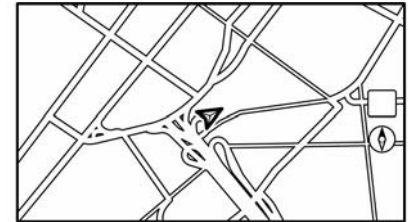

North Up

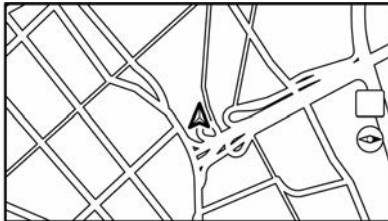



Heading Up



3D

INFO:

- You can also change the map view from the map view settings screen.
 "Map settings" (page 6-8)
- A long range map is available that displays a wider area in the direction the vehicle is moving in the Heading Up view.
 "Map settings" (page 6-8)

Setting split screen

Two different maps can be displayed at once on a screen with the split screen setting.

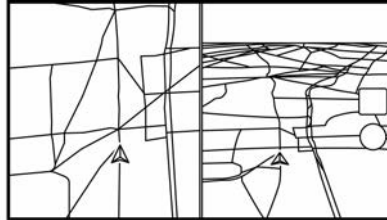

1. Touch  on the map screen.
2. Touch [Map Settings].
3. Touch [Dual Map View].
4. Select [Split: 2D Map] or [Split: 3D Map].

INFO:

The settings on the left split map can be changed from the navigation settings menu.

 "Map settings" (page 6-8)

6. Navigation (if equipped)

MAP SETTINGS

The setup for the map view is performed from the Map Menu on the touch screen display.

1. Touch  on the current location map screen.
2. Touch [Map Settings].





INFO:

[Map Settings] can also be accessed from [Settings] on the Launch Bar.

 "Navigation settings" (page 6-45)

Available setting items may vary depending on models and specifications.

Menu item	Action	
[Dual Map View]	[2D Map]	Displays 2D map.
	[3D Map]	Displays 3D map.
	[Split: 2D Map]	Displays 2D map on both left and right side of the split screen. You can see the different scale and settings of 2D maps at the same time.
	[Split: 3D Map]	Displays 2D map on the left side and 3D map on the right side of the split screen.
[Left Side Info]	[Intersection]	Displays the enlarged view of the next intersection on the left side of the screen during route guidance.  "Route guidance screens" (page 6-23)
	[Turn List]	Displays the turn list on the left side of the screen when a route is set.  "Route guidance screens" (page 6-23)
	[Full Map]	Displays full map screen.
[Map Icons]	Select the categories of POI icons to display on the map screen.  "Displaying map icons" (page 6-11)	
[More Settings]	[Map Orientation]	The map orientation can be selected from [North Up] or [Heading Up]. [Map Orientation] is available only when 2D map is displayed.
	[Long Range]	The position of the vehicle icon is located slightly lower than the center of the screen to view a wider area in the traveling direction. Long Range is available only when the map view is in [Heading Up] mode.

6. Navigation (if equipped)

Menu item		Action
[Left Split Map Settings]	[Map Orientation]	The map orientation for the left side of split screen can be selected from [North Up] or [Heading Up].
	[Long Range]	With this item turned on, the vehicle position icon on the left screen will be located slightly lower than the center of the screen so that a wider area in the traveling direction can be viewed. Long Range Map View is available only when the left side of split screen is in [Heading Up] mode.
	[Map Scale]	Sets the map scale of the left screen.
[Audio Display on Map]		Turns on/off the audio information displayed at the top of the map screen.
[Map Colour]		Sets map color from [Standard], [Emphasise Roads], [Emphasise Text] and [Emphasise Traffic].
[Map Text Size]	[Large]	Sets the font size of the text displayed on the map screen.
	[Medium]	
	[Small]	
[Select Text to Display on Map]	[Place Names]	Allows place, facility and road names to be displayed on the map screen.
	[Facility Names]	
	[Road Names]	
[Map Scrolling Information]		Information about the location, on which the center of the cross pointer is placed by scrolling on the map, can be set to be displayed.  "Displaying map scrolling information" (page 6-11)
[Tracking Dots Displayed on Map]	[Record & Show Tracking Dots on Map]	Turns the route tracking dots display on/off.
	[Tracking Dot Distance]	Select the interval between tracking dots.
	[Delete Track to Current Location]	Deletes the route tracking dots up to the current location.

6. Navigation (if equipped)

Menu item	Action
	[Small Step Zoom with Dial]
	[Show all M-way Exits on Route]
	[Auto. Show Turn List on M-way]
	[North Up when Zoomed Out]
[Back to Map]	Back to the current location map.

SETTING INFORMATION ON MAP

Some information on the map can be displayed or hidden.

Displaying map icons

Displays map icons of certain points of interest (such as restaurants, parking lots, etc.) on the map.

1. Touch [Settings] on the Launch Bar.
2. Touch [Navigation].
3. Touch [Map Settings].
4. Touch [Map Icons].
5. Touch the preferred icon. The indicator of the selected icon illuminates.



INFO:

- [Map Icons] can also be accessed from on the Map screen.
- The charging station icon can be also set by performing the following procedure.
 1. Push **<MENU>**.
 2. Touch [Info] on the Launch Bar and then touch [EV Info].
 3. Touch [EV Settings].
 4. Touch [Show Charging Stations on Map].
- If brand icons are registered in the map data, the brand icons will be displayed on the map instead of the general map icons.

Charging station icons:

Charging station locations are displayed with icons below on the map.



: Normal charging station



: Quick charging station



INFO:

- Charging stations that are registered as open 24 hours are displayed in icons with "24" marked by the charging station icon.
 - : 24 hours open normal charging station
 - : 24 hours open quick charging station
- Models with NissanConnect Services:

When charging station information is updated, the updated charging stations will be displayed as icons with "New" marked by the charging station icon.



: Updated normal charging station



: Updated quick charging station

Displaying map scrolling information

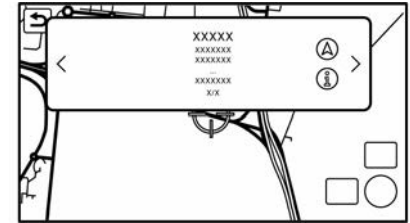

Information about the location on which the center of the cross pointer is placed can be set to be displayed.

1. Touch [Settings] on the Launch Bar.
2. Touch [Navigation] and touch [Map Settings].
3. Touch [More Settings].
4. Touch [Map Scrolling Information].
5. Touch the preferred information item.

The following information items are available.

- [Address Book Icons]
- [Traffic Icons]
- [Destination/Waypoint Icons]
- [Show Pop-Up for POIs]
- [Latitude/Longitude Info]

6. Navigation (if equipped)



INFO:

- When the settings are turned on, placing the cross pointer on the icons will display the information in a Pop-Up window. The latitude/longitude of any point on the map where the cross pointer is located will be displayed on the bottom left corner of the map screen.
- When the [A] is displayed on the Pop-Up window, the destination can be set by touching it.
Touching [C] will display the place information screen.
On the place information screen, touch [Call] to call the selected place if the key is available.
Touch [Go Here] to set the selected location as the destination.
- Touch [<] or [>] to scroll to the next or previous page.

TRAFFIC INFORMATION ON MAP (if equipped)

Traffic information can be displayed on the map.

- ☞ "Traffic information on map" (page 6-37)

MAP MENU SCREEN

Touch [≡] while the current location map screen or a scrolled map screen is displayed to display the menu corresponding to that screen.

This menu can be used to quickly access helpful functions, such as setting a destination or searching for points of interest nearby.

Current location map screen

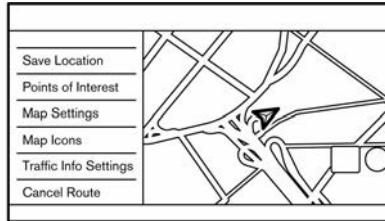

If [≡] is touched while the current location map screen is displayed, the following options are available.

- [Save Location]:
Saves the current vehicle location in the Address Book.
☞ "Storing location by moving map" (page 6-39)
- [Points of Interest]:
Searches for the Points of Interest and set as destinations.
☞ "Finding points of interest" (page 6-16)



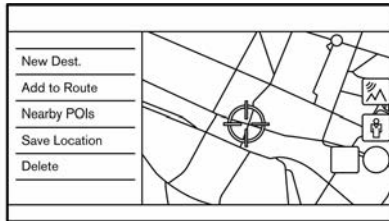

- [Map Settings]:
Map view settings can be changed.
☞ "Map settings" (page 6-8)
- [Map Icons]:
The map icons can be displayed or hidden by type.
☞ "Displaying map icons" (page 6-11)
- [Traffic Info Settings] (if equipped):
Set the various functions of the traffic information.
☞ "Traffic information settings" (page 6-38)
- [Cancel Route]:
Delete current destination and way-points.
☞ "Canceling Route" (page 6-28)

Scrolled location map screen









Example

If  is touched while the map is scrolled, the following options are available.

- [New Dest.]: Sets the map location pointed at by the cross pointer as a new destination.  "Setting point on map" (page 6-20)
- [Add to Route]: Adds the map location pointed at by the cross pointer as a destination or a waypoint to the route already set.  "Setting destination or waypoint" (page 6-32)
- [Nearby POIs]: Searches for points of interest near the current vehicle location.  "Finding points of interest" (page 6-16)
- [Save Location]: Saves the map location pointed at by the cross pointer in the Address Book.  "Storing location by moving map" (page 6-39)

- [Delete]: Deletes a saved location or destination (waypoint) when the cross pointer is placed over an icon.  "Deleting individual item on map" (page 6-44)

INFO:

- Touch  (if equipped) to display the Google Map Satellite View when connected to Wi-Fi network (if equipped). Touching  or  on the satellite view screen can change the map scale.
- Touch  (if equipped) to display Google Street View when connected to Wi-Fi network (if equipped). The view can be shifted to left and right by touching [] and [].

SETTING DESTINATION

The system can provide route guidance once a destination is set.

BASIC OPERATIONS

Displaying destination setting menu

There are several methods that can be used to set a destination. Select a preferred method for finding and setting a destination.

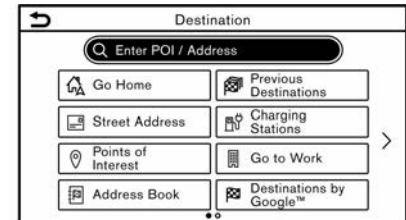















Push **<MAP>** and then touch [Destination] on the Launch Bar.

Availability of the destination setting methods varies depending on the models and specifications. Items displayed on the screen may not function depending on various conditions.

Available destination setting methods:

6. Navigation (if equipped)

Setting item	Action
[Enter POI / Address]	Searches for a destination by inputting the address or POI names.  "Free text search" (page 6-15)
[Go Home]	Searches for a route from the current location to the previously stored home location.  "Setting home or work location as destination" (page 6-16)
[Street Address]	Searches for a destination by address.  "Finding address" (page 6-16)
[Points of Interest]	Searches for a destination from various POIs.  "Finding points of interest" (page 6-16)
[Address Book]	Searches for a destination from the vehicle Address Book.  "Searching from Address Book" (page 6-18)
[Previous Destinations]	Searches for the destination from the previous destinations and a previous start point.  "Searching from previous destinations" (page 6-18)
[Charging Stations]	Sets a destination from charging station list.  "Finding charging station" (page 6-19)
[Go to Work]	Searches for a route from the current location to the previously stored work location.  "Setting home or work location as destination" (page 6-16)
[Phone Number]	Searches for a point of interest by a phone number.  "Setting by phone number" (page 6-19)
[Destinations by Google™]	Sets a place searched by Google as a destination.  "Setting destinations by Google" (page 6-20)
[Saved Routes]	Sets a route from the saved route data.  "Setting from saved routes" (page 6-20)
[By Map]	Searches for a destination by map.  "Setting point on map" (page 6-20)
[Latitude/Longitude]	Sets a destination from latitude and longitude.  "Setting with latitude/longitude" (page 6-21)
[Door-to-Door Navigation]	Turns on/off Door-to-Door Navigation.  "Using Door-to-Door Navigation" (page 6-21)



INFO:

- After setting a destination, the location of the destination can be adjusted and the location can be stored in the Address Book, etc.
 "Options before starting the route guidance" (page 6-22)
- The destination can be deleted.
 "Canceling Route" (page 6-28)

FREE TEXT SEARCH

A location or facility can be searched by inputting POI name or Address.

1. Push **<MAP>**.
2. Touch [Destination] on the Launch Bar.
3. Touch [Enter POI / Address].
4. Enter the POI name or address. After finishing the entry, touch [List]. The search results are displayed in list.



INFO:

- To display the search results of POI names, touch .
To display the search results of addresses, touch .
 - While entering the facility name, the expected selections are displayed on the input screen. The list can be scrolled by touching [**<**] or [**>**].
5. The following optional functions are available by touching [Option] on the list.
 - [Online] (if equipped):
When this item is turned on, the system searches for POIs using on-line information if connected to Wi-Fi network (if equipped).
 - [Along Route]:
If a route is already set, the system displays only the facilities located along the route.
 - [Near Destination]:
If a route is already set, the system displays only the facilities located near the destination.
 - [Select a City]:
Narrow down the list by specifying the city.
 - [Near Current Location]:
The system displays only the facilities located near the current location.
 - [Sort]:
The list can be sorted by touching [By Distance] or [By Name].
6. Return to the search result screen and touch the preferred destination from the list.
 7. The entire route is displayed. Touch [Start] to start route guidance.

Online Search (if equipped)

When your vehicle is connected to a Wi-Fi network (if equipped), Online Search can search the location considering the latest information via the online network.

1. Push **<MAP>**.
2. Touch [Destination] on the Launch Bar.
3. Touch [Enter POI / Address].
4. Enter the POI name or address. After finishing the entry, touch [List]. The search results are displayed in list.
5. Touch [Option].
6. Touch [Online]. The indicator will illuminate.
7. The system connects to the on-line network.
8. The updated search result is displayed.



INFO:

You can also use the Online Search when a Door-to-Door Navigation (if equipped) enabled smartphone is connected to the vehicle. It may be charged separately when Door-to-Door Navigation is used.

"Using Door-to-Door Navigation"

6. Navigation (if equipped)

(page 6-21)

SETTING HOME OR WORK LOCATION AS DESTINATION

The home or work location can be quickly set as the destination if the location is stored in advance.

1. Push **<MAP>**.
2. Touch [Destination] on the Launch Bar.
3. Touch [Go Home] or [Go to Work].



INFO:

If the home or work location is not stored yet, the system will display a message asking if you wish to store a home or work location. Touch [Yes] to store the home or working place location.

"Storing home or work location"
(page 6-38)

4. The entire route is displayed. Touch [Start] to start route guidance.



INFO:

[Go Home] can also be accessed from the Launch Bar.

FINDING ADDRESS

The system supports searching for a destination by address.

1. Push **<MAP>**.
2. Touch [Destination] on the Launch Bar.
3. Touch [Street Address].

Street Address	
Country	XXXX
Postcode or City	
Street	
House Number	
Intersection	

OK

4. Input the street address.
 - Touch [Country] to select the country name.
 - Touch [Postcode or City] to enter a postal code or city name. If the city name is not available, touch [All Cities].
 - Touch [Street] to enter the street name.
After finishing the entry, touch [List].
A list of streets is displayed.
 - Touch [House Number] to enter the house number. If the house number is not available, touch [No House #].
 - Touch [Intersection] to enter the intersection.



INFO:

- While entering the data, the expected words are displayed on the input screen. The list can be scrolled by touching [**<**] or [**>**].
 - Touch [Last 5 Cities] to display the last 5 cities set as destinations.
5. After entering the address, touch [OK].
 6. The entire route is displayed. Touch [Start] to start route guidance.

FINDING POINTS OF INTEREST

This allows you to find a facility by name or by category. Specify the region and city of the destination to find it more quickly.



NOTE:

Locations and business hours of facilities are subject to change, which may not be reflected in the map data. Double-check this information before you go to an emergency facility to ensure that you can receive the proper support. Otherwise, you may not receive emergency help when you arrive at the destination.

A confirmation message also appears on the navigation screen. Follow the displayed instructions and check the items required.

Searching for a Points of Interest by name

1. Push **<MAP>**.
2. Touch [POI] on the Launch Bar.
3. Touch [By Name]. A character input screen is displayed.

INFO:

- When a route is set, touch [Destination] on the Launch Bar and select [Points of Interest] to select [By Name].
4. Enter the name of the destination facility. After finishing the entry, touch [List]. A list screen is displayed.

INFO:

- While entering the facility name, the expected selections are displayed on the input screen. The list can be scrolled by touching [**<**] or [**>**].
 - To search for a POI with two or more words, touch [Space] to enter a space between each word.
 - The latest information can be obtained by touching [Online] (if equipped), using an available Wi-Fi network (if equipped).
 "Online Search" (page 6-15)
5. The following optional functions are available by touching [Option] on the list.

- [Along Route]:
If a route is already set, the system displays only the facilities located along the route.
 - [Near Destination]:
When a route is set, up to 100 POIs are listed in the order of distance from the destination.
 - [Select a City]:
Narrow down the list by specifying the city.
 - [Near Current Location]:
When a route is set, up to 100 POIs are listed in the order of distance from the current location.
 - [Sort]:
The list can be sorted by [By Distance] or [By Name].
6. Touch the preferred destination facility from the list.
 7. The entire route is displayed. Touch [Start] to start route guidance.

INFO:



- After setting a destination, the location of the destination can be adjusted and the location can be saved in the saved location, etc.
-  "Options before starting the route guidance" (page 6-22)

Searching Points of Interest by category

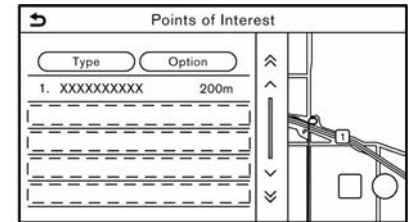
1. Push **<MAP>**.
2. Touch [POI] on the Launch Bar.
3. Touch [All Categories].
4. Touch the preferred category. The facility list is displayed.



INFO:

- If the selected category has subcategories, a list will be displayed. Select the preferred subcategory. The POI categories to be used frequently can be registered in the Points of Interest menu.
 "Customizing POIs" (page 6-18)
5. Touch [Option] to narrow down, sort or refresh the list.
 "Searching for a Points of Interest by name" (page 6-17)
- The latest information can be obtained by touching [Online] (if equipped), using an available Wi-Fi network (if equipped).

6. Navigation (if equipped)

 "Online Search" (page 6-15)

6. Touch the preferred destination facility from the list.
7. The entire route is displayed. Touch [Start] to start route guidance.

Customizing POIs

The POI categories displayed in the Points of Interest menu can be customized.

1. Push **<MAP>**.
2. Touch [POI] on the Launch Bar.
3. Touch [Customise POIs].
4. Touch the item number to be modified.
5. Touch the preferred POI category. The selected POI category is displayed in the Points of Interest menu.

SEARCHING FROM ADDRESS BOOK

Locations frequently visited can be stored in the Address Book and reused to set destinations.

 "Storing location" (page 6-38)

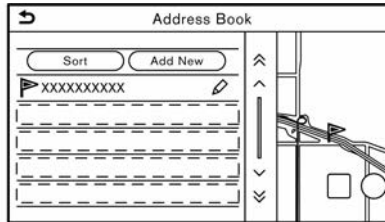

1. Push **<MAP>**.
2. Touch [Destination] on the Launch Bar.
3. Touch [Address Book].



4. Touch the preferred location from the list.



INFO:

- Touch [Add New] to add a new location.
- Touch  to edit the saved route.  "Editing stored location" (page 6-41)
- Selecting [Sort] displays a list of various sort functions.
 - [Sort by Number]:
The Address Book entries are displayed in ascending numerical order.
 - [Sort by Name]:
The Address Book entries are displayed in alphabetic order.
 - [Sort by Icon]:

By selecting a particular icon, a list that contains only the Address Book entries associated with that icon is displayed.

– [Sort by Group]:

By selecting a particular group (family, friends, leisure, etc.), the selected group is displayed at the top of the list.

5. The entire route is displayed. Touch [Start] to start route guidance.

SEARCHING FROM PREVIOUS DESTINATIONS

A previous destination or a previous start point can be set as the destination.

Up to 100 previous destinations will be automatically stored. If the number of previous destinations exceeds 100, the oldest one is automatically deleted and the new destination is added.

1. Push **<MAP>**.
2. Touch [Destination] on the Launch Bar.
3. Touch [Previous Destinations]. A list screen is displayed.
4. Touch the previous destination or a previous start point from the list.
5. The entire route is displayed. Touch [Start] to start route guidance.

FINDING CHARGING STATION

The system supports searching for charging stations.

1. Push **<MAP>**.
2. Touch [Destination] on the Launch Bar.
3. Touch [Charging Stations]. A list of charging stations is displayed.

INFO:

- Touch [Filter] or [Option] to narrow down, sort or refresh the list.
 - Touch [Filter]:
 - [Quick Charging Station Only]: Shows charging stations with quick charger.
 - [Show Available Charging Stations]: Shows charging stations that are available.
 - [Free Only]: Shows charging stations that are free of charge.
 - [Plug Type]: Select plug type and the usable charging stations are displayed.
 - [Select Payment Type]: Select payment method and the usable charging stations are displayed.

- [Available within 30 minutes]: Shows charging stations that are available within 30 minutes drive from the current location.
 - Touch [Option]:
 - [Online] (if equipped): Obtains the latest information online when this item is turned on while connected to Wi-Fi network (if equipped).
 -  "Wi-Fi setting" (page 1-17)
 - [Along Route]: Displays a list of charging stations located along the route to destination.
 - [Near Destination]: Displays a list of charging stations that are near the destination, when a destination has been set.
 - [Select a City]: Displays a list of charging stations when a city name is entered.
 - [Near Current Location]: Displays a list of charging stations that are near the current vehicle location.
4. Touch the preferred charging station from the list.
 5. The entire route is displayed. Touch [Start] to start route guidance.

NOTE:

Equipment that is displayed on the charging station information screen is not necessarily compatible with your vehicle. Be sure to check whether the equipment can be used with your vehicle beforehand.

INFO:

Charging station search menus can also be accessed from [Charging Stations] in the EV Info menu.

 "EV Info menu screen" (page 2-2)

SETTING BY PHONE NUMBER (if equipped)

If the phone number of a facility is registered in the map data, it is possible to search for a facility by entering the phone number.

INFO:

- If the area code of the specified phone number does not exist in the map data, the system cannot search for the location.
 - Only the locations included in the database in the map data can be searched for by phone number. Residential phone numbers cannot be used to search for a location.
1. Push **<MAP>**.

6. Navigation (if equipped)

2. Touch [Destination] on the Launch Bar.
3. Touch [Phone Number]. The phone number input screen is displayed.
4. Enter the phone number including the area code. After finishing entry, touch [OK].
5. The entire route is displayed. Touch [Start] to start route guidance.



INFO:

If there are more than one location registered for the phone number, a list screen is displayed. Touch an item on the list to select a preferred location.

SETTING DESTINATIONS BY GOOGLE (if equipped)

It is possible to set a destination by downloading the place information searched on Google by entering keywords.

1. Push **<MAP>**.
2. Touch [Destination] on the Launch Bar.
3. Touch [Destinations by Google™]. A list of search conditions is displayed.
4. Enter the keyword and then touch [List]. A list of the searched items downloaded from Google is displayed.
5. Touch the preferred destination in the list.

6. The entire route is displayed. Touch [Start] to start route guidance.



INFO:

The system downloads the information searched by Google via the TCU (Telematics Control Unit). Use of NissanConnect Services features is dependent upon a valid subscription and the telematics device being in operative condition, as well as cellular connectivity, navigation map data and GNSS satellite signal reception being available.

SETTING FROM SAVED ROUTES

It is possible to select a preferred route from the saved routes.

1. Push **<MAP>**.
2. Touch [Destination] on the Launch Bar.
3. Touch [Saved Routes]. A list screen is displayed.
4. Touch the preferred route from the list.

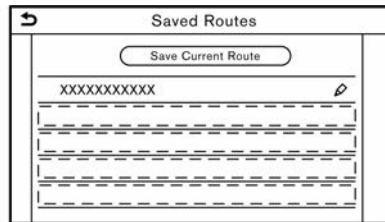

5. The entire route is displayed. Touch [Start] to start route guidance.



INFO:

- Touch [✎] to edit the saved route.
✎ "Editing stored route" (page 6-43)
- The saved route only includes locations (destination and waypoints) and route calculation conditions, not the route itself. Therefore, when the destination is set using a saved route, a different route may be suggested if the current vehicle location is different from the one when the route was saved.
- To save the current route, touch [Save Current Route]. A route can be saved only when it includes one or more waypoints.
✎ "Storing route" (page 6-39)

SETTING POINT ON MAP

It is possible to set a location scrolled to on the map as the destination and have the system calculate a route.

1. Push **<MAP>**.
2. Touch [Destination] on the Launch Bar.
3. Touch [By Map].
4. Scroll the map, place the cross pointer over the preferred location, and touch [OK].

INFO:

The point on the highlighted road where the center of the cross pointer is located can be set as a destination.

5. The entire route is displayed. Touch [Start] to start route guidance.

Other settings

1. Scroll the map, place the cross pointer over the preferred location, and touch .
2. Touch [New Dest.].
3. The entire route is displayed. Touch [Start] to start route guidance.

SETTING WITH LATITUDE/LONGITUDE

A destination can be set by specifying the latitude and longitude of the location.

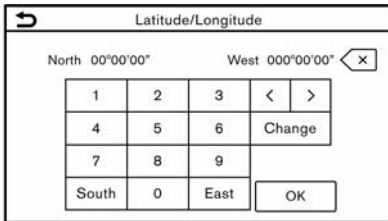

Latitude/Longitude					
North 00°00'00"			West 000°00'00" 		
1	2	3	<	>	
4	5	6	Change		
7	8	9			
South	0	East	OK		

1. Push <MAP>.
2. Touch [Destination] on the Launch Bar.
3. Touch [Latitude/Longitude]. A number input screen is displayed.

4. Enter latitude and longitude of the location to be set as a destination and touch [OK].
5. The location is displayed at the center of the map. Touch [OK].
6. The entire route is displayed. Touch [Start] to start route guidance.

INFO:

- To switch between entering latitude and longitude, move the cursor by touching [<] and [>].
- Touch [Change] to switch the format of the latitude and longitude.
- Touch [West] or [East] to set the appropriate longitude.
- Touch [North] or [South] to set the appropriate latitude.
- A message will appear if the selected location is not included in the map area.

USING DOOR-TO-DOOR NAVIGATION (if equipped)

The destination can be set using a companion smartphone application and transferred to the vehicle. For detailed information, see the manual in the Door to Door Navigation app.

INFO:

- The Door to Door Navigation app can be downloaded from the iTunes App Store or Google Play.
 - A user account is required before logging-in at the first use of the application.
1. Push <MAP>.
 2. Touch [Destination] on the Launch Bar.
 3. Touch [Door-to-Door Navigation] and check that [Sync with Door-to-Door Navi] is turned on.

INFO:

[Sync with Door-to-Door Navi] can also be turned on from the navigation settings screen.

 "Navigation settings" (page 6-45)

4. Activate the Door to Door Navigation app on your smartphone.
5. Select a destination using the Door to Door Navigation app on your smartphone.

Transfer the destination information from the smartphone to the vehicle.

INFO:

This vehicle incorporates a communication device that is called a TCU (Telematics Control Unit).

 "NissanConnect Services"

6. Navigation (if equipped)

(page 5-6)

6. A confirmation screen will be displayed. Touch [Go Here] and the position of the transferred location is displayed in the preview on the touch screen display.



INFO:

- Touch [Store] to register the destination in the Address Book.
 - Touch [Ignore] to cancel the transfer of the destination.
7. The entire route is displayed. Touch [Start] to start route guidance.

OPTIONS BEFORE STARTING THE ROUTE GUIDANCE

Before starting the route guidance, select menus for route details to modify the route, preview the turn list, or store the route.

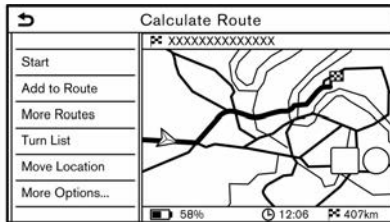

- [Start]: Starts route guidance to the selected destination.

- [Add to Route]: Adds a location to the route previously set.
- [More Routes]: Suggests alternative routes.
 - [Fastest] Selects a route that is fastest in time.
 - [ECO] Selects a route for the energy saving.
 - [Shortest] Selects a route that is the shortest in distance.
- [Turn List]: Displays a detailed turn list. The map can be displayed and the turn can be avoided by touching a turning point.
 - ☞ "Displaying Turn List" (page 6-28)
- [Move Location]: Displays a map screen and allows the location of the destination to be adjusted.
- [More Options...]:
 - [Place Info] Displays detailed information of the destination. Touch [Go Here] to set the destination. Touch [Call] (when available) to make a phone call to the facility set as a destination.
 - [Save Location] Saves the location to the Address

Book.

- [Save Route] Store the route for later use.



INFO:

- Battery power information is displayed on the screen after [More Routes] is touched. The remaining battery power estimation function cannot be used to confirm condition changes that arise after driving starts. Utilize the function as a reference when selecting driving routes.
- After starting to drive, refer to the driving range on the meter and perform battery charging allowing for some leeway.
- In the following instances, the actual battery power may differ from the remaining battery power estimation.
 - Frequent repetition of sudden acceleration and sudden braking
 - Change of air conditioner operating conditions
 - Change of traffic conditions and driving routes that differ from the one used for the estimation
 - Strong wind, cold, and snowy weather conditions
 - Tires that do not comply with specifications, low air pressure tires, worn tires, studless tires, and others

ROUTE GUIDANCE

ABOUT ROUTE GUIDANCE

After setting the route, select [Start] to start the route guidance.

During route guidance, the system navigates you through the guide points using visual and voice guidance.



WARNING

- **The navigation system's visual and voice guidance is for reference purposes only. The contents of the guidance may be inappropriate depending on the situation.**
- **Follow all traffic regulations when driving along the suggested route (e.g., one-way traffic).**
 "Route guidance" (page 6-52)

Voice guidance during route guidance

Basics of voice guidance:

Voice guidance announces which direction to turn when approaching an intersection for which a turn is necessary.



INFO:

- There may be some cases in which voice guidance and actual road conditions do not correspond. This may

occur because of discrepancies between the actual road and the information on the map data, or may also be due to the vehicle speed.

- In case voice guidance does not correspond to the actual road conditions, follow the information obtained from traffic signs or notices on the road.
- When approaching a guide point (intersection or corner) or destination/waypoint during route guidance, voice guidance announces the remaining distance and/or turning direction. Push and hold **<MAP>** to repeat voice guidance.

Route guidance screens

Various guidance screens are displayed on the touch screen display during route guidance.

The settings of the guidance screens can be changed.

"Map settings" (page 6-8)

- Decreased capacity of the Li-ion battery
- Installation of equipment that does not comply with specifications (carriers and others)
- Touch [1 Type] to display alternative routes calculated with a route search condition selected on the [Basic Route Type] setting screen.
 "Route Preference" (page 6-29)
Touch [3 Types] to display alternative routes calculated in all three route search conditions ([Fastest], [ECO] and [Shortest]).

6. Navigation (if equipped)

Route guidance on map screen:

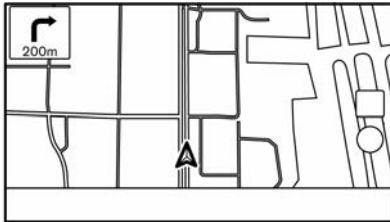

When route guidance starts, the small turn arrow and the distance to the next guide point are displayed in the upper left corner of the map screen. This arrow indicates the turning direction at the next guide point (corner or intersection). When approaching a guide point, enlarged intersection view is displayed. Also, there may be cases where next street names are announced.

Enlarged intersection view:

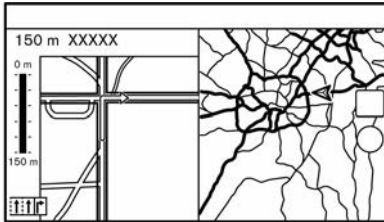

When approaching a guide point, the system automatically changes to the split screen view and shows an enlarged view of the intersection on the left side of the screen. To switch to the full map screen while the enlarged intersection view is displayed, push **<MAP>**. The distance to the guide point and the name of the next street to drive on are displayed at the top of the screen.

Junction guidance:

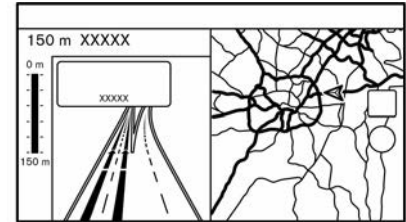

While driving on a motorway, when the vehicle approaches a junction, the system automatically switches to the split screen view and displays an enlarged view of the junction on the left side of the screen. After the vehicle passes the junction, the system automatically returns to the full screen mode. To switch to the full map screen while the enlarged junction view is displayed, push **<MAP>**.

6. Navigation (if equipped)

Turn list:

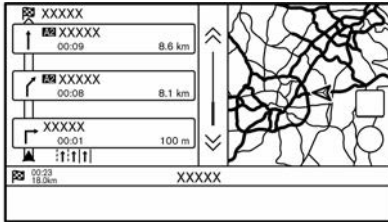

When [Turn List] in the map settings menu is turned on, a turn list can be displayed on the left side of the screen.

☞ "Map settings" (page 6-8)

To switch to the full map screen, push **<MAP>**.

The left screen automatically switches to an enlarged view of the intersection when approaching a guide point.

With [Auto. Show Turn List on M-way] turned on, the turn list will appear automatically when driving on motorways.

☞ "Map settings" (page 6-8)

Selecting a waypoint from the exit information list:

When exit information is displayed on the turn list, a waypoint to a facility located near the motorway exit can be set as a waypoint. The facility categories that are not shown with an icon on the turn list cannot be selected.

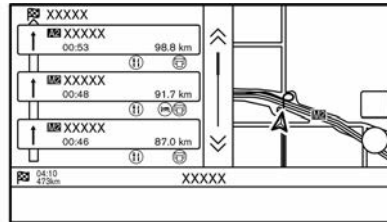

1. Touch the exit where the exit information icon is displayed. The category list screen is displayed.
2. Touch the POI category. A list of facilities located near the motorway exit is displayed.
3. Touch the preferred facility for the destination or waypoint.
4. The destination or waypoint is set, and the route search is performed.
☞ "Options before starting the route guidance" (page 6-22)
5. Touch [Start] to start the route guidance.

ROUTE MENU



WARNING

Always stop the vehicle in a safe location before modifying the route conditions. Modifying the route conditions while driving may cause an accident.

During route guidance, the route conditions can be modified and the route



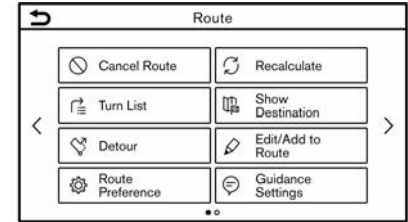



information can be confirmed. Set route conditions according to your personal preference.



Push **<MAP>** when a destination is set, and then touch [Route] on the Launch Bar. The route menu screen is displayed.

6. Navigation (if equipped)

Available settings

Menu item		Result
[Cancel Route]		<p>Cancels the current route guidance.</p> <p> "Canceling Route" (page 6-28)</p>
[Turn List]		<p>Displays the details of the suggested route.</p> <p> "Displaying Turn List" (page 6-28)</p>
[Detour]		<p>A detour of a specified distance can be calculated.</p> <p> "Setting detour route" (page 6-28)</p>
[Route Preference]		<p>Set the route search conditions.</p> <p> "Route Preference" (page 6-29)</p>
[Recalculate]		<p>Manually search for the route again after changing the search conditions, etc. and have the system calculate a route.</p> <p> "Recalculating route" (page 6-32)</p>
[Show Destination]	[Move Location]	<p>Displays a map screen and allows the location of the destination to be adjusted.</p>
	[Nearby POIs]	<p>Search for points of interest near the destination, such as restaurants, charging stations, etc. The location can be set as a destination or a waypoint.</p>
	[Save Location]	<p>Save the destination in the Address Book.</p>
[Edit/Add to Route]		<p>A destination or waypoint can be edited/added to a route that has already been set.</p> <p> "Editing route" (page 6-32)</p>
[Guidance Settings]		<p>Various guidance settings can be customized.</p> <p> "Guidance settings" (page 6-35)</p>
[Save Route]		<p>The current route (a destination and waypoints) can be saved. A maximum of 10 routes can be saved. The saved routes can easily be recalled for future use. Saved route includes only the location information, not the route itself. Route may vary depending on the traffic information (if equipped) or other conditions.</p>
[Map Scroll]		<p>Displays the current map screen which can be scrolled to confirm the location of the destination, waypoints, route, etc.</p>

6. Navigation (if equipped)

[Simulation]

Simulates the route guidance. This function provides a detailed image of the route with voice guidance.

The following operations are available:

[||]: Pauses the simulation.

[▶]: Resumes the simulation.

[■]: Ends the simulation.

: Increases the play speed.

: Decrease the play speed.

6. Navigation (if equipped)

CANCELING ROUTE

It is possible to delete a destination and all waypoints that have already been set.

1. Push **<MAP>** and then touch [Route] on the Launch Bar.
2. Touch [Cancel Route].
3. A confirmation message is displayed. Touch [Yes] to delete the currently set destinations and waypoints.



INFO:

- Touching [Cancel] on the Launch Bar can also delete the destination and waypoints.
- The deleted destination and waypoints cannot be reactivated.

DISPLAYING TURN LIST

Displays the details of the suggested route.

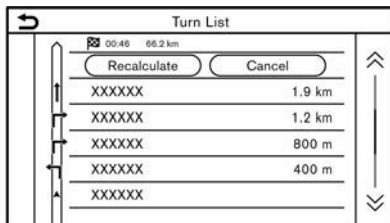

1. Push **<MAP>** and then touch [Route] on the Launch Bar.
2. Touch [Turn List].

Setting avoid road

The detour to avoid a road is available by touching the road name on the Turn List display.

1. Touch the road on the list you prefer to avoid. The position of the selected intersection is displayed.
2. Touch [Avoid This Road].



INFO:

- Touching [Show Map] can confirm the entire route.
3. Display returns to the turn list. Touch [Recalculate]. The route is recalculated. Touch [Cancel] to cancel the avoid setting.

SETTING DETOUR ROUTE

To detour from the suggested route, a detour distance can be specified.

1. Push **<MAP>** and then touch [Route] on the Launch Bar.
2. Touch [Detour].
3. Touch a detour distance.

Available setting items:

- 200 m/400 yd (1/4 mi)
- 500 m/800 yd (1/2 mi)
- 1.0 km (1.0 mi)
- 5.0 km (3.0 mi)

- 10.0 km (5.0 mi)

After calculating the detour, the system displays the detour route on the map.



INFO:

- The detour setting can be canceled by touching [Cancel Detour].
- When the vehicle has deviated from the suggested route, [Detour] cannot be selected.
- If the system cannot calculate a detour with the specified conditions, the previous suggested route is displayed.
- If the vehicle is traveling very fast, the detour route may start from a location that the vehicle has already passed.

ROUTE PREFERENCE

It is possible to set the conditions of the route search.

1. Touch [Settings] on the Launch Bar.
2. Touch [Navigation] and touch [Route Preference].
3. Touch the item you would like to set.

Available items may vary depending on models and specifications.

Setting Item		Action	
[Basic Route Type]	[Fastest Route]	Prioritizes the use of fastest route.	
	[Energy-Saving]	Prioritizes a route which uses less energy.	
	[Shortest Distance]	Prioritizes the shortest route. The route may not be the shortest because the system prioritizes roads that are easy to drive on for safety reasons.	
[Other Routing Choices]	[Minimise Motorways]	Minimizes the use of motorways.	
	[Minimise Toll Roads]	Minimizes the use of toll roads.	
	[Time Restricted Roads]	[Use Restriction Info]	Calculates route taking time restriction information into consideration.
		[Do Not Use Restriction Info]	Calculates route without taking time restriction information into consideration.
		[Avoid]	Calculates route avoiding the use of time restricted roads.
	[Seasonal Restricted Roads]	[Use Restriction Info]	Calculates route taking seasonal restriction information into consideration.
		[Do Not Use Restriction Info]	Calculates route without taking seasonal restriction information into consideration.
		[Avoid]	Calculates route avoiding the use of seasonal restricted roads.
	[Use Traffic Information]	[Auto]	Calculates the route automatically taking traffic information into consideration.
		[Accept]	If a traffic jam or incident occurs, a confirmation screen will appear before calculation.

6. Navigation (if equipped)

	[OFF]	Calculates the route without taking traffic information into consideration.
	[Use Avoid Area Settings]	When enabled, the system avoids the previously defined avoid areas.
	[Use Ferries]	Includes the use of ferries.
	[Use Car-Carrying Trains]	Includes the use of car-carrying trains.
	[Use Unpaved Roads]	Includes the use of unpaved roads.
	[Use Learned Routes]	Uses the roads that are most frequently traveled with the help of self-learning technology.
[Customise More Routes]	[3 Types]	Calculates 3 types of route when confirming other routes.
	[1 Type]	Calculates routes with a route search condition selected on the [Basic Route Type] setting screen.  "Route Preference" (page 6-29)
[Estimated Time]	[Destination]	Displays the estimated time of arrival or remaining time to the destination during route guidance.
	[Waypoint]	Displays the estimated time of arrival or remaining time to the waypoint during the route guidance.
[Time Shown on Map]	[ETA]	Displays the estimated time of arrival.
	[Remaining]	Displays the remaining time to arrival.



INFO:

- [Route Preference] can also be accessed from route menu screen.
- If the vehicle greatly deviates from the suggested route, the system calculates a new route.
- Traffic jam information displayed on the map screen is not statistical traffic information.
- If [Do Not Use Restriction Info] is selected for [Time Restricted Roads] setting, the system calculates a route without any consideration of the regulations concerning the time or day of the week. Therefore, the suggested route may include a road subject to traffic regulations concerning the time or day of the week. When driving along the route, always follow all traffic regulations regardless of whether [Time Restricted Roads] is set to be considered or not.
- In the area where traffic information is not broadcast, [Use Traffic Information] setting is disabled.
- The system calculates to reduce the time required for the entire route from the start to the destination. If there are no appropriate routes, the system may lead to a route where a traffic jam occurs instead of leading to a detour.
- The system may not lead to a detour if the traffic closure or a traffic jam occurs far from the present location.

6. Navigation (if equipped)

RECALCULATING ROUTE

A route can be manually searched again after changing the search conditions, etc.

1. Push **<MAP>** and then touch [Route] on the Launch Bar.
2. Touch [Recalculate]. A message is displayed and the route is recalculated.
3. Touch [Start] or conduct other operations as necessary.
☞ "Options before starting the route guidance" (page 6-22)



INFO:

- When a waypoint has been set on the route, the system will search for only one route, even if route recalculation is performed.
- When the vehicle deviates from the suggested route, the route from the current location to the destination is automatically searched again by the Auto Reroute function.

EDITING ROUTE

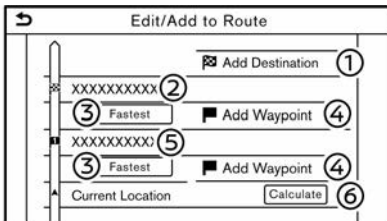

1. Push **<MAP>** and then touch [Route] on the Launch Bar.
2. Touch [Edit/Add to Route].
3. Edit the following settings and touch [Calculate].

Available settings

- ① [Add Destination]:
Touch to add a new destination.
- ② Current destination:
Touch to edit or delete the destination.
☞ "Editing/deleting destination or waypoint" (page 6-33)
- ③ Criteria for calculating a route to the destination/waypoint:
Touch to change the conditions for route calculation.
☞ "Changing route calculation conditions" (page 6-33)
- ④ [Add Waypoint]:
Touch to add a waypoint.
☞ "Setting destination or waypoint"

(page 6-32)

- ⑤ Current waypoint:
Touch to edit or delete the waypoint.
☞ "Editing/deleting destination or waypoint" (page 6-33)
- ⑥ [Calculate]:
After editing the route, touch to recalculate a route with new conditions.

Setting destination or waypoint

A destination or waypoint can be added to a route that has already been set. Up to 20 waypoints besides one destination can be set.

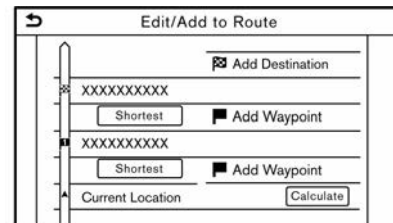

1. Push **<MAP>** and then touch [Route] on the Launch Bar.
2. Touch [Edit/Add to Route].



3. Touch [Add Destination] or [Add Waypoint].

INFO:

If [Add Destination] is selected, the current destination changes to a waypoint.

4. Set a destination or waypoint. The method of searching for a waypoint is the same as the one for a destination.
 "Setting destination" (page 6-13)
5. Touch [Add to Route] to add the location to the route.
6. The route information with the selected location added to the route is displayed. Adjust the route calculation conditions as necessary.
 "Changing route calculation conditions" (page 6-33)
7. Touch [Calculate] to confirm the route change. The route will be recalculated.

INFO:

- The prior route will be deleted automatically.
- Destinations or waypoints can also be added from the Map Menu.
 "Scrolled location map screen" (page 6-13)

Editing/deleting destination or waypoint

A destination or waypoint that has already been set can be modified or deleted.

1. Push **<MAP>** and then touch [Route] on the Launch Bar.
2. Touch [Edit/Add to Route].
3. Touch a destination or waypoint that is already set.

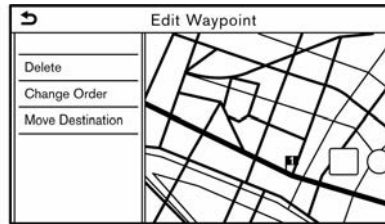

4. Touch to edit the following settings:

Available settings

- [Delete]:
A selected destination or waypoint that has already been set can be deleted.
- [Change Order]:
The order of a destination and waypoints that are already set can be changed.
- [Move Destination]:
The location of the destination or waypoint can be adjusted by moving the cross pointer across the

map on the touch screen display.

5. Touch [Calculate] to apply the change.

INFO:

If the destination is deleted, the route guidance will be canceled.

Changing route calculation conditions

Each section of the route between waypoints can have different route calculation conditions.

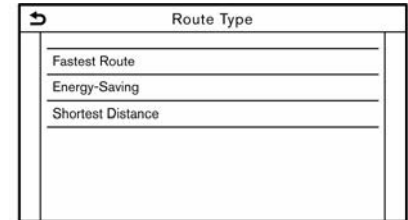

1. Push **<MAP>** and then touch [Route] on the Launch Bar.
2. Touch [Edit/Add to Route].
3. Touch the route condition shown on the preferred section of the route to the destination or waypoint.
4. Touch the preferred condition.
 "Route Preference" (page 6-29)
The conditions are changed and the display returns to the edit route screen.

6. Navigation (if equipped)

5. Touch [Calculate] to apply the change.



INFO:

The recalculated route may not be the shortest route because the system prioritizes roads that are easy to drive on for safety reasons.

Changing order of destination and waypoints and waypoints

The order of a destination and waypoints that are already set can be changed.

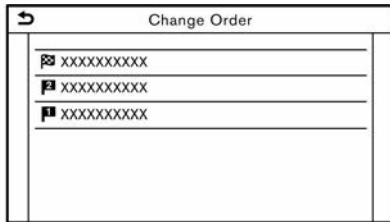

1. Push **<MAP>** and then touch [Route] on the Launch Bar.
2. Touch [Edit/Add to Route].
3. Touch a destination or waypoint that is already set.
4. Touch [Change Order].
5. Touch a preferred destination or waypoint to replace the previously selected destination or waypoint.
6. Touch [Calculate] to apply the change.

GUIDANCE SETTINGS

Various settings are available to customize the guidance information provided by the system.



1. Touch [Settings] on the Launch Bar.
2. Touch [Navigation] and touch [Guidance Settings].
3. Touch an item you would like to set.

Available items may vary depending on models and specifications.

Setting item	Action
[Guidance Volume]	Adjusts the volume level of voice guidance.
[Guidance Voice]	Activates or deactivates voice guidance.
[Traffic Announcement]	Activates or deactivates the traffic announcement. When this item is activated, the system provides an announcement of traffic information or events on the route. The indicator illuminates if traffic announcement is activated.
[Toll Booth Guide]	Activates or deactivates the function to notify that the vehicle is approaching a toll booth.



INFO:

- [Guidance Settings] can also be accessed from the route menu screen.
 "Route menu" (page 6-25)
- Even when [Traffic Announcement] (if equipped) is turned on, the traffic information is not announced in the area where traffic information is not broadcast.
- The guidance volume can also be adjusted by turning **<VOL/  >** or pushing **<  >** on the steering wheel while voice guidance is being announced.

6. Navigation (if equipped)

VIEWING TRAFFIC INFORMATION (if equipped)

Two types of traffic information are available on this system, RDS-TMC (Radio Data System - Traffic Message Channel) and Premium Traffic information.

To activate RDS-TMC, set [Use Premium Traffic] off.

To activate Premium Traffic information, set [Use Premium Traffic] on.

 "Traffic information settings"
(page 6-38)

RDS-TMC FEATURE

The navigation system receives traffic information from the best available sources and enables the RDS-TMC to broadcast this information for the best possible guidance. The RDS-TMC broadcast is fed by a dedicated FM tuner so that you can still listen to the radio while Traffic Information is being broadcast. Traffic information can be displayed only in areas where RDS-TMC is broadcast. Traffic information is not available in some areas.

PREMIUM TRAFFIC INFORMATION

Real-time traffic information can also be obtained from Premium Traffic information with more street coverage.

The types of event displayed on the screen are the same as RDS-TMC Information.

Premium Traffic information is available by turning [Use Premium Traffic] on and connecting a Wi-Fi device (if equipped) or connecting a smartphone through Wi-Fi.

 "Traffic information settings"
(page 6-38)



INFO:

You can also use Premium Traffic information when a Door-to-Door Navigation (if equipped) enabled smartphone is connected to the vehicle.

 "Using Door-to-Door Navigation"
(page 6-21)

VIEWING AVAILABLE TRAFFIC INFORMATION

Viewing traffic events from list

1. Push **<MENU>** and then touch [Info] on the Launch Bar.
2. Touch [Traffic Information] or [Premium Traffic]. A list of available types of information is displayed.

Available items	Function
[Show Traffic on the Route]	Displays a list of traffic information found on the route from the current vehicle location to the destination. Available only when a route is set.
[Nearby Traffic Info]	Displays a list of available traffic information around the current vehicle location.



INFO:

- [Traffic Information] or [Premium Traffic] is available only when the traffic information is received.
3. Touch the preferred item. A list of available events are displayed.

6. Navigation (if equipped)

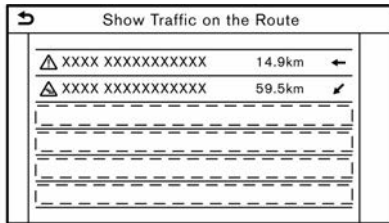

4. Touch an event from the list to check the detailed information and the map. Touch [Avoid] to search for an alternate route.

Displaying urgent traffic information

When an urgent event is found around the current vehicle location, a message pops up automatically on the touch screen display with a voice announcement.

The message includes the icon, event type, event information and the direct distance from the current location to the event.



INFO:

- When there are multiple urgent events, the event with the shortest direct distance from the current location is displayed.
- If the urgent event is on the recommended route, and if a detour is found, the detour route notification screen is displayed when the vehicle ap-

proaches the detour point.

Traffic information on map

Traffic information is displayed on both 2D and 3D map screens.

Screen information

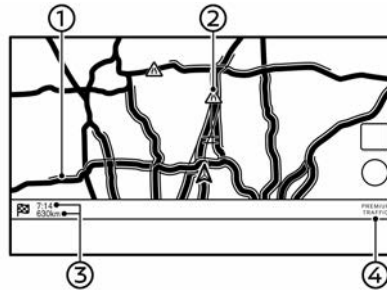

Example

- ① Road conditions:

Free Flow	Green
Slow traffic	Yellow
Heavy traffic	Red
Road closed and section affected by serious traffic event	Orange and white stripes
Queuing traffic	Orange (Premium Traffic information only)

- ② Traffic information icon:

If a route is not already set, all of the traffic information icons on the map

screen are displayed in gray. When a route is already set, the icons on the route are displayed in color, and the icons outside the route are displayed in gray.

	Stationary traffic
	Slow traffic
	Free flowing traffic
	Stretch is closed
	Accident
	Roadworks
	Narrow lanes
	All other events

- ③ Remaining distance and time:

Remaining distance and time calculated with consideration of traffic information on route.

Whether to display the remaining time to the destination or estimated arrival time at the destination can be selected.

"Route Preference" (page 6-29)

- ④ Traffic indicator:

TMC

Displayed when there is available RDS-TMC received.

PREMIUM TRAFFIC

Displayed when there is available Premium Traffic information received.

6. Navigation (if equipped)



INFO:

Traffic icons are displayed in the scale level of 25m (1/64 miles) - 12.5 km (7.5 miles) range. Some traffic icons are displayed only on the map at higher detail levels.

TRAFFIC INFORMATION SETTINGS

Settings for traffic information related functions can be changed.

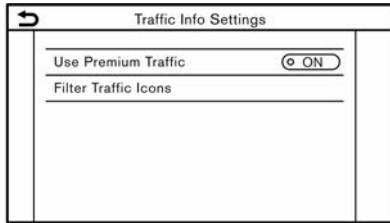



1. Touch [Settings] on the Launch Bar.
2. Touch [Navigation].
3. Touch [Traffic Info Settings].
4. Touch the preferred setting. The indicator for the selected setting illuminates.

Available setting items

- [Use Premium Traffic]:
Turns Premium Traffic information on/off.
- [Filter Traffic Icons]:
Selects which types of traffic incidents (e.g., accident) will be displayed on the map screen.



INFO:

- [Traffic Info Settings] can also be accessed from current location map screen.
 "Current location map screen" (page 6-12)
- Even when [Traffic Announcement] is set to off, the route guidance will not be affected. Also, the announcement of emergency information will not be turned off.
 "Guidance settings" (page 6-35)

STORING A LOCATION/ROUTE

STORING LOCATION

Often visited locations can be stored in the Address Book. The stored addresses can be easily retrieved to set them as a destination or waypoint. The Address Book can store up to 200 locations.

Storing home or work location

A home or work location can be stored in the system.

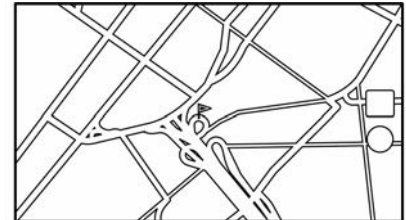

1. Touch [Settings] on the Launch Bar.
2. Touch [Navigation] and touch [Address Book].
3. Touch [Add Home Location] or [Add Work Location].
4. Touch an appropriate method to set a location. Refer to the search methods used for destination setting.
 "Setting destination" (page 6-13)
5. Touch [OK].
6. A message is displayed, and the address of the location is stored in the

6. Navigation (if equipped)

Address Book.

- Adjust and edit the contents of the stored item as necessary. Touch [OK] to confirm.
 "Editing stored location" (page 6-41)

INFO:



If you touch [Go Home (Save Location)] or [Go to Work (Save Location)] on the destination screen while the home or work location is not stored yet, the system will display a message asking if you wish to store a home or work location. Touch [Yes] to store the home or work location.

Storing location by searching

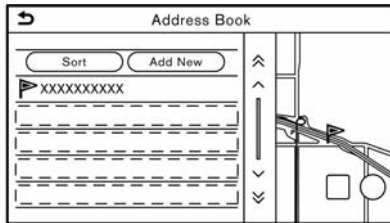
It is possible to store a location by searching in various ways.



- Touch [Settings] on the Launch Bar.
- Touch [Navigation].
- Touch [Address Book].
- Touch [Saved Locations].

- Touch [Add New].
- Touch an appropriate method to set a location. Refer to the search methods used for destination setting.
 "Setting destination" (page 6-13)
- Touch [OK].
- A message is displayed, and the address of the location is stored in the Address Book.
- Adjust and edit the contents of the stored item as necessary. Touch [OK] to confirm.
 "Editing stored location" (page 6-41)

INFO:

- When the location is stored in the [Saved Locations], [Address Book] can be used to search for the location.
 "Searching from Address Book" (page 6-18)
- When 200 locations are already stored, a new location cannot be stored until a currently stored location is deleted.

Storing location by moving map

- Move to the preferred location on the map and touch  on the touch screen display.

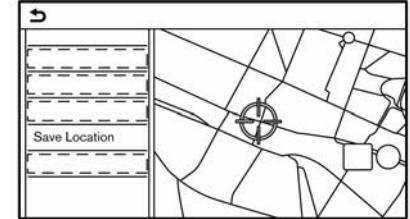

- Touch [Save Location]. A message is displayed.
- The icon representing the stored location is displayed on the map. Push **<MAP>** to return to the current location map screen.

STORING ROUTE

A maximum of 10 calculated routes can be stored. Stored routes can be easily retrieved and set as the suggested route.

A route requires at least one waypoint in order to be stored.

- Push **<MAP>** and then touch [Route] on the Launch Bar.
- Touch [Save Route]. A confirmation message is displayed. If asked, touch [Yes] to store the current route.

Other settings

A route can also be stored using the following procedure.

6. Navigation (if equipped)

1. Touch [Settings] on the Launch Bar.
2. Touch [Navigation].
3. Touch [Address Book].
4. Touch [Saved Routes].
5. Touch [Save Current Route]. A confirmation message is displayed. If asked, touch [Yes] to store the current route.



INFO:

- At least 1 waypoint must be set for the route to be stored.
- A stored route includes only locations (destination and waypoints) and route calculation conditions, not the route itself.
- The route is stored in the first available position number in the stored routes list.
- When 10 routes are already stored in the Address Book, a new route cannot be stored until a route is deleted.
☞ "Deleting stored item" (page 6-43)

STORING AVOID AREA

An Avoid Area can be stored. The Avoid Area is an area that can be excluded from a route, such as a road that is always congested. Once Avoid Areas are stored, the system avoids those areas when calculating a route. Up to 10 Avoid Areas can be stored.

1. Touch [Settings] on the Launch Bar.
2. Touch [Navigation].
3. Touch [Address Book].
4. Touch [Avoid Area].

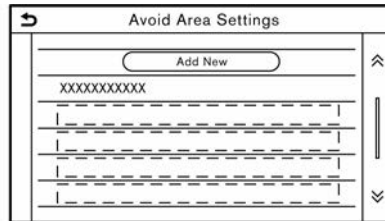

5. Touch [Add New].
Touch an appropriate method to search for a location.
☞ "Setting destination" (page 6-13)
6. Touch [OK].
7. Adjust the information of the Avoid Area as necessary.
☞ "Editing avoid area" (page 6-43)
8. Touch [OK] to store the avoid area information.



INFO:

A maximum of 10 Avoid Areas can be stored. When 10 Avoid Areas are already stored, a new Avoid Area cannot be stored until a currently stored Avoid Area is deleted.

☞ "Deleting stored item" (page 6-43)

EDITING STORED INFORMATION

Items stored in the system can be edited.

Editing stored location

1. Touch [Settings] on the Launch Bar.
2. Touch [Navigation] and touch [Address Book].

Available items may vary depending on models and specifications.

Setting item		Action	
[Home Location]*	[Edit]	[Show Icon on Map]	Displays the home icon on the map.
		[Icon]	Selects a home icon of a preferred design.
		[Sound]	Sets the type of the alarm that sounds when the vehicle approaches home.
		[Direction]	Sets the alarm to sound when approaching from a specific direction.
		[Distance]	Sets the alarm to sound when reaching a specific distance to home.
		[Phone Number]	Stores the home phone number.
	[Move Location]	Adjusts the stored home location.	
	[Delete]	Deletes the stored home location.	
[OK]	Confirms and saves the edited home information.		
[Work Location]*	[Edit]	[Show Icon on Map]	Displays the work icon on the map.
		[Icon]	Selects a work icon of a preferred design.
		[Sound]	Sets the type of the alarm that sounds when the vehicle approaches work.
		[Direction]	Sets the alarm to sound when approaching from a specific direction.
		[Distance]	Sets the alarm to sound when reaching a specific distance to work.
		[Phone Number]	Stores the work phone number.
	[Move Location]	Adjusts the stored work location.	
	[Delete]	Deletes the stored work location.	

6. Navigation (if equipped)

	[OK]		Confirms and saves the edited work information.	
[Saved Locations]	[Sort]	[Sort by Number]	Sorts the saved locations. ☞ “Searching from Address Book” (page 6-18)	
		[Sort by Name]		
		[Sort by Icon]		
		[Sort by Group]		
	[Add New]			Adds a new location. ☞ “Storing location by searching” (page 6-39)
	Saved Location List	[Edit]	[Show Icon on Map]	Displays the icon of a stored location on the map.
			[Name]	Registers a name of the entry.
			[Voice Tag]	Registers a voice tag for the entry which allows the entry to be used with the Voice Recognition System (if equipped).
			[Icon]	Selects an icon for the entry.
			[Sound]	Sets the type of the alarm that sounds when the vehicle approaches the location.
			[Direction]	Sets the alarm to sound when approaching from a specific direction.
			[Distance]	Sets the alarm to sound when reaching a specific distance to the location.
			[Phone Number]	Registers a phone number for the location.
			[Group]	Registers a group of the entry.
[Entry Numbers]			Registers an entry number for the location.	
[Move Location]			Adjusts the stored location information.	
[Delete]			Deletes the stored location information.	
[OK]			Confirms and saves the edited stored location information.	

*: When home or work location has not been stored, [Add Home Location] or [Add Work Location] is displayed and a home or work location can be stored from the menu.

Editing stored route

1. Touch [Settings] on the Launch Bar.
2. Touch [Navigation] and touch [Address Book].
3. Touch [Saved Routes].
4. Touch the preferred saved route from the list. Saved Routes settings screen will be displayed.

Setting item	Action
[Rename]	Changes the saved route name.
[Replace]	Overwrites the saved route with the current route.
[Delete]	Deletes the saved route.
[OK]	Applies the edited settings.

Editing avoid area

1. Touch [Settings] on the Launch Bar and touch [Navigation].
2. Touch [Address Book] and then touch [Avoid Area].
3. Touch a preferred Avoid Area from the list. Avoid Area settings screen will be displayed.

Setting item	Action
[Rename]	Changes the name of an Avoid Area.
[Move Location]	Adjusts the Avoid Area location.
[Resize Area]	Adjusts the size of the Avoid Area.
[Motorway]	Sets the Avoid Area to include or not include motorways. The color of the Avoid Area changes depending on the setting. Motorway ON: Green Motorway OFF: Blue
[Delete]	Deletes an Avoid Area.
[OK]	Applies the edited setting.

DELETING STORED ITEM

The locations and routes in the Address Book can be deleted. Deleting an individual item and deleting all stored items are available.



INFO:

Deleted items cannot be restored. Before deleting an item, always make sure that the item is no longer needed.

6. Navigation (if equipped)

Deleting stored item individually

1. Touch [Settings] on the Launch Bar.
2. Touch [Navigation] and touch [Address Book].
3. Touch [Delete Saved Items].

Select the preferred item and touch [Yes] to confirm deletion.

Step 1	Step 2	Action
[Delete Home Location]		Deletes home location.
[Delete Work Location]		Deletes work location.
[Delete Address Book]	[Delete All]	Deletes all stored locations.
	[Delete One]	Deletes a selected stored location.
[Delete Saved Routes]	[Delete All]	Deletes all stored routes.
	[Delete One]	Deletes a selected stored route.
[Delete Avoid Areas]	[Delete All]	Deletes all Avoid Areas.
	[Delete One]	Deletes a selected Avoid Area.
[Delete Previous Destinations]	[Delete All Previous Destinations]	Deletes all of the previous destinations.
	[Delete One Previous Destination]	Deletes a selected previous destination.
	[Delete Previous Starting Point]	Deletes the previous starting point.
[Delete Learned Routes]		Deletes the learned routes.

Deleting individual item on map

1. Align the cross pointer over the stored location to be deleted by moving on the map, and then touch .

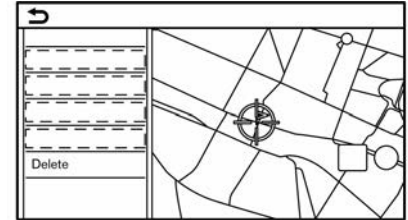

2. Touch [Delete].
3. A confirmation message is displayed. Confirm the contents of the message and touch [Yes].
The stored item is deleted from the Address Book.





NAVIGATION SETTINGS

The navigation system can be customized according to the user's preference.



1. Touch [Settings] on the Launch Bar.
2. Touch [Navigation].
3. Touch the item you would like to set.

Available setting items may vary depending on models and specifications.

Available items :

- **[Map Settings]**
Sets the display method and direction of the map.
 "Map settings" (page 6-8)
- **[Guidance Settings]**
Sets the various functions for route guidance.
 "Guidance settings" (page 6-35)
- **[Route Preference]**
Changes the routing preferences.
 "Route Preference" (page 6-29)
- **[Traffic Info Settings]**
Sets the various functions of the Traffic information feature.
 "Traffic information settings" (page 6-38)
- **[Safety Guide Settings]**

6. Navigation (if equipped)

Setting item	Action
[Speed Limit Indication on Map]	When this item is turned on, the speed limit indicator will appear on the right side of the map screen when there is a speed limit on the road the vehicle is driving on.  "2D map" (page 6-3)
[Speed Limit Warning]	When this item is turned on, the speed limit indicator will blink and warn the driver when the vehicle speed exceeds the speed limit.  "2D map" (page 6-3)
[Speed Limit Sens.]	Adjusts the speed limit sensitivity for [Speed Limit Warning].

- **[Address Book]**

Stores locations and routes. Stored items can be edited or deleted.

 "Storing a location/route" (page 6-38)

- **[Customise POIs]**

Sets the POI categories to be displayed on the Points of Interest screen.

 "Customizing POIs" (page 6-18)

- **[Adjust Current Location]**

If the vehicle icon indicating the current vehicle location is not in the correct position, the location of the vehicle icon on the map screen can be adjusted.

- **[Delete Saved Items]**

Deletes a saved location or route.

 "Deleting stored item individually" (page 6-44)

- **[Delete Previous Destinations]**

Deletes all or one of the previous destinations or the previous start point.

 "Deleting stored item individually" (page 6-44)

- **[Sync with Door-to-Door Navi]**

Turns on/off Door-to-Door Navigation.

 "Using Door-to-Door Navigation" (page 6-21)

- **[Reset All Navigation Settings to Default]**

This resets various settings (display, volume level, etc.) to the default settings.

- **[EV Settings]**

Various EV-specific settings can be adjusted from this menu.

 "Unique EV function settings" (page 2-7)

6. Navigation (if equipped)

GENERAL INFORMATION FOR NAVIGATION SYSTEM

CURRENT VEHICLE LOCATION

Display of current vehicle location

This navigation system combines the data obtained from the vehicle (by gyro sensor) and from Global Navigation Satellite System (GNSS) to calculate the current location of the vehicle. This position is then displayed throughout route guidance to a destination.

What is Global Navigation Satellite System (GNSS)?

GNSS is a general term for positioning systems that use signals from satellites. This navigation system receives radio signals from three or more different satellites, and detect the position of the vehicle by utilizing the principle of triangulation.

Positioning adjustment:

When the system judges that the vehicle position is not accurate based on vehicle speed and gyro sensor data calculations, the system will automatically adjust the position of the vehicle icon using GNSS signals.

Receiving signals from GNSS satellites:

The reception of GNSS signals can be weak, depending on the environment. Vehicles in the following areas/environments may not receive GNSS signals.

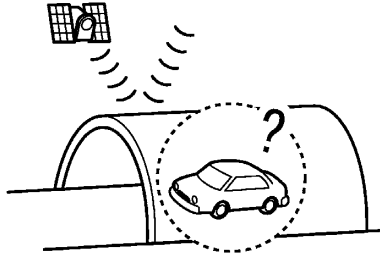

- Inside tunnels or parking garages

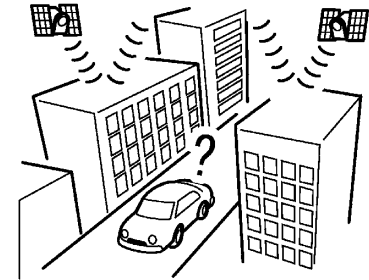

- In areas with numerous tall buildings

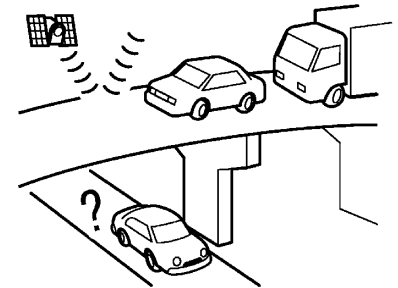

- Under multi-layered highways

6. Navigation (if equipped)

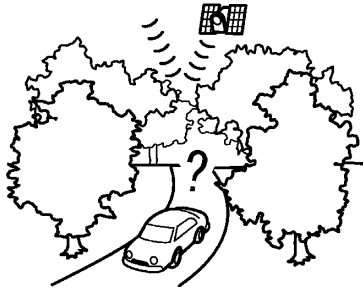

- Areas with numerous tall trees

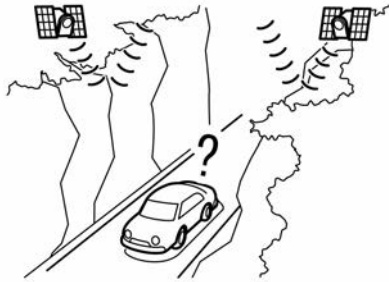

- In canyons

INFO:

The GNSS antenna is located on the instrument panel inside the vehicle. Do not place any objects, especially cellular phones or transceivers, on the instrument panel. Because the strength of the GNSS signal is weak, phones and transceivers

will affect or may totally disrupt the signal.

Incorrect display of vehicle position

The following cases may affect the display accuracy of the vehicle's position or traveling direction. The accuracy will return to normal if the driving conditions return to normal.

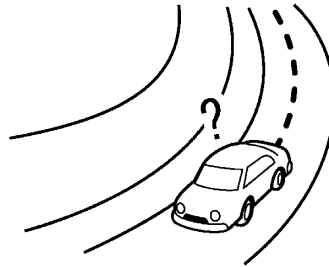

- When there is a similar road nearby.

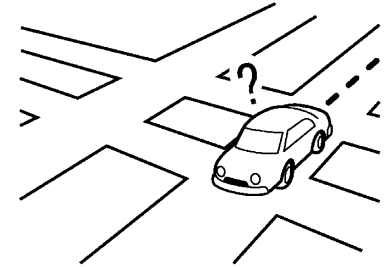

- When the vehicle is traveling in an area with a grid pattern road system.

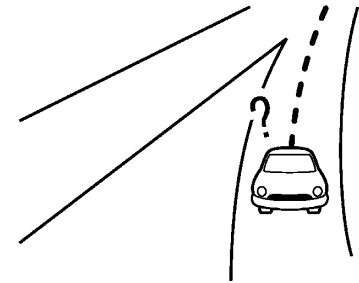

- When the vehicle is passing through a large Y-shaped intersection/junction.

6. Navigation (if equipped)

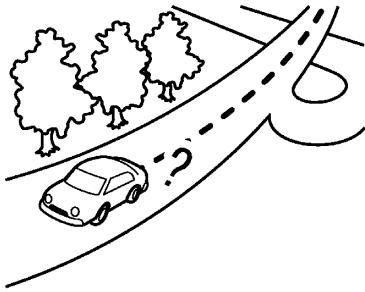

- When the vehicle is traveling on a continuous, slowly curving road.

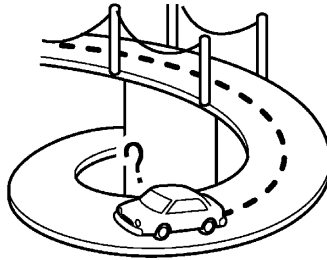

- When the vehicle is on a loop bridge.

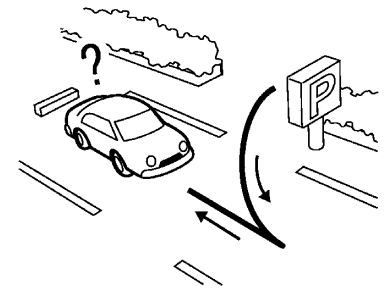

- When repeatedly turning left or right, or driving in zigzags.

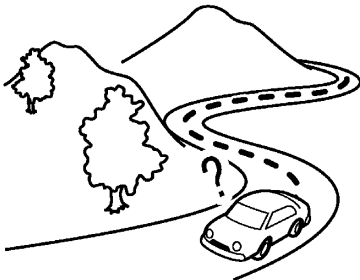

- When the vehicle is traveling on a road with repeating S-shaped curves.



- When the vehicle is on a snow-covered or unpaved road.

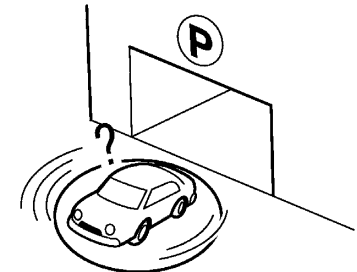

- When the vehicle is rotated on a parking lot turntable while the power switch placed in the OFF position.

6. Navigation (if equipped)

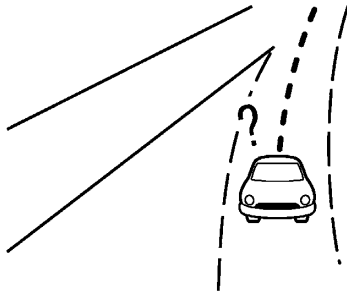

- When driving on a road not displayed on the map screen or a road that has been changed due to additional construction or other reasons.

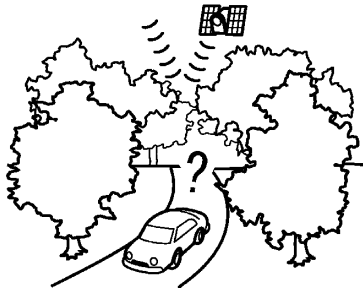

- When the GNSS positioning accuracy is low.

INFO:

- The vehicle icon may be misaligned when starting the vehicle just after the

READY to drive indicator light is turned on.

- The vehicle icon may also be misaligned if different sized tires or tire chains are installed.
- The system has a function that automatically corrects the vehicle icon position when it is misaligned from the actual position.
- Vehicle position correction by GNSS may not function when the vehicle is stopped.
- If the vehicle icon position does not return to normal even after driving for a while, correct the vehicle icon position manually.

Detailed Map Coverage Areas (MCA) for navigation system

This system is designed to help guiding to the destination, and it also performs other functions as outlined in this manual. However, the system must be used safely and properly. Information concerning road conditions, traffic signs and the availability of services may not always be up to date. The system is not a substitute for safe, proper and legal driving.

Map data covers select metropolitan areas.

Map data includes two types of areas: "Detailed coverage areas" providing all detailed road data and other areas show-

ing "Main roads only".

INFO:

Detailed map data is not available in many areas and is generally limited to select major metropolitan areas.

ROUTE CALCULATION

- The suggested route may not be the shortest, nor are other circumstances such as traffic jams considered.
- Because of the inevitable difference in road conditions and circumstances between the time you use this system and the time the information was produced for the map data, there may be discrepancies in roads and regulations. In such cases, actual road conditions and regulations take precedence over map data information.
- During route calculation, the map will not scroll, however the vehicle icon will move according to the actual vehicle's movement.
- During route calculation, buttons such as **<MAP>** and **<MENU>** will be disabled.
- In some cases, after the calculation is complete, the calculated route may not be immediately displayed.
- Waypoints that have been passed will be disregarded by rerouting calculation.

6. Navigation (if equipped)

- If you scroll the map while the suggested route is being drawn, it may take more time to finish drawing.
- Route calculation may not be completed in the following cases.
 - If there is no main road within a range of 2.5 km (1.5 miles) from the vehicle, a message saying so will appear on the screen. Try recalculating when the vehicle is closer to a main road.
 - If there is no main road within a range of 2.5 km (1.5 miles) from the destination or waypoint, a message saying so will appear on the screen. Try setting the location closer to a main road.
 - If the vehicle is too close to the destination or if there are no roads to the destination, a message saying so will appear on the screen.
 - If it is impossible to reach the destination or waypoints because of traffic regulations, etc.
 - If the only route to reach the destination or waypoints is extremely complicated.
- The following may occur when the route is displayed.
 - If you calculate a route on a main road, the starting point of the route may not exactly match the current vehicle location.
 - The endpoint of the route may not exactly match the destination.
 - If you calculate a route on a main road, the system may display a route from another main road. This may be because the position of the vehicle icon is not accurate. In this case, park the vehicle in a safe location and reset the vehicle icon, or continue driving to see if the position of the vehicle icon is automatically adjusted before recalculating the route.
 - There are cases in which the system shows an indirect route to reach the destination or waypoints, if you set them from stored or facility information. In order to correct this, you must be careful about the traffic direction, especially when lanes with different travel directions are shown separately, such as interchanges and service areas.
 - This system makes no distinction between limited traffic control and total control (blockage). It may show an indirect route even if the road is usable.
 - Even if the ferry preference is set to OFF, a route that uses a ferry line may be suggested.

ROUTE GUIDANCE



INFO:

The system will announce street names when the system language is set to English.

Repeating voice guidance

This function is available throughout route guidance, from the time after the route calculation is completed until the vehicle arrives at the destination. Push and hold **<MAP>**. Voice guidance will be repeated.

Notes on voice guidance

- Voice guidance in this system should be regarded as a supplementary function. When driving the vehicle, check the route on the map and follow the actual roads and traffic regulations.
- Voice guidance is activated only for intersections with certain conditions. There may be cases where the vehicle has to turn, but voice guidance is not provided.
- Voice guidance contents may vary, depending on the direction of the turn and the type of intersection.
- The voice guidance timing will vary depending on the situation.
- When the vehicle has deviated from the suggested route, voice guidance is not available. The system will not

announce this. Refer to the map and recalculate the route.

 "Recalculating route" (page 6-32)

- Voice guidance may not accurately correspond with road numbers and directions at motorway junctions.
- The displayed street names may sometimes differ from the actual names.
- Voice guidance is not available when [Guidance Voice] is turned off.
 "Volume and Beeps settings" (page 1-19)
- Voice guidance will start when the vehicle enters the suggested route. Refer to the map for directions to the starting point of the route.
- When approaching a waypoint, the voice guidance will announce and inform the driver that the vehicle has reached a waypoint. Voice guidance will switch to the next section of the route. When voice guidance is not available, refer to the map for directions.
- In some cases, voice guidance ends before arrival at the destination. Refer to the destination icon on the map to reach the destination.
- Voice guidance may be partially operational or inoperative due to the angle of roads at an intersection.

- Motorway exit information may differ from the information on the actual exit signs.
- Because it is not possible to consider data concerning roads that are seasonally available or unavailable, a route may be displayed that does not match the actual traffic restrictions. Be sure to follow the actual traffic restrictions while driving.

HOW TO UPDATE MAP DATA (if equipped)



WARNING

TO AVOID RISK OF DEATH OR SERIOUS PERSONAL INJURY WHEN UPDATING THE MAP SOFTWARE:

If you choose to park the vehicle within range of a TCU (Telematics Control Unit) (if equipped) or a Wi-Fi connection (if equipped), park the vehicle in a secure and safe location.

1. **Apply the parking brake.**
2. **Remain with the vehicle while the update is in process.**
3. **Do not allow children, pets or people who may need assistance to remain in the vehicle while the software is updating.**



NOTE:

The vehicle is not required to be parked during the map update process.

Map data can be updated via USB, Wi-Fi (if equipped) or TCU (Telematics Control Unit) (if equipped).

Updating with USB memory

The navigation map data can be updated with the latest information by downloading a new map database to a USB memory device and installing it in the vehicle.

For map update, use the USB memory with the following specifications:

Supported media: USB2.0

Supported file system: FAT32

1. Push <MENU>.
2. Touch [Info] on the Launch Bar and then touch [System Information].
3. **For Europe:**
Touch [Map Update] and then touch [Update via USB Device].
Except for Europe:
Touch [Map Update].
4. Touch [Save Map Information to USB Device].
5. Insert blank USB memory device into the USB connection port.
 "USB (Universal Serial Bus) connection port and AUX (auxiliary) input jack" (page 1-5)

6. Navigation (if equipped)



INFO:

If data is in the USB memory, it may be deleted.

6. Touch [Start].
7. Touch [OK] after saving the map information to USB.
8. Access to the designated website with your personal computer. Download and install the map update tool in your personal computer. (Consult a NISSAN dealer for details.)
9. Download the updated data and store it in the USB memory with the map update tool.
10. Push **<MENU>**.
11. Touch [Info] on the Launch Bar and then touch [System Information].
12. **For Europe:**
Touch [Map Update] and then touch [Update via USB Device].
Except for Europe:
Touch [Map Update].
13. Touch [Install Map Update from USB Device].
14. Insert the USB memory into the USB connection port.
A confirmation message is displayed. Confirm the contents of the message and touch [Yes].
15. Touch [OK] after completing the update.



INFO:

- The navigation system cannot be operated while the map updates.
- Map data should be updated while the EV system is running to prevent discharge of the vehicle battery (12V battery).
- The same operation can be performed by touching [Settings] on the Launch Bar and then touching [System Update].

Updating using wireless LAN (Wi-Fi) (if equipped)

The map data can be updated using the vehicle Wi-Fi connection. Wi-Fi communications can be made by using a Wi-Fi network, smartphone, etc.

"Wi-Fi setting" (page 1-17)

1. Connect the vehicle to an available Wi-Fi network.
2. Push **<MENU>**.
3. Touch [Info] on the Launch Bar and then touch [System Information].
4. Touch [Map Update].
5. Touch [Update via Wi-Fi].
6. Select an area to be updated, and touch [Start].
7. Touch [OK] after completing the update.



INFO:

- When [Cancel] is displayed during the map data update, touching the key can cancel the update.
- The navigation system cannot be operated while the map updates.
- Do not turn off the power source of the smartphone while updating.
- Map data should be updated while the EV system is running to prevent discharge of the vehicle battery (12V battery).
- Touch [Vehicle Hotspot] (if equipped) and turn on the indicator to activate the Wi-Fi hotspot communication.
- The download data size of map update for one country or one regional zone can vary between 100 MB to 1 GB. Data size in case of updating multiple countries or regional zones can be over 1 GB. Use of Wi-Fi hotspot functionality of your smartphone for map updates may incur additional data charges from your cellular provider. Please connect to your home Wi-Fi network to avoid additional phone data charges.
- The same operation can be performed by touching [Settings] on the Launch Bar and then touching [System Update].

- The update is done in the background, and the updates are reflected in the map data the next time the system is started.

Automatic map update (if equipped)

The map data can be updated using the TCU (Telematics Control Unit).

1. Push **<MENU>**.
2. Touch [Info] on the Launch Bar and then touch [System Information].
3. Touch [Map Update].
4. Touch [Map Update Settings].
5. Select an area of the map you wish to update. A confirmation message is displayed. The next time you start the system, a notification message will be displayed if map data update is available.
6. Touch [Yes] to update the map data.



INFO:

The update is done in the background, and the updates are reflected in the map data the next time the system is started.

Automotive products End User License Provisions

This End-User License Agreement ("**EULA**") is an agreement between you and TomTom International B.V. ("**TomTom**"). You agree that this EULA is enforceable. This EULA applies to your use of the TomTom Map data, software, Traffic and Travel services or any other TomTom products (together the "**Services**").

Please read this EULA carefully. By using the Services you agree to all the terms and conditions of this EULA.

1. **GRANT OF LICENSE:** In consideration of you agreeing to abide by the terms of this EULA, TomTom hereby grants to you a non-exclusive, license to use the Services solely in connection with the vehicle. If upgrades, updates or supplements to the Services are provided the use of such upgrades or updates is governed by this EULA.
2. **RESTRICTIONS:** You are prohibited from renting, lending, public presentation, performance or broadcasting or any other kind of distribution of the Services. Other than as permitted by applicable legislation, you will not, and you will not allow any person to, copy or modify the Services or any part thereof or to reverse engineer, decompile or disassemble the Services.
3. **OWNERSHIP:** Copyright and other intellectual, industrial and/or proprie-

tary rights to the Services are owned by TomTom and/or its suppliers. TomTom permits you to use the Services only in accordance with the terms of this EULA. All rights not specifically granted in this EULA are reserved by TomTom. To the extent applicable, you acknowledge that you have no right to have access to the Services in source code or in unlocked coding.

4. **THIRD PARTY SOFTWARE LICENSES:** The Services may make use of third party software. Notwithstanding Clauses 2 and 3, use of some third party materials included in the Software may be subject to other terms and conditions. The official copyright notices and specific license conditions of these third party software codes and algorithms are to be found via <http://www.tomtom.com>. You hereby agree to the terms and conditions for such third party software.
5. **LIMITED WARRANTY:**
 - YOU ACKNOWLEDGE THAT THE SERVICES HAVE NOT BEEN DEVELOPED TO MEET YOUR INDIVIDUAL REQUIREMENTS AND THAT IT IS THEREFORE YOUR RESPONSIBILITY TO ENSURE THAT THE FACILITIES AND FUNCTIONS OF THE SERVICES MEET YOUR REQUIREMENTS. TOMTOM DOES NOT AND CANNOT WARRANT THAT THE SERVICES OPERATE UNINTERRUPTED OR ERROR-FREE. YOU SHOULD BE PARTICULARLY

6. Navigation (if equipped)

AWARE OF THE FACT THAT CALCULATION ERRORS MAY OCCUR WHEN USING SOFTWARE IN A NAVIGATION SYSTEM FOR INSTANCE CAUSED BY LOCAL ENVIRONMENTAL CONDITIONS AND/OR INCOMPLETE DATA.

- TO THE MAXIMUM EXTENT PERMITTED BY APPLICABLE LAW, TOMTOM AND ITS SUPPLIERS PROVIDE THE SERVICES "AS IS", AND HEREBY DISCLAIM ALL OTHER WARRANTIES AND CONDITIONS, WHETHER EXPRESS, IMPLIED OR STATUTORY, INCLUDING, BUT NOT LIMITED TO, ANY (IF ANY) IMPLIED WARRANTIES, DUTIES OR CONDITIONS OF SATISFACTORY QUALITY, OF FITNESS FOR A PARTICULAR PURPOSE, OF RELIABILITY OR AVAILABILITY, OF ACCURACY OR COMPLETENESS OF RESPONSES, OF RESULTS, WITH REGARD TO THE SERVICES, AND THE PROVISION OF OR FAILURE TO PROVIDE SUPPORT OR OTHER SERVICES, INFORMATION, SOFTWARE, AND RELATED CONTENT THROUGH THE SERVICES OR OTHERWISE ARISING OUT OF THE USE OF THE SERVICES.

SAFETY: THE SERVICES ARE INTENDED TO BE USED FOR PROVIDING INFORMATION AND NAVIGATION SERVICES RELATED TO YOUR JOURNEY ONLY AND ARE NOT INTENDED TO BE USED AS A SAFETY RELATED TOOL AND CAN-

NOT WARN YOU ABOUT ALL DANGERS AND HAZARDS WITH RESPECT TO THE ROAD YOU ARE DRIVING. THEREFORE, IT REMAINS YOUR DUTY TO DRIVE IN A CAREFUL AND SAFE MANNER (PAYING ALL DUE CARE AND ATTENTION TO THE ROAD) AS WELL AS OBSERVING ALL APPLICABLE TRAFFIC REGULATIONS AND RULES. IT IS YOUR RESPONSIBILITY NOT TO USE THE SERVICES IN A MANNER THAT WOULD DISTRACT YOU FROM DRIVING SAFELY.

6. LIMITATION OF LIABILITY:

TO THE MAXIMUM EXTENT PERMITTED BY APPLICABLE LAW, NEITHER TOMTOM NOR ITS LICENSORS AND SUPPLIERS, OFFICERS, DIRECTORS OR EMPLOYEES SHALL BE LIABLE TO YOU OR TO ANY THIRD PARTY FOR ANY DAMAGES, WHETHER DIRECT, SPECIAL, INCIDENTAL, INDIRECT OR CONSEQUENTIAL (INCLUDING BUT NOT LIMITED TO, DAMAGES FOR THE INABILITY TO USE OR ACCESS THE SERVICES, LOSS OF DATA, LOSS OF BUSINESS, LOSS OF PROFITS, BUSINESS INTERRUPTION OR THE LIKE) ARISING OUT OF OR RELATED TO THE USE OF, THE INABILITY TO USE OR ACCESS, OR OTHERWISE THE PERFORMANCE OF THE SERVICES, EVEN IF NISSAN HAS BEEN ADVISED OF THE POSSIBILITY OF SUCH DAMAGES.

TO THE EXTENT TOMTOM IS NOT PERMITTED UNDER APPLICABLE LAW TO EXCLUDE ITS LIABILITY PURSUANT TO CLAUSE 6.1 ABOVE, TOMTOM'S TOTAL AGGREGATE LIABILITY TO YOU SHALL BE LIMITED TO THE AMOUNT OF US \$100.00.

THE ABOVE LIMITATIONS OF LIABILITY UNDER THIS CLAUSE 6 DO NOT: (I) AFFECT YOUR RIGHTS UNDER ANY APPLICABLE MANDATORY NATIONAL LEGISLATION; (II) EXCLUDE OR LIMIT ANY LIABILITY THAT CANNOT BE EXCLUDED OR LIMITED UNDER APPLICABLE LAW.

7. TERMINATION: Without prejudice to any other rights, TomTom may immediately terminate this EULA if you fail to comply with any of its terms and conditions. The provisions of this Agreement, which by their nature are intended to survive termination, will remain in effect after termination of this EULA.
8. LINKS TO THIRD PARTY SITES: TomTom and other third parties involved in making the Services available to you ("Third Parties") are not responsible for the contents of any third-party sites or services, any links contained in third-party sites or services, or any changes or updates to third-party sites or services which are delivered by the Services or otherwise. TomTom (and, as applicable, each of the Third Parties) is providing these links and ac-

cess to third-party sites and services to you only as a convenience, and the inclusion of any link or access does not imply an endorsement by TomTom or any Third Parties of the third-party site or service. Any use by you of such links or third party sites and the manner in which you use such third party sites and links shall be your responsibility and at your risk and you shall not use them in any illegal or fraudulent manner.

Should you have any questions concerning this EULA, or if you desire to contact TomTom for any reason, please visit TomTom's website at <http://www.tomtom.com>.

6. Navigation (if equipped)

MEMO

7 Voice recognition (if equipped)

Voice recognition	7-2
Using Voice Recognition System	7-2
Before starting	7-2
Giving voice commands	7-2
System Voice settings	7-5



7. Voice recognition (if equipped)

VOICE RECOGNITION

USING VOICE RECOGNITION SYSTEM

Initialization

When the power switch is in the ACC or ON position, voice recognition is initialized. When the initialization is complete, the system is ready to accept voice commands. If < 🗣️ > on the steering wheel is operated before the initialization completes, the display will show a message to wait until the system is ready.

BEFORE STARTING

To get the best recognition performance from voice recognition, observe the following items.

- The interior of the vehicle should be as quiet as possible. Close the windows to eliminate the surrounding noises (traffic noise, vibration sounds, etc.) and turn down the fan speed level of the heater/air conditioner to lower the noise which may prevent the system from correctly recognizing the voice commands.
- Wait until the tone sounds before speaking a command.
- Speak in a natural conversational voice without pausing between words.
- The system cannot recognize voice commands spoken from passenger

seats.

GIVING VOICE COMMANDS

1. Push < 🗣️ > on the steering wheel.

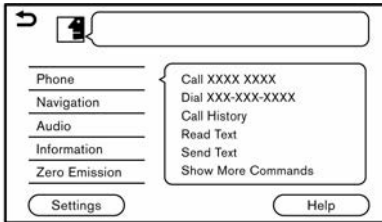

Example

2. A list of commands appears on the screen, and the system provides the voice menu prompt.

Available category commands are displayed on the left side of the screen. Speak or touch a category command from the category command list.

INFO:

- Some of the commands for each category are shown on the right side of the screen and they can also be spoken without selecting a category.
 - After executing the category command, only the commands related to the selected category can be recognized.
3. After the tone sounds and the icon on the screen changes from 🗣️ to 🗣️,

Speak a command. You can also select a command by directly touching the screen, using < ▲ >/< ▼ > on the steering wheel or using < TUNE-SCROLL/OK >/< 🗣️ /OK > on the control panel.

INFO:

The Voice Recognition System will pause its operation when no command is given after a few prompts. To resume the operation, push < 🗣️ > on the steering wheel.

4. Continue to follow the voice menu prompts and speak the voice commands after the tone sounds until the preferred operation is executed.

INFO:

- To exit the Voice Recognition System, push and hold < 🗣️ >/< 🏠 > on the steering wheel.
- Touching [🏠] on the touch screen or pushing < BACK > on the control panel repeatedly can also end the voice recognition session.
- Depending on the language setting, the Voice Recognition System cannot be used.

Operating tips

- Speak a command after the tone.
- If the command is not recognized, the system will prompt you to speak the command again. Repeat the command in a clear voice.
- Touch [↵] on the touch screen or push <↵> on the steering wheel to return to the previous screen.
- To adjust the volume of the system feedback, push <🔊> on the steering wheel or turn <VOL/🔊> while the system is making an announcement.

Voice Prompt Interrupt:

In most cases, you can interrupt the voice feedback to speak the next command by pushing <🔊> on the steering wheel. After interrupting the system, wait for a tone before speaking your command.

One Shot Call:

To use the system faster when making a call, you may speak the second level command skipping speaking the first level command. For example, push <🔊> on the steering wheel and say "Redial" after the tone without first saying "Phone".

How to see voice command screen

1. Push <🔊> on the steering wheel to display the first screen of the voice command list.
2. Speak a command or select an item on the voice command list. The second screen is displayed.
3. Speak a command or select an item on the voice command list. The command is executed or the next screen for further command is displayed.
4. Follow the prompts to complete the commands.

Voice command screens:

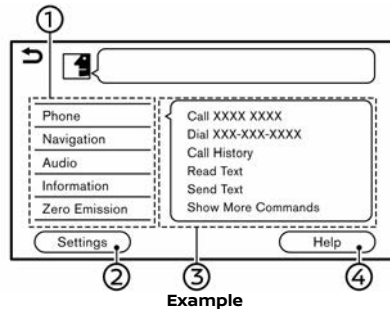

- ① Shows a list of available categories. Speak a category command or touch the key of the corresponding category.

- ② Touch [Settings] or say "Settings" to display the system voice settings.
- ③ Shows a list of available commands for the selected category. Speak a preferred command.
- ④ Touch [Help] or say "Help" to hear help announcements on how to use the system.

INFO:

Push <🔊> on the steering wheel to stop the help announcements.

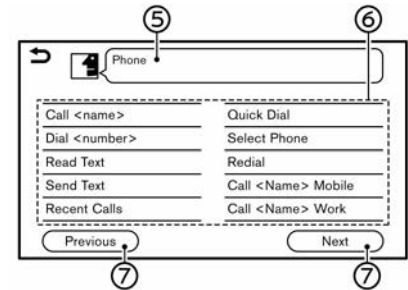

- ⑤ Previously selected command
- ⑥ Command list

You can speak a command from the list or touch the corresponding key. Preferred words can be spoken for the part of the command enclosed in <>.

7. Voice recognition (if equipped)

⑦ [Previous]/[Next]

Say as a command or touch to go to the previous/next screen.

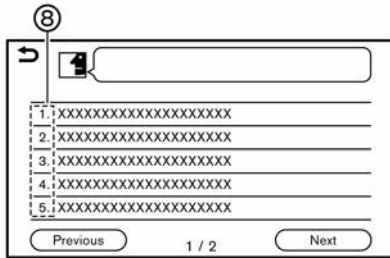

⑧ Speak a number from 1 to 5 or touch an item on the list screen to select the item.

How to speak numbers

The Voice Recognition System requires the user to speak numbers in a certain way when giving voice commands.

General rule:

Only single digits "0" (zero) to "9" can be used. (For example, for the number "600", speaking "six zero zero" can be recognized by the system, but "six hundred" cannot be recognized.)



INFO:

For the best recognition, speak "zero" for the number "0", and "oh" for the letter "o".

Voice command examples

As examples, some additional basic operations that can be performed by voice commands are described here.

Example 1 Placing call by speaking a phone number:

1. Push < > on the steering wheel.
2. Wait for the indicator to change to . Speak "Phone".

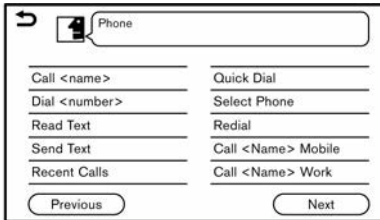

Example

3. Speak "Dial <number>".

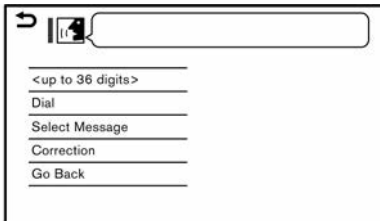

Example

4. The phone number recognized by the system is displayed on the screen. If the number is correct, say "Dial".
5. The system will make a phone call to the spoken phone number.

Example 2 Tuning station of FM:

1. Push < > on the steering wheel.
2. Wait for the indicator to change to . Speak "Audio".
3. Speak "Tune <frequency> FM". The system will tune to the FM radio station and the audio screen will be displayed.

SYSTEM VOICE SETTINGS

The system voice settings can be changed.

1. Touch [Settings] on the Launch Bar.
2. Touch [System Voice].
3. Touch the item you would like to set.

Available setting items may vary depending on models and specifications.

Available item	Action
[Initial Voice Prompt]	When this item is turned on, voice prompts are announced.
[Short Voice Prompts]	When this item is turned on, short and minimized voice feedback will be provided.
[Best Match Lists]	When these items are turned on, the voice recognition results are displayed on the list in the order of reliable recognition.
[Phone Book] [Music Commands]	
[Voice Preference]	Guidance voice setting can be selected from a male or female voice. Depending on the language setting, the guidance voice setting cannot be changed.
[Speech Rate]	Adjusts the speech rate of prompt.

7. Voice recognition (if equipped)

MEMO



8 Troubleshooting guide

System unit.....	8-2
Liquid crystal display	8-2
Unique EV functions (if equipped)	8-3
Driving range	8-3
Charging stations	8-4
Energy information display	8-5
Audio system	8-6
AM radio	8-6
DAB radio (if equipped)	8-7
iPod player	8-9
USB memory device	8-11
Bluetooth® audio	8-12
Bluetooth® Hands-Free Phone System	8-14
Apple CarPlay (if equipped)	8-17
Android Auto (if equipped)	8-18
Siri Eyes Free (if equipped)	8-19
Navigation (if equipped)	8-20
Basic operations	8-20
Vehicle icon	8-21
Route calculation and visual guidance	8-23
Voice guidance	8-25
Traffic information (if equipped)	8-26
Voice recognition (if equipped)	8-27

8. Troubleshooting guide

SYSTEM UNIT

LIQUID CRYSTAL DISPLAY

Symptom	Possible cause	Possible solution
The screen is too dark.	The cabin temperature is too low.	Wait until the cabin temperature becomes moderate.
	Screen brightness is set to the maximum darkness.	Adjust the brightness setting of the screen.  "Display settings" (page 1-21)
The screen is too bright.	Screen brightness is set to the maximum brightness.	Adjust the brightness setting of the screen.  "Display settings" (page 1-21)
A small black spot or a small bright spot appears on the screen.	This is a typical phenomenon for liquid crystal displays.	This is not a malfunction.
A dot or stripe pattern appears on the screen.	Electromagnetic waves that are generated from neon billboards, high voltage electric power cables, ham radios or other radio devices equipped to other vehicles may adversely affect the screen.	This is not a malfunction.
Image lag appears on the screen.	This is a typical phenomenon for liquid crystal displays.	This is not a malfunction.
Image motion displayed on the screen is slow.	The cabin temperature is less than 10°C (50°F).	Wait until the cabin temperature rises to within 10°C (50°F) and 50°C (122°F).
When looking at the screen from an angle, the screen lightens or darkens.	This is a typical phenomenon for liquid crystal displays.	Adjust the brightness setting of the screen.  "Display settings" (page 1-21)
The screen turns blue or an error message is displayed on the touch screen display.	A system malfunction has occurred.	It is recommended that you contact a NISSAN dealer for an inspection.



UNIQUE EV FUNCTIONS (if equipped)

DRIVING RANGE

Symptom	Possible cause	Possible solution
The driving range cannot be displayed.	The power switch is in the ACC position.	The driving range can be displayed when the power switch is in the ON position or when the READY to drive indicator light is on.
	It cannot be displayed because the distance to empty is too short.	Charge the Li-ion battery. Once the distance to empty increases, the driving range will be displayed.

8. Troubleshooting guide

CHARGING STATIONS

Symptom	Possible cause	Possible solution
The charging station icon display setting is off but icons are still displayed on the map.	The charging station displayed has been set as a stored location.	This is not a malfunction.
Searched for charging stations because the battery information guidance (if equipped) was displayed, but could not find any.	In an area where the number of charging stations is low, it may not be possible to find a charging station located near the vehicle.	This is not a malfunction.
Charging station information is not displayed.	Information is not provided for all charging stations, so there may be cases when information is not displayed.	This is not a malfunction. Contact charging stations beforehand by phone to confirm whether they can be used.
The charging station information displayed is incorrect.	The map data is old.	Update the map data.  "How to update map data" (page 6-53) Models with NissanConnect Services: Charging station information on the map automatically updates periodically.
The charging station information provided by the system was incorrect and could not charge the Li-ion battery.	The map data is old.	Update the map data.  "How to update map data" (page 6-53) Models with NissanConnect Services: Charging station information on the map automatically updates periodically.
	Charging station facilities have changed, or the charge cable equipped cannot be used.	Contact the charging station by phone beforehand to check whether facilities can be used.

ENERGY INFORMATION DISPLAY

Symptom	Possible cause	Possible solution
<p>The driving range fluctuation value based on the climate control system activation condition displayed in the energy usage information screen is displayed as +0 km (+0 mile) or -0 km (-0 mile).</p>	<p>The power used for the climate control system will decrease in response to the power used by the traction motor and the increase/decrease difference of the driving range will be under ± 1 km (± 1 mile). Also, when the Li-ion battery available charge is low, the increase/decrease of the driving range will also become smaller.</p>	<p>This is not a malfunction.</p>

8. Troubleshooting guide

AUDIO SYSTEM

AM RADIO

Symptom	Possible cause	Possible solution
AM reception deteriorates at night.	AM stations are required to lower their power at night.	This is not a malfunction.

8. Troubleshooting guide

DAB RADIO (if equipped)

Symptom	Possible cause	Possible solution
The sound skips, stutters or echoes.	The radio station has not properly aligned digital and analog audio.	Verify correct operation on another station. Report the station with poor performance.
The volume level is unstable.	Level alignment is inappropriate.	Verify correct operation on another station and check the station availability in the area. Report the station with poor alignment.
The sound fades in/out.	DAB-FM is taking place.	Verify transition performance on several stations in the area. Report stations with poor alignment.
Excessive DAB-FM takes place.	The vehicle is located near the edge of the DAB coverage area.	Verify the radio station coverage in your area.
The sound quality of DAB is no better than that of FM/AM.	Audio processing on the digital audio by the station can potentially decrease digital audio sound quality.	Verify correct operation on another station. Report the station with poor performance.
Local stations keep being lost.	Digital coverage is slightly smaller than analog signal coverage.	Verify correct operation on another station.
	Shadowing (Urban/Terrain) can cause reduced digital coverage.	Verify correct operation on another station.
Some data fields are blank.	Text information is sent at the broadcaster's discretion.	Verify correct operation on another station. Report the station issue.
Text information is truncated.	The display is limited to a fixed number of characters and more data is being sent than can be displayed.	This is not a malfunction.
The DAB-FM setting is turned on but an alternative station does not play and the signal does not appear on the display.	The tuner is waiting for the original signal to recover and is seeking an available alternative signal.	Wait for the signal to return or for the tuner to pick up an alternative signal.
A message indicating that service is not available is displayed on the screen.	The selected service or ensemble is not in service.	Select a different service or ensemble.

8. Troubleshooting guide



INFO:

- When station presetting is performed while a secondary service is playing, the parent primary service will be registered.
- Secondary services do not appear on the station list.

8. Troubleshooting guide

iPod PLAYER

Symptom	Possible cause	Possible solution
The system does not recognize an iPod.	A connector cable is not correctly connected, or the iPod does not correctly operate.	Connect the connector cable again. If the system does not recognize the iPod after performing this procedure above, reset the iPod.
	The iPod that is to be connected is not compatible with the system.	Check the iPod model and firmware versions available for the system.
	The connected USB extension cable is not compatible with the system.	Replace the USB extension cable if the system still does not recognize the iPod after reconnecting the cable properly a number of times.
	The cable is rapidly connected to or disconnected from the USB connection port.	Slowly connect or disconnect the USB cable.
An iPod cannot be operated.	The iPod is connected to the in-vehicle audio system while headsets, etc. are connected to the iPod.	Remove all equipment from the iPod after disconnecting the iPod from the system, and then connect it to the system again.
	The iPod is not operating normally.	Disconnect the iPod from the in-vehicle audio system, and then connect it to the system again.
	The system plays back an album/file that includes a particular album art.	Disconnect the iPod from the in-vehicle audio system, and then reset the iPod. Disable the album art, and then connect the iPod to the system.  "iPod Menu" (page 3-21)
An iPod does not respond.	There are too many files in a category.	Decrease the number of files in a category (less than 65500 files).
	The shuffle function is turned on.	Turn off the shuffle function if many files are stored on the iPod.
Music cannot be played back.	A connector is not connected to the iPod.	Firmly connect the connector to the iPod.
Playback cuts out.	The sound cuts due to vibration resulting from an unstable location of the iPod.	Place the iPod on a stable location where it does not roll over.
Battery charge of an iPod takes longer.	Battery charge of the iPod may take longer while an iPod is playing back.	If the iPod needs to be charged, it is recommended to stop playing the music.

8. Troubleshooting guide

Symptom	Possible cause	Possible solution
Battery charge of an iPod is unavailable.	The cable that is connected to the iPod may be damaged or improperly connected.	Check the cable currently in use.
Functions cannot be operated using an iPod that is connected to the in-vehicle audio system.	-	The operation of an iPod must be performed using the in-vehicle audio system after the iPod is connected to the system.
Sound skips.	Surrounding circumstances (noise, etc.) may cause the sound to skip.	This does not indicate a malfunction.
	A USB extension cable is used.	Do not use a USB extension cable.

USB MEMORY DEVICE

Symptom	Possible cause	Possible solution
The system does not recognize a USB device.	A USB extension cable is used.	Do not use a USB extension cable.
	A USB hub is used.	Do not use a USB hub.
	A USB device is rapidly connected to or disconnected from the USB connection port.	Slowly connect or disconnect the USB device.

8. Troubleshooting guide

BLUETOOTH® AUDIO

Symptom	Possible cause	Possible solution	
Registration cannot be performed.	The Bluetooth® audio device is not compatible with the in-vehicle audio system.	Check the Bluetooth® audio device Owner's Manual.	
	Bluetooth® is disabled on device.	Check that the Bluetooth® function is enabled on device.	
	The PIN code is incorrect.		Check the PIN code for the Bluetooth® audio device that is to be registered.
			Check that the PIN code for the Bluetooth® audio device is consistent with that for the in-vehicle audio system.
Another Bluetooth® device is used in the vehicle.	Turn off the other Bluetooth® device until the registration is completed.		
Music cannot be played back.	The Bluetooth® audio device is not compatible with the in-vehicle audio system.	Check the Bluetooth® audio device Owner's Manual.	
	The system is not set to the Bluetooth® audio mode.	Push <AUDIO> and select the Bluetooth® audio mode.  "Selecting audio source" (page 3-8)	
	A Bluetooth® adapter is turned off.	Turn on a Bluetooth® adapter when it is used for a Bluetooth® audio device.	
Playback stops.	The Bluetooth® audio device is not compatible with the in-vehicle audio system.	Use a device compatible with the system. ASK a NISSAN dealer for information regarding model compatibility.	
	A cellular call is active.	This is not a malfunction.	
	Sound may cut out when a Bluetooth® audio device is operated.	Push <AUDIO> and select the Bluetooth® audio mode, and then operate a function on the touch screen display of the in-vehicle system instead of conducting the operation on the Bluetooth® audio device.	

8. Troubleshooting guide



Symptom	Possible cause	Possible solution
Audio operation cannot be performed.	A Bluetooth® audio device that does not support audio operations is in use.	Use a device compatible with the system. Ask a NISSAN dealer for information regarding model compatibility.
	An error occurs when connecting to a Bluetooth® audio profile.	Turn the power source of the Bluetooth® audio player off and on, and then resume connection with the system.

8. Troubleshooting guide

BLUETOOTH® HANDS-FREE PHONE SYSTEM

Symptom	Possible cause	Possible solution
A cellular phone cannot be registered.	The cellular phone is not compatible with the in-vehicle hands-free phone system.	Use a cellular phone compatible with the system. Ask a NISSAN dealer for information regarding model compatibility.
	Registration of the cellular phone has been performed incorrectly.	Check the registration procedure, and then register the cellular phone again.
A cellular phone cannot be connected or is disconnected after the registration is completed.	The Bluetooth® setting of the in-vehicle hands-free phone system is turned off.	Turn on the Bluetooth® setting of the system.
	The Bluetooth® setting of the cellular phone is turned off.	Turn on the Bluetooth® setting of the cellular phone.
	The remaining battery level of the cellular phone is low.	Charge the battery of the cellular phone.
	The wireless Bluetooth® connection may be disrupted depending on the location of the cellular phone.	Do not place the cellular phone in an area surrounded by metal or far away from the in-vehicle hands-free phone system. Do not place the cellular phone close to the seats or your body.
	Registration of the cellular phone is not completed.	Perform registration of the cellular phone.
A call to a particular phone number fails.	If the system tries to make a call several times to the same phone number (for example: the party does not respond to the call, the party is out of the service area, or the call is abandoned before the party responds), the system may reject a request to make a call to the phone number.	Turn off the cellular phone and turn it on again to reset the connection.



8. Troubleshooting guide

Symptom	Possible cause	Possible solution
The system does not recognize the connection of a cellular phone. The system does not receive or make a call.	The cellular phone is not compatible with the in-vehicle hands-free phone system.	Use a cellular phone compatible with the system. Ask a NISSAN dealer for information regarding model compatibility.
	The cellular phone is not connected.	Check the registration procedure, and then register the cellular phone again.
	The phone operation is limited by the functions (such as dial lock, etc.) of the registered cellular phone.	Remove any settings that are limiting use of the cellular phone, and then perform registration again.
The other party cannot hear your voice. The other party can hear your voice, but it cracks or cuts out.	Mute function is enabled.	Verify mute function is disabled.
	The cellular phone is not connected.	Check the registration procedure, and then register the cellular phone again.
	The fan speed of the heater/air conditioner is too fast.	Decrease the fan speed of the heater/air conditioner.
	The ambient noise level is excessive. (For example: heavy rain, construction sites, inside a tunnel, oncoming vehicles, etc.)	Close the windows to shut out ambient noise.
	The noise generated by driving the vehicle is too loud.	Reduce the vehicle speed.
	The incoming voice volume is too loud/soft.	Adjust the volume using <VOL/ ⏻ > or < 🔊 > .
	The outgoing voice volume is too loud/soft.	Adjust the volume from volume adjustment screen.  "Volume and Beeps settings" (page 1-19)
The voice is cut out or noise is heard during a call.	The wireless Bluetooth® connection may be disrupted depending on the location of the cellular phone.	Do not place the cellular phone in an area surrounded by metal or far away from the in-vehicle hands-free phone system. Do not place a cellular phone close to the seats or your body.
When a cellular phone is operated to make a call, the hands-free function becomes unavailable.	Some models of a cellular phone do not switch to the hands-free mode when they are operated to make a call.	This is not a malfunction. Make another call using the hands-free function.
The other party's voice cannot be heard. There is no ringtone.	The volume level is set to the minimum.	Adjust the volume level.  "Volume and Beeps settings" (page 1-19)
	A cellular phone is not connected.	Check the registration procedure, and then register the cellular phone again.

8. Troubleshooting guide







Symptom	Possible cause	Possible solution
Each volume level (ringtone, incoming voice or outgoing voice) is different.	Each volume level is not adjusted properly.	Adjust each volume level properly.
The antenna display is different between the touch screen display and a cellular phone screen. Making or receiving a call is unavailable even though the antenna display shows that it is possible to do so.	The antenna display varies depending on the model of cellular phone.	This does not indicate a malfunction. The antenna display and remaining battery level shown on the touch screen display may be different from those shown on the cellular phone screen. Use them as a reference.
A voice cannot be heard clearly when using a cellular phone behind tall buildings.	Some structures such as tall buildings, etc. may cause irregular reflection of radio waves or completely shut out radio waves that are used for cellular phones.	Move to a place without tall buildings.
Noise is heard when using a cellular phone under/near areas of elevated railroads, high voltage electric power cables, traffic signals, neon billboards, etc.	Electromagnetic waves that are generated from radio devices may adversely affect the cellular phone.	This is not a malfunction.
Noise is heard in the sound from the audio system while using a cellular phone.	Radio waves that are generated from a cellular phone may adversely affect the sound from the audio system.	This is not a malfunction.
Sound skips or stutters.	The cellular phone may have turned on the wireless LAN (Wi-Fi).	Turn off the wireless LAN (Wi-Fi).
Phonebook cannot be downloaded.	An error occurred during the phone pairing process.	Please delete the Bluetooth® pairing information from both the cellular phone and vehicle system before registering it again.
	Phone does not support phonebook download function.	Use a cellular phone compatible with the system. Ask a NISSAN dealer for information regarding model compatibility.

Apple CarPlay (if equipped)



Symptom	Cause and Countermeasure
Cannot start Apple CarPlay though it is tethered to the vehicle.	The USB cable is not connected to the USB connection port. Properly connect the USB cable to the USB connection port.  "USB (Universal Serial Bus) connection port and AUX (auxiliary) input jack" (page 1-5)
	Use an Apple Lightning cable (Mfi certified) to connect your phone to the USB connection port and check that the cable is not broken.
	Apple CarPlay setting is not active on your iPhone. Turn on "CarPlay" on your iPhone.
	The device is not compatible with Apple CarPlay. Check the compatibility requirements.
Apple CarPlay performance decreases. For example, slow connectivity or slow application functionality. or An error message appears when trying to access features of Apple CarPlay. A blank screen appears when trying to access maps.	Confirm you have a compatible iPhone, a cellular connection and an active data plan.
	Use an Apple Lightning cable (Mfi certified) to connect your phone to the USB connection port.
	Phone's performance or cellular connection. Disconnect and reconnect your phone.
Cannot access Siri using  > on the steering wheel.	Phone's performance or cellular connection. Cycle phone power off/on to restart.
	The USB cable may not be properly connected. Disconnect and reconnect the USB cable.
	Siri setting is not enabled on the phone. Turn on Siri on your phone.
	Check that you are pushing and holding  > instead of just pushing the switch to initiate Siri operation.

8. Troubleshooting guide

Android Auto (if equipped)

Symptom	Cause and Countermeasure
Cannot start Android Auto though it is connected to the vehicle.	The USB cable is not connected to the USB connection port. Properly connect the USB cable to the USB connection port.  "USB (Universal Serial Bus) connection port and AUX (auxiliary) input jack" (page 1-5)
	[Enable after USB Connection:] is set to [Never]. Change the setting to [Always] or [Ask].  "Android Auto settings" (page 5-14)
	To activate Android Auto, touch  on the Launch Bar or touch [Apps] on the information screen and then touch [Android Auto].  "Selecting menu from Launch Bar" (page 1-6)  "Information menu" (page 5-2)
	The connected device is not compatible with Android Auto. Check the compatibility requirements.
	Your Android phone may not be recognized if its battery is low. Charge your Android phone then try again.
Android Auto performance decreases. For example, slow connectivity or slow application functionality. or An error message appears when trying to access features of Android Auto. A blank screen appears when trying to access maps.	Confirm you have a compatible Android phone, a cellular connection and an active data plan.
	Use the Android phone OEM cable to connect your phone to the USB connection port.
	Phone's performance or cellular connection. Disconnect and reconnect your phone.
	Phone's performance or cellular connection. Close all apps and restart them.
Cannot start voice operation using  > on the steering wheel.	The USB cable may not be properly connected. Disconnect and reconnect the USB cable.
	Voice operation can not be performed while driving. Turn on appropriate settings on your Android phone.
	Check that you are pushing and holding  > instead of just pushing the switch to initiate voice operation.



SIRI EYES FREE (if equipped)

Symptom	Cause and Countermeasure
Cannot access Siri Eyes Free using  on the steering wheel.	Check if a Bluetooth® connection is established between the iPhone and the system.
	Check if Siri is enabled on the device. On your phone, go to Siri setting.
	Check that Siri can be accessed from the device lock screen. This can be set in the settings menu of your phone.
Audio source does not change automatically to iPod or Bluetooth® Audio mode.	For best results, use the native music app. Performance of music control function while using Podcasts, Audiobook or other third party music apps may vary.
	For best results, play media already stored on your device. Streaming music or playback from cloud storage may degrade performance.
	Switch the source manually.  "Selecting audio source" (page 3-8)
Play, pause, next track, previous track or play timer does not work.	For best results, use the native music app. Performance of music control function while using Podcasts, Audiobook or other third party music apps may vary and is controlled by the device.
Cannot hear any music/audio being played back from a connected iPhone.	Check that the audio source is set to Bluetooth® Audio or iPod mode. A USB connection is required for iPod mode.
Models with navigation system: Cannot hear map turn-by-turn direction guidance from a connected iPhone.	Check that the audio source is set to Bluetooth® Audio or iPod mode. A USB connection is required for iPod mode.
Cannot receive text message notifications on the vehicle audio system.	Check if notification setting is enabled on your phone.
Cannot reply to text message notifications using Siri Eyes Free.	After receiving an incoming text message, follow the on-screen guidance. Push and hold  on the steering wheel for Siri Eyes Free operation. After Siri Eyes Free starts, speak an appropriate command to reply to the message using Siri Eyes Free.

8. Troubleshooting guide

NAVIGATION (if equipped)

BASIC OPERATIONS

Symptom	Possible cause	Possible solution
No image is displayed.	The brightness is at the lowest setting.	Adjust the brightness of the display.  "Display settings" (page 1-21)
	The display is turned off.	Push  to turn on the display.
The volume of the voice guidance is too high or too low.	The volume is not set correctly, or the voice guidance setting is turned off.	Adjust the volume of the voice guidance or turn on the voice guidance setting.  "Volume and Beeps settings" (page 1-19)
No map is displayed on the screen.	A screen other than a map screen is displayed.	Touch [Map] on the Launch Bar or push <MAP> .
The screen is too dim. The movement is slow.	The temperature in the interior of the vehicle is low.	Wait until the interior of the vehicle has warmed up.
Some pixels in the display are darker or brighter than others.	This condition is an inherent characteristic of liquid crystal displays.	This is not a malfunction.
Some menu items cannot be selected.	Some menu items become unavailable while the vehicle is driven.	Park the vehicle in a safe location, and then operate the navigation system.

VEHICLE ICON

Symptom	Possible cause	Possible solution
Names of roads and locations differ between 2D and 3D view.	This is because the quantity of the displayed information is reduced so that the screen does not become too cluttered. There is also a chance that names of the roads or locations may be displayed multiple times, and the names appearing on the screen may be different because of a processing procedure.	This is not a malfunction.
The location of the vehicle icon is misaligned from the actual position.	The vehicle was transported after the power switch was placed in the OFF position, for example, by a ferry or car transporter.	Drive the vehicle for a period of time on a road where Global Navigation Satellite System (GNSS) signals can be received.
	The position and direction of the vehicle icon may be incorrect depending on the driving environments and the levels of positioning accuracy of the navigation system.	This is not a malfunction. Drive the vehicle for a period of time to automatically correct the position and direction of the vehicle icon. ☞ "Current vehicle location" (page 6-48)
	Driving with tire chains or tires that have been replaced may result in an incorrect vehicle location display due to miscalculation by the speed sensor.	Drive the vehicle for a period of time (at approximately 30 km/h (19 MPH) for about 30 minutes) to automatically correct the vehicle icon position. If this does not correct the vehicle icon position, it is recommended you contact a NISSAN dealer.
	The map data has a mistake or is incomplete (the vehicle icon position is always misaligned in the same area).	Updated road information will be included in the next version of the map data. ☞ "How to update map data" (page 6-53)
When the vehicle is traveling on a new road, the vehicle icon is located on another road nearby.	Because the new road is not stored in the map data, the system automatically places the vehicle icon on the nearest road available.	Updated road information will be included in the next version of the map data. ☞ "How to update map data" (page 6-53)
The screen does not switch to the night screen even after turning on the headlights.	The daytime screen was set the last time the headlights were turned on.	Set the screen to the night screen mode using <*/> when turning on the headlights. ☞ "Display settings" (page 1-21)
The map does not scroll even when the vehicle is moving.	The current location map screen is not displayed.	Touch [Map] on the Launch Bar or push <MAP>.

8. Troubleshooting guide

Symptom	Possible cause	Possible solution
The vehicle icon is not displayed.	The current location map screen is not displayed.	Touch [Map] on the Launch Bar or push <MAP> .

ROUTE CALCULATION AND VISUAL GUIDANCE

Symptom	Possible cause	Possible solution
Waypoints are not included in the auto reroute calculation.	Waypoints that have been already passed are not included in the auto reroute calculation.	To go to that waypoint again, edit the route.
Route information is not displayed.	Route calculation has not yet been performed.	Set the destination and perform route calculation.
	The vehicle is not on the suggested route.	Drive on the suggested route.
	Route guidance is turned off.	Turn on route guidance.
	Route information is not provided for certain types of roads.	This is not a malfunction.
The auto reroute calculation (or detour calculation) suggests the same route as the one previously suggested.	Route calculations took priority conditions into consideration, but the same route was calculated.	This is not a malfunction.
A waypoint cannot be added.	Twenty waypoints are already set on the route, including ones that the vehicle has already passed.	A maximum of 20 waypoints can be set on the route. To go to 21 or more waypoints, perform route calculations multiple times as necessary.
The suggested route is not displayed.	Roads near the destination cannot be calculated.	Reset the destination to a main or ordinary road, and recalculate the route.
	The starting point and destination are too close.	Set a more distant destination.
	The starting point and destination are too far away.	Divide the trip by selecting one or two intermediate destinations, and perform route calculations multiple times.
	There are time restricted roads (by the day of the week, by time) near the current vehicle location or destination.	Select [Do Not Use Restriction Info] in the [Time Restricted Roads] setting. ☞ "Route Preference" (page 6-29)
A part of the route is not displayed.	The suggested route includes narrow streets.	This is not a malfunction.
The part of the route that the vehicle has already passed is deleted.	A route is managed by sections between waypoints. If the vehicle passed the first waypoint, the section between the starting point and the waypoint is deleted (it may not be deleted depending on the area).	This is not a malfunction.

8. Troubleshooting guide



Symptom	Possible cause	Possible solution
An indirect route is suggested.	If there are restrictions (such as one-way streets) on roads close to the starting point or destination, the system may suggest an indirect route.	Adjust the location of the starting point or destination.
	The system may suggest an indirect route because route calculation does not take into consideration some areas such as narrow streets.	Reset the destination to a main or ordinary road, and recalculate the route.
The landmark information does not correspond to the actual information.	This may be caused by insufficient or incorrect map data.	Updated information will be included in the next version of the map data.  "How to update map data" (page 6-53)
The suggested route does not exactly connect to the starting point, waypoints or destination.	There is no data for route calculation closer to these locations.	Set the starting point, waypoints and destination on a main road, and perform route calculation.

VOICE GUIDANCE

Symptom	Possible cause	Possible solution
Voice guidance is not available.	The vehicle has deviated from the suggested route.	Go back to the suggested route or request route calculation again.
	Voice guidance is turned off.	Turn on voice guidance.
	Route guidance is turned off.	Turn on route guidance.
The guidance content does not correspond to the actual road conditions.	The content of voice guidance may vary, depending on the types of intersections at which turns are made.	Follow all traffic rules and regulations.

8. Troubleshooting guide

TRAFFIC INFORMATION (if equipped)

Symptom	Possible cause	Possible solution
Traffic information is not displayed.	The traffic information setting is turned off.	Turn on the traffic information setting.  "Traffic information settings" (page 6-38)
	The vehicle is in an area where traffic information is not available.	Scroll to an area where traffic information is available.
	The map scale is set at a level where the icons cannot be displayed.	Check that the map scale is set at a level at which the icons can be displayed.  "Traffic information on map" (page 6-37)
The automatic detour route search setting is turned on, but the suggested detour route does not avoid congested areas.	A faster route was not found, based on the road network and traffic information available.	The automatic detour search is not intended for avoiding traffic jams. It searches for the fastest route taking conditions such as traffic jams into consideration. Follow the suggested route.  "Viewing traffic information" (page 6-36)
The route does not avoid a road section with traffic information stating that it is closed due to road construction.	The navigation system does not avoid roads under construction if the day and time of the actual roadwork differs from the one that was declared.	Observe the actual road conditions and follow the instructions on the road to make a detour when necessary. If the road is closed, use the detour function and set the detour distance to avoid the road section that is closed.

VOICE RECOGNITION (if equipped)

Symptom	Possible cause	Possible solution
The system does not operate or fails to interpret the command correctly.	The interior of the vehicle is too noisy.	Close the windows or have the other occupants be quiet.
	The fan speed of the heater/air conditioner is too fast.	Decrease the fan speed of the heater/air conditioner.
	The noise generated by driving the vehicle is too loud.	Reduce the vehicle speed.
	The voice command is spoken in a low voice.	Speak the command in a louder voice.
	The timing of speaking a command is too early.	Speak the command after confirming the following: a voice guidance is announced, a tone sounds, and an icon on the screen changes from gray to orange.
	The command is spoken too slowly.	Speak in a natural voice without pausing between words.
The system prompts to repeat a command.	Pronunciation is unclear.	Speak clearly.
	The command is spoken too late after the tone.	Speak the command within 5 seconds after confirming the following: a voice guidance is announced, a tone sounds, and an icon on the screen changes from gray to orange.
	An improper command is spoken.	Speak the command or a number that is displayed on the screen. Speak a command that is shown in the command list.
The system does not correctly recognize a number spoken.	Too many numbers are spoken at once.	Place a pause between the appropriate digits for correct recognition by the system. When speaking a phone number, place a pause between area codes, dial codes, etc.
USB memory device cannot be operated with voice commands.	Depending on the device, iPhone or iPod may be recognized as a USB memory device.	This is not malfunction.
The USB/iPod operation screen is grayed out.	The audio device is not connected.	Connect an audio device to the system.

8. Troubleshooting guide

Symptom	Possible cause	Possible solution
An error message is displayed when trying to select a track and operate USB/iPod.	The track information is being processed for registration by the system.	Song information will be loaded into the system when a new audio device is registered for the first time or when the song information in the pre-registered device has been changed. Please wait for the loading to complete which may take a few minutes to up to an hour.
	A number of songs exceeding the amount the device can contain are stored in the connected audio device.	Decrease the number of songs stored in the audio device.
	No song is stored in the audio device.	Store songs in the connected audio device. Storing songs with information such as artist name, album name, song name, playlist, etc., will make voice recognition song search available.

Number

2D map..... 6-3
 3D map..... 6-5

A

About route guidance..... 6-23
 Adjusting settings..... 1-9
 Android Auto..... 5-11
 Apple CarPlay..... 5-7
 Audio main buttons..... 3-7
 Audio operation precautions..... 3-2
 Audio operations..... 3-8
 Automatic map update..... 6-55
 AUX (auxiliary) input jack..... 1-5
 Auxilliary (AUX) devices..... 3-24

B

Bluetooth® audio..... 3-6, 3-21
 Bluetooth® Hands-Free
 Phone System..... 4-2
 Building graphics..... 6-5

C

Canceling route..... 6-28
 Changing map..... 6-6
 Changing order of destination
 and waypoints..... 6-34
 Changing scale of map..... 6-6
 Charging station information..... IT-2

Clock settings..... 1-20
 Compressed audio
 files (MP3/WMA/AAC)..... 3-4
 Connecting Bluetooth®
 Hands-Free Phone..... 4-4
 Connectings settings..... 1-16
 Control buttons and touch
 screen display..... 1-2
 Control panel..... 1-2
 Current location map screen..... 6-12
 Current vehicle location..... 6-48

D

Deleting stored item..... 6-43
 Destination out of range guidance..... 2-9
 Destination setting menu..... 6-13
 Displaying charging station icons
 on map..... 2-5
 Displaying estimated driving range.... 2-3
 Displaying navigation screen..... 6-2
 Driving range..... IT-2
 During a call..... 4-5

E

Editing route..... 6-32
 Editing stored information..... 6-40
 Energy usage
 information display..... IT-3, 2-6
 EV Info menu screen..... 2-2

F

Finding address..... 6-16
 Finding charging station..... 6-19
 Finding points of interest..... 6-16
 Functions disabled while driving..... 1-13

G

Giving voice commands..... 7-2

H

Hands-free text
 messaging assistant..... 4-6
 How to see voice command screen... 7-3

I

Information menu..... 5-2
 iPod player..... 3-18

L

Launch Bar..... 1-6
 Li-ion battery
 information guidance..... 2-9
 Licenses..... 0-5
 Liquid crystal display..... 1-3
 Low Battery..... 2-9

9. Index

M

Making a call.....	4-4
Map Menu screen.....	6-12
Map types.....	6-3
Map view settings.....	6-8
Moving map.....	6-5

N

Navigation screen.....	6-2
Navigation settings.....	6-45
NissanConnect Services.....	5-6
Number input screen.....	1-11

O

One Shot Call.....	7-3
Online Search.....	6-15
Options before starting the route guidance.....	6-22
Out of charging range alert.....	2-9

P

Phone.....	4-4
Phone operation.....	5-13
Phone selection.....	4-4
Phone settings.....	4-10

Q

Quick Dial.....	4-12
-----------------	------

R

Radio.....	3-2, 3-10
Recalculating route.....	6-32
Receiving a call.....	4-5
Route calculation.....	6-51
Route guidance.....	6-23, 6-52
Route menu.....	6-25

S

Safety information.....	0-3, 6-2
Scrolled location map screen.....	6-13
Searching from Address Book.....	6-18
Searching from previous destinations.....	6-18
Setting by phone number.....	6-19
Setting destinations by Google.....	6-20
Setting detour route.....	6-28
Setting from stored routes.....	6-20
Setting home as destination.....	6-16
Setting information on map.....	6-11
Setting point on map.....	6-20
Setting work location as destination.....	6-16
Settings menu.....	1-14
Siri Eyes Free.....	5-15
Siri operation.....	5-8
Split screen.....	6-7

Start-up screen.....	1-6
Starting system.....	1-6
Steering wheel controls for audio.....	3-7
Steering wheel switches.....	1-4
Storing a location/route.....	6-38
Storing avoid area.....	6-40
Storing home location.....	6-38
Storing location.....	6-38
Storing route.....	6-39
System settings.....	1-14
System voice settings.....	7-5

T

Telematics service.....	IT-3
Text message settings.....	4-10
Touch panel operation.....	1-7
Trademarks.....	0-5
Traffic information settings.....	6-38
Turn list.....	6-25

U

Unique EV function settings.....	2-7
Unique EV functions.....	IT-2
USB (Universal Serial Bus) connection port.....	1-5, 3-3
USB memory device care.....	3-27
USB memory device player.....	3-15

V

Viewing energy usage information..... 2-6
Viewing traffic information..... 6-36
Voice Prompt Interrupt..... 7-3
Voice recognition..... 7-2
Volume settings..... 1-19