

# Foreword

This manual was prepared to help you understand the operation and maintenance of your vehicle so that you may enjoy many kilometers (miles) of driving pleasure. Please read through this manual before operating your vehicle.

A separate Warranty Information & Maintenance Booklet explains details about the warranties covering your vehicle.

Your NISSAN dealer knows your vehicle best. When you require any service or have any questions, we will be glad to assist you with the extensive resources available for you.

## IMPORTANT SAFETY INFORMATION

### Reminders for safety!

Follow these important driving rules to help ensure a safe and complete trip for you and your passengers!

- **NEVER drive under the influence of alcohol or drugs.**
- **ALWAYS observe posted speed limits and never drive too fast for conditions.**
- **ALWAYS use your seat belts and appropriate child restraint systems. Preteen children should be seated in the rear seat (if equipped).**
- **ALWAYS provide information about the proper use of vehicle safety features to all occupants of the vehicle.**
- **ALWAYS review this Owner's Manual for important safety information.**

## When reading the manual

This manual includes information for all options available on this model. Therefore, you may find some information that does not apply to your vehicle.

Throughout this manual, some illustrations may only show the layout for Right-Hand Drive (RHD) models. For Left-Hand Drive (LHD) models, the illustrated shape and location of some components may differ.

All information, specifications and illustrations in this manual are those in effect at the time of printing. NISSAN reserves the right to change specifications or designs without notice and without obligation.

## MODIFICATION OF YOUR VEHICLE

This vehicle should not be modified. Modification could affect its performance, safety or durability, and may even violate governmental regulations. In addition, damage or performance problems resulting from modifications may not be covered under NISSAN warranties.

## Read first — then drive safely

Before driving your vehicle, read this Owner's Manual carefully. This will ensure familiarity with controls and maintenance requirements, assisting you in the safe operation of your vehicle.

Throughout this manual we have used the symbol  followed by the word **WARNING**. This is used to indicate the presence of a hazard that could cause death or serious personal injury. To avoid or reduce the risk, the procedures must be followed precisely.

The symbol  followed by the word **CAUTION** is also used throughout this manual to indicate the presence of a hazard that could

cause minor or moderate personal injury or damages to your vehicle. To avoid or reduce the risk, the procedures must be followed carefully.

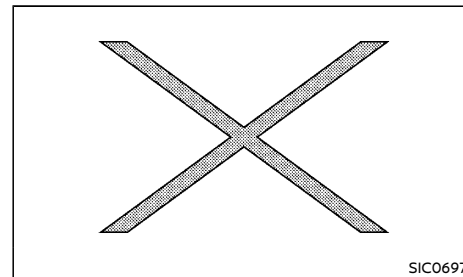

If you see this symbol, it means **“Do not do this”** or **“Do not let this happen”**.

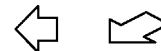

If you see a symbol similar to these in an illustration, it means the arrow points to the front of the vehicle.



Arrows in an illustration that are similar to these indicate movement or action.



Arrows in an illustration that are similar to these call attention to an item in the illustration.

**Air bag warning labels (if equipped):**



“NEVER use a rearward facing child restraint on a seat protected by an ACTIVE AIRBAG in front of it, DEATH or SERIOUS INJURY to the CHILD can occur.”

Be sure to read “Air bag warning labels” (P.1-28).

**ON-PAVEMENT AND OFF-ROAD DRIVING**

This vehicle will handle and maneuver differently from an ordinary passenger car, because it has a higher center of gravity. As with other vehicles with features of this type, failure to operate this vehicle correctly may result in loss of control or an accident.

Be sure to read “On-pavement and off-road driving precautions” (P.5-7).

Bluetooth® is a trademark owned by Bluetooth SIG, Inc. and licensed to Visteon Corporation and Robert Bosch GmbH.



© 2018 NISSAN MOTOR CO., LTD.

# Table of Contents

<b>Illustrated table of contents</b>	<b>0</b>
<b>Safety – seats, seat belts and supplemental restraint system</b>	<b>1</b>
<b>Instruments and controls</b>	<b>2</b>
<b>Pre-driving checks and adjustments</b>	<b>3</b>
<b>Monitor, air conditioner, audio and phone system</b>	<b>4</b>
<b>Starting and driving</b>	<b>5</b>
<b>In case of emergency</b>	<b>6</b>
<b>Appearance and care</b>	<b>7</b>
<b>Maintenance and do-it-yourself</b>	<b>8</b>
<b>Technical information</b>	<b>9</b>
<b>Index</b>	<b>10</b>



# 0 Illustrated table of contents

Seats, seat belts and Supplemental Restraint System (SRS) .....	0-2	Instrument panel .....	0-8
Exterior front .....	0-3	Left-Hand Drive (LHD) model .....	0-8
Exterior rear .....	0-4	Right-Hand Drive (RHD) model .....	0-9
Passenger compartment .....	0-5	Meters and gauges .....	0-11
Cockpit .....	0-6	Engine compartment .....	0-12
Left-Hand Drive (LHD) model .....	0-6	QR25DE engine .....	0-12
Right-Hand Drive (RHD) model .....	0-7	YD25DDTi engine .....	0-13
		YS23DDT/DDTT engine .....	0-14

## SEATS, SEAT BELTS AND SUPPLEMENTAL RESTRAINT SYSTEM (SRS)

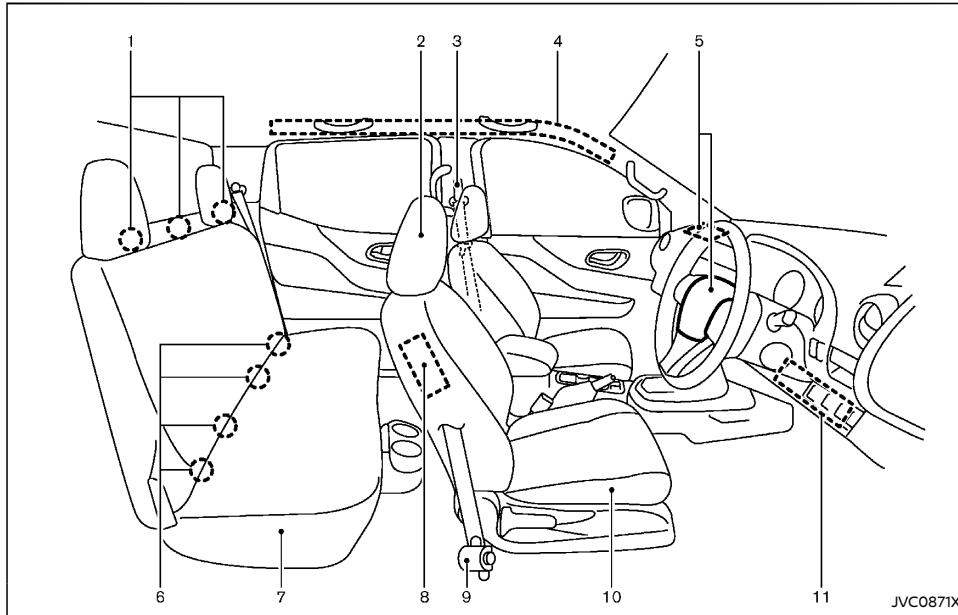

- |   |  |
|---|--|
| 1. Child restraint anchor point* (for top tether strap child restraint) (Page 1-17) | 8. Supplemental side-impact air bags* (P.1-25)   |
| 2. Head restraints (P. 1-6)   | 9. Pre-tensioner seat belt system* (P.1-34)      |
| 3. Seat belts (P.1-8)   | 10. Front seats (P.1-2)                          |
| 4. Supplemental curtain side-impact air bags* (P.1-25)                              | 11. Supplemental driver's knee air bag* (P.1-25) |
| 5. Supplemental front-impact air bags* (P.1-25)                                     | *: if equipped                                   |
| 6. ISOFIX child restraint system* (P.1-16)  |  |
| 7. Rear seats* (P.1-5) or Jump seat* (P.1-6)  |  |

## EXTERIOR FRONT

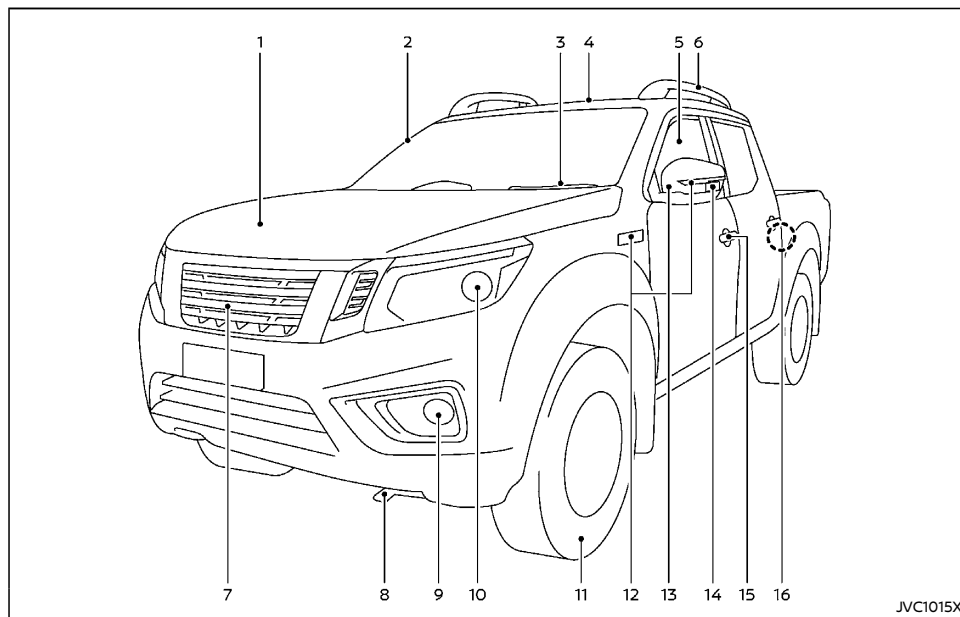

- |   |   |
|---|---|
| 1. Hood (P.3-16)  | 7. Front view camera*1 (P.4-13)   |
| 2. Antenna*1 (P.4-76)   | 8. Towing hook*2 (P.6-14)   |
| 3. Windshield wipers and washers<br>– Switch operation (P.2-37)<br>– Wiper blade replacement (P.8-18)<br>– Window washer fluid (P.8-20) | 9. Front fog lights*1 or Daytime running lights*1<br>– Switch operation (P.2-34, P.2-36)<br>– Bulb replacement (P.8-26) |
| 4. Sunroof*1 (P.2-41)   | 10. Headlights and turn signal lights<br>– Switch operation (P.2-33)<br>– Bulb replacement (P.8-26)                     |
| 5. Windows (P.2-39)   |   |
| 6. Roof rack*1 (P.2-45)   |   |

- |  |  |
|--|--|
| 11. Tires<br>– Tires and wheels (P.8-32)<br>– Flat tire (P.6-2)<br>– Specifications (P.9-7)<br>– Four-Wheel Drive (4WD)*1 (P.5-17)                                   | 12. Side turn signal lights (fender or outside rearview mirror)<br>– Bulb replacement (P.8-26) |
| 13. Outside rearview mirrors (P.3-24)  | 14. Side view camera*1 (P.4-13)  |
| 15. Doors<br>– Keys (P.3-2)<br>– Door locks (P.3-4)<br>– Remote keyless entry system*1 (P.3-6)<br>– Intelligent Key system*1 (P.3-7)<br>– Security system*1 (P.3-15) | 16. Child safety rear door locks*1 (P.3-5)   |

\*1: if equipped

\*2: The layout illustrated is for the Right-Hand Drive (RHD) model. On the Left-Hand Drive (LHD) model, the towing hook is located on the opposite side.

## EXTERIOR REAR

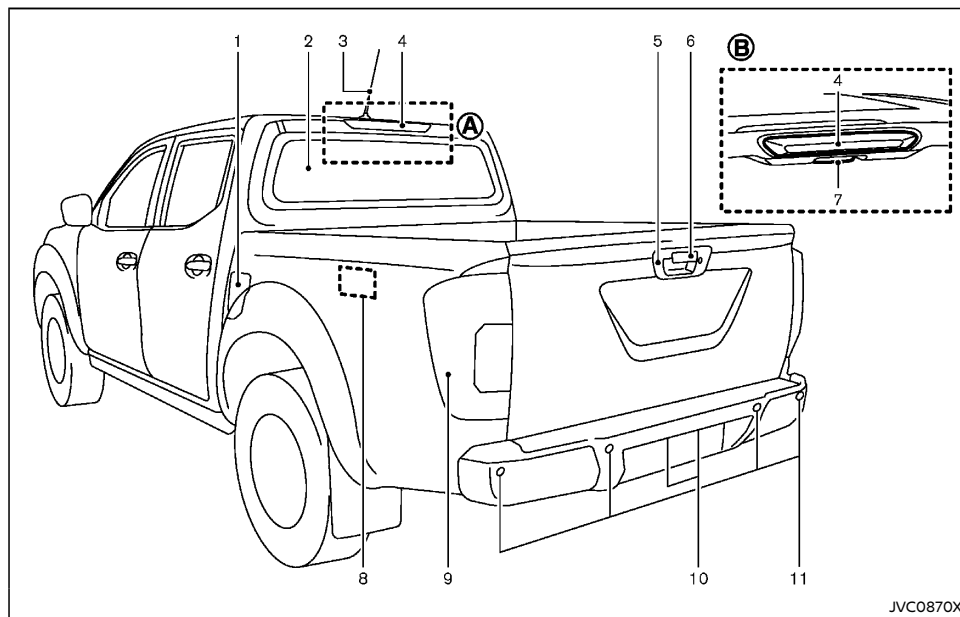

- |   |   |
|---|---|
| 1. Fuel-filler lid* or Fuel-filler cap* (P.3-17)<br>— Fuel information (P.9-2)          | 6. Truck box* (P.3-19)  |
| 2. Rear window defogger* (P.2-38)/Auto<br>slide back window system* (P.2-41)            | 7. Cargo light* (P.8-26)<br>— Switch operation (P.2-37)                               |
| 3. Antenna* (P.4-76)  | 8. Power outlet* (P.2-42)   |
| 4. High-mounted stop light*<br>(P.8-26)   | 9. Rear combination lights (bulb replace-<br>ment) (P.8-26)                           |
| 5. Rear view camera*<br>— Rear view monitor* (P.4-7)<br>— Around View Monitor* (P.4-13) | 10. License plate lights (bulb replacement)<br>(P.8-26)                               |
|   | 11. Parking sensor (sonar)* (P.5-31)  |
|   | Ⓐ: Except for Sportech models (for Thailand)<br>and SPORT EDITION models (for Philip- |

pires)

Ⓑ: For Sportech models (for Thailand) and  
SPORT EDITION models (for Philippines)

\*: if equipped



## PASSENGER COMPARTMENT

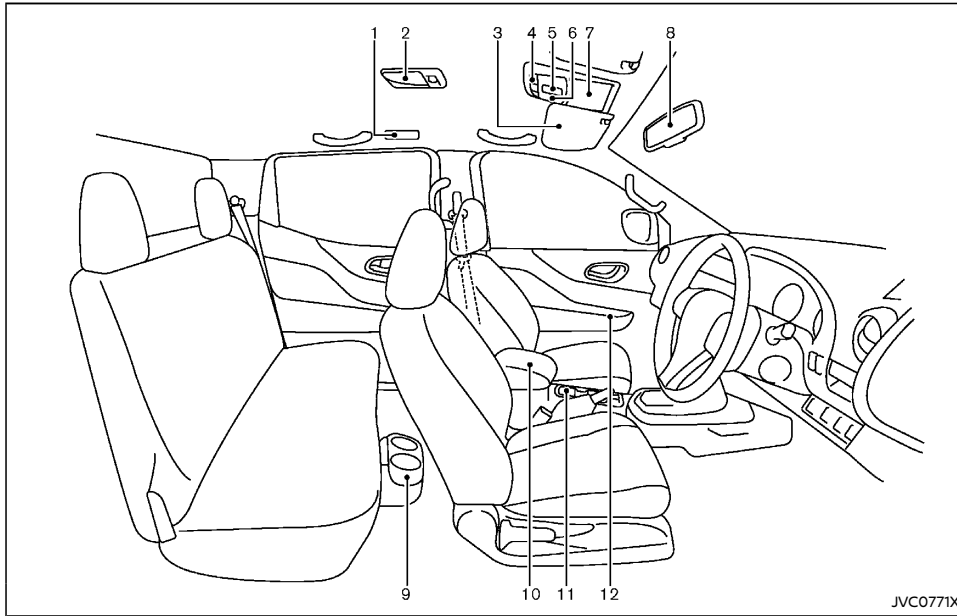

1. Rear personal light\* (P.2-48)
2. Room light\* (P.2-48)
3. Sun visors (P.2-46)
4. Map lights (P.2-47)
5. Sunroof switch\* (P.2-41)
6. Microphone\*  
– Bluetooth® Hands-Free Phone System\* (P.4-77, P.4-83, P.4-87 or \*\*)
7. Sunglasses holder\* (P.2-44)
8. Inside rearview mirror (P.3-23)  
– Compass\* (P.2-11)  
– Rear view monitor\* (P.4-7)  
– Around View Monitor\* (P.4-13)
9. Rear cup holders\* (P.2-44)
10. Console box\* (P.2-44)  
– Power outlet (P.2-42)
11. Cup holders\* (P.2-44)
12. Door armrest  
– Power window controls\* (P.2-39)

- Power door lock switch (driver's door)\* (P.3-5)
- Outside rearview mirror remote control switch (driver's door)\* (P.3-24)

\*: if equipped

\*\* : See the separate NissanConnect Owner's Manual (if equipped).

## COCKPIT

### LEFT-HAND DRIVE (LHD) MODEL

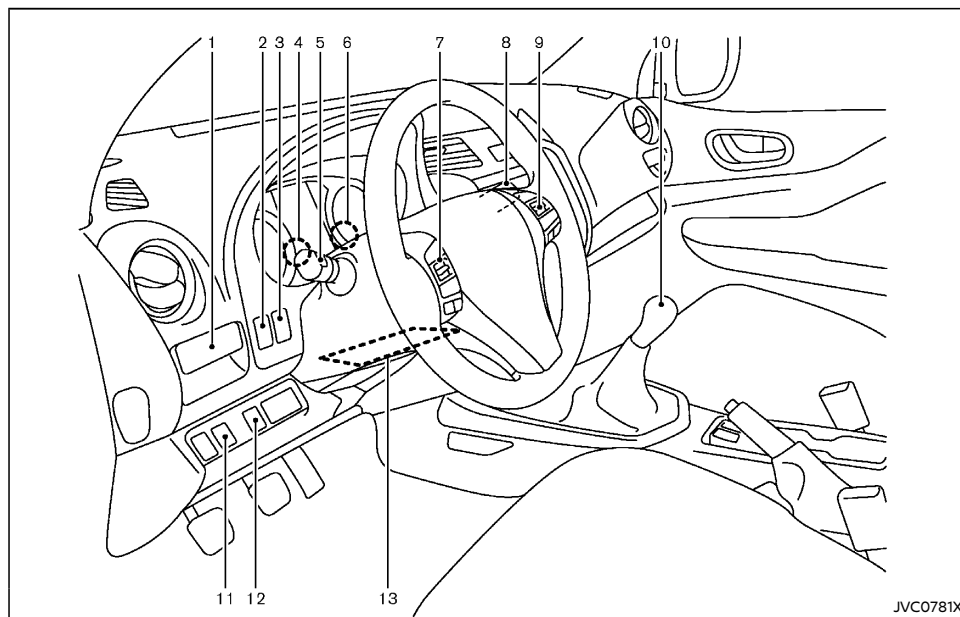

1. Cup holder (P.2-44)
2. Instrument brightness control switch (models with color display) (P.2-10)
3. TRIP/RESET switch for twin trip odometer (models with color display) (P.2-8)
4. Instrument brightness control switch (P.2-10)/Trip computer mode switch (models without color display) (P.2-31)
5. Headlight, fog light and turn signal switch
  - Headlight (P.2-33)
  - Turn signal (P.2-35)
  - Fog light\* (P.2-36)
6. TRIP/RESET switch for twin trip odometer (P.2-8)/Trip computer mode switch (models without color display) (P.2-31)
7. Steering-wheel-mounted controls\* (left side)

- Audio control steering switch\* (P.4-75 or \*\*)
  - Vehicle information display control switch\* (P.2-25)
8. Wiper and washer switch (P.2-37)
  9. Steering-wheel-mounted controls\* (right side)
    - Cruise control system\* (P.5-26)
    - Hands-Free Phone System switch\* (P.4-77, P.4-83 or \*\*)
    - Voice recognition system switch\*\*
  10. Shift lever
    - Automatic Transmission (AT) (P.5-14)
    - Manual Transmission (MT) (P.5-17)
  11. Vehicle Dynamic Control (VDC) OFF switch\* (P.5-23)
  12. Fuel-filler lid opener switch\* (P.3-17)
  13. Tilting steering wheel lever\* (P.3-23)
- \*: if equipped  
\*\*: See the separate NissanConnect Owner's Manual (if equipped).

## RIGHT-HAND DRIVE (RHD) MODEL

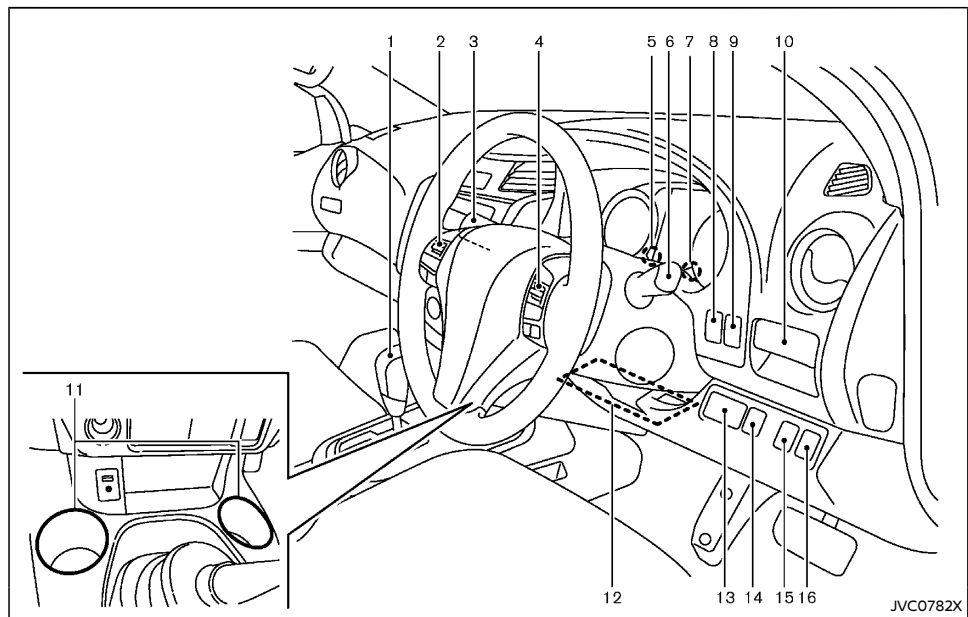

- |  |  |
|--|--|
| <p>1. Shift lever<br/>             – Automatic Transmission (AT) (P.5-14)<br/>             – Manual Transmission (MT) (P.5-17)</p> <p>2. Steering-wheel-mounted controls* (left side)<br/>             – Audio control steering switch* (P.4-75 or **)<br/>             – Vehicle information display control switch* (P.2-25)</p> | <p>3. Wiper and washer switch (P.2-37)</p> <p>4. Steering-wheel-mounted controls* (right side)<br/>             – Cruise control system* (P.5-26)<br/>             – Hands-Free Phone System switch* (P.4-77, P.4-83, P.4-87 or **)<br/>             – Voice recognition system switch**</p> <p>5. Instrument brightness control switch (P.2-10)/Trip computer mode switch (models without color display) (P.2-31)</p> |
|--|--|

6. Headlight, fog light and turn signal switch  
 – Headlight (P.2-33)  
 – Turn signal (P.2-35)  
 – Fog light\* (P.2-36)
7. TRIP/RESET switch for twin trip odometer (P.2-8)/Trip computer mode switch (models without color display) (P.2-31)
8. TRIP/RESET switch for twin trip odometer (models with color display) (P.2-8)
9. Instrument brightness control switch (models with color display) (P.2-10)
10. Cup holder\* (P.2-44)
11. Cup holder (for front bench seat models) (P.2-44)
12. Tilting steering wheel lever\* (P.3-23)
13. Auto slide back window switch\* (P.2-41)
14. Fuel-filler lid opener switch\* (P.3-17)
15. Vehicle Dynamic Control (VDC) OFF switch\* (P.5-23)
16. Headlight aiming control switch\* (P.2-34)
- \*: if equipped  
 \*\*: See the separate NissanConnect Owner's Manual (if equipped).

## INSTRUMENT PANEL

### LEFT-HAND DRIVE (LHD) MODEL

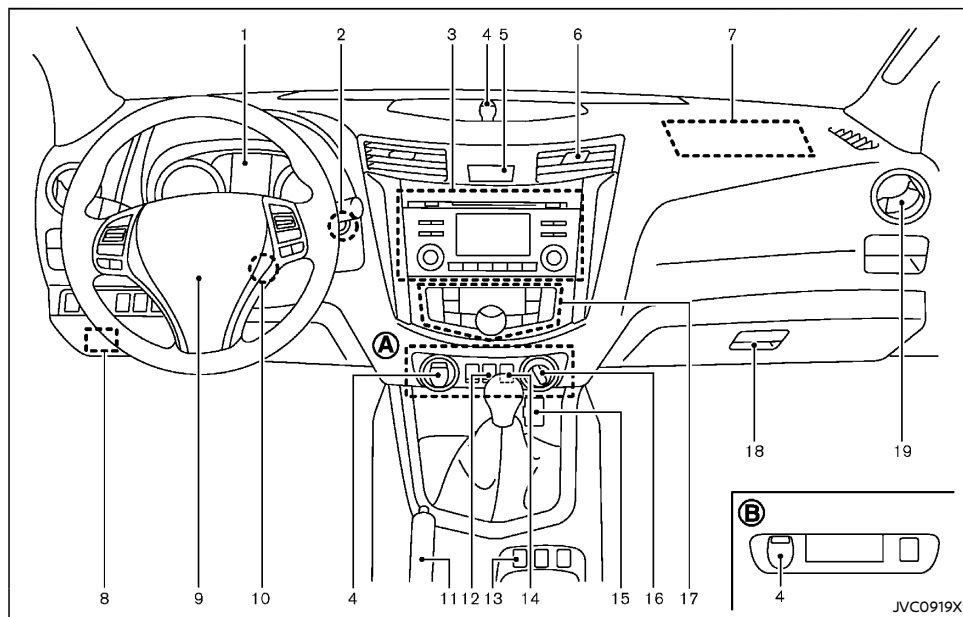

1. Meters and gauges (P.2-7)
  - Vehicle information display (P.2-20, P.2-30)
2. Push-button ignition switch (models with Intelligent Key system) (P.5-10)
3. Audio system\* (P.4-31 or \*\*)
  - Rear view monitor\* (P.4-7)
  - Around View Monitor\* (P.4-13)
4. Power outlet (P.2-42)
5. Hazard indicator flasher switch (P.6-2)
6. Center ventilator (P.4-20)
7. Front passenger's supplemental front-impact air bag\* (P.1-25)
8. Hood release handle (P.3-16)
9. Steering wheel
  - Horn (P.2-39)

- Driver's supplemental front-impact air bag\* (P.1-25)
  - Power steering (P.5-34)
  10. Ignition switch (models without Intelligent Key system) (P.5-9)
  11. Parking brake
    - Operation (P.3-25)
    - Check (P.8-15)
  12. Hill descent control switch\* (P.5-25)
  13. Cargo light switch\* (P.2-37)
  14. Differential lock mode switch\* (P.5-23)
  15. USB (Universal Serial Bus) connection port/iPod connection port (P.4-74 or \*\*)
    - Auxiliary (AUX) input jack (P.4-75 or \*\*)
  16. Four-Wheel Drive (4WD) mode switch\* (P.5-17)
  17. Heater and air conditioner control (P.4-21)
  18. Glove box (P.2-44)
    - Fuse box (P.8-25)
  19. Side ventilator (P.4-20)
- A: 4WD models  
B: 2WD models  
\*: if equipped  
\*\*: See the separate NissanConnect Owner's Manual (if equipped).

## RIGHT-HAND DRIVE (RHD) MODEL

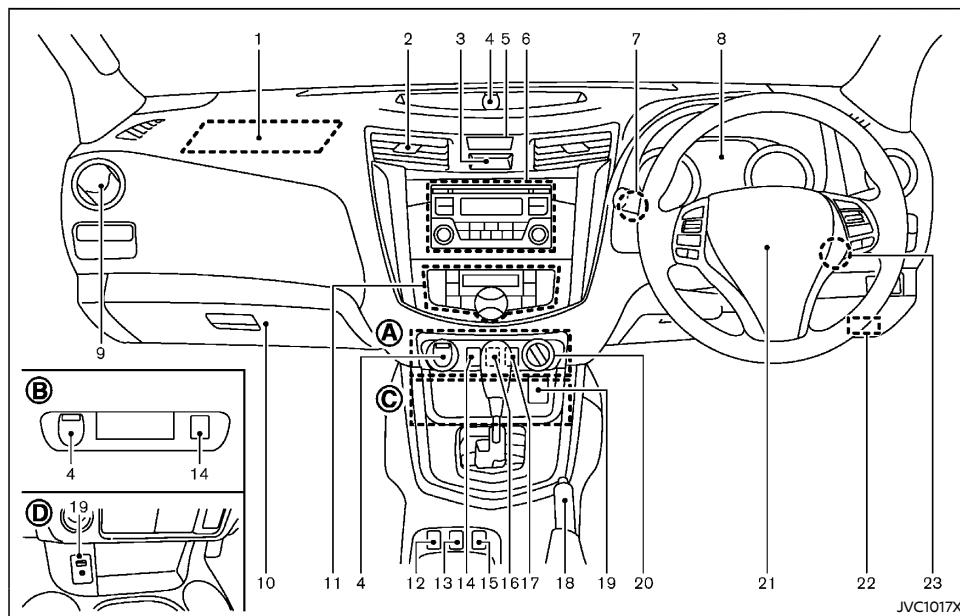

- |   |  |   |
|---|--|---|
| <ol style="list-style-type: none"> <li>1. Front passenger's supplemental front-impact air bag* (P.1-25)</li> <li>2. Center ventilator (P.4-20)</li> <li>3. Hazard indicator flasher switch (P.6-2)</li> <li>4. Power outlet (P.2-42)</li> <li>5. Rear seat belt warning light* (P.2-17)</li> <li>6. Audio system* (P.4-31 or ***) or Navigation system** or ***<br/>— Rear view monitor* (P.4-7)</li> </ol> | <ol style="list-style-type: none"> <li>7. Push-button ignition switch (models with Intelligent Key system) (P.5-10)</li> <li>8. Meters and gauges (P.2-7)<br/>— Vehicle information display (P.2-20, P.2-30)</li> <li>9. Side ventilator (P.4-20)</li> <li>10. Glove box (P.2-44)<br/>— Fuse box (P.8-25)</li> </ol> | <ol style="list-style-type: none"> <li>11. Heater* and air conditioner control (P.4-21)</li> <li>12. Heated seat switch* (P.1-5)</li> <li>13. Diesel Particulate Filter (DPF) regeneration switch* (P.5-5)</li> <li>14. Parking sensor (sonar) system off switch* (P.5-31)</li> <li>15. Heated seat switch* (P.1-5) or Diesel Particulate Filter (DPF) regeneration switch* (P.5-5) or Cargo light switch* (P.2-37)</li> <li>16. Hill descent control switch* (P.5-25)</li> <li>17. Differential lock mode switch* (P.5-23)</li> <li>18. Parking brake<br/>— Operation (P.3-25)<br/>— Check (P.8-15)</li> <li>19. USB (Universal Serial Bus) connection port/iPod connection port* (P.4-74 or ***)<br/>— Auxiliary (AUX) input jack* (P.4-75 or ***)</li> <li>20. Four-Wheel Drive (4WD) mode switch* (P.5-17)</li> <li>21. Steering wheel<br/>— Horn (P.2-39)<br/>— Driver's supplemental front-impact air bag* (P.1-25)<br/>— Power steering (P.5-34)</li> <li>22. Hood release handle (P.3-16)</li> <li>23. Ignition switch (models without Intelligent Key system) (P.5-9)</li> </ol> |
|---|--|---|

- Ⓐ: 4WD models  
 Ⓑ: 2WD models  
 Ⓒ: Except for front bench seat models  
 Ⓓ: For front bench seat models

- \*: if equipped  
 \*\*: See the separate Navigation System Owner's Manual (if equipped).

\*\*\*: See the separate NissanConnect Owner's Manual (if equipped).

## METERS AND GAUGES

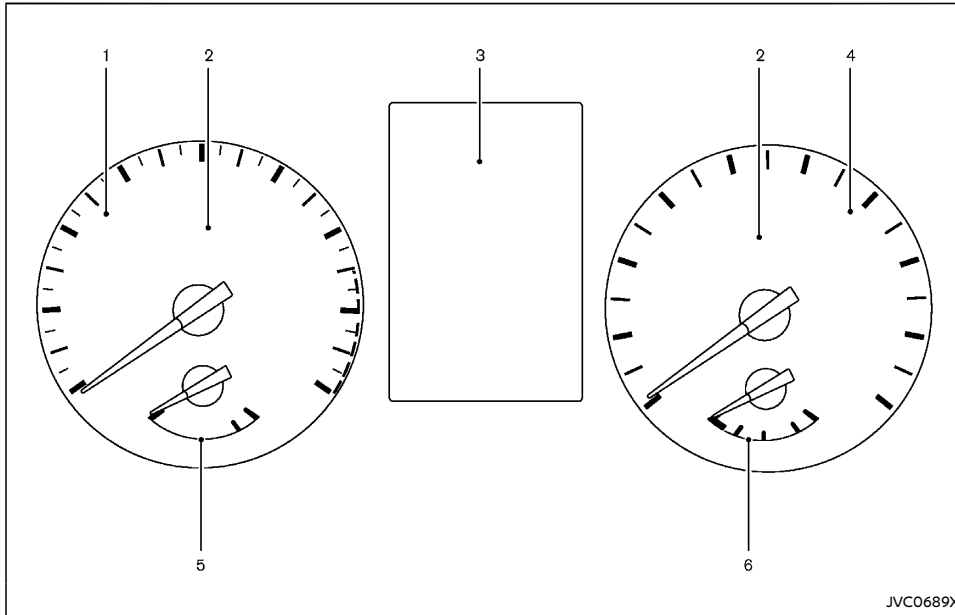

\*: if equipped

- |   |   |
|---|---|
| <ol style="list-style-type: none"> <li>1. Tachometer (P.2-8)</li> <li>2. Warning/Indicator lights (P.2-13)</li> <li>3. Vehicle information display (P.2-20, P.2-30)             <ul style="list-style-type: none"> <li>– Engine coolant temperature gauge (models without color display) (P.2-9)</li> <li>– Fuel gauge (models without color display) (P.2-9)</li> <li>– Four-Wheel Drive (4WD) mode indicator* (P.5-17)</li> <li>– Oil control system* (P.2-29, P.2-31)</li> </ul> </li> </ol> | <ul style="list-style-type: none"> <li>– Odometer/twin trip odometer (P.2-8)</li> <li>– Trip computer (P.2-25, P.2-31)</li> <li>– Instrument brightness control (P.2-10)</li> <li>– Automatic Transmission (AT) position indicator (AT model) (P.2-24, P.2-30, P.5-14)</li> <li>4. Speedometer (P.2-8)</li> <li>5. Engine coolant temperature gauge (models with color display) (P.2-9)</li> <li>6. Fuel gauge (models with color display) (P.2-9)</li> </ul> |
|---|---|

## ENGINE COMPARTMENT

### QR25DE ENGINE

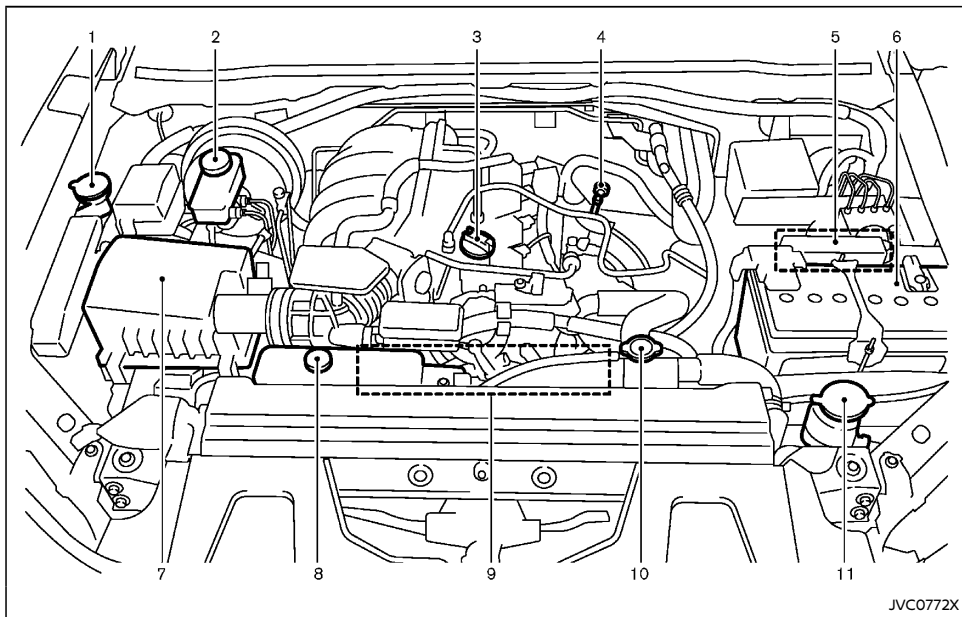

- |   |   |
|---|---|
| 1. Window washer fluid reservoir (P.8-20)     | 7. Air cleaner (P.8-18)                     |
| 2. Brake and clutch* fluid reservoir (P.8-16) | 8. Engine coolant reservoir (P.8-7)         |
| 3. Engine oil filler cap (P.8-9)              | 9. Engine drive belt location (P.8-14)      |
| 4. Engine oil dipstick (P.8-9)                | 10. Radiator filler cap (P.8-7)             |
| 5. Fuse/fusible link holder (P.8-24)          | — Vehicle overheat (P.6-11)                 |
| 6. Battery (P.8-21)                           | 11. Power steering fluid reservoir (P.8-18) |
| — Jump starting (P.6-7)                       | *: For Manual Transmission (MT) model       |



## YD25DDTi ENGINE

Drive (LHD) model, brake (and clutch) fluid reservoir is located on the opposite side.

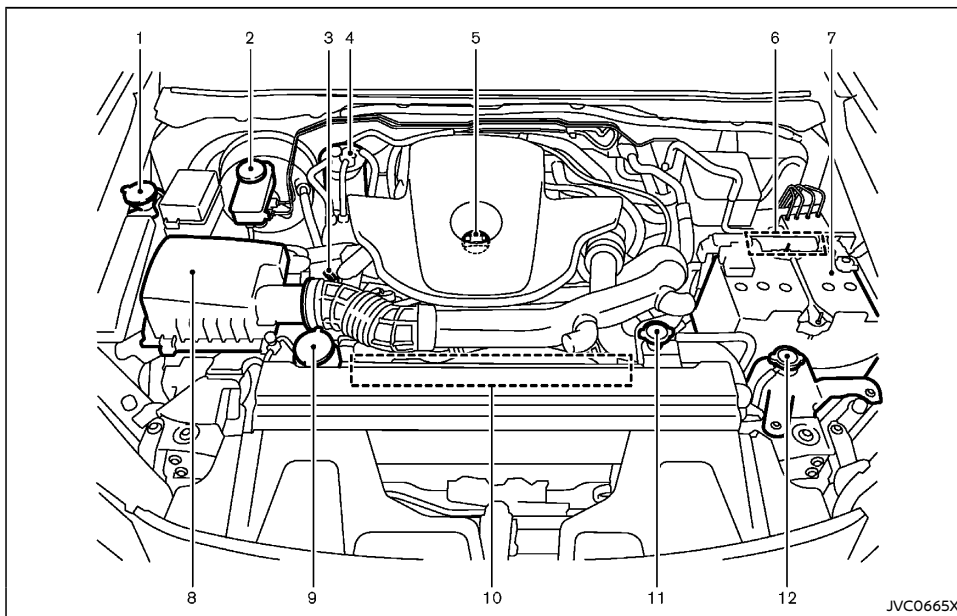

- |  |  |
|--|--|
| 1. Window washer fluid reservoir (P.8-20)        | 8. Air cleaner (P.8-18)  |
| 2. Brake and clutch*1 fluid reservoir*2 (P.8-16) | 9. Power steering fluid reservoir (P.8-18)   |
| 3. Engine oil dipstick (P.8-9)                   | 10. Engine drive belt location (P.8-14)  |
| 4. Fuel filter (P.8-13)                          | 11. Radiator filler cap (P.8-7)<br>— Vehicle overheat (P.6-11)                           |
| 5. Engine oil filler cap (P.8-9)                 | 12. Engine coolant reservoir (P.8-7)   |
| 6. Fuse/fusible link holder (P.8-24)             | *1: For Manual Transmission (MT) model   |
| 7. Battery (P.8-21)<br>— Jump starting (P.6-7)   | *2: The layout illustrated is for the Right-<br>Hand Drive (RHD) model. On the Left-Hand |

## YS23DDT/DDTT ENGINE

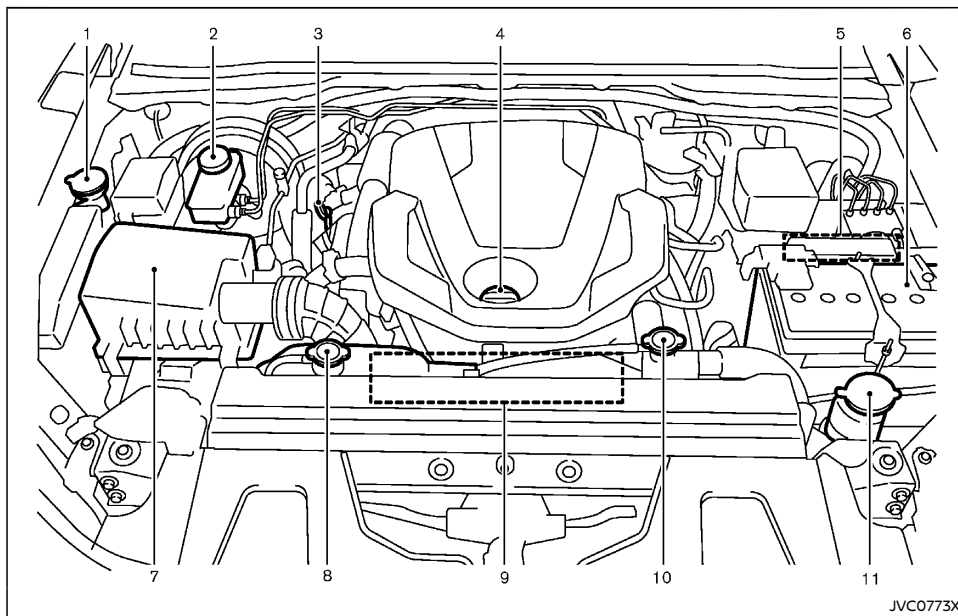

- |   |   |
|---|---|
| 1. Window washer fluid reservoir (P.8-20)     | 8. Engine coolant reservoir (P.8-7)         |
| 2. Brake and clutch* fluid reservoir (P.8-16) | 9. Engine drive belt location (P.8-14)      |
| 3. Engine oil dipstick (P.8-9)                | 10. Radiator filler cap (P.8-7)             |
| 4. Engine oil filler cap (P.8-9)              | — Vehicle overheat (P.6-11)                 |
| 5. Fuse/fusible link holder (P.8-24)          | 11. Power steering fluid reservoir (P.8-18) |
| 6. Battery (P.8-21)                           | *: For Manual Transmission (MT) model       |
| — Jump starting (P.6-7)                       |   |
| 7. Air cleaner (P.8-18)                       |   |

# 1 Safety — seats, seat belts and supplemental restraint system

Seats .....	1-2	Child restraints .....	1-13
Front seats .....	1-2	Precautions on child restraint usage .....	1-13
Rear seats (Double Cab model) .....	1-5	Universal child restraints for front seat and rear seats (Double Cab models) .....	1-14
Jump seat (if equipped for King Cab models) .....	1-6	ISOFIX child restraint system (if equipped) .....	1-16
Head restraints (if equipped) .....	1-6	Child restraint anchorage (if equipped) .....	1-17
Adjustable head restraint components .....	1-6	Child restraint installation using ISOFIX (if equipped) .....	1-18
Non-adjustable head restraint components .....	1-6	Child restraint installation using three-point type seat belt .....	1-19
Remove .....	1-7	Child restraint installation using two-point type seat belt (if equipped) .....	1-23
Install .....	1-7	Supplemental Restraint System (SRS) (if equipped) ....	1-25
Adjust .....	1-7	Precautions on Supplemental Restraint System (SRS) .....	1-25
Seat belts .....	1-8	Supplemental air bag systems .....	1-30
Precautions on seat belt usage .....	1-8	SRS air bag deployment conditions .....	1-31
Child safety .....	1-10	Pre-tensioner seat belt system (if equipped) .....	1-34
Pregnant women .....	1-10	Repair and replacement procedure .....	1-34
Injured persons .....	1-11		
Center mark on seat belts (if equipped) .....	1-11		
Three-point type seat belts .....	1-11		
Two-point type seat belts (if equipped) .....	1-12		
Seat belt maintenance .....	1-12		

## SEATS

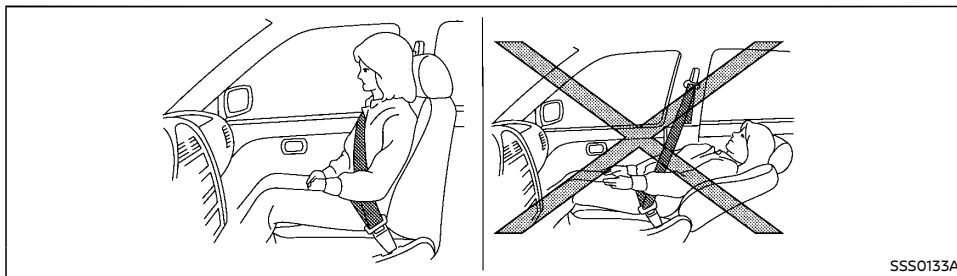

### **WARNING:**

- Do not drive and/or ride in the vehicle with the seatback reclined. This can be dangerous. The shoulder belt will not be properly against the body. In an accident, you and your passengers could be thrown into the shoulder belt and receive neck or other serious injuries. You and your passengers could also slide under the lap belt and receive serious injuries.
- For the most effective protection while the vehicle is in motion, the seatback should be upright. Always sit well back and upright in the seat and adjust the seat properly. (See "Seat belts" (P.1-8).)
- Do not leave children unattended inside the vehicle. They could unknowingly activate switches or controls. Unattended children could become involved in serious accidents.
- To help avoid risk of injury or death through unintended operation of the vehicle and/or its systems, do not leave children, people who require the assistance of others or pets unattended in

your vehicle. Additionally, the temperature inside a closed vehicle on a warm day can quickly become high enough to cause a significant risk of injury or death to people and pets.

### **CAUTION:**

When adjusting the seat positions, be sure not to contact any moving parts to avoid possible injuries and/or damages.

## FRONT SEATS

### **WARNING:**

Do not adjust the driver's seat while driving so that full attention may be given to vehicle operation.

Manual seat adjustment (if equipped)

### **WARNING:**

After adjusting a seat, gently shake the seat to confirm that the seat is locked securely. If the seat is not locked securely, it may move suddenly and could cause the loss of control of the vehicle.

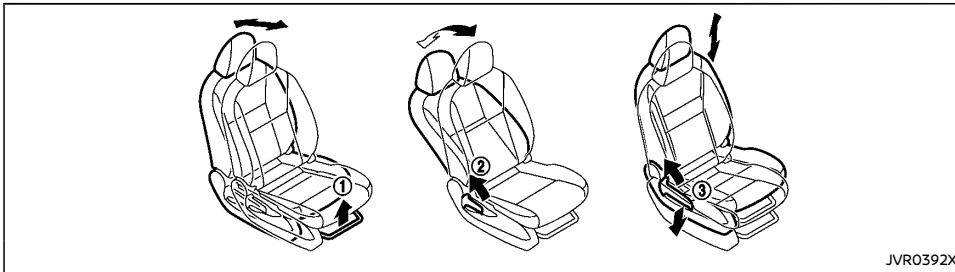

**Forward and backward:**

1. Pull up the adjusting lever ①.
2. Slide the seat to the desired position.
3. Release the adjusting lever to lock the seat in position.

**Reclining:**

1. Pull up the adjusting lever ②.
2. Tilt the seatback to the desired position.
3. Release the adjusting lever to lock the seatback in position.

The reclining feature allows the adjustment of the seatback for occupants of different sizes to help obtain the proper seat belt fit. (See "Seat belts" (P.1-8).)

The seatback may be reclined to allow occupants to rest when the vehicle is parked.

**Seat lifter (if equipped):**

Pull up or push down the adjusting lever ③ to adjust the seat height until the desired position is achieved.

**Reclining bench seat (front bench seat models)**

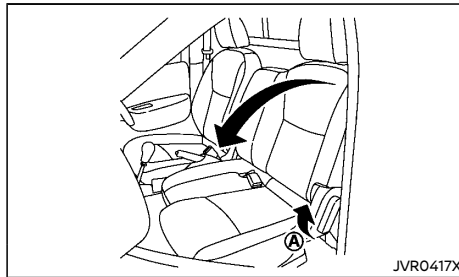

The bench seat can be reclined to make it easier to remove the jacking tools from the storage area. To recline the seatback, pull the lever up ①.

## Power seat adjustment (if equipped)

### Operating tips:

- The power seat motor has an auto-reset overload protection circuit. If the motor stops during the seat adjustment, wait 30 seconds, then reactivate the switch.
- To avoid discharge of the battery, do not operate the power seats for a long period of time when the engine is not running.

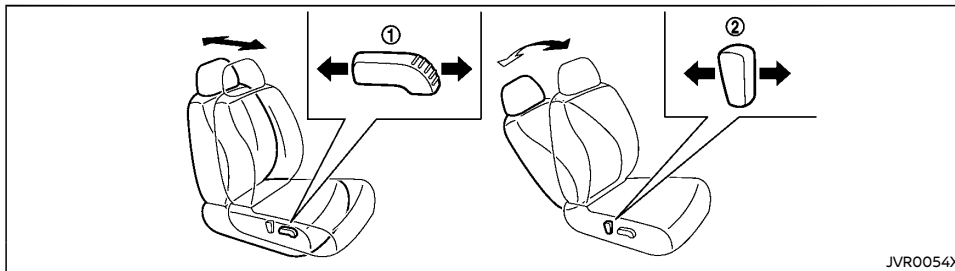

JVR0054X

### Forward and backward:

Move forward or backward the adjusting switch ① to the desired position.

### Reclining:

Move forward or backward the adjusting switch ② to the desired position.

The reclining feature allows the adjustment of the seatback for occupants of different sizes to help obtain the proper seat belt fit. (See "Seat belts" (P.1-8).)

The seatback may be reclined to allow occupants to rest when the vehicle is parked.



### WARNING:

**The seatback should not be reclined any more than needed for comfort. Seat belts are most effective when the passenger sits well back and straight up in the seat. If the seatback is reclined, the risk of sliding under the lap belt and being injured is increased.**

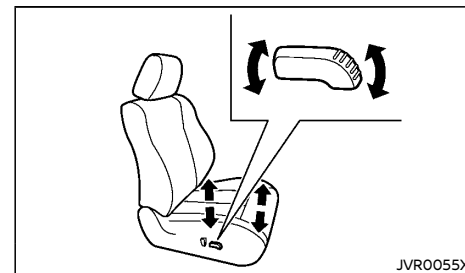

JVR0055X

### Seat lifter:

1. Pull up or push down the adjusting switch to adjust the seat height until the desired position is achieved.
2. Tilt up or down the adjusting switch to adjust the front angle of the seat until the desired position is achieved.

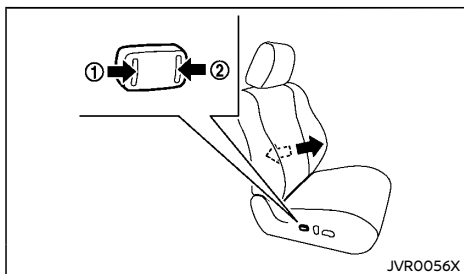

### Lumbar support:

The lumbar support feature provides lower back support to the driver.

Push each side of the adjusting switch ① and ② to adjust the seat lumbar area until the desired position is achieved.

### Heated seats (if equipped)

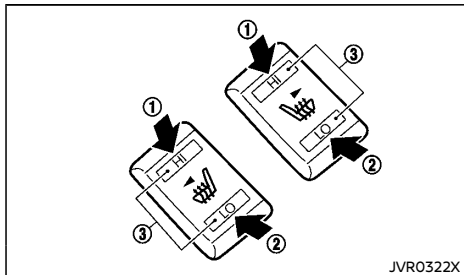

The front seats can be warmed by built-in heaters. The switches located on the center console can be operated independently of each other.

1. Start the engine.
2. Select heat range.
  - For high heat, push the HI (High) side of the switch ①.
  - For low heat, push the LO (Low) side of the switch ②.
  - The indicator light ③ will illuminate when the heater is on.
3. To turn off the heater, return the switch to the level position. Make sure the indicator light turns off.

The heater is controlled by a thermostat, automatically turning the heater on and off. The indicator light will remain on as long as the switch is on.

When the vehicle's interior is warmed, or before you leave the vehicle, be sure to turn off the switch.

### ⚠ CAUTION:

- **The battery could run down if the seat heater is operated while the engine is not running.**
- **Do not use the seat heater for extended periods or when no one is using the seat.**
- **Do not put anything on the seat which insulates heat, such as a blanket, cushion, seat cover, etc. Otherwise, the seat may become overheated.**
- **Do not place anything hard or heavy on the seat or pierce it with a pin or similar object. This may result in damage to the seat heater.**
- **Any liquid spilled on the heated seat should be removed immediately with a dry cloth.**

- **When cleaning the seat, never use gasoline, thinner, or any similar materials.**
- **If any malfunctions are found or the heated seat does not operate, turn the switch off and have the system checked by a NISSAN dealer.**

### REAR SEATS (Double Cab model)

#### Folding

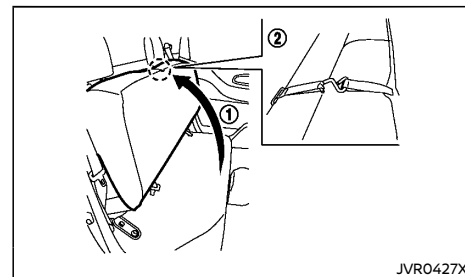

The jack and tools are stored in the tool storage compartment located under the rear seat cushion. To access the tool storage compartment, fold the rear seats in the following steps.

1. Lift up the seat cushion ①.
2. Secure the seat cushion with the strap ②.

To remove the jack and tools, see "Preparing tools" (P.6-2).

### Do not drive the vehicle with the rear seat folded.

When returning the rear seat to the original position, be certain the seat belts and the buckles are positioned properly. The strap can be stored in the pocket under the seat cushion.

## HEAD RESTRAINTS (if equipped)

### WARNING:

- Never allow anyone to ride on the rear seats when they are in the fold-up position. Use of this area by passengers without proper restraints could result in serious injury in an accident or sudden stop.
- When folding or returning the rear seat, be careful not to squeeze your finger between the seat cushion and the body side.

JUMP SEAT (if equipped for King Cab models)

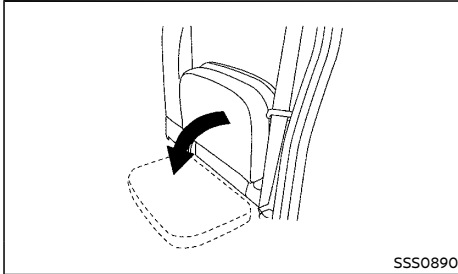

### WARNING:

- Do not use the jump seat for child restraint installation.
- When folding or returning the jump seat, be careful not to squeeze your finger between the seat cushion and the body side.

### WARNING:

Head restraints supplement the other vehicle safety systems. They may provide additional protection against injury in certain rear end collisions. Adjustable head restraints must be adjusted properly, as specified in this section. Check the adjustment after someone else uses the seat. Do not attach anything to the head restraint stalks or remove the head restraint. Do not use the seat if the head restraint has been removed. If the head restraint was removed, reinstall and properly adjust the head restraint before an occupant uses the seating position. Failure to follow these instructions can reduce the effectiveness of the head restraint. This may increase the risk of serious injury or death in a collision.

- Your vehicle is equipped with a head restraint that may be integrated, adjustable or non-adjustable.
- Adjustable head restraints have multiple notches along the stalk to lock them in a desired adjustment position.
- The non-adjustable head restraints have a single locking notch to secure them to the seat frame.
- Proper Adjustment:
  - For the adjustable type, align the head restraint so the center of your ear is approximately level with the center of the head restraint.
  - If your ear position is still higher than the recommended alignment, place the head restraint at the highest position.
- If the head restraint has been removed, ensure that it is reinstalled and locked in place before riding in that designated

seating position.

## ADJUSTABLE HEAD RESTRAINT COMPONENTS

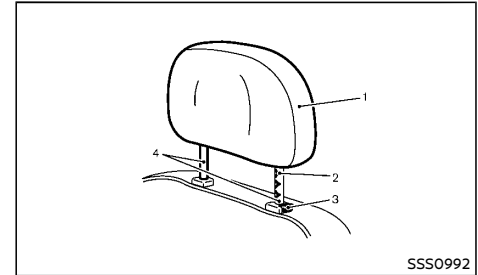

1. Removable head restraint
2. Multiple notches
3. Lock knob
4. Stalks

## NON-ADJUSTABLE HEAD RESTRAINT COMPONENTS

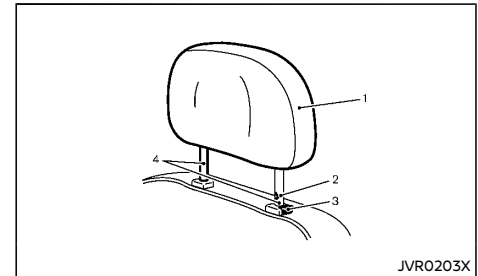

1. Removable head restraint



2. Single notch
3. Lock knob
4. Stalks

## REMOVE

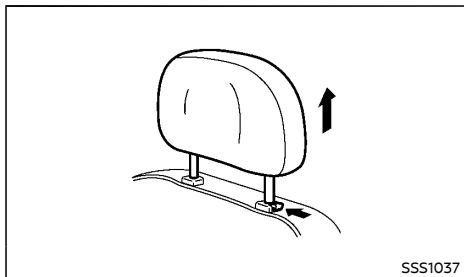

Use the following procedure to remove the head restraint.

1. Pull the head restraint up to the highest position.
2. Push and hold the lock knob.
3. Remove the head restraint from the seat.
4. Store the head restraint properly in a secure place so it is not loose in the vehicle.
5. Reinstall and properly adjust the head restraint before an occupant uses the seating position.

## INSTALL

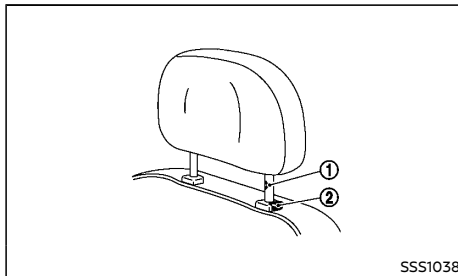

1. Align the head restraint stalks with the holes in the seat. Make sure that the head restraint is facing the correct direction. The stalk with the notch ① must be installed in the hole with the lock knob ②.
2. Push and hold the lock knob and push the head restraint down.
3. Properly adjust the head restraint before an occupant uses the seating position.

## ADJUST

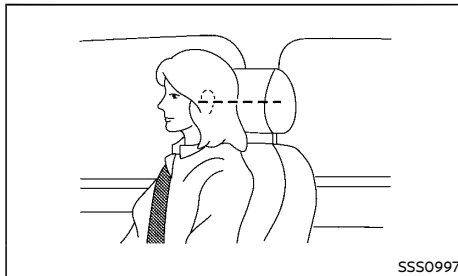

## For adjustable head restraint

Adjust the head restraint so the center is level with the center of your ears. If your ear position is still higher than the recommended alignment, place the head restraint at the highest position.

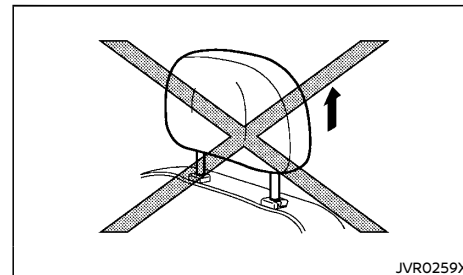

## For non-adjustable head restraint

Make sure the head restraint is positioned from the stored position or any non-latch position so the lock knob is engaged in the notch before riding in that designated seating position.

## Raise

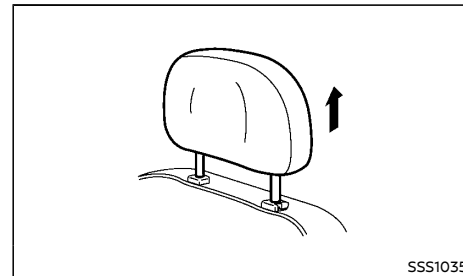

To raise the head restraint, pull it up.

## SEAT BELTS

Make sure the head restraint is positioned from the stored position or any non-latch position so the lock knob is engaged in the notch before riding in that designated seating position.

### Lower

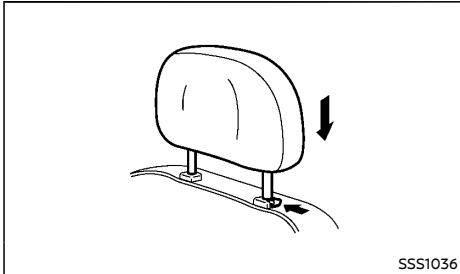

To lower, push and hold the lock knob and push the head restraint down.

Make sure the head restraint is positioned so the lock knob is engaged in the notch before riding in that designated seating position.

### PRECAUTIONS ON SEAT BELT USAGE

If you are wearing the seat belt properly adjusted and sitting upright and well back in the seat, chances of being injured or killed in an accident and/or the severity of injury may be greatly reduced. NISSAN strongly encourages you and all of your passengers to buckle up every time you drive, even if your seating position includes the supplemental air bag systems.

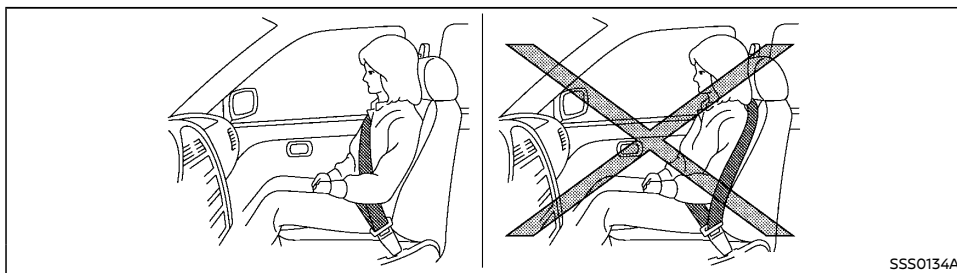

SSS0134A

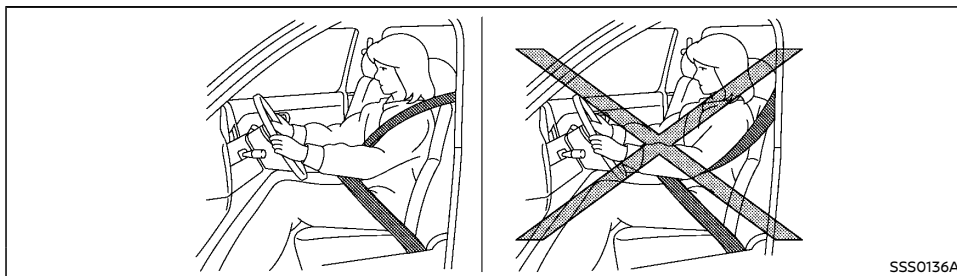

SSS0136A

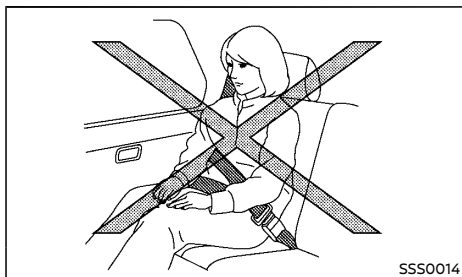

SSS0014

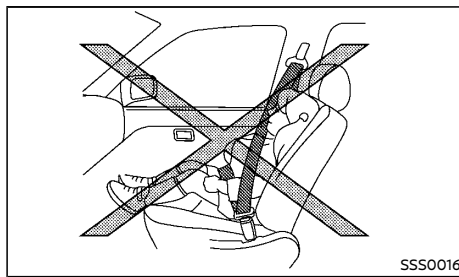

SSS0016

**⚠ WARNING:**

- Seatbelts are designed to bear upon the bony structure of the body, and should be worn low across the front of the pelvis or the pelvis, chest and shoulders, as applicable; wearing the lap section of the belt across the abdominal area must be avoided. Serious injury may occur if a seat belt is not worn properly.
- Position the lap belt as low and snug as possible around the hips, not the waist. A lap belt worn too high could increase the risk of internal injuries in an accident.
- Do not allow more than one person to use the same seat belt. Each belt assembly must only be used by one occupant; it is dangerous to put a belt around a child being carried on the occupant's lap.
- Never carry more people in the vehicle than there are seat belts.
- Never wear seat belts inside out. Belts should not be worn with straps twisted. Doing so may reduce their effectiveness.
- Seatbelts should be adjusted as firmly as possible, consistent with comfort, to provide the protection for which they have been designed. A slack belt will greatly reduce the protection afforded to the wearer.
- Every person who drives or rides in this vehicle should use a seat belt at all times. Children should be properly restrained in the rear seat (if equipped) and, if appropriate, in a child restraint system.
- Do not put the belt behind your back or under your arm. Always route the shoulder belt over your shoulder and across your chest. The belt should be

away from your face and neck, but not falling off your shoulder. Serious injury may occur if a seat belt is not worn properly.

- No modifications or additions should be made by the user which will either prevent the seat belt adjusting devices from operating to remove slack, or prevent the seat belt assembly from being adjusted to remove slack.
- Care should be taken to avoid contamination of the webbing with polishes, oils and chemicals, and particularly battery acid. Cleaning may safely be carried out using mild soap and water. The belt should be replaced if webbing becomes frayed, contaminated or damaged.
- It is essential to replace the entire assembly after it has been worn in a severe impact even if damage to the assembly is not obvious.
- All seat belt assemblies including retractors and attaching hardware should be inspected after any collision by a NISSAN dealer. NISSAN recommends that all seat belt assemblies in use during a collision be replaced unless the collision was minor and the belts show no damage and continue to operate properly. Seat belt assemblies not in use during a collision should also be inspected and, when necessary, replaced if either damage or improper operation is noted.
- Once the pre-tensioner seat belt (if equipped) has activated, it cannot be reused. It must be replaced together with the retractor. Contact a NISSAN dealer.
- Removal and installation of the pre-tensioner seat belt system (if equipped) components should be done by a NISSAN

dealer.

## CHILD SAFETY



### WARNING:

- Infants and children need special protection. The vehicle's seat belts may not fit them properly. The shoulder belt may come too close to the face or neck. The lap belt may not fit over their small hipbones. In an accident, an improperly fitted seat belt could cause serious or fatal injury.
- Always use an appropriate child restraint system.

Children need adults to help protect them. They need to be properly restrained. The proper restraint depends on the child's size.

### Infants and small children

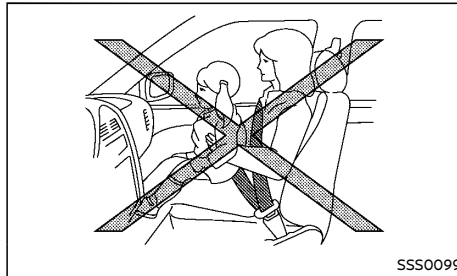

NISSAN recommends that infants and small children be seated in a child restraint system. You should choose a child restraint system that fits your vehicle and the child, and always follow the manufacturer's instructions for installation and use.

### Large children



### WARNING:

- Never allow children to stand or kneel on any seats.
- Never allow children in the luggage areas while the vehicle is moving. A child could be seriously injured in an accident or sudden stop.

Children who are too large for a child restraint system should be seated and restrained by the seat belts that are provided.

If the child's seating position has a shoulder belt that fits close to the face or neck, the use of a booster seat (commercially available) may help overcome this. The booster seat should raise the child so that the shoulder belt is properly positioned across the top, middle portion of the shoulder and the lap belt is low on the hips. The booster seat should also fit the vehicle seat. Once the child has grown so that the shoulder belt is no longer on or near the face or neck of the child, use the shoulder belt without the booster seat. In addition, there are many types of child restraint systems available for larger children that should be used for maximum protection.

### PREGNANT WOMEN

NISSAN recommends that pregnant women use seat belts. The seat belt should be worn snug, and always position the lap belt as low as possible around the hips, not the waist. Place the shoulder belt over your shoulder and across your chest. Never run the lap/shoulder belt over your abdominal area. Contact your doctor for specific recommendations.

## INJURED PERSONS

NISSAN recommends that injured persons use seat belts. Contact your doctor for specific recommendations.

## CENTER MARK ON SEAT BELTS (if equipped)

### Selecting correct set of seat belts

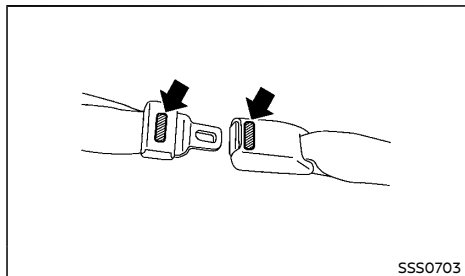

The center seat belt buckle (and/or tongue, if equipped) is identified by the CENTER mark. The center seat belt tongue can be fastened only into the center seat belt buckle.

## THREE-POINT TYPE SEAT BELTS

### Fastening seat belts

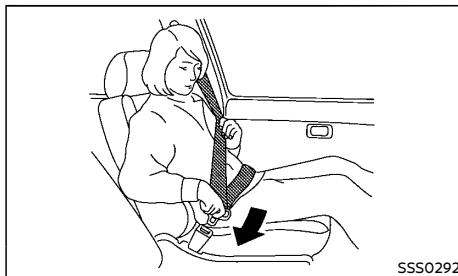

#### WARNING:

The seatback should not be in a reclined position any more than needed for comfort. Seat belts are most effective when the passenger sits well back and straight up in the seat.

1. Adjust the seat. (See "Seats" (P.1-2).)
2. Slowly pull the seat belt out of the retractor and insert the tongue into the buckle until you hear and feel the latch engage.
  - The retractor is designed to lock during a sudden stop or on impact. A slow pulling motion permits the seat belt to move, and allows you some freedom of movement in the seat.
  - If the seat belt cannot be pulled from its fully retracted position, firmly pull the belt and release it. Then smoothly pull the belt out of the retractor.

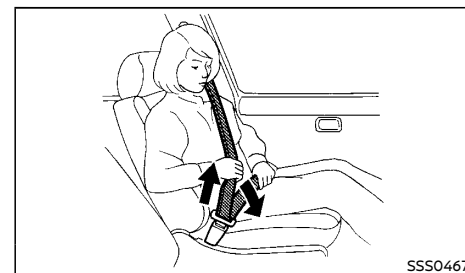

3. Position the lap belt portion low and snug on the hips as shown.
4. Pull the shoulder belt portion toward the retractor to take up extra slack. Be sure the shoulder belt is routed over your shoulder and is snug across your chest.

### Shoulder belt height adjustment (for front seats)

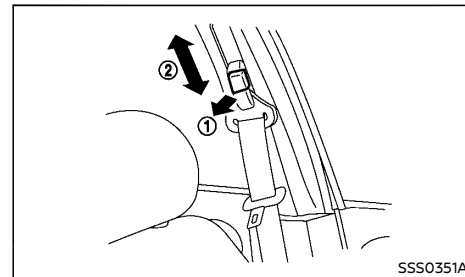

#### WARNING:

- The shoulder belt anchor height should be adjusted to the position best for you. Failure to do so may reduce the effec-

**tiveness of the entire restraint system and increase the chance or severity of injury in an accident.**

- **The shoulder belt should rest on the middle of the shoulder. It must not rest against the neck.**
- **Be sure that the seat belt is not twisted in any way.**
- **Be sure that the shoulder belt anchor is secured by trying to move the shoulder belt anchor up and down after adjustment.**

To adjust, pull in the release button ① and move the shoulder belt anchor to the proper position ②, so that the belt passes over the center of the shoulder. The belt should be away from your face and neck, but not falling off your shoulder. Release the button to lock the shoulder belt anchor into position.

### Unfastening seat belts

Push the button on the buckle. The seat belt automatically retracts.

### Checking seat belt operation

Seat belt retractors are designed to lock seat belt movement:

- When the seat belt is pulled quickly from the retractor.
- When the vehicle slows down rapidly.

To increase your confidence in the seat belts, check the operation by grasping the shoulder belt and pulling forward quickly. The retractor should lock and restrict further belt movement. If the retractor does not lock during this check, contact a NISSAN dealer immediately.

### TWO-POINT TYPE SEAT BELTS (if equipped)

#### Fastening seat belts



#### WARNING:

**Every person who drives or rides in this vehicle should use a seat belt at all times.**

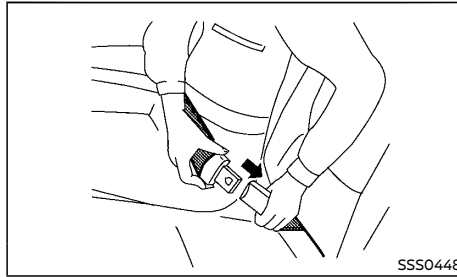

1. Insert the tongue into the buckle marked **CENTER** until you hear and feel the latch engage.

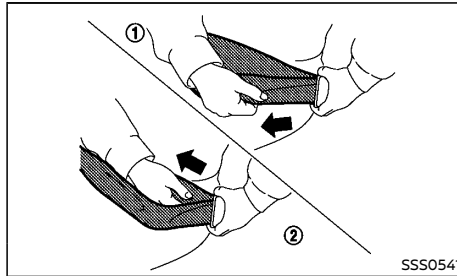

2. Adjust the seat belt length. To shorten, hold the tongue and pull the upper belt as illustrated ①. To lengthen, hold the tongue and pull the under belt as illustrated ②.

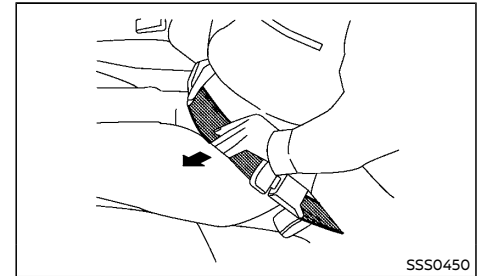

3. Position the lap belt portion low and snug on the hips as shown.

### Unfastening seat belts

Push the button on the buckle.

### SEAT BELT MAINTENANCE

Periodically check that the seat belt and all the metal components, such as buckles, tongues, retractors, flexible wires and anchors, work properly. If loose parts, deterioration, cuts or other damage on the seat belt webbing is found, the entire seat belt assembly should be replaced.

If dirt builds up in the shoulder belt guide of the seat belt anchors, the seat belts may retract slowly. Wipe the shoulder belt guide with a clean, dry cloth.

To clean the seat belt webbing, apply a mild soap solution or any solution recommended for cleaning upholstery or carpet. Then wipe with a cloth and allow the seat belts to dry in the shade. Do not allow the seat belts to retract

## CHILD RESTRAINTS

until they are completely dry.

### PRECAUTIONS ON CHILD RESTRAINT USAGE

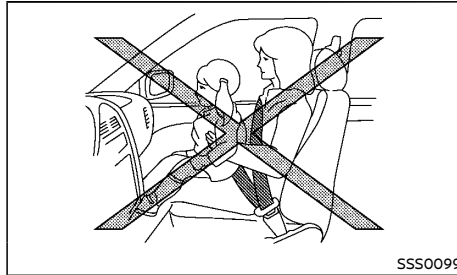

#### WARNING:

- Infants and small children should never be carried on your lap. It is not possible for even the strongest adult to resist the forces of a severe accident. The child could be crushed between the adult and parts of the vehicle. Also, do not put the same seat belt around both your child and yourself.
  - Infants and children need special protection. The vehicle's seat belts may not fit them properly. The shoulder belt may come too close to the face or neck. The lap belt may not fit over their small hip bones. In an accident, an improperly fitting seat belt could cause serious or fatal injury.
  - Infants and small children should always be placed in an appropriate child restraint while riding in the vehicle. Failure to use a child restraint can result in serious injury or death.
- Child restraint systems specially designed for infants and small children are available from several manufacturers. When selecting any child restraint systems, place your child in the child restraint system and check the various adjustments to be sure that the child restraint system is compatible with your child. Always follow the manufacturer's instructions for installation and use.
  - NISSAN recommends that the child restraints be installed in the rear seat (Double Cab model). According to accident statistics, children are safer when properly restrained in the rear seat than in the front seat.
  - Follow all of the child restraint manufacturer's instructions for installation and use. When purchasing a child restraint, be sure to select one which will fit your child and vehicle. It may not be possible to properly install some types of child restraint in your vehicle.
  - The direction of the child restraint, either front-facing or rear-facing, depends on the type of the child restraint and the size of the child. Refer to the child restraint manufacturer's instructions for details.
  - For a front-facing child restraint system, check to make sure the shoulder belt does not fit close to child's face or neck. If it does, put the shoulder belt behind the child restraint system. If you must install a front-facing child restraint system in the front seat, see "Installation on front passenger's seat" (P.1-22).
  - Never install a rear-facing child restraint on the front passenger's seat when the front passenger's air bag is available. Supplemental front-impact air bags in-

flate with great force. A rear-facing child restraint could be struck by the supplemental front-impact air bags in an accident and could seriously injure or kill your child.

- Do not install a child restraint in the jump seats (if equipped for King Cab model). These seats are not suitable for child restraint installation.
- Adjustable seatbacks should be positioned to ensure full contact between child restraint and seatback.
- If the seat belt in the position where a child restraint is installed requires a locking device and if it is not used, injuries could result from a child restraint system tipping over during normal vehicle braking or cornering.
- After attaching a child restraint, test it before you place the child in it. Push it from side to side and tug it forward to make sure that it is held securely in place. The child restraint system should not move more than 25 mm (1 in). If the restraint is not secure, tighten the belt as necessary, or install the restraint in another seat and test it again.
- Check the child restraint system in your vehicle to be sure that it is compatible with the vehicle's seat belt system.
- If a child restraint system is not anchored properly, the risk of a child being injured in a collision or a sudden stop greatly increases.
- Improper use or improper installation of a child restraint can increase the risk or severity of injury for both the child and other occupants of the vehicle and can lead to serious injury or death in an

accident.

- Always use an appropriate child restraint system. An improperly installed child restraint system could lead to serious injury or death in an accident.
- When the child restraint is not in use, keep it secured with the ISOFIX child restraint system (if equipped) or a seat belt to prevent it from being thrown around in case of a sudden stop or accident.

NISSAN recommends that infants and small children be seated in a child restraint system. You should choose a child restraint system that fits your vehicle and always follow the manufacturer's instructions for installation and use. In addition, there are many types of child restraint systems available for larger children that should be used for maximum protection.



**CAUTION:**

Remember that a child restraint system left in a closed vehicle can become very hot. Check the seating surface and buckles before placing your child in a child restraint system.

**UNIVERSAL CHILD RESTRAINTS FOR FRONT SEAT AND REAR SEATS (Double Cab models)**

**NOTE:**

Universal child restraints approved to UN Regulation NO. 44 (UN R44) or UN Regulation NO. 129 (UN R129) are clearly marked "Universal".

When selecting any child restraint, keep the following points in mind:

- Choose a child restraint that complies with UN R44 or UN R129.
- Place your child in the child restraint and check the various adjustments to be sure the child restraint is compatible with your child. Always follow all of the recommended procedures.
- Check the child restraint in your vehicle to be sure it is compatible with vehicle's seat belt system.
- Refer to the tables later in this section for a list of the recommended fitment positions.

**Mass group of child seat**

Mass group	Child's weight
Group 0	up to 10 kg
Group 0+	up to 13 kg
Group I	9 to 18 kg
Group II	15 to 25 kg
Group III	22 to 36 kg



**Kind of child seats (example):**

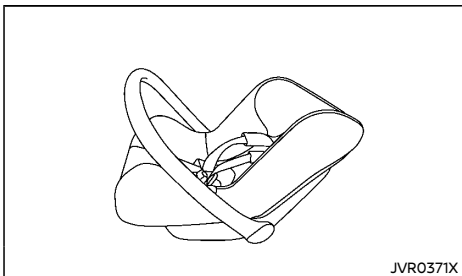

JVR0371X

**Child safety seat categories 0 and 0+**

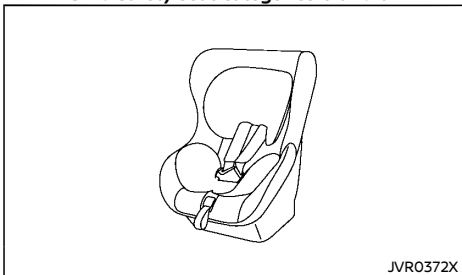

JVR0372X

**Child safety seat categories 0+ and I**

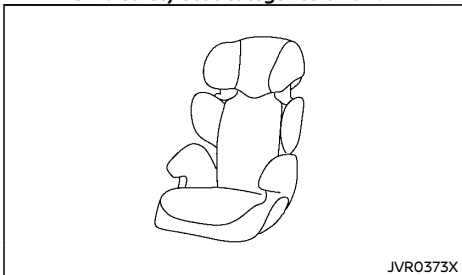

JVR0373X

**Child safety seat categories II and III**

**Approved child restraint positions (without ISOFIX)**

The following restriction is applied when using child restraints varying by infants weight and installation position.

Mass group	Suitability		
	Front passenger seat	2nd row outer seat	2nd row center seat
0 (<10 kg)	X	U, L	U, L
0+ (<13 kg)	X	U, L	U, L
I (9-18 kg)	X	U, L	U, L
II (15-25 kg)	X	U, L	U, L
III (22-36 kg)	X	U, L	U, L

If you install a child restraint system in the rear seat, remove the rear seat head restraint.

X: Not suitable for child restraint system

U: Suitable for "universal" category child restraint system approved for this weight group.

L: Suitable for child restraints in "semi-universal" category.

## Approved child restraint positions (with ISOFIX)

The following restriction is applied when using child restraints varying by infants weight and installation position.

Mass group			Suitability		
			Front passenger seat	2nd row outer seat	2nd row center seat
Carry-cot	F	ISO/L1	X	X	X
	G	ISO/L2	X	X	X
0 (< 10 kg)	E	ISO/R1	X	IL*1	X
0+ (< 13 kg)	E	ISO/R1	X	IL*1	X
	D	ISO/R2	X	IL*1	X
	C	ISO/R3	X	IL*1	X
I (9 - 18 kg)	D	ISO/R2	X	IL*1	X
	C	ISO/R3	X	IL*1	X
	B	ISO/F2	X	IUF/IL	X
	B1	ISO/F2X	X	IUF/IL	X
	A	ISO/F3	X	IUF/IL	X
II (15 - 25 kg)	—		X	IL	X
III (22 - 36 kg)	—		X	IL	X

If you install a child restraint system in the rear seat, remove the rear seat head restraint.

\*1: The forward and backward, and reclining adjustments of front seat are required.

X: Position not suitable for installation of ISOFIX child restraint systems (CRS) in these seating positions.

IUF: Suitable for universal category forward facing child restraint system approved for this weight group.

IL: Suitable for ISOFIX CRS in "semi-universal" category.

## ISOFIX CHILD RESTRAINT SYSTEM (if equipped)

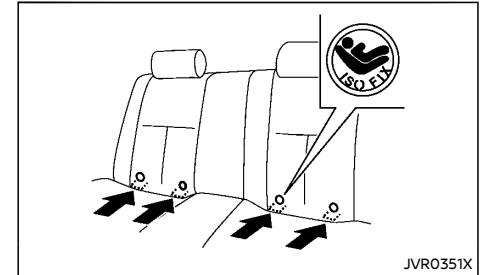

### ISOFIX label location

Your vehicle is equipped with special anchor points that are used with ISOFIX child restraint systems.

### ISOFIX lower anchor point locations

The ISOFIX anchor points are provided to install child restraints in the rear outboard seating positions only. **Do not attempt to install a child restraint in the rear seat center position using the ISOFIX anchors.**

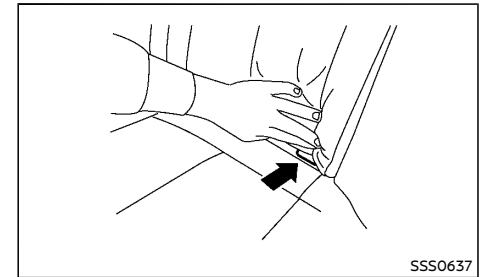

### ISOFIX lower anchor location

The ISOFIX anchors are located as shown. A

label is attached to the seatback to help you locate the ISOFIX anchors.

### ISOFIX child restraint anchor attachments

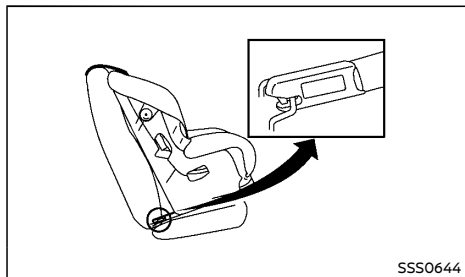

Anchor attachment

ISOFIX child restraints include two rigid attachments that can be connected to two anchors located in the seat. With this system, you do not have to use a vehicle seat belt to secure the child restraint. Check your child restraint for a label stating that it is compatible with the ISOFIX child restraints. This information may also be in the instructions provided by the child restraint manufacturer.

ISOFIX child restraints generally require the use of a top tether strap or other anti-rotation devices such as support legs. When installing ISOFIX child restraints, carefully read and follow the instructions in this manual and those supplied with the child restraints. See "Child restraint installation using ISOFIX" (P.1-18).

### CHILD RESTRAINT ANCHORAGE (if equipped)

Your vehicle is designed to accommodate a child restraint system on the rear seat. When installing a child restraint system, carefully read and follow the instructions in this manual and those supplied with the child restraint system.



#### WARNING:

**Child restraint anchorages are designed to withstand only those loads imposed by correctly fitted child restraints. Under no circumstances are they to be used for adult seat belts, harnesses or for attaching other items or equipment to the vehicle. Doing so could damage the child restraint anchorages, and a child could be seriously injured or killed in a collision.**

### Anchorage location

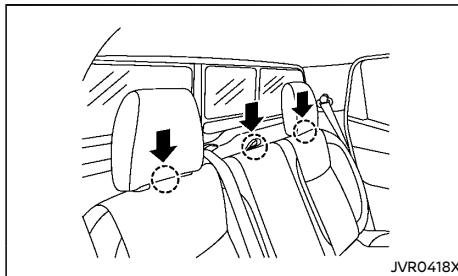

The anchor points (loops) are located on the top of the rear seatback.

If the child restraint manufacturer recommends that the top tether strap be attached,

attach and tighten the top tether strap to the top tether anchor (loop). Refer to the child restraint instructions and the following steps.

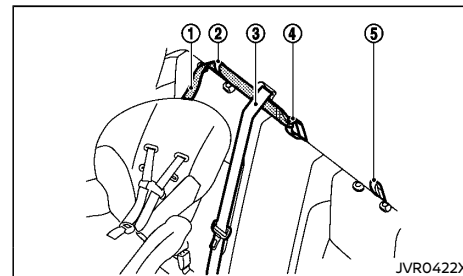

On the rear right outboard seating position

#### 1. On the rear right outboard seating position:

1. Remove the head restraint of the rear right outboard seat.
2. Route the top tether strap ① through the right top tether anchor (loop) ② and under the center shoulder belt ③.
3. Attach the top tether strap ① to the top tether anchor (loop) ④ at the rear center seating position.

#### 2. On the rear left outboard seating position:

1. Remove the head restraint of the rear left outboard seat.
2. Route the top tether strap ① through the left top tether anchor (loop) ⑤.
3. Attach the top tether strap ① to the top tether anchor (loop) ④ at the rear center seating position.

#### 3. On the rear center seating position:

1. Remove the head restraint of the rear left (or right) outboard seat.

2. Route the top tether strap ① through the center top tether anchor (loop) ④.
3. Attach the top tether strap ① to the left top tether anchor (loop) ⑤ (or right top tether anchor (loop) ②) through under the center shoulder belt ③.

Tighten the top tether according to the child restraint manufacturer's instructions.

When the top tether strap is properly tightened, the top tether anchor (loop) may bend. This is normal and will not damage the vehicle.

### CHILD RESTRAINT INSTALLATION USING ISOFIX (if equipped)

#### **⚠ WARNING:**

- **Attach ISOFIX child restraints only at the specified locations. For the ISOFIX lower anchor locations, see "ISOFIX child restraint system" (P.1-16). If a child restraint is not secured properly, your child could be seriously injured or killed in an accident.**
- **Do not install child restraints that require the use of a top tether strap to seating positions that do not have a top tether anchor.**
- **Do not secure a child restraint in the center rear seating position using the ISOFIX lower anchors. The child restraint will not be secured properly.**
- **Inspect the lower anchors by inserting your fingers into the lower anchor area and feeling to make sure there are no obstructions over the ISOFIX anchors, such as seat belt webbing or seat cushion material. The child restraint will not be secured properly if the ISOFIX anchors are obstructed.**

- **Child restraint anchorages are designed to withstand only those loads imposed by correctly fitted child restraints. Under no circumstances are they to be used for adult seat belts, harnesses or for attaching other items or equipment to the vehicle. Doing so could damage the child restraint anchorages. The child restraint will not be properly installed using the damaged anchorage, and a child could be seriously injured or killed in a collision.**

### Installation on rear outboard seats

#### Front-facing:

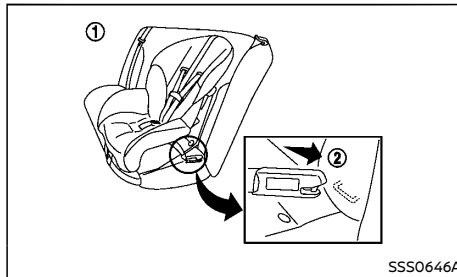

Front-facing: Steps 1 and 2

Be sure to follow the manufacturer's instructions for the proper use of your child restraint. Follow these steps to install a front-facing child restraint on the rear outboard seats using ISOFIX:

1. Position the child restraint on the seat ①.
2. Secure the child restraint anchor attachments to the ISOFIX lower anchors ②.
3. The back of the child restraint should be secured against the vehicle seatback. Remove the head restraint to obtain the correct child restraint fit. (See "Head re-

straints" (P.1-6.) Store the removed head restraint in a secure place. Be sure to install the head restraint when the child restraint is removed. If the seating position does not have an adjustable head restraint and it is interfering with the proper child restraint fit, try another seating position or a different child restraint.

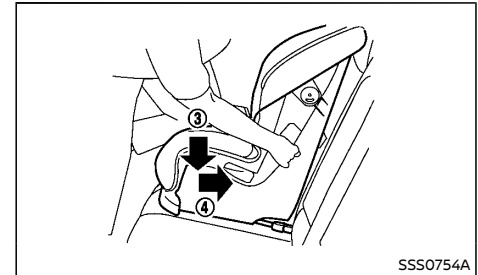

Front-facing: Step 4

4. Shorten the rigid attachment to have the child restraint firmly tightened; press downward ③ and rearward ④ firmly in the center of the child restraint with your knee to compress the vehicle seat cushion and seatback.
5. If the child restraint is equipped with a top tether strap, route the top tether strap and secure the tether strap to the tether anchor point. (See "Child restraint anchorage" (P.1-17).)
6. If the child restraint is equipped with other anti-rotation devices such as support legs, use them instead of the top tether strap following the child restraint manufacturer's instructions.

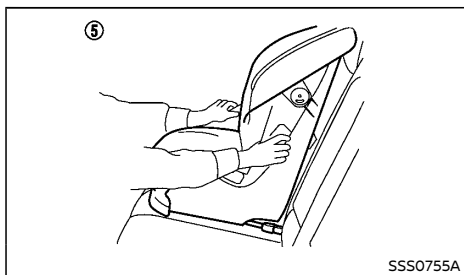

**Front-facing: Step 7**

7. Test the child restraint before you place the child in it ⑤. Push the child restraint from side to side and tug it forward to make sure that it is held securely in place.
8. Check to make sure that the child restraint is properly secured prior to each use. If the child restraint is loose, repeat steps 3 through 7.

**Rear-facing:**

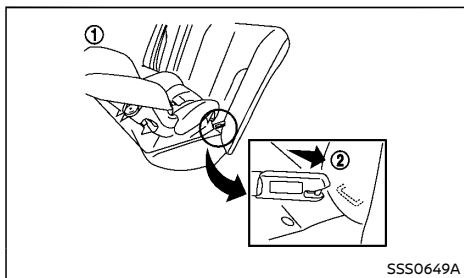

**Rear-facing: Steps 1 and 2**

Be sure to follow the manufacturer's instructions for the proper use of your child restraint. Follow these steps to install a rear-facing child restraint on the rear outboard seats using

**ISOFIX:**

1. Position the child restraint on the seat ①.
2. Secure the child restraint anchor attachments to the ISOFIX lower anchors ②.

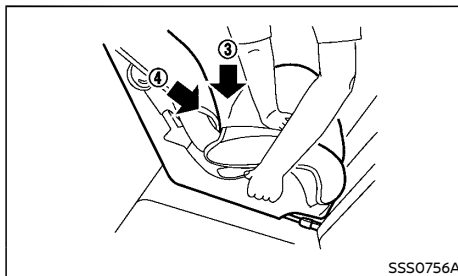

**Rear-facing: Step 3**

3. Shorten the rigid attachment to have the child restraint firmly tightened; press downward ③ and rearward ④ firmly in the center of the child restraint with your hand to compress the vehicle seat cushion and seatback.
4. If the child restraint is equipped with a top tether strap, route the top tether strap and secure the tether strap to the tether anchor point. (See "Child restraint anchorage" (P.1-17).)
5. If the child restraint is equipped with other anti-rotation devices such as support legs, use them instead of the top tether strap following the child restraint manufacturer's instructions.

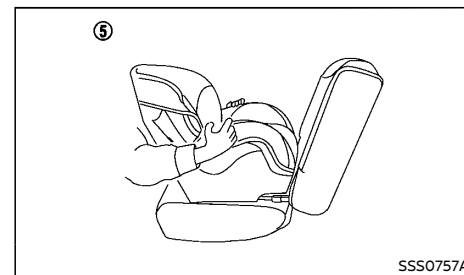

**Rear-facing: Step 6**

6. Test the child restraint before you place the child in it ⑤. Push the child restraint from side to side and tug it forward to make sure that it is held securely in place.
7. Check to make sure that the child restraint is properly secured prior to each use. If the child restraint is loose, repeat steps 3 through 6.

**CHILD RESTRAINT INSTALLATION USING THREE-POINT TYPE SEAT BELT**

Installation on rear seats (Double Cab models)

**Front-facing:**

Be sure to follow the manufacturer's instructions for the proper use of your child restraint. Follow these steps to install a front-facing child restraint on the rear seats using three-point type seat belt without automatic locking mode:

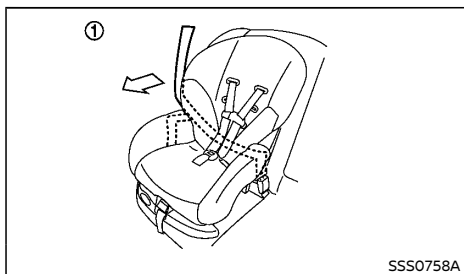

**Front-facing: Step 1**

1. Position the child restraint on the seat ①.

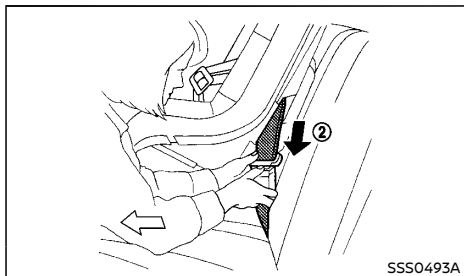

**Front-facing: Step 2**

2. Route the seat belt tongue through the child restraint and insert it into the buckle ② until you hear and feel the latch engage.
3. To prevent slack in the seat belt webbing, it is necessary to secure the seat belt in place with locking devices attached to the child restraint.

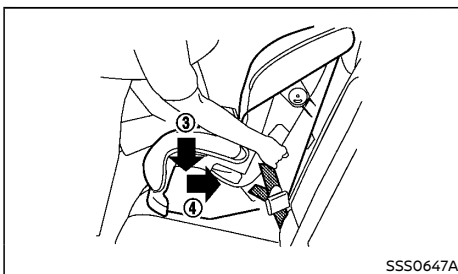

**Front-facing: Step 4**

4. Remove any additional slack from the seat belt; press downward ③ and rearward ④ firmly in the center of the child restraint with your knee to compress the vehicle seat cushion and seatback while pulling up on the seat belt.

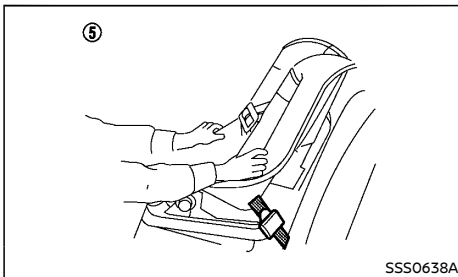

**Front-facing: Step 5**

5. Test the child restraint before you place the child in it ⑤. Push the child restraint from side to side and tug it forward to make sure that it is held securely in place.
6. Check to make sure that the child restraint is properly secured prior to each use. If the child restraint is loose, repeat steps 3 through 5.

**Rear-facing:**

Be sure to follow the manufacturer's instructions for the proper use of your child restraint. Follow these steps to install a rear-facing child restraint on the rear seats using three-point type seat belt without automatic locking mode:

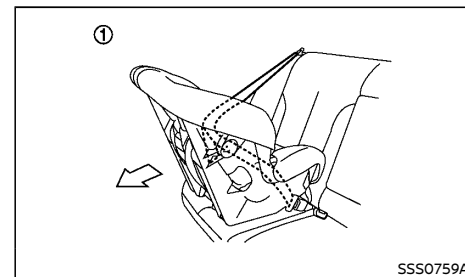

**Rear-facing: Step 1**

1. Position the child restraint on the seat ①.

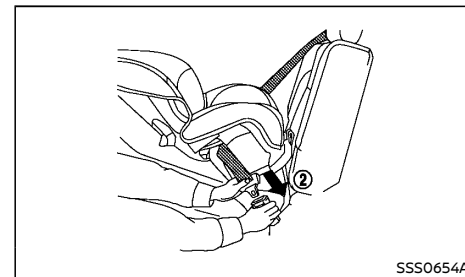

**Rear-facing: Step 2**

2. Route the seat belt tongue through the child restraint and insert it into the buckle ② until you hear and feel the latch engage.
3. To prevent slack in the seat belt webbing, it is necessary to secure the seat belt in place with locking devices attached to the child

restraint.

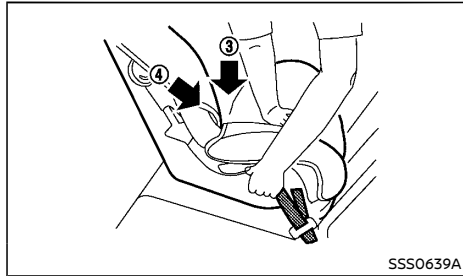

**Rear-facing: Step 4**

4. Remove any additional slack from the seat belt; press downward ③ and rearward ④ firmly in the center of the child restraint with your hand to compress the vehicle seat cushion and seatback while pulling up on the seat belt.

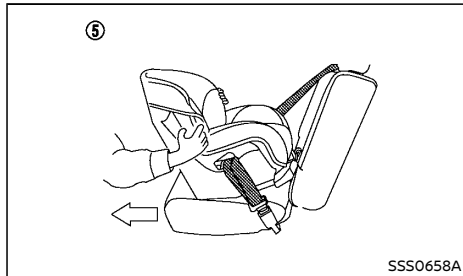

**Rear-facing: Step 5**

5. Test the child restraint before you place the child in it ⑤. Push the child restraint from side to side and tug it forward to make sure that it is held securely in place.
6. Check to make sure that the child restraint is properly secured prior to each use. If the

child restraint is loose, repeat steps 3 through 5.

## Installation on front passenger's seat

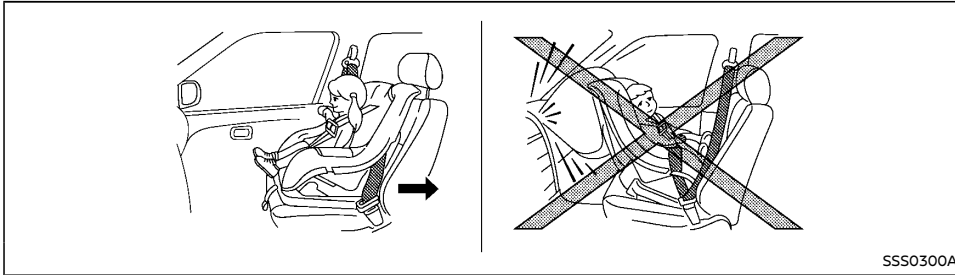

### **WARNING:**

- **Never install a rear facing child restraint system on the front seat. Supplemental front-impact air bags inflate with great force. A rear-facing child restraint system could be struck by the supplemental front-impact air bags in an accident and could seriously injure or kill your child.**
- **NISSAN recommends that a child restraint be installed on the rear seat (Double Cab models). However, subject to local regulations, if you must install a front facing child restraint system on the front passenger's seat, move the passenger's seat to the rearmost position.**
- **Child restraints for infants must be used in the rear-facing direction and therefore must not be used on the front seat.**
- **Failure to use the seat belts will result in the child restraint system not being properly secured. It could tip over or otherwise be unsecured and cause injury to the child in a sudden stop or collision.**

### **Front-facing:**

Be sure to follow the manufacturer's instructions for the proper use of your child restraint. Follow these steps to install a front-facing child restraint on the front passenger's seat using three-point type seat belt without automatic locking mode:

1. Move the seat to the rearmost position ①.

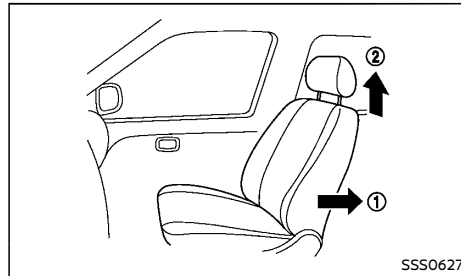

### **Front-facing: Steps 1 and 2**

2. Adjust or remove the head restraint ②.
3. Position the child restraint in the seat.

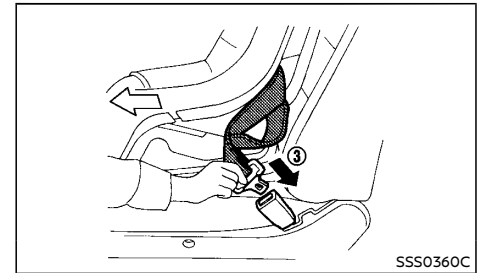

### **Front-facing: Step 4**

4. Route the seat belt tongue through the child restraint and insert it into the buckle ③ until you hear and feel the latch engage.
5. To prevent slack in the seat belt webbing, it is necessary to secure the seat belt in place with locking devices attached to the child restraint.

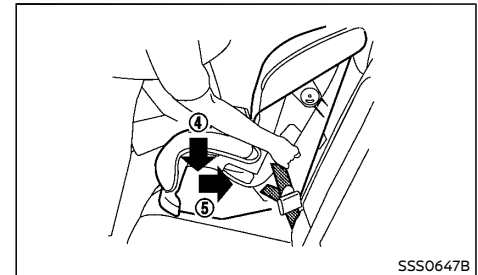

### **Front-facing: Step 6**

6. Remove any additional slack from the seat belt; press downward ④ and rearward ⑤ firmly in the center of the child restraint with your knee to compress the vehicle seat cushion and seatback while pulling up on the seat belt.



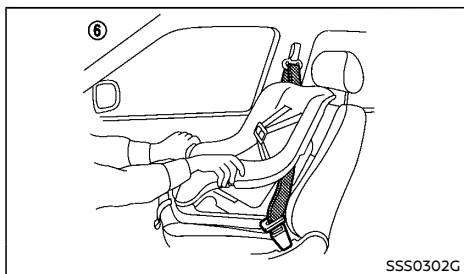

**Front-facing: Step 7**

7. Test the child restraint before you place the child in it ⑥. Push the child restraint from side to side and tug it forward to make sure that it is held securely in place.
8. Check to make sure that the child restraint is properly secured prior to each use. If the child restraint is loose, repeat steps 5 through 7.

## CHILD RESTRAINT INSTALLATION USING TWO-POINT TYPE SEAT BELT (if equipped)

### Installation on rear center seat

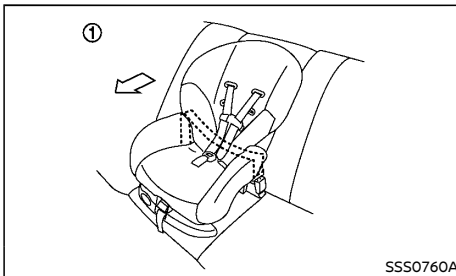

**Front-facing: Step 1**

#### **Front-facing:**

Be sure to follow the manufacturer's instructions for the proper use of your child restraint. Follow these steps to install a front-facing child restraint on the rear center seat using two-point type seat belt:

1. Position the child restraint on the seat ①.

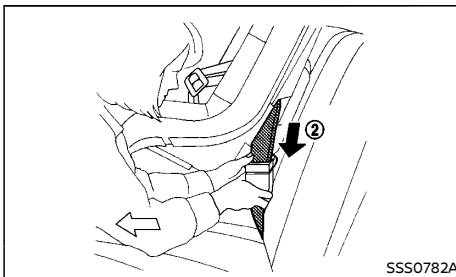

**Front-facing: Step 2**

2. Route the seat belt tongue through the child restraint and insert it into the buckle ② until you hear and feel the latch engage.

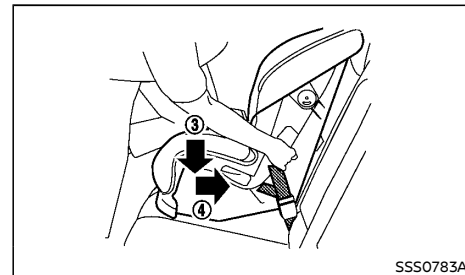

**Front-facing: Step 3**

3. Remove any additional slack from the seat belt; press downward ③ and rearward ④ firmly in the center of the child restraint with your knee and seatback while pulling up on the seat belt.

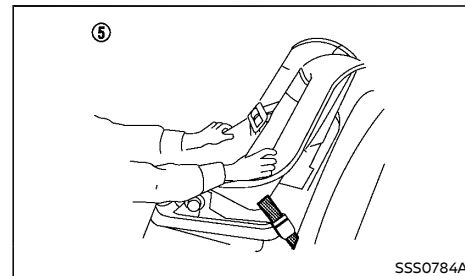

**Front-facing: Step 4**

4. Test the child restraint before you place the child in it ⑤. Push the child restraint from side to side and tug it forward to make sure that it is held securely in place.

5. Check to make sure that the child restraint is properly secured prior to each use. If the child restraint is loose, repeat steps 3 through 4.

**Rear-facing:**

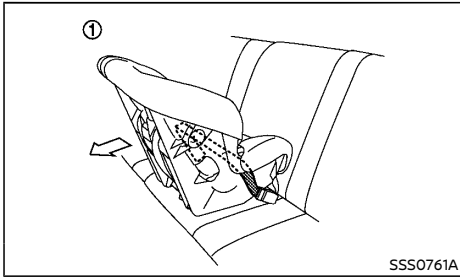

**Rear-facing: Step 1**

Be sure to follow the manufacturer's instructions for the proper use of your child restraint. Follow these steps to install a rear-facing child restraint on the rear center seat using 2-point type seat belt:

1. Position the child restraint on the seat ①.

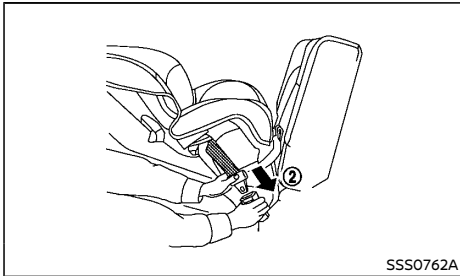

**Rear-facing: Step 2**

2. Route the seat belt tongue through the child restraint and insert it into the buckle ② until you hear and feel the latch engage.

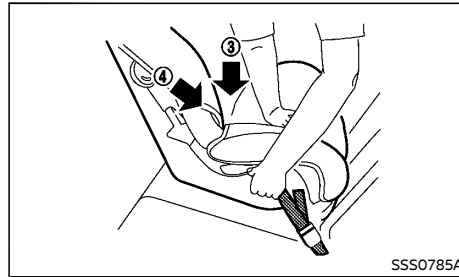

**Rear-facing: Step 3**

3. Remove any additional slack from the seat belt; press downward ③ and rearward ④ firmly in the center of the child restraint with your hand to compress the vehicle seat cushion and seatback while pulling up on the seat belt.

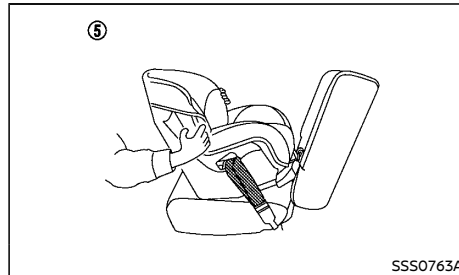

**Rear-facing: Step 4**

4. Test the child restraint before you place the child in it ⑤. Push the child restraint from side to side and tug it forward to make sure that it is held securely in place.

5. Check to make sure that the child restraint is properly secured prior to each use. If the child restraint is loose, repeat steps 3 through 4.

## SUPPLEMENTAL RESTRAINT SYSTEM (SRS) (if equipped)

### PRECAUTIONS ON SUPPLEMENTAL RESTRAINT SYSTEM (SRS)

This Supplemental Restraint System (SRS) section contains important information concerning the driver's and passenger's supplemental front-impact air bags, supplemental driver's knee air bag (if equipped), supplemental side-impact air bags (if equipped), supplemental curtain side-impact air bags (if equipped) and pre-tensioner seat belts (if equipped).

#### Supplemental front-impact air bag system

This system can help cushion the impact force to the head and chest area of the driver and/or front passenger in certain frontal collisions. The supplemental front-impact air bag is designed to inflate on the front where the vehicle is impacted.

#### Supplemental driver's knee air bag system (if equipped)

This system can help cushion the impact force to the knee area of the driver in certain frontal collisions. The supplemental driver's knee air bag is designed to inflate on the front where the vehicle is impacted.

#### Supplemental side-impact air bag system (if equipped)

This system can help cushion the impact force to the chest and pelvis area of the driver and front passenger in certain side-impact collisions. The supplemental side-impact air bag is designed to inflate on the side where the vehicle is impacted.

#### Supplemental curtain side-impact air bag system (if equipped)

This system can help cushion the impact force to the head of the driver and passengers in front seating positions and rear outboard seating positions (if equipped) in certain side-impact collisions. The supplemental curtain side-impact air bag is designed to inflate on the side where the vehicle is impacted.

The SRS is designed to **supplement** the accident protection provided by the driver's and passenger's seat belts and **is not** designed to **substitute** for them. The SRS can help save lives and reduce serious injuries. However, inflating air bags may cause abrasions or other injuries. Air bags do not provide protection to the lower body. Seat belts should always be correctly worn and the occupants should always be seated a suitable distance away from the steering wheel, instrument panel and door finishers. (See "Seat belts" (P.1-8).) The air bags inflate quickly in order to help protect the occupants. The force of the air bags inflating can increase the risk of injury if the occupants are too close to, or are against, the air bag modules during inflation. The air bags will deflate quickly after deployment.

**The SRS operates only when the ignition switch is in the "ON" position.**

**When the ignition switch is in the "ON" position, the SRS air bag warning light illuminates for about 7 seconds and then turns off. This indicates that the SRS is operational. (See "Warning lights, indicator lights and audible reminders" (P.2-13).)**

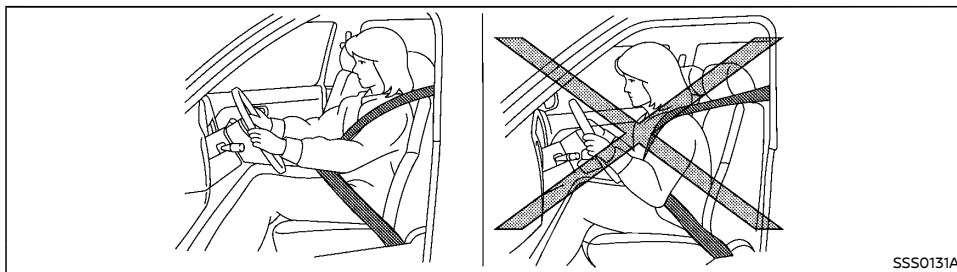

SSS0131A

if the supplemental front air bag inflates.

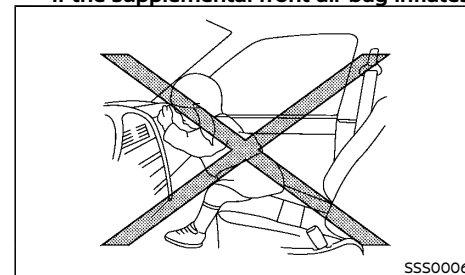

SSS0006

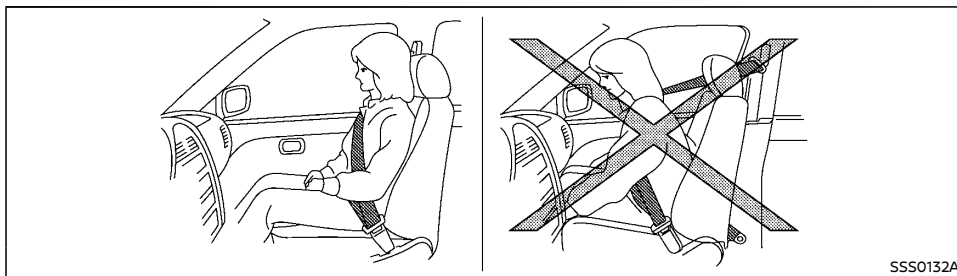

SSS0132A

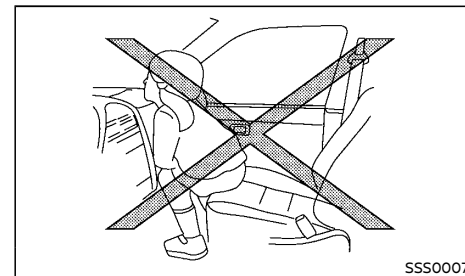

SSS0007

**WARNING:**

- The supplemental front air bags ordinarily will not inflate in the event of a side impact, rear impact, rollover, or lower severity frontal collision. Always wear your seat belts to help reduce the risk or severity of injury in various kinds of accidents.
- The seat belts and the supplemental front-impact air bags are most effective when you are sitting well back and upright in the seat. The front-impact air bags inflate with great force. If you and your passengers are unrestrained, lean-

ing forward, sitting sideways, or out of position in any way, you and your passengers are at greater risk of injury or death in an accident. You and your passengers may also receive serious or fatal injuries from the supplemental front-impact air bag if you are up against it when it inflates. Always sit back against the seatback and as far away as practical from the steering wheel or instrument panel. Always use the seat belts.

- Keep hands on the outside of the steering wheel. Placing them inside the steering wheel rim could increase the risk of injury

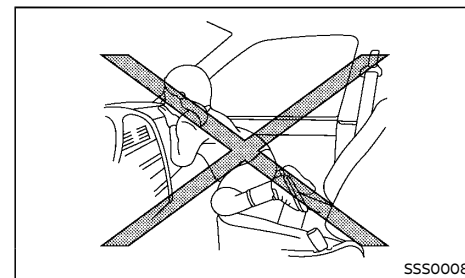

SSS0008

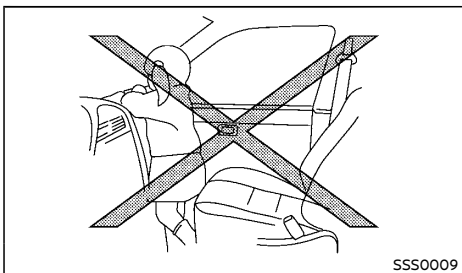

**⚠ WARNING:**

- Never let children ride unrestrained or extend their hands or face out of the window. Do not attempt to hold them in your lap or arms. Some examples of dangerous riding positions are shown in the illustrations.
- Children may be severely injured or killed when the air bags inflate if they are not properly restrained.
- Never install a rear-facing child restraint system in the front seat. An inflating supplemental front-impact air bag could seriously injure or kill your child. (See "Child restraints" (P.1-13).)

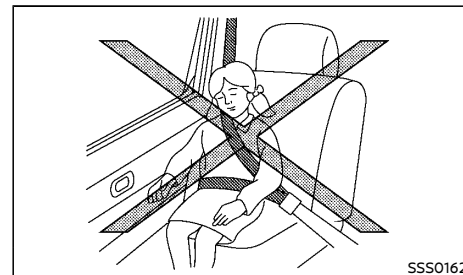
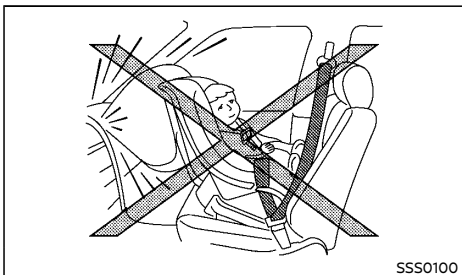
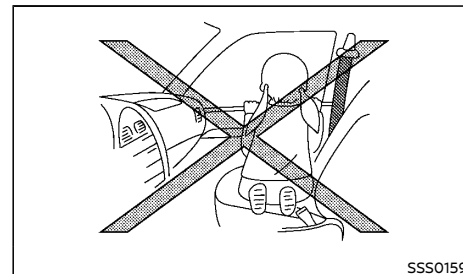
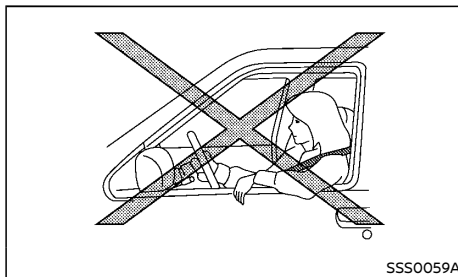
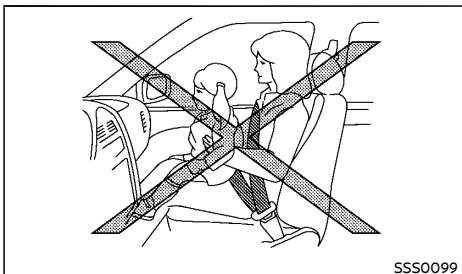
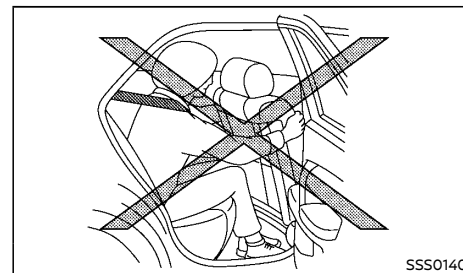

**WARNING:**

- The supplemental side-impact air bags (if equipped) and supplemental curtain side-impact air bags (if equipped) ordinarily will not inflate in the event of a front impact, rear impact, rollover, or lower severity side collision. Always wear the seat belts to help reduce the risk or severity of injury in accidents.
- The seat belts and the supplemental side-impact air bags and supplemental curtain side-impact air bags are most effective when you are sitting well back and upright in the seat. The supplemental side-impact air bags and supplemental curtain side-impact air bags inflate with great force. If you and your passengers are unrestrained, leaning forward, sitting sideways, or out of position in any way, you and your passengers are at greater risk of injury or death in an accident.
- Do not allow anyone to place their hands, legs or face near the supplemental side-impact air bags and supplemental curtain side-impact air bags located on the sides of the seatback of the front seats or near the side roof rails. Do not allow anyone sitting in the front seats or rear outboard seats to extend their hands out of the windows or lean against the doors. Some examples of dangerous riding positions are shown in the illustrations.
- When sitting in the rear seats, do not hold onto the seatback of the front seats. If the supplemental side-impact air bags and supplemental curtain side-impact air bags inflate, you may be seriously injured. Be especially careful with children, who should always be properly re-

strained.

- Do not use seat covers on the front seatbacks. They may interfere with the supplemental side-impact air bag inflations.
- Do not attach the key with heavy objects, hard objects or objects with sharp edges. This may cause injury if the supplemental knee air bag inflates.

Pre-tensioner seat belt system (if equipped)

The pre-tensioner seat belt system may activate with the supplemental air bag system in certain types of collisions. Working with the front seat belt retractors and anchors, it helps tighten the seat belt the instant the vehicle becomes involved in certain types of collisions, helping to restrain front seat occupants. (See "Pre-tensioner seat belt system" (P.1-34).)

Air bag warning labels

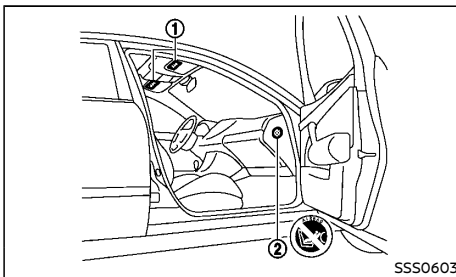

Label location

Warning labels about the supplemental front-impact air bag system are placed in the vehicle as shown in the illustration.

The warning label ① is located on the surface

of the driver's and/or passenger's sun visor.

The warning label ② (if equipped) is located on the side of the passenger's side instrument panel.

The label(s) warn you not to fit a rear-facing child restraint system on the front passenger seat as such a restraint system used in this position could cause serious injury to the infant in case of air bag deployment during a collision.

Type A:



① Air bag warning label (sample)

The label ① design varies depending on the model.

The label warns:

"Extreme Hazard! Do not use a rearward facing child restraint on a seat protected by an airbag in front of it!"

**Type B:**



① **Air bag warning label**

The label warns:

"NEVER use a rearward facing child restraint on a seat protected by an ACTIVE AIRBAG in front of it, DEATH or SERIOUS INJURY to the CHILD can occur."

In vehicles equipped with a front-impact passenger air bag system, use a rear-facing child restraint system only on the rear seats (Double Cab models).

When installing a child restraint system in your vehicle, always follow the child restraint system manufacturer's instructions for installation. For additional information, see "Child restraints" (P.1-13).

**SRS air bag warning light**



The supplemental air bag warning light, displaying in the instrument panel, monitors the circuits for the air bag systems, pre-tensioner seat belt system (if equipped) and all related wiring.

When the ignition switch is in the "ON" position, the SRS air bag warning light illuminates for about 7 seconds and then turns off. This indicates that the SRS air bag systems are operational.

If any of the following conditions occur, the air bag and/or pre-tensioner seat belt system need servicing:

- The SRS air bag warning light remains on after approximately 7 seconds.
- The SRS air bag warning light flashes intermittently.
- The SRS air bag warning light does not illuminate at all.

Under these conditions, the air bag and/or pre-tensioner seat belt system may not operate properly. They must be checked and repaired. Contact a NISSAN dealer immediately.

## SUPPLEMENTAL AIR BAG SYSTEMS

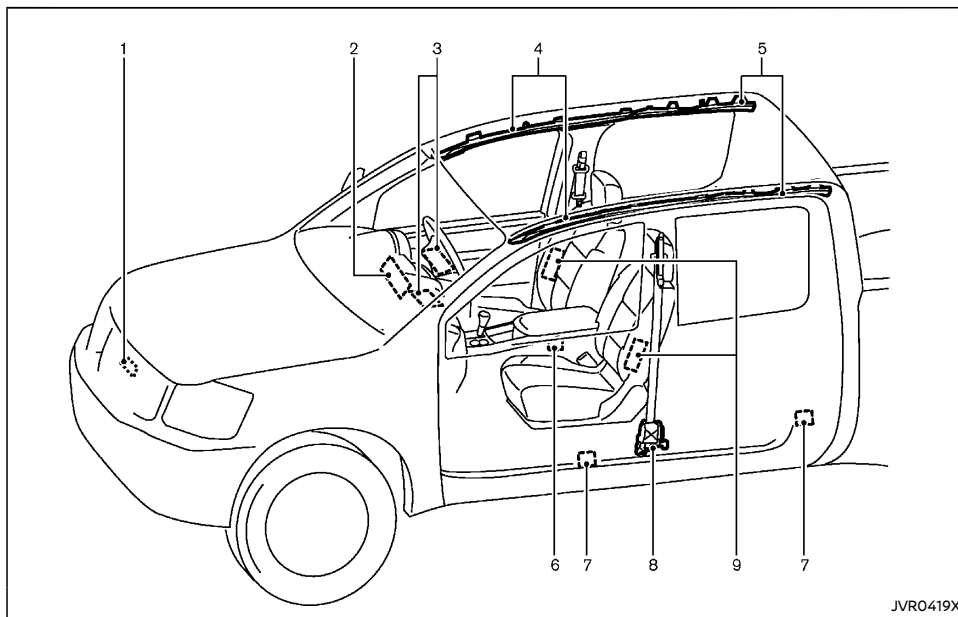

- |   |   |
|---|---|
| 1. Crash zone sensor  | 6. Air bag Control Unit (ACU)                             |
| 2. Supplemental driver's knee air bag module (if equipped)          | 7. Satellite sensors (if equipped)                        |
| 3. Supplemental front air bag modules                               | 8. Seat belt pre-tensioner retractors (if equipped)       |
| 4. Supplemental curtain side-impact air bag inflators (if equipped) | 9. Supplemental side-impact air bag modules (if equipped) |
| 5. Supplemental curtain side-impact air bag modules (if equipped)   |   |



### WARNING:

- Do not place any objects on the steering wheel pad, on the instrument panel, under the steering column and near the front door finishers and the front seats. Do not place any objects between any occupants and the steering wheel pad, on the instrument panel, and near the front door finishers and the front seats. Such objects may become dangerous projectiles and cause injury if a supplemental air bag inflates.
- Immediately after inflation, several supplemental air bag system components will be hot. Do not touch them: you may severely burn yourself.
- No unauthorized changes should be made to any components or wiring of the supplemental air bag systems. This is to prevent accidental inflation of the supplemental air bags or damage to the supplemental air bag systems.
- Do not make unauthorized changes to your vehicle's electrical system, suspension system, front end structure, and side panels. This could affect proper operation of the supplemental air bag systems.
- Tampering with the supplemental air bag systems may result in serious personal injury. Tampering includes changes to the steering wheel and the instrument panel by placing materials over the steering wheel pad and above, around or on the instrument panel or by installing additional trim materials around the supplemental air bag systems.
- Work on and around the supplemental air bag systems should be done by a NISSAN dealer. The SRS wiring should not be



**modified or disconnected. Unauthorized electrical test equipment and probing devices should not be used on the supplemental air bag systems.**

- **The SRS wiring harness connectors are yellow for easy identification.**

When the air bags inflate, a fairly loud noise may be heard, followed by the release of smoke. This smoke is not harmful and does not indicate a fire. Care should be taken not to inhale it, as it may cause irritation and choking. Those with a history of a breathing condition should get fresh air promptly.

### Supplemental front-impact air bag system

The driver's supplemental front-impact air bag is located at the center of the steering wheel. The passenger's supplemental front-impact air bag is located at the instrument panel above the glove box.

The supplemental front-impact air bag system is designed to inflate in higher severity frontal collisions, although it may inflate if the forces in another type of collision are similar to those of a higher severity frontal impact. It may not inflate in certain frontal collisions. Vehicle damage (or lack of it) is not always an indication of proper supplemental front-impact air bag system operation.

### Supplemental driver's knee air bag system (if equipped)

The supplemental driver's knee air bag is located under the steering column.

The supplemental driver's knee air bag system is designed to inflate in higher severity frontal collisions, although it may inflate if the forces in another type of collision are similar to those of

a higher severity impact. It may not inflate in certain collisions.

Vehicle damage (or lack of it) is not always an indication of proper supplemental driver's knee air bag system operation.

### Supplemental side-impact air bag system (if equipped)

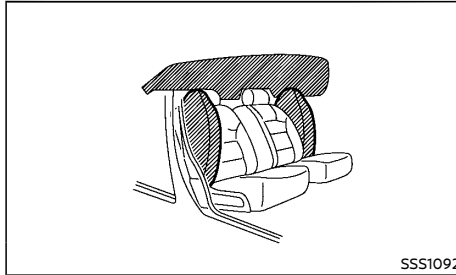

The supplemental side-impact air bag is located at the outside of the front seats' seat-backs.

The supplemental side-impact air bag system is designed to inflate in higher severity side collisions, although it may inflate if the forces in another type of collision are similar to those of a higher severity side impact. It may not inflate in certain side collisions. Vehicle damage (or lack of it) is not always an indication of proper supplemental side-impact air bag system operation.

### Supplemental curtain side-impact air bag system (if equipped)

The supplemental curtain side-impact air bag is located at the roof rails.

The supplemental curtain side-impact air bag system is designed to inflate in higher severity side collisions, although it may inflate if the forces in another type of collision are similar to those of a higher severity side impact. It may not inflate in certain side collisions. Vehicle damage (or lack of it) is not always an indication of proper supplemental curtain side-impact air bag system operation.

### SRS AIR BAG DEPLOYMENT CONDITIONS

The SRS air bags activate in the event of a front or side impact in which the vehicle occupants may be severely injured even if they are wearing the seat belts properly.

They may not activate when the crash energy is absorbed and/or distributed by the vehicle body. Vehicle damage (or lack of it) is not always an indication of proper SRS air bag system operation.

### When the SRS air bag will deploy

#### Supplemental front-impact air bags and driver's knee air bag (if equipped):

The supplemental front-impact air bag and driver's knee air bag (if equipped) systems are designed to inflate in higher severity frontal collisions. Some examples are shown in the following illustrations.

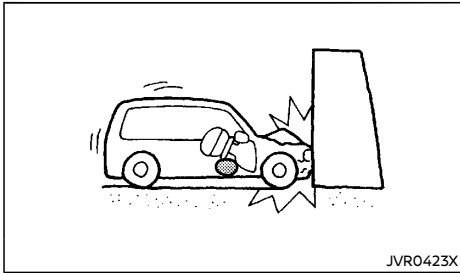

The supplemental front-impact air bag and driver's knee air bag (if equipped) systems will deploy in the event of an impact which exceeds a 25 km/h (16 MPH) frontal collision with a solid wall that does not move or deform.

The supplemental front-impact air bag and driver's knee air bag (if equipped) systems may also deploy when the vehicle receives severe damage to the undercarriage.

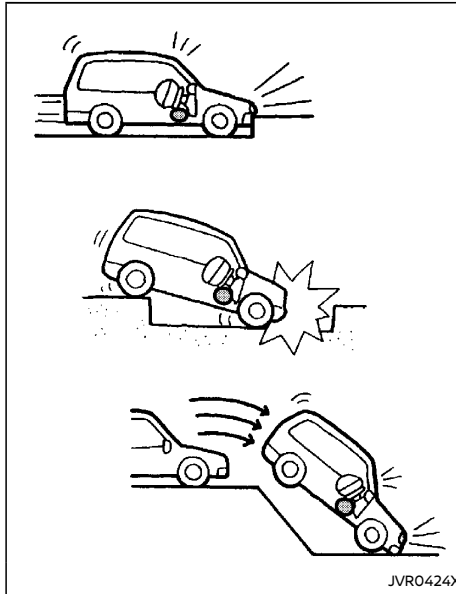

- Hitting a curb, pavement edge or hard surface at high speed
- Falling into a deep hole or ditch
- Landing hard on the ground after jumping

**Supplemental side-impact and curtain side-impact air bags (if equipped):**

The supplemental side-impact and curtain side-impact air bag systems are designed to inflate in higher severity side collisions. Some examples are shown in the following illustrations.

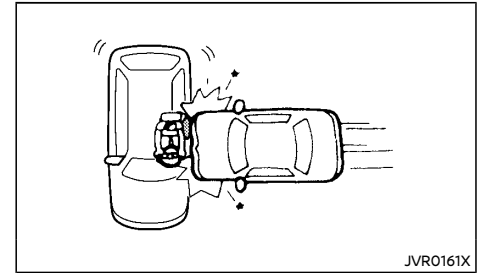

**(supplemental side-impact air bag system)**

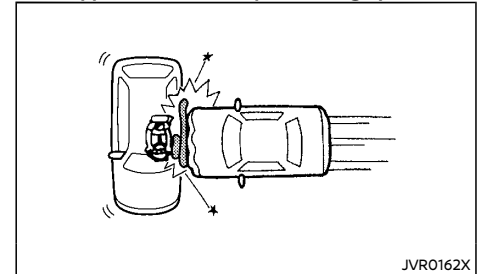

**(supplemental curtain side-impact air bag system)**

- The supplemental side-impact and curtain side-impact air bags will deploy in the event of a side impact with a normal passenger vehicle that exceeds at a speed of 25 km/h (16 MPH).

When the SRS air bag is unlikely to deploy

The SRS air bags may not deploy in cases where the impact is not forceful enough to inflate the SRS air bags.

For example, if the vehicle strikes an object, such as a parked vehicle or sign pole, which can move or deform on impact, the SRS air bags are

unlikely to deploy.

**Supplemental front-impact air bags and driver's knee air bag (if equipped):**

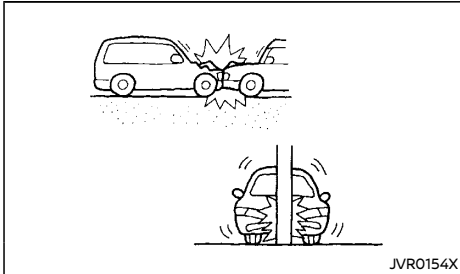

- Striking a vehicle of the same class that is parked
- Crashing into a solid utility pole

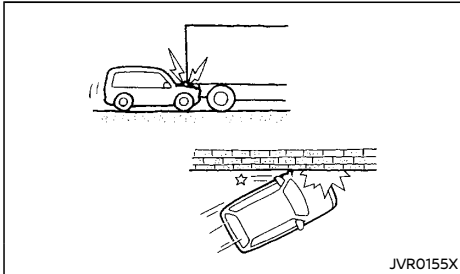

- Running under the tailgate of a truck
- A frontal offset impact to the guard rails

**Supplemental side-impact and curtain side-impact air bags (if equipped):**

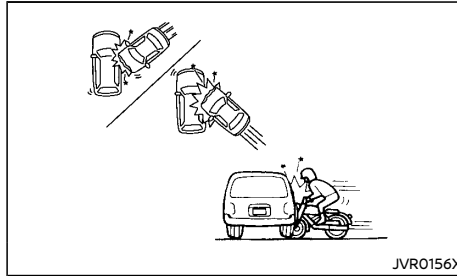

- A collision from the side at an angle
- A side impact with a two-wheeled vehicle

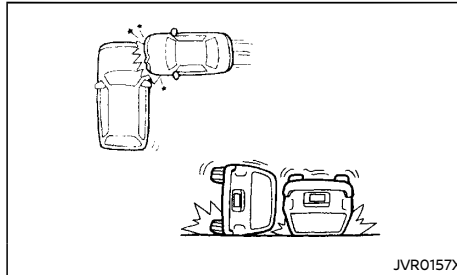

- A collision from the side impacting the vehicle engine room (truck box area)
- Vehicle rollover

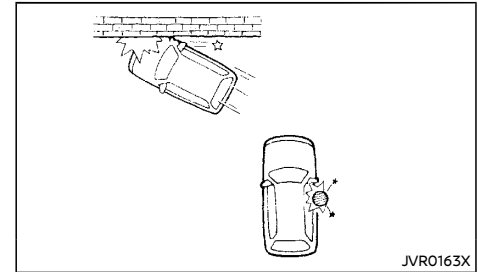

- A frontal offset impact to the guard rails
- A collision with a pole

**When the SRS air bag will not deploy**

Once the SRS air bag has inflated, the air bag module will not function again if your vehicle collides with another vehicle or an object.

Other examples where the SRS air bag will not deploy are shown in the following illustrations.

**Supplemental front-impact air bags and driver's knee air bag (if equipped):**

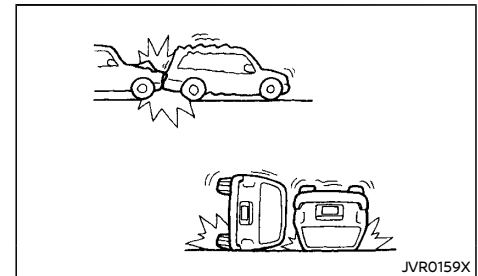

- A collision from the side or rear

- Vehicle rollover

**Supplemental side-impact and curtain side-impact air bags (if equipped):**

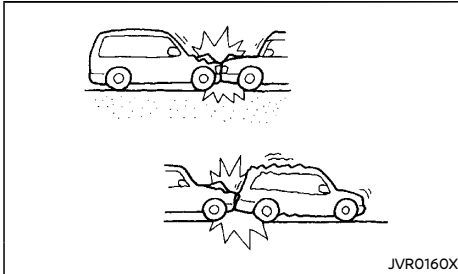

- A frontal collision with a parked or moving vehicle
- A rear collision

**PRE-TENSIONER SEAT BELT SYSTEM (if equipped)**

**WARNING:**

- The pre-tensioner seat belt cannot be reused after activation. It must be replaced together with the retractor and buckle as a unit.
- If the vehicle becomes involved in a collision but the pre-tensioner is not activated, be sure to have the pre-tensioner system checked and, if necessary, replaced by a NISSAN dealer.
- No unauthorized changes should be made to any components or wiring of the pre-tensioner seat belt system. This is to prevent accidental activation of the pre-tensioner seat belt or damage to the pre-tensioner seat belt system.

- Work around or on the pre-tensioner seat belt system should be done by a NISSAN dealer. The SRS wiring should not be modified or disconnected. Unauthorized electrical test equipment and probing devices should not be used on the pre-tensioner seat belt system.
- If you need to dispose of the pre-tensioner seat belt system, or scrap the vehicle, contact a NISSAN dealer. Correct pre-tensioner disposal procedures are set forth in the appropriate NISSAN Service Manual. Incorrect disposal procedures could cause personal injury.

The pre-tensioner is encased with the front seat belt's retractor and anchor. These seat belts are used the same as conventional seat belts.

When the pre-tensioner seat belt activates, a fairly loud noise may be heard, followed by the release of smoke. This smoke is not harmful and does not indicate a fire. Care should be taken not to inhale it, as it may cause irritation and choking. Those with a history of a breathing condition should get fresh air promptly.

**REPAIR AND REPLACEMENT PROCEDURE**

**WARNING:**

- Once the supplemental front-impact air bags have been inflated, the air bag modules will not function and must be replaced. The air bag modules must be replaced by a NISSAN dealer. The inflated air bag modules cannot be repaired.
- The air bag systems should be inspected by a NISSAN dealer if there is any damage to the vehicle.

- If you need to dispose of the SRS or scrap the vehicle, contact a NISSAN dealer. Correct disposal procedures are set forth in the appropriate NISSAN Service Manual. Incorrect disposal procedures could cause personal injury.

The supplemental front-impact air bags and pre-tensioner seat belts (if equipped) are designed to activate on a one-time-only basis. As a reminder, unless the SRS air bag warning light is damaged, the SRS air bag warning light remains illuminated after inflation has occurred. The repair and replacement of the SRS should be done only by a NISSAN dealer.

When maintenance work is required on the vehicle, information about the air bags, pre-tensioner seat belts and related parts should be pointed out to the person performing the maintenance. The ignition switch should always be in the "LOCK" position when working under the hood or inside the vehicle.

# 2 Instruments and controls

Cockpit .....	2-3	Oil control system (if equipped for diesel engine model) .....	2-31
Left-Hand Drive (LHD) model .....	2-3	Headlight and turn signal switch .....	2-33
Right-Hand Drive (RHD) model .....	2-4	Headlight switch .....	2-33
Instrument panel .....	2-5	Headlight aiming control (if equipped) .....	2-34
Left-Hand Drive (LHD) model .....	2-5	Battery saver system .....	2-35
Right-Hand Drive (RHD) model .....	2-6	Turn signal switch .....	2-35
Meters and gauges .....	2-7	Fog light switch (if equipped) .....	2-36
Speedometer and odometer .....	2-8	Front fog lights (if equipped) .....	2-36
Tachometer .....	2-8	Rear fog light (if equipped) .....	2-37
Engine coolant temperature gauge .....	2-9	Cargo light switch (if equipped) .....	2-37
Fuel gauge .....	2-9	Wiper and washer switch .....	2-37
Instrument brightness control .....	2-10	Windshield wiper and washer switch .....	2-37
Compass (if equipped) .....	2-11	Defogger switch (if equipped) .....	2-38
Zone variation change procedure .....	2-11	Horn .....	2-39
Warning lights, indicator lights and audible reminders .....	2-13	Windows .....	2-39
Checking lights .....	2-14	Manual windows (if equipped) .....	2-39
Warning lights .....	2-14	Power windows (if equipped) .....	2-39
Indicator lights .....	2-17	Auto slide back window system (if equipped) .....	2-41
Audible reminders .....	2-19	Sunroof (if equipped) .....	2-41
Vehicle information display (models with color display) .....	2-20	Automatic sunroof .....	2-41
Indicators for operation .....	2-21	Power outlets .....	2-42
Maintenance indicators .....	2-24	Storage .....	2-44
Trip computer .....	2-25	Glove box .....	2-44
Oil control system (if equipped for diesel engine model) .....	2-29	Console box (if equipped) .....	2-44
Clock and outside air temperature (if equipped) .....	2-30	Sunglasses holder (if equipped) .....	2-44
Vehicle information display (models without color display) .....	2-30	Cup holders .....	2-44
Outside air temperature (if equipped) .....	2-31	Roof rack (if equipped) .....	2-45
Trip computer .....	2-31	Card holder (if equipped) .....	2-46
		Sun visors .....	2-46
		Interior lights .....	2-47
		Interior light switch (if equipped) .....	2-47

Console light (if equipped) .....	2-47
Map lights .....	2-47
Map light control switch (if equipped) .....	2-47
Room light (if equipped) .....	2-48

Rear personal light (if equipped) .....	2-48
Vanity mirror lights (if equipped) .....	2-48
Battery saver system .....	2-49

## COCKPIT

### LEFT-HAND DRIVE (LHD) MODEL

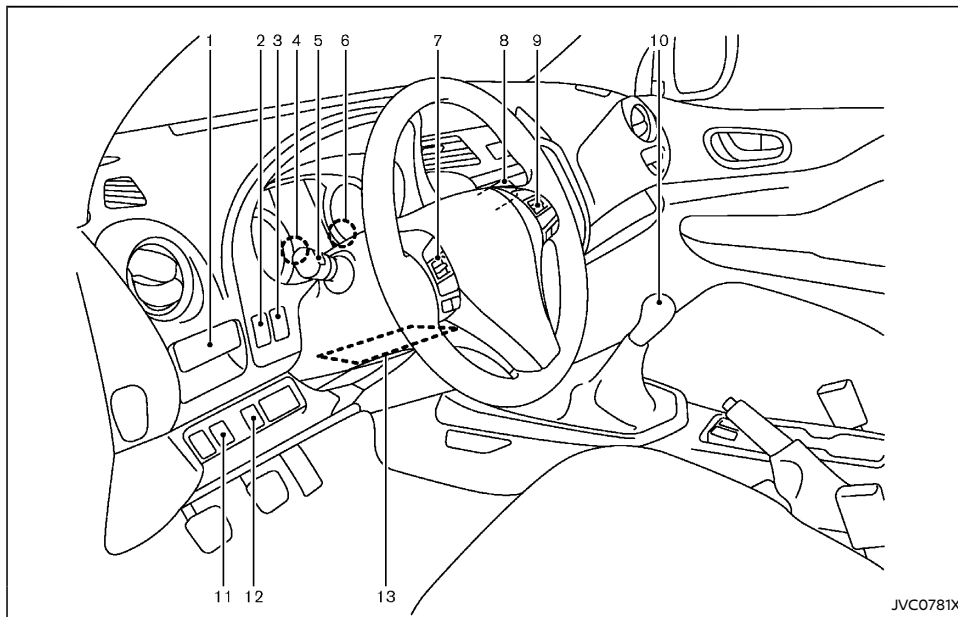

1. Cup holder
2. Instrument brightness control switch (models with color display)
3. TRIP/RESET switch for twin trip odometer (models with color display)
4. Instrument brightness control switch/Trip computer mode switch (models without color display)

5. Headlight, fog light and turn signal switch
  - Headlight
  - Turn signal
  - Fog light\*
6. TRIP/RESET switch for twin trip odometer/Trip computer mode switch (models without color display)
7. Steering-wheel-mounted controls\* (left side)

- Audio control steering switch\*
  - Vehicle information display control switch\*
  8. Wiper and washer switch
  9. Steering-wheel-mounted controls\* (right side)
    - Cruise control system\*
    - Hands-Free Phone System switch\*
    - Voice recognition system switch\*
  10. Shift lever
    - Automatic Transmission (AT)
    - Manual Transmission (MT)
  11. Vehicle Dynamic Control (VDC) OFF switch\*
  12. Fuel-filler lid opener switch\*
  13. Tilting steering wheel lever\*
- \*: if equipped

## RIGHT-HAND DRIVE (RHD) MODEL

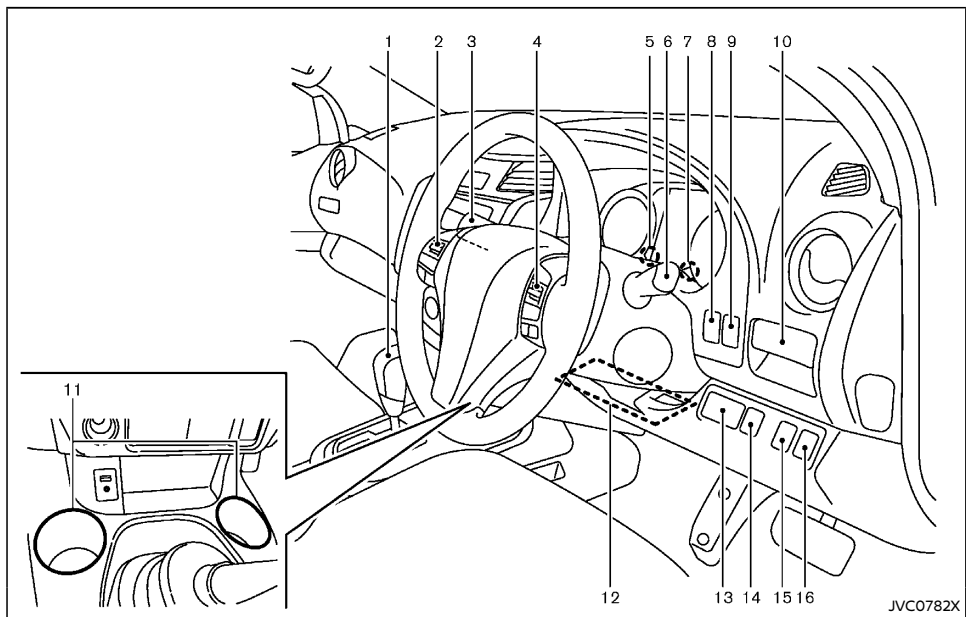

- |  |   |
|--|---|
| <p>1. Shift lever<br/>           – Automatic Transmission (AT)<br/>           – Manual Transmission (MT)</p> <p>2. Steering-wheel-mounted controls* (left side)<br/>           – Audio control steering switch*<br/>           – Vehicle information display control switch*</p> | <p>3. Wiper and washer switch</p> <p>4. Steering-wheel-mounted controls* (right side)<br/>           – Cruise control system*<br/>           – Hands-Free Phone System switch*<br/>           – Voice recognition system switch*</p> <p>5. Instrument brightness control switch/ Trip computer mode switch (models without color display)</p> |
|--|---|

6. Headlight, fog light and turn signal switch  
 – Headlight  
 – Turn signal  
 – Fog light\*
7. TRIP/RESET switch for twin trip odometer/Trip computer mode switch (models without color display)
8. TRIP/RESET switch for twin trip odometer (models with color display)
9. Instrument brightness control switch (models with color display)
10. Cup holder\*
11. Cup holder (for front bench seat models)
12. Tilting steering wheel lever\*
13. Auto slide back window switch\*
14. Fuel-filler lid opener switch\*
15. Vehicle Dynamic Control (VDC) OFF switch\*
16. Headlight aiming control switch\*
- \*: if equipped



## INSTRUMENT PANEL

### LEFT-HAND DRIVE (LHD) MODEL

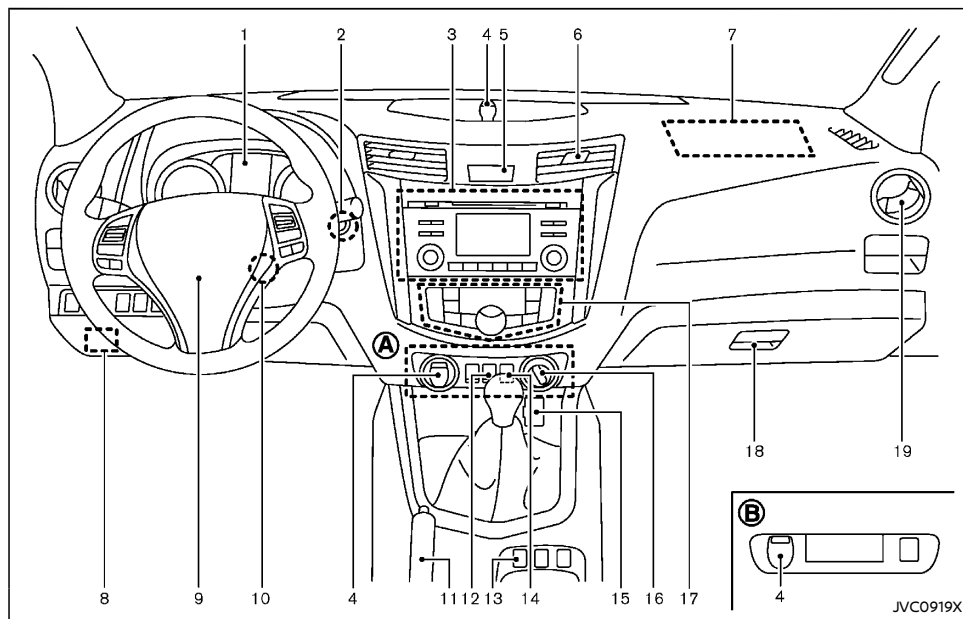

1. Meters and gauges
  - Vehicle information display
2. Push-button ignition switch (models with Intelligent Key system)
3. Audio system\*
  - Rear view monitor\*
  - Around View Monitor\*
4. Power outlet
5. Hazard indicator flasher switch
6. Center ventilator
7. Front passenger's supplemental front-impact air bag\*
8. Hood release handle
9. Steering wheel
  - Horn
  - Driver's supplemental front-impact air bag\*

- Power steering
10. Ignition switch (models without Intelligent Key system)
  11. Parking brake
    - Operation
    - Check
  12. Hill descent control switch\*
  13. Cargo light switch\*
  14. Differential lock mode switch\*
  15. USB (Universal Serial Bus) connection port/iPod connection port
    - Auxiliary (AUX) input jack
  16. Four-Wheel Drive (4WD) mode switch\*
  17. Heater and air conditioner control
  18. Glove box
    - Fuse box
  19. Side ventilator
- Ⓐ: 4WD models  
Ⓑ: 2WD models  
\*: if equipped

## RIGHT-HAND DRIVE (RHD) MODEL

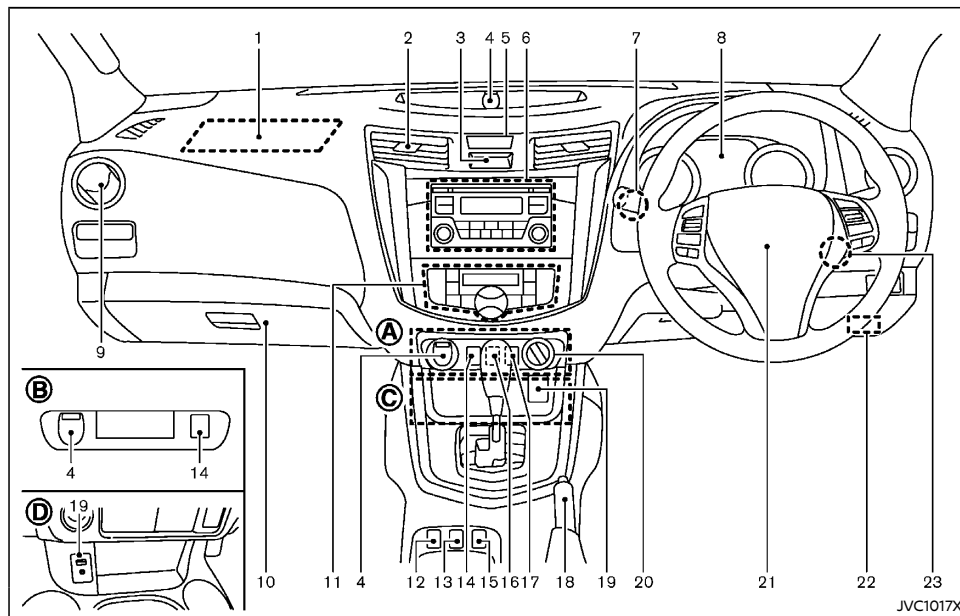

- |  |   |
|--|---|
| 1. Front passenger's supplemental front-impact air bag*                                  | 7. Push-button ignition switch (models with Intelligent Key system) |
| 2. Center ventilator   | 8. Meters and gauges<br>— Vehicle information display               |
| 3. Hazard indicator flasher switch   | 9. Side ventilator  |
| 4. Power outlet  | 10. Glove box<br>— Fuse box   |
| 5. Rear seat belt warning light*   | 11. Heater* and air conditioner control                             |
| 6. Audio system* or Navigation system*<br>— Rear view monitor*<br>— Around View Monitor* |   |

- |  |
|--|
| 12. Heated seat switch*  |
| 13. Diesel Particulate Filter (DPF) regeneration switch*   |
| 14. Parking sensor (sonar) system off switch*  |
| 15. Heated seat switch* or Diesel Particulate Filter (DPF) regeneration switch* or Cargo light switch* |
| 16. Hill descent control switch*   |
| 17. Differential lock mode switch*   |
| 18. Parking brake<br>— Operation<br>— Check  |
| 19. USB (Universal Serial Bus) connection port/iPod connection port*<br>— Auxiliary (AUX) input jack*  |
| 20. Four-Wheel Drive (4WD) mode switch*  |
| 21. Steering wheel<br>— Horn<br>— Driver's supplemental front-impact air bag*<br>— Power steering      |
| 22. Hood release handle  |
| 23. Ignition switch (models without Intelligent Key system)  |

Ⓐ: 4WD models

Ⓑ: 2WD models

Ⓒ: Except for front bench seat models

Ⓓ: For front bench seat models

\*: if equipped

## METERS AND GAUGES

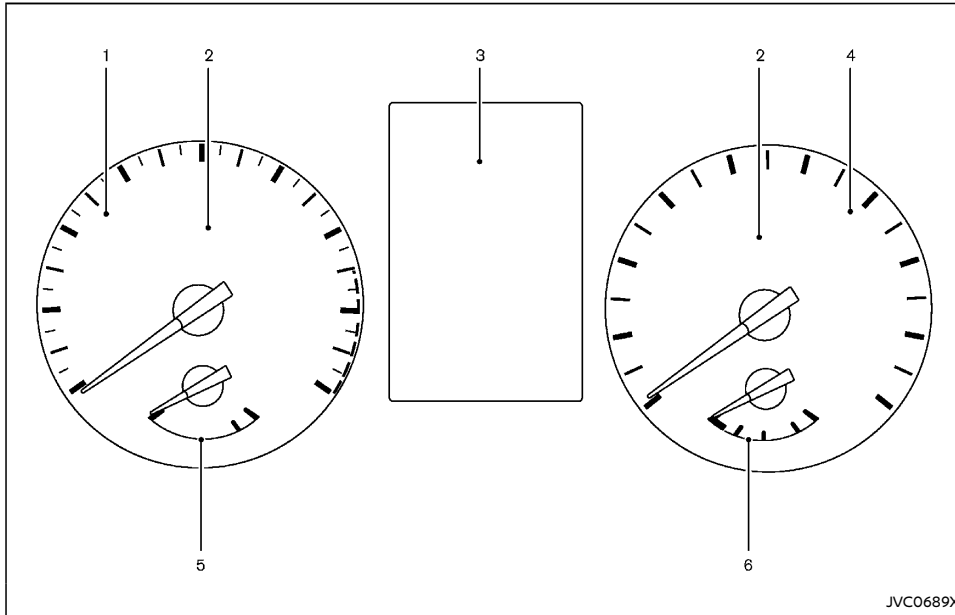

**"OFF" position. This is not a malfunction.**

- |  |  |
|--|--|
| <ol style="list-style-type: none"> <li>1. Tachometer</li> <li>2. Warning/Indicator lights</li> <li>3. Vehicle information display             <ul style="list-style-type: none"> <li>– Engine coolant temperature gauge (models without color display)</li> <li>– Fuel gauge (models without color display)</li> <li>– Four-Wheel Drive (4WD) mode indicator*</li> <li>– Oil control system*</li> <li>– Odometer/twin trip odometer</li> </ul> </li> </ol> | <ul style="list-style-type: none"> <li>– Trip computer</li> <li>– Instrument brightness control</li> <li>– Automatic Transmission (AT) position indicator (AT model)</li> <li>4. Speedometer</li> <li>5. Engine coolant temperature gauge (models with color display)</li> <li>6. Fuel gauge (models with color display)</li> </ul> <p>*: If equipped</p> <p><b>The needle indicators may move slightly after the ignition switch is placed in the</b></p> |
|--|--|

## SPEEDOMETER AND ODOMETER

### Speedometer

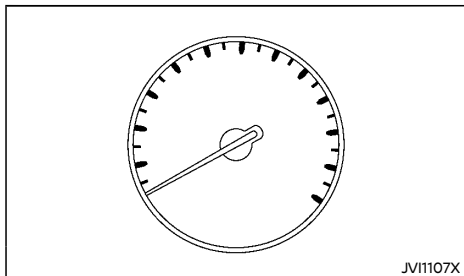

The speedometer indicates the vehicle speed.

### Odometer (models with color display)

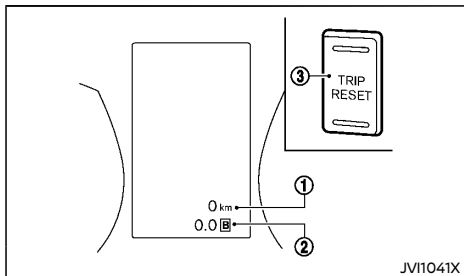

#### Odometer/Twin trip odometer:

The odometer/twin trip odometer is displayed in the vehicle information display when the ignition switch is in the "ON" position.

The odometer ① displays the total distance the vehicle has been driven.

The twin trip odometer ② displays the distance

of individual trips.

#### Changing twin trip odometer display:

Push the TRIP RESET switch ③ (located on the instrument panel) to change the display as follows:

TRIP A → TRIP B → TRIP A

#### Resetting twin trip odometer:

Push the TRIP RESET switch ③ for more than 1 second to reset the trip odometer to zero.

Odometer (models without color display)

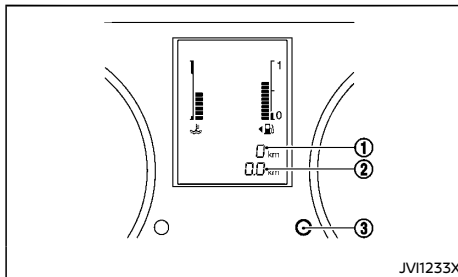

#### Odometer/twin trip odometer:

The odometer/twin trip odometer is displayed when the ignition switch is in the "ON" position.

The odometer ① displays the total distance the vehicle has been driven.

The twin trip odometer ② displays the distance of individual trips.

#### Changing trip odometer display:

Push the trip odometer reset switch ③ to change the display as follows:

TRIP A → TRIP B → Trip computer mode → TRIP A

For trip computer information, see "Trip computer" (P.2-31).

#### Resetting trip odometer:

Push the trip odometer reset switch ③ for approximately 1 second to reset the trip odometer to zero.

### TACHOMETER

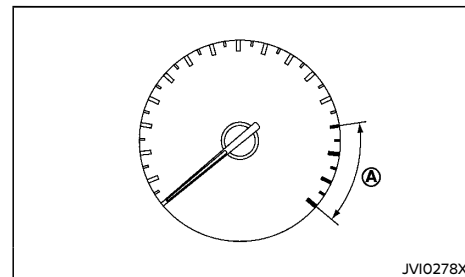

The tachometer indicates the engine speed in revolutions per minute (rpm). **Do not rev the engine into the red zone A.**

The red zone varies with models.

## ENGINE COOLANT TEMPERATURE GAUGE

### Models with color display

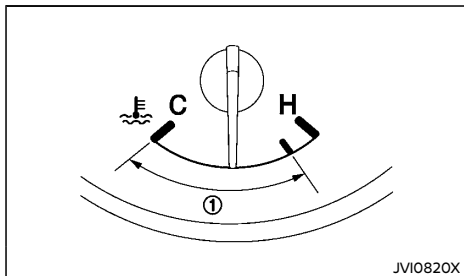

The engine coolant temperature gauge indicates the engine coolant temperature.

The engine coolant temperature is normal when the gauge needle points within the zone ① shown in the illustration.

The engine coolant temperature will vary with the outside air temperature and driving conditions.

### Models without color display

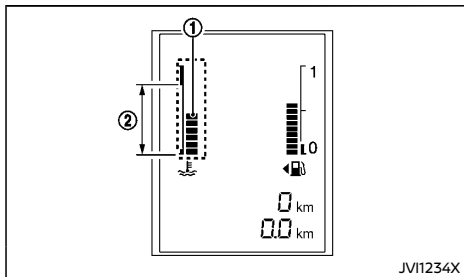

The engine coolant temperature gauge ① indicates the engine coolant temperature.

The engine coolant temperature is normal when the gauge is within the zone ② shown in the illustration.

The engine coolant temperature will vary with the outside air temperature and driving conditions.

### CAUTION:

- If the gauge indicates the engine coolant temperature is near the hot (H) end of the normal range, reduce vehicle speed to decrease the temperature.
- If the gauge is over the normal range, stop the vehicle as soon as safely possible and let the engine idle.
- If the engine is overheated, continued operation of the vehicle may seriously damage the engine. (See "If your vehicle overheats" (P.6-11) for immediate action required.)

## FUEL GAUGE

### Models with color display

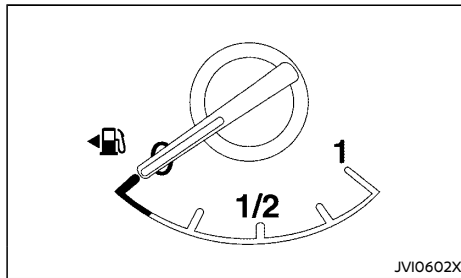

The fuel gauge indicates the approximate fuel level in the tank when the ignition switch is in the "ON" position.

The gauge may move slightly during braking, turning, accelerating, or going up and down hills due to movement of fuel in the tank.

The low fuel warning appears on the vehicle information display when the fuel level in the tank is getting low. Refuel as soon as it is convenient, preferably before the gauge reads the empty (0) position.

The arrow, , indicates that the fuel-filler lid is located on the left side of the vehicle.

### CAUTION:

**Refuel before the gauge reads the empty (0) position.**

There is a small reserve of fuel in the tank when the fuel gauge reads the empty (0) position.

### Models without color display

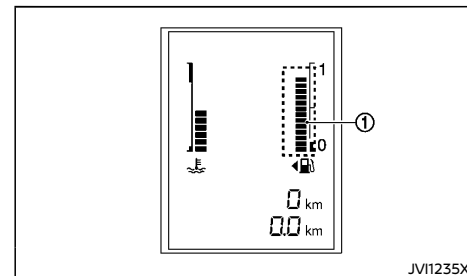

The fuel gauge ① indicates the approximate fuel level in the tank when the ignition switch is in the "ON" position.

The gauge may move slightly during braking,

turning, accelerating, or going up and down hills due to movement of fuel in the tank.

The low fuel warning light illuminates when the fuel level in the tank is getting low. Refuel as soon as it is convenient, preferably before the gauge reads 0.

The arrow, , indicates that the fuel-filler lid is located on the left side of the vehicle.



### CAUTION:

**Refuel before the gauge reads 0 (empty).**

There is a small reserve of fuel in the tank when the fuel gauge reads 0 (empty).

## INSTRUMENT BRIGHTNESS CONTROL

### Models with color display

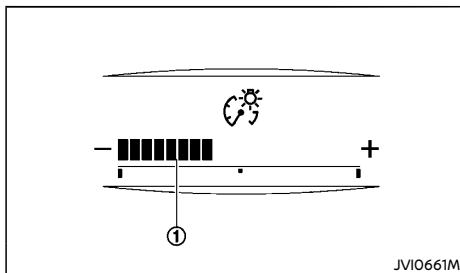
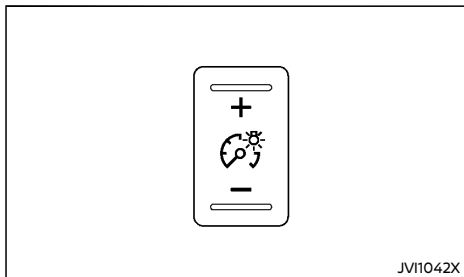

The instrument brightness control switch can be operated when the ignition switch is in the "ON" position. When the switch is operated, the vehicle information display switches to the brightness adjustment mode.



Push the + side of the switch to brighten the meter panel lights. The bar ① moves to the + side.

Push the - side of the switch to dim the lights. The bar ① moves to the - side.

The vehicle information display returns to the normal display when the instrument brightness control switch is not operated for more than 5 seconds.

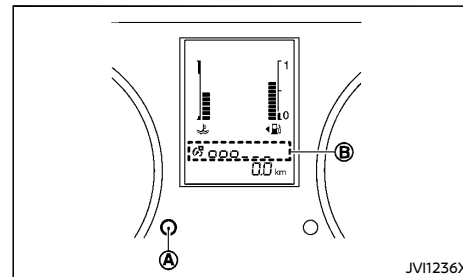
### Models without color display





The instrument brightness control operates when the ignition switch is in the "ON" position and the headlight switch is in either the  or  position.

Turn the instrument brightness control switch ① to adjust the brightness of the meter. The brightness indicator ② will be shown briefly in the vehicle information display when the control is turned.

When the brightness level reaches the maximum or minimum, a beep will sound.

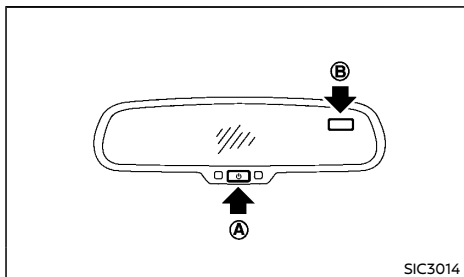
## COMPASS (if equipped)



When the  switch **(A)** is pushed, the compass display **(B)** will indicate the direction of the vehicle's heading.

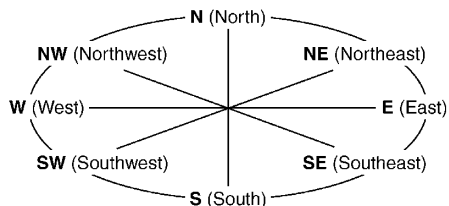

If the display reads "C" or the  switch is pushed for 9 seconds, calibrate the compass by driving the vehicle in 3 complete circles at less than 8 km/h (5 MPH). You can also calibrate the compass by driving your vehicle on your everyday route. The compass will be calibrated once it has tracked 3 complete circles.

To turn off the compass, push **(A)** again.

## ZONE VARIATION CHANGE PROCEDURE

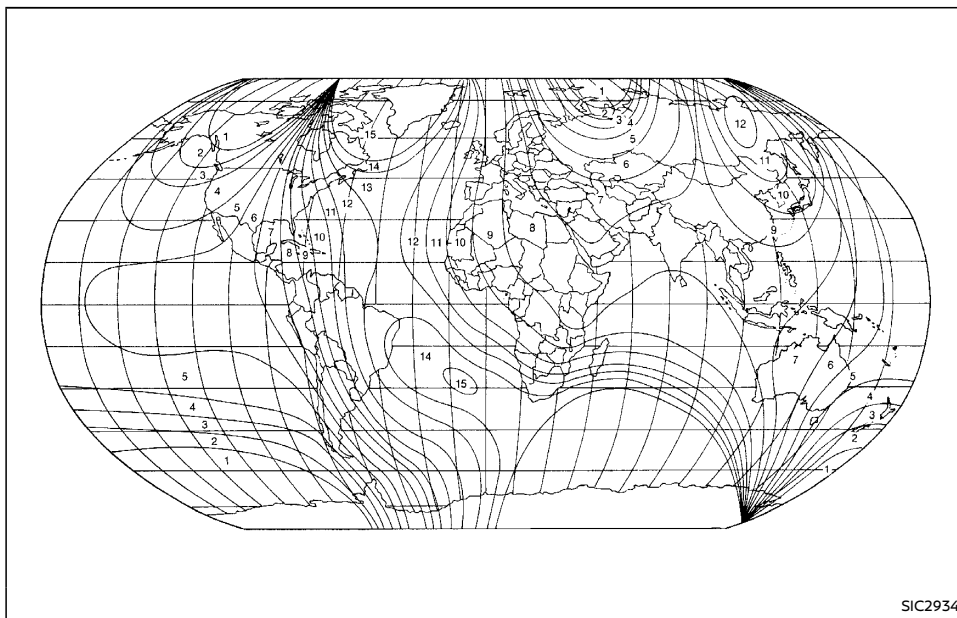

**Zone map**

The difference between magnetic north and geographical north is known as variance. In some areas, this difference can sometimes be great enough to cause false compass readings. Follow these instructions to set the variance for your particular location if this happens:

1. Push the  switch **(A)** for 6 seconds. The current zone number will appear in the display.

2. Find your current location and variance number on the zone map.
  3. Push the  switch **(A)** repeatedly until the new zone number appears in the display. After you release the switch, the display will show a compass direction within a few seconds.
- If the compass deviates from the correct indication soon after repeated adjustment, have the compass checked at a NISSAN

dealer.

- The compass may not indicate the correct compass point in tunnels or while driving up or down a steep hill. (The compass returns to the correct compass point when the vehicle moves to an area where the geomagnetism is stabilized.)































**CAUTION:**

- **Do not install a ski rack, antenna, etc. which are attached to the vehicle by means of a magnet. They affect the operation of the compass.**
- **When cleaning the mirror, use a paper towel or similar material dampened with glass cleaner. Do not spray glass cleaner directly on the mirror as it may cause the liquid cleaner to enter the mirror housing.**

















## WARNING LIGHTS, INDICATOR LIGHTS AND AUDIBLE REMINDERS

	Anti-lock Braking System (ABS) warning light*		Low fuel warning light		High beam indicator light
	Automatic Transmission (AT) check warning light (AT model)		Malfunction warning light (red)*		Hill descent control system on indicator light*
	Automatic Transmission (AT) oil temperature warning light (AT model)		Master warning light*		Malfunction Indicator Light (MIL)
	Automatic Transmission (AT) park warning light (AT model)		Seat belt warning light*		Rear fog light indicator light*
	Brake warning light		Supplemental Restraint System (SRS) air bag warning light*		Security indicator light*
	Charge warning light		Vehicle Dynamic Control (VDC) warning light*		Small light indicator light*
	Diesel Particulate Filter (DPF) warning light*		Water-in-fuel-filter warning light*		Turn signals/hazard indicator lights
	Door open warning light		Differential lock indicator light*		Vehicle Dynamic Control (VDC) off indicator light*
	Engine oil pressure warning light		Front fog lights indicator light*		
	Four-Wheel Drive (4WD) warning light (4WD model)		Glow plug indicator light*		

\*: if equipped

## CHECKING LIGHTS

With all doors closed, apply the parking brake, fasten the seat belts and place the ignition switch in the "ON" position without starting the engine. The following lights (if equipped) will come on: , , , , . **4WD.**

The following lights (if equipped) will come on briefly and then go off: , , ,  <sup>AT</sup> **CHECK**, **ATP**, , ,  **OFF**, , .

If any light does not come on or operates in a way other than described, it may indicate a burned-out bulb and/or a system malfunction. Have the system checked, and if necessary repaired, by a NISSAN dealer promptly.

### Models with color display:

Some indicators and warnings are also displayed on the vehicle information display between the speedometer and tachometer. (See "Vehicle information display (models with color display)" (P.2-20).)

## WARNING LIGHTS

### Anti-lock Braking System (ABS) warning light (if equipped)

When the ignition switch is in the "ON" position, the Anti-lock Braking System (ABS) warning light illuminates and then turns off. This indicates the ABS is operational.

If the ABS warning light illuminates while the engine is running, or while driving, it may indicate the ABS is not functioning properly. Have the system checked by a NISSAN dealer promptly.

If an ABS malfunction occurs, the anti-lock function is turned off. The brake system then operates normally, but without anti-lock assistance. (See "Anti-lock Braking System (ABS)"

(P.5-35).)

**While the differential lock (if equipped) is engaged, the ABS warning light illuminates. This indicates that the anti-lock function is not fully operating.** (See "Rear differential locking system" (P.5-23) for the rear differential lock function.)

### Automatic Transmission (AT) check warning light (AT model)

When the ignition switch is in the "ON" position, the Automatic Transmission (AT) check warning light illuminates and then turns off. This indicates that the AT is operational.

If the AT check warning light illuminates while the engine is running, or while driving, it may indicate that the AT is not functioning properly and may need servicing. Have the system checked, and if necessary repaired, by a NISSAN dealer promptly.

### Automatic Transmission (AT) oil temperature warning light (AT model)

This light illuminates when the Automatic Transmission (AT) oil temperature is too high. If the light illuminates while driving, reduce the vehicle speed as soon as safely possible until the light turns off.

### **CAUTION:**

**Continued vehicle operation when the AT oil temperature warning light is on may damage the AT.**

### Automatic Transmission (AT) park warning light (AT model)

This light indicates that the Automatic Transmission (AT) parking function is not engaged. If the transfer control is not secured in any driving position while the AT shift lever is in the "P" (Park) position, the transmission will disengage and the wheels will not lock.

**For 4WD model: If the ATP warning light illuminates with the shift lever in the "P" (Park) position, shift the Four-Wheel Drive (4WD) mode switch to the 2WD, 4H or 4LO position again with the shift lever in the N (Neutral) position.** (See "Four-Wheel Drive (4WD)" (P.5-17).)

### **WARNING:**

**If the 4WD mode indicator (see "4WD mode indicator" (P.5-21)) is "OFF" or the ATP warning light is "ON", this indicates that the automatic transmission P (Park) position will not function and could result in the vehicle moving unexpectedly, causing serious personal injury or property damage. Always set the parking brake.**

### Brake warning light

### **WARNING:**

- **If the brake fluid level is below the minimum mark on the brake fluid reservoir, do not drive the vehicle until the brake system has been checked by a NISSAN dealer.**

- **Even if you judge it to be safe, have your vehicle towed because driving it could be dangerous.**
- **Depressing the brake pedal without the engine running and/or with a low brake fluid level could increase the stopping distance and require greater pedal travel distance and effort.**

The brake warning light indicates the parking brake system operation, a low brake fluid level of the brake system and an Anti-lock Braking System (ABS) malfunction.

#### **Parking brake warning indicator:**

When the ignition switch is placed in the "ON" position, the brake warning light illuminates. When the engine is started and the parking brake is released, the brake warning light turns off.

If the parking brake is not fully released, the brake warning light remains on. Be sure that the brake warning light has turned off before driving. (See "Parking brake" (P.3-25).)

#### **Low brake fluid warning indicator:**

If the brake warning light illuminates while the engine is running, or while driving, and the parking brake is released, it may indicate the brake fluid level is low.

When the brake warning light illuminates while driving, stop the vehicle safely as soon as possible. Stop the engine and check the brake fluid level. If the brake fluid level is at the minimum mark, add brake fluid as necessary. (See "Brake fluid" (P.8-16).)

If the brake fluid level is sufficient, have the brake system checked by a NISSAN dealer promptly.

#### **Anti-lock Braking System (ABS) warning indicator (if equipped):**

When the parking brake is released and the brake fluid level is sufficient, if both the brake warning light and the Anti-lock Braking System (ABS) warning light illuminate, it may indicate the ABS is not functioning properly. Have the brake system checked, and if necessary repaired, by a NISSAN dealer promptly. (See "Anti-lock Braking System (ABS) warning light" (P.2-14).)

#### Charge warning light

When the ignition switch is in the "ON" position, the charge warning light illuminates. After starting the engine, the charge warning light turns off. This indicates that the charging system is operational.

If the charge warning light illuminates while the engine is running, or while driving, it may indicate that the charging system is not functioning properly and may need servicing.

When the charge warning light illuminates while driving, stop the vehicle safely as soon as possible. Stop the engine and check the alternator belt. If the alternator belt is loose, broken or missing, the charging system needs repair. (See "Drive belt" (P.8-14).)

If the alternator belt appears to be functioning correctly but the charge warning light remains illuminated, have the charging system checked by a NISSAN dealer promptly.

#### **CAUTION:**

**Do not continue driving if the alternator belt is loose, broken or missing.**

#### Diesel Particulate Filter (DPF) warning light (if equipped)

When the DPF warning light illuminates, it indicates that particulate matter is accumulated to the specified amount of the limit in the filter and the filter needs to regenerate. For filter regeneration details, see "Diesel Particulate Filter (DPF)" (P.5-5).

#### **CAUTION:**

**If you continue driving with the DPF warning light on without performing the filter regeneration, this will lead to particulate matter overload in the filter.**

**If this occurs, then the Malfunction Indicator Light (MIL) will turn on. The performance of the engine might be limited to protect the DPF system. See a NISSAN dealer to perform the service regeneration.**

#### Door open warning light

When the ignition switch is in the "ON" position, the door open warning light illuminates if any of the doors are open or not closed securely.

#### Engine oil pressure warning light

When the ignition switch is in the "ON" position, the engine oil pressure warning light illuminates. After starting the engine, the engine oil pressure warning light turns off. This indicates that the oil pressure sensors in the engine are operational.

If the engine oil pressure warning light illuminates or blinks while the engine is running, it may indicate that the engine oil pressure is low.

Stop the vehicle safely as soon as possible. Stop the engine immediately and call a NISSAN dealer.

 **CAUTION:**

- **Running the engine with the engine oil pressure warning light illuminated could cause serious damage to the engine.**
- **The engine oil pressure warning light is not designed to indicate a low oil level. The oil level should be checked using the dipstick. (See “Engine oil” (P.8-9).)**

 **Four-Wheel Drive (4WD) warning light (4WD model)**

When the ignition switch is in the “ON” position, the Four-Wheel Drive (4WD) warning light illuminates. After starting the engine, the 4WD warning light turns off.

If the 4WD system malfunctions or the revolution or radius of the front and the rear wheel differs, the warning light will either remain illuminated or blink. (See “Four-Wheel Drive (4WD)” (P.5-17).)

 **CAUTION:**

- **If the 4WD warning light illuminates or blinks while driving, reduce the vehicle speed and have your vehicle checked by a NISSAN dealer as soon as possible.**
- **If the Four-Wheel Drive (4WD) warning light turns on when driving on dry hard surface roads:**
  - **in the 4H position, shift the 4WD mode switch to 2WD.**

- **in the 4LO position, stop the vehicle and shift the transmission lever to the “N” (Neutral) position with the brake pedal depressed and shift the 4WD mode switch to 2WD.**

If the warning light is still on after the above operations, have your vehicle checked by a NISSAN dealer as soon as possible.

 **Low fuel warning light**

The low fuel warning light illuminates when the fuel level in the tank is getting low. Refuel as soon as it is convenient, preferably before the fuel gauge reaches the empty (0) position.

**There will be a small reserve of fuel remaining in the tank when the fuel gauge reaches the empty (0) position.**

 **Malfunction warning light (red) (if equipped)**

When the ignition switch is placed in the “ON” position, the malfunction warning light illuminates in red. This means that the system is operational. After starting the engine, the warning light turns off.

For the orange Malfunction Indicator Light (MIL), see “Malfunction Indicator Light (MIL)” (P.2-18) for details.

If the malfunction warning light (red) illuminates continuously while the engine is running, it may indicate an engine control system malfunction. Have your vehicle inspected by a NISSAN dealer. You do not need to have your vehicle towed to the dealer.

 **CAUTION:**

**Continuing vehicle operation without proper servicing of the engine control system could lead to poor driveability, reduced fuel economy, and damage to the engine control system, which may affect the vehicle’s warranty coverage.**

 **Master warning light (if equipped)**

When the ignition switch is in the “ON” position, the master warning light illuminates if any of the following are displayed on the vehicle information display.

- No Key Detected warning (if equipped)
  - Shift to Park warning (Automatic Transmission (AT) models)
  - Key ID Incorrect warning (if equipped)
  - Release Parking Brake warning
  - Low fuel warning
  - Door open warning
  - Low Washer warning (if equipped)
  - Key System Error warning (if equipped)
  - Low Oil Pressure warning (if equipped)
  - 4WD Error (if equipped)
  - Shipping Mode On Push Storage Fuse warning (if equipped)
  - Headlight System Error warning (if equipped)
  - Automatic Transmission (AT) Error warning (Automatic Transmission (AT) models)
  - Parking Sensor Error (if equipped)
- See “Vehicle information display (models with color display)” (P.2-20).

 Seat belt warning light (if equipped)

#### Front seat belts:

When the ignition switch is in the "ON" position, the seat belt warning light illuminates. The light will continue to illuminate until the driver's and/or the front passenger's (if equipped) seat belts are fastened.

When the vehicle speed exceeds 15 km/h (10 MPH), the light will blink and the chime will sound unless the driver's and/or the front passenger's (if equipped) seat belts are securely fastened. The chime will continue to sound for about 95 seconds until the seat belt is fastened.

#### Rear seat belts (if equipped):

The rear seat belt warning lights are located on the instrument panel. When the vehicle speed exceeds 10 km/h (6 MPH), the corresponding warning light illuminates in red if any of the rear passenger's seat belt is not fastened. When the rear passenger's seat belt has been securely fastened, the warning light will turn off. The warning lights will automatically turn off after approximately 35 seconds.

When the vehicle speed exceeds 15 km/h (10 MPH), if a rear passenger unfastens the seat belt, a chime will sound briefly and the rear seat belt warning light will illuminate. The warning light will automatically turn off after approximately 35 seconds.

For precautions on seat belt usage, see "Seat belts" (P.1-8).

 Supplemental Restraint System (SRS) air bag warning light (if equipped)

When the ignition switch is in the "ON" position, the Supplemental Restraint System (SRS) air bag warning light illuminates for about 7 seconds and then turns off. This indicates the SRS air bag system is operational.

If any of the following conditions occur, the SRS air bag system and/or pre-tensioner seat belt (if equipped) need servicing. Have the system checked, and if necessary repaired, by a NISSAN dealer promptly.

- The SRS air bag warning light remains illuminated after about 7 seconds.
- The SRS air bag warning light flashes intermittently.
- The SRS air bag warning light does not come on at all.

Unless checked and repaired, the SRS air bag system and/or pre-tensioner seat belt may not function properly. (See "Supplemental Restraint System (SRS)" (P.1-25).)

 Vehicle Dynamic Control (VDC) warning light (if equipped)

When the ignition switch is in the "ON" position, the Vehicle Dynamic Control (VDC) warning light illuminates and then turns off.

The warning light blinks when the VDC system is operating.

When the warning light blinks while driving, the driving condition is slippery and the vehicle's traction limit is about to be exceeded.

If the VDC warning light illuminates while the engine is running or while driving, it may indicate that the VDC system is not functioning

properly and may need servicing. Have the system checked, and if necessary repaired, by a NISSAN dealer promptly. If a malfunction occurs, the VDC function is turned off, but the vehicle is still drivable. (See "Vehicle Dynamic Control (VDC) system" (P.5-23).)

 Water-in-fuel-filter warning light (if equipped)

#### YD25DDTi engine model:

If the water-in-fuel-filter warning light illuminates while the engine is running, drain the water from the fuel filter promptly. (See "Fuel filter (YD25DDTi engine model)" (P.8-13).)

#### YS23DDT/DDTT engine model:

If the water-in-fuel-filter warning light illuminates while the engine is running, contact a NISSAN dealer as soon as possible.



#### CAUTION:

**Continuing vehicle operation without properly draining could cause serious damage to the engine.**

#### INDICATOR LIGHTS

 Differential lock indicator light (if equipped)

When the differential lock mode switch is in the "ON" position, the differential lock indicator light will blink and then stay on after the differential gear is completely locked.

See "Rear differential locking system" (P.5-23).

 Front fog light indicator light (if equipped)

The front fog light indicator light illuminates when the front fog lights are on. (See "Fog light switch" (P.2-36).)

 Glow plug indicator light (if equipped)

**YD25DDTi engine model:**

When the ignition switch is in the "ON" position, the glow plug indicator light illuminates and turns off after the glow plugs have warmed up.

If the glow plugs have already warmed up, the glow plug indicator flashes briefly and then turns off.

**YS23DDT/DDTT engine model:**

When the ignition switch is in the "ON" position (models without Intelligent Key system) or when the engine is started (models with Intelligent Key system), the glow plug indicator light illuminates and turns off after the glow plugs have warmed up.

If the engine is already warmed up, the glow plug indicator light may not illuminate.

 High beam indicator light

The high beam indicator light illuminates when the headlight high beam is on. The indicator turns off when the low beam is selected. (See "Headlight and turn signal switch" (P.2-33).)

 Hill descent control system ON indicator light (if equipped)

When the ignition switch is in the "ON" position the hill descent control system on indicator light illuminates briefly and then turns off. This indicates that the hill descent control system is operational.

The light illuminates when the hill descent control system is activated.

If the hill descent control switch is on and the indicator light blinks, the system is not engaged.

If the indicator light does not illuminate or blink when the hill descent control switch is on, the system may not be functioning properly. Have the system checked by a NISSAN dealer.

For additional information, see "Hill descent control system" (P.5-25).

 Malfunction Indicator Light (MIL)

 **CAUTION:**

- **Continuing vehicle operation without proper servicing of the engine control system could lead to poor driveability, reduced fuel economy, and damage to the engine control system, which may affect the vehicle's warranty coverage.**
- **Incorrect setting of the engine control system may lead to non-compliance of local and national emission laws and regulations.**

When the ignition switch is in the "ON" position, the Malfunction Indicator Light (MIL) illuminates. After starting the engine, the MIL turns off. This indicates that the engine control

system is operational.

If the Malfunction Indicator Light illuminates or blinks while the engine is running, it may indicate that the engine control system is not functioning properly and may need servicing. Have the system checked, and if necessary repaired, by a NISSAN dealer promptly.

**Precautions:**

To reduce or avoid possible damage to the engine control system when the MIL blinks:

- Avoid driving at speeds above 70 km/h (43 MPH).
- Avoid sudden acceleration or deceleration.
- Avoid going up steep uphill grades.
- Avoid carrying or towing unnecessary loads.

 Rear fog light indicator light (if equipped)

The rear fog light indicator light illuminates when the rear fog light turns on. (See "Fog light switch" (P.2-36).)

 Security indicator light (if equipped)

The security indicator light blinks when the ignition switch is in the "ACC", "OFF" or "LOCK" position. This function indicates that the security system equipped on the vehicle is operational.

If the security system is malfunctioning, this light will remain on while the ignition switch is in the "ON" position. (See "Security system" (P.3-15) for additional information.)

 Small light indicator light (if equipped)

The light illuminates when the headlight switch is turned to the  position.

 Turn signal/hazard indicator lights

The turn signal/hazard indicator lights blink when the turn signal switch lever or hazard indicator flasher switch is on. (See "Headlight and turn signal switch" (P.2-33) or "Hazard indicator flasher switch" (P.6-2).)

 Vehicle Dynamic Control (VDC) off indicator light (if equipped)

When the ignition switch is in the "ON" position, the Vehicle Dynamic Control (VDC) off indicator light illuminates and then turns off.

The VDC off indicator light illuminates when the VDC OFF switch is pushed to the "OFF" position.

When the VDC OFF switch is pushed to the "OFF" position, the VDC system is turned off.

When the rear differential lock is engaged with the differential lock mode switch or the 4LO position is selected with the Four-Wheel Drive (4WD) mode switch, the VDC system is disabled and the VDC off indicator light illuminates. (See "Vehicle Dynamic Control (VDC) system" (P.5-23) and "Rear differential locking system" (P.5-23).)

## AUDIBLE REMINDERS

### Brake pad wear warning

The disc brake pads have audible wear warnings. When a brake pad requires replacement, it will make a high pitched scraping sound when the vehicle is in motion. This scraping sound will first occur only when the brake pedal is depressed. After more wear of the brake pad, the sound will always be heard even if the brake pedal is not depressed. Have the brakes checked as soon as possible if the wear warning sound is heard.

Have the system checked, and if necessary repaired, by a NISSAN dealer promptly. (See "Brakes" (P.8-15).)

### Key reminder chime

The chime will sound if any of the following operations are detected:



#### **Models with Intelligent Key system:**

The chime will sound if the driver side door is opened while the ignition switch is placed in the "ACC" position.

#### **Models without Intelligent Key system:**

The chime sounds if the driver's side door is opened while the key is left in the ignition switch and the ignition switch is in the "ACC", "OFF" or "LOCK" position. Remove the key and take it with you when leaving the vehicle.

### Light reminder chime

The light reminder chime will sound if the driver's side door is opened and the headlight switch is in either the  or  position, and the ignition switch is in the "ACC", "OFF" or "LOCK" position.

Be sure to turn the headlight switch to the "OFF" or "AUTO" (if equipped) position when you leave the vehicle.

### Parking brake reminder chime

The parking brake reminder chime will sound if the vehicle is driven at more than 7 km/h (4 MPH) with the parking brake applied. Stop the vehicle and release the parking brake.

### Seat belt warning chime (if equipped)

When the vehicle speed exceeds 15 km/h (10 MPH), the chime will sound unless the driver's and/or the front passenger's (if equipped) seat belts are securely fastened. The chime will continue to sound for about 95 seconds until the seat belt is fastened.

## VEHICLE INFORMATION DISPLAY (models with color display)

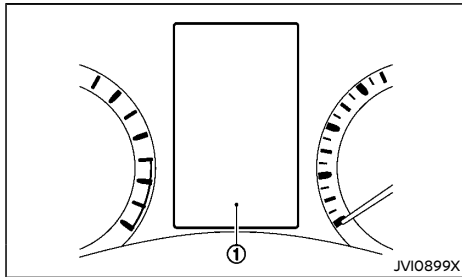













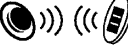



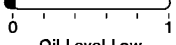









The vehicle information display ① is located between the tachometer and the speedometer, and it displays the warnings and information. The following items are also displayed if the vehicle is equipped with them:

- Automatic Transmission (AT)
  - “Driving with Automatic Transmission (AT)” (P.5-14)
- Four-Wheel Drive (4WD)
  - “Four-Wheel Drive (4WD)” (P.5-17)
- Clock and outside air temperature
  - “Clock and outside air temperature” (P.2-30)
- Trip computer
  - “Trip computer” (P.2-25)
- Cruise control
  - “Cruise control” (P.5-26)
- Intelligent Key system
  - “Intelligent Key system” (P.3-7)
- Oil control system
  - “Oil control system (if equipped for diesel engine model)” (P.2-29)



## INDICATORS FOR OPERATION

 1	 8	 16	 23
 2	 9	 17	 24
 3	 10	 17	 25
 4	 11	 18	 26
 5	 12	 19	 27
 6	 13	 20	 28
 7	 15	 21	 29
		 22	

JVI1207X

### 1. Engine start operation indicator (if equipped for Automatic Transmission (AT) models)

This indicator appears when the shift lever is in the "P" (Park) position.

This indicator means that the engine will start by pushing the ignition switch with the brake pedal depressed. You can start the engine directly in any position of the ignition switch.

### 2. Engine start operation indicator (if equipped for Manual Transmission (MT) models)

This indicator means that the engine will start by pushing the ignition switch with the clutch pedal depressed. You can start the engine directly in any position of the ignition switch.

You can also start the engine by pushing the ignition switch with the brake pedal depressed when the shift lever is in the "N" (Neutral) position.

### 3. Steering lock release malfunction indicator (if equipped)

This indicator appears when the steering wheel cannot be released from the "LOCK" position.

If this indicator appears, push the ignition switch while lightly turning the steering wheel right and left.

See "Steering lock" (P.5-11).

### 4. No Key Detected warning (if equipped)

This warning appears when the door is closed with the Intelligent Key left outside the vehicle and the ignition switch in the "ON" position. Make sure that the Intelligent Key is inside the vehicle.

See "Intelligent Key system" (P.3-7) for more details.

### 5. Key reminder warning (if equipped)

This warning appears if the driver's side door is opened while the key is left in the ignition switch and ignition switch is in the "ACC", "OFF" or "LOCK" position. Remove the key and take it with you when leaving the vehicle.

### 6. Shift to Park warning (if equipped for AT models)

This warning appears when the ignition switch is pushed to stop the engine with the shift lever in any position except the "P" (Park) position.

If this warning appears, move the shift lever to the "P" (Park) position or push the ignition switch to the "ON" position.

An inside warning chime will also sound. (See "Intelligent Key system" (P.3-7).)

### 7. "PUSH" warning (if equipped for AT models)

This warning appears when the shift lever is moved to the "P" (Park) position with the ignition switch in the "ACC" position after the Shift to Park warning appears.

To push the ignition switch to the "OFF" position, perform the following procedure:

**Shift to Park warning** → (Move the shift lever to "P") → **PUSH warning** → (Push the ignition

switch → ignition switch position is turned to "ON") → **PUSH warning** → (Push the ignition switch → ignition switch position is turned to "OFF")

### 8. Key Battery low warning (if equipped)

This warning appears when the Intelligent Key battery is running out of power.

If this warning appears, replace the battery with a new one. (See "Intelligent Key battery" (P.8-23).)

### 9. Engine start operation for Intelligent Key system indicator (if equipped)

This indicator appears when the Intelligent Key battery is running out of power and when the Intelligent Key system and vehicle are not normally communicated.

If this indicator appears, touch the ignition switch with the Intelligent Key while depressing the brake pedal. (See "Intelligent Key battery discharge" (P.5-12).)

### 10. Key ID Incorrect warning (if equipped)

This warning appears when the ignition switch is placed from the "LOCK" position and the Intelligent Key cannot be recognized by the system. You cannot start the engine with an unregistered key. Use the registered Intelligent Key.

See "Intelligent Key system" (P.3-7).

### 11. Release Parking Brake warning

This warning appears when the vehicle speed is above 7 km/h (4 MPH) and the parking brake is applied. Stop the vehicle and release the parking brake.

### 12. Low fuel warning

This warning appears when the fuel level in the tank is getting low. Refuel as soon as it is convenient, preferably before the fuel gauge reaches the empty (0) position.

**There will be a small reserve of fuel remaining in the tank when the fuel gauge reaches the empty (0) position.**

### 13. Door open warning

This warning appears if any of the doors are open or not closed securely. The vehicle icon indicates which door is open on the display. Make sure that all of the doors are closed.

### 14. 4WD mode indicator (if equipped)

This indicator shows the drive mode of the 4WD system.

See "Four-Wheel Drive (4WD)" (P.5-17) for details.

### 15. Low Washer Fluid warning (if equipped)

This warning appears when the washer tank fluid is at a low level. Add washer fluid as necessary. (See "Window washer fluid" (P.8-20).)

### 16. Key System Error warning (if equipped)

This warning appears if there is a malfunction in the Intelligent Key system.

If this warning appears while the engine is stopped, the engine cannot be started. If this warning appears while the engine is running, the vehicle can be driven. However, contact a NISSAN dealer for repair as soon as possible.

### 17. Oil Level Low indicator (if equipped)

If the low level indicator is displayed, the engine oil level is low. If the low level indicator is displayed, check the level using the engine oil dipstick. (See "Engine oil" (P.8-9).)



#### CAUTION:

**The oil level should be checked regularly using the engine oil dipstick. Operating with an insufficient amount of oil can damage the engine and such damage is not covered by the warranty.**

### 18. Oil level sensor warning (if equipped)

If the oil level sensor warning is displayed, the engine oil level sensor may be malfunctioning. Contact a NISSAN dealer immediately.

### 19. Low Oil Pressure Stop vehicle warning (if equipped)

This warning appears if low engine oil pressure is detected. If the warning appears during normal driving, pull off the road in a safe area, stop the engine immediately and call a NISSAN dealer.

The low oil pressure warning is not designed to indicate a low oil level. Use the dipstick to check the oil level. (See "Engine oil" (P.8-9).)



#### CAUTION:

**Running the engine with the engine oil pressure warning displayed could cause serious damage to the engine.**

### 20. 4WD Error warning (if equipped)

This warning appears when the four wheel drive (4WD) system is not functioning properly while the engine is running. Reduce vehicle speed and have your vehicle checked by a NISSAN dealer. See "4WD warning" (P.5-21).

### 21. Shipping Mode On Push Storage Fuse warning (if equipped)

This warning may appear if the extended storage fuse switch is not pushed in (switched on). When this warning appears, push in (switch on) the extended storage fuse switch to turn off the warning. For more information, see "Extended storage fuse switch" (P.8-25).

### 22. Headlight System Error warning (if equipped)

This warning appears if the LED headlights are malfunctioning. Have the system checked by a NISSAN dealer.

### 23. Reminder Turn OFF Headlights warning

This warning appears when the driver side door is opened with the headlight switch is left ON and the ignition switch is placed in the "OFF", "ACC" or "LOCK" position. Place the headlight switch in "OFF" or "AUTO" (if equipped) position. For additional information, see "Headlight and turn signal switch" (P.2-33).

#### 24. Time for a driver break? indicator

This indicator appears when the set "Timer Alert" alarm activates. You can set the time for up to 6 hours. (See "Trip computer" (P.2-25).)

#### 25. Cruise control indicator (if equipped)

This indicator shows the cruise control system status. The status is shown by the color.

See "Cruise control" (P.5-26) for details.

#### 26. Automatic Transmission (AT) position indicator (AT models)

This indicator shows the automatic shift position.

In the manual shift mode, when the transmission does not shift to the selected gear due to a transmission protection mode, the AT position indicator will blink and a chime will sound.

For further details, see "Driving with Automatic Transmission (AT)" (P.5-14).

#### 27. Automatic Transmission (AT) Error warning (AT models)

If the Automatic Transmission (AT) Error warning appears while the engine is running, or while driving, it may indicate that the AT is not functioning properly and may need servicing. Have the system checked, and if necessary repaired, by a NISSAN dealer promptly.

#### 28. Automatic Transmission (AT) park warning (AT models)

This warning indicates that the Automatic Transmission (AT) parking function is not engaged. If the transfer control is not secured in any driving position while the AT shift lever is in the "P" (Park) position, the transmission will disengage and the wheels will not lock.

**For 4WD model: If the ATP warning appears with the shift lever in the "P" (Park) position, shift the Four-Wheel Drive (4WD) mode switch to the 2WD, 4H or 4LO position again with the shift lever in the N (Neutral) position.** (See "Four-Wheel Drive (4WD)" (P.5-17).)



#### WARNING:

**If the 4WD mode indicator (see "4WD mode indicator" (P.5-21)) is "OFF" or the ATP warning light is "ON", this indicates that the automatic transmission P (Park) position will not function and could result in the vehicle moving unexpectedly, causing serious personal injury or property damage. Always set the parking brake.**

#### 29. Parking Sensor Error warning (if equipped)

This warning appears when the parking sensor (sonar) system is not functioning properly. If the warning appears, have the system checked by a NISSAN dealer.

### MAINTENANCE INDICATORS

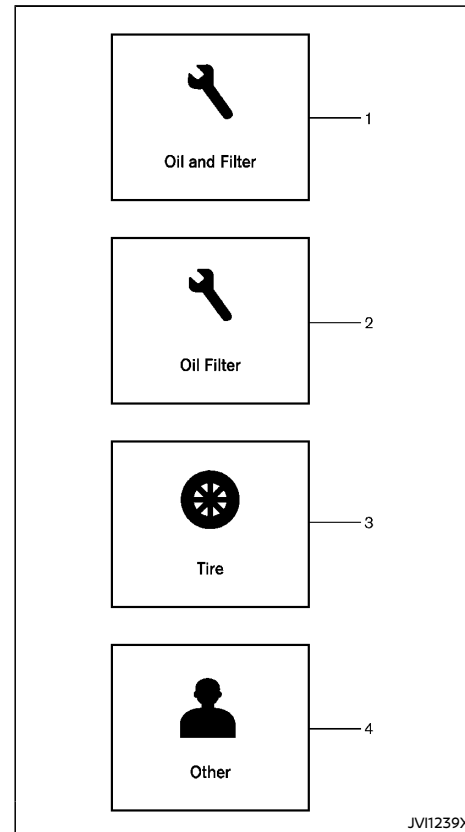

See "Trip computer" (P.2-25) for the setting of each indicator.

### 1. Oil and Filter replacement indicator (except for YS23DDT/DDTT engine models)

This indicator appears when the customer set distance comes for changing the engine oil and filter. You can set or reset the distance for checking or replacing these items.

### 2. Oil Filter replacement indicator (YS23DDT/DDTT engine models)

This indicator appears when the set time comes for replacing the oil filter. For scheduled maintenance items and intervals, see a separate maintenance booklet.

### 3. Tire replacement indicator

This indicator appears when the set time comes for replacing tires. You can set or reset the distance for replacing tires.

### 4. "OTHER" indicator

This indicator appears when the customer set distance comes for checking or replacing maintenance items other than the engine oil, oil filter and tires. Other maintenance items can include such things as air filter or tire rotation. You can set or reset the distance for checking or replacing the items.

## TRIP COMPUTER

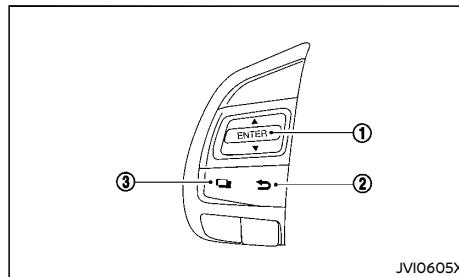



Switches for the trip computer are located on the left side of the steering wheel. To operate the trip computer, push the switches.

①  and ENTER switch



②  switch

③  switch

When the ignition switch is placed in the "ON" position, modes of the trip computer can be selected by pushing the  switch ③.

Each time the  switch ③ is pushed, the display will change as follows:

Car view (Home) → Distance to empty (dte) → Average speed or Speed and Average → Elapsed time and trip odometer → Current and average fuel consumption → Navigation (if equipped) → Compass (if equipped) → Audio (if equipped) → Warning check → Settings

When the ②  or ③  is pushed and held for more than 3 seconds, the average speed, the elapsed time, the trip odometer, the current and average fuel consumption will be reset.

## Distance to empty (dte – km or mile)

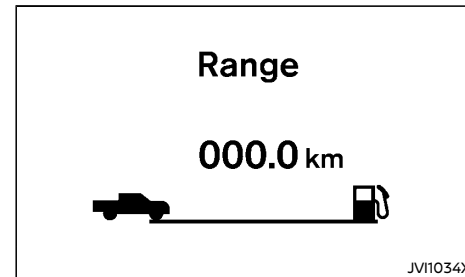

Type A

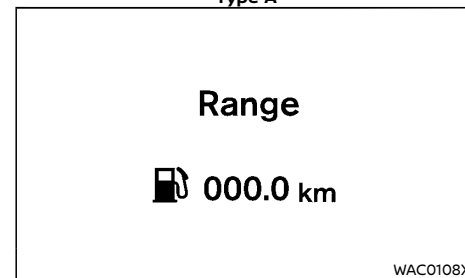

Type B

The distance to empty (dte) mode provides you with an estimation of the distance that can be driven before refueling. The dte is constantly being calculated based on the amount of fuel in the fuel tank and the actual fuel consumption.

The display is updated every 30 seconds.

The dte mode includes a low range warning feature. If the fuel level is low, the warning is displayed on the screen.

When the fuel level drops even lower, the dte display will change to "----".

- If the amount of fuel added is small, the display just before the ignition switch is placed in the "OFF" position may continue to be displayed.
- When driving uphill or rounding curves, the fuel in the tank shifts, which may momentarily change the display.

### Speed and Average (km/h or MPH)

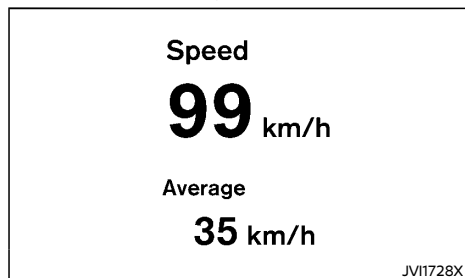

#### Speed:

The (digital) speed shows the current speed at which the vehicle is travelling.

#### Average speed:

The average speed shows the average vehicle speed since the last reset. Resetting is done by pushing the ② or ③ for longer than 1 second.

When the ② or ③ is pushed and held for more than 3 seconds, the average speed, the elapsed time, the trip odometer, the current and average fuel consumption will be reset.

The display is updated every 30 seconds. For the first 30 seconds after a reset, the display shows "----".

### Elapsed time and trip odometer (km or mile)

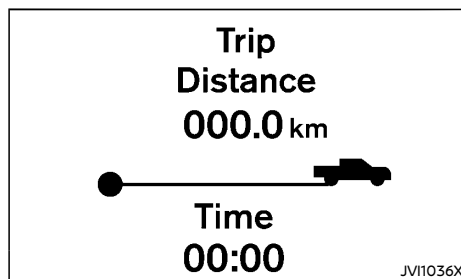

Type A

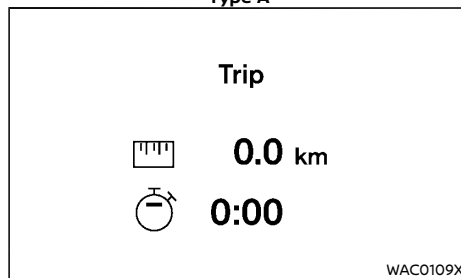

Type B

#### Elapsed time:

The elapsed time mode shows the time since the last reset. The displayed time can be reset by pushing the ② or ③ for longer than 1 second. (The trip odometer is also reset at the same time.)

#### Trip odometer:

The trip odometer mode shows the total distance that the vehicle has been driven since the last reset. Resetting is done by pushing the ② or ③ for longer than 1 second. (The elapsed time is also reset at the same time.)

When the ② or ③ is pushed and held for more than 3 seconds, the average speed, the elapsed time, the trip odometer, the current and average fuel consumption will be reset.

#### Current and average fuel consumption (l (liter)/100 km, km/(liter) or MPG)

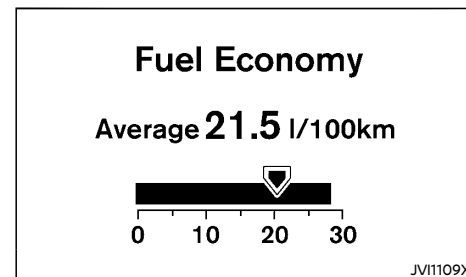

#### Current fuel consumption:

The current fuel consumption mode shows the current fuel consumption.

#### Average fuel consumption:

The average fuel consumption mode shows the average fuel consumption since the last reset. Resetting is done by pushing the ② or ③ for longer than 1 second.

When the ② or ③ is pushed and held for more than 3 seconds, the average speed, the elapsed time, the trip odometer, the current and average fuel consumption will be reset.

The display is updated every 30 seconds. At about the first 500 m (1/3 mile) after a reset, the display shows “—”.

### Navigation (if equipped)

When the route guidance is set in the navigation system, this item shows the navigation route information.

### Compass (if equipped)

This display indicates the heading direction of the vehicle.

### Audio (if equipped)



The audio mode shows the status of audio information.

### Warning check

The present warnings are displayed. If no warning is present, “No Warning” is displayed.

### Settings

#### Settings cannot be made while driving.

The  and ENTER switch  is used in the setting mode.

Use the  switch to select a menu.

Push ENTER to decide a menu.

#### Driver Assistance (if equipped):

Select this submenu to change the status or turn on or off any of the systems displayed in the Parking Aids menu.

- Parking Aids  
There are 3 submenus under the Parking Aids menu.
  - Sensor  
Select this submenu to enable/disable the parking sensor (sonar).

- Volume  
Select this submenu to change the parking sensor (sonar) buzzer volume.
- Range  
Select this submenu to change the parking sensor (sonar) detection range.

#### Clock:

There are following submenus under the clock menu, depending on the equipment of each vehicle.

- Set Clock in NAVI (if equipped)  
See “How to use SETUP button” (P.4-6), the separate Navigation Owner’s Manual or the separate NissanConnect Owner’s Manual.
- Set Clock in Audio (if equipped)  
See “How to use SETUP button” (P.4-6), “Audio main operation” (P.4-39), “Audio main operation” (P.4-45), “Audio main operation” (P.4-52), “Audio main operation” (P.4-58), “Audio main operation” (P.4-64) or the separate NissanConnect Owner’s Manual.
- Set Clock (if equipped)  
Select this submenu to adjust the time on the clock.
- 12H/24H (if equipped)  
Select this submenu to choose the clock format between 12-hour and 24-hour.

#### Meter Settings:

There are following submenus under the Meter settings menu.

- Main Menu Selection  
Select this submenu to enable/disable the items that are displayed.
- Body Color  
Select this submenu to change the color of the vehicle that displays in the vehicle

information display when the ignition switch is placed in the “ON” position.

- ECO Drive Report (if equipped)  
There are 2 submenus under the ECO Drive Report menu.
  - Display  
Select this submenu to enable/disable the ECO Drive Report in the vehicle information display.
  - View History  
Select this submenu to reset the past history of the fuel economy and the best fuel economy. See “ECO drive report” (P.5-28).
- Welcome Effect  
Select this submenu to enable/disable the display effect and the dial and pointer effect described below to on or off.
  - Display Effect  
The welcome screen display appears when the ignition switch is turned on.
  - Dial Effect  
The indicator needles sweep in the meters when the engine is started.

#### Vehicle Settings:

There are following submenus under the Vehicle settings menu.

- Lighting (if equipped)  
There are 2 submenus under the Lighting menu.
  - Auto Room Lamp  
Select this submenu to enable/disable the auto room lamp feature.  
The interior lights will be ON if any door is unlocked when the auto room lamp is enabled.

– Light Sensitivity

The light sensitivity can be set to illuminate earlier or later based on the brightness outside the vehicle.

- Turn indicator  
Select this submenu to enable/disable the “3 Flash Pass” lane change signal feature.
- Locking (if equipped)
  - I-Key Door Lock  
Select this submenu to activate/deactivate the request switch on the door.
- Wipers  
Select this submenu to activate/deactivate the speed dependent wiper speed feature.

**Maintenance:**

There are following submenus under the maintenance menu.

- Oil Control System (YS23DDT/DDTT engine models)  
Select this submenu to reset the distance for replacing the engine oil.  
To reset the oil replacement indicator, select “Oil Control System”, push ENTER ① (for more than 1 second but less than 3 seconds) and select “Yes”.  
The distance to oil change interval cannot be adjusted manually. The interval is set automatically.
- Oil Filter (YS23DDT/DDTT engine models)  
Select this submenu to set or reset the distance for replacing the oil filter.
- Oil and Filter (except for YS23DDT/DDTT engine models)  
Select this submenu to set or reset the distance for replacing the engine oil and oil filter.

**NOTE:**

**Be sure to reset the distance for replacing the engine oil and oil filter after replacing. Otherwise, the Oil and filter replacement indicator will continue to be displayed.**

- Tire  
Select this submenu to set or reset the distance for replacing tires.
- Other  
Select this submenu to set or reset the distance for replacing items other than the engine oil, oil filter and tires.

**Alarm:**

There are following submenus under the Alarm menu.

- Outside Temp (if equipped)  
Select this submenu to enable/disable the alarm for outside air temperature in the vehicle information display.
- Timer Alert  
Select this submenu to specify when the “Time for a driver break?” indicator activates.
- Navigation (if equipped)  
Select this submenu to enable/disable the navigation system information in the vehicle information display.
- Phone (if equipped)  
Select this submenu to enable/disable an incoming call information in the vehicle information display.
- Mail (if equipped)  
Select this submenu to enable/disable an incoming mail information in the vehicle information display.

**Unit:**

Select this submenu to change the units that are shown in the vehicle information display.

**Language:**

Select this menu to choose language for the display.

**Factory Reset:**

Select this menu to reset the settings in the vehicle information display back to the factory default.



## OIL CONTROL SYSTEM (if equipped for diesel engine model)

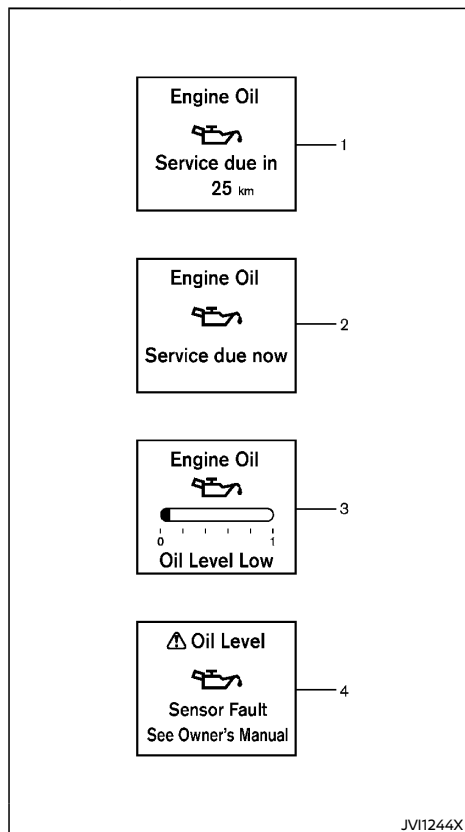

When the ignition switch is in the "ON" position, engine oil information is displayed.

Engine oil information informs the distance to oil change, oil level indication and malfunction of oil level sensor.

### 1. Distance to oil change

The distance to oil change is displayed if the distance to oil change is less than 1,500 km (930 miles).

### 2. Oil replacement indicator

When the set mileage approaches, the engine oil replacement indicator will appear on the display. After the oil is changed, reset the distance to oil change. The oil replacement indicator will not be reset automatically. To reset this indicator, see "Settings" (P.2-27).

The distance to oil change interval cannot be adjusted manually. The distance to oil change interval is set automatically.

### CAUTION:

- If the oil replacement indicator is displayed, change the engine oil as soon as possible. Operating your vehicle with deteriorated oil can damage the engine.
- Never perform reset if the engine oil was not changed. Always visit a NISSAN dealer to perform the engine oil change including an oil filter change and the reset.

### NOTE:

- It is not possible to undo the reset.
- Resetting the oil change distance is only possible when:
  - The distance to oil change is displayed in the vehicle information display.

– The oil replacement indicator is displayed in the vehicle information display.

- The engine oil should be changed before the distance to oil change reaches 0 km (0 miles). Continued driving after the distance to oil change reaches 0 km (0 miles) may result in reduced engine performance.
- The Diesel Particulate Filter (DPF) may also become saturated because regeneration is restricted once the distance to oil change reaches 0 km (0 miles).

Have the vehicle inspected by a NISSAN dealer if the above condition occurs.

- The oil change interval will reduce faster with certain types of driving, especially at row speeds in urban conditions.

### 3. Low level reminder

If the low level indicator is displayed, the engine oil level is low. If the low level reminder is displayed, check the level using the engine oil dipstick. (See "Engine oil" (P.8-9).)

### CAUTION:

The oil level should be checked regularly using the engine oil dipstick. Operating with an insufficient amount of oil can damage the engine and such damage is not covered by the warranty.

#### 4. Oil level sensor warning

If the oil sensor warning is displayed, the engine oil level sensor may be malfunctioning. Contact a NISSAN dealer immediately.

#### CLOCK AND OUTSIDE AIR TEMPERATURE (if equipped)

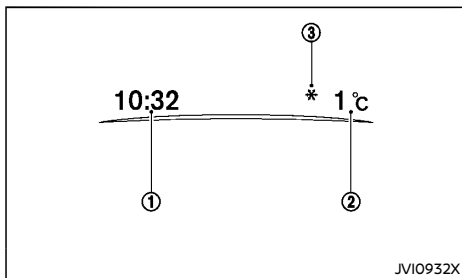

The clock ① and outside air temperature ② (if equipped) are displayed on the upper side of the vehicle information display.

#### Clock

For clock adjustment, see "Settings" (P.2-27), the separate Navigation System Owner's Manual (if equipped) or the NissanConnect Owner's Manual (if equipped).

#### Outside air temperature (°C or °F) (if equipped)

The outside air temperature is displayed in °C or °F in the range of -40 to 60°C (-40 to 140°F).

The outside air temperature mode includes a low temperature warning feature. If the outside air temperature is below 3°C (37°F), the warning ③ is displayed on the screen.

The outside temperature sensor is located in

front of the radiator. The sensor may be affected by road or engine heat, wind directions and other driving conditions. The display may differ from the actual outside temperature or the temperature displayed on various signs or billboards.

## VEHICLE INFORMATION DISPLAY (models without color display)

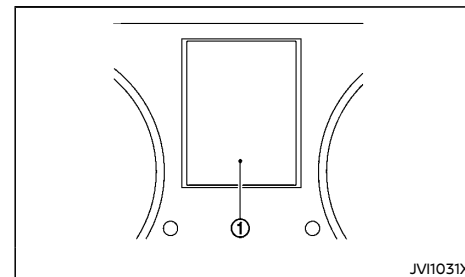

When the ignition switch is placed in the "ON" position, the vehicle information display ① shows the following information:

- Engine coolant temperature gauge
  - "Engine coolant temperature gauge" (P.2-9)
- Fuel gauge
  - "Fuel gauge" (P.2-9)
- Odometer
  - "Odometer (models without color display)" (P.2-8)
- Four-Wheel Drive (4WD) (if equipped)
  - "4WD mode indicator" (P.5-21)
- Outside air temperature (if equipped)
  - "Outside air temperature" (P.2-31)
- Trip computer
  - "Trip computer" (P.2-31)
- Oil control system (if equipped)
  - "Oil control system (if equipped for diesel engine model)" (P.2-31)
- Automatic Transmission (AT) position indicator (AT model)
  - "Driving with Automatic Transmission (AT)" (P.5-14)

- Cruise control (if equipped)
  - “Cruise control” (P.5-26)

## OUTSIDE AIR TEMPERATURE (if equipped)

The outside air temperature is displayed in °C.

## TRIP COMPUTER

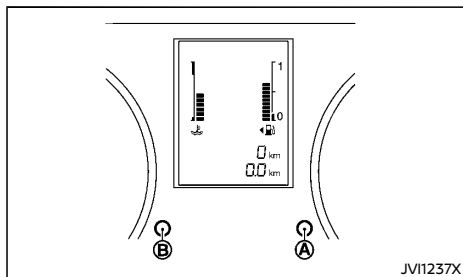

The switch for the trip computer is located on the meter panel.

When the ignition switch is placed in the “ON” position, modes of the trip computer can be selected by pushing the trip computer mode switch (A).

Each time the trip computer mode switch (A) is pushed, the display will change as follows:

(TRIP A → TRIP B) → Current fuel consumption  
 → Average fuel consumption → Distance to empty (dte) → (TRIP A)

## Current fuel consumption

The current fuel consumption mode shows the current fuel consumption.

Push the trip computer mode switch (B) to toggle the fuel consumption display between l/100 km and km/l (if equipped).

## Average fuel consumption (l/100 km, km/l or mpg)

The average fuel consumption mode shows the average fuel consumption since the last reset. Resetting is done by pushing the trip computer mode switch (A) for longer than 1 second.

The display is updated every 30 seconds. At about the first 500 m (1/3 miles) after a reset, the display shows “----”.

Push the trip computer mode switch (B) to toggle the fuel consumption display between l/100 km and km/l (if equipped).

## Distance to empty (dte - km or miles)

The distance to empty (dte) mode provides you with an estimation of the distance that can be driven before refueling. The dte is constantly being calculated, based on the amount of fuel in the fuel tank and the actual fuel consumption.

The display is updated every 30 seconds.

The dte mode includes a low range warning feature: when the fuel level is low, the dte mode is automatically selected and the digits and the low fuel warning light (B) blink in order to draw the driver’s attention. Push the trip computer mode switch (A) to return to the mode that was selected before the warning occurred.

When the fuel level drops even lower, the dte

display will change to “----”.

- **If the amount of fuel added is small, the display just before the ignition switch is turned off may continue to be displayed.**
- **When driving uphill or rounding curves, the fuel in the tank shifts, which may momentarily change the display.**

## OIL CONTROL SYSTEM (if equipped for diesel engine model)

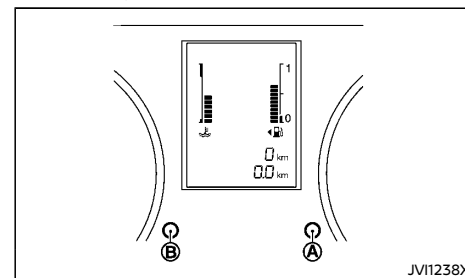

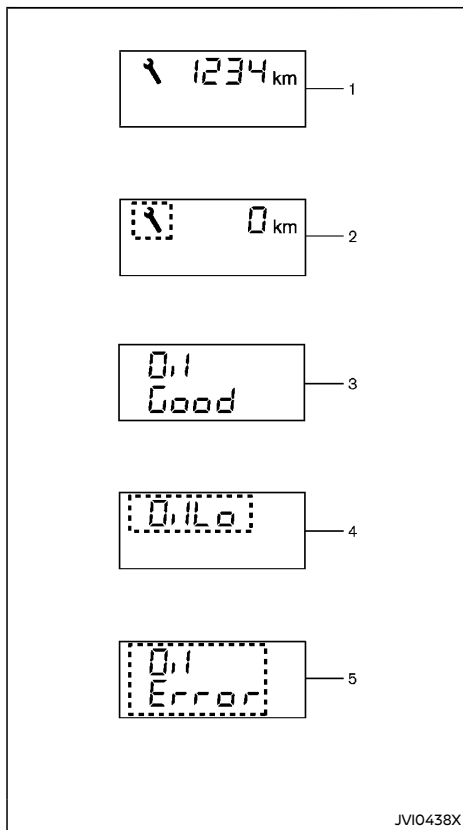

When the ignition switch is in the "ON" position, engine oil information is displayed. Engine oil information informs you of the

distance to oil change, oil level indication and oil level sensor malfunctions.

To reset the oil control system, push and hold the trip computer mode switch (A) for more than 3 seconds when the engine oil information is displayed.

### 1. Distance to oil change

When the ignition switch is placed in the "ON" position, the distance to oil change is displayed.

### 2. Oil replacement indicator



#### CAUTION:

**If the oil replacement indicator is displayed, change the engine oil as soon as possible. Operating your vehicle with oil that has deteriorated can damage the engine.**

When the distance to oil change information showing zero (0) or less is displayed: When the ignition switch is placed in the "ON" position, a wrench symbol blinks and the distance to oil change information showing zero (0) is displayed for approximately 5 seconds.

#### Setting distance to oil change:

The distance to oil change interval can be adjusted or disabled using the trip computer mode switch (A).

Refer to the separate maintenance booklet for the appropriate distance to oil change interval.

#### To adjust oil change interval:

1. Push and hold the trip computer mode switch (A) for more than 3 seconds while the wrench symbol and distance to oil change information are displayed.

If adjusting the distance from zero (0): Push and hold the trip computer mode switch (A)

for more than 3 seconds within 5 seconds of placing the ignition switch in the "ON" position.

The wrench symbol and the distance will start flashing.

2. While the display is flashing, push and hold the trip computer mode switch (A) for more than 3 seconds to enter the adjustment mode.

If adjusting the distance from zero (0): Push the trip computer mode switch (A). The default distance to oil change will be restored.

3. Turn the trip computer mode switch (B) clockwise or counterclockwise to increase or decrease the interval. Each turn increases or decreases the interval by 1,000 km (500 miles).

If no further action is taken, the display will switch to the oil level indication and the new interval will be set.

#### To cancel oil change reminder:

1. Push and hold the trip computer mode switch (A) for more than 3 seconds while the wrench symbol and distance to oil change information are displayed.

The wrench symbol and the distance will start flashing.

2. While the display is flashing, push the trip computer mode switch (A) again to enter the adjustment mode.

3. Turn the trip computer mode switch (B) counterclockwise until the interval reads 0.

If no further action is taken, the display will switch to the oil level indication and the oil change reminder is cancelled.

No wrench symbol or distance will be displayed

## HEADLIGHT AND TURN SIGNAL SWITCH

when the ignition switch is placed in the "ON" position. To reactivate the reminder, set the distance to oil change interval to a value above zero (0).

### 3. Oil level display

When the ignition switch is placed in the "ON" position, the engine oil level status is displayed.

### 4. Low level reminder

If the low level indicator is displayed, the engine oil level is low. If the low level reminder is displayed, check the level using the engine oil dipstick. (See "Engine oil" (P.8-9).)



#### CAUTION:

The oil level should be checked regularly using the engine oil dipstick. Operating the vehicle with an insufficient amount of oil can damage the engine and such damage is not covered by the warranty.

(See "Engine oil" (P.8-9).)

### 5. Oil level sensor warning

If the oil sensor warning is displayed, the engine oil level sensor may be malfunctioning. Contact a NISSAN dealer immediately.



#### CAUTION:

- Even if "Oil Good" appears on the engine oil maintenance display, be sure to replace the engine oil when the engine oil level gauge shows that the oil level exceeds the Hi level by approximately 10 mm (0.4 in) because the oil performance has decreased.
- Always reset the oil control system after replacing the engine oil.

### HEADLIGHT SWITCH

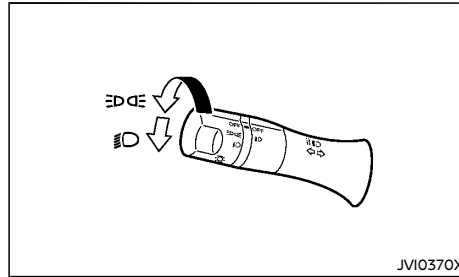

Example A

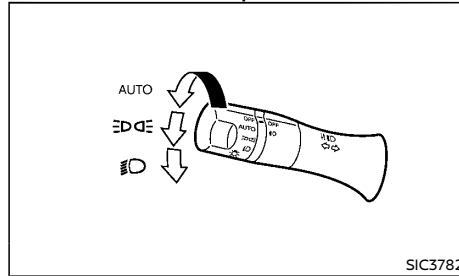

Example B

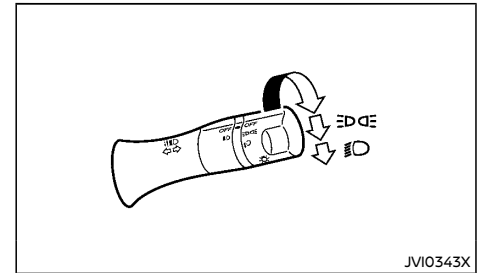

Example C

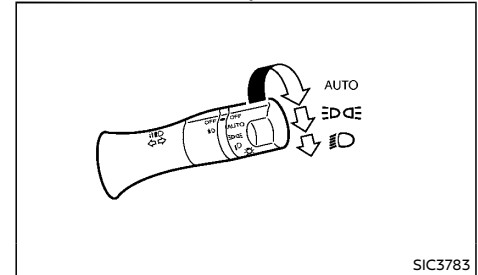

Example D

The headlight switch varies depending on the model.

NISSAN recommends that you consult the local regulations concerning the use of lights.

### AUTO position (if equipped)

When the ignition switch is in the "ON" position and the headlight switch is in the "AUTO" position, the headlights, front clearance lights, instrument panel lights, rear combination lights and other lights turn on automatically depending on the brightness of the surroundings.

The headlights will turn on automatically at twilight or in rainy weather (when the wind-

shield wiper is operated continuously).

When the ignition switch is placed in the "OFF" position, the lights will turn off automatically.

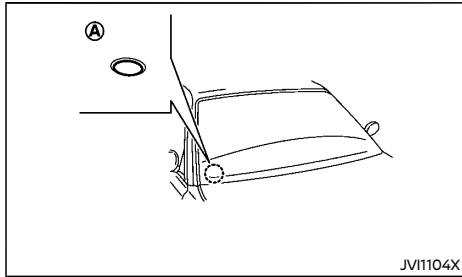

Example



**CAUTION:**

**Do not place any objects on top of the sensor** . The sensor senses the brightness level and controls the Intelligent Auto Headlight function. If the sensor is covered, it reacts as if it is dark, and the headlights will illuminate.

 position

The  position turns on the front clearance, instrument panel, tail and license plate lights.

 position

The  position turns on the headlights in addition to the other lights.

### Headlight beam

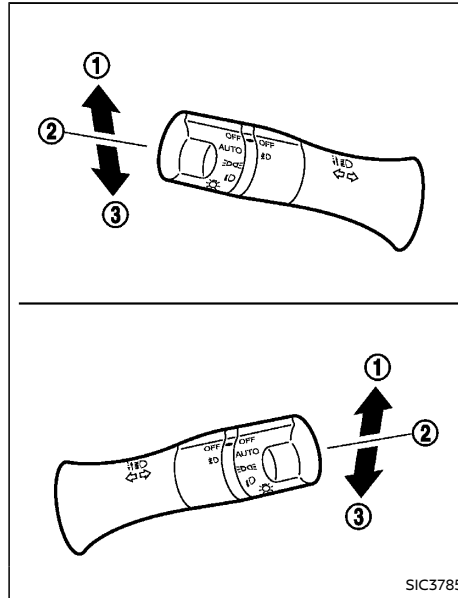

To turn on the high beam, push the lever towards the front position .

To turn off the high beam, return the lever to the neutral position .

To flash the headlights, pull the lever towards the rearmost position . The headlights can be flashed even when the headlights are not on.



If equipped, when the lever is pulled towards the rearmost position  after the ignition switch is placed in the "OFF" or "LOCK" position, the headlight will turn on and stay on for 30

seconds.

The lever can be pulled 4 times for up to 2 minutes.

### Daytime running light system (if equipped)

Even if the headlight switch is in the OFF position, the daytime running lights will come on after starting the engine.

When the light switch is turned to the  or  position, the daytime running light will turn off.

### HEADLIGHT AIMING CONTROL (if equipped)

#### Manual type

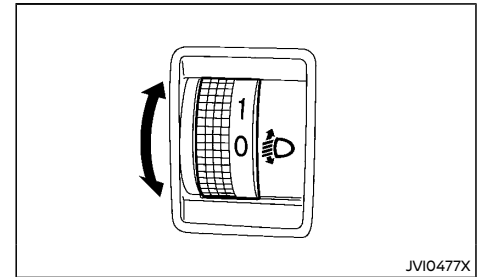

The headlight aiming control operates when the ignition switch is in the "ON" position and the headlight is on to allow the headlight axis to be adjusted according to the driving condition.

When driving with no heavy load/luggage or driving on a flat road, select the normal position "0".

If the number of occupants and load/luggage

in the vehicle changes, the headlight axis may become higher than normal.

If the vehicle is traveling on a hilly road, the headlights may directly shine on the rearview and outside mirrors of a vehicle ahead or the windshield of an oncoming vehicle, which may obscure other drivers' vision.

To adjust to the proper aiming height, turn the switch accordingly. The higher the number, designated on the switch, the lower the headlight axis.

Select the switch position by referring to the following samples.

**For Malaysia Single Cab:**

Switch position	Number of front seat occupants	Number of rear seat occupants	Weight of load in luggage compartment
0	1 or 2	No occupants	No load
1	-	-	-
2	-	-	-
3	1	No occupants	Approximately 803 kg (1,771 lb)



**For Malaysia Double Cab:**



Switch position	Number of front seat occupants	Number of rear seat occupants	Weight of load in luggage compartment
0	1 or 2	No occupants	No load
1	2	3	No load
2	-	-	-
3	1 or 2	No occupants or 3	Approximately 614 kg (1,354 lb) Approximately 805 kg (1,775 lb)

**Automatic type**

For the vehicle equipped with the automatic leveling system, the headlight axis is controlled automatically.

**BATTERY SAVER SYSTEM**

The light reminder chime will sound if the headlight switch is in either the  or  position and when the driver's door is opened with the ignition switch in the "ACC", "OFF" or "LOCK" position.

If the ignition switch is in the "OFF" or "LOCK" position and the doors are closed and locked while the headlight switch is in either the  or  position, the battery saver function will turn off the lights to prevent the battery from being discharged. The lights will turn on when the doors are being opened.



**CAUTION:**

**Do not leave the lights on when the engine is not running for extended periods of time to prevent the battery from being discharged.**

**TURN SIGNAL SWITCH**

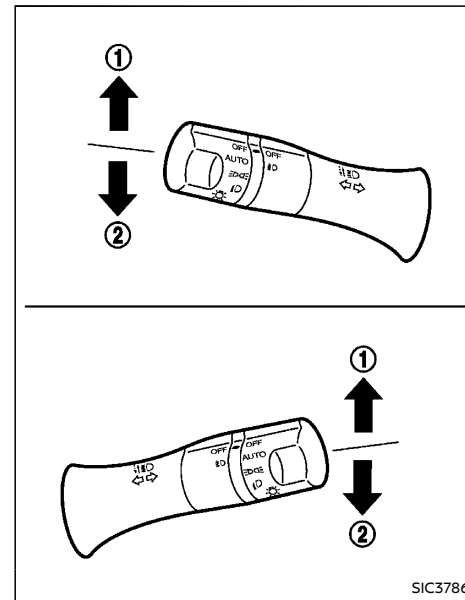

**CAUTION:**

**The turn signal switch will not be canceled automatically if the steering wheel turning angle does not exceed the preset amount. After the turn or lane change, make sure that the turn signal switch is returned to its original position.**

## FOG LIGHT SWITCH (if equipped)

### Turn signal

To turn on the turn signals, move the lever up ① or down ② to the point where the lever latches. When the turn is completed, the turn signal cancels automatically.

### Lane change signal

To turn on the lane change signals, move the lever up ① or down ② to the point where the light begins to flash.

If the lever is moved back to its original position right after moving up or down, the light will flash 3 times.

To cancel the flashing, move the lever to the opposite direction.

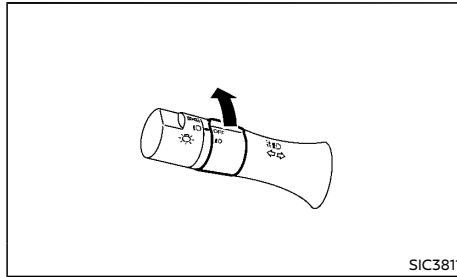

Type A

SIC3811

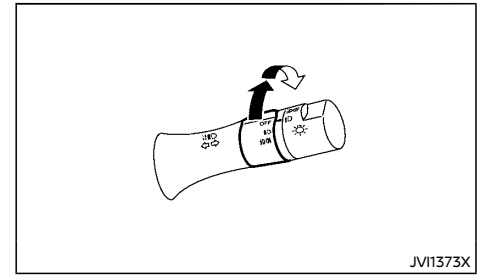

Type C

JV11373X

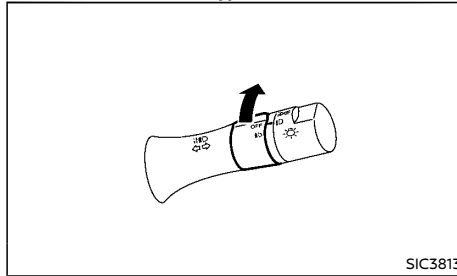

Type B

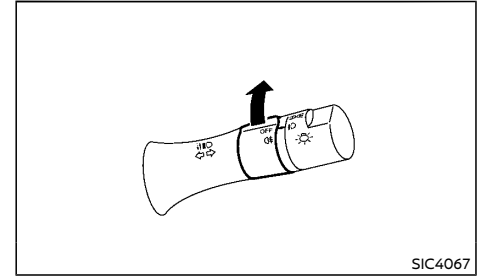

SIC3813



Type D

SIC4067

## FRONT FOG LIGHTS (if equipped)

To turn on the front fog lights, turn the fog light switch to the  position with the headlight switch in the  or  or AUTO (if equipped) position.

To turn off the fog lights, turn the fog light switch to the "OFF" position.



## CARGO LIGHT SWITCH (if equipped)

### REAR FOG LIGHT (if equipped)

The rear fog light should be used only when visibility is seriously reduced. [Generally, to less than 100 m (328 ft)]

To turn on the rear fog light, turn the headlight switch to the  $\equiv \bigcirc$  or AUTO position, then turn the fog light switch to the  $\bigcirc \#$  or  $\# \bigcirc \#$  position. The rear fog light and  $\bigcirc \#$  indicator light on the meter illuminate. The fog light switch will return to the OFF or  $\# \bigcirc$  position automatically.

If the front fog lights (if equipped) are already turned on, you can turn on the rear fog light without first turning the headlight switch to the  $\equiv \bigcirc$  or AUTO position.

To turn off the rear fog light, turn the fog light switch to the  $\bigcirc \#$  or  $\# \bigcirc \#$  position again. Make sure the  $\bigcirc \#$  indicator light on the instrument panel turns off.

To turn off both the front and rear fog lights, turn the fog light switch to the "OFF" position.

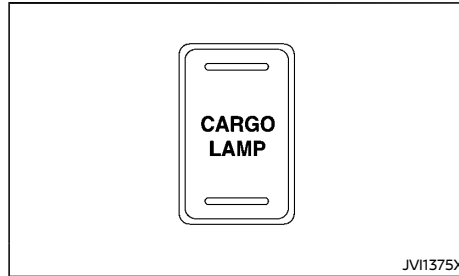

To turn on the cargo light, push the switch.

To turn off the cargo light, push the switch again.

### CAUTION:

- The battery could run down if the cargo light is operated while the engine is not running.
- Be sure to turn the light switch to the OFF position when you leave the vehicle for extended periods of time, otherwise the battery will go dead.

### NOTE:

Be sure to apply the parking brake when you use the cargo light switch, otherwise the cargo light will not turn on.

## WIPER AND WASHER SWITCH

### WARNING:

In freezing temperatures, the washer fluid may freeze on the windshield and obscure your vision. Warm the windshield with the defogger before you wash the windshield.

### CAUTION:

- Do not operate the washer continuously for longer than 30 seconds.
- Do not operate the washer if the window washer fluid reservoir is empty.
- If the wiper operation is interrupted by snow or ice, the wiper may stop moving to protect its motor. If this occurs, turn the wiper switch to the "OFF" position and remove the snow or ice on and around the wiper arms. In approximately 1 minute, turn the switch on again to operate the wiper.

## WINDSHIELD WIPER AND WASHER SWITCH

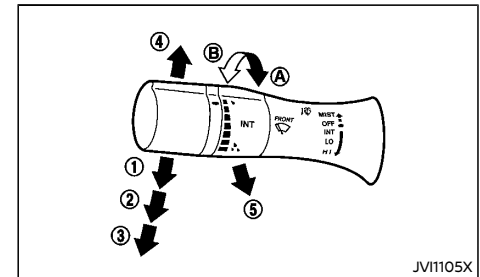

Type A

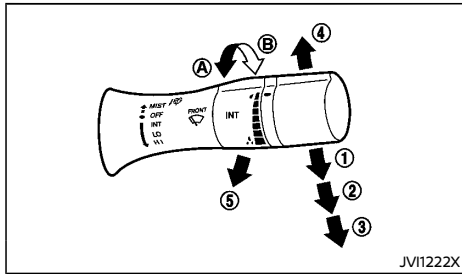

Type B

JV11222X

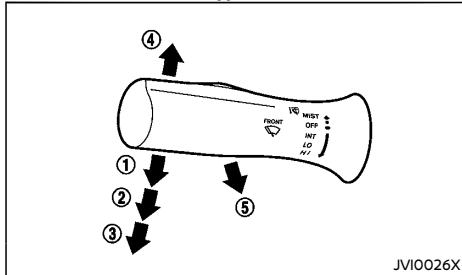

Type C

JV10026X

The windshield wiper and washer operate when the ignition switch is in the "ON" position.

### Wiper operation

The lever position "INT" ① operates the wiper intermittently.

The intermittent operation can be adjusted by turning the adjustment control knob, (longer) (A) or (shorter) (B). (Type A or Type B)

The lever position "LO" ② operates the wiper at low speed.

The lever position "HI" ③ operates the wiper at high speed.

To stop the wiper operation, move the lever up to the "OFF" position.

The lever position "MIST" ④ operates the wiper one sweep. The lever automatically returns to its original position.

### Washer operation

To operate the washer, pull the lever toward the back of the vehicle ⑤ until the desired amount of washer fluid is spread on the windshield. The wiper will automatically operate several times.

## DEFOGGER SWITCH (if equipped)

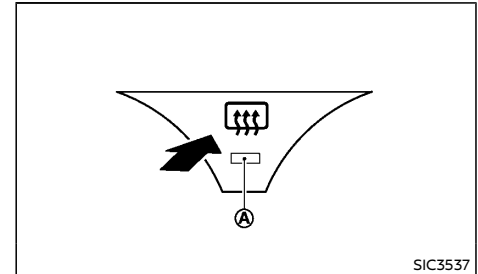

Type A

SIC3537

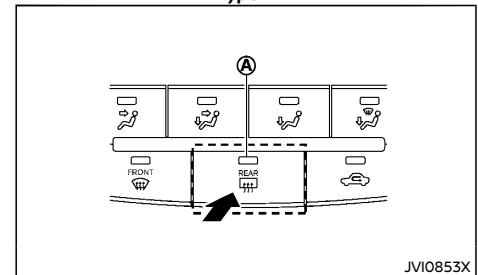

Type B

JV10853X

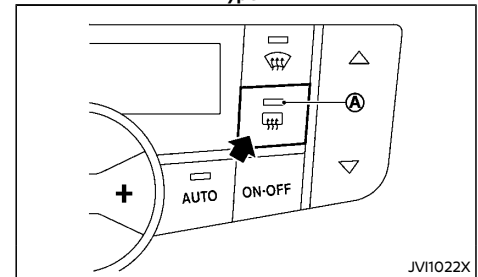

Type C

JV11022X

The rear window defogger switch operates

## HORN

when the ignition switch is in the "ON" position.

The defogger is used to reduce the moisture, fog or frost on the rear window and outside rearview mirror (if equipped) surfaces to improve the rear view.

When the defogger switch is pushed, the indicator light **A** illuminates and the rear window defogger operates for approximately 15 minutes. After the preset time has passed, the defogger will turn off automatically.

To turn off manually, push the defogger switch again.



### CAUTION:

- **When operating the defogger continuously, be sure to start the engine. Otherwise, it may cause the battery to discharge.**
- **When cleaning the inner side of the window, be careful not to scratch or damage the electrical conductors on the surface of the window.**

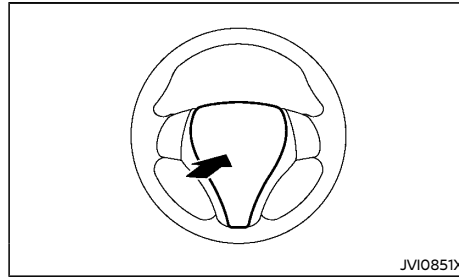

The horn switch operates regardless of the ignition switch position except when the battery is discharged.

When the horn switch is pushed and held, the horn will sound. Releasing the horn switch will cease the horn sound.

## WINDOWS

### MANUAL WINDOWS (if equipped)

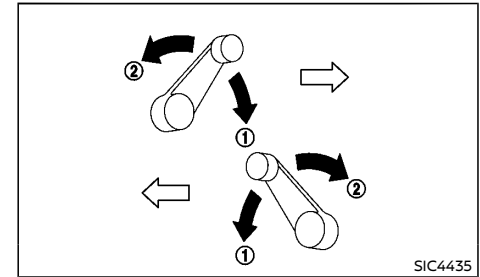

The side windows can be opened ① or closed ② by turning the hand crank on each door.

### POWER WINDOWS (if equipped)



### WARNING:

- **Make sure that all passengers have their hands, etc. inside the vehicle before operating the power windows.**
- **To help avoid risk of injury or death through unintended operation of the vehicle and or its systems, including entrapment in windows or inadvertent door lock activation, do not leave children, people who require the assistance of others or pets unattended in your vehicle. Additionally, the temperature inside a closed vehicle on a warm day can quickly become high enough to cause a significant risk of injury or death to people and pets.**

The power windows operate when the ignition switch is in the "ON" position.

To open a window, push down the power window switch.

To close a window, pull up the power window switch.

### Driver's window switch

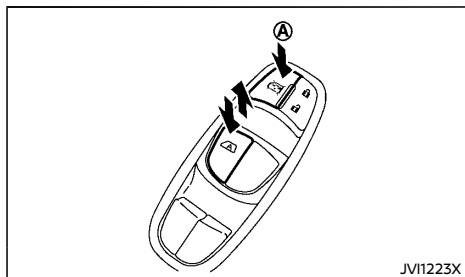

The driver's switch, the main switch, can control all windows.

### Locking passenger's windows:

When the lock button (A) is pushed in, the passenger's windows cannot be operated.

To cancel the passenger's windows lock, push the lock button (A) again.

### Passenger's window switch

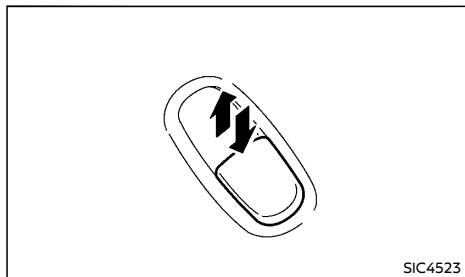

The passenger's switch can control its corre-

sponding window.

When the passenger's windows lock button on the driver's switch is pushed in, the passenger's switch cannot be operated.

### Automatic function

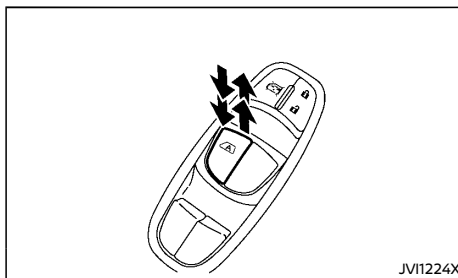

The automatic function is available for the switch that has an (A) mark on its surface.

The automatic function enables a window to fully open or close without holding the switch down or up.

To fully open the window, push the power window switch down to the second detent and release the switch. To fully close the window, pull the power window switch up to the second detent and release the switch. The switch does not have to be held during window operation.

To stop the window open/close operation during the automatic function, push down or pull up the switch in opposite directions.

### Auto-reverse function:



### WARNING:

**There is a small distance just before the closed position which cannot be detected. Make sure that all passengers have their hands, etc. inside the vehicle before closing the windows.**

The auto-reverse function enables a window to automatically reverse when something is caught in the window as it is closing by the automatic function. When the control unit detects an obstacle, the window will be lowered immediately.

Depending on the environment or driving conditions, the auto-reverse function may activate if an impact or load similar to something being caught in the window occurs.

### If the window does not close automatically

If the power window automatic function (closing only) does not operate properly, perform the following procedure to initialize the power window system.

1. Start the engine.
2. Close the door.
3. Open the window completely by operating the power window switch.
4. Pull the power window switch and hold it to close the window, and then hold the switch more than 3 seconds after the window is closed completely.
5. Release the power window switch. Operate the window by the automatic function to confirm the initialization is complete.

If the power window automatic function does

not operate properly after performing the procedure above, have your vehicle checked by a NISSAN dealer.

### AUTO SLIDE BACK WINDOW SYSTEM (if equipped)

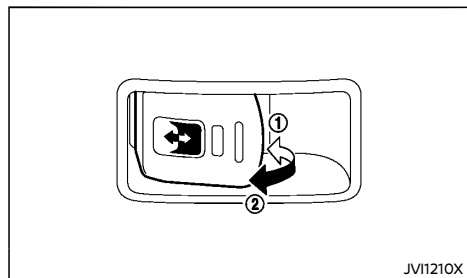
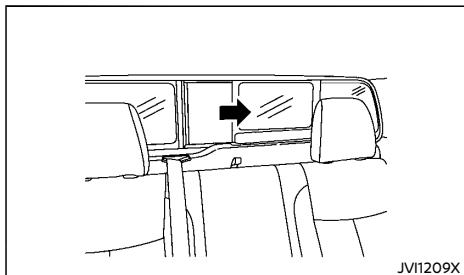

#### WARNING:

- Make sure that all passengers have their hands, etc. inside the vehicle before operating the auto slide back window.
- Never leave children or adults who would normally require the support of others alone in the vehicle. They could unknow-

#### ingly activate switches or controls and inadvertently become involved in an accident.

The auto slide back window operates when the ignition switch is in the "ON" position.

To open the back window, push down ① the auto slide back window switch.

To close the back window, pull up ② the auto slide back window switch.

## SUNROOF (if equipped)

#### WARNING:

- In an accident you could be thrown from the vehicle through an open sunroof. Adults should always use seat belts and children should always use seat belts or child restraint systems.
- Never allow anyone to stand up or extend any portion of their body out of the opening while the vehicle is in motion or while the sunroof is closing.

#### CAUTION:

- Remove water drops, snow, ice or sand from the sunroof before opening.
- Do not place any heavy objects on the sunroof or surrounding area.

### AUTOMATIC SUNROOF

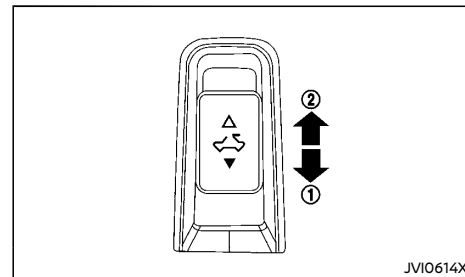

The sunroof operates when the ignition switch is in the "ON" position.

## Sunshade

To open or close the sunshade, slide the sunshade manually.

The sunshade will open automatically when the sunroof is opened. The sunshade needs to be closed manually by sliding it.

## Sunroof

### Tilting:

To tilt up, first close the sunroof, then push the switch to the TILT UP position ① and release it; it need not be held. To tilt down the sunroof, push the switch to the TILT DOWN position ②.

### Sliding:

To fully open or close the sunroof, push the switch to the OPEN ② or CLOSE ① position and release it; it need not be held. The roof will automatically open or close all the way. To stop the roof, push the switch once more while it is opening or closing.

## Auto-reverse function



### WARNING:

**There is a small distance just before the closed position which cannot be detected. Make sure that all passengers have their hands, etc. inside the vehicle before closing the sunroof.**

The auto-reverse function enables the sunroof to automatically reverse when something is caught in the sunroof as it is closing. When the control unit detects an obstacle, the sunroof will open immediately.

If the sunroof cannot be closed automatically when the auto reverse function activates due to a malfunction, push and hold the sunroof

switch to the CLOSE ① position.

Depending on the environment or driving conditions, the auto-reverse function may activate if an impact or load similar to something being caught in the sunroof occurs.

## If sunroof does not operate

If the sunroof does not operate properly, perform the following procedure to initialize the sunroof operation system.

1. If the sunroof is open, close it fully by repeatedly pushing the sunroof switch to the close position ① to tilt the sunroof up.
2. Push and hold the switch to the close position ①.
3. Release the sunroof switch after the sunroof moves slightly up and down.
4. Push and hold the switch to the open position ② to fully tilt the sunroof down.
5. Check if the sunroof switch operates normally.

If the sunroof does not operate properly after performing the procedure above, have your vehicle checked by a NISSAN dealer.

## POWER OUTLETS

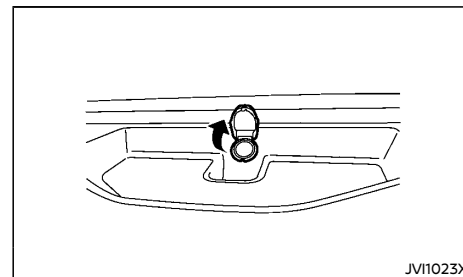

Instrument panel (upper)

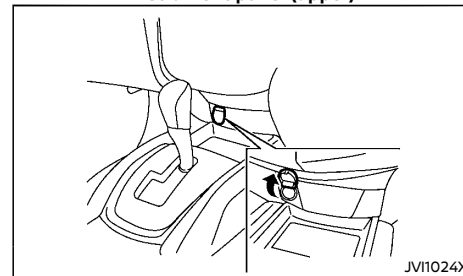

Instrument panel (lower)

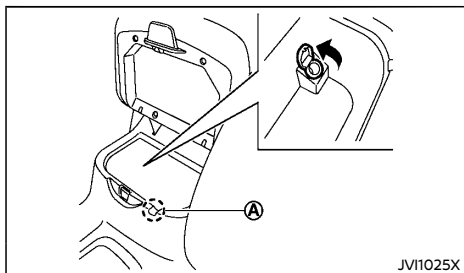

Console box (if equipped)

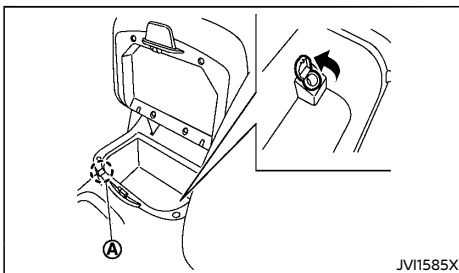

Console box

The power outlet is used for powering electrical accessories.

Use the cutout **A** between the lid and the console box to use a power cable with the console box lid closed.

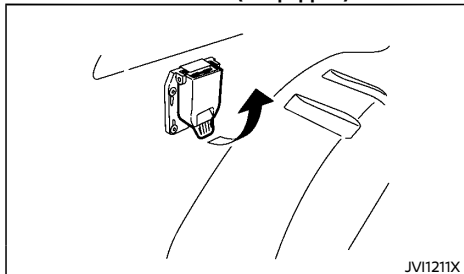

Truck box (if equipped)

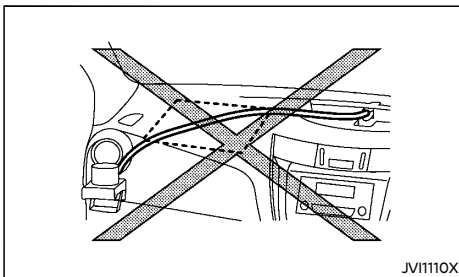

Instrument panel (upper)



**WARNING:**

Do not place any objects on the instrument panel. Such objects may become dangerous projectiles and cause injury if a supplemental air bag inflates (if equipped).

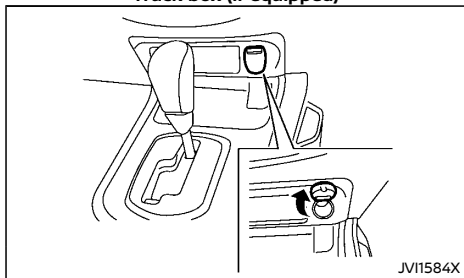

Instrument panel (lower)



**CAUTION:**

- Do not leave a power cable on the instrument panel in direct sunlight. The surface of the instrument panel may become very hot resulting in damage to the power cable.
- Do not put a liquid container near the power outlet. Spilled contents may get into the power outlet and can result in a malfunction.
- The outlet and plug may be hot during or immediately after use.
- This power outlet is not designed for use with a cigarette lighter unit.
- Do not use accessories that exceed a combined power draw of 12 volt, 120W (10A) (except for truck box power outlet) or 12 volt, 240W (20A) (for truck box power outlet). Do not use double adapters or more than one electrical accessory.
- Use this power outlet with the engine running to avoid discharging the vehicle battery.
- Avoid using when the air conditioner, headlights or rear window defogger is on (if equipped).
- Push the plug in as far as it will go. If good contact is not made, the plug may over-heat or the internal temperature fuse may blow.
- Before inserting or disconnecting a plug, be sure that the electrical accessory being used is turned OFF.
- When not in use, be sure to close the cap. Do not allow water or any liquid to contact the outlet.

## STORAGE

### **WARNING:**

- The storages should not be used while driving so that the full attention may be given to vehicle operation.
- Keep the storage lids closed while driving to help prevent injury in an accident or a sudden stop.

### GLOVE BOX

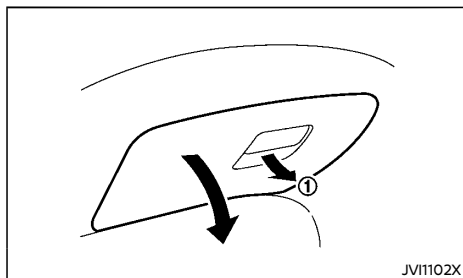

To open the glove box, pull the handle ①.  
To close, push the lid in until the lock latches.

### CONSOLE BOX (if equipped)

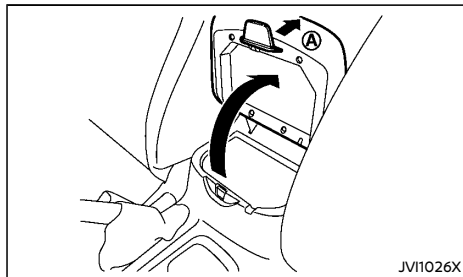

To open the console box lid, push up the knob A and pull up the lid.

To close, push the lid down until the lock latches.

### SUNGLASSES HOLDER (if equipped)

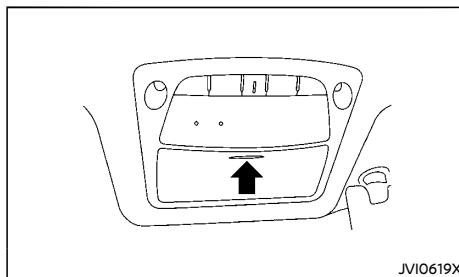

To open the sunglasses holder, push and release. Only store one pair of sunglasses in the holder.

### **WARNING:**

**Keep the sunglasses holder closed while driving to avoid obstructing the driver's view and to help prevent an accident.**

### **CAUTION:**

- Do not use for anything other than sunglasses.
- Do not leave sunglasses in the sunglasses holder while parking in direct sunlight. The heat may damage the sunglasses.

## CUP HOLDERS

### **WARNING:**

The driver must not remove or insert cups into the cup holder while driving so that full attention may be given to vehicle operation.

### **CAUTION:**

- Avoid abrupt starting and braking especially when the cup holder is being used to prevent spilling the contents. If the contents are hot, they could scald you or your passengers.
- Use only soft cups in the cup holder. Hard objects can injure you in an accident.

### Front (if equipped)

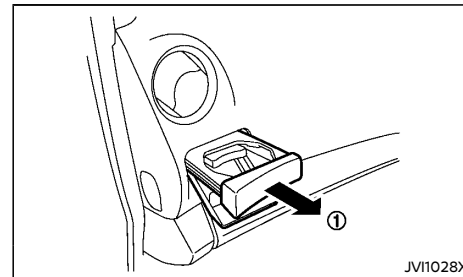

To open the cup holder, pull the holder ① from the instrument panel.

When the cup holder is not in use, keep it stored.



### Center console (front separate seat models)

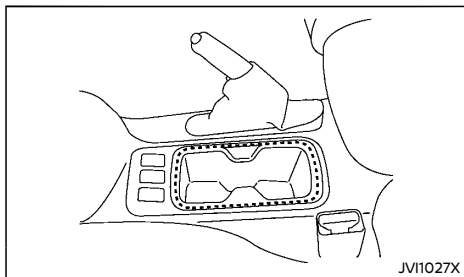

### Lower instrument panel (front bench seat models)

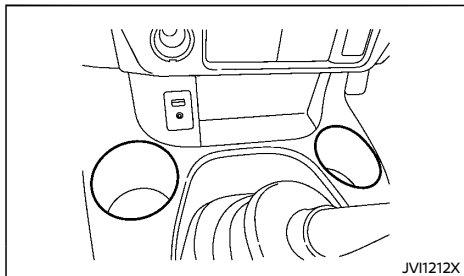

### Rear seat (if equipped for Double Cab models)

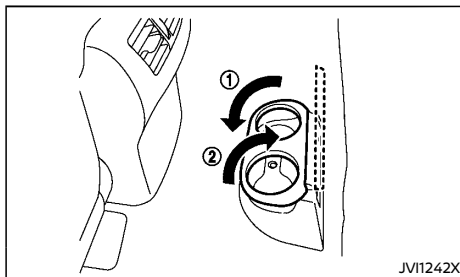

The cup holder for rear seats is located on the rear foot well area.

To use the cup holder, pull it down ①.

When the cup holder is not in use, keep it stored ②.

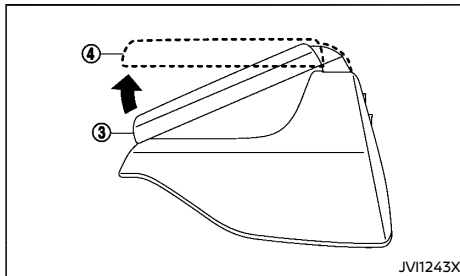

If an excessive force is applied on the cup holder, the cup holder may fold down lower than the normal position ③. If this occurs, pull the cup holder up to the original position ④.

### Soft bottle holder

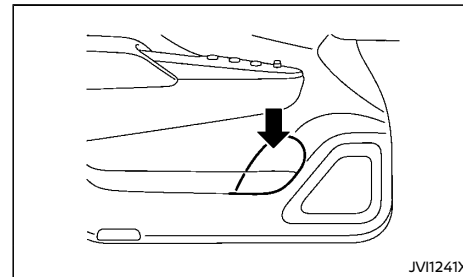

#### Example

The front and rear (if equipped) soft bottle holders are located on the doors.



#### CAUTION:

- Do not use bottle holder for any other objects that could be thrown about in the vehicle and possibly injure people during sudden braking or an accident.
- Do not use bottle holder for open liquid containers.

### ROOF RACK (if equipped)

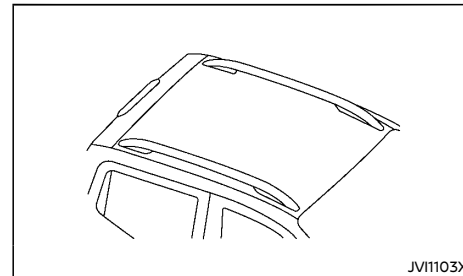

Do not apply any load directly to the roof side rails. Cross bars must be installed before applying load/cargo/luggage to the roof of the vehicle. Genuine NISSAN accessory cross bars may be available through a NISSAN dealer. Contact a NISSAN dealer for additional information.

The service load capacity for the roof side rails is 56 kg (125 lb), however do not exceed the accessory cross bars load capacity.



#### WARNING:

- Always install the cross bars onto the roof side rails before loading cargo of any kind. Loading cargo directly onto the roof side rails or the vehicle's roof may cause vehicle damage.
- Drive extra carefully when the vehicle is loaded at or near the cargo carrying capacity, especially if the significant portion of that load is carried on the roof rack.
- Heavy loading of the roof rack has the potential to affect the vehicle stability and handling during sudden or unusual handling maneuvers.
- Roof rack load should be evenly distributed.
- Do not exceed maximum roof rack load weight capacity.
- Properly secure all cargo with ropes or straps to help prevent it from sliding or shifting. In a sudden stop or collision, unsecured cargo could cause personal injury.

#### CARD HOLDER (if equipped)

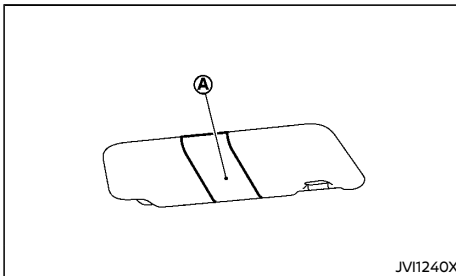

Slide a card in the card holder (A).

#### SUN VISORS

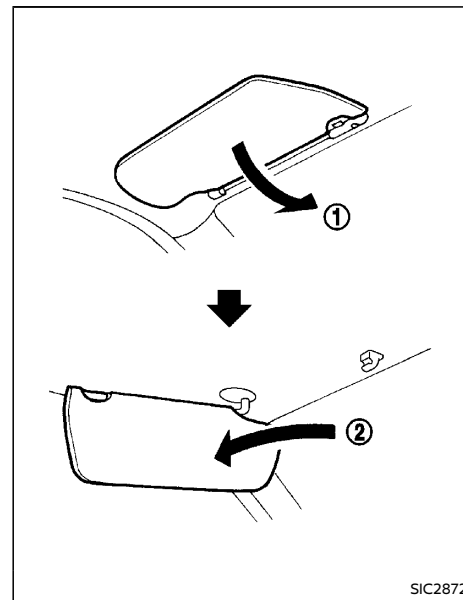

1. To block out glare from the front, swing down the sun visor ①.
2. To block glare from the side, remove the sun visor from the center mount and swing it to the side ②.

## INTERIOR LIGHTS



### CAUTION:

- Turn off the lights when you leave the vehicle.
- Do not use the lights for extended periods of time with the engine stopped. This could result in a discharged battery.

### INTERIOR LIGHT SWITCH (if equipped)

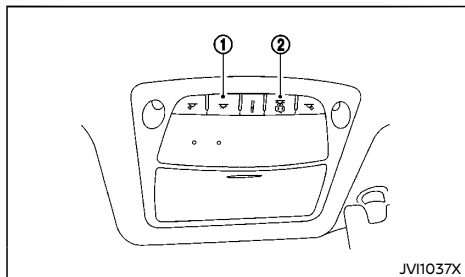

- ① The interior light can be turned ON regardless of door position. The light will go off after a period of time unless the ignition switch is placed in the "ON" position when any door is opened.
- ② The interior lights can be set to operate when the doors are opened. To turn off the interior lights when a door open, push the switch, the interior lights will not illuminate, regardless of door position. The lights will go off when the ignition switch is placed in the "ON" position, or the driver's door is closed and locked. The lights will also go off after a period of time when the doors are open.

### CONSOLE LIGHT (if equipped)

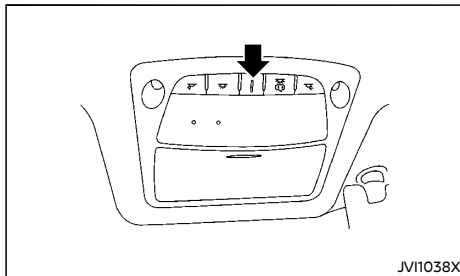

The console light will turn on whenever the clearance lights or headlights are illuminated.

### MAP LIGHTS

#### Type A

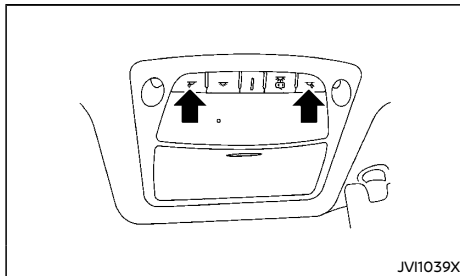

Push the button to turn the map lights on. To turn them off, push the button again.

#### Type B

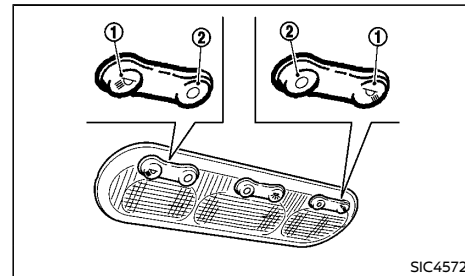

Operate the map light switch to turn the map light on or off.

- ① : ON position
- ② : OFF position

### MAP LIGHT CONTROL SWITCH (if equipped)

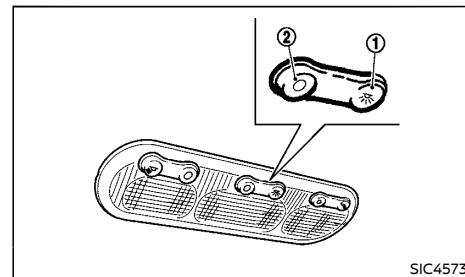

The map lights control switch has three positions: ON ①, OFF ② and center.

## ON position

When the switch is in the "ON" position ①, the map lights will illuminate.

## OFF position

When the switch is in the "OFF" position ②, the map lights will not illuminate, regardless of any other condition.

## Center position

When the switch is in the center position, the map lights will illuminate under the following conditions:

- the key is removed from the ignition switch
  - remain on for a period of time.
- doors are unlocked by pushing the "UNLOCK"  button (model with remote keyless entry system) with the ignition switch in the "LOCK" position
  - remain on for a period of time.
- any door is opened
  - remain on while the door is opened.
  - When the door is closed, the lights go off.

## ROOM LIGHT (if equipped)

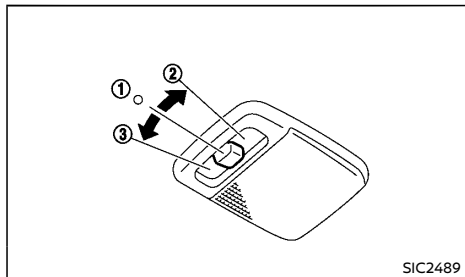

The room light has a three-position switch.

When the switch is in the "ON" position ②, the room light illuminates.

When the switch is in the "O" (Door) position ①, the room light illuminates when a door is opened.

The interior light timer will keep the room light on for a period of time when:

- The key is removed from the ignition switch with all doors closed (models without Intelligent Key).
- The ignition switch is placed in the "OFF" position with all doors closed (models with Intelligent Key).
- The driver's door is unlocked without the key in the ignition switch (models without Intelligent Key).
- The driver's door is unlocked when the ignition switch is in the "LOCK" position (models with Intelligent Key).
- The doors are unlocked with the "UNLOCK"  button (model with remote keyless entry system).
- The last door is closed without the key in the ignition switch (models without Intelligent Key).

The interior light timer will be cancelled when:

- Any door is locked by pushing the "LOCK" button on the remote controller (if equipped) with the ignition switch in the "OFF" position.
- Any door is locked by door handle request switch (if equipped) with the ignition switch in the "OFF" position.
- The ignition switch is placed in the "ON" position.

When the switch is in the "OFF" position ③, the room light does not illuminate, regardless of

any condition.

## REAR PERSONAL LIGHT (if equipped)

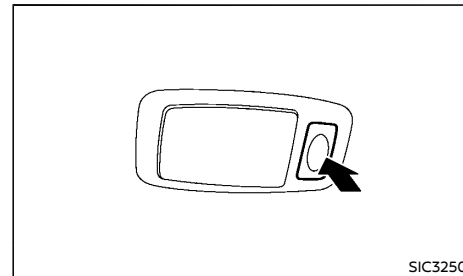

To turn the rear personal lights on, push the switch. To turn them off, push the switch again.

## VANITY MIRROR LIGHTS (if equipped)

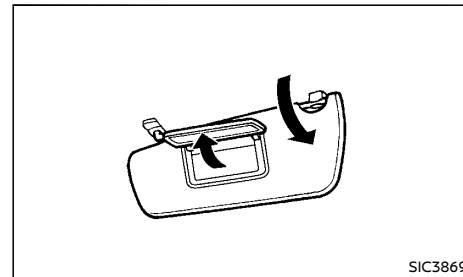

To access the vanity mirror, pull the sun visor down and flip open the mirror cover.

The vanity mirror light illuminates when the vanity mirror cover is opened. When the cover is closed, the light will turn off.

## **BATTERY SAVER SYSTEM**

The lights will turn off after a period of time when the lights remain illuminated to prevent the battery from becoming discharged.

**MEMO**

# 3 Pre-driving checks and adjustments

Keys .....	3-2	Security system (if equipped) .....	3-15
Key (if equipped) .....	3-2	Theft warning system (if equipped) .....	3-15
NISSAN Anti-Theft System (NATS) key (if equipped) .....	3-2	NISSAN Anti-Theft System (NATS) .....	3-15
Intelligent Key (if equipped) .....	3-3	Hood .....	3-16
Doors .....	3-4	Opening hood .....	3-17
Locking with key .....	3-4	Closing hood .....	3-17
Locking with inside lock knob .....	3-4	Fuel-filler lid and cap .....	3-17
Locking with power door lock switch (if equipped) ....	3-5	Opening fuel-filler lid (if equipped) .....	3-17
Rear access doors (King Cab models) .....	3-5	Fuel-filler cap .....	3-18
Child safety rear door locks (Double Cab models) ....	3-5	Truck box (if equipped) .....	3-19
Remote keyless entry system (if equipped) .....	3-6	Tailgate .....	3-19
Using remote keyless entry system .....	3-6	Tie down hooks (if equipped) .....	3-20
Intelligent Key system (if equipped) .....	3-7	C-Channel system (if equipped) .....	3-20
Intelligent Key operating range .....	3-8	Sport bar (if equipped) .....	3-22
Using Intelligent Key system .....	3-8	Steering wheel .....	3-23
Battery saver system .....	3-9	Steering wheel adjustment (if equipped) .....	3-23
Warning and audible reminders .....	3-9	Mirrors .....	3-23
Troubleshooting guide .....	3-11	Inside rearview mirror .....	3-23
Using remote keyless entry system .....	3-13	Outside rearview mirrors .....	3-24
Hazard indicator and horn operation .....	3-13	Vanity mirror (if equipped) .....	3-25
		Parking brake .....	3-25

## KEYS

A key number plate is supplied with your key. Record the key number on the key number plate/metal tag and keep it in a safe place (such as your wallet), NOT IN THE VEHICLE. NISSAN does not record key numbers so it is very important to keep track of your key number plate.

A key number is only necessary when you have lost all keys and do not have one to duplicate from. If you still have a key, this key can be duplicated by a NISSAN dealer.

### KEY (if equipped)

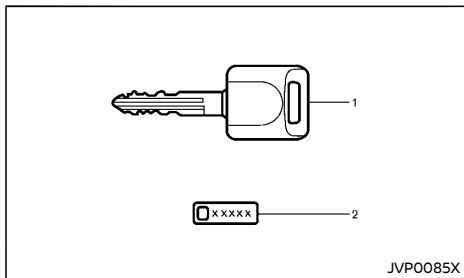

1. Master key (2)
2. Key number plate (1)

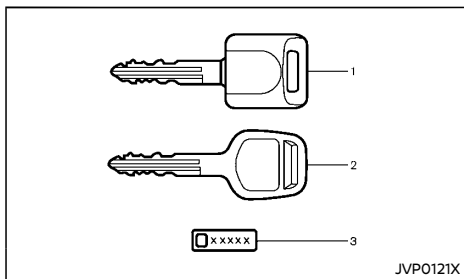

1. Master key (Molded) (1)
2. Master key (Plate) (1)
3. Key number plate (1)

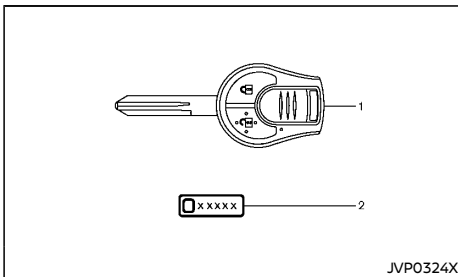

1. Master key (with remote controller) (2)
2. Key number plate (1)

As many as 5 master keys with remote controller can be registered and used with one vehicle.

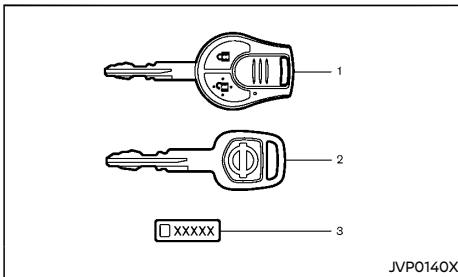

1. Master key (with remote controller) (1)
2. Plate key (1)
3. Key number plate (1)

As many as 5 master keys with remote controller can be registered and used with

one vehicle.

### NISSAN ANTI-THEFT SYSTEM (NATS\*) KEY (if equipped)

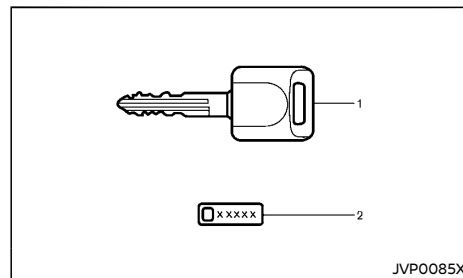

1. NATS key (molded) (2)
2. Key number plate (1)

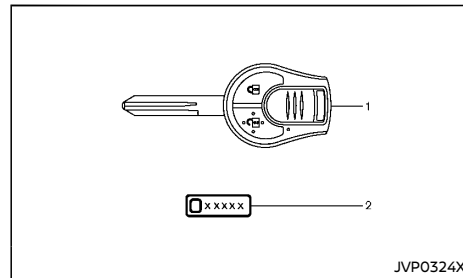

1. NATS key (with remote controller) (2)
2. Key number plate (1)

Your vehicle can only be driven with the NATS keys, which are registered to your vehicle's NATS components. As many as 5 NATS keys can be registered and used with one vehicle. The new keys must be registered by a NISSAN dealer prior to use with the NATS of your



vehicle. Since the registration process requires erasing all memory in the NATS components when registering new keys, be sure to take all NATS keys that you have to the NISSAN dealer.

**CAUTION:**

**Do not allow the NATS key, which contains an electrical transponder, to come into contact with water or salt water. This could affect the system function.**

\*: Immobilizer

INTELLIGENT KEY (if equipped)

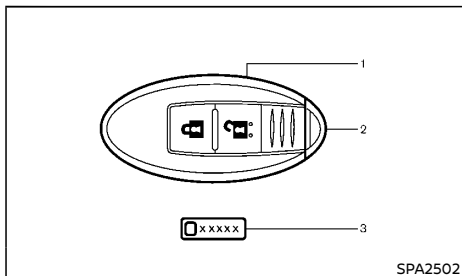

1. Intelligent Key (2)
2. Mechanical key (inside Intelligent Key) (2)
3. Key number plate (1)

**WARNING:**

- The Intelligent Key transmits radio waves that can adversely affect medical electric equipment.
- If you have a pacemaker, you should contact the medical equipment manufacturer to ask if it will be affected by the

**Intelligent Key signal.**

Your vehicle can only be driven with the Intelligent Keys, which are registered to your vehicle's Intelligent Key system components and NISSAN Anti-Theft System (NATS\*) components. As many as 4 Intelligent Keys can be registered and used with one vehicle. The new keys must be registered by a NISSAN dealer prior to use with the Intelligent Key system and NATS of your vehicle. Since the registration process requires erasing all memory in the Intelligent Key system components when registering new keys, be sure to take all Intelligent Keys that you have to a NISSAN dealer.

\*: Immobilizer

**CAUTION:**

- Be sure to carry the Intelligent Key with you. Do not leave the vehicle with the Intelligent Key inside.
- Be sure to carry the Intelligent Key with you when driving. The Intelligent Key is a precision device with a built-in transmitter. To avoid damaging it, please note the following.
  - The Intelligent Key is water resistant; however, wetting may damage the Intelligent Key. If the Intelligent Key gets wet, immediately wipe until it is completely dry.
  - Do not bend, drop or strike it against another object.
  - If the outside temperature is below  $-10^{\circ}\text{C}$  ( $14^{\circ}\text{F}$ ), the battery of the Intelligent Key may not function properly.
  - Do not place the Intelligent Key for an extended period in a place where temperatures exceed  $60^{\circ}\text{C}$  ( $140^{\circ}\text{F}$ ).

- Do not change or modify the Intelligent Key.
  - Do not use a magnet key holder.
  - Do not place the Intelligent Key near equipment that produces a magnetic field such as a TV, audio equipment and personal computers.
  - Do not allow the Intelligent Key to come into contact with water or salt water, and do not wash it in a washing machine. This could affect the system function.
- If an Intelligent Key is lost or stolen, NISSAN recommends erasing the ID code of that Intelligent Key. This will prevent the Intelligent Key from unauthorized use to unlock the vehicle. For information regarding the erasing procedure, please contact a NISSAN dealer.

Mechanical key

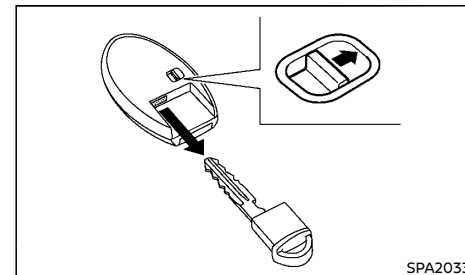

To remove the mechanical key, release the lock knob at the back of the Intelligent Key.

To install the mechanical key, firmly insert it into the Intelligent Key until the lock knob returns to the lock position.

## DOORS

Use the mechanical key to lock or unlock the doors and tailgate (if equipped). (See "Doors" (P.3-4) and "Tailgate" (P.3-19).)



### WARNING:

- Always look before opening any doors, to avoid an accident with oncoming traffic.
- To help avoid risk of injury or death through unintended operation of the vehicle and or its systems, including entrapment in windows or inadvertent door lock activation, do not leave children, people who require the assistance of others or pets unattended in your vehicle. Additionally, the temperature inside a closed vehicle on a warm day can quickly become high enough to cause a significant risk of injury or death to people and pets.

### LOCKING WITH KEY

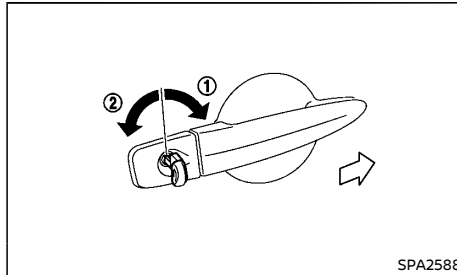

To lock the door, insert the mechanical key to the door key cylinder and turn the key to the front side of the vehicle ①.

To unlock the door, turn the key to the rear of the vehicle ②.

### LOCKING WITH INSIDE LOCK KNOB

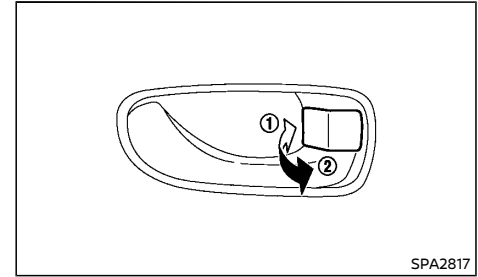

SPA2817



### CAUTION:

**When locking the doors using the inside lock knob, be sure not to leave the key or Intelligent Key in the vehicle.**

To lock the front doors, push the inside lock knob to the lock position ①, and then close the door while pulling the outside door handle.

To lock the rear doors (if equipped), push the inside lock knob to the lock position ① and then close the door.

To unlock, pull the inside lock knob to the unlock position ②.

**For driver's door (with power door lock switch):**

When the doors are locked, you do not need to operate the inside lock knob. Just pull the inside door handle to open the driver's door.

## LOCKING WITH POWER DOOR LOCK SWITCH (if equipped)

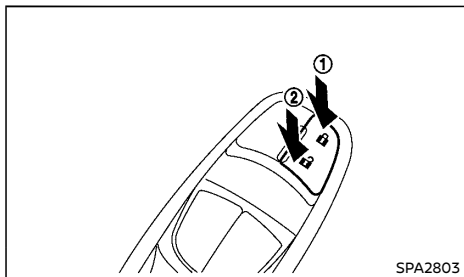

Operating the power door lock switch (located on the driver's door) will lock or unlock all the doors.

To lock the doors, push the power door lock switch to the lock position ① with the driver's door open, then close the door while pulling the outside door handle. All doors will lock.

### CAUTION:

- When locking the doors using the power door lock switch, be sure not to leave the key in the vehicle.
- When the Intelligent Key (if equipped) is left in the vehicle, and you try to lock the door using the power door lock switch after getting out of the vehicle, all the doors will unlock automatically after the door is closed.

To unlock, push the power door lock switch to the unlock position ②.

## REAR ACCESS DOORS (King Cab models)

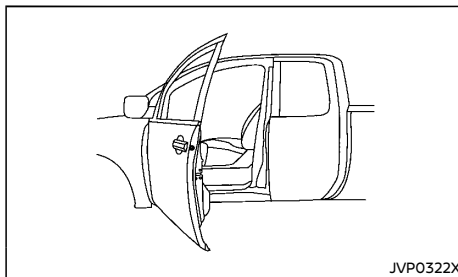

1. Open the driver's or passenger's door.

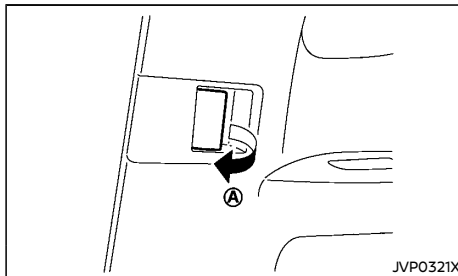

2. From the inside, pull the door handle  toward the front of the vehicle.

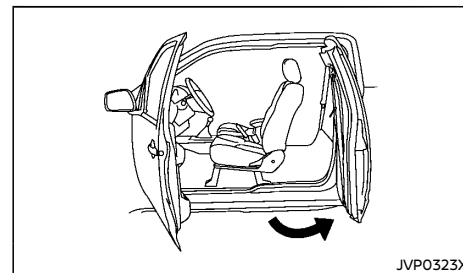

3. Open the door to the desired position.

## CHILD SAFETY REAR DOOR LOCKS (Double Cab models)

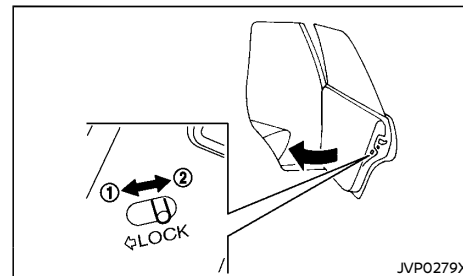

The child safety rear door locks help prevent rear doors from being opened accidentally, especially when small children are in the vehicle.

When the levers are in the lock position ①, the child safety rear door locks engage and the rear doors can only be opened by the outside door handles.

To disengage, move the levers to the unlock position ②.

## REMOTE KEYLESS ENTRY SYSTEM (if equipped)

The remote keyless entry system can operate all door locks using the remote controller. The remote controller can operate at a distance of approximately 1 m (3.3 ft) away from the vehicle. The operating distance depends upon the conditions around the vehicle.

As many as 5 remote controllers can be used with one vehicle. For information about the purchase and use of additional remote controllers, contact a NISSAN dealer.

The remote controller will not function under the following conditions:

- When the distance between the remote controller and vehicle is more than approximately 1 m (3.3 ft).
- When the remote controller battery is discharged.
- When the key is in the ignition switch.



### CAUTION:

- **When locking the doors using the remote controller, be sure not to leave the key in the vehicle.**
- **Do not allow the remote controller, which contains electrical components, to come into contact with water or salt water. This could affect the system function.**
- **Do not drop the remote controller.**
- **Do not strike the remote controller sharply against another object.**
- **Do not place the remote controller for an extended period in an area where temperatures exceed 60°C (140°F).**

If a remote controller is lost or stolen, NISSAN recommends erasing the ID code of that remote controller from the vehicle. This may prevent the unauthorized use of the remote

controller to unlock the vehicle. For information regarding the erasing procedure, contact a NISSAN dealer.

For information regarding the replacement of a battery, see "Battery" (P.8-21).

## USING REMOTE KEYLESS ENTRY SYSTEM

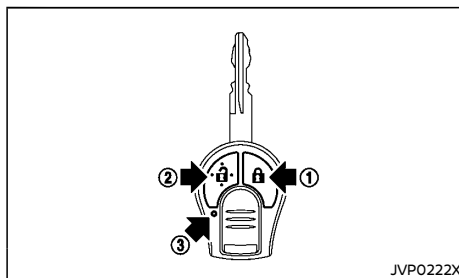

- ① LOCK button
- ② UNLOCK button
- ③ Battery indicator light

### Locking doors

1. Remove the ignition key.
2. Close all doors.
3. Push the "LOCK" button ① on the remote controller.
4. All doors will be locked.
5. Operate door handles to confirm that the doors have been securely locked.



### CAUTION:

**After locking the doors using the remote controller, be sure that the doors have been securely locked by operating the door han-**

**dles.**

### Unlocking doors

1. Push the "UNLOCK" button ② on the remote controller.
2. All doors will be unlocked.

All doors will be locked automatically unless one of the following operations is performed within 30 seconds after pushing the "UNLOCK" button ②.

- Opening any doors.
- Inserting the key into the ignition switch.

### Battery indicator light

The battery indicator light ③ illuminates when you push any button. If the light does not illuminate, the battery is weak or needs replacement. For information regarding replacement of a battery, see "Battery" (P.8-21).

### Hazard indicator operation

When you lock or unlock the doors, the hazard indicator will flash as a confirmation.

- "LOCK": The hazard indicator flashes once.
- "UNLOCK": The hazard indicator flashes twice.

## INTELLIGENT KEY SYSTEM (if equipped)



### WARNING:

- **Radio waves could adversely affect electric medical equipment. Those who use a pacemaker should contact the electric medical equipment manufacturer for the possible influences before use.**
- **The Intelligent Key transmits radio waves when the buttons are pushed. The radio waves may affect aircraft navigation and communication systems. Do not operate the Intelligent Key while on an airplane. Make sure the buttons are not operated unintentionally when the unit is stored during a flight.**

The Intelligent Key system can operate all doors using the remote controller function or pushing the request switch on the vehicle without taking the key out from a pocket or purse. The operating environment and/or conditions may affect the Intelligent Key system operation.

Be sure to read the following before using the Intelligent Key system.



### CAUTION:

- **Be sure to carry the Intelligent Key with you when operating the vehicle.**
- **Never leave the Intelligent Key in the vehicle when you leave the vehicle.**

The Intelligent Key is always communicating with the vehicle as it receives radio waves. The Intelligent Key system transmits weak radio waves. Environmental conditions may interfere with the operation of the Intelligent Key system under the following operating conditions.

- When operating near a location where strong radio waves are transmitted, such as a TV tower, power station and broadcasting station.
- When in possession of wireless equipment, such as a cellular telephone, transceiver, and CB radio.
- When the Intelligent Key is in contact with or covered by metallic materials.
- When any type of radio wave remote control is used nearby.
- When the Intelligent Key is placed near an electric appliance such as a personal computer.

In such cases, correct the operating conditions before using the Intelligent Key function or use the mechanical key.

Although the life of the battery varies depending on the operating conditions, the battery's life is approximately 2 years. If the battery is discharged, replace it with a new one.

For information regarding replacement of a battery, see "Battery" (P.8-21).

Since the Intelligent Key is continuously receiving radio waves, if the key is left near equipment which transmits strong radio waves, such as signals from a TV and personal computer, the battery life may become shorter.

Because the steering wheel is locked electrically, unlocking the steering wheel with the ignition switch in the "LOCK" position is impossible when the vehicle battery is completely discharged. Pay special attention that the vehicle battery is not completely discharged.

As many as 4 Intelligent Keys can be registered and used with one vehicle. For information about the purchase and use of additional Intelligent Keys, contact a NISSAN dealer.



### CAUTION:

- **Do not allow the Intelligent Key, which contains electrical components, to come into contact with water or salt water. This could affect the system function.**
- **Do not drop the Intelligent Key.**
- **Do not strike the Intelligent Key sharply against another object.**
- **Do not change or modify the Intelligent Key.**
- **Wetting may damage the Intelligent Key. If the Intelligent Key gets wet, immediately wipe until it is completely dry.**
- **If the outside temperature is below -10°C (14°F), the battery of the Intelligent Key may not function properly.**
- **Do not place the Intelligent Key for an extended period in an area where temperatures exceed 60°C (140°F).**
- **Do not attach the Intelligent Key with a key holder that contains a magnet.**
- **Do not place the Intelligent Key near equipment that produces a magnetic field, such as a TV, audio equipment and personal computers.**

If an Intelligent Key is lost or stolen, NISSAN recommends erasing the ID code of that Intelligent Key from the vehicle. This may prevent the unauthorized use of the Intelligent Key to operate the vehicle. For information regarding the erasing procedure, contact a NISSAN dealer.

The Intelligent Key function can be disabled. For information about disabling the Intelligent Key function, contact a NISSAN dealer.

## INTELLIGENT KEY OPERATING RANGE

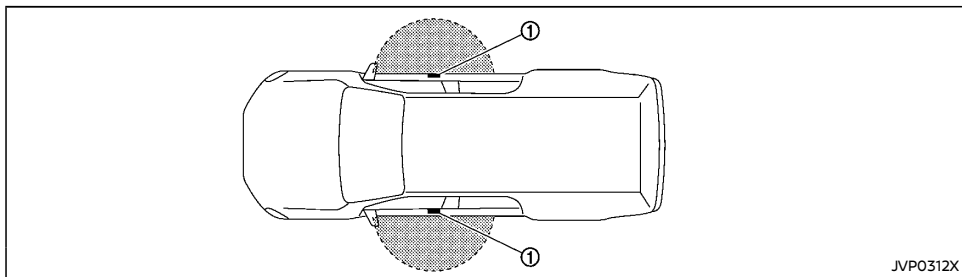

The Intelligent Key functions can only be used when the Intelligent Key is within the specified operating range from the request switch ①.

When the Intelligent Key battery is discharged or strong radio waves are present near the operating location, the Intelligent Key system's operating range becomes narrower, and the Intelligent Key may not function properly.

The operating range is within 80 cm (31.50 in) from each request switch ①.

If the Intelligent Key is too close to the door glass or door handle, the request switches may not function.

When the Intelligent Key is within the operating range, it is possible for anyone, even someone who does not carry the Intelligent Key, to push the request switch to lock/unlock the doors.

## USING INTELLIGENT KEY SYSTEM

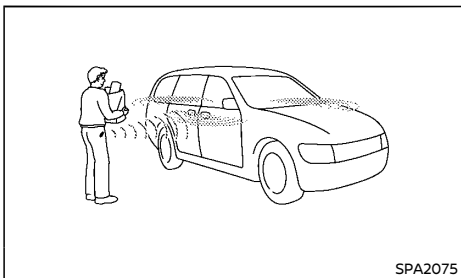

The request switch will not function under the following conditions:

- When another Intelligent Key is left inside the vehicle
- When the Intelligent Key is not within the operational range
- When any door is open or not closed securely
- When the Intelligent Key battery is discharged

- When the ignition switch is in the "ACC" or "ON" position

The Intelligent Key system (opening/closing doors with the door handle request switch) can be set to remain inactive. (See "Settings" (P.2-27).)

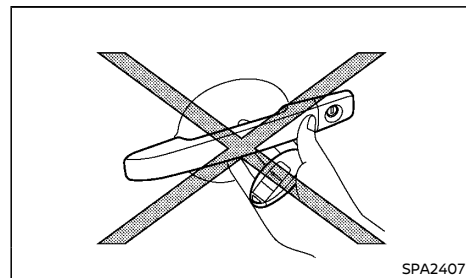

- Do not push the door handle request switch with the Intelligent Key held in your hand as illustrated. The close distance to the door handle will cause the Intelligent Key system to have difficulty recognizing that the Intelligent Key is outside the vehicle.
- After locking the doors using the door handle request switch, make sure that the doors have been securely locked by operating the door handles.
- When locking the doors using the door handle request switch, make sure to have the Intelligent Key in your possession before operating the door handle request switch to prevent the Intelligent Key from being left in the vehicle.
- The door handle request switch is operational only when the Intelligent Key has been detected by the Intelligent Key system.

- Do not pull the door handle before pushing the door handle request switch. The door will be unlocked but will not open. Release the door handle once and pull it again to open the door.

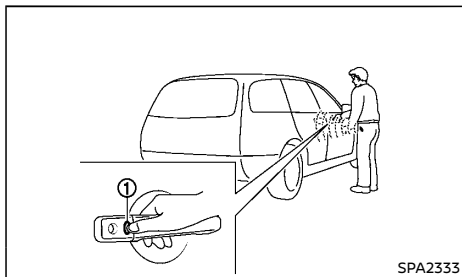

When you carry the Intelligent Key with you, you can lock or unlock all doors by pushing the door handle request switch ① (driver's or front passenger's door) within the range of operation.

When you lock or unlock the doors, the hazard indicator will flash as a confirmation. For details, see "Hazard indicator and horn operation" (P.3-13).

### Locking doors

- Push the ignition switch to the "OFF" position.
- Carry the Intelligent Key with you.
- Close all doors.
- Push the door handle request switch ① (driver's or front passenger's door).
- All doors will be locked.
- Operate door handles to confirm that the doors have been securely locked.

### Lockout protection:

To prevent the Intelligent Key from being accidentally locked in the vehicle, lockout protection is equipped with the Intelligent Key system.

- When the Intelligent Key is left in the vehicle and you try to lock the door using the power door lock switch after getting out of the vehicle, all the doors will unlock automatically and a chime will sound after the door is closed.



### CAUTION:

**The lockout protection may not function under the following conditions:**

- When the Intelligent Key is placed on top of the instrument panel.
- When the Intelligent Key is placed inside of the glove box.
- When the Intelligent Key is placed inside of the door pockets.
- When the Intelligent Key is placed inside or near metallic materials.

**The lockout protection may function when the Intelligent Key is outside the vehicle but is too close to the vehicle.**

### Unlocking doors

- Carry the Intelligent Key with you.
- Push the door handle request switch ①.
- All doors will be unlocked.

If a door handle is pulled while unlocking the doors, that door may not be unlocked. Returning the door handle to its original position will unlock the door. If the door does not unlock, after returning the door handle, push the door handle request switch to unlock the door.

### Automatic relock:

All doors will be locked automatically unless one of the following operations is performed within 30 seconds after pushing the request switch while the doors are locked.

- Opening any doors.
- Pushing the ignition switch.

If during the preset time period the "UNLOCK" button on the Intelligent Key is pushed, all doors will be locked automatically after the next preset time.

### BATTERY SAVER SYSTEM

When all the following conditions are met for a period of time, the battery saver system will cut off the power supply to prevent battery discharge.

- The ignition switch is in the "ACC" position, and
- All doors are closed, and
- The shift lever is in the "P" (Park) position (automatic transmission model).

### WARNING AND AUDIBLE REMINDERS

The Intelligent Key system is equipped with a function that is designed to minimize improper operations of the Intelligent Key and to help prevent the vehicle from being stolen. A chime or beep sounds inside and outside the vehicle and a warning message appears in the vehicle information display.

See the troubleshooting guide on the next page and "Vehicle information display (models with color display)" (P.2-20).



**CAUTION:**

**When the chime or beep sounds or the warning message appears, be sure to check both the vehicle and the Intelligent Key.**





## TROUBLESHOOTING GUIDE

Symptom		Possible cause	Action to take
When pushing the ignition switch to stop the engine	The Shift to Park warning appears in the vehicle information display and the inside warning chime sounds continuously or for a few seconds. (Automatic Transmission models)	The shift lever is not in the "P" (Park) position.	Shift the shift lever to the "P" (Park) position.
When shifting the shift lever to the P (Park) position	The inside warning chime sounds continuously. (Automatic Transmission models)	The ignition switch is in the "ACC" or "ON" position.	Push the ignition switch to the "OFF" position.
When opening the driver's door to get out of the vehicle	The inside warning chime sounds continuously.	The ignition switch is in the "ACC" position.	Push the ignition switch to the "OFF" position.
When closing the door after getting out of the vehicle	The No Key Detected warning appears on the display, the outside chime sounds 3 times and the inside warning chime sounds for a few seconds.	The ignition switch is in the "ACC" or "ON" position.	Push the ignition switch to the "OFF" position.
	The Shift to Park warning appears in the vehicle information display and the outside chime sounds continuously. (Automatic Transmission models)	The ignition switch is in the "ACC" or "OFF" position and the shift lever is not in the "P" (Park) position.	Move the shift lever to the "P" (Park) position and push the ignition switch to the "OFF" position.
When pushing the request switch or the "LOCK"  button on the Intelligent Key to lock the door	The outside chime sounds for a few seconds and all the doors unlock.	The Intelligent Key is inside the vehicle.	Carry the Intelligent Key with you.
When closing the door with the inside lock knob turned to "LOCK"	The outside chime sounds for a few seconds and all the doors unlock.	The Intelligent Key is inside the vehicle.	Carry the Intelligent Key with you.
When pushing the door handle request switch to lock the door	The outside chime sounds for a few seconds.	The Intelligent Key is inside the vehicle.	Carry the Intelligent Key with you.
		A door is not closed securely.	Close the door securely.
		The door handle request switch is pushed before the door is closed.	Push the door handle request switch after the door is closed.

Symptom		Possible cause	Action to take
When pushing the ignition switch to start the engine	The Key Battery low warning appears in the vehicle information display.	The battery charge is low.	Replace the battery with a new one. (See "Battery" (P.8-21).)
	The No Key Detected warning appears in the display and the inside warning chime sounds for a few seconds.	The Intelligent Key is not in the vehicle.	Carry the Intelligent Key with you.
When pushing the ignition switch	The Key System Error warning appears in the vehicle information display.	It warns of a malfunction with the electrical steering lock system (if equipped) or the Intelligent Key system.	Contact a NISSAN dealer.

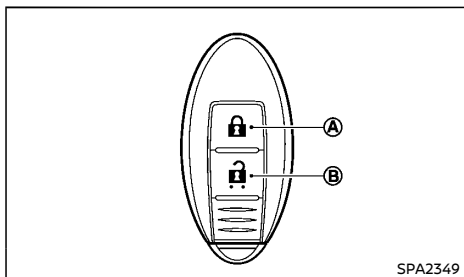
## USING REMOTE KEYLESS ENTRY SYSTEM



- Ⓐ LOCK button 
- Ⓑ UNLOCK button 

### Operating range

The remote keyless entry system allows you to lock/unlock all doors. The operating distance depends upon the conditions around the vehicle. To securely operate the lock and unlock buttons, approach the vehicle to about 1 m (3.3 ft) from the door.

The remote keyless entry system will not function under the following conditions:

- When the Intelligent Key is not within the operational range.
- When the Intelligent Key battery is discharged.

For information regarding the replacement of a battery, see "Battery" (P.8-21).

### Locking doors

1. Place the ignition switch in the "OFF" position.
2. Carry the Intelligent Key with you.
3. Close all doors.
4. Push the "LOCK"  button Ⓐ on the Intelligent Key.
5. All doors will be locked.
6. Operate the door handles to confirm that the doors have been securely locked.



### CAUTION:

- **After locking the doors using the Intelligent Key, be sure that the doors have been securely locked by operating the door handles.**
- **When locking the doors using the Intelligent Key, be sure not to leave the key in the vehicle.**

### Unlocking doors

1. Push the "UNLOCK"  button Ⓑ on the Intelligent Key.
2. All doors will be unlocked.

### Automatic relock:

All doors will be locked automatically unless one of the following operations is performed within 30 seconds after pushing the "UNLOCK"  Ⓑ button on the Intelligent Key while the doors are locked.



- Opening any doors.
- Pushing the ignition switch.

If during the preset time period the "UNLOCK"  Ⓑ button on the Intelligent Key is pushed, all doors will be locked automatically after the next preset time.

## HAZARD INDICATOR AND HORN OPERATION

When you lock or unlock the doors, the hazard indicator will flash and the horn (or the outside chime) will sound as a confirmation.

The following descriptions show how the hazard indicator and horn/chime will activate when locking or unlocking the doors.

Operation	<b>DOOR LOCK</b>	<b>DOOR UNLOCK</b>
<b>Intelligent Key system (using request switch)</b>	HAZARD - <b>once</b> OUTSIDE CHIME - <b>once</b>	HAZARD - <b>twice</b> OUTSIDE CHIME - <b>twice</b>
<b>Remote keyless entry system (using  or  button)</b>	HAZARD - <b>once</b> HORN - <b>once</b>	HAZARD - <b>twice</b> HORN - <b>twice</b>

## SECURITY SYSTEM (if equipped)

Your vehicle has either or both of the following security systems:

- Theft warning system
- NISSAN Anti-Theft System (NATS\*)

\*: Immobilizer

The security condition will be shown by the security indicator light.

### THEFT WARNING SYSTEM (if equipped)

The theft warning system provides visual and audio alarm signals if parts of the vehicle are disturbed.

### Security indicator light

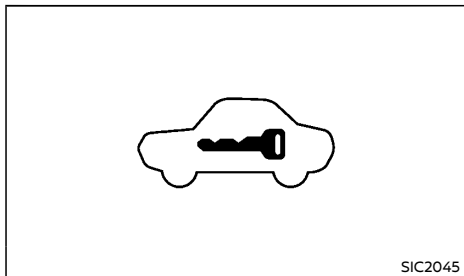

The security indicator light, located on the meter panel, operates whenever the ignition switch is in the "LOCK", "OFF" or "ACC" position. This is normal.

### How to activate system (if equipped)

1. Close all windows.  
**The system can be armed even if the windows are open.**
2. Place the ignition switch in the "OFF" position.
3. Carry the remote controller or the Intelligent Key with you and get out of the vehicle.
4. Make sure the hood is closed (for Malaysia). Close and lock all doors. The doors can be locked with the remote controller, the Intelligent Key or door handle request switch (if equipped).
5. Confirm that the security indicator light comes on. The security indicator light glows for about 30 seconds and then blinks. The system is now activated. If, during this 30 second time period, the door is unlocked or the ignition switch is placed in the "ACC" or "ON" position, the system will not activate.

**Even when the driver and/or passengers are in the vehicle, the system will activate with all doors and hood (for Malaysia) locked with the ignition switch in the "LOCK" position. When pushing the ignition switch to the "ACC" or "ON" position, the system will be released.**

### Theft warning system operation

The vehicle security system will give the following alarm:

- The hazard indicator blinks and the horn sounds intermittently.
- The alarm automatically turns off after approximately 30 seconds. However, the alarm reactivates if the vehicle is tampered

with again.

The alarm is activated by:

- Unlocking the door without using the remote controller, the Intelligent Key, the door handle request switch (if equipped) or the mechanical key. (Even if the door is opened by releasing the door inside lock knob, the alarm will activate.)
- opening the hood (for Malaysia).

### How to stop alarm

- The alarm will stop only by unlocking a door by pushing the "UNLOCK" button on the Intelligent Key.
- The alarm will not stop if the ignition switch is placed in the "ACC" or "ON" position.

### NISSAN ANTI-THEFT SYSTEM (NATS)

The NISSAN Anti-Theft System (NATS) will not allow the engine to start without the use of the registered NATS key.

If the engine does not start using the registered NATS key, it may be due to interference caused by:

- Another NATS key.
- Automated toll road device.
- Automated payment device.
- Other devices that transmit similar signals.

Start the engine using the following procedure:

1. Remove any items that may be causing the interference away from the NATS key.
2. Leave the ignition switch in the "ON" position for approximately 5 seconds.
3. Place the ignition switch in the "OFF" or "LOCK" position, and wait approximately 10 seconds.

4. Repeat steps 2 and 3 again.
5. Start the engine.
6. Repeat the steps above until all possible interferences are eliminated.

If this procedure allows the engine to start, NISSAN recommends placing the registered NATS key separate from other devices to avoid interference.

**FCC Notice:**

**This device complies with Part 15 of the FCC Rules. Operation is subject to the following two conditions: (1) this device may not cause harmful interference, and (2) this device must accept any interference received, including interference that may cause undesired operation.**

**Note: Changes or modifications not expressly approved by the party responsible for compliance could void the user's authority to operate the equipment.**

Security indicator light

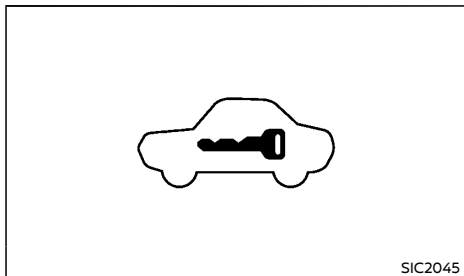

The security indicator light is located in the meter panel. It indicates the status of NATS.

The light operates whenever the ignition switch is in the "LOCK", "ACC" or "OFF" position.

**3-16 Pre-driving checks and adjustments**

## HOOD



**WARNING:**

- **The hood must be closed and latched securely before driving. Failure to do so could cause the hood to fly open and result in an accident.**
- **Never open the hood if steam or smoke is coming from the engine compartment to avoid injury.**

## OPENING HOOD

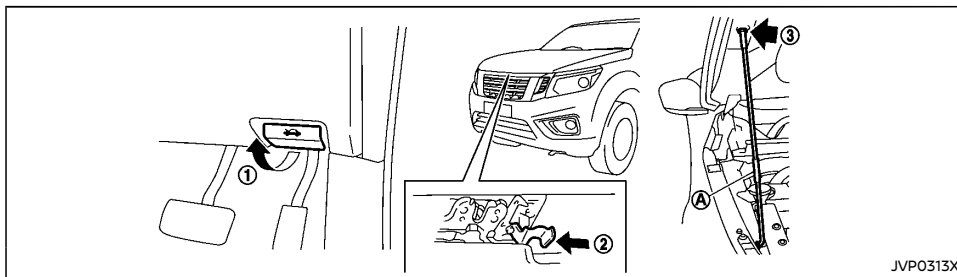

1. Pull the hood lock release handle ① located below the instrument panel until the hood springs up.
2. Locate the lever ② in between the hood and grille and push the lever with your fingertips.
3. Raise the hood.
4. Remove the support rod and insert it into the slot ③.

**Hold the coated parts ④ when removing or resetting the support rod. Avoid direct contact with the metal parts, as they may be hot immediately after the engine has been stopped.**

## CLOSING HOOD

1. While supporting the hood, return the support rod to its original position.
2. Slowly lower the hood to about 20 to 30 cm (8 to 12 in) above the hood lock, then let it drop.
3. Make sure it is securely latched.

## FUEL-FILLER LID AND CAP



### WARNING:

- Fuel is extremely flammable and highly explosive under certain conditions. You could be burned or seriously injured if it is misused or mishandled. Always stop the engine and do not smoke or allow open flames or sparks near the vehicle when refueling.
- Fuel may be under pressure. Turn the cap a half of a turn, and wait for any "hissing" sound to stop to prevent fuel from spraying out and possibly causing personal injury. Then remove the cap.
- Use only an original equipment type fuel-filler cap as a replacement. It has a built-in safety valve needed for proper operation of the fuel system and emission control system. An incorrect cap can result in a serious malfunction and possible injury.

## OPENING FUEL-FILLER LID (if equipped)

### Type A

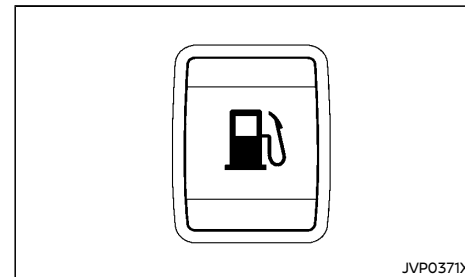

To open the fuel-filler lid, push the fuel-filler lid opener switch located on the lower side of the

instrument panel.

To lock the fuel-filler lid, close the lid until it securely locks.

### Type B

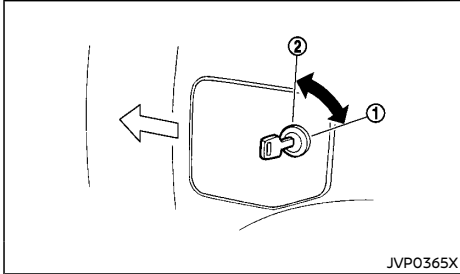

To open the fuel-filler lid, turn the key clockwise ①. To lock, close it and turn the key counter-clockwise ②.

### FUEL-FILLER CAP

#### Type A

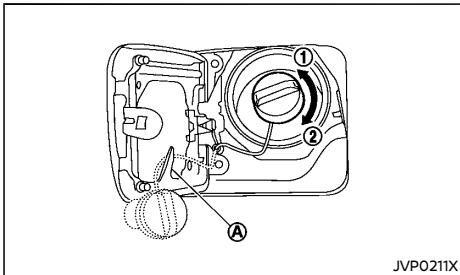

The fuel-filler cap is a ratcheting type. Turn the cap counterclockwise ① to remove. Tighten the cap clockwise ② until ratchet clicks, more than

twice, after refueling.

Put the fuel-filler cap on the cap holder (A) while refueling.



### CAUTION:

If fuel is spilled on the vehicle body, flush it away with water to avoid paint damage.

#### Type B

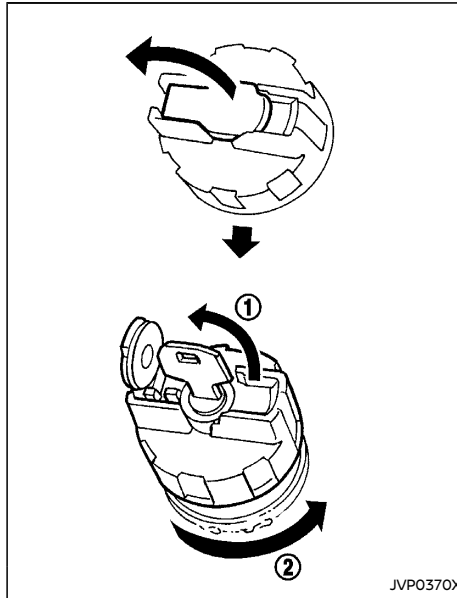

To open the fuel-filler cap, turn the key counterclockwise ①.

Turn the fuel-filler cap counterclockwise ②

after the cap is unlocked.

The fuel-filler cap is a screw-on ratcheting type. After refueling, tighten the cap clockwise until more than 2 ratcheting clicks are heard. The fuel-filler cap locks automatically when it is tightened.



## TRUCK BOX (if equipped)

### WARNING:

- While driving, never allow anyone to ride in the cargo area. Abrupt braking or stopping could lead to personal injury.
- Do not drive the vehicle with the tailgate down.
- Properly secure all cargo with ropes or straps to help prevent it from sliding or shifting. In a sudden stop or collision, unsecured cargo could cause personal injury.

## TAILGATE

### Locking or unlocking tailgate (if equipped)

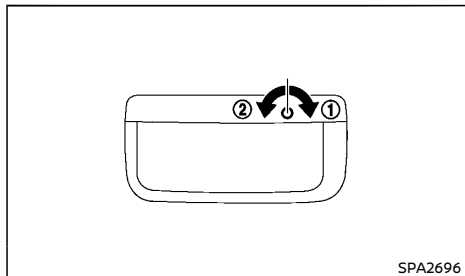

To lock the tailgate, insert the key to the tailgate key cylinder and turn the key clockwise ①.

To unlock the tailgate, turn the key counter-clockwise ②.

For Intelligent Key equipped models, see "Mechanical key" (P.3-3) for removing the mechanical key.

## Opening the tailgate

### Type A:

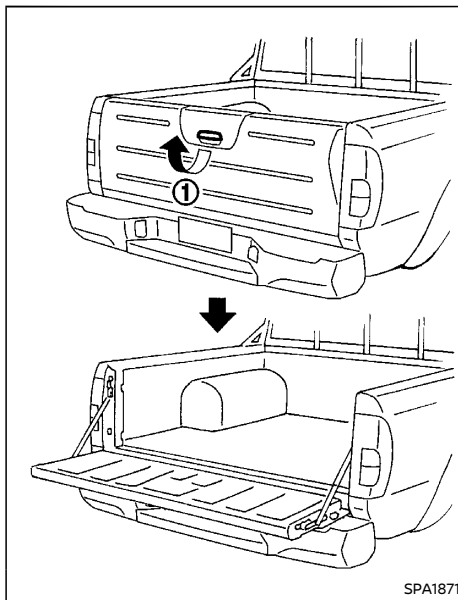

To open the tailgate, pull the tailgate handle ① and lower the tailgate. The support wires will hold the gate open.

### Type B:

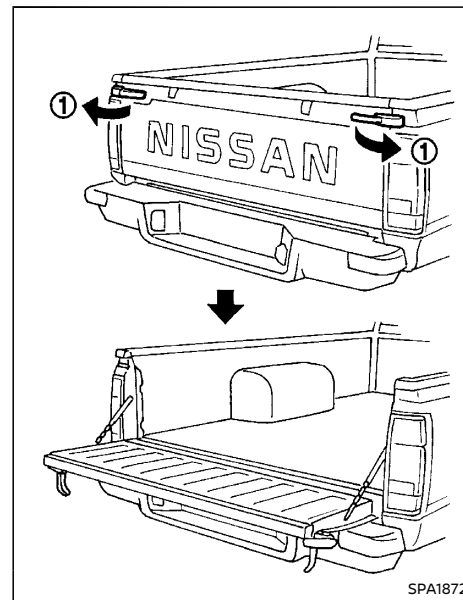

To open the tailgate, pull the tailgate levers ① and lower the tailgate. The support wires will hold the gate open.

- The weight of the cargo load must be evenly distributed over both the front and the rear axles.
- All cargo should be securely fastened with ropes or straps to prevent it from shifting or sliding within the vehicle.

**WARNING:**

- Do not drive the vehicle with the tailgate down.
- While driving, never allow anyone to ride in the cargo area. Abrupt braking or stopping could lead to personal injury.

### Closing the tailgate

When closing the tailgate, make sure that the latches or levers are securely locked.

### TIE DOWN HOOKS (if equipped)

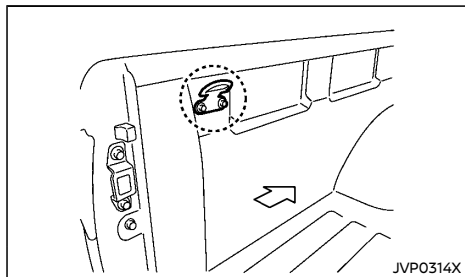

Type A

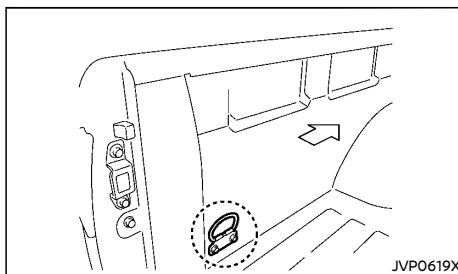

Type B

For your convenience, four tie down hooks are placed on the inside of the truck box. These may be used to help secure cargo loaded into the truck box.

- The weight of the cargo load must be evenly distributed over both the front and rear axles.
- All cargo should be securely fastened with ropes or straps to prevent it from shifting or sliding within the vehicle.

### C-CHANNEL SYSTEM (if equipped)

**WARNING:**

- Properly install and tighten the tie-down cleats into the C-Channel system. Also, do not attach any rope or straps directly to the channel. Failure to properly install the tie-down cleats or attaching ropes or straps directly to the channel can cause the cargo to become unsecured. In a sudden stop or collision, unsecured cargo could cause personal injury.
- Properly secure all cargo with ropes or straps to help prevent it from sliding or shifting. In a sudden stop or collision, unsecured cargo could cause personal

injury.

- Do not place cargo higher than the seat-backs. In a sudden stop or collision, unsecured cargo could cause personal injury.
- Overloading not only can shorten the life of your vehicle and the tire, but can also cause unsafe vehicle handling and longer braking distances. This may cause a premature tire failure which could result in a serious accident and personal injury. Failures caused by overloading are not covered by the vehicle's warranty.
- Do not install accessories over the gap between the front and rear side channels. Doing so could affect the rear structure in certain rear impacts, which could result in serious injury.

The C-Channel system allows you to move tie-down clamps in the bed to the best location to secure a load.

The tie-down cleats must be installed so the clamp is properly seated in the notches in the rail. If the tie-down cleat is not seated in the notches, it will not be properly tightened. The bolt in the center of the cleat must be securely tightened.

Check the tightness of the tie-down cleat periodically during a trip to make sure the center bolt has not become loose.

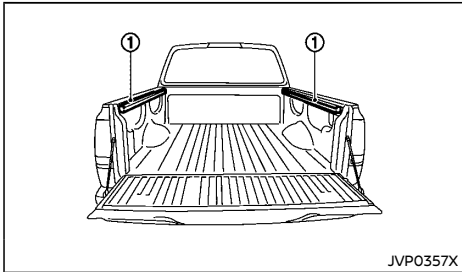

① Side channels

Install the tie-down cleat as follows:

1. Loosen the center bolt completely.

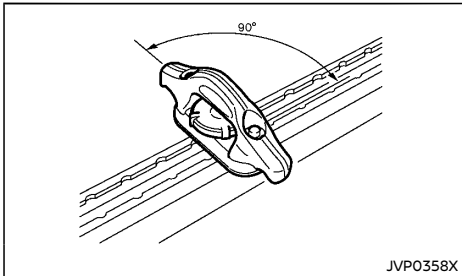

2. Insert the cleat into the channel perpendicular to the channel as shown. Then rotate the cleat clockwise 90° and slide it to desired location.

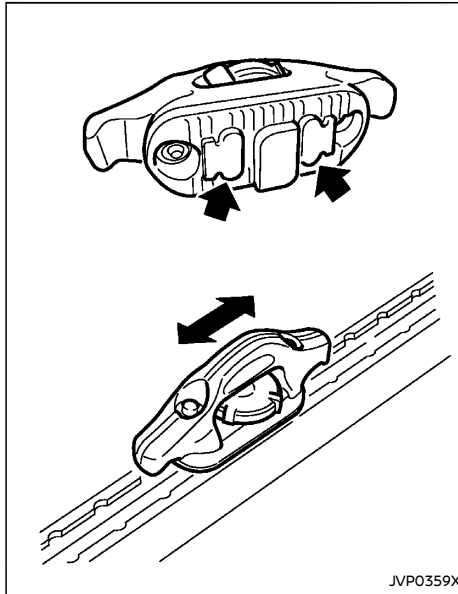

3. Position the cleat so the nubs on the bottom fully seat into the channel detents.

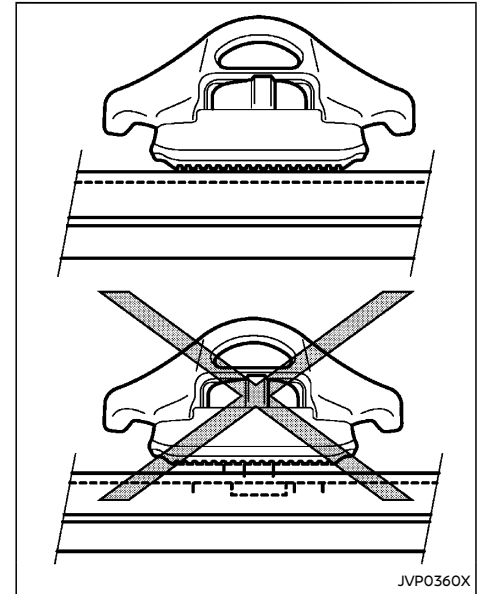

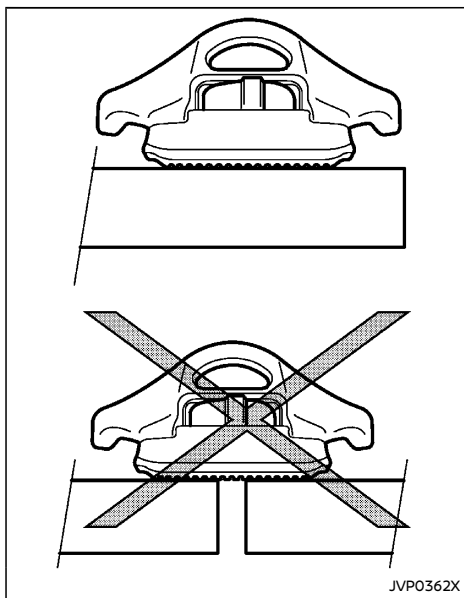

4. There should be no gap between the bottom of the cleat and the top of the channel. Securely tighten the center bolt.

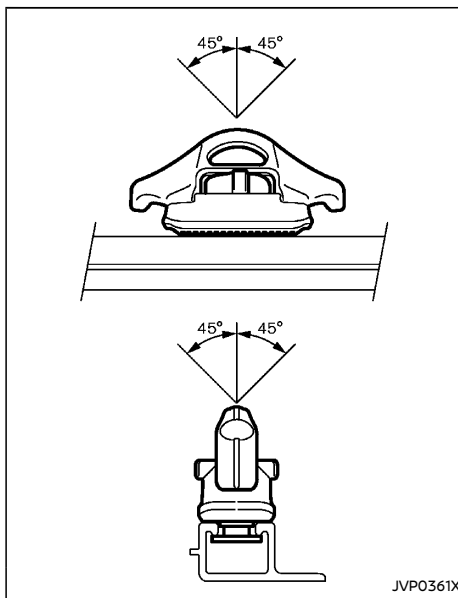

**CAUTION:**

- Install only one cleat per section of channel.
- Applying loads at angles to the cleats that are greater than 45° or loads greater than 90 kg (200 lbs.) may cause damage to the channel or the bed.

**SPORT BAR (if equipped)**

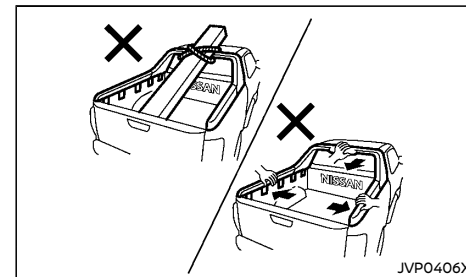

**CAUTION:**

Do not put a load on the sport bar as the examples shown in the illustration. The sport bar is an accessory for ornamental purposes which is not designed to support and hold the weight of the objects including tension and pressure on itself.

## STEERING WHEEL

STEERING WHEEL ADJUSTMENT (if equipped)



### WARNING:

Never adjust the steering wheel while driving so that full attention may be given to vehicle operation.

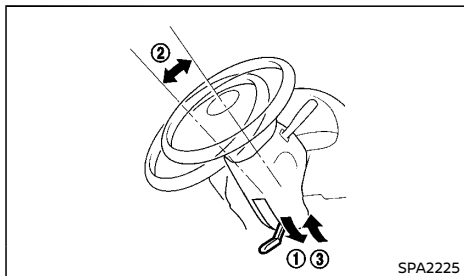

Pull the lock lever down ① and adjust the steering wheel up or down ② until the desired position is achieved.

Push the lock lever back ③ firmly to lock the steering wheel in place.

## MIRRORS



### WARNING:

Adjust the position of all mirrors before driving. Do not adjust the mirror positions while driving so that full attention may be given to vehicle operation.

### INSIDE REARVIEW MIRROR

While holding the inside rearview mirror, adjust the mirror angles until the desired position is achieved.

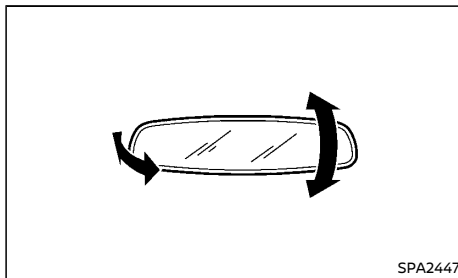

### Manual anti-glare type

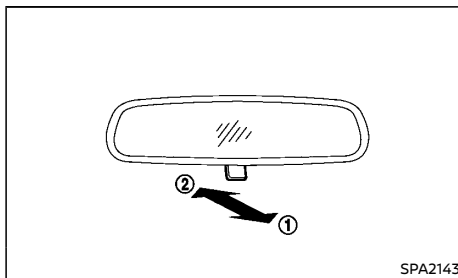

Pull the adjusting lever ① when the glare from

the headlights of the vehicle behind you obstructs your vision at night.

Push the adjusting lever ② during the day for the best rearward visibility.

### Automatic anti-glare type

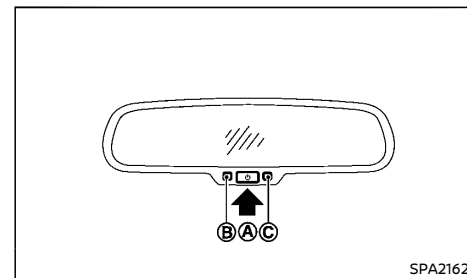

Type A

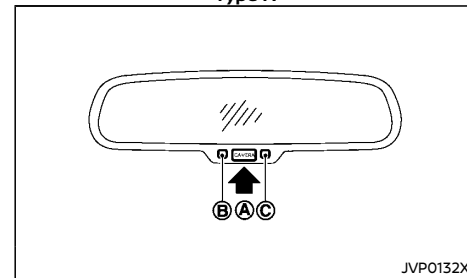



Type B

The inside rearview mirror is designed so that it automatically changes reflection according to the intensity of the headlights of the vehicle following you.

The anti-glare system will be automatically turned on when you push the ignition switch to the "ON" position.

When the system is turned on, the indicator light  will illuminate and excessive glare from the headlights of the vehicle behind you will be reduced.

Push the switch  for 3 seconds to make the inside rearview mirror operate normally and the indicator light will turn off. Push the switch again for 3 seconds to turn the system on.

**Do not hang any objects on the mirror or apply glass cleaner. Doing so will reduce the sensitivity of the sensor , resulting in improper operation.**

For the compass (if equipped) operation, see "Compass" (P.2-11).

For the monitor display (if equipped) operation, see "Rear view monitor" (P.4-7) or "Around View Monitor" (P.4-13).

## OUTSIDE REARVIEW MIRRORS

### WARNING:

- **Never touch the outside rearview mirrors while they are in motion. Doing so may pinch your fingers or damage the mirror.**
- **Never drive the vehicle with the outside rearview mirrors folded. This reduces rear view visibility and may lead to an accident.**
- **Objects viewed in the outside mirror are closer than they appear (if equipped).**
- **The picture dimensions and distance in the outside mirrors are not real.**

## Adjusting

### Manual type:

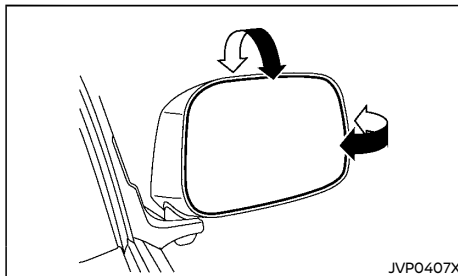

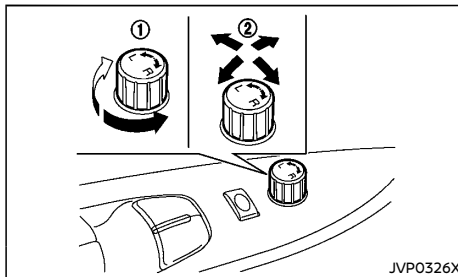

The outside rearview mirror can be moved in any direction for a better rear view.

### Remote control type:



The outside rearview mirror remote control operates when the ignition switch is in the "ACC" or "ON" position.

1. Turn the switch to select the left (L) or right (R) mirror .
2. Adjust each mirror by pushing the switch until the desired position is achieved .

## Defogging (if equipped)

The outside rearview mirrors will be heated when the rear window defogger switch is operated.

## Folding

### Manual type:

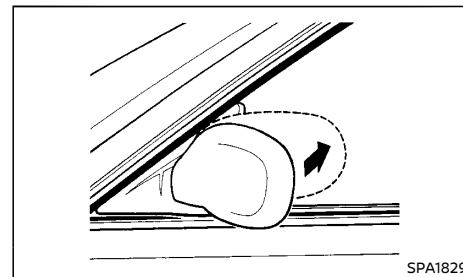

Fold the outside rearview mirror by pushing it toward the rear of the vehicle.

### Remote control type:

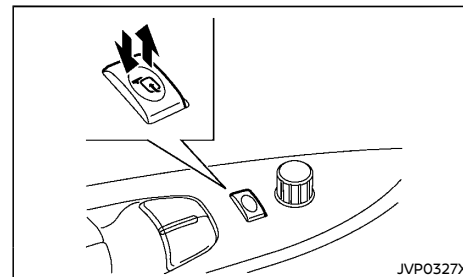

The outside rearview mirror remote control operates when the ignition switch is in the "ACC" or "ON" position.

## PARKING BRAKE

The outside rearview mirrors automatically fold when the outside rearview mirror folding switch is pushed in. To unfold, push to the switch again.



### CAUTION:

Continuously performing the fold/unfold operation of the outside rearview mirror may cause the switch to stop the operation.

### VANITY MIRROR (if equipped)

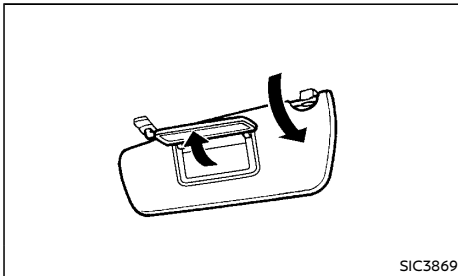

SIC3869

To use the front vanity mirror, pull down the sun visor and pull up the cover.



### WARNING:

- **Never drive the vehicle with the parking brake applied. The brake will overheat and fail to operate and will lead to an accident.**
- **Never release the parking brake from outside the vehicle. If the vehicle moves, it will be impossible to push the brake pedal and will lead to an accident.**
- **Never use the shift lever in place of the parking brake. When parking, be sure the parking brake is fully applied.**
- **To help avoid risk of injury or death through unintended operation of the vehicle and/or its systems, do not leave children, people who require the assistance of others or pets unattended in your vehicle. Additionally, the temperature inside a closed vehicle on a warm day can quickly become high enough to cause a significant risk of injury or death to people and pets.**

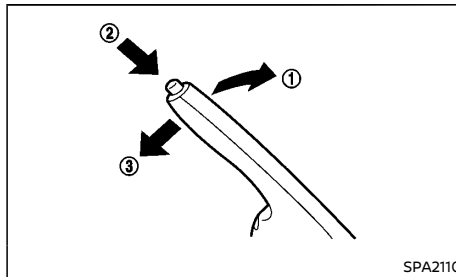

SPA2110

To apply the parking brake, pull the parking brake lever up ①.

To release the parking brake, depress and hold

the foot brake pedal. Pull up the parking brake lever slightly, push the button ② and lower the lever completely ③.

Before driving, be sure that the brake warning light has turned off.

**MEMO**



# 4 Monitor, air conditioner, audio and phone system

NissanConnect Owner's Manual (if equipped) .....	4-3	Ventilators .....	4-20
Safety precautions .....	4-3	Center ventilators .....	4-20
Center multi-function control panel (for type F audio) .....	4-4	Side ventilators .....	4-20
How to use touch screen display .....	4-4	Rear ventilators (if equipped) .....	4-21
How to use brightness control/display on-off button .....	4-5	Heater and air conditioner .....	4-21
How to use ENTER/Scroll dial .....	4-5	Operating tips (models with automatic air conditioner) .....	4-22
How to use BACK button .....	4-5	Air Conditioner .....	4-22
Vehicle information and settings (for type F audio) .....	4-5	Manual air conditioner and heater (Type A) .....	4-24
How to use INFO button .....	4-5	Manual air conditioner and heater (Type B) .....	4-26
How to use SETUP button .....	4-6	Automatic air conditioner .....	4-29
Rear view monitor (if equipped) .....	4-7	Servicing air conditioner .....	4-30
How to read the displayed lines .....	4-8	Audio system (if equipped) .....	4-31
Difference between predictive and actual distances .....	4-9	Audio operation precautions .....	4-31
How to park with predictive course lines (if equipped) .....	4-10	FM-AM radio with compact disc (CD) player (Type A) .....	4-39
How to adjust the screen (if equipped) .....	4-11	FM-AM radio with compact disc (CD) player (Type B) .....	4-44
How to turn on and off predictive course lines (if equipped) .....	4-12	FM-AM radio with compact disc (CD) player (Type C) .....	4-51
How to turn on and off guide lines (if equipped) .....	4-12	FM-AM radio with compact disc (CD) player (Type D) .....	4-57
Operating tips .....	4-12	FM-AM radio with compact disc (CD) player (Type E) .....	4-63
Around View Monitor (if equipped) .....	4-13	FM-AM radio with compact disc (CD) player (Type F) .....	4-69
Available views .....	4-14	NissanConnect App smartphone integration (if equipped) .....	4-73
Difference between predictive and actual distances .....	4-17	USB (Universal Serial Bus) connection port .....	4-74
How to switch the display .....	4-18	AUX (auxiliary) input jack .....	4-75
Camera aiding parking sensor (sonar) function (if equipped) .....	4-18	CD/USB memory care and cleaning .....	4-75
How to adjust the screen (if equipped) .....	4-19	Audio control steering switch (if equipped) .....	4-75
Operating tips .....	4-20		

Antenna .....	4-76	Bluetooth® Hands-Free Phone System (Type C) .....	4-87
Roof antenna .....	4-76	Regulatory information .....	4-88
Pillar antenna .....	4-76	Control buttons and microphone .....	4-88
Car phone and CB radio .....	4-77	Pairing procedure .....	4-88
Bluetooth® Hands-Free Phone System (Type A) .....	4-77	Phonebook .....	4-88
Regulatory information .....	4-78	Making a call .....	4-88
Control buttons and microphone .....	4-78	Receiving a call .....	4-89
Bluetooth® settings .....	4-78	During a call .....	4-89
Using the system .....	4-80	Ending a call .....	4-89
General settings .....	4-82	Bluetooth® settings .....	4-89
Bluetooth® Hands-Free Phone System (Type B) .....	4-83	Telephone setup .....	4-89
Regulatory information .....	4-84		
Using the system .....	4-84		
Bluetooth® settings .....	4-86		

## NISSANCONNECT OWNER'S MANUAL (if equipped)

For models with NissanConnect System, refer to the NissanConnect Owner's Manual that includes the following information.

Available functions may vary depending on the models and specifications.

- Audio
- Hands-free phone
- Apple CarPlay
- Android Auto
- Navigation
- Voice recognition
- Information and settings viewable on NissanConnect

## SAFETY PRECAUTIONS



### WARNING:

- **Do not adjust the heater and air conditioner controls or audio controls while driving so that full attention may be given to vehicle operation.**
- **If you noticed any foreign objects entering the system hardware, spilled liquid on the system, or noticed smoke or fumes coming out from the system, or any other unusual operation is observed, stop using the system immediately and contact the nearest NISSAN dealer. Ignoring such conditions may lead to an accident, fire or electric shock.**
- **Do not disassemble or modify this system. If you do, it may lead to an accident, fire, or electric shock.**



### CAUTION:

**Do not use the system when the engine is not running for extended periods of time to prevent battery discharge.**

## CENTER MULTI-FUNCTION CONTROL PANEL (for type F audio)

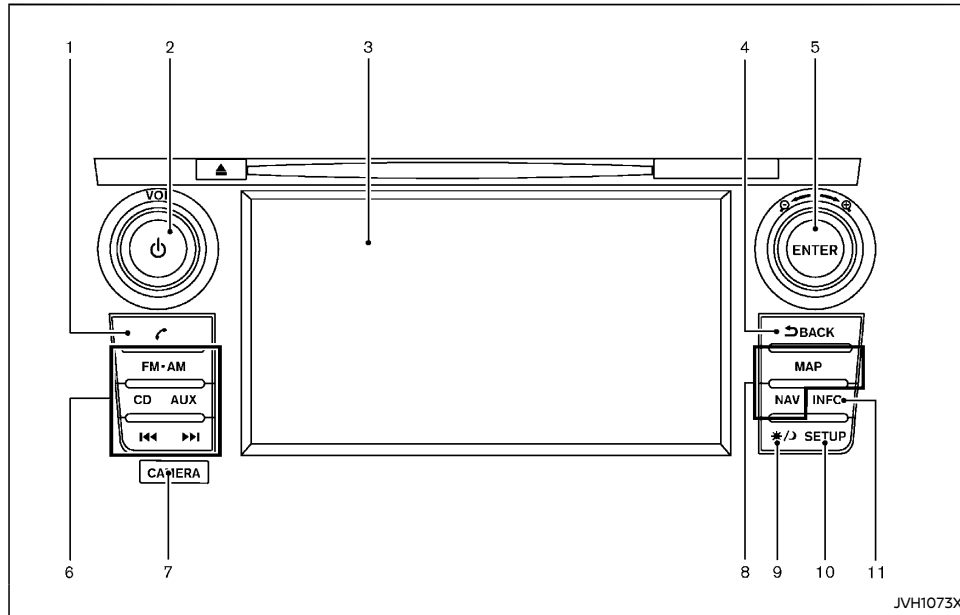

1. Phone button (P.4-87)
2. Power/VOL (volume) dial (P. 4-69)
3. Display screen (P.4-4)
4. BACK button (P.4-5)
5. ENTER/Scroll dial (P.4-5)
6. Audio control buttons (P.4-69)
7. CAMERA button (P.4-7, P.4-13)
8. For navigation system control buttons refer to the separate Navigation System Owner's Manual.
9. Brightness control/display on-off button (P. 4-5)
10. SETUP button (P.4-6)
11. INFO button (P.4-5)

## HOW TO USE TOUCH SCREEN DISPLAY



### WARNING:

- The glass display screen may break if it is hit with a hard or sharp object. If the glass screen breaks, do not touch it. Doing so could result in an injury.
- To clean the display, never use a rough cloth, alcohol, benzene, thinner or any kind of solvent or paper towel with a chemical cleaning agent. They will scratch or deteriorate the panel.
- Do not splash any liquid such as water or car fragrance on the display. Contact with liquid will cause the system to malfunction.

To help ensure safe driving, some functions cannot be operated while driving.

The on-screen functions that are not available while driving will be "grayed out" or muted.

Park the vehicle in a safe location and then operate the navigation system.



### CAUTION:

- **ALWAYS** give your full attention to driving.
- **Avoid using vehicle features that could distract you. If distracted, you could lose control of your vehicle and cause an accident.**

## Touch screen operation

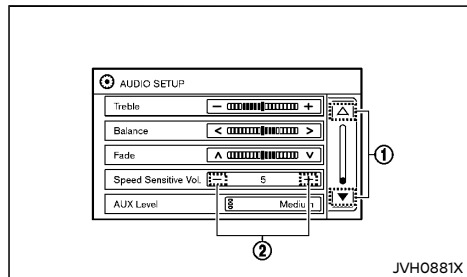

### Selecting items:

Touch an item to select. For example, to select the "Treble" key, touch the "Treble" key on the screen. Touch up/down arrow ① on the screen to display the previous or the next page.

### Adjusting items:

Touch the "+" or "-" ② key to adjust the settings of an item.

### Entering characters:

Touch the letter or number key on the keyboard screen. Options below are available when inputting characters.

- **123/ABC:**  
Changes the keyboard between numbers and alphabets.
- **Space:**  
Inserts a space.
- **Delete:**  
Deletes the last entered character with one touch. Touch and hold the "Delete" key to delete all of the characters.

- **OK:**  
Completes the character input.

### Touch screen maintenance

To clean the display screen, use a dry, soft cloth. If additional cleaning is necessary, use a small amount of neutral detergent with a soft cloth. Never spray the screen with water or detergent. Dampen the cloth first and then wipe the screen.

### HOW TO USE BRIGHTNESS CONTROL/ DISPLAY ON-OFF BUTTON

Push the brightness control/display on-off "☀/🌙" button to change the display brightness between day mode and night mode. While the mode is being displayed, the brightness can be adjusted using the scroll dial.

Push and hold the brightness control/display on-off "☀/🌙" button to turn the display off. Push the button again to turn the display on.

### HOW TO USE ENTER/SCROLL DIAL

Turn the ENTER/Scroll dial to select items on the screen and to adjust the levels of setting items. Push the dial to confirm the selected item or setting.

### HOW TO USE BACK BUTTON

Push the BACK button to return to the previous screen.

## VEHICLE INFORMATION AND SETTINGS (for type F audio)

Vehicle information can be checked and various settings can be adjusted on the display.

### HOW TO USE INFO BUTTON

Designs and items displayed on the screen may vary depending on the models and specifications.

Push the INFO button to display the following information on the display screen.

#### Available items:

- My Apps
- Traffic Messages
- Eco Score

### My Apps

Some application services can be used with this system when linked to your smartphone. For details, see "NissanConnect App smartphone integration" (P.4-73).

### Traffic Messages (if equipped)

Traffic Messages can be displayed on the display screen when available. Refer to the separate Navigation System Owner's Manual for details.

### Eco Score (if equipped)

The Eco Score feature analyzes driving behavior and provides an overall score. Refer to the separate Navigation System Owner's Manual for details.

## HOW TO USE SETUP BUTTON

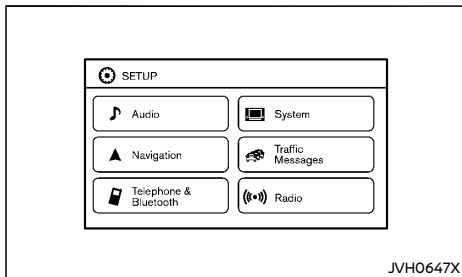

### Example

Designs and items displayed on the screen may vary depending on the models and specifications.

Push the SETUP button to view and adjust the following setting items.

#### Available items:

- Audio
- Navigation
- Telephone & Bluetooth
- System
  - Display
  - Clock
  - Language
  - Camera Settings
  - Temperature Unit
  - Touch Click
  - Beep Tones
  - Factory Settings
  - Software Licenses
- Traffic Messages
- Radio

## Audio settings

Audio settings can be adjusted from the audio setup screen.

This item is available only when the audio system is turned on.

1. Push the SETUP button.
2. Select the "Audio" key.
3. Select the item you wish to adjust.

#### Bass/Treble/Balance/Fade:

Touch the adjustment bar next to the corresponding keys on the display to adjust the tone quality and speaker balance.

The levels of these features can also be adjusted with the ENTER/Scroll dial. See "FM-AM radio with compact disc (CD) player (Type F)" (P.4-69) for audio operations.

#### Speed Sensitive Vol.:

Speed sensitive volume function increases the volume of the audio system as the speed of the vehicle increases. Choose the desired effect level from 0 (OFF) to 5. The higher the setting, the more the volume increases in relation to vehicle speed.

#### AUX Level:

This feature controls the volume level of incoming sound when an auxiliary device is connected to the system. Select the level from "Low (Quiet)", "Medium", and "High (Loud)".

## Navigation settings

Navigation settings can be changed. See Navigation System Owner's Manual for details.

## Telephone & Bluetooth settings

Telephone & Bluetooth settings can be changed. See "Bluetooth® Hands-Free Phone System (Type C)" (P.4-87) for details.

## System settings

Various system settings can be adjusted from the system settings.

1. Push the SETUP button.
2. Select the "System" key.
3. Select the item you wish to adjust.

#### Display:

Select the corresponding keys to adjust the settings.

- **Brightness:**  
Adjusts the brightness of the display.
- **Display Mode:**  
Adjusts to fit the level of lighting in the vehicle. Touch the "Display Mode" key to cycle through options of the mode (Day, Night and Auto).
- **Scroll Direction:**  
Adjusts the direction of the menu scroll. Choose either the up arrow or the down arrow.

#### Clock:

Select the corresponding keys to adjust the settings.

- **Time Format:**  
The time setting can be selected from 12 hour and 24 hour formats.

## REAR VIEW MONITOR (if equipped)

- **Date Format:**

The day, month and year display can be selected from five formats.

- **Clock Mode:**

Select the clock mode from Manual, Time Zone and Auto.

When "Manual" is selected, you can set the clock mode manually from the "Set Clock Manually" screen.

Select "Auto" to automatically maintain the time using GPS.

- **Set Clock Manually:**

Mode (AM/PM) (if equipped), Hours, Minutes, Day, Month and Year can be set manually if "Manual" is selected in the Clock Mode setting.

- **Daylight Savings Time:**

Turns the daylight savings time on or off.

- **Time Zone:**

Select the applicable time zone from the list.

**Language:**

Select a language to be displayed on the screen.

**Camera Settings:**

See "How to adjust the screen" (P.4-11) or "How to adjust the screen" (P.4-19) for details.

**Temperature Unit:**

Select the temperature unit from °C and °F.

**Touch Click:**

Turns the touchscreen click feature on or off. When turned on, a click sound will be heard every time a key on the screen is touched.

**Beep Tones:**

Turns the beep tones feature on or off. When turned on, a beep sound will be heard as a pop-up message appears on the screen.

**Factory Settings:**

Select this key to return all settings to default.

**Software Licenses (if equipped):**

Select this key to view software license information.

**Traffic Messages settings**

Traffic information guidance, announcement and warning settings can be adjusted.

Traffic Announcement (TA) information can be received only in the area where the service is available.

**Radio settings**

Traffic Announcement (TA) related settings can be turned on or off. When this item is turned on, the received traffic announcement information will be tuned to automatically when received.

Traffic Announcement (TA) information can be received only in the area where the service is available.

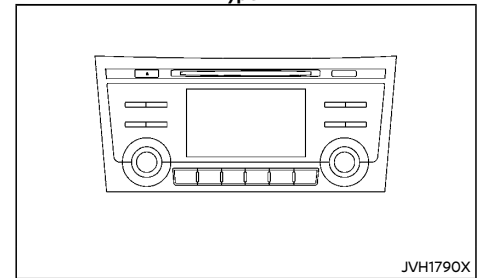
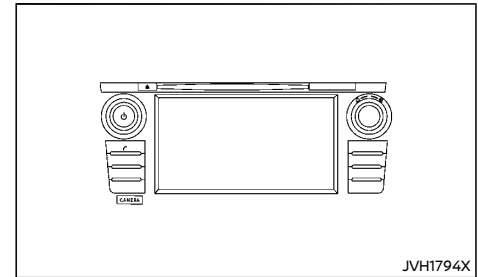

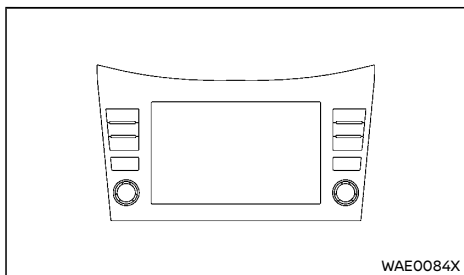

Type C

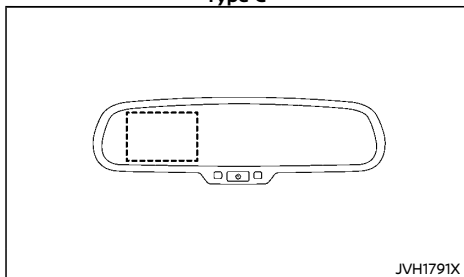

Type D

When the shift lever is shifted into the "R" (Reverse) position, the monitor display shows the view to the rear of the vehicle.

The system is designed as an aid to the driver in detecting large stationary objects to help avoid damaging the vehicle. The system will not detect small objects below the bumper and may not detect objects close to the bumper or on the ground.

**⚠ WARNING:**

Failure to follow the warnings and instructions for proper use of the rear view monitor could result in serious injury or death.

- The rear view monitor is a convenience but it is not a substitute for proper backing. Always turn and look out the windows, and check mirrors to be sure that it is safe to move before operating the vehicle. Always back up slowly.
- The system is designed as an aid to the driver in showing large stationary objects directly behind the vehicle, to help avoid damaging the vehicle.
- The system cannot completely eliminate blind spots and may not show every object.
- Underneath the bumper and the corner areas of the bumper cannot be viewed on the rear view monitor because of its monitoring range limitation. The system will not show small objects below the bumper, and may not show objects close to the bumper or on the ground.
- Objects viewed in the rear view monitor differ from actual distance because a wide-angle lens is used.
- Objects in the rear view monitor will appear visually opposite compared to when viewed in the rear view and outside mirrors.
- Make sure that the tailgate is securely closed when backing up.
- Do not put anything on the rear view camera. The rear view camera is installed on top of the tailgate.

- When washing the vehicle with high pressure water, be sure not to spray it around the camera. Otherwise, water may enter the camera unit causing water condensation on the lens, a malfunction, fire or an electric shock.
- Do not strike the camera. It is a precision instrument. Otherwise, it may malfunction or cause damage resulting in a fire or an electric shock.

**⚠ CAUTION:**

Do not scratch the camera lens when cleaning dirt or snow from the lens.

HOW TO READ THE DISPLAYED LINES

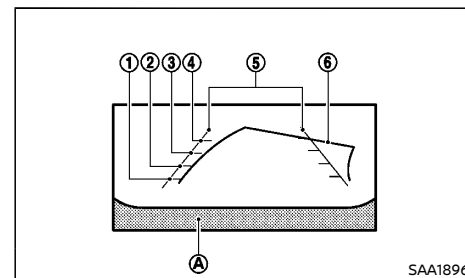

Guiding lines which indicate the vehicle width and distances to objects with reference to the bumper line (A) are displayed on the monitor.

**Distance guide lines:**

Indicate distances from the vehicle body.

- Red line ①: approx. 0.5 m (1.5 ft)
- Yellow line ②: approx. 1 m (3 ft)



- Green line ③: approx. 2 m (7 ft)
- Green line ④: approx. 3 m (10 ft)

**Vehicle width guide lines ⑤:**

Indicate the vehicle width when backing up.

**Predictive course lines ⑥ (if equipped):**

Indicate the predictive course when backing up. The predictive course lines will be displayed on the monitor when the shift lever is in the "R" (Reverse) position and the steering wheel is turned. The predictive course lines will move depending on how much the steering wheel is turned and will not be displayed while the steering wheel is in the neutral position.

The vehicle width guide lines and the width of the predictive course lines are wider than the actual width and course.

**DIFFERENCE BETWEEN PREDICTIVE AND ACTUAL DISTANCES**

The distance guide line and the vehicle width guide line should be used as a reference only when the vehicle is on a level, paved surface. The distance viewed on the monitor is for reference only and may be different than the actual distance between the vehicle and displayed objects.

**Backing up on a steep uphill**

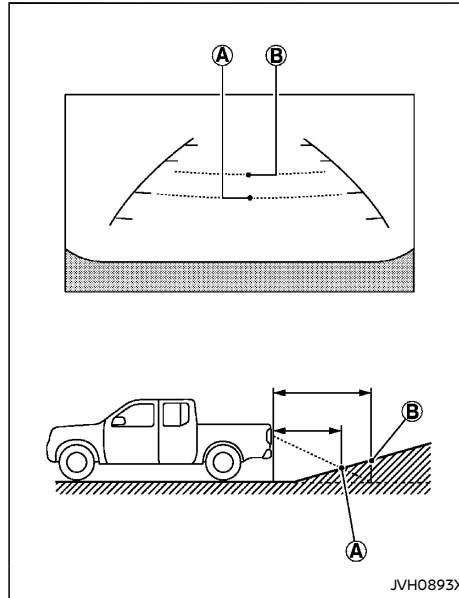

When backing up the vehicle up a hill, the distance guide lines and the vehicle width guide lines are shown closer than the actual distance. For example, the display shows 1 m (3 ft) to the place ①, but the actual 1 m (3 ft) distance on the hill is the place ②. Note that any object on the hill is viewed in the monitor further than it appears.

**Backing up on a steep downhill**

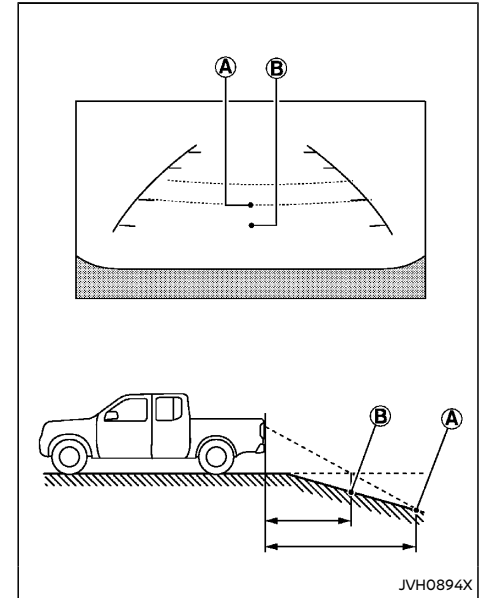

When backing up the vehicle down a hill, the distance guide lines and the vehicle width guide lines are shown further than the actual distance. For example, the display shows 1 m (3 ft) to the place ①, but the actual 1 m (3 ft) distance on the hill is the place ②. Note that any object on the hill is viewed in the monitor closer than it appears.

### Backing up near a projecting object

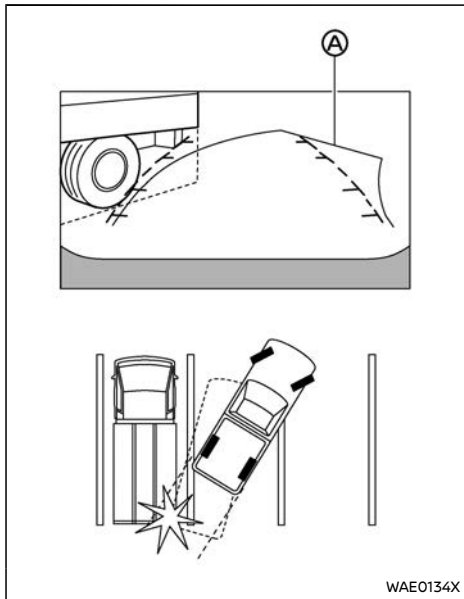

The predictive course lines (A) (if equipped) do not touch the object in the display. However, the vehicle may hit the object if it projects over the actual backing up course.

### Backing up behind a projecting object

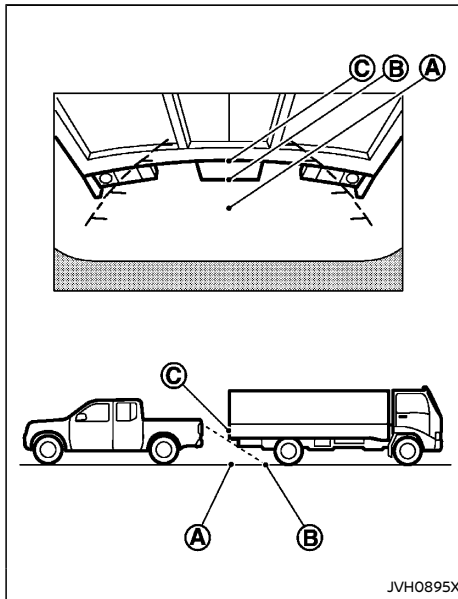

The position (C) is shown further than the position (B) in the display. However, the position (C) is actually at the same distance as the position (A). The vehicle may hit the object when backing up to the position (A) if the object projects over the actual backing up course.

### HOW TO PARK WITH PREDICTIVE COURSE LINES (if equipped)

#### **⚠ WARNING:**

- If the tires are replaced with different sized tires, the predictive course lines may not be displayed correctly.
- On a snow-covered or slippery road, there may be a difference between the predictive course lines and the actual course line.
- If the battery is disconnected or becomes discharged, the predictive course lines may not be displayed correctly. If this occurs, perform the following procedures.
  - Turn the steering wheel from lock to lock while the engine is running.
  - Drive the vehicle on a straight road for more than 5 minutes.

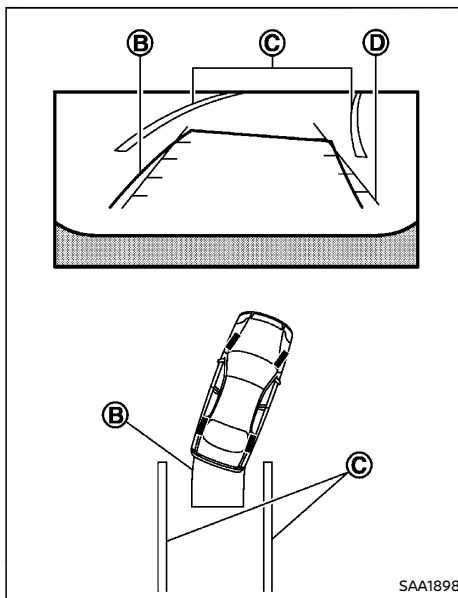
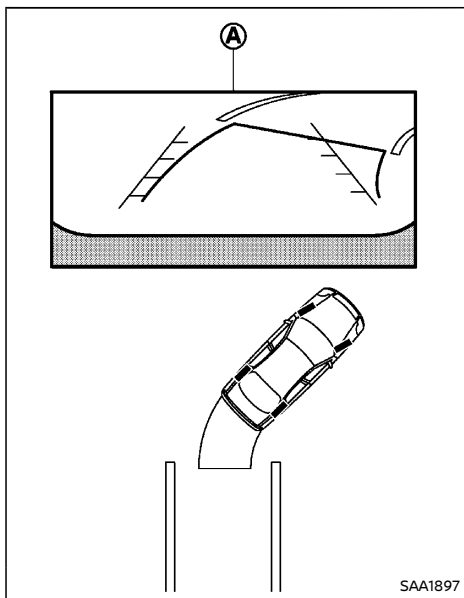

## HOW TO ADJUST THE SCREEN (if equipped)

### NOTE:

**Do not adjust the screen while the vehicle is moving.**

### Adjusting screen (Type A)

1. Push the SETUP button.
2. Select the "System" key.
3. Select the "Camera Settings" key.
4. Select the item you wish to adjust.

- **Display Mode:**

Adjusts to fit the level of lighting in the vehicle. Touch the "Display Mode" key to cycle through options of the mode (Day, Night and Auto).

- **Brightness:**

Adjusts the brightness of the display.

- **Contrast:**

Adjusts the level of contrast.

- **Color:**

Adjusts the level of the color.

### Adjusting screen (Type B)

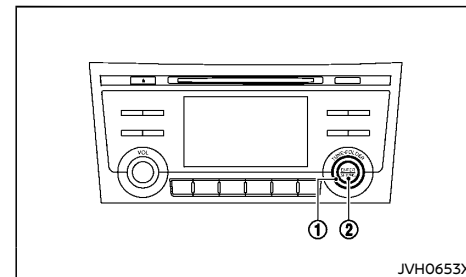

1. Visually check that the parking space is safe before parking your vehicle.
2. The rear view of the vehicle is displayed on the screen (A) as illustrated when the shift lever is moved to the "R" (Reverse) position.

3. Slowly back up the vehicle adjusting the steering wheel so that the predictive course lines (B) enter the parking space (C).
4. Maneuver the steering wheel to make the vehicle width guide lines (D) parallel to the parking space (C) while referring to the predictive course lines (B).
5. When the vehicle is parked in the space completely, move the shift lever to the "P" (Park) position (AT model) or the "N" (Neutral) position (MT model) and apply the parking brake.

1. Push the ENTER/SETTING button ②.
2. Turn the TUNE-FOLDER dial ① to highlight the "Brightness" or the "Contrast" key.
3. Push the ENTER/SETTING button ②.
4. Adjust the level using the TUNE-FOLDER dial ① and then push the ENTER/SETTING button ② to apply the adjustment.

### Adjusting screen (Type C)

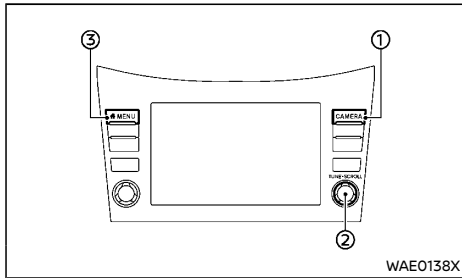

1. Push the CAMERA button ①.
2. Touch the "Display Settings" key.
3. Select the setting items you wish to adjust by touching or by turning and pushing the TUNE-SCROLL dial ②.

#### Available setting items:

- Brightness
- Contrast
- Tint
- Colour/Color
- Black Level

The "Display Settings" key can also be shown by pushing the MENU button ③, touching the "Settings" key and then touching the "Camera" key.

### HOW TO TURN ON AND OFF PREDICTIVE COURSE LINES (if equipped)

1. Push the CAMERA button.
2. Touch the "Predictive Course Lines" key to turn on and off the predictive course lines.

The "Predictive Course Lines" key can also be shown by pushing the MENU button, touching the "Settings" key and then touching the "Camera" key.

### HOW TO TURN ON AND OFF GUIDE LINES (if equipped)

When the rear view monitor is displayed, you can switch the vehicle width guide lines and distance guide lines on/off by pushing the CAMERA button.

### OPERATING TIPS

- When the shift lever is shifted to the "R" (Reverse) position, the monitor screen automatically changes to the rear view monitor mode. However, the radio can be heard.
- It may take some time until the rear view monitor or the normal screen is displayed after the shift lever has been shifted to "R" (Reverse) from another position or to another position from "R" (Reverse). Objects may be distorted momentarily until the rear view monitor screen is displayed completely.
- When the temperature is extremely high or low, the screen may not clearly display objects. This is not a malfunction.
- When strong light directly enters the camera, objects may not be displayed clearly. This is not a malfunction.

- Vertical lines may be seen in objects on the screen. This is due to strong reflected light from the bumper. This is not a malfunction.
- The screen may flicker under fluorescent light. This is not a malfunction.
- The colors of objects on the rear view monitor may differ somewhat from those of the actual object.
- Objects on the monitor may not be clear in a dark place or at night. This is not a malfunction.
- If dirt, rain or snow attaches to the camera, the rear view monitor may not clearly display objects. Clean the camera.
- Do not use alcohol, benzine or thinner to clean the camera. This will cause discoloration. To clean the camera, wipe with a cloth dampened with diluted mild cleaning agent and then wipe with a dry cloth.
- Do not damage the camera as the monitor screen may be adversely affected.
- Do not use wax on the camera window. Wipe off any wax with a clean cloth dampened with mild detergent diluted with water.

## AROUND VIEW MONITOR (if equipped)

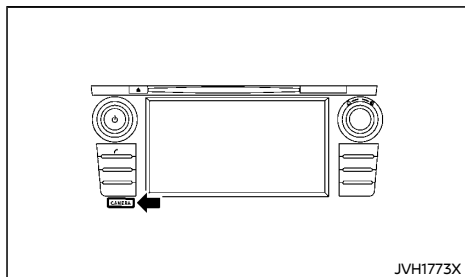

Type A

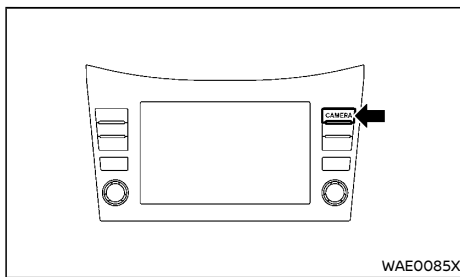

Type C

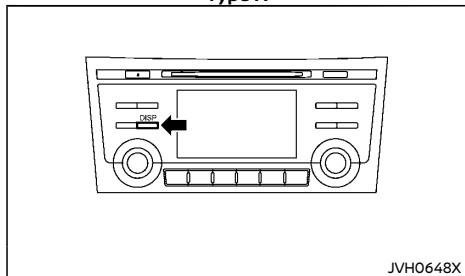

Type B

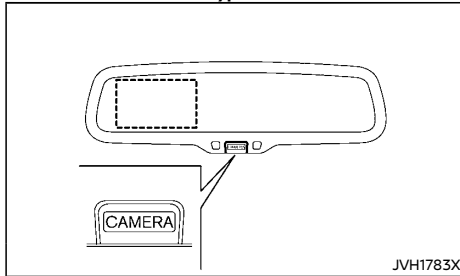

Type D

With the ignition switch in the "ON" position, push the CAMERA button (if equipped)/DISP button (if equipped) or move the shift lever to the "R" (Reverse) position to operate the Around View Monitor. The monitor displays various views of the position of the vehicle.

### Available views:

- Bird's-eye View  
The surrounding view of the vehicle.
- Front-side View  
The view around and ahead of the front passenger's side wheel.

- Front View  
The view to the front of the vehicle.
- Rear View  
The view to the rear of the vehicle.

The system is designed as an aid to the driver in situations such as slot parking or parallel parking.



### WARNING:

For Australia and New Zealand:

- The front camera view may be obscured when fitting equipment to the front of the vehicle such as bullbar, nudge bar or additional lamps.
- The driver is always responsible for safety during parking and other manoeuvres.

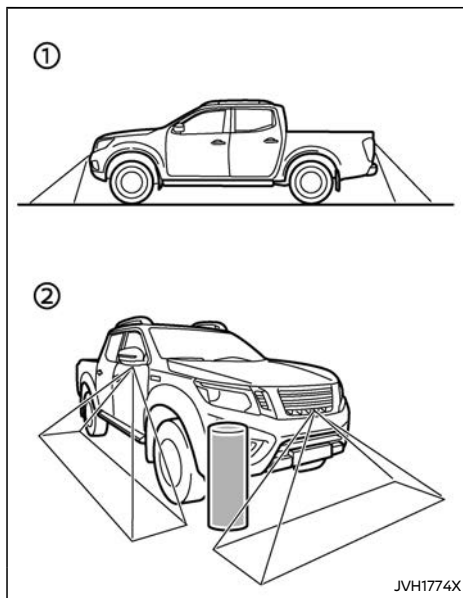

There are some areas where the system will not display objects. When in the front or the rear view display, an object below the bumper or on the ground may not be displayed ①. When in the bird's-eye view, a tall object near the seam of the camera detecting areas will not appear in the monitor ②.

**WARNING:**

- The Around View Monitor is a convenient feature but it is not a substitute for proper vehicle operation because it has areas where objects cannot be viewed.

Always look out the windows and check mirrors to be sure that it is safe to move.

- The driver is always responsible for safety during parking and other maneuvers.
- Do not use the Around View Monitor with the outside mirror in the stored position, and make sure that the tailgate is securely closed when operating the vehicle using the Around View Monitor.
- The distance between objects viewed on the Around View Monitor differs from the actual distance.
- The cameras are installed above the front grille, the outside mirrors and on top of the tailgate. Do not put anything on the cameras.
- When washing the vehicle with high-pressure water, be sure not to spray it around the cameras. Otherwise, water may enter the camera unit causing water condensation on the lens, a malfunction, fire or an electric shock.
- Do not strike the cameras. They are precision instruments. Doing so could cause a malfunction or cause damage resulting in a fire or an electric shock.

**CAUTION:**

Clean the camera lens with soft cloth to keep it free from dirt, snow, etc. Do not scratch the lens when cleaning.

AVAILABLE VIEWS

**WARNING:**

- The distance guide line and the vehicle width line should be used as a reference only when the vehicle is on a paved, level surface. The distance viewed on the monitor is for reference only and may be different than the actual distance between the vehicle and displayed objects.
- Use the displayed lines and the bird's-eye view as a reference. The lines and the bird's-eye view are greatly affected by the number of occupants, fuel level, vehicle position, road condition and road grade.
- If the tires are replaced with different sized tires, the predictive course line and the bird's-eye view may be displayed incorrectly.
- When driving the vehicle up a hill, objects viewed in the monitor are further than they appear. When driving the vehicle down a hill, objects viewed in the monitor are closer than they appear.
- Use the mirrors or actually look to properly judge distances to other objects.
- The vehicle width and predictive course lines are wider than the actual width and course.

## Front and rear view

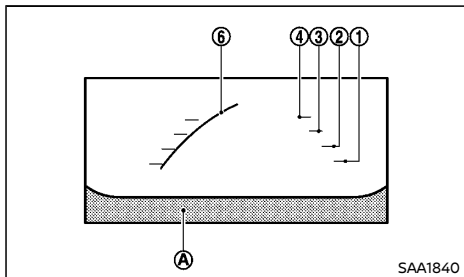

Front view

SAA1840

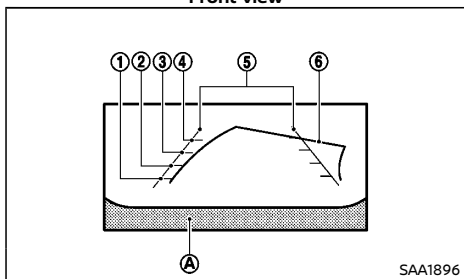

Rear view

SAA1896

Guiding lines, which indicate the vehicle width and distances to objects with reference to the vehicle body line **A**, are displayed on the monitor.

### Distance guide lines:

Indicate distances from the vehicle body.

- Red line ① : approx. 0.5 m (1.5 ft)
- Yellow line ② : approx. 1 m (3 ft)
- Green line ③ : approx. 2 m (7 ft)

- Green line ④ : approx. 3 m (10 ft)

### Vehicle width guide lines ⑤ :

Indicate the approximate vehicle width.

### Predictive course lines ⑥ :

Indicate the predictive course when operating the vehicle. The predictive course lines will be displayed on the monitor when the steering wheel is turned. The predictive course lines will move depending on how much the steering wheel is turned. When the rear view is displayed, predictive course lines will not be displayed while the steering wheel is in the neutral position.

The front view will not be displayed when the vehicle speed is above 10 km/h (6 MPH).



### WARNING:

- **The distance between objects viewed in the rear view may differ from the actual distance. Objects in the rear view will appear visually opposite in the same way for those viewed in the inside and outside mirrors.**
- **On a snow-covered or slippery road, there may be a difference between the predictive course line and the actual course line.**
- **The displayed lines on the rear view will appear slightly off to the right because the rear view camera is not installed in the rear center of the vehicle.**

### NOTE:

**When the monitor displays the front view and the steering wheel turns about 90 degrees or less from the neutral position, both the right and left predictive course lines ⑥ are displayed. When the steering wheel turns about**

**90 degrees or more, a predictive course line is displayed only on the opposite side of the turn.**

### Bird's-eye view (Type A)

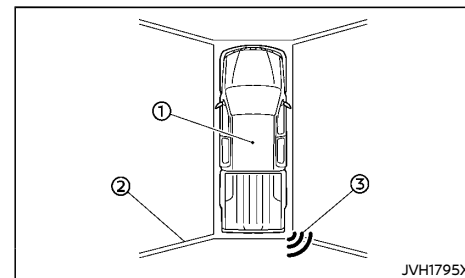

JVH1795X

The bird's-eye view shows the overhead view of the vehicle which helps confirm the vehicle position and the predicted course to a parking space.

The vehicle icon ① shows the position of the vehicle. Note that the distance between objects viewed in the bird's-eye view differs from the actual distance.

The areas that the cameras cannot cover ② are indicated in black.

After the ignition switch is placed in the "ON" position, the nonviewable area ② is highlighted in yellow for 3 seconds after the bird's-eye view is displayed.

When the vehicle moves closer to an object, the parking sensor (sonar) indicators ③ (if equipped) appear. See "Camera aiding parking sensor (sonar) function" (P.4-18) for more information.

**WARNING:**

- **Objects in the bird's-eye view will appear further than the actual distance because the bird's-eye view is a pseudo view that is processed by combining the views from the cameras on the outside mirrors, the front and the rear of the vehicle.**
- **Tall objects, such as a curb or vehicle, may be misaligned or not displayed at the seam of the views.**
- **Objects that are above the camera cannot be displayed.**
- **The view for the bird's-eye view may be misaligned when the camera position alters.**
- **A line on the ground may be misaligned and is not seen as being straight at the seam of the views. The misalignment will increase as the line proceeds away from the vehicle.**

Bird's-eye view (Type B)

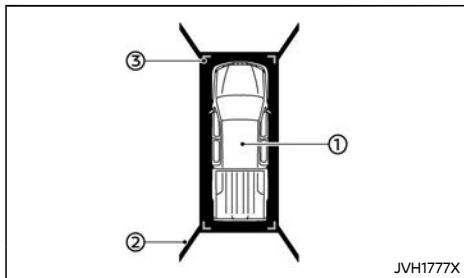

The bird's-eye view shows the overhead view of the vehicle which helps confirm the vehicle position and the predictive course to a parking

space.

The vehicle icon ① shows the position of the vehicle. Note that the distance between objects viewed in the bird's-eye view differs from the actual distance.

The areas that the cameras cannot cover ② are indicated in black.

After the ignition switch is placed in the "ON" position, the non-viewable area ② is highlighted in yellow for 3 seconds after the bird's-eye view is displayed.

In addition, the non-viewable corners ③ are displayed in red to remind the driver to be cautious.

After the ignition switch is placed in the "ON" position, the non-viewable corners ③ will blink for 3 seconds after the bird's-eye view is displayed.

**WARNING:**

- **Objects in the bird's-eye view will appear further than the actual distance because the bird's-eye view is a pseudo view that is processed by combining the views from the cameras on the outside mirrors, the front and the rear of the vehicle.**
- **Tall objects, such as a curb or vehicle, may be misaligned or not displayed at the seam of the views.**
- **Objects that are above the camera cannot be displayed.**
- **The view for the bird's-eye view may be misaligned when the camera position alters.**
- **A line on the ground may be misaligned and is not seen as being straight at the seam of the views. The misalignment will increase as the line proceeds away from**

the vehicle.

Front-side view

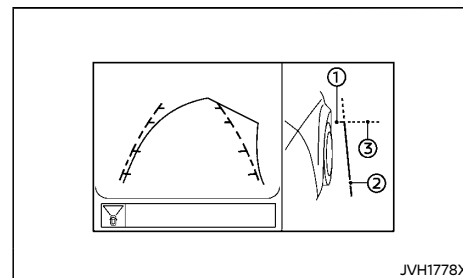

**Guiding lines:**

Guiding lines that indicate the width and the front end of the vehicle are displayed on the monitor.

The front-of-vehicle line ① shows the front part of the vehicle.

The side-of-vehicle line ② shows the vehicle width including the outside mirrors.

The extensions ③ of both the front ① and side ② lines are shown with a green dotted line.

**CAUTION:**

- **Do not scratch the camera lens when cleaning dirt or snow.**
- **The turn signal light may overlap with the side-of-vehicle line. This is not a malfunction.**



## DIFFERENCE BETWEEN PREDICTIVE AND ACTUAL DISTANCES

### Backing up on a steep uphill

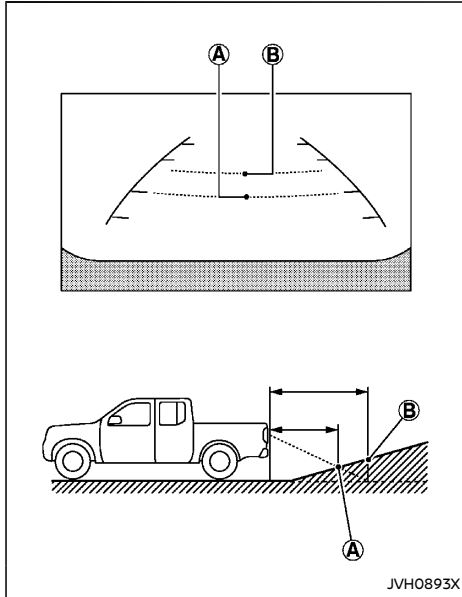

When backing up the vehicle up a hill, the distance guide lines and the vehicle width guide lines are shown closer than the actual distance. For example, the display shows 1 m (3 ft) to the place A, but the actual 1 m (3 ft) distance on the hill is the place B. Note that any object on the hill is viewed in the monitor further than it appears.

### Backing up on a steep downhill

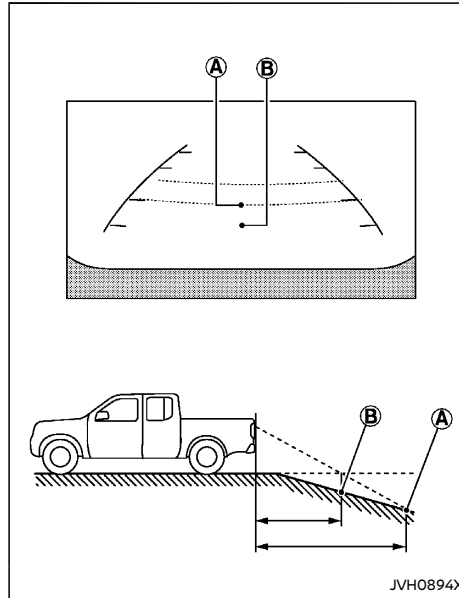

When backing up the vehicle down a hill, the distance guide lines and the vehicle width guide lines are shown further than the actual distance. For example, the display shows 1 m (3 ft) to the place A, but the actual 1 m (3 ft) distance on the hill is the place B. Note that any object on the hill is viewed in the monitor closer than it appears.

### Backing up near a projecting object

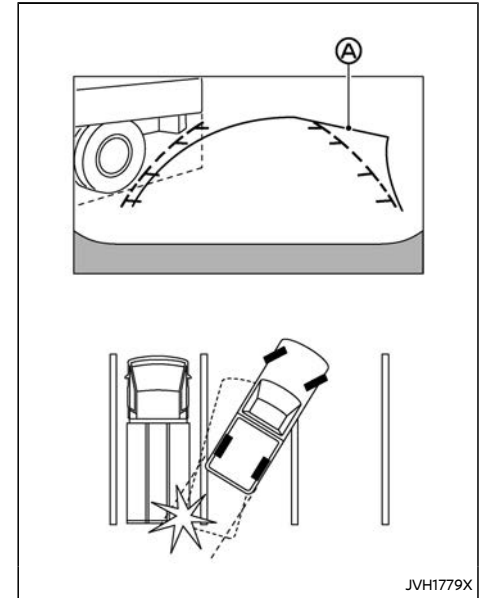

The predictive course lines A do not touch the object on the display. However, the vehicle may hit the object if it projects over the actual moving course.

## Backing up behind a projecting object

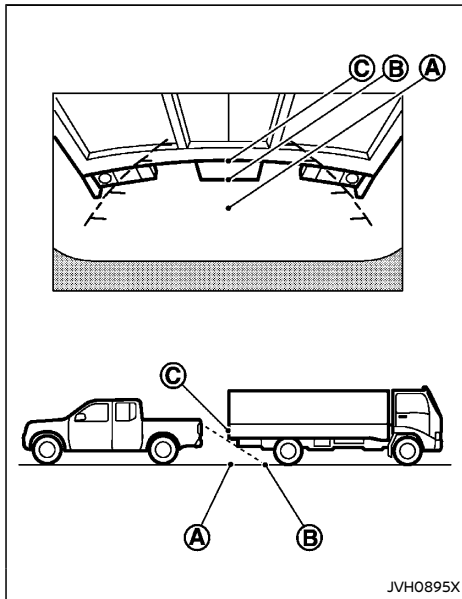

The position © is shown further than the position ⓑ in the display. However, the position © is actually at the same distance as the position Ⓐ. The vehicle may hit the object when backing up to the position Ⓐ if the object projects over the actual moving course.

## HOW TO SWITCH THE DISPLAY

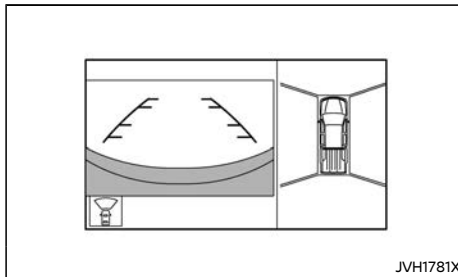

With the ignition switch in the "ON" position, push the CAMERA/DISP button or move the shift lever to the "R" (Reverse) position to operate the Around View Monitor.

The Around View Monitor can display two split views.

If the shift lever is not in the "R" (Reverse) position, the available views are:

- Front view/bird's-eye view split screen
- Front view/front-side view split screen

If the shift lever is in the "R" (Reverse) position, the available views are:

- Rear view/bird's-eye view split screen
- Rear view/front-side view split screen
- Rear view

The display will switch back to the previously displayed screen from the Around View Monitor screen when:

- The shift lever is in the "D" (Drive) position (AT model) or the shift lever is out of the "R" (Reverse) position (MT model), and the vehicle speed increases above approximately 10 km/h (6 MPH).

- A different screen is selected (when the shift lever is not in the "R" (Reverse) position).

## CAMERA AIDING PARKING SENSOR (sonar) FUNCTION (if equipped)

When the vehicle moves closer to the object while the Around View Monitor is displayed, an indicator is displayed and a tone is sounded by the parking sensor (sonar) function to warn the driver.

The color of the parking sensor (sonar) indicator and the pattern of the tone vary according to the distance to the object.

Keep the parking sensor (sonar) (located on the rear bumper fascia) free from snow, ice and large accumulations of dirt. Do not clean the sensors (sonar) with sharp objects. If the sensors (sonar) are covered, the accuracy of the parking sensor (sonar) function will be diminished.

The tone sound and the sensor (sonar) indicator display can be turned on/off, and the volume of the tone sound and the sensor (sonar) detection range can be adjusted. (See "Trip computer" (P.2-25).)



### WARNING:

- **The parking sensor (sonar) function is not designed to prevent the object.**
- **The colors of the parking sensor (sonar) indicator and the distance guide lines in the front/rear view indicate different distances to the object.**
- **Inclement weather may affect the function of the parking sensor (sonar) system; this may include reduced performance or a false activation.**

- This function is designed as an aid to the driver in detecting large stationary objects to help avoid damaging the vehicle. The system will not detect small objects below the bumper, and may not detect objects that are too close to the bumper or on the ground.
- If your vehicle sustains damage to the bumper fascia, leaving it misaligned or bent, the sensing zone may be altered causing inaccurate measurement of obstacles or false alarms.



**CAUTION:**

Keep the interior of the vehicle as quiet as possible to hear the tone clearly.

HOW TO ADJUST THE SCREEN (if equipped)

**NOTE:**

Do not adjust the screen while the vehicle is moving.

Adjusting screen (Type A)

Operation with buttons:

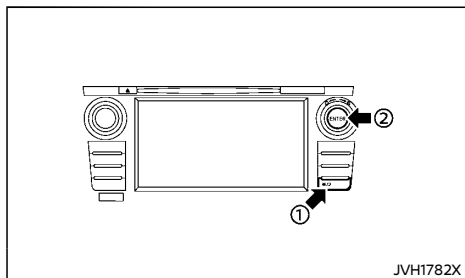

1. To adjust the screen brightness when the Around View Monitor is displayed, push the brightness control/display on-off "\*/" button ①.
2. Adjust brightness to the preferred setting using the ENTER/Scroll dial ②.

**Operation with touch screen:**

1. Push the SETUP button.
2. Select the "System" key.
3. Select the "Camera Settings" key.
4. Select the item you wish to adjust.

• **Display Mode:**

Adjusts to fit the level of lighting in the vehicle. Touch the "Display Mode" key to cycle through options of the mode (Day, Night and Auto).

• **Brightness:**

Adjusts the brightness of the display.

• **Contrast:**

Adjusts the level of contrast.

• **Color:**

Adjusts the level of the color.

Adjusting screen (Type B)

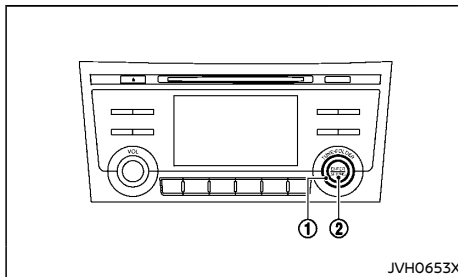

1. Push the ENTER/SETTING button ②.
2. Turn the TUNE-FOLDER dial ① to highlight the "Brightness" or the "Contrast" key.
3. Push the ENTER/SETTING button ②.
4. Adjust the level using the TUNE-FOLDER dial ① and then push the ENTER/SETTING button ② to apply the adjustment.

Adjusting screen (Type C)

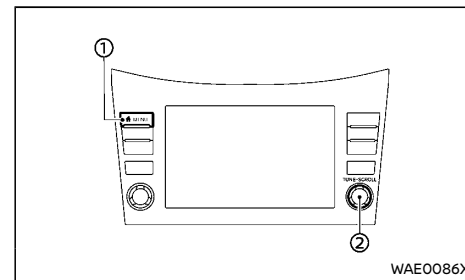

1. Push the MENU button ①.
2. Touch the "Settings" key.
3. Touch the "Camera" key.
4. Touch the "Display Settings" key.
5. Select the setting items you wish to adjust by touching or by turning and pushing the TUNE-SCROLL dial ②.

**Available setting items:**

- Brightness
- Contrast
- Tint
- Colour/Color
- Black Level

## OPERATING TIPS



### CAUTION:

- **Do not use alcohol, benzine or thinner to clean the camera. This will cause discoloration. To clean the camera, wipe with a cloth dampened with a diluted mild cleaning agent and then wipe with a dry cloth.**
- **Do not damage the camera as the monitor screen may be adversely affected.**
- The screen displayed on the Around View Monitor will automatically return to the previous screen when no operation takes place for 3 minutes after the CAMERA button or DISP button has been pushed while the shift lever is in a position other than the "R" (Reverse) position.
- The display of images on the screen may be delayed after screens are switched. Objects in the Around View Monitor may be distorted momentarily until the Around View Monitor screen is displayed completely.
- When the temperature is extremely high or low, the screen may not display objects clearly. This is not a malfunction.
- When strong light directly shines on the camera, objects may not be displayed clearly. This is not a malfunction.
- The screen may flicker under fluorescent light. This is not a malfunction.
- The colors of objects on the Around View Monitor may differ somewhat from those of the actual object.
- Objects on the monitor may not be clear and the color of the object may differ in a dark location or at night. This is not a malfunction.

- There may be differences in clearness between each camera view of the bird's-eye view.
- If dirt, rain or snow attaches to the camera, the Around View Monitor may not display objects clearly. Clean the camera.
- Do not use wax on the camera window. Wipe off any wax with a clean cloth that has been dampened with a mild detergent diluted with water.

## VENTILATORS

### CENTER VENTILATORS

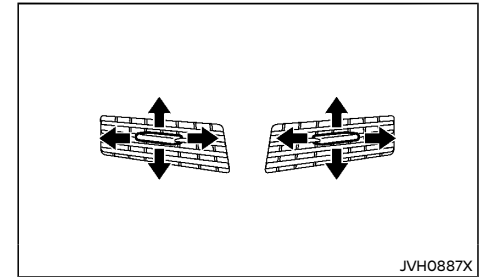

Adjust the air flow direction of the ventilators by moving the center knob (up/down, left/right) until the desired position is achieved.

### SIDE VENTILATORS

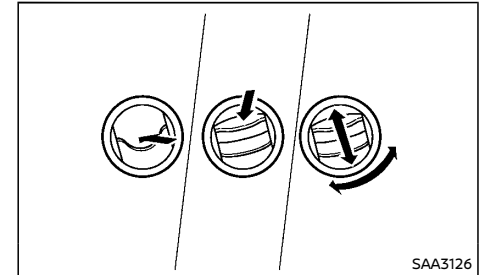

Adjust the air flow direction of the ventilators by opening, closing or rotating.

The side ventilators can be used for the side defogger.

## HEATER AND AIR CONDITIONER

### REAR VENTILATORS (if equipped)

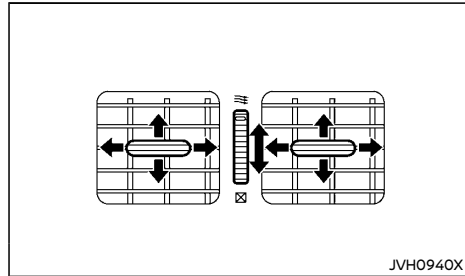

Type A

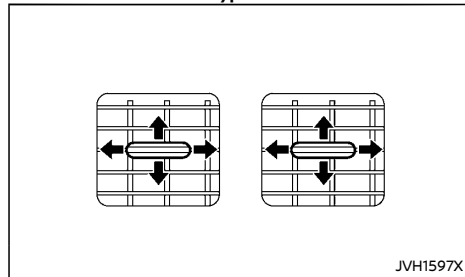

Type B

Adjust the air flow direction of the ventilators by moving the center knob (up/down, left/right) until the desired position is achieved.

#### For Type A:

Open/close the vents by moving the control to either direction.

☒ : This symbol indicates that the vents are closed. Moving the control to this direction will close the vents.

/// : This symbol indicates that the vents are open. Moving the control to this direction will open the vents.



#### WARNING:

- The heater and air conditioner operate only when the engine is running.
- Never leave children or adults who would normally require the support of others alone in the vehicle. Pets should not be left alone either. They could unknowingly activate switches or controls and inadvertently become involved in a serious accident and injure themselves. On hot, sunny days, temperatures in a closed vehicle could quickly become high enough to cause severe or possibly fatal injuries to people or animals.
- Do not use the recirculation mode for long periods as it may cause the interior air to become stale and the windows to fog up.
- Do not adjust the heating and air conditioning controls while driving so that full attention may be given to vehicle operation.

The heater and air conditioner operate when the engine is running. The air blower will operate even if the engine is turned off and the ignition switch is placed in the "ON" position.

#### NOTE:

- Odors from inside and outside the vehicle can build up in the air conditioner unit. Odor can enter the passenger compartment through the vents.
- When parking, set the heater and air conditioner controls to turn off air recirculation to allow fresh air into the passenger compartment. This should help reduce odors inside the vehicle.

## OPERATING TIPS (models with automatic air conditioner)

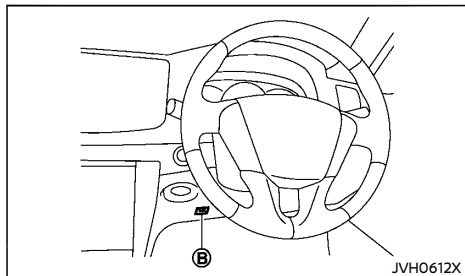
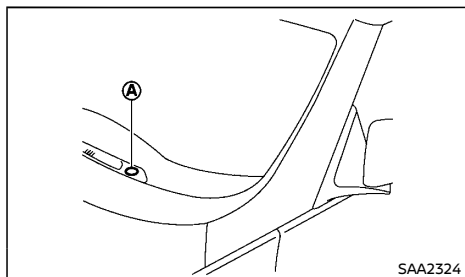

### Right-Hand Drive (RHD) model (example)

When the engine coolant temperature and outside air temperature are low, the air flow from the foot outlets may not operate. However, this is not a malfunction. After the coolant temperature warms up, the air flow from the foot outlets will operate normally.

The sensors A and B, located on the instrument panel, help maintain a constant temperature. Do not put anything on or around the sensors.

## AIR CONDITIONER

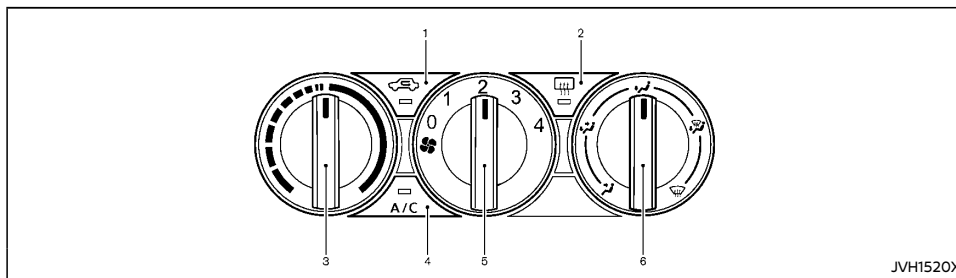

1. Air recirculation "↻" button
2. Rear defogger "☒" button (See "Defogger switch" (P.2-38).) (if equipped)
3. Temperature control dial
4. "A/C" (air conditioner) button
5. Fan speed control "⚙" dial
6. Air flow control dial

### Controls

#### Turning system on/off:

To turn on the system, turn the fan speed control "⚙" dial out of the "0" position. Turn the dial counter clockwise to the "0" position to turn off the system.

#### Fan speed control:

Turn the fan speed control "⚙" dial clockwise to increase the fan speed.

Turn the fan speed control "⚙" dial counter-clockwise to decrease the fan speed.

#### Temperature control:

Turn the temperature control dial to set the desired temperature.

#### Air flow control:

This dial allows you to select the air flow outlets.

- ☒ — Air flows from center and side ventilators.
- ☒ — Air flows from center and side ventilators and foot outlets.
- ☒ — Air flows mainly from the foot outlets.
- ☒ — Air flows from the defogger and foot outlets.
- ☒ — Air flows mainly from the defogger outlets.

#### Outside air circulation:

Push the air recirculation "↻" button. (The indicator light will turn off.) The air flow is drawn from outside the vehicle.

Select the outside air circulation mode for normal air conditioning operation.

**Air recirculation:**

Push the air recirculation " button. (The indicator light will illuminate.)



The air flow is recirculated inside the vehicle.

**A/C (Air Conditioner) operation:**



Push the "A/C" button to turn on or off the air conditioner. When the air conditioner is on, the "A/C" indicator light on the button illuminates.

**Air conditioner operation****Cooling:**

The cooler should be operated for approximately 10 minutes at least once a month. This helps prevent damage to the cooling function due to the lack of lubrication.



1. Push the air recirculation " button. (The indicator light will turn off.)
2. Turn the air flow control dial to the " " position.
3. Turn the fan speed control " " dial to the desired position.
4. Push the "A/C" button. (The "A/C" indicator light will illuminate.)
5. Turn the temperature control dial to the desired position.

A visible mist may be seen coming from the ventilators in hot, humid conditions as the air is cooled rapidly. This does not indicate a malfunction.

For quick cooling when the outside temperature is high, push the air recirculation " button. (The indicator light will turn on.) Be sure to return the air recirculation " button to turn off for normal cooling.

**Dehumidified defogging:**

This mode is used to defog the windows and dehumidify the air.

1. Push the air recirculation " button. (The indicator light will turn off.)
2. Turn the air flow control dial to the " " position.
3. Turn the fan speed control " " dial to the desired position.
4. Push the "A/C" button. (The "A/C" indicator light will illuminate.)
5. Turn the temperature control dial to the desired position.

## MANUAL AIR CONDITIONER AND HEATER (Type A)

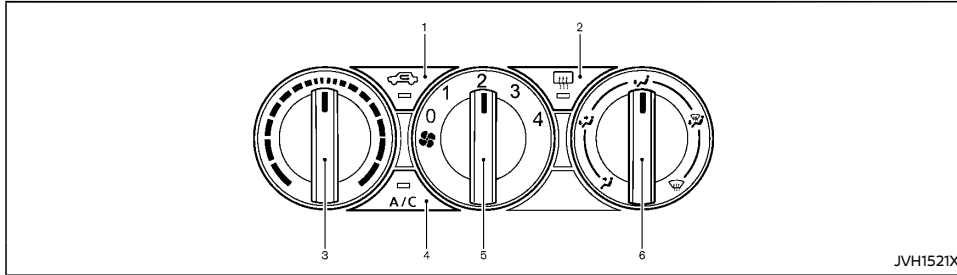

1. Air recirculation "↻" button
2. Rear defogger "☐" button (See "Defogger switch" (P.2-38).) (if equipped)
3. Temperature control dial
4. "A/C" (air conditioner) button
5. Fan speed control "⚙️" dial
6. Air flow control dial

### Controls

#### Turning system on/off:

To turn on the system, turn the fan speed control "⚙️" dial out of the "0" position. Turn the dial counter clockwise to the "0" position to turn off the system.

#### Fan speed control:

Turn the fan speed control "⚙️" dial clockwise to increase the fan speed.

Turn the fan speed control "⚙️" dial counter-clockwise to decrease the fan speed.

#### Temperature control:

Turn the temperature control dial to set the desired temperature. Turn the dial between the middle and the right position to select the hot temperature. Turn the dial between the middle and the left position to select the cool temperature.

#### Air flow control:

This dial allows you to select the air flow outlets.

- ↻ — Air flows from center and side ventilators.
- ☐ — Air flows from center and side ventilators and foot outlets.
- ⚙️ — Air flows mainly from the foot outlets.
- ☐ — Air flows from the defogger and foot outlets.
- ☐ — Air flows mainly from the defogger outlets.

#### Outside air circulation:

Push the air recirculation "↻" button. (The indicator light will turn off.) The air flow is drawn from outside the vehicle.

Select the outside air circulation mode for normal heating or air conditioning operation.

#### Air recirculation:

Push the air recirculation "↻" button. (The indicator light will illuminate.)

The air flow is recirculated inside the vehicle.

#### A/C (Air Conditioner) operation:

Push the "A/C" button to turn on or off the air conditioner. When the air conditioner is on, the "A/C" indicator light on the button illuminates.

### Heater operation

#### Heating:

This mode is used to direct heated air from the foot outlets.



1. Push the air recirculation "↻" button for normal heating. (The indicator light will turn off.)
2. Turn the air flow control dial to the "⚙️" position.
3. Turn the fan speed control "⚙️" dial to the desired position.
4. Turn the temperature control dial to the desired position between the middle and the hot (right) position.

#### Ventilation:

This mode directs outside air from the side and center ventilators.





1. Push the air recirculation "↻" button. (The indicator light will turn off.)



2. Turn the air flow control dial to the "  " position.
3. Turn the fan speed control "  " dial to the desired position.
4. Turn the temperature control dial to the desired position.



#### **Defrosting or defogging:**

This mode directs the air to the defogger outlets to defrost/defog the windows.

1. Turn the air flow control dial to the "  " position.
  2. Push the air recirculation "  " button. (The indicator light will turn off.)
  3. Turn the fan speed control "  " dial to the desired position.
  4. Turn the temperature control dial to the desired position between the middle and the hot (right) position.
- To remove frost from the windshield quickly, turn the temperature control dial to the maximum position and the fan speed control "  " dial to the maximum position.
  - If it is difficult to defog the windshield, turn the "A/C" button on.

#### **Bi-level heating:**



This mode directs cool air from the side and center vents and warm air from the foot outlets. When the temperature control dial is turned to the maximum hot or cool position, the air between the ventilators and the foot outlets is the same temperature.

1. Push the air recirculation "  " button. (The indicator light will turn off.)
2. Turn the air flow control dial to the "  " position.

3. Turn the fan speed control "  " dial to the desired position.
4. Turn the temperature control dial to the desired position.

#### **Heating and defogging:**

This mode heats the interior and defogs the windows.



1. Push the air recirculation "  " button. (The indicator light will turn off.)
2. Turn the air flow control dial to the "  " position.
3. Turn the fan speed control dial to the desired position.
4. Turn the temperature control dial to the maximum hot (right) position.

#### **Air conditioner operation**



The air conditioner system should be operated for approximately 10 minutes at least once a month. This helps prevent damage to the air conditioner system due to the lack of lubrication.

#### **Cooling:**

This mode is used to cool and dehumidify the air.



1. Push the air recirculation "  " button. (The indicator light will turn off.)
2. Turn the air flow control dial to the "  " position.
3. Turn the fan speed control dial to the desired position.
4. Push the "A/C" button. (The "A/C" indicator light will illuminate.)
5. Turn the temperature control dial to the desired position between the middle and the cool (left) position.

A visible mist may be seen coming from the ventilators in hot, humid conditions as the air is cooled rapidly. This does not indicate a malfunction.

- For quick cooling when the outside temperature is high, push the air recirculation "  " button. (The indicator light will turn on.) Be sure to return the air recirculation "  " button to turn off for normal cooling.



#### **Dehumidified heating:**

This mode is used to heat and dehumidify the air.

1. Push the air recirculation "  " button. (The indicator light will turn off.)
2. Turn the air flow control dial to the "  " position.
3. Turn the fan speed control "  " dial to the desired position.
4. Push the "A/C" button. (The "A/C" indicator light will illuminate.)
5. Turn the temperature control dial to the desired position between the middle and the hot (right) position.

#### **Dehumidified defogging:**





This mode is used to defog the windows and dehumidify the air.

1. Push the air recirculation "  " button. (The indicator light will turn off.)
2. Turn the air flow control dial to the "  " position.
3. Turn the fan speed control "  " dial to the desired position.
4. Push the "A/C" button. (The "A/C" indicator light will illuminate.)

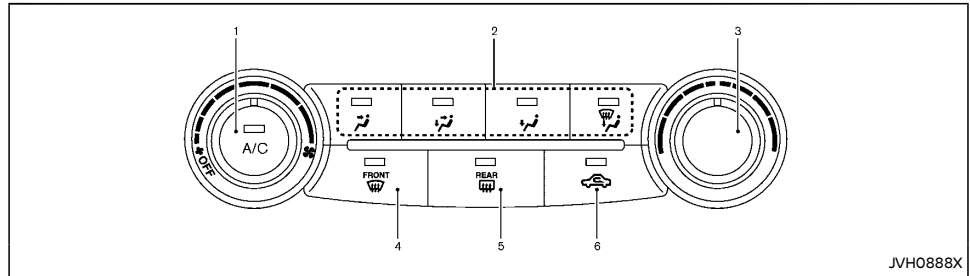
- Turn the temperature control dial to the desired position.

## MANUAL AIR CONDITIONER AND HEATER (Type B)



- "A/C" button/Fan speed control "  " dial
- Air flow control buttons
- Temperature control dial
- Front defogger "  " button
- Rear defogger "  " button (See "Defogger switch" (P.2-38).) (if equipped)
- Air recirculation "  " button

### Controls

#### Turning system on/off:

To turn on the system, turn the fan speed control "  " dial out of the "OFF" position. Turn the dial counterclockwise to the "OFF" position to turn off the system.



#### Fan speed control:

Turn the fan speed control "  " dial clockwise to increase the fan speed.

Turn the fan speed control "  " dial counterclockwise to decrease the fan speed.

#### Ventilation:

This mode directs outside air from the side and center ventilators.





- Push the air recirculation "  " button. (The indicator light will turn off.)
- Push the "  " button. (The indicator light will turn on.)
- Turn the fan speed control "  " dial to the desired position.
- Turn the temperature control dial to the desired position.

#### Temperature control:

Turn the temperature control dial to set the desired temperature. Turn the dial between the middle and the right position to select the hot temperature. Turn the dial between the middle and the left position to select the cool temperature.

### Air flow control:

Push one of the air flow control buttons to select the air flow outlets.

-  — Air flows mainly from center and side ventilators.
-  — Air flows mainly from center and side ventilators and foot outlets.
-  — Air flows mainly from the foot outlet and partly from the defogger.
-  — Air flows mainly from the defogger and foot outlets.

### Outside air circulation:

Push the air recirculation " " button. (The indicator light will turn off.) The air flow is drawn from outside the vehicle.

Select the outside air circulation mode for normal heating or air conditioning operation.

### Air recirculation:

Push the air recirculation " " button on. (The indicator light will illuminate.)

The air will recirculate inside the vehicle.

### A/C (Air Conditioner) operation:



Push the "A/C" button to turn on or off the air conditioner. When the air conditioner is on, the "A/C" indicator light on the button illuminates.

### Heater operation

#### Heating:



This mode is used to direct heated air from the foot outlets.

1. Push the air recirculation " " button for normal heating. (The indicator light will turn off.)

2. Push the " " button. (The indicator light will turn on.)
3. Turn the fan speed control " " dial to the desired position.
4. Turn the temperature control dial to the desired position between the middle and the hot (right) position.

### Defrosting or defogging:



This mode directs the air to the defogger outlets to defrost/defog the windows.

1. Turn the fan speed control " " dial to the desired position.
2. Push the front defogger " " button. (The indicator lights on the front defogger " " button and the "A/C" button will turn on.) Then the air recirculation indicator light will turn off.
3. Turn the temperature control dial to the desired position between the middle and the hot (right) position.

To remove frost from the windshield quickly, turn the temperature control dial to the maximum hot (right) position and the fan speed control " " dial to the maximum position. For the best bi-level heating performance, do not select the air recirculation mode. For the best defogging performance, do not select the air recirculation mode.



### Bi-level heating:

This mode directs cool air from the side/center ventilators and warm air from the foot outlets. (When the temperature control dial is turned to the maximum hot (right) or cool (left) position, the temperatures from the side/center ventilators and the foot outlets will be the same.)

1. Push the air recirculation " " button. (The indicator light will turn off.)
2. Push the " " button. (The indicator light will turn on.)
3. Turn the fan speed control " " dial to the desired position.
4. Turn the temperature control dial to the desired position.

### Heating and defogging:

This mode heats the interior and defogs the windows.



1. Push the air recirculation " " button. (The indicator light will turn off.)
2. Push the " " button. (The indicator light will turn on.)
3. Turn the fan speed control " " dial to the desired position.
4. Turn the temperature control dial to the maximum hot (right) position.

### Air conditioner operation

The air conditioner system should be operated for approximately 10 minutes at least once a month. This helps prevent damage to the air conditioner system due to the lack of lubrication.



### Cooling:

This mode is used to cool and dehumidify the air.

1. Push the air recirculation " " button. (The indicator light will turn off.)
2. Push the " " button. (The indicator light will turn on.)
3. Turn the fan speed control " " dial to the desired position.



4. Push the "A/C" button. (The indicator light will turn on.)
5. Turn the temperature control dial to the desired position between the middle and the cool (left) position.
2. Turn the fan speed control "  " dial to the desired position.
3. Turn the temperature control dial to the desired position.

A visible mist may be seen coming from the ventilators in hot, humid conditions as the air is cooled rapidly. This does not indicate a malfunction.

- For quick cooling when the outside temperature is high, push the air recirculation "  " button. (The indicator light will turn on.) Be sure to return the air recirculation "  " button to turn off for normal cooling.



#### **Dehumidified heating:**

This mode is used to heat and dehumidify the air.

1. Push the air recirculation "  " button. (The indicator light will turn off.)
2. Push the "  " button. (The indicator light will turn on.)
3. Turn the fan speed control "  " dial to the desired position.
4. Push the "A/C" button. (The indicator light will turn on.)
5. Turn the temperature control dial to the desired position between the middle and the hot (right) position.

#### **Dehumidified defogging:**

This mode is used to defog the windows and dehumidify the air.

1. Push the front defogger "  " button. (The indicator lights on the front defogger "  " button and the "A/C" button will turn on. ) Then the air recirculation indicator light will turn off.

## AUTOMATIC AIR CONDITIONER

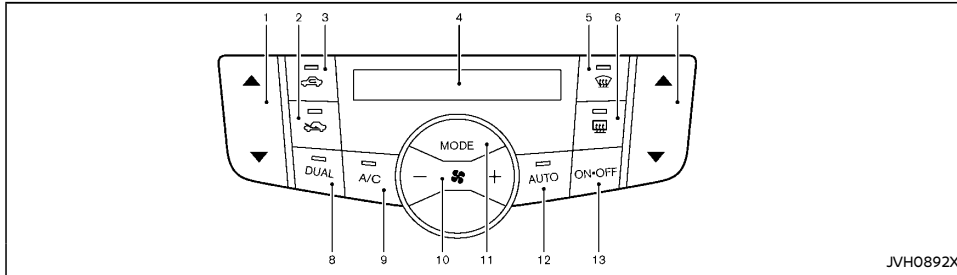

1. Temperature control buttons (left side seat)
2. Outside air circulation "🌬️" button\*
3. Air recirculation "🔄" button\*
4. Display screen
5. Front defogger "🌫️" button\*
6. Rear defogger "🌫️" button\* (See "Defogger switch" (P.2-38).)
7. Temperature control buttons (right side seat)
8. "DUAL" (zone control ON/OFF) button\*
9. "A/C" (Air Conditioner) button\*
10. Fan speed control "🌀" button
11. "MODE" button
12. "AUTO" button\*
13. "ON-OFF" button\*

\*:The switch layout in the illustration is for the Right-Hand Drive (RHD) model. For the Left-Hand Drive (LHD) model, the switch layout will be opposite.

### Automatic operation (AUTO)

The "AUTO" mode may be used year-round as the system automatically controls the air conditioner to a constant temperature, air flow distribution and fan speed after the desired temperature is set manually.

To turn the heater and air conditioner on or off, push the "ON-OFF" button.

### Cooling and dehumidified heating:

1. Push the "AUTO" button (the "AUTO" indicator light will illuminate).
2. For the Right-Hand Drive (RHD) model:
  - If the "A/C" indicator light is not illuminated, push the "A/C" button (the "A/C" indicator light will illuminate).
3. Push the temperature control buttons ("▲" and "▼") to set the desired temperature.
  - When the "DUAL" indicator light is not illuminated, pushing the "DUAL" button (the "DUAL" indicator light will illuminate) allows the user to independently change the driver and passenger side temperatures with the corresponding temperature control buttons ("▲" and "▼").
  - To cancel the separate temperature setting, push the "DUAL" button (the "DUAL" indicator light will turn off) and the driver's side temperature setting will be applied to both the driver and passenger sides.

tures with the corresponding temperature control buttons ("▲" and "▼").

- To cancel the separate temperature setting, push the "DUAL" button (the "DUAL" indicator light will turn off) and the driver's side temperature setting will be applied to both the driver and passenger sides.
4. Push either the outside air circulation "🌬️" button or the air recirculation "🔄" button (the button with an indicator light illuminated) for approximately 2 seconds to switch to the automatic air intake control mode (the indicator lights will blink twice).

A visible mist may be seen coming from the ventilators in hot, humid conditions as the air is cooled rapidly. This does not indicate a malfunction.







### Heating (A/C off):

1. Push the "AUTO" button (the "AUTO" indicator light will illuminate).
2. If the "A/C" indicator light is illuminated, push the "A/C" button (the "A/C" indicator light will turn off).
3. Push the temperature control buttons ("▲" and "▼") to set the desired temperature.
  - When the "DUAL" indicator light is not illuminated, pushing the "DUAL" button (the "DUAL" indicator light will illuminate) allows the user to independently change the driver and passenger side temperatures with the corresponding temperature control buttons ("▲" and "▼").
  - To cancel the separate temperature setting, push the "DUAL" button (the "DUAL" indicator light will turn off) and the driver's side temperature setting will be applied to both the driver and passenger sides.

senger sides.

- Do not set the temperature lower than the outside air temperature. Doing so may cause the temperature to not be controlled properly.
- If the windows fog up, use dehumidified heating instead of the "A/C" off heating.

#### Dehumidified defrosting/defogging:

1. Push the front defogger " " button (the " " indicator light will illuminate).
  2. Push the temperature control buttons ("  " and "  ") to set the desired temperature.
- To quickly remove frost from the outside surface of the windshield, set the temperature control and the fan speed to the maximum levels.
  - After the windshield is cleared, push the "AUTO" button to return to the "AUTO" mode.
  - When the front defogger " " button is pushed, the air conditioner will automatically turn on, sensing the outside air temperature to defog the windshield. For the best defogging performance, do not select the air recirculation mode.
  - Do not set the temperature too low when the front defogger mode is on (the " " indicator light is illuminated), because doing so may fog up the windshield.

#### Manual operation





The manual mode can be used to control the heater and air conditioner to your desired settings.

#### Fan speed control:



Push the fan speed control " " button (+ side or - side) to manually control the fan speed.



#### Air flow control:

Push the "MODE" button to select the desired mode:









-  — Air flows from the center and side ventilators.
-  — Air flows from the center and side ventilators and foot outlets.
-  — Air flows mainly from the foot outlets
-  — Air flows from the front defogger outlets and foot outlets.

#### Temperature control:

Push the temperature control buttons ("  " and "  ") to set the desired temperature.

- When the "DUAL" indicator light is not illuminated, pushing the "DUAL" button (the "DUAL" indicator light will illuminate) allows the user to independently change the driver and passenger side temperatures with the corresponding temperature control buttons ("  " and "  ").
- To cancel the separate temperature setting, push the "DUAL" button (the "DUAL" indicator light will turn off) and the driver's side temperature setting will be applied to both the driver and passenger sides.

#### Air intake control:

- Push the  air recirculation button to recirculate interior air inside the vehicle. The  indicator light on the button will come on.
- Push the  outside air circulation button to draw outside air into the passenger compartment. The  indicator light on the button will come on.
- To control the air intake automatically, push and hold either the  air recirculation button or the  outside air circulation button (whichever indicator light is illuminated). The indicator lights (both air recirculation and outside air circulation buttons) will flash twice, and then the air intake will switch to automatic control. When the automatic control is set, the system automatically alternates between the  outside air circulation and the  air recirculation modes (the indicator light of the active mode will illuminate).

#### To turn system on/off

To turn off the heater and air conditioner, push the "ON-OFF" button.

#### SERVICING AIR CONDITIONER



#### WARNING:

**The air conditioner system contains refrigerant under high pressure. To avoid personal injury, any air conditioner service should be done only by an experienced technician with the proper equipment.**

The air conditioner system in your vehicle is charged with a refrigerant designed with the environment in mind.

**This refrigerant will not harm the earth's**

## AUDIO SYSTEM (if equipped)

**ozone layer.** However, it may contribute in a small part to global warming.

Special charging equipment and lubricant are required when servicing your vehicle's air conditioner. Using improper refrigerants or lubricants will cause severe damage to the air conditioner system. (See "Air conditioner system refrigerant and lubricant" (P.9-5).)

A NISSAN dealer will be able to service your environmentally friendly air conditioner system.

### Air conditioner filter

The air conditioner system is equipped with an air conditioner filter which collects and neutralizes dirt, pollen, dust, etc. To make sure that the air conditioner heats, defogs and ventilates efficiently, replace the filter in accordance with the specified maintenance intervals listed in the separate maintenance booklet. To replace the filter, contact a NISSAN dealer.

The filter should be replaced if the air flow decreases significantly or if windows fog up easily when operating the heater or air conditioner.

For models with NissanConnect System:

Refer to NissanConnect Owner's Manual for the audio system operations.

### AUDIO OPERATION PRECAUTIONS



#### WARNING:

**Do not adjust the audio system while driving so that full attention may be given to vehicle operation.**

### Radio

- Radio reception is affected by station signal strength, distance from radio transmitter, buildings, bridges, mountains and other external influences. Intermittent changes in reception quality normally are caused by these external influences.
- Using a cellular phone in or near the vehicle may influence radio reception quality.

### Compact Disc (CD) player

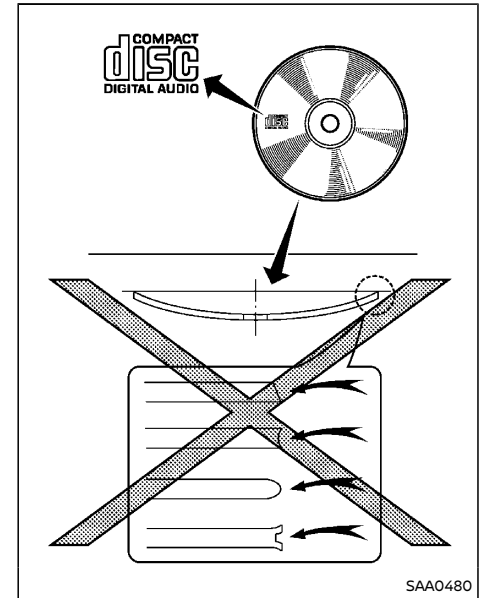

- During cold weather or rainy days, the player may malfunction due to the humidity. If this occurs, remove the CD from CD player and dehumidify or ventilate the player completely.
- The player may skip while driving on rough roads.
- The CD player sometimes may not function when the passenger compartment temperature is extremely high. Lower the temperature before use.

- Do not expose the CD to direct sunlight.
- CDs that are of poor quality, or are dirty, scratched, covered with fingerprints, or that have pin holes may not work properly.
- The following CDs may not work properly.
  - Copy control compact discs (CCCD)
  - Recordable compact discs (CD-R)
  - Rewritable compact discs (CD-RW)
- Do not use the following CDs as they may cause the CD player to malfunction.
  - 8 cm (3.1 in) discs
  - CDs that are not round
  - CDs with a paper label
  - CDs that are warped, scratched or have unusual edges.
- This audio system can only play prerecorded CDs. It has no capabilities to record or burn CDs.

## USB (Universal Serial Bus) Connection Port



### WARNING:

**Do not connect, disconnect or operate the USB device while driving. Doing so can be a distraction. If distracted you could lose control of your vehicle and cause an accident or serious injury.**



### CAUTION:

- **Do not force the USB device into the USB connection port. Inserting the USB device tilted or up-side-down into the port may damage the port. Make sure that the USB device is connected correctly into the USB connection port.**

- **Do not leave the USB cable in a place where it can be pulled unintentionally. Pulling the cable may damage the port.**

The vehicle is not equipped with a USB device. USB devices should be purchased separately as necessary.

This system cannot be used to format USB devices. To format a USB device, use a personal computer.

In some states/area, the USB device for the front seats plays only sound without images for regulatory reasons, even when the vehicle is parked.

This system supports various USB memory devices, USB hard drives and iPod players. Some USB devices may not be supported by this system.

- Partitioned USB devices may not be played correctly.
- Some characters used in other languages (Chinese, Japanese, etc.) may not appear properly in the display. Using English language characters with a USB device is recommended.

### General notes for USB use:

Refer to your device manufacturer's owner information regarding the proper use and care of the device.

### Notes for iPod use:

"Made for iPod", "Made for iPhone", and "Made for iPad" mean that an electronic accessory has been designed to connect specifically to iPod, iPhone, or iPad, respectively, and has been certified by the developer to meet Apple performance standards.

Apple is not responsible for the operation of this device or its compliance with safety and regulatory standards.

Please note that the use of this accessory with iPod, iPhone, or iPad may affect wireless performance.

iPad, iPhone, iPod, iPod classic, iPod nano, iPod shuffle, and iPod touch are trademarks of Apple Inc., registered in the U.S. and other countries. Lightning is a trademark of Apple Inc.

- Improperly plugging in the iPod may cause a checkmark to be displayed on and off (flickering). Always make sure that the iPod is connected properly.
- An iPod nano (1st Generation) may remain in fast forward or rewind mode if it is connected during a seek operation. In this case, please manually reset the iPod.
- An iPod nano (2nd Generation) will continue to fast-forward or rewind if it is disconnected during a seek operation.
- An incorrect song title may appear when the Play Mode is changed while using an iPod nano (2nd Generation).
- Audiobooks may not play in the same order as they appear on an iPod.
- Large video files cause slow responses in an iPod. The vehicle center display may momentarily black out, but will soon recover.
- If an iPod automatically selects large video files while in the shuffle mode, the vehicle center display may momentarily black out, but will soon recover.



## Bluetooth® audio player (if equipped)

- Some Bluetooth® audio devices may not be used with this system. For detailed information about Bluetooth® audio devices that are available for use with this system, contact a NISSAN dealer.
- Before using a Bluetooth® audio system, the initial registration process for the audio device is necessary.
- Operation of the Bluetooth® audio system may vary depending on the audio device that is connected. Confirm the operation procedure before use.
- The playback of Bluetooth® audio will be paused under the following conditions. The playback will be resumed after the following conditions are completed.
  - while using a hands-free phone
  - while checking a connection with a cell phone
- The in-vehicle antenna for Bluetooth® communication is built in the system. Do not place the Bluetooth® audio device in an area surrounded by metal, far away from the system or in a narrow space where the device closely contacts the body or the seat. Otherwise, sound degradation or connection interference may occur.
- While a Bluetooth® audio device is connected through the Bluetooth® wireless connection, the battery power of the device may discharge quicker than usual.
- This system is compatible with the Bluetooth® AV profile (A2DP and AVRCP).



Bluetooth® is a trademark owned by Bluetooth SIG, Inc., and licensed to Visteon Corporation and Robert Bosch GmbH.

## Compact Disc (CD)/USB device with MP3/WMA/AAC (if equipped)

### Terms:

- **MP3** — MP3 is short for Moving Pictures Experts Group Audio Layer 3. MP3 is the most well known compressed digital audio file format. This format allows for near “CD quality” sound, but at a fraction of the size of normal audio files. MP3 conversion of an audio track from CD can reduce the file size by approximately 10:1 ratio (Sampling: 44.1 kHz, Bit rate: 128 kbps) with virtually no perceptible loss in quality. MP3 compression removes the redundant and irrelevant parts of a sound signal that the human ear doesn’t hear.
- **WMA** — Windows Media Audio (WMA) is a compressed audio format created by Microsoft as an alternative to MP3. The WMA codec offers greater file compression than the MP3 codec, enabling storage of more digital audio tracks in the same amount of space when compared to MP3s at the same level of quality.

This product is protected by certain intellectual property rights of Microsoft Corporation and third parties. Use or distribution of such technology outside of this product is prohibited without a license from Microsoft or an authorized Microsoft subsidiary and third parties.
- **AAC (if equipped)** — Advanced Audio Coding (AAC) is a compressed audio format. AAC offers greater file compression than MP3

and enables music file creation and storage at the same quality as MP3.

- **Bit rate** — Bit rate denotes the number of bits per second used by a digital music files. The size and quality of a compressed digital audio file is determined by the bit rate used when encoding the file.
  - **Sampling frequency** — Sampling frequency is the rate at which the samples of a signal are converted from analog to digital (A/D conversion) per second.
  - **Multisession** — Multisession is one of the methods for writing data to media. Writing data once to the media is called a single session, and writing more than once is called a multisession.
  - **ID3/WMA Tag** — The ID3/WMA tag is the part of the encoded MP3 or WMA file that contains information about the digital music file such as song title, artist, album title, encoding bit rate, track time duration, etc. ID3 tag information is displayed on the Album/Artist/Track title line on the display.
- \* Windows® and Windows Media® are registered trademarks and/or trademarks of Microsoft Corporation in the United States of America and/or other countries.

### Playback order:

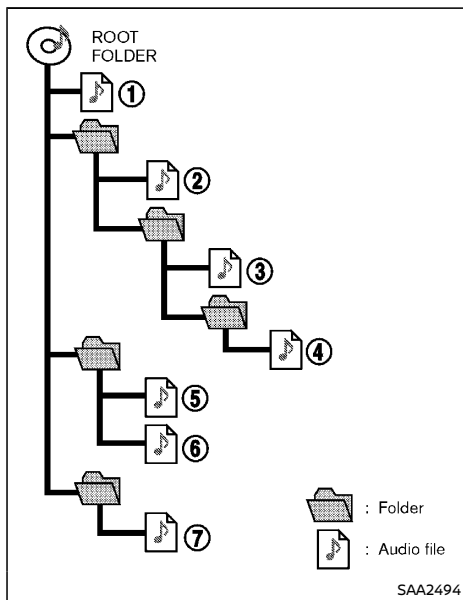

Music playback order of the CD with MP3/WMA/AAC (if equipped) is as illustrated above.

- The folder names of folders not containing MP3/WMA files are not shown in the display.
- If there is a file in the top level of the disc, "Root Folder" is displayed.
- The playback order is the order in which the files were written by the writing software, so the files might not play in the desired order.

**Specification chart:**

**For FM-AM radio with compact disc (CD) player type A, B or C**

Supported media		CD, CD-R, CD-RW, USB2.0	
Supported file systems		ISO9660 LEVEL1, ISO9660 LEVEL2, Romeo, Joliet ISO9660 Level 3 (packet writing) is not supported. Files saved using the Live File System component (on a Windows Vista-based computer) are not supported. USB memory: FAT16, FAT32	
Supported versions*1	MP3	Version	MPEG1
		Sampling frequency	32 kHz - 48 kHz
		Bit rate	32 kbps - 320 kbps VBR*4
	WMA*2	Version	WMA9 (compatible WMA7 and WMA8)
		Sampling frequency	16 kHz - 48 kHz
		Bit rate	48 kbps - 320 kbps, VBR*4
	AAC	Version	MPEG-4 AAC
		Sampling frequency	8 kHz - 48 kHz
		Bit rate	32 kbps - 192 kbps, VBR*4
Tag information (Song title and Artist name)		ID3 tag VER1.0, VER1.1, VER2.2, VER2.3 AAC tag supported	
Folder levels	CD, CD-R, CD-RW	Folder levels: 8, Folders: 255 (including root folder), Files: 512 (Max. 255 files for one folder)	
	USB	Folder levels: 8, Folders 255, Files: 2500 (Max. 255 files for one folder) Memory size: 4GB	
Displayable character codes*3		01: ASCII, 02: ISO-8859-1, 03: UNICODE (UTF-16 BOM Big Endian), 04: UNICODE (UTF-16 Non-BOM Big Endian), 05: UNICODE (UTF-8), 06: UNICODE (Non-UTF-16 BOM Little Endian), 07:SHIFT-JIS	

\*1 Files created with a combination of 48 kHz sampling frequency and 64 kbps bit rate cannot be played.

\*2 Protected WMA files (DRM) cannot be played.

\*3 Available codes depend on what kind of media, versions and information are going to be displayed.

\*4 When VBR files are played, the playback time may not be displayed correctly. WMA7 and WMA8 are not applied to VBR.

**Specification chart:**

**For FM-AM radio with compact disc (CD) player type D or E**

Supported media		CD, CD-R, CD-RW, USB2.0	
Supported file systems		CD, CD-R, CD-RW: ISO9660 LEVEL1, ISO9660 LEVEL2, Romeo, Joliet * ISO9660 Level 3 (packet writing) is not supported. * Files saved using the Live File System component (on a Windows Vista-based computer) are not supported. USB memory: FAT16, FAT32	
Supported versions*1	MP3	Version	MPEG1 Audio Layer 3
		Sampling frequency	32 kHz - 48 kHz
		Bit rate	32 kbps - 320 kbps, VBR*4
	WMA*2	Version	WMA7, WMA8, WMA9
		Sampling frequency	32 kHz - 48 kHz
		Bit rate	32 kbps - 192 kbps, VBR4, 32 kbps - 320 kbps (WMA9 only)
Tag information (Song title and Artist name)		ID3 tag VER1.0, VER1.1, VER2.2, VER2.3, VER2.4 (MP3 only) WMA tag (WMA only)	
Folder levels	CD, CD-R, CD-RW	Folder levels: 8, Folders: 255, Files: 999 (Max. 255 files for one folder)	
	USB	Folder levels: 8, Folders: 255, Files: 2500 (Max. 255 files for one folder) Memory size: 4GB	
Displayable character codes*3		01: ASCII, 02: ISO-8859-1, 03: UNICODE (UTF-16 BOM Big Endian), 04: UNICODE (UTF-16 Non-BOM Big Endian), 05: UNICODE (UTF-8)	

\*1 Files created with a combination of 48 kHz sampling frequency and 64 kbps bit rate cannot be played.

\*2 Protected WMA files (DRM) cannot be played.

\*3 Available codes depend on what kind of media, versions and information are going to be displayed.

\*4 When VBR files are played, the playback time may not be displayed correctly.

**Specification chart:****For FM-AM radio with compact disc (CD) player type F**

Supported media		CD, CD-R, CD-RW, USB2.0	
Supported file systems		ISO9660 LEVEL 1, ISO9660 LEVEL2, Apple ISO, Romeo, Joliet *ISO9660 LEVEL 3 (packet writing) is not supported.	
Supported versions*1	MP3	Version	MPEG1, MPEG2, MPEG2.5
		Sampling frequency	8 kHz - 48 kHz
		Bit rate	8 kbps - 320 kbps, VBR
	WMA*2	Version	WMA7, WMA8, WMA9
		Sampling frequency	32 kHz - 48 kHz
		Bit rate	48 kbps - 192 kbps, VBR
Tag information		ID3 tag VER1.0, VER1.1, VER2.2, VER2.3 (MP3 only)	
Folder levels		Folder levels: 8, Max folders: 255 (including root folder), Files: 512 (Max. 255 files for one folder)	
Displayable character codes*3		01: ASCII, 02: ISO-8859-1, 03: UNICODE (UTF-16 BOM Big Endian), 04: UNICODE (UTF-16 Non-BOM Big Endian), 05: UNICODE (UTF-8), 06: UNICODE (Non-UTF-16 BOM Little Endian)	

\*1 Files created with a combination of 48 kHz sampling frequency and 64 kbps bit rate cannot be played.

\*2 Protected WMA files (DRM) cannot be played.

\*3 Available codes depend on what kind of media, versions and information are going to be displayed.

**Troubleshooting guide:**

Symptom	Cause and Countermeasure
Cannot play	Check if the disc was inserted correctly.
	Check if the disc is scratched or dirty.
	Check if there is condensation inside the player, and if there is, wait until the condensation is gone (about 1 hour) before using the player.
	If there is a temperature increase error, the CD player will play correctly after it returns to the normal temperature.
	If there is a mixture of music CD files (CD-DA data) and MP3/WMA/AAC (if equipped) files on a CD, only the music CD files (CD-DA data) will be played.
	Files with extensions other than ".MP3", ".WMA", ".mp3" or ".wma" cannot be played. In addition, the character codes and number of characters for folder names and file names should be in compliance with the specifications.
	Check if the disc or the file is generated in an irregular format. This may occur depending on the variation or the setting of MP3/WMA/AAC (if equipped) writing applications or other text editing applications.
	Check if the finalization process, such as session close and disc close, is done for the disc.
Check if the disc is protected by copyright.	
Poor sound quality	Check if the disc is scratched or dirty.
It takes a relatively long time before the music starts playing.	If there are many folder or file levels on the MP3/WMA/AAC (if equipped) disc, some time may be required before the music starts playing.
Music cuts off or skips	The writing software and hardware combination might not match, or the writing speed, writing depth, writing width, etc., might not match the specifications. Try using the slowest writing speed.
Skipping with high bit rate files	Skipping may occur with large quantities of data, such as for high bit rate data.
Move immediately to the next song when playing.	When a non-MP3/WMA/AAC (if equipped) file has been given an extension of ".MP3", ".WMA", ".mp3" or ".wma", or when play is prohibited by copyright protection, the player will skip to the next song.
The songs do not play back in the desired order.	The playback order is the order in which the files were written by the writing software, so the files might not play in the desired order.

## FM-AM RADIO WITH COMPACT DISC (CD) PLAYER (Type A)

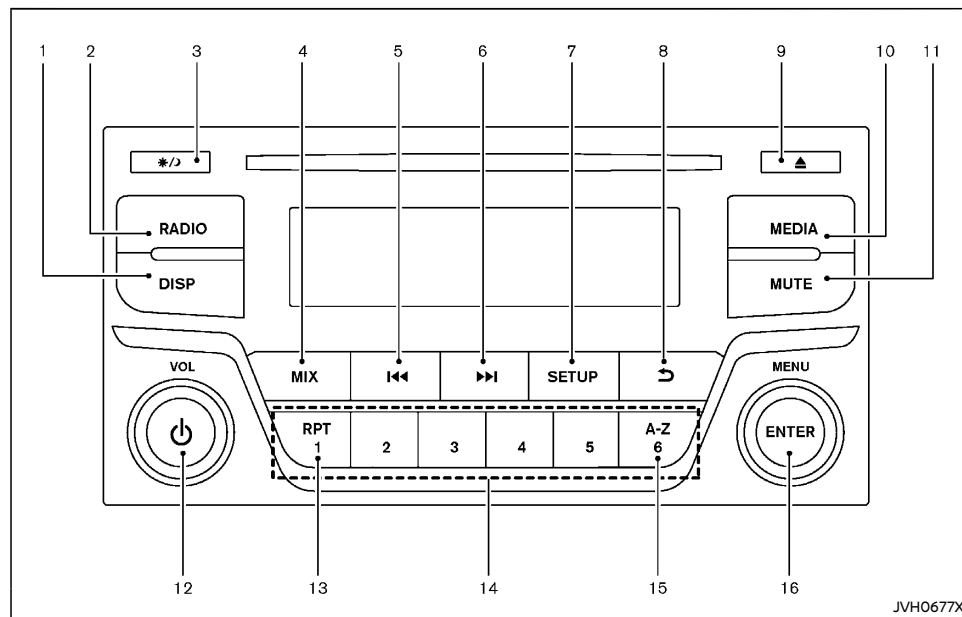

- |                                     |                             |
|-------------------------------------|-----------------------------|
| 1. DISP (Display) button            | 9. CD eject button          |
| 2. RADIO button                     | 10. MEDIA button            |
| 3. Day/Night button                 | 11. MUTE button             |
| 4. MIX button                       | 12. Power VOL (volume) dial |
| 5. Seek/track (rewind) button       | 13. RPT (repeat) button     |
| 6. Seek/track (fast forward) button | 14. Station memory buttons  |
| 7. SETUP button                     | 15. A-Z button              |
| 8. Back button                      | 16. ENTER button/MENU knob  |

## Audio main operation

The audio system operates when the ignition switch is placed in the "ACC" or "ON" position.

### Power button/VOL control knob:

#### Power ON/OFF:

To turn on the audio system, push the power button.

The system will turn on in the mode that was used immediately before the system was turned off.

To turn off the audio system, push the power button.

#### Volume control:

To control the volume, turn the VOL control knob.

Turn the knob clockwise to make the sound louder.

Turn the knob counterclockwise to make the sound quieter.

The audio unit is equipped with a speed volume. This means that the audio system automatically adjusts the volume level in relation to vehicle speed.

### SETUP button:

This item is available only when the audio system is turned on.

To configure Audio, Clock, Radio or Language, perform the following procedure.

1. Push the  button.
2. Turn the MENU knob clockwise or counterclockwise, the display will appear in the following order.

Audio ⇄ Clock ⇄ Radio ⇄ Language

3. Push the ENTER button to select the item.

#### **Audio setting:**

Push the  button and then select "Audio".

Turn the MENU knob, and the mode will change as follows.

Sound ⇔ AUX In ⇔ Speed Volume ⇔ Audio Default

Push the ENTER button to select the setting you want to change. Turn the MENU knob to adjust the selected item.

#### **Sound:**

Adjust Bass, Treble, Balance and Fade. Turn the MENU knob and then push the ENTER button to select the setting item. Turn the MENU knob to adjust the setting.

- **Bass:**  
Enhances or attenuates the bass response sound.
- **Treble:**  
Enhances or attenuates the treble.
- **Balance:**  
Adjusts the balance of the volume between the left and right speakers.
- **Fade:**  
Adjusts the balance of the volume between the front and rear (if equipped) speakers.

#### **AUX In:**

Adjusts the volume output from the auxiliary source.

#### **Speed Vol.:**

Set the audio system to automatically adjust the volume level in relation to vehicle speed.

Turn the MENU knob counterclockwise or clockwise to adjust the volume, higher (more) bars mean the volume level relatively changes more when the vehicle speed increase or



decrease. Push the ENTER button to confirm.

This mode controls the volume output from the speakers automatically in relation to vehicle speed. When "Speed Volume" is displayed, turn the MENU knob clockwise or counterclockwise to adjust the volume level.

Adjusting the setting to 0 (zero) turns off the speed volume feature. Increasing the speed volume setting results in the audio volume increasing more rapidly with vehicle speed. Once chosen, press Enter button to save the setting.

#### **Audio Default menu:**

The audio unit has a saved preset settings as a factory default. Select "Yes" to change all settings back to the factory preset settings. Select "No" to exit the menu keeping the current settings.

After the desired settings have been set, push either the  button or the  button continuously, and wait for 10 seconds without pushing any other buttons to exit the menu screen.

#### **Clock setting:**

Push the  button to enter the setup menu screen and then select "Clock".

Turn the MENU knob, and the mode will change as follows.

Set Time ⇔ ON/OFF ⇔ Format

#### **Set Time:**

Select "Set Time" and then adjust the clock as follows.

The hour display will start flashing. Turn the MENU knob to adjust the hour and push the ENTER button. The minute display will start flashing. Turn the MENU knob to adjust the

minute and push the ENTER button to finish the clock adjustment.

#### **ON/OFF:**

Set the clock display between on or off when the audio unit is turned off. If the clock display setting is turned on, the clock will be displayed when the audio unit is turned off either by pushing the power button or when the ignition switch is placed in the "OFF" position.

#### **Format:**

Switch the clock display between 24-hour mode and 12-hour clock mode.

#### **Radio setting:**

Push the  button to enter the setup menu screen and then select "Radio".

This function is used to select the FM frequency band.

#### **Language setting:**

Push the  button to enter the setup menu screen and then select "Language".

Select the appropriate language and push the ENTER button. Upon completion, the screen will automatically adapt the language setting.



#### **Day/Night button:**

Push the Day/Night button to switch the display brightness between the daytime and nighttime modes.



#### **MUTE button:**

Push the MUTE button to mute the audio system. Push again to restore the sound.



### **MEDIA** MEDIA button:

Push the MEDIA button to play a compatible device when it is connected.

Each time the MEDIA button is pushed, the audio source will change as follows.

CD → USB/iPod → AUX → CD

A source that is not available will be skipped.

### Radio operation



The audio system operates when the ignition switch is placed in the "ACC" or "ON" position.



### **RADIO** RADIO button:

When the RADIO button is pushed while another audio source is playing, the other audio source will turn off and the radio will turn on.

To change the radio band (FM1, FM2, or AM), push the RADIO button.

### Seek/track buttons:

When adjusting the broadcasting station frequency manually, push the  or  button until the desired frequency is achieved.





When adjusting the broadcasting station frequency automatically, push and hold the  or  button. When the system detects a broadcasting station, it will stop at the station.

### (Radio memory) buttons:

During radio reception, pushing the radio memory button will select the stored radio station.

The audio system can store up to 12 FM station frequencies (6 in each of FM 1, FM 2) and 6 AM station frequencies.

To store the station frequency manually:

1. Tune to the desired broadcasting station frequency by using the   buttons.
2. Push and hold a radio memory button  -  until a beep sounds.
3. The channel indicator will display, indicating that the memory is stored properly.
4. Perform steps 1 - 3 for all other memory buttons.

If the battery cable is disconnected, or if the audio fuse blows, the radio memory will be erased. In such a case, reset the desired stations.

### CD player operation

The audio system operates when the ignition switch is placed in the "ACC" or "ON" position.

#### Loading:

Insert a CD into the slot with the label side facing up. The CD will be guided automatically into the slot and will start playing. After loading the CD, the number of tracks and the play time will appear on the display.



#### CAUTION:

**Do not force the CD into the slot. This could damage the player.**

#### NOTE:

- The CD player accepts normal audio CDs or CDs containing MP3/WMA/AAC files.
- An error notification message will be displayed when inserting an incompatible disc type (e.g., DVD), or if the player cannot read the CD. Eject the disc and insert another disc.

### **MEDIA** MEDIA button:

To change to the CD mode, push the MEDIA button with a CD inserted until the CD mode is selected.



#### List view:

While the track is being played, push the ENTER button to display the available tracks in a listed view mode. To select a track from the list, turn the MENU knob and then push the ENTER button.





#### Quick search:

In the list view mode, a quick search can be performed to find a track from the list. Push the A-Z button, turn the MENU knob to the first alphabetic letter of the song title, and then push the ENTER button. When found, a list of the available songs will be displayed. Select, and push the ENTER button to play the preferred track.



### Seek/track buttons:

Push and hold the  or  button to fast forward or rewind through the track. When the button is released, the track will play at normal playing speed.



#### Track up/down:

By pushing the  or  button once, the track will skip forward to the next track or backward to the beginning of the current track. Push the  or  button more than once to skip through the tracks.

#### Folder browsing:

If the recorded media contains folders with music files, pushing the  or  button will play the tracks of each folder in sequence.

To select a preferred folder:

1. Push the ENTER button or the  button, and a list of tracks in the current folder is displayed.
2. Push the  button.
3. Turn the MENU knob for the preferred folder.
4. Push the ENTER button to access the folder. Push the ENTER button again to start playing the first track or turn the MENU knob, and push the ENTER button to select another track.

If the current selected folder contains sub folders, push the ENTER button, and a new screen with a list of sub folders will be displayed. Turn the MENU knob for the sub folder and then push the ENTER button to select. Select the root folder item when songs are recorded additionally in the root folder.

To return to the previous folder screen, push the  button.

#### **RPT button:**

Push the  button and the current track will be played continuously.

#### **MIX button:**

Push the  button and all the tracks will be played in a random order.

#### **DISP button:**



While a CD with title information is being played, the title of the played track is displayed.

When the  button is pushed repeatedly while a CD with MP3/WMA is playing, further information about the track can be displayed

along with the track title as follows.

Track time → Artist → Album → Track time

Track details:

Pushing and holding the  button will turn the display into a detailed overview. Push the  button to return to the display for the main display mode.

#### **CD eject button:**

When the  button is pushed while a CD is loaded, the CD will be ejected.

When the ignition switch is placed in the “OFF” or “LOCK” position it is possible to eject the CD currently being played. However the audio unit will not be activated.

If a CD is ejected by pushing the  button, and it is not taken out from the loading slot within 20 seconds, the CD will automatically be reloaded to the slot in order to protect the CD.



### USB (Universal Serial Bus) connection port

The USB connection port is located on the lower part of the instrument panel. See “USB (Universal Serial Bus) connection port” (P.4-74). Connect a USB memory device into the connection port. The system will switch to the USB memory device mode automatically.

If the system has been turned off while the USB memory device was playing, pushing the power button will start the USB memory device.

The following operations are identical to the audio main operation of the Compact Disc (CD) operation. For details, see “CD player operation” (P.4-41).

- List view

- Quick search
-   (Seek/track)
- MIX (Random play)
- RPT (Repeat track)
- Folder browsing

#### **MEDIA button:**

To change to the USB mode, push the  button with a USB connected until the USB mode is selected.



#### **DISP button:**

While a track with recorded music information tags (ID3-tags) is being played, the title of the played track is displayed. If the tags are not provided then a notification message is displayed.

When the  button is pushed continuously, further information about the track can be displayed along with the track title as follows.

Track time → Artist → Album → Track time

Track details:

Pushing and holding the  button will turn the display into a detailed overview. Push the  button to return to the display for the main display mode.

### iPod player operation

#### **Connecting iPod:**

Connect the iPod to the USB connection port using the USB cable that came with your iPod.

The USB connection port is located on the lower part of the instrument panel. See “USB (Universal Serial Bus) connection port” (P.4-74).

When the iPod is connected to the vehicle, the iPod music library can only be operated by the

vehicle audio controls.

\* iPod and iPhone are a trademark of Apple Inc., registered in the U.S. and other countries.



#### WARNING:

**Do not connect, disconnect or operate the USB device while driving. Doing so can be a distraction. If distracted you could lose control of your vehicle and cause an accident or serious injury.**



#### CAUTION:

- **Do not force the USB device into the USB connection port. Inserting the USB device tilted or up-side-down into the port may damage the port. Make sure that the USB device is connected correctly into the USB connection port. (Some USB devices come with a  mark as a guide. Make sure that the mark is facing the correct direction before inserting the device.)**
- **Do not leave the USB cable in a place where it can be pulled unintentionally. Pulling the cable may damage the port.**

Refer to your device manufacturer's owner information regarding the proper use and care of the device.

#### Compatibility:

The system unit shall be compatible with all devices (past and future) supporting Apple Accessory Protocol on USB link.

It includes (and not limited to):

- iPod Generation 5 devices
- iPod Classic I and II (Generation 6 and 7)

- iPod Generation OS 1, 2, 3, 4 and next
- iPhone Generation OS 1, 2, 3, 4 and next
- iPod Nano (1G, 2G, 3G)
- iPad 1, 2 and 3

#### NOTE:

**This audio system does not support iPad charging.**

#### MEDIA button:

To operate the iPod, push the  button repeatedly until the USB/iPod mode is selected and then push the ENTER button.

#### iPod main operation:

Interface:

The interface for iPod operation shown on the audio system display is similar to the iPod interface. Use the ENTER button or MENU knob to play a track on the iPod.



The following items can be chosen from the menu list screen.

- Playlists
- Artist
- Albums
- Tracks
- More

For further information about each item, see the iPod owner's manual.

The following operations are identical to the audio main operation of the Compact Disc (CD) operation. For details, see "CD player operation" (P.4-41).

- List view
- Quick search

-   (Seek/track)
- MIX (Random play)
- RPT (Repeat track)
- Folder browsing



#### DISP button:

While a track with recorded music information tags (ID3-tags) is being played, the title of the played track is displayed.

When the  button is pushed repeatedly, further information about the track can be displayed along with the track title as follows:

Track time → Artist → Album → Track time

Track details:

Pushing and holding the  button will turn the display into a detailed overview. To return to the main display, push the  button.

#### Auxiliary input jack

The AUX input jack is located on the lower part of the instrument panel. See "AUX (auxiliary) input jack" (P.4-75). The AUX input jack accepts any standard analog audio input such as from a portable cassette tape/CD player, MP3 player or laptop computer.

Push the  button to play a compatible device when it is plugged into the AUX input jack.

NISSAN strongly recommends using a stereo mini plug cable when connecting your music device to the audio system. Music may not play properly when a monaural cable is used.



#### WARNING:

**Do not allow the cable or an external device connected to the AUX terminal to affect your driving.**

**NOTE:**

- Depending on the external device, please note that the volume may be louder or quieter than that of the external device.
- When the AUX contacts the plug of the connector cable, noise may be heard.
- The connected external device cannot be operated with the main audio system. The volume and sound quality can be adjusted.
- The song title in the external device cannot be displayed on the audio display.
- For the power source of the external device, use the special battery. The external device cannot be charged with the AUX terminal. Noise may be heard if the CD, radio etc. is operated while charging the battery with the power socket of the vehicle.

**FM-AM RADIO WITH COMPACT DISC (CD) PLAYER (Type B)**

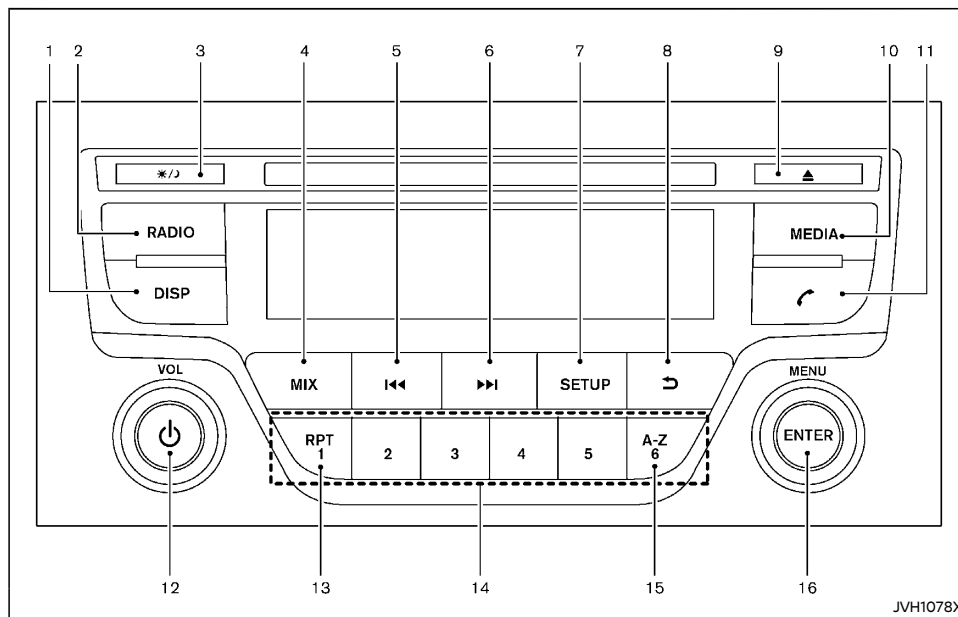

- |                                     |                             |
|-------------------------------------|-----------------------------|
| 1. DISP (Display) button            | 9. CD eject button          |
| 2. RADIO button                     | 10. MEDIA button            |
| 3. Day/Night button                 | 11. Phone button            |
| 4. MIX button                       | 12. Power/VOL (Volume) dial |
| 5. Seek/track (rewind) button       | 13. RPT (repeat) button     |
| 6. Seek/track (fast forward) button | 14. Station memory buttons  |
| 7. SETUP button                     | 15. A-Z button              |
| 8. Back button                      | 16. MENU/ENTER dial         |

## Anti-theft system (if equipped)

Use of a 4-digit radio PIN (Personal Identification Number) code, known only to the vehicle owner, effectively reduces the possibility of the audio unit being stolen. Without the PIN code the audio unit cannot be activated.

If force is used to try and remove the audio unit, the Anti-theft system activates and the audio unit is locked. The only way to unlock the audio unit is to enter the radio code number shown on an identification card supplied with the vehicle documentation.

### NOTE:

- **The 4 digit radio code is shown on a card that you received with your vehicle documentation.**
- **Contact a NISSAN dealer if you do lose the 4 digit radio code of the audio unit.**

### Unlocking the unit:

If the battery supply to the vehicle is interrupted, the audio unit will lock.

When the power is restored and the unit switched on, the display will show "Radio Code" and it will be unlocked when the codes have been entered correctly.

### Unlocking procedure:

Read this section very carefully. It is important that the instructions are followed precisely.

To unlock the audio unit, proceed as follows:

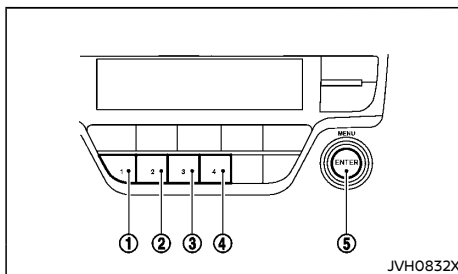

1. Place the ignition switch in the "ACC" or "ON" position.
2. "Radio Code" is displayed along with four numerical zero digits.
3. Push preset ① the number of times corresponding with the first digit of the radio code.  
For example, if the radio code is 5169: for the first digit, "5", push the preset ① five times.
4. The second, third, and fourth digits of the radio code must be entered in the same way, only now using preset ②, ③, and ④.  
For example, push ② once, ③ six times, and ④ nine times.
5. Push the MENU/ENTER dial ⑤ to confirm the code. If you entered the code correctly the unit will switch on.
6. If the code is entered incorrectly a notification message "Incorrect Pin", "Please re-enter Pin" and the number of attempts left [Remaining Tries: xx] will be shown.

After reading the message, push the MENU/ENTER dial ⑤ to return to the entry screen and enter the correct radio code.

- If the wrong code is entered after the third attempt, the audio unit will lock for 60 minutes. The display will show a count down timer from 60 to 0 (minutes). After 60 minutes enter the correct radio code.
- If the wrong code is entered after eight sets of three entries, the audio unit will lock permanently. Contact a NISSAN dealer for further details.

## Audio main operation

The audio system operates when the ignition switch is placed in the "ON" or "ACC" position.

### Power/VOL dial:

#### Power ON/OFF:

To turn on the audio system, push the Power/VOL dial.

The system will turn on in the mode, which was used immediately before the system was turned off.

To turn off the audio system, push the Power/VOL dial.

#### Volume control:

To control the volume, turn the Power/VOL dial. Turn the Power/VOL dial clockwise to make the sound louder.

Turn the Power/VOL dial counterclockwise to make the sound quieter.

### SETUP button:

To configure Audio, Clock, Radio, or Language settings, perform the following procedure:

1. Push the SETUP button.
2. Turn the MENU/ENTER dial, the display will appear in the following order:  
Audio → Clock → Radio → Language

### 3. Push the MENU/ENTER dial.

After the desired levels have been set, push the Back button repeatedly or push the SETUP button.

#### Audio adjustments:

Turn the MENU/ENTER dial until the Audio is displayed, and push the MENU/ENTER dial.

Each time the MENU/ENTER dial is pushed, the mode will change as follows:

Sound → AUX In → Speed Vol. → Bass Boost → Audio Default

Turn the MENU/ENTER dial clockwise or counterclockwise to adjust the following items and push MENU/ENTER dial to confirm.

- **Sound:**

Bass:

Use this control to enhance or attenuate bass response sound.

Treble:

Use this control to enhance or attenuate the treble.

Bal. (Balance) :

Use this control to adjust the balance of the volume between the left and right speakers.

Fade:

Use this control to adjust the balance of the volume between the front and the rear speakers.

- **AUX In:**

Use this control to adjust the volume output from the auxiliary source.

- **Speed Vol. (Volume) :**

This mode controls the volume output from the speakers automatically in relation to vehicle speed.

Adjusting the setting to 0 (zero) turns off

the speed volume feature.

- **Bass Boost:**

Turn on or off the Bass Boost feature which emphasizes the lower audio frequencies.

- **Audio Default:**

The audio unit has a saved preset settings as a factory default. Select "Yes" to change all settings back to the factory preset settings. Select "No" to exit the menu keeping the current settings.

#### Clock setting:

Turn the MENU/ENTER dial until the Clock is displayed, and push the MENU/ENTER dial.

Turn the MENU/ENTER dial, the mode will change as follows:

Set Time → ON/OFF → Format

- **Set Time**

Select "Set Time" then adjust the clock as follows:

The hour display will start flashing. Turn the MENU/ENTER dial to adjust the hour and push the MENU/ENTER dial. The minute display will start flashing. Turn the MENU/ENTER dial to adjust the minute and push the MENU/ENTER dial to finish the clock adjustment.

- **ON/OFF**

The clock display can be turned on and off. When "ON" is selected, the clock will be displayed. (The clock will keep being displayed even after the power of the audio unit is turned off). When "OFF" is selected, the clock will not be displayed.

- **Format**

Switch the clock display between 24-hour mode and 12-hour clock mode.

#### Radio setting:

Turn the MENU/ENTER dial until the Radio is displayed, and push the MENU/ENTER dial.

The FM station which can be received will be updated.

#### Language setting:

Turn the MENU/ENTER dial until the Language is displayed, and push the MENU/ENTER dial.

Select the appropriate language and push the MENU/ENTER dial. Upon completion, the screen will automatically adapt the language setting.



#### Day/Night button:

Push the Day/Night button to switch the display brightness between the daytime and nighttime modes.

The switches on the audio unit will also illuminate in the nighttime mode.



#### Phone button:

For operation on how to use phone button, see "Bluetooth® Hands-Free Phone System (Type A)" (P.4-77).



#### MEDIA button:

Push the MEDIA button to play a compatible device when it is connected.

Each time the MEDIA button is pushed, the audio source will change.

## Radio operation

### Frequency range and step change:

To change the frequency range and step specification of the radio, perform the following operations.

1. Turn on the audio system.
2. Push the RADIO button and select AM or FM mode.
3. Push and hold the SETUP button for more than 3 seconds.
4. After the 3 seconds, keep holding the SETUP button and turn the MENU/ENTER dial counterclockwise until you hear 3 clicks, clockwise until you hear 3 clicks, and then counterclockwise until you hear 3 clicks.
5. Turn the MENU/ENTER dial until "Region" is highlighted, and push the MENU/ENTER dial.
6. Select an appropriate region from the following options:
  - EUR
  - GOM Pacific
  - GOM S. America
7. To apply the setting, turn off the audio system, place the ignition switch in the "OFF" position, and then place the ignition switch back in the "ON" position.

### **RADIO** RADIO button:

When the RADIO button is pushed while the audio system is off, the audio system will turn on and the radio will turn on.

When the RADIO button is pushed while another audio source is playing, the other audio source will turn off and the radio will turn on.



To change the radio bands, push the RADIO button until the desired band appears.

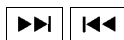

FM 1 → FM 2 → AM → FM 1

When the RADIO button is pushed for more than 1.5 seconds, the six stations with the strongest signals are stored in the preset (1 to 6) buttons of the band. During the search, a notification message appears on the display and the sound is muted until the operation is complete. Once completed, the radio selects preset button.



### Seek/track buttons:

Push  or  button briefly to manually change the frequency.

To adjust the broadcasting station frequency automatically, push and hold the  or  button. When the system detects a broadcasting station, it will stop at the station.

### **1 2 3 4 5 6** Station memory buttons:

During radio reception, pushing the station memory button for less than 2 seconds will select the stored radio station.

The audio system can store up to 12 FM station frequencies (6 in each of FM 1 and FM 2 ) and 6 AM station frequencies.

To store the station frequency manually:

1. Tune to the desired broadcasting station frequency by using the Seek/track buttons.
2. Push and hold a station memory button **1** - **6** until a beep sounds.
3. The channel indicator will display, indicating that the memory is stored properly.
4. Perform steps 1 - 3 for all other memory buttons.

If the battery cable is disconnected, or if the

audio fuse blows, the station memory will be erased. In such a case, reset the desired stations.

### Radio Data System (RDS) operation (if equipped):

The RDS is a system through which encoded digital information is transmitted by FM radio stations in addition to the normal FM radio broadcasting. The RDS provides information services such as station name, traffic information, or news.

#### NOTE:

**In some countries or regions, some of these services may not be available.**

### Alternative Frequency (AF) mode

The AF mode operates in the FM (radio) mode.

The AF function compares signal strengths and selects the station with the optimum reception conditions for the currently tuned-in station.

### RDS functions

When an RDS station is tuned in with seek or manual tuning, the RDS data is received and the Programme Service (PS) name is displayed.

## CD player operation

### Loading:

Insert a CD into the slot with the label side facing up. The CD will be guided automatically into the slot and will start playing. After loading the CD, the number of tracks and the playtime will appear on the display.



### CAUTION:

Do not force the CD into the slot. This could damage the player.

### NOTE:

- The CD player accepts normal audio CDs or CDs containing MP3/WMA/AAC files.
- An error notification message will be displayed when inserting an incompatible disc type (e.g. DVD), or if the player cannot read the CD. Eject the disc and insert another disc.



### MEDIA button:

To change to the CD mode, push the MEDIA button with a CD inserted until the CD mode is selected.

### List view:



While the track is being played, push the MENU/ENTER dial to display the available tracks in a listed view mode. To select a track from the list, turn the MENU/ENTER dial then push MENU/ENTER dial.

### Quick search:





In the list view mode, a quick search can be performed to find a track from the list. Push the A-Z button, turn the MENU/ENTER dial to the first alphabetic letter of the song title and then push the MENU/ENTER dial. When found, a list of the available songs will be displayed. Select, and push the MENU/ENTER dial to play the preferred track.



### Seek/track buttons:

Push and hold the  or  button to fast forward or rewind through the track. When the button is released, the track will play at normal playing speed.

Track up/down:

Pushing the  or  button once, the track will skip forward to the next track or backward to the beginning of the current track. Push the  or  button more than once to skip through the tracks.

### Folder browsing:

If the recorded media contains folders with music files, pushing the Seek/track button will play in sequence the tracks of each folder.

To select a preferred folder:

1. Push the MENU/ENTER dial or the Back button and a list of tracks in the current folder is displayed.
2. Push the Back button.
3. Turn the MENU/ENTER dial for the preferred folder.
4. Push the MENU/ENTER dial to access the folder. Push the MENU/ENTER dial again to start playing the first track or turn the MENU/ENTER dial, and push the MENU/ENTER dial to select another track.

If the current selected folder contains sub folders, push the MENU/ENTER dial, a new screen with a list of sub folders will be displayed. Turn the MENU/ENTER dial for the sub folder then push the MENU/ENTER dial to select. Select the root folder item when songs are recorded additionally in the root folder.

To return to the previous folder screen, push the Back button.



### RPT button:

Push the RPT button and the current track will be played continuously.



### MIX button:

Push the MIX button and all the tracks will be played in a random order.



### DISP button:

While a CD with recorded music information tags (CD-text/ID3-text tags) is being played, the title of the played track is displayed when available.

When the DISP button is pushed repeatedly, further information about the track can be displayed along with the track title as follows:

Track time → Artist name → Album title → Track time

Track details:

Pushing and holding the DISP button will turn the display into a detailed overview. Push the Back button to return to the previous screen.



### CD eject button:

When the CD eject button is pushed while the ignition switch is placed in the "ON" or "ACC" position, the CD will be ejected.

If a CD is ejected by pushing the CD eject button, and it is not taken out from the loading slot within 20 seconds, the CD will automatically be reloaded to the slot to protect the CD.



## USB (Universal Serial Bus) connection port



### USB device main operation:

The USB connection port is located on the lower part of the instrument panel. See "USB (Universal Serial Bus) connection port" (P.4-74). Connect a USB memory device into the connection port. The USB memory device will be activated automatically.

Refer to your device manufacturer's owner information regarding the proper use and care of the device.

If the system has been turned off while the USB memory device was playing, pushing the Power/VOL dial will start the USB memory device.

The following operations are identical to the audio main operation of the Compact Disc (CD) operation. For details, see "CD player operation" (P.4-47).

- List view
- Quick search
-   (Seek/track)
- MIX (Random play)
- RPT (Repeat track)
- Folder browsing

### MEDIA button:

To operate the USB memory device, push the MEDIA button repeatedly until the USB mode is selected.

### DISP button:

While a track with recorded music information tags (ID3-tags) is being played, the title of the played track is displayed.

When the DISP button is pushed repeatedly, further information about the track can be displayed along with the track title as follows:

Track time → Artist → Album → Track time

Track details:

Pushing and holding the DISP button will turn the display into a detailed overview. Push the Back button to return to the display for the main display mode.

## iPod player operation

### Connecting iPod:

Connect the iPod to the USB connection port using the USB cable that came with your iPod.

The USB connection port is located on the lower part of the instrument panel. See "USB (Universal Serial Bus) connection port" (P.4-74).

When the iPod is connected to the vehicle, the iPod music library can only be operated by the vehicle audio controls.

\* iPod and iPhone are a trademark of Apple Inc., registered in the U.S. and other countries.

### Compatibility:

The system unit shall be compatible with all devices (past and future) supporting Apple Accessory Protocol on USB link.

It includes (and not limited to):

- iPod Generation 5 devices
- iPod Classic I and II (Generation 6 and 7)

- iTunes Generation OS 1, 2, 3, 4 and next
- iPhone Generation OS 1, 2, 3, 4 and next
- iPod Nano (1G, 2G, 3G)
- iPad 1, 2 and 3

### NOTE:

**This audio system do not support iPad charging.**

### MEDIA button:

To operate the iPod, push the MEDIA button repeatedly until the USB (iPod) mode is selected and then push the MENU/ENTER dial.

### iPod main operation:

Interface:

The interface for iPod operation shown on the audio system display is similar to the iPod interface. Use the MENU/ENTER dial to play a track on the iPod.



The following items can be chosen from the menu list screen.

- Playlists
- Artists
- Albums
- Tracks
- More

For further information about each item, see the iPod owner's manual.

The following operations are identical to the audio main operation of the Compact Disc (CD) operation. For details, see "CD player operation" (P.4-47).

- List view
- Quick search

-   (Seek/track)
- MIX (Random play)
- RPT (Repeat track)
- Folder browsing

**DISP DISP button:**

While a track with recorded music information tags (ID3-tags) is being played, the title of the played track is displayed.

When the DISP button is pushed repeatedly, further information about the track can be displayed along with the track title as follows:

Track time → Artist → Album → Track time

Track details:

Pushing and holding the DISP button will turn the display into a detailed overview. To return to the main display, push the Back button.

**Bluetooth® audio player operation**

**Regulatory information:**



Bluetooth® is a trademark owned by Bluetooth SIG, Inc. and licensed to Visteon Corporation.

**CE statement:**

Hereby Visteon Corp. declares that this system is in compliance with the essential requirements and other relevant provisions of Directive 1999/5/EC.



**NOTE:**

The audio system only supports Bluetooth® devices with AVRCP (Audio Video Remote Control Profile) version 1.3, or 1.0 or earlier.

**Bluetooth® audio player main operation:**

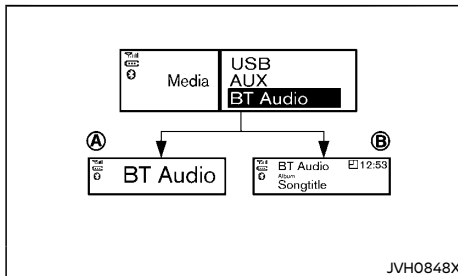

To play Bluetooth® audio, the Bluetooth® audio device needs to be paired to the in-vehicle system. For the pairing operation, see "Pairing device" (P.4-78).



**MEDIA MEDIA button:**

To operate the Bluetooth® audio streaming use the following method:





Push MEDIA button repeatedly until "BT Audio" is shown.

The type of display, (A) or (B), shown on the audio system can vary depending on the Bluetooth® version of the device.

  **Seek/track buttons**

Push and hold the  or  button to fast forward or rewind through the track. When the button is released, the track will play at normal playing speed.

**Track up/down:**

Pushing the  or  button once, the track will skip forward to the next track or backward to the beginning of the current track. Push the  or  button more than once to skip through the tracks.

**DISP DISP button:**

If the song contains music information tags (ID3- tags), the title of the played song will be displayed. If tags are not provided then the display will not show any messages.

When the DISP button is pushed repeatedly further information about the song can be displayed along with the song title.

A long push on DISP button will turn the display into a detailed overview which after a few seconds returns to the main display; or push DISP button briefly.

**AUX device player operation**

The AUX jack is located on lower part of the instrument panel. See "AUX (auxiliary) input jack" (P.4-75). The AUX input jack accepts any standard analog audio input such as from a portable cassette tape/CD player, MP3 player or laptop computer.

NISSAN strongly recommends using a stereo mini plug cable when connecting your music device to the audio system. Music may not play properly when a monaural cable is used.

**MEDIA MEDIA button:**

To switch to the AUX mode, push the MEDIA button repeatedly until the AUX mode is selected.

## FM-AM RADIO WITH COMPACT DISC (CD) PLAYER (Type C)

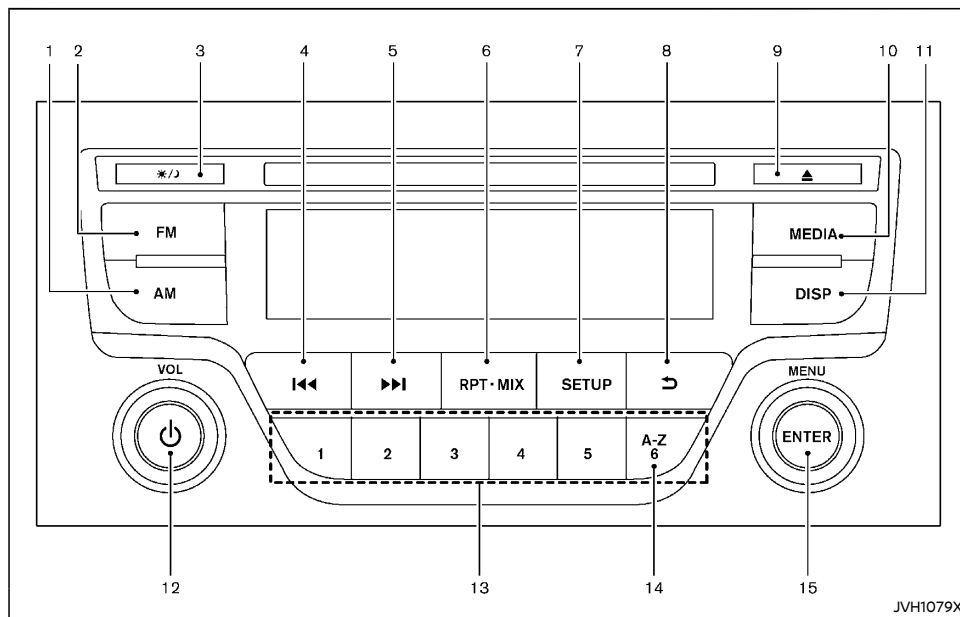

- |                                     |                             |
|-------------------------------------|-----------------------------|
| 1. AM button                        | 9. CD eject button          |
| 2. FM button                        | 10. MEDIA button            |
| 3. Day/Night button                 | 11. DISP (Display) button   |
| 4. Seek/track (rewind) button       | 12. Power/VOL (Volume) dial |
| 5. Seek/track (fast forward) button | 13. Station memory buttons  |
| 6. RPT (repeat) · MIX button        | 14. A-Z button              |
| 7. SETUP button                     | 15. MENU/ENTER dial         |
| 8. Back button                      |                             |

## Anti-theft system (if equipped)

Use of a 4-digit radio PIN (Personal Identification Number) code, known only to the vehicle owner, effectively reduces the possibility of the audio unit being stolen. Without the PIN code the audio unit cannot be activated.

If force is used to try and remove the audio unit, the Anti-theft system activates and the audio unit is locked. The only way to unlock the audio unit is to enter the radio code number shown on an identification card supplied with the vehicle documentation.

### NOTE:

- **The 4 digit radio code is shown on a card that you received with your vehicle documentation.**
- **Contact a NISSAN dealer if you do lose the 4 digit radio code of the audio unit.**

### Unlocking the unit:

If the battery supply to the vehicle is interrupted, the audio unit will lock.

When the power is restored and the unit switched on, the display will show "Radio Code" and it will be unlocked when the codes have been entered correctly.

### Unlocking procedure:

Read this section very carefully. It is important that the instructions are followed precisely.

To unlock the audio unit, proceed as follows:

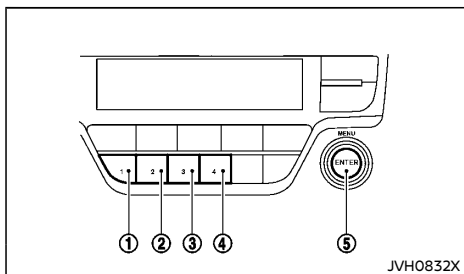

- Place the ignition switch in the "ACC" or "ON" position.
- "Radio Code" is displayed along with four numerical zero digits.
- Push preset ① the number of times corresponding with the first digit of the radio code.  
For example, if the radio code is 5169: for the first digit, "5", push the preset ① five times.
- The second, third, and fourth digits of the radio code must be entered in the same way, only now using preset ②, ③, and ④.  
For example, push ② once, ③ six times, and ④ nine times.
- Push the MENU/ENTER dial ⑤ to confirm the code. If you entered the code correctly the unit will switch on.
- If the code is entered incorrectly a notification message "Incorrect Pin", "Please re-enter Pin" and the number of attempts left [Remaining Tries: xx] will be shown.

After reading the message, push the MENU/ENTER dial ⑤ to return to the entry screen and enter the correct radio code.

- If the wrong code is entered after the third attempt, the audio unit will lock for 60 minutes. The display will show a count down timer from 60 to 0 (minutes). After 60 minutes enter the correct radio code.
- If the wrong code is entered after eight sets of three entries, the audio unit will lock permanently. Contact a NISSAN dealer for further details.

### Audio main operation

The audio system operates when the ignition switch is placed in the "ON" or "ACC" position.

#### Power/VOL dial:

##### Power ON/OFF:

To turn on the audio system, push the Power/VOL dial.

The system will turn on in the mode, which was used immediately before the system was turned off.

To turn off the audio system, push the Power/VOL dial.

##### Volume control:

To control the volume, turn the Power/VOL dial. Turn the Power/VOL dial clockwise to make the sound louder.

Turn the Power/VOL dial counterclockwise to make the sound quieter.

#### SETUP button:

To configure Audio, Clock, Radio, or Language settings, perform the following procedure:

- Push the SETUP button.
- Turn the MENU/ENTER dial, the display will appear in the following order:  
Audio → Clock → Radio → Language

- Push the MENU/ENTER dial.

After the desired levels have been set, push the Back button repeatedly or push the SETUP button.

### Audio adjustments:

Turn the MENU/ENTER dial until the Audio is displayed, and push the MENU/ENTER dial.

Each time the MENU/ENTER dial is pushed, the mode will change as follows:

Sound → AUX In → Speed Vol. → Bass Boost → Audio Default

Turn the MENU/ENTER dial clockwise or counterclockwise to adjust the following items and push MENU/ENTER dial to confirm.

#### • Sound menu

Bass:

Use this control to enhance or attenuate bass response sound.

Treble:

Use this control to enhance or attenuate the treble.

Bal. (Balance) :

Use this control to adjust the balance of the volume between the left and right speakers.

Fade:

Use this control to adjust the balance of the volume between the front and the rear speakers.

#### • AUX In menu

Use this control to adjust the volume output from the auxiliary source.

#### • Speed Vol. (Volume) menu

This mode controls the volume output from the speakers automatically in relation to vehicle speed.

Adjusting the setting to 0 (zero) turns off

the speed volume feature.

- **Bass Boost menu**

Turn on or off the Bass Boost feature which emphasizes the lower audio frequencies.

- **Audio Default menu**

The audio unit has a saved preset settings as a factory default. Select "Yes" to change all settings back to the factory preset settings. Select "No" to exit the menu keeping the current settings.

**Clock setting:**

Turn the MENU/ENTER dial until the Clock is displayed, and push the MENU/ENTER dial.

Turn the MENU/ENTER dial, the mode will change as follows:

Set Time → ON/OFF → Format

- **Set Time**

Select "Set Time" then adjust the clock as follows:

The hour display will start flashing. Turn the MENU/ENTER dial to adjust the hour and push the MENU/ENTER dial. The minute display will start flashing. Turn the MENU/ENTER dial to adjust the minute and push the MENU/ENTER dial to finish the clock adjustment.

- **ON/OFF**

The clock display can be turned on and off. When "ON" is selected, the clock will be displayed. (The clock will keep being displayed even after the power of the audio unit is turned off). When "OFF" is selected, the clock will not be displayed.

- **Format**

Switch the clock display between 24-hour mode and 12-hour clock mode.

**Radio setting:**

Turn the MENU/ENTER dial until the Radio is displayed, and push the MENU/ENTER dial.

The FM station which can be received will be updated.

**Language setting:**

Turn the MENU/ENTER dial until the Language is displayed, and push the MENU/ENTER dial.

Select the appropriate language and push the MENU/ENTER dial. Upon completion, the screen will automatically adapt the language setting.



**Day/Night button:**

Push the Day/Night button to switch the display brightness between the daytime and nighttime modes.

The switches on the audio unit will illuminate in the nighttime mode.



**MEDIA button:**

Push the MEDIA button to play a compatible device when it is connected.

Each time the MEDIA button is pushed, the audio source will change.

**Radio operation**

**Frequency range and step change:**

To change the frequency range and step specification of the radio, perform the following operations.

1. Turn on the audio system.
2. Push the FM or the AM button and select AM or FM mode.

3. Push and hold the SETUP button for more than 3 seconds.
4. After the 3 seconds, keep holding the SETUP button and turn the MENU/ENTER dial counterclockwise until you hear 3 clicks, clockwise until you hear 3 clicks, and then counterclockwise until you hear 3 clicks.
5. Turn the MENU/ENTER dial until "Region" is highlighted, and push the MENU/ENTER dial.
6. Select an appropriate region from the following options:
  - EUR
  - GOM Pacific
  - GOM S. America
7. To apply the setting, turn off the audio system, place the ignition switch in the "OFF" position, and then place the ignition switch back in the "ON" position.



**AM/FM buttons:**

When the AM or the FM button is pushed while the audio system is off, the audio system will turn on and the radio will turn on.

When the AM or the FM button is pushed while another audio source is playing, the other audio source will turn off and the radio will turn on.



To change the radio bands, push the FM button until the desired band appears.



FM 1 → FM 2 → FM 1

When the AM or the FM button is pushed for more than 1.5 seconds, the six stations with the strongest signals are stored in the preset (1 to 6) buttons of the band. During the search, a notification message appears on the display

and the sound is muted until the operation is complete. Once completed, the radio selects preset button.

  **Seek/track buttons:**

Push  or  button briefly to manually change the frequency.



To adjust the broadcasting station frequency automatically, push and hold the  or  button. When the system detects a broadcasting station, it will stop at the station.

      **Station memory buttons:**

During radio reception, pushing the station memory button for less than 2 seconds will select the stored radio station.

The audio system can store up to 12 FM station frequencies (6 in each of FM 1 and FM 2 ) and 6 AM station frequencies.

To store the station frequency manually:

1. Tune to the desired broadcasting station frequency by using the Seek/track buttons.
2. Push and hold a station memory button  -  until a beep sounds. (The radio mutes when the memory button is pushed.)
3. The channel indicator will display and the radio mute disengages, indicating that the memory is stored properly.
4. Perform steps 1 - 3 for all other memory buttons.

If the battery cable is disconnected, or if the audio fuse blows, the station memory will be erased. In such a case, reset the desired stations.

### Radio Data System (RDS) operation (if equipped):

The RDS is a system through which encoded digital information is transmitted by FM radio stations in addition to the normal FM radio broadcasting. The RDS provides information services such as station name, traffic information, or news.

#### NOTE:

**In some countries or regions, some of these services may not be available.**

#### Alternative Frequency (AF) mode

The AF mode operates in the FM (radio) mode. The AF function compares signal strengths and selects the station with the optimum reception conditions for the currently tuned-in station.

#### RDS functions

When an RDS station is tuned in with seek or manual tuning, the RDS data is received and the Programme Service (PS) name is displayed.

#### CD player operation

##### Loading:

Insert a CD into the slot with the label side facing up. The CD will be guided automatically into the slot and will start playing. After loading the CD, the number of tracks and the playtime will appear on the display.



#### CAUTION:

**Do not force the CD into the slot. This could damage the player.**

#### NOTE:

- The CD player accepts normal audio CDs or CDs containing MP3/WMA files.
- The audio unit will automatically detect if a CD containing MP3/WMA files is inserted, and "MP3CD" will be indicated.
- An error notification message will be displayed when inserting an incompatible disc type (e.g. DVD), or if the player cannot read the CD. Eject the disc and insert another disc.

 **MEDIA button:**

To change to the CD mode, push the MEDIA button with a CD inserted until the CD mode is selected.



#### List view:

While the track is being played, push the MENU/ENTER dial to display the available tracks in a listed view mode. To select a track from the list, turn the MENU/ENTER dial then push MENU/ENTER dial.





#### Quick search:

In the list view mode, a quick search can be performed to find a track from the list. Push the A-Z button, turn the MENU/ENTER dial to the first alphabetic letter of the song title and then push the MENU/ENTER dial. When found, a list of the available songs will be displayed. Select, and push the MENU/ENTER dial to play the preferred track.

  **Seek/track button:**

Push and hold the  or  button to fast forward or rewind through the track. When the button is released, the track will play at normal playing speed.

Track up/down:

Pushing the  or  button once, the track will skip forward to the next track or backward to the beginning of the current track. Push the  or  button more than once to skip through the tracks.

#### Folder browsing:

If the recorded media contains folders with music files, pushing the  or  button will play in sequence the tracks of each folder.

To select a preferred folder:

1. Push the MENU/ENTER dial or the Back button and a list of tracks in the current folder is displayed.
2. Push the Back button.
3. Turn the MENU/ENTER dial for the preferred folder.
4. Push the MENU/ENTER dial to access the folder. Push the MENU/ENTER dial again to start playing the first track or turn the MENU/ENTER dial, and push the MENU/ENTER dial to select another track.

If the current selected folder contains sub folders, push the MENU/ENTER dial, a new screen with a list of sub folders will be displayed. Turn the MENU/ENTER dial for the sub folder then push the MENU/ENTER dial to select. Select the root folder item when songs are recorded additionally in the root folder.

To return to the previous folder screen, push the Back button.

#### **RPT-MIX button:**

When the RPT-MIX button is pushed while a CD is playing, the play mode will change as follows:

CD:

DISC REPEAT → TRACK REPEAT → DISC RANDOM → DISC REPEAT

CD with MP3/WMA:

DISC REPEAT → FOLDER REPEAT → TRACK REPEAT → DISC RANDOM → FOLDER RANDOM → DISC REPEAT

DISC REPEAT:

All the tracks on the selected CD will play repeatedly in sequential order.

FOLDER REPEAT (CD with MP3 or WMA only):

All the tracks in the selected folder will play repeatedly in sequential order.

TRACK REPEAT:

The selected track will play repeatedly.

DISC RANDOM:

All the tracks on the selected CD will play in random order.

FOLDER RANDOM (CD with MP3 or WMA only):

All the tracks in the selected folder will play repeatedly in random order.

#### **DISP button:**

While a CD with recorded music information tags (CD-text/ID3-text tags) is being played, the title of the played track is displayed when available.

When the DISP button is pushed repeatedly, further information about the track can be displayed along with the track title as follows:

Track time → Artist name → Album title → Track time

Track details:

Pushing and holding the DISP button will turn the display into a detailed overview. Push the

Back button to return to the previous screen.

#### **CD eject button:**

When the CD eject button is pushed while the ignition switch is placed in the "ON" or "ACC" position, the CD will be ejected.

If a CD is ejected by pushing the CD eject button, and it is not taken out from the loading slot within 20 seconds, the CD will automatically be reloaded to the slot to protect the CD.

#### USB (Universal Serial Bus) connection port



##### USB device main operation:

The USB connection port is located on the lower part of the instrument panel. See "USB (Universal Serial Bus) connection port" (P.4-74). Connect a USB memory device into the connection port. The USB memory device will be activated automatically.

Refer to your device manufacturer's owner information regarding the proper use and care of the device.

If the system has been turned off while the USB memory device was playing, pushing the Power/VOL dial will start the USB memory device.

The following operations are identical to the audio main operation of the Compact Disc (CD) operation. For details, see "CD player operation" (P.4-54).

- List view
- Quick search
-   (Seek/track)
- MIX (Random play)

- RPT (Repeat track)
- Folder browsing

#### **MEDIA MEDIA button:**

To operate the USB memory device, push the MEDIA button repeatedly until the USB mode is selected.

#### **DISP DISP button:**

While a track with recorded music information tags (ID3-tags) is being played, the title of the played track is displayed.

When the DISP button is pushed repeatedly, further information about the track can be displayed along with the track title as follows:

Track time → Artist → Album → Track time

Track details:

Pushing and holding the DISP button will turn the display into a detailed overview. Push the Back button to return to the display for the main display mode.

### iPod player operation

#### **Connecting iPod:**

Connect the iPod to the USB connection port using the USB cable that came with your iPod.

The USB connection port is located on the lower part of the instrument panel. See "USB (Universal Serial Bus) connection port" (P.4-74).

When the iPod is connected to the vehicle, the iPod music library can only be operated by the vehicle audio controls.

\* iPod and iPhone are a trademark of Apple Inc., registered in the U.S. and other countries.

#### **Compatibility:**

The system unit shall be compatible with all devices (past and future) supporting Apple Accessory Protocol on USB link.

It includes (and not limited to):

- iPod Generation 5 devices
- iPod Classic I and II (Generation 6 and 7)
- iTouch Generation OS 1, 2, 3, 4 and next
- iPhone Generation OS 1, 2, 3, 4 and next
- iPod Nano (1G, 2G, 3G)
- iPad 1, 2 and 3

#### **NOTE:**

**This audio system do not support iPad charging.**

#### **MEDIA MEDIA button:**

To operate the iPod, push the MEDIA button repeatedly until the USB (iPod) mode is selected and then push the MENU/ENTER dial.

#### **iPod main operation:**

Interface:

The interface for iPod operation shown on the audio system display is similar to the iPod interface. Use the MENU/ENTER dial to play a track on the iPod.

The following items can be chosen from the menu list screen.

- Playlists
- Artists
- Albums
- Tracks
- More

For further information about each item, see the iPod owner's manual.

The following operations are identical to the

audio main operation of the Compact Disc (CD) operation. For details, see "CD player operation" (P.4-54).

- List view
- Quick search
-  (Seek/track)
- MIX (Random play)
- RPT (Repeat track)
- Folder browsing

#### **DISP DISP button:**

While a track with recorded music information tags (ID3-tags) is being played, the title of the played track is displayed.

When the DISP button is pushed repeatedly, further information about the track can be displayed along with the track title as follows:

Track time → Artist → Album → Track time

Track details:

Pushing and holding the DISP button will turn the display into a detailed overview. To return to the main display, push the Back button.

### AUX device player operation

The AUX jack is located on lower part of the instrument panel. See "AUX (auxiliary) input jack" (P.4-75). The AUX input jack accepts any standard analog audio input such as from a portable cassette tape/CD player, MP3 player or laptop computer.

NISSAN strongly recommends using a stereo mini plug cable when connecting your music device to the audio system. Music may not play properly when a monaural cable is used.



**MEDIA MEDIA button:**

To switch to the AUX mode, push the MEDIA button repeatedly until the AUX mode is selected.

**FM-AM RADIO WITH COMPACT DISC (CD) PLAYER (Type D)**

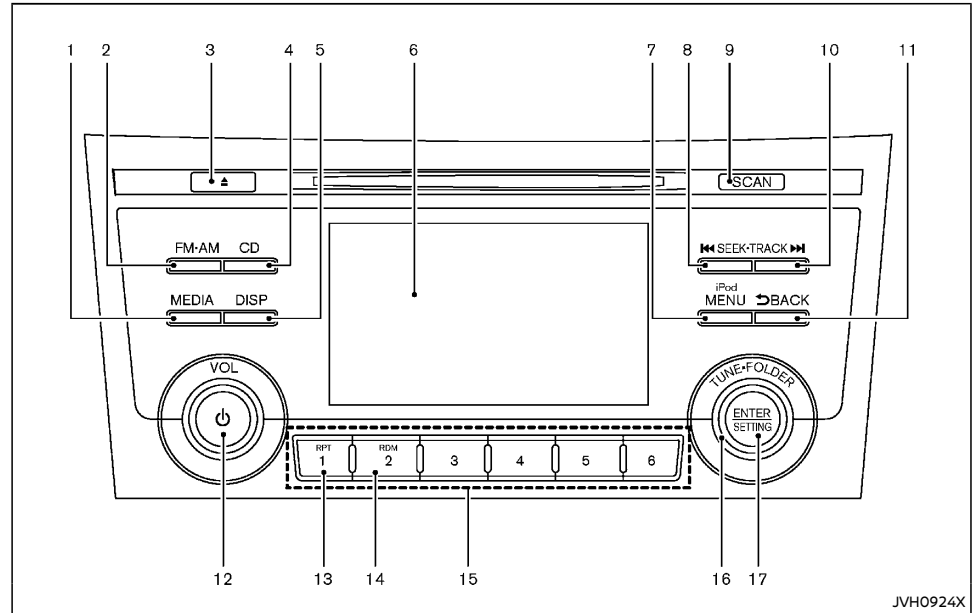

- |                               |                                      |
|-------------------------------|--------------------------------------|
| 1. MEDIA button               | 9. SCAN tuning button                |
| 2. FM-AM button               | 10. SEEK-TRACK (fast forward) button |
| 3. CD eject button            | 11. BACK button                      |
| 4. CD button                  | 12. Power/VOL (volume) dial          |
| 5. DISP (display) button      | 13. RPT (repeat) button              |
| 6. Display screen             | 14. RDM (random) button              |
| 7. iPod MENU button           | 15. Station memory buttons           |
| 8. SEEK-TRACK (rewind) button | 16. TUNE-FOLDER dial                 |

## 17. ENTER/SETTING button

### Audio main operation

#### Head unit:

The auto loudness circuit enhances the low and high frequency ranges automatically.

#### Power/VOL dial:

The power of the audio system can be turned on when the ignition switch is placed in the "ON" or "ACC" position. Push the power/VOL dial while the system is off to turn on the last audio source, which was playing immediately before the system was turned off. While the system is on, pushing the power/VOL dial turns the system off.

Turn the power/VOL dial to adjust the volume.

#### Audio settings:

The settings screen will appear when pushing the ENTER/SETTING button.

The following items are available in the settings screen.

- Bluetooth

It is possible to set the Bluetooth® settings. For details of the Bluetooth® settings, see "Bluetooth® audio player operation" (P.4-62).

- Bass, Treble, Balance and Fade

Controls the sound of the audio system. Balance adjusts the sound between the left and right speakers. Fade adjusts the sound between the front and rear speakers.

Select the "Bass", "Treble", "Balance" or "Fade" using the TUNE-FOLDER dial and then push the ENTER/SETTING button. Turn the TUNE-FOLDER dial to adjust the Bass, Treble, balance and Fade of the screen to the preferred level.

- Brightness and Contrast  
Adjust the brightness and contrast of the screen.  
Select the "Brightness" or "Contrast" using the TUNE-FOLDER dial and then push the ENTER/SETTING button. Turn the TUNE-FOLDER dial to adjust the brightness and contrast of the screen to the preferred level.
- Clock Adjust  
Adjust the clock according to the following procedure.

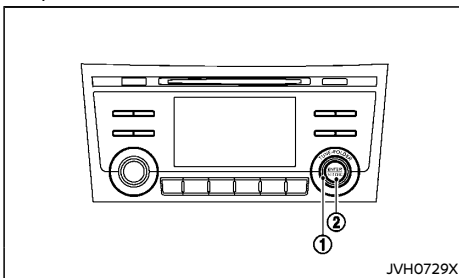

- 1) Select "Clock Adjust" using the TUNE-FOLDER dial ① and then push the ENTER/SETTING button ②.
  - 2) Adjust the hour with the TUNE-FOLDER dial ① and then push the ENTER/SETTING button ②.
  - 3) Adjust the minute with the TUNE-FOLDER dial ① and then push the ENTER/SETTING button ②.
- 24 hour clock is not available.
- On-Screen Clock  
When this item is turned on, a clock is always displayed in the upper right corner of the screen.

Select the "On-Screen Clock" using the TUNE-FOLDER dial and then push the ENTER/SETTING button. You can toggle between ON and OFF using the TUNE-FOLDER dial.

- RDS Display  
RDS (radio data system) information can be shown on the display. Select "RDS Display" using the TUNE-FOLDER dial and then push the ENTER/SETTING button. You can toggle between ON and OFF using the TUNE-FOLDER dial.
- Speed Sensitive Vol.  
To change the Speed Sensitive Volume (Speed Sensitive Vol.) level from off (0) to 5, turn the TUNE-FOLDER dial.
- AUX Vol.  
Controls the volume level of incoming sound when an auxiliary device is connected to the system. Choose a setting between 1 and 3 or choose 0 to disable the feature entirely.
- Language Select  
The language settings can be changed.  
Select "Language Select" using the TUNE-FOLDER dial and then push the ENTER/SETTING button. Use the TUNE-FOLDER dial to select the preferred language.

#### **DISP** DISP button:

- Model without Around View Monitor  
Display of the screen can be turned off by pushing the DISP button. You can still listen to music that is being played back even while the screen display is turned off. If you want to display the screen again, push the DISP button once more. Pushing some of the audio source buttons will also turn the screen back on and display the screens of

the corresponding sources.

- Model with Around View Monitor

The Around View Monitor can be displayed by pushing the DISP button. To display the audio screen again, push the DISP button repeatedly. Pushing some of the audio source buttons can also display the audio screen. For details about the Around View Monitor, see "Around View Monitor" (P.4-13).

#### **MEDIA** MEDIA button:

Pushing the MEDIA button will switch the audio source as follows:

USB/iPod → Bluetooth → AUX → USB/iPod

#### Radio operation

#### **FM•AM** FM•AM button:

Pushing the FM•AM button will change the band as follows:

AM → FM1 → FM2 → AM

#### **TUNE (Tuning):**

Turn the radio TUNE-FOLDER dial for manual tuning.

#### **Radio Data System (RDS):**

RDS stands for Radio Data System, and is a data information service transmitted by some radio stations on the FM band (not AM band) encoded within a regular radio broadcast. Currently, most RDS stations are in large cities, but many stations are now considering broadcasting RDS data.

RDS can display:

- Station name, such as "The Groove".

- Music or programming type such as "Classical", "Country" or "Rock".

#### **SEEK tuning buttons:**

Push the  or  button to tune from low to high or high to low frequencies and to stop at the next broadcasting station.



#### **SCAN** SCAN tuning buttons:

Push the SCAN tuning button to tune from low to high frequencies and stop at each broadcasting station for 5 seconds. Pushing the button again during this 5 seconds period will stop SCAN tuning and the radio will remain tuned to that station.

If the SCAN tuning button is not pushed within 5 seconds, SCAN tuning moves to the next station.

#### **1 to 6** Station memory buttons:

12 stations can be set for the FM band (6 each for FM1 and FM2) and 6 stations can be set for the AM band.

1. Choose the radio band using the FM•AM button.
2. Tune to the desired station using the  or  button or the TUNE-FOLDER dial.
3. Push and hold the desired station preset button **1** to **6** until the radio mutes.
4. The station indicator will then come on and the sound will resume. Memorizing is now complete.
5. Other buttons can be set in the same manner.

If the battery cable is disconnected, or if the fuse opens, the station memory will be erased. In that case, reset the desired stations.

#### CD player operation

Place the ignition switch in the "ON" or "ACC" position. Insert the Compact Disc (CD) into the slot with the label side facing up. The CD will be guided automatically into the slot and start playing.

After loading the CD, the number of tracks on the CD and the play time will appear on the display.

If the radio is already operating, it will automatically turn off and the CD will play.



If the system has been turned off while the CD was playing, pushing the power/VOL dial will start the CD.



#### **CD** CD button:

When the CD button is pushed with the system off and the CD loaded, the system will turn on and the CD will start to play.

When the CD button is pushed with the CD loaded and the radio playing, the radio will automatically be turned off and the CD will start to play.

#### **SEEK/TRACK:**

When the  or  button is pushed for more than 1.5 seconds while the CD is being played, the CD will play while fast forwarding or rewinding. When the button is released, the CD will return to normal play speed.

When the  or  button is pushed for less than 1.5 seconds while the CD is being played, the next track or the beginning of the current track on the CD will be played.

### **RPT button:**

When the RPT button is pushed while the CD is played, the play pattern can be changed as follows:

(CD)

(Normal) ⇔ 1 Track Repeat

(CD with compressed audio files)

(Normal) → 1 Folder Repeat → 1 Track Repeat → (Normal)

### **RDM button:**

When the RDM button is pushed while a CD is being played, the play pattern can be changed as follows:

(CD)

(Normal) ⇔ 1 Disc Random

(CD with compressed audio files)

(Normal) → 1 Disc Random → 1 Folder Random → (Normal)

### **CD eject button:**

When the CD eject button is pushed with the CD loaded, the CD will be ejected.

When this button is pushed while the CD is being played, the CD will be ejected.

**If the CD comes out and is not removed, it will be pulled back into the slot to protect it.**

## USB (Universal Serial Bus) connection port

### **USB main operation:**

The USB connection port is located on the lower part of the instrument panel. See "USB (Universal Serial Bus) connection port" (P.4-74). Connect a USB memory device into the connection port. The USB memory device will be activated automatically.

If the system has been turned off while the USB memory device was playing, pushing the power/VOL dial will start the USB memory device.



### **WARNING:**

**Do not connect, disconnect or operate the USB device while driving. Doing so can be a distraction. If distracted you could lose control of your vehicle and cause an accident or serious injury.**



### **CAUTION:**

- **Do not force the USB device into the USB connection port. Inserting the USB device tilted or up-side-down into the port may damage the port. Make sure that the USB device is connected correctly into the USB connection port. (Some USB devices come with a  mark as a guide. Make sure that the mark is facing the correct direction before inserting the device.)**
- **Do not leave the USB cable in a place where it can be pulled unintentionally. Pulling the cable may damage the port.**

Refer to your device manufacturer's owner information regarding the proper use and care of the device.



### **MEDIA button:**



When the MEDIA button is pushed with the system turned off and the USB device inserted, the system will turn on.

If another audio source is playing and a USB device is inserted, push the MEDIA button repeatedly until the display screen changes to the USB device mode.



### **SEEK-TRACK buttons:**

When the  or  button is pushed for more than 1.5 seconds while a USB device is being played, the USB device will play while forwarding or rewinding. When the button is released, the USB device will return to normal play speed.

When the  or  button is pushed for less than 1.5 seconds while the USB device is being played, the next track or the beginning of the current track on the USB device will be played.

### **Folder selection:**

To change to another folder in the USB device, turn the TUNE-FOLDER dial.

### **RPT button:**

When the RPT button is pushed while the USB device is played, the play pattern can be change as follows.

To change the play mode, push the RPT button repeatedly and the mode will change as follows.

(Normal) → 1 Folder Repeat → 1 Track Repeat → (Normal)

### **RDM** RDM button:

When the RDM button is pushed while a USB device is being played, the play pattern can be changed as follows.

To change the play mode, push the RDM button repeatedly, and the mode will change as follows.

(Normal) → All Random → 1 Folder Random → (Normal)

### **BACK** BACK:

When the BACK button is pushed, it returns to the previous display.

## iPod player operation

### Connecting iPod:

Connect the iPod to the USB connection port using the USB cable that came with your iPod.

The USB connection port is located on the lower part of the instrument panel. See "USB (Universal Serial Bus) connection port" (P.4-74).

Connect the iPod cable to the USB connection port. The battery of the iPod is charged while the cable is connected to the vehicle.

Depending on the version of the iPod, the display on the iPod shows a NISSAN or Accessory Attached screen when the connection is completed. When the iPod is connected to the vehicle, the iPod music library can only be operated by the vehicle audio controls.

\* iPod and iPhone are a trademark of Apple Inc., registered in the U.S. and other countries.



### WARNING:

**Do not connect, disconnect or operate the USB device while driving. Doing so can be a distraction. If distracted you could lose control of your vehicle and cause an accident or serious injury.**



### CAUTION:

- **Do not force the USB device into the USB connection port. Inserting the USB device tilted or up-side-down into the port may damage the port. Make sure that the USB device is connected correctly into the USB connection port. (Some USB devices come with a ⚡ mark as a guide. Make sure that the mark is facing the correct direction before inserting the device.)**
- **Do not leave the USB cable in a place where it can be pulled unintentionally. Pulling the cable may damage the port.**

Refer to your device manufacturer's owner information regarding the proper use and care of the device.

### Compatibility:

The following models are compatible:

- iPod nano 1G (Firmware version 1.3.1 -)
- iPod nano 2G (Firmware version 1.1.3 -)
- iPod nano 3G (Firmware version 1.0.0 -)
- iPod nano 4G (Firmware version 1.0.2 -)
- iPod nano 5G (Firmware version 1.0.1 -)
- iPod nano 6G (Firmware version 1.0 -)
- iPod nano 7G (Firmware version 1.0.0 -)
- iPod 5G (Firmware version 1.2.1 -)
- iPod classic (Firmware version 1.0.0 -)

- iPod Touch (iOS 1.1 -)
- iPod Touch 2G (iOS 2.1.1 -)
- iPod Touch 3G (iOS 3.1 -)
- iPod Touch 4G (iOS 4.1 -)
- iPod Touch 5G (iOS 6.0.0 -)
- iPhone (iOS 1.0.0 - 2.2.1)
- iPhone 3G (iOS 2.1 -)
- iPhone 3GS (iOS 3.0 -)
- iPhone 4/4S (iOS 4.0 -)
- iPhone 5 (iOS 6.0.0 -)

Operations attributable to firmware update by Apple are not guaranteed.

### iPod main operation:

The system operates when the ignition switch is placed in the "ON" or "ACC" position. Push the MEDIA button repeatedly or push the iPod MENU button to switch to the iPod mode.

If the system has been turned off while the iPod was playing, pushing the power/VOL dial will start the iPod.

If another audio source is playing and the iPod is connected, pushing the iPod MENU button or the MEDIA button repeatedly will change to the iPod mode.



When the iPod MENU button is pushed while the iPod is connected, the interface for iPod operation is shown on the audio display. The items on the menu list can be scrolled by turning the TUNE-FOLDER dial while the iPod is operating. To select an item, push ENTER/SETTING button. Items in the iPod menu appear on the display in the following order.



- Now playing
- Playlists
- Artists

- Albums
- Songs
- Podcasts
- Genres
- Composers
- Audiobooks
- Shuffle Songs

For more information about each item, see the iPod Owner's Manual.

**SEEK-TRACK buttons:**

When the  or  button is pushed for more than 1.5 seconds while the iPod is playing, the iPod will play while fast forwarding or rewinding. When the button is released, the iPod will return to the normal play speed.

When the  or  button is pushed for less than 1.5 seconds while the iPod is playing, the next track or the beginning of the current track on the iPod will be played.

**RPT RPT button:**

When the RPT button is pushed while a track is being played, the play pattern can be changed as follows:

(Repeat off) → 1 Track Repeat → All Repeat → (Repeat off)

**RDM RDM button:**

When the RDM button is pushed while a track is being played, the play pattern can be changed as follows:

(Shuffle off) → Track Shuffle → (Shuffle off)

**BACK BACK button:**

The display will return to the previous screen.

**Bluetooth® audio player operation**

If you have a compatible Bluetooth® audio device that is capable of playing audio files, the device can be connected to the vehicle's audio system so that the audio files on the device play through the vehicle's speakers.

**Regulatory information:**

**Bluetooth® trademark:**



Bluetooth® is a trademark owned by Bluetooth SIG, Inc. and licensed to Visteon Corporation.

**Connecting Bluetooth® device:**

To connect your Bluetooth® device to the vehicle, follow the procedure below:

1. Push the ENTER/SETTING button.

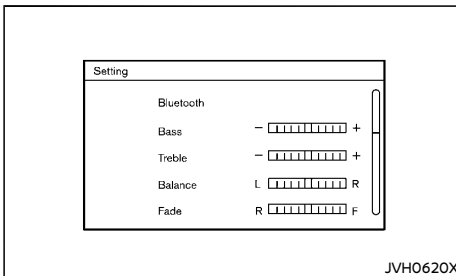

2. Select the "Bluetooth" key.
3. Select the "Add Phone" key. This same screen can be accessed to remove, replace or select a different Bluetooth® device.

4. The system acknowledges the command and asks you to initiate connecting from the Bluetooth® device. The connecting procedure of the Bluetooth® device varies according to each cellular phone model. See the Owner's manual of the Bluetooth® device for details.

**Bluetooth® audio main operation:**

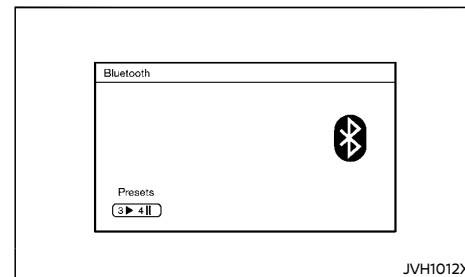

To switch to the Bluetooth® audio mode, push the MEDIA button repeatedly until the Bluetooth® audio mode is displayed on the screen.

The controls for the Bluetooth® audio are displayed on the screen. Use the Preset 3 button to play and use the Preset 4 button to pause.

**Auxiliary input jack**

The AUX input jack is located on the lower part of the instrument panel. See "AUX (auxiliary) input jack" (P.4-75). The AUX input jack accepts any standard analog audio input such as from a portable cassette tape/CD player, MP3 player or laptop computer.

Push the MEDIA button to play a compatible device when it is plugged into the AUX input jack.

NISSAN strongly recommends using a stereo mini plug cable when connecting your music device to the audio system. Music may not play properly when a monaural cable is used.

## FM-AM RADIO WITH COMPACT DISC (CD) PLAYER (Type E)

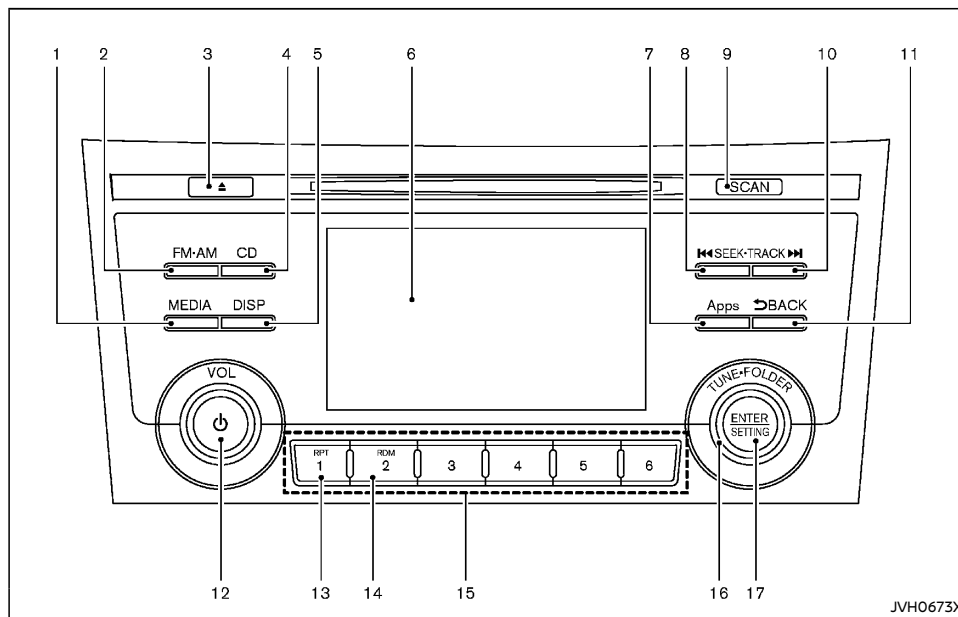

- |                               |                                      |
|-------------------------------|--------------------------------------|
| 1. MEDIA button               | 9. SCAN tuning button                |
| 2. FM-AM button               | 10. SEEK-TRACK (fast forward) button |
| 3. CD eject button            | 11. BACK button                      |
| 4. CD button                  | 12. Power/VOL (volume) dial          |
| 5. DISP (display) button      | 13. RPT (repeat) button              |
| 6. Display screen             | 14. RDM (random) button              |
| 7. Apps button                | 15. Station memory buttons           |
| 8. SEEK-TRACK (rewind) button | 16. TUNE-FOLDER dial                 |

## 17. ENTER/SETTING button

### Audio main operation

The audio system operates when the ignition switch is placed in the "ON" or "ACC" position.

#### Head unit:

The auto loudness circuit enhances the low and high frequency ranges automatically.

#### Power/VOL dial:

Push Power/VOL dial to turn on and off the audio system.

Turn the Power/VOL dial to adjust the volume.

#### Audio settings:

The settings screen will appear when pushing the ENTER/SETTING button.

The following items are available in the settings screen.

- **Bluetooth**

It is possible to set the Bluetooth® settings. For details of the Bluetooth® settings, see "Bluetooth® audio player operation" (P.4-67).

- **Bass, Treble, Balance and Fade**

Controls the sound of the audio system. Balance adjusts the sound between the left and right speakers. Fade adjusts the sound between the front and rear speakers.

Select the "Bass", "Treble", "Balance" or "Fade" using the TUNE-FOLDER dial and then push the ENTER/SETTING button. Turn the TUNE-FOLDER dial to adjust the Bass, Treble, balance and Fade of the screen to the preferred level.

- **Brightness and Contrast**

Adjust the brightness and contrast of the screen.

Select the "brightness" or "contrast" using

the TUNE-FOLDER dial and then push the ENTER/SETTING button. Turn the TUNE-FOLDER dial to adjust the brightness and contrast of the screen to the preferred level.

- **Clock Adjust**

Adjust the clock according to the following procedure.

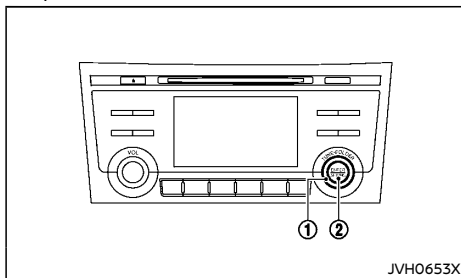

1) Select "Clock Adjust" using the TUNE-FOLDER dial ① and then push the ENTER/SETTING button ②.

2) Adjust the hour with the TUNE-FOLDER dial ① and then push the ENTER/SETTING button ②.

3) Adjust the minute with the TUNE-FOLDER dial ① and then push the ENTER/SETTING button ②.

24 hour clock is not available.

- **On-Screen Clock**

When this item is turned on, a clock is always displayed in the upper right corner of the screen.

Select the "On-Screen Clock" using the TUNE-FOLDER dial and then push the ENTER/SETTING button. You can toggle between ON and OFF using the TUNE-FOLDER dial.

- **RDS Display (if equipped)**

RDS (radio data system) information can be shown on the display. Select "RDS Display" using the TUNE-FOLDER dial and then push the ENTER/SETTING button. You can toggle between ON and OFF using the TUNE-FOLDER dial.

- **Speed Sensitive Vol.**

To change the Speed Sensitive Volume (Speed Sens Vol.) level from off (0) to 5, turn the TUNE-FOLDER dial.

- **AUX Vol.**

Controls the volume level of incoming sound when an auxiliary device is connected to the system. Choose a setting between 1 and 3 or choose 0 to disable the feature entirely.

- **Language Select**

The language settings can be changed.

Select "Language Select" using the TUNE-FOLDER dial and then push the ENTER/SETTING button. Use the TUNE-FOLDER dial to select the preferred language.

#### **DISP** DISP button:

Display of the screen can be turned off by pushing the DISP button. You can still listen to music that is being played back even while the screen display is turned off. If you want to display the screen again, push the DISP button once more. Pushing some of the audio source buttons will also turn the screen back on and display the screens of the corresponding sources.



#### **MEDIA button:**

Pushing the MEDIA button will switch the audio source as follows:

USB/iPod → Bluetooth → AUX → USB/iPod

#### **Apps button:**

The Apps button launches the Smartphone Integration mode. See "NissanConnect App smartphone integration" (P.4-73).

#### Radio operation

#### **FM-AM button:**

Push the FM-AM button to change the band as follows:

AM → FM1 → FM2 → AM

#### **TUNE (Tuning):**

Turn the radio TUNE-FOLDER dial for manual tuning.



#### **Radio Data System (RDS) (if equipped):**

RDS stands for Radio Data System, and is a data information service transmitted by some radio stations on the FM band (not AM band) encoded within a regular radio broadcast. Currently, most RDS stations are in large cities, but many stations are now considering broadcasting RDS data.

RDS can display:

- Station name, such as "The Groove".
- Music or programming type such as "Classical", "Country" or "Rock".

#### **SEEK-TRACK buttons:**

Push the  or  button to tune from low to high or high to low frequencies and to stop at the next broadcasting station.





#### **SCAN tuning button:**

Push the SCAN tuning button to tune from low to high frequencies and stop at each broadcasting station for 5 seconds. Pushing the button again during this 5 seconds period will stop SCAN tuning and the radio will remain tuned to that station.

If the SCAN tuning button is not pushed within 5 seconds, SCAN tuning moves to the next station.

#### **Station memory buttons:**

12 stations can be set for the FM band (6 each for FM1 and FM2) and 6 stations can be set for the AM band.

1. Choose the radio band using the FM-AM button.
2. Tune to the desired station using the  or , SCAN tuning button or the TUNE-FOLDER dial.
3. Push and hold the desired station preset button  to .
4. The station indicator will then come on. Memorizing is now complete.
5. Other buttons can be set in the same manner.

If the battery cable is disconnected, or if the fuse opens, the station memory will be erased. In that case, reset the desired stations.

#### CD player operation

Place the ignition switch in the "ON" or "ACC" position, and insert the Compact Disc (CD) into the slot with the label side facing up. The CD will be guided automatically into the slot and start playing.

After loading the CD, the number of tracks on the CD and the play time will appear on the display.

If the radio is already operating, it will automatically turn off and the CD will play.



If the system has been turned off while the CD was playing, pushing the Power/VOL dial will start the CD.



#### **CD button:**

When the CD button is pushed with the system off and the CD loaded, the system will turn on and the CD will start to play.

When the CD button is pushed with the CD loaded and the radio playing, the radio will automatically be turned off and the CD will start to play.

#### **SEEK-TRACK buttons:**

When the  or  button is pushed for more than 1.5 seconds while the CD is being played, the CD will play while fast forwarding or rewinding. When the button is released, the CD will return to normal play speed.

When the  or  button is pushed for less than 1.5 seconds while the CD is being played, the next track or the beginning of the current track on the CD will be played.

### **RPT button:**

When the RPT button is pushed while the CD is played, the play pattern can be changed as follows:

(CD)

(Normal) ⇔ 1 Track Repeat

(CD with compressed audio files)

(Normal) → 1 Folder Repeat → 1 Track Repeat → (Normal)

### **RDM button:**

When the RDM button is pushed while a CD is being played, the play pattern can be changed as follows:

(CD)

(Normal) ⇔ 1 Disc Random

(CD with compressed audio files)

(Normal) → 1 Disc Random → 1 Folder Random → (Normal)

### **CD eject button:**

When the CD eject button is pushed with the CD loaded, the CD will be ejected.

When this button is pushed while the CD is being played, the CD will be ejected.

**If the CD comes out and is not removed, it will be pulled back into the slot to protect it.**

## USB (Universal Serial Bus) connection port

### **USB main operation:**

The USB connection port is located on the lower part of the instrument panel. See "USB (Universal Serial Bus) connection port" (P.4-74). Connect a USB memory device into the connection port. The USB memory device will be activated automatically.

If the system has been turned off while the USB memory device was playing, pushing the Power/VOL dial will start the USB memory device.



Refer to your device manufacturer's owner information regarding the proper use and care of the device.

### **MEDIA button:**

When the MEDIA button is pushed with the system off and the USB memory device inserted, the system will turn on.

If another audio source is playing and a USB memory device is inserted, push the MEDIA button repeatedly until the display screen changes to the USB memory device mode.

### **SEEK/TRACK buttons:**

When the  or  button is pushed for more than 1.5 seconds while a USB memory device is being played, the USB memory device will play while forwarding or rewinding. When the button is released, the USB memory device will return to normal play speed.

When the  or  button is pushed for less than 1.5 seconds while the USB memory device is being played, the next track or the beginning of the current track on the USB memory device

will be played.

### **Folder selection:**

To change to another folder in the USB memory device, turn the TUNE-FOLDER dial.

### **RPT button:**

When the RPT button is pushed while the USB memory device is played, the play pattern can be change as follows.

To change the play mode, push the RPT button repeatedly and the mode will change as follows.

(Normal) → 1 Folder Repeat → 1 Track Repeat → (Normal)

### **RDM button:**

When the RDM button is pushed while a USB memory device is being played, the play pattern can be changed as follows.

To change the play mode, push the RDM button repeatedly, and the mode will change as follows.

(Normal) → All Random → 1 Folder Random → (Normal)

## iPod player operation

### **Connecting iPod:**

Connect the iPod to the USB connection port using the USB cable that came with your iPod.

USB connection port is located on the lower part of the instrument panel. Connect the iPod with a USB connection port using the cable. See "USB (Universal Serial Bus) connection port" (P.4-74). The battery of the iPod is charged while the cable is connected to the vehicle.

Depending on the version of the iPod, the

display on the iPod shows a NISSAN or Accessory Attached screen when the connection is completed. When the iPod is connected to the vehicle, the iPod music library can only be operated by the vehicle audio controls.

\* iPod and iPhone are a trademark of Apple Inc., registered in the U.S. and other countries.

Refer to your device manufacturer's owner information regarding the proper use and care of the device.

### Compatibility:

The following models are compatible:

- iPod nano 1G (Firmware version 1.3.1 -)
- iPod nano 2G (Firmware version 1.1.3 -)
- iPod nano 3G (Firmware version 1.0.0 -)
- iPod nano 4G (Firmware version 1.0.2 -)
- iPod nano 5G (Firmware version 1.0.1 -)
- iPod nano 6G (Firmware version 1.0 -)
- iPod nano 7G (Firmware version 1.0.0 -)
- iPod 5G (Firmware version 1.2.1 -)
- iPod classic (Firmware version 1.0.0 -)
- iPod Touch (iOS 1.1 -)
- iPod Touch 2G (iOS 2.1.1 -)
- iPod Touch 3G (iOS 3.1 -)
- iPod Touch 4G (iOS 4.1 -)
- iPod Touch 5G (iOS 6.0.0 -)
- iPhone (iOS 1.0.0 - 2.2.1)
- iPhone 3G (iOS 2.1 -)
- iPhone 3GS (iOS 3.0 -)
- iPhone 4/4S (iOS 4.0 -)
- iPhone 5 (iOS 6.0.0 -)

Operations attributable to firmware update by Apple are not guaranteed.

### MEDIA button:

To switch to the iPod mode, push the MEDIA button until the USB/iPod mode is selected while the ignition switch is placed in the "ON" or "ACC" position.

If another audio source is playing and the iPod is connected, pushing the MEDIA button changes to the iPod mode.

If the system has been turned off while the iPod was playing, pushing the Power/VOL dial button will start the iPod.

When the MEDIA button is pushed while the iPod is connected, the interface for iPod operation is shown on the audio display. The items on the menu list can be scrolled by pushing the SEEK-TRACK (rewind) or SEEK-TRACK (fast forward) button while the iPod is operational. To select an item, push ENTER/SETTING button. Items in the iPod menu appear on the display in the following order.



- Now playing
- Playlists
- Artists
- Albums
- Songs
- Podcasts
- Genres
- Composers
- Audiobooks
- Shuffle Songs

Push the BACK button to return to the previous screen.

For more information about each item, see the iPod Owner's Manual.

### SEEK-TRACK button:

When the  or  button is pushed for more than 1.5 seconds while the iPod is playing, the iPod will play while fast forwarding or rewinding. When the button is released, the iPod will return to the normal play speed.

When the  or  button is pushed for less than 1.5 seconds while the iPod is playing, the next track or the beginning of the current track on the iPod will be played.

### RPT button:

When the RPT button is pushed while a track is being played, the play pattern can be changed as follows:

Repeat Off → 1 Track Repeat → All Repeat → Repeat Off

### RDM button:

When the RDM button is pushed while a track is being played, the play pattern can be changed as follows:

Shuffle Off → Track Shuffle → Shuffle Off

Bluetooth® audio player operation (if equipped)

If you have a compatible Bluetooth® audio device that is capable of playing audio files, the device can be connected to the vehicle's audio system so that the audio files on the device play through the vehicle's speakers.

## Regulatory information:

### Bluetooth® trademark:



Bluetooth® is a trademark owned by Bluetooth SIG, Inc. and licensed to Visteon Corporation.

### Connecting Bluetooth® device:

To connect your Bluetooth® device to the vehicle, follow the procedure below:

1. Push the ENTER/SETTING button.

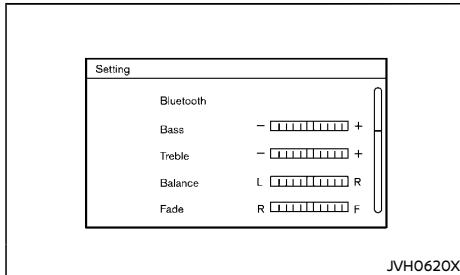

2. Select the "Bluetooth" key.
3. Select the "Add Phone" key. This same screen can be accessed to remove, replace or select a different Bluetooth® device.
4. The system acknowledges the command and asks you to initiate connecting from the Bluetooth® device. The connecting procedure of the Bluetooth® device varies according to each cellular phone model. See the Owner's manual of the Bluetooth® device for details.

### Bluetooth® audio main operation:

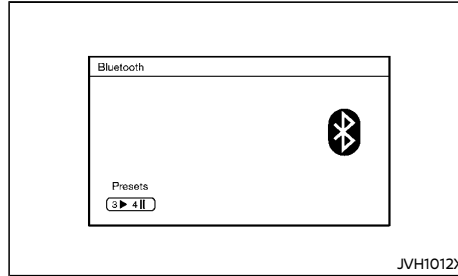

To switch to the Bluetooth® audio mode, push the MEDIA button repeatedly until the Bluetooth® audio mode is displayed on the screen.

The controls for the Bluetooth® audio are displayed on the screen. Use the Preset 3 button to play and use the Preset 4 button to pause.

### AUX device player operation

The AUX input jack is located on the lower part of the instrument panel. See "AUX (auxiliary) input jack" (P.4-75). The AUX audio input jack accepts any standard analog audio input such as from a portable cassette tape/CD player, MP3 player or laptop computer.

NISSAN strongly recommends using a stereo mini plug cable when connecting your music device to the audio system. Music may not play properly when a monaural cable is used.

### **MEDIA** MEDIA:

To switch to the AUX mode, push the MEDIA button until the AUX mode is selected while the ignition switch is placed in the "ON" or "ACC" position.

## FM-AM RADIO WITH COMPACT DISC (CD) PLAYER (Type F)

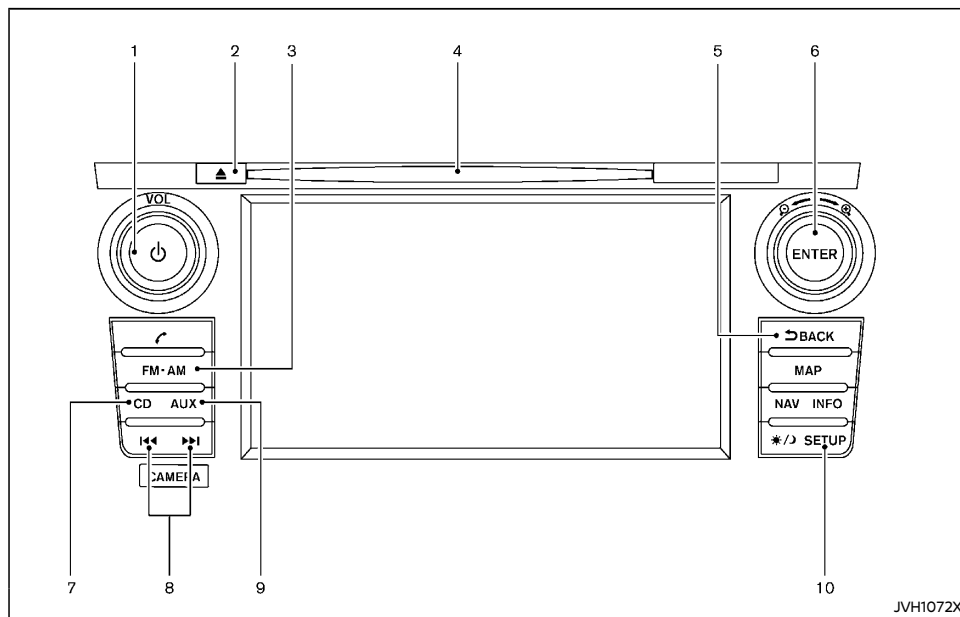

1. Power/VOL (volume) dial
2. Disc eject button
3. FM-AM button
4. Disc insert slot
5. BACK button
6. ENTER/Scroll dial
7. CD button
8. Seek/Track buttons
9. AUX (auxiliary) button
10. SETUP button

### Audio main operation

The audio system operates when the ignition switch is placed in the "ON" or "ACC" position.

#### Power/VOLUME dial:

Push Power/VOLUME dial to turn on and off the audio system.

Turn the Power/VOLUME dial to adjust the volume.

This vehicle may be equipped with Speed Sensitive Volume (SSV) function for audio. When this function is turned on, the audio volume will be adjusted automatically as the vehicle speed changes. For operations to turn on and off the SSV function, see "Audio settings" (P.4-6).

#### Audio settings:

For the operations to adjust the audio settings, see "Audio settings" (P.4-6).

#### Traffic Announcement:

Touch "TA" on the audio screen to turn on or off the Traffic Information setting. When a traffic announcement is received, the Traffic Information will interrupt the music that was playing and informs the driver of the received traffic information.

### Radio operation

The audio system operates when the ignition switch is placed in the "ON" or "ACC" position.

#### Radio band select button:

Push the FM-AM button to change the band as follows:

AM → DAB → FM → AM

If another audio source is playing when the FM-AM button is pushed, the audio source playing will automatically be turned off and

the last radio station played will begin playing.

### Radio tuning:

When in radio mode, the radio can be tuned using the touchscreen. To bring up the visual tuner, touch the "Tune" key on the lower part of the screen. A screen appears with a bar running from low frequencies on the left to high frequencies on the right.

One of the following operations can be used for tuning.

- Touching the bar on the screen
- Touching "◀"/"▶" on the screen
- Turning ENTER/Scroll dial

To return to the regular radio display screen, touch the "OK" key.

### Station List:

When in FM or DAB (if equipped) mode, touch "FM List" or "DAB List" to display the station lists.



### Seek/Track buttons:

When in radio mode, push the Seek/Track buttons to tune from low to high or high to low frequencies and to stop at the next broadcasting station.

### Station memory keys:

Up to six stations can be stored for AM band, and up to twelve stations can be stored for each of the other bands.

1. Choose the radio band using the FM-AM button.
2. Tune to the desired station using manual or seek tuning. Touch and hold any of the desired station memory keys until a beep sound is heard.

For FM and DAB (if equipped), touch the "7-12" key to display the 7 - 12 memory keys.

3. The channel indicator will then come on and the sound will resume. Programming is now complete.

### DAB operation:

In the DAB mode, the following operation keys and information are available.

- DAB List:  
Touch to display the available station list.
- TA:  
Touch this key to turn on and off the TA (Traffic Announcement) mode. When turned on, received TA will interrupt the audio source that is playing.
- Extra chan.:  
The "Extra chan." key will allow access to extra stations transmitted within the group of the currently selected station. If extra stations are not available within the group, the key will not operate.
- Radio text:  
Radio text is shown on the DAB main screen underneath the DAB station name. This displays radio program and song information as determined by the DAB station.

EAS in EAS test (displayed on the screen as a PTY name) is an abbreviation of Emergency Alert System.

Occasionally, in areas of poor DAB signal strength, the full station name in the DAB List and DAB main screen might be distorted. In this situation it may still be possible to listen to the particular radio station, at a reduced level of sound quality, but this is not always possible. This may also be shown in the vehicle information display.

## CD player operation

### Loading disc:

Insert a CD into the slot with the label side facing up. The CD will be guided automatically into the slot and will start playing. If the radio is already playing, it will automatically turn off, and the CD will start playing.



### CAUTION:

**Do not force the compact disc into the slot. This could damage the player.**



### CD CD button:



When the CD button is pushed with the system off and the CD loaded, the system will turn on and the CD will start to play.

When the CD button is pushed with a CD loaded while the radio playing, the radio will be turned off and the CD will start to play.



### Seek/Track button:

When the  or  button is pushed for more than 1.5 seconds while the CD is being played, the CD will play while fast forwarding or rewinding. When the button is released, the CD will return to normal play speed.

When the  or  button is pushed for less than 1.5 seconds while the CD is being played, the next track or the beginning of the current track on the CD will be played. Push the button several times to skip through the tracks on the CD. If the last track on a CD is skipped, the first track on the disc will play. If the last track in a folder of an MP3 CD is skipped, the first track of the next folder will play.

### **CD/MP3/WMA display mode:**

While listening to a CD or an MP3/WMA CD, certain text may be displayed (when a CD encoded with text is being used). Depending on how the CD or MP3/WMA CD is encoded, the text is displayed listing the artist, album and song title. Operation keys are also displayed on the screen.

#### **Mix:**

Touching the "Mix" key while an CD or MP3 CD is playing will alternate the random play pattern as follows:

(CD)

(Normal) → Mix → (Normal)

(CD with compressed audio files)

(Normal) → Random Folder → Random All → (Normal)

#### **Repeat:**

Touching the "Repeat" key while an CD or MP3 CD is playing will alternate the repeat play pattern as follows:

(CD)

(Normal) → Repeat → (Normal)

(CD with compressed audio files)

(Normal) → Repeat Track → Repeat Folder → (Normal)

#### **Browse:**

Touch the "Browse" key to display the titles on the CD in list format. Touch the title of a song in the list to begin playing that song. If an MP3 CD is playing, touching the "Browse" key will also list the folders on the disc. Touch the "Folder Up" key to view the lists in the upper layer. Follow the procedure for selecting a song with the touchscreen to choose a folder.



### **Disc eject button:**

When the Disc eject button is pushed while a CD is loaded, the CD will be ejected.

If the CD is not removed within 10 seconds, the CD will be reloaded.

### **USB (Universal Serial Bus) connection port**

The audio system operates when the ignition switch is placed in the "ON" or "ACC" position.

The USB connection port is located on the lower part of the instrument panel. See "USB (Universal Serial Bus) connection port" (P.4-74). Connect a USB memory device into the connection port. The USB memory device will be activated automatically.

Refer to your device manufacturer's owner information regarding the proper use and care of the device.

#### **USB main operation:**

If another audio source is playing with a USB memory device inserted, push the AUX button until the screen on the display changes to the USB memory mode.

If the system has been turned off while the USB memory device was playing, push the Power/VOLUME dial to restart the USB memory device.

Touch the name of a song on the screen to begin playing that song.

#### **USB screen operation:**

While files on a USB memory device are playing, the play pattern can be altered so that songs are repeated or played randomly.

#### **Mix:**

Touching the "Mix" key on the screen while a USB memory device is playing will alternate the

random play pattern as follows:

(Normal) → Random Folder → Random All → (Normal)

#### **Repeat:**

Touching the "Repeat" key on the screen while a USB memory device is playing will alternate the repeat play pattern as follows:

(Normal) → Repeat Track → Repeat Folder → (Normal)

#### **Browse:**

Touch "Browse" key to display USB interface. Select the songs you wish to play by touching the item on the screen.



#### **Seek/Track buttons:**

Push the Seek/Track (rewind) button while an audio file on the USB memory device is playing to return to the beginning of the current track. Push the button several times to skip backward several tracks.

Push the Seek/Track (fast forward) button while an audio file on the USB memory device is playing to advance one track. Push the button several times to skip forward several tracks. If the last track on the USB memory device is skipped, the first track of the next folder is played.

## iPod player operation

### Connecting iPod:

Connect the iPod to the USB connection port using the USB cable that came with your iPod.

The USB connection port is located on the lower part of the instrument panel. See "USB (Universal Serial Bus) connection port" (P.4-74).

If your iPod supports charging via a USB connection, its battery will be charged while connected to the vehicle with the ignition switch placed in the "ON" or "ACC" position.

### Compatibility:

The following models are compatible:

- iPod 5th Generation (firmware version 1.2.3 or later)
- iPod Classic (firmware version 1.1.1 or later)
- iPod Touch (firmware version 2.0.0 or later)\*
- iPod nano - 1st generation (firmware version 1.3.1 or later)
- iPod nano - 2nd generation (firmware version 1.1.3 or later)
- iPod nano - 3rd generation (firmware version 1.1.3 or later)
- iPod nano - 4th generation (firmware version 1.0.4 or later)
- iPod nano - 5th generation (firmware version 1.0.1 or later)

\* Some features of this iPod may not be fully functional.

Make sure that your iPod firmware is updated to the version indicated above.

### iPod main operation:

If the system has been turned off while the iPod was playing, pushing the Power/VOLUME dial will start the iPod.

If another audio source is playing with an iPod connected, push the AUX button until the screen on the display changes to the iPod mode.

Refer to your device manufacturer's owner information regarding the proper use and care of the device.

### Interface operation:

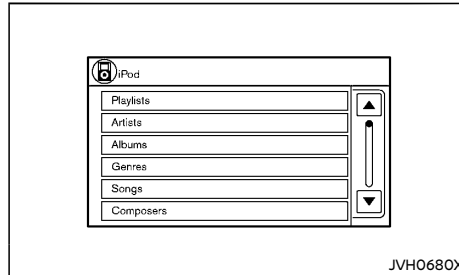

The interface for iPod operation shown on the vehicle's audio system display screen is similar to the iPod interface. Use the touchscreen, BACK button or the ENTER/Scroll dial to navigate the menus on the screen.

When the iPod is playing, touch the "Menu" key to bring up the iPod interface.

Depending on the iPod model, the following items may be available on the menu list screen. For further information about each item, see the iPod Owner's Manual.

- Playlists

- Artists
- Albums
- Genres
- Songs
- Composers
- Audiobooks
- Podcasts

### Scrolling menus:

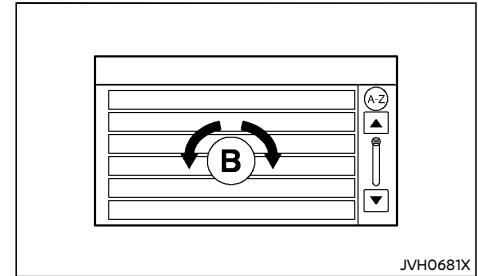

While navigating long lists of artists, albums or songs in the music menu, it is possible to scroll the list by the first character in the name. To activate character indexing, touch the "A-Z" key in the upper right corner of the screen. Turn the ENTER/Scroll dial to choose the number or letter to jump to in the list and then push the ENTER/Scroll dial.

If no character is selected after thirty seconds, the display returns to normal.

### Random and repeat play mode:

While the iPod is playing, the play pattern can be altered so that songs are repeated or played randomly.



### Mix:

Touching the "Mix" key on the screen while an iPod is playing will alternate the random play pattern as follows:

(Normal) → Shuffle Songs → (Normal)



### Repeat:



Touching the "Repeat" key on the screen while an iPod is playing will alternate the repeat play pattern as follows:

(Normal) → Repeat Song → (Normal)



### Seek/Track buttons:

When the  or  button is pushed for less than 1.5 seconds while the iPod is playing, the next track or the beginning of the current track will be played. Push the button several times to skip through the tracks.

Push and hold the  or  button for 1.5 seconds while a track is playing to reverse or fast forward the track being played. The track plays at an increased speed while reversing or fast forwarding. When the button is released, the track returns to normal play speed.

### Bluetooth® audio player operation

If you have a compatible Bluetooth® audio device that is capable of playing audio files, the device can be connected to the vehicle's audio system so that the audio files on the device play through the vehicle's speakers

### Bluetooth® trademark:



Bluetooth® is a trademark owned by Bluetooth SIG, Inc. and licensed to Robert Bosch GmbH.

### Connecting Bluetooth® audio:

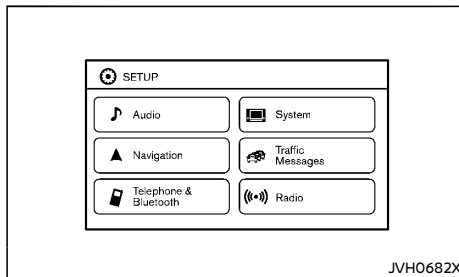

#### Example

To connect your Bluetooth® audio device to the vehicle, follow the procedure below:

1. Push the SETUP button.
2. Select the "Telephone & Bluetooth" key.
3. Select the "Pair New Device" key.
4. The system acknowledges the command and asks you to initiate connecting from the phone handset. The connecting procedure of the cellular phone varies according to each cellular phone model. See the Bluetooth® device Owner's Manual for details.

### Bluetooth® audio player main operation:

To switch to the Bluetooth® audio mode, push the AUX button repeatedly until the Bluetooth® audio mode is displayed on the screen.

The controls for the Bluetooth® audio are displayed on the screen.

### AUX device player operation

The AUX input jack is located on the lower part of the instrument panel. See "AUX (auxiliary) input jack" (P.4-75). The AUX audio input jack accepts any standard analog audio input such as from a portable cassette tape/CD player, MP3 player or laptop computer.

NISSAN strongly recommends using a stereo mini plug cable when connecting your music device to the audio system. Music may not play properly when a monaural cable is used.

### AUX button:

To switch to the AUX mode, push the AUX button until the AUX mode is selected while the ignition switch is placed in the "ON" or "ACC" position.

### NISSANCONNECT APP SMARTPHONE INTEGRATION (if equipped)

This vehicle is equipped with Smartphone Integration technology. This allows many compatible Smartphone applications to be displayed and easily controlled through the vehicle's touchscreen.

#### NOTE:

**A compatible smartphone and registration is required to use mobile applications or to access connected features of certain vehicle applications.**

## Registering with NissanConnect App

To use the Smartphone Integration feature, it is necessary for the user to register. In order to register, visit the NissanConnect website for more information and to sign up. Once registered, download the NissanConnect Mobile App from your compatible phone's application download source and then log into the application.

## Connecting phone

To use this feature, a compatible smartphone must be connected via Bluetooth® or USB to the vehicle. For the Bluetooth® connecting procedure, see "Bluetooth® audio player operation" (P.4-67) or "Bluetooth® audio player operation" (P.4-73).

### NOTE:

- For Apple iPhone, NissanConnect Apps REQUIRES the phone to be plugged in via USB.
- For Vehicles without Navigation, Apple iPhone must be paired via Bluetooth® for NissanConnect Apps to function.
- For Android phones, NissanConnect Apps REQUIRES the phone to be paired via Bluetooth®.

## Application download

Once connected, the NissanConnect Mobile App will search your phone to determine which compatible applications are currently installed. The vehicle will then download the in-vehicle interface for each of these compatible applications. Once downloaded, the user can access many smartphone Applications through the vehicle touchscreen by pushing the INFO button followed by touching the "My Apps" key. For more information on application availability visit the NissanConnect website.

## 4-74 Monitor, air conditioner, audio and phone system

## USB (Universal Serial Bus) CONNECTION PORT



### WARNING:

**Do not connect, disconnect or operate the USB device while driving. Doing so can be a distraction. If distracted you could lose control of your vehicle and cause an accident or serious injury.**



### CAUTION:

- Do not force the USB device into the USB connection port. Inserting the USB device tilted or up-side-down into the port may damage the port. Make sure that the USB device is connected correctly into the USB connection port.
- Do not grab the USB connection port cover (if equipped) when pulling the USB device out of the port. This could damage the port and the cover.
- Do not leave the USB cable in a place where it can be pulled unintentionally. Pulling the cable may damage the port.

Refer to your device manufacturer's owner information regarding the proper use and care of the device.

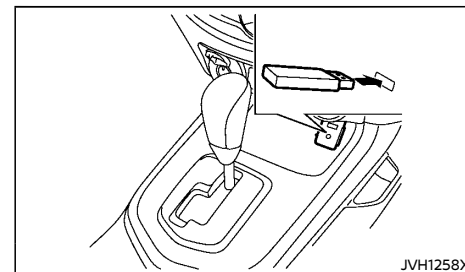

Except for front bench seat models

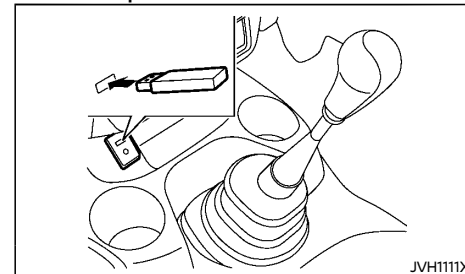

For front bench seat models

The USB connection port is located on the lower part of the instrument panel. Insert USB devices or iPod connectors into this port.

## AUX (auxiliary) INPUT JACK

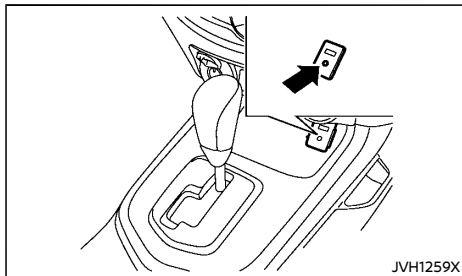

Except for front bench seat model

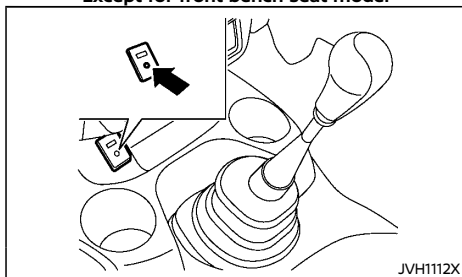

For front bench seat model

The AUX input jack is located on the lower part of the instrument panel. Compatible audio devices, such as some MP3 players, can be connected to the system through the AUX input jack.

Before connecting a device to a jack, turn off the power of the portable device.

With a compatible device connected to the jack, push the corresponding button (depends on the audio system) repeatedly until the display switches to the AUX mode.

NISSAN strongly recommends using a stereo

mini plug cable when connecting your music device to the audio system. Music may not play properly when a monaural cable is used.

## CD/USB MEMORY CARE AND CLEANING

### CD

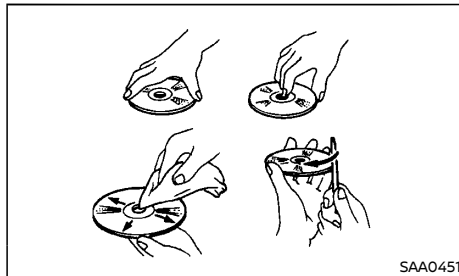

- Handle a disc by its edges. Never touch the surface of the disc. Do not bend the disc.
- Always place the discs in the storage case when they are not being used.
- To clean a disc, wipe the surface from the center to the outer edge using a clean, soft cloth. Do not wipe the disc using a circular motion.
- Do not use a conventional record cleaner or alcohol intended for industrial use.
- A new disc may be rough on the inner and outer edges. Remove the rough edges by rubbing the inner and outer edges with the side of a pen or pencil as illustrated.

## USB memory

- Do not place heavy objects on the USB memory.
- Do not store the USB memory in highly humid locations.
- Do not expose the USB memory to direct sunlight.
- Do not spill any liquids on the USB memory. Refer to the USB memory Owner's Manual for details.

## AUDIO CONTROL STEERING SWITCH (if equipped)

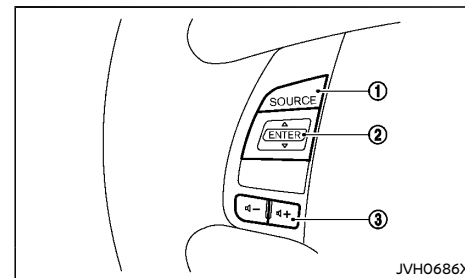

1. SOURCE select switch
2. Tuning switch
3. Volume control switches

### Tuning switch

Push the switch upward or downward to select a channel, track or folder when they are listed on the display.

## ANTENNA

### RADIO:

- Pushing DOWN ▼ /UP ▲ shorter  
Next or previous preset channel
- Pushing DOWN ▼ /UP ▲ longer  
Next or previous station/channel

### CD:

- Pushing DOWN ▼ /UP ▲ shorter  
Next track or the beginning of the current track (the previous track if the button is pushed immediately after the current track starts playing)
- Pushing DOWN ▼ /UP ▲ longer  
Forward or rewind

### CD with MP3/WMA, iPod, USB device or Bluetooth® audio (if equipped):

- Pushing DOWN ▼ /UP ▲ shorter  
Next track or the beginning of the current track (the previous track if the button is pushed immediately after the current track starts playing)
- Pushing DOWN ▼ /UP ▲ longer  
Folder change (When the last folder is changed, the next disc will be selected.)

### SOURCE select switch

Push the SOURCE select switch to change the mode to available audio source.

### Volume control switches

Push the  (+) or  (-) button to increase or decrease the volume.

### ROOF ANTENNA

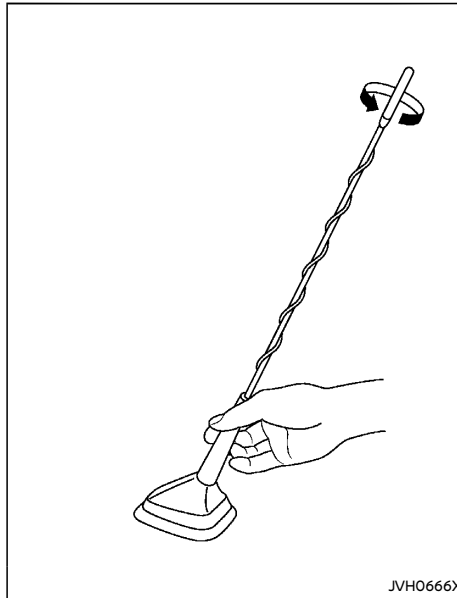

The antenna can be removed if necessary.

Hold the bottom of the antenna and remove by turning counterclockwise.

To install the antenna, turn the antenna clockwise and tighten.



### CAUTION:

To avoid damaging or deforming the antenna, be sure to remove the antenna under the following conditions.

- The vehicle enters an automatic car wash.
- The vehicle enters a garage with a low ceiling.
- The vehicle is covered with a car cover.

### PILLAR ANTENNA

Adjust the antenna length for the best reception. A fully extended antenna is usually best for distant reception.



### CAUTION:

To prevent damage, be sure that the antenna is retracted before the vehicle enters an automatic car wash.

## CAR PHONE AND CB RADIO

When installing a CB, ham radio or a car phone in your vehicle, be sure to observe the following cautions, otherwise the new equipment may adversely affect the Engine Control System and other electronic parts.

### CAUTION:

- Keep the antenna as far away as possible from the Electronic Control Module.
- Keep the antenna wire at least 20 cm (8 in) away from the Engine Control harnesses. Do not route the antenna wire next to any harnesses.
- Adjust the antenna standing wave ratio as recommended by the manufacturer.
- Connect the ground wire from the radio chassis to the body.
- For details, consult a NISSAN dealer.

## Bluetooth® HANDS-FREE PHONE SYSTEM (Type A)

\*This Bluetooth® Hands-Free Phone System is for models without audio system or models with type B audio (if equipped).

### WARNING:

- Use a phone after stopping your vehicle in a safe location. If you have to use a phone while driving, exercise extreme caution at all times so full attention may be given to vehicle operation.
- If you find yourself unable to devote full attention to vehicle operation while using the phone, pull off the road to a safe location and stop your vehicle before doing so.

### CAUTION:

To avoid draining the vehicle battery, use a phone after starting the engine.

Bluetooth® is a wireless radio communication standard. This system offers a hands-free facility for your cellular phone to enhance driving comfort.

To use the Bluetooth® Hands-Free Phone System, your cellular phone must first be setup. For details, see "Bluetooth® settings" (P.4-78). Once it has been setup, the hands-free mode is automatically activated on the registered cellular phone (via Bluetooth®) when it comes into range.

A notification message appears on the audio display when the phone is connected, when an incoming call is being received, as well as when a call is initiated.

When a call is active, the Instrument panel mounted control buttons (if equipped), microphone, and steering wheel mounted control buttons enable hands-free communication.

If the audio system is in use at the time, the radio, CD, iPod, USB audio, Bluetooth® audio or AUX source mode will be muted and will stay muted until the active call has ended.

The Bluetooth® system may not be able to connect with your cellular phone for the following reasons:

- The cellular phone is too far away from the vehicle.
- The Bluetooth® mode on your cellular phone has not been activated.
- Your cellular phone has not been paired with the Bluetooth® system of the audio unit.
- The cellular phone does not support Bluetooth® technology.

### NOTE:

- For details, see your cellular phone's Owner's Manual.
- For assistance with your cellular phone integration, please visit your local NISSAN dealer.

## REGULATORY INFORMATION

### Bluetooth® trademark



Bluetooth® is a trademark owned by Bluetooth SIG, Inc. and licensed to Visteon Corporation.

### CE statement

Hereby Visteon Corp. declares that this system is in compliance with the essential requirements and other relevant provisions of Directive 1999/5/EC.



### NOTE:

The audio system only supports Bluetooth® devices with AVRCP (Audio Video Remote Control Profile) version 1.3, or 1.0 or earlier.

### CONTROL BUTTONS AND MICROPHONE Instrument panel (if equipped):

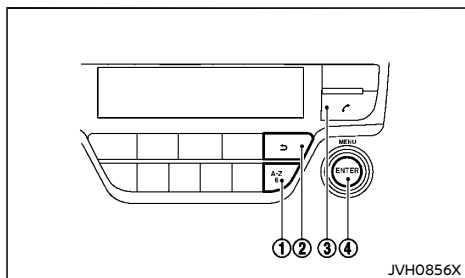

1. Phonebook quick search button

2. Back button
3. Phone button
4. MENU/ENTER dial

### Steering wheel mounted control:

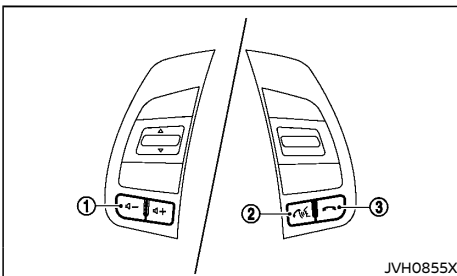

1. Volume control -/ + buttons  
Push the buttons to increase or decrease the volume of the speakers.
2. Phone send button
  - Accept an incoming call by pushing once.
  - Redial the last outgoing call by pushing the button for more than 2 seconds.
3. Phone end button
  - Reject an incoming call by pushing the button during an incoming call.
  - End an active call by pushing the button once.

### Microphone:

Microphone is located near the map lights.

## Bluetooth® SETTINGS

### Pairing device

Enter the phone setup menu via the button on the instrument panel or the button on the steering wheel, select the "Bluetooth" key, and then check if the Bluetooth® is set to on. (If not push the MENU/ENTER dial to turn it on.)

To setup the Bluetooth® system to pair (connect or register) your preferred cellular phone, follow the following procedure.

1. To pair a device, select the "Scan device" key or the "Pair device" key on the display.
  2. A notification message will be displayed when the phone is successfully paired.
  3. The display will return to the current audio source status after the connection is complete.
- While the Bluetooth® connection is active, the following icons will appear on the display.
    - : Signal strength indicator
    - : Battery status indicator\*
    - : Bluetooth® connection ON indicator
  - \*: If low battery is indicated, the Bluetooth® device must be recharged soon.
  - Up to 5 different Bluetooth® devices can be connected. However, only one device can be used at a time. If 5 different Bluetooth® devices are registered, a new device can only replace one of the 5 existing paired devices.
  - The pairing procedure and operation may vary according to device type and compatibility. See the Bluetooth® device Owner's Manual for further details.

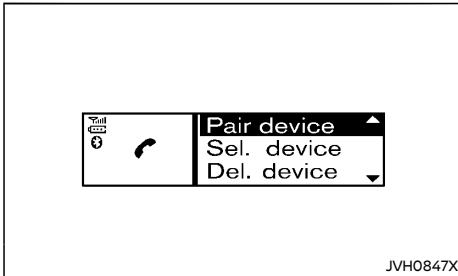

## Setting items

To set up the Bluetooth® system with a device, the following items are available:



- **Scan devices**  
Shows all available visible Bluetooth® devices and initializes Bluetooth® connection from the audio unit.
- **Pair device**  
Initializes Bluetooth® connection from the mobile device.
- **Sel. device**  
Paired Bluetooth® devices are listed and can be selected for connection.
- **Del. device**  
A registered Bluetooth® device can be deleted.
- **Bluetooth**  
If this setting is turned off, the connection between the Bluetooth® devices and the in-vehicle Bluetooth® module will be cancelled.

## Scan device:

1. Push the  button on the instrument panel or the  button on the steering wheel. Select "Scan device" key. The audio unit searches for the Bluetooth® devices and shows all devices that were found.

Make sure your Bluetooth® device is available at this time.

2. Select the device to be paired using the MENU/ENTER dial.
3. The pairing procedure depends on the device to be connected:
  - a. Device without PIN code:

The Bluetooth® connection will be automatically connected without any further input.

b. Device with PIN code:

Two different ways of pairing are possible depending on the device:



- **Type A:**  
The message "To pair" and "Enter Pin" 0000 will be displayed.

Confirm the PIN code on the device. The Bluetooth® connection will be made.

- **Type B:**  
The message "Pairing request" and "Confirm password" together with a 6 digit code will be displayed. The unique and identical code should be displayed on the device. If the code is identical confirm on the device.

The Bluetooth® connection will be made.

## Pair device:

- Turn on the Bluetooth® on the audio unit. See "Bluetooth" (P.4-80).
- Use the audio unit to pair:  
Push the  button on the instrument panel or the  button on the steering wheel. Select the "Pair Device" key.  
The pairing procedure depends on the Bluetooth® device to be connected:
  - 1) Device without PIN code:  
The Bluetooth® connection will be automatically connected without any further input.
  - 2) Device with PIN code:  
Two different ways of pairing are possible depending on the device. For the correct procedure details, see "Scan device" (P.4-79).
- Use the Bluetooth® audio/cellular phone device to pair:
  - 1) Switch on the search mode for Bluetooth® devices.  
If the search mode finds the audio unit it will be shown on the device display.
  - 2) Select the unit device shown as "My Car".
  - 3) Enter the number code shown on the relevant device with the device's own keypad, and push the confirmation key on the Bluetooth® device.



Refer to the relevant Bluetooth® device Owner's Manual for further details.

## Sel. device:

The paired device list shows which Bluetooth® audio or cellular phone devices have been paired or registered to the system. Select the appropriate device to connect to the system.

The following icons (if equipped) indicate the

capability of the registered device:

-  : Cellular phone integration
-  : Audio streaming (A2DP - Advanced Audio Distribution Profile)



#### Del. device:

A registered device can be removed from Bluetooth® system registration. Select a registered device and push the MENU/ENTER dial to confirm to deletion.

#### Bluetooth:

If Bluetooth® signal has been turned off, a notification message "ON/OFF" appears when you select "Bluetooth" from the phone menu. (Push the  button to display the phone menu.) To turn the Bluetooth® signal on, push the MENU/ENTER dial and a follow up screen will appear. Select "ON" and push the MENU/ENTER dial to display the Bluetooth® settings menu screen.

### USING THE SYSTEM

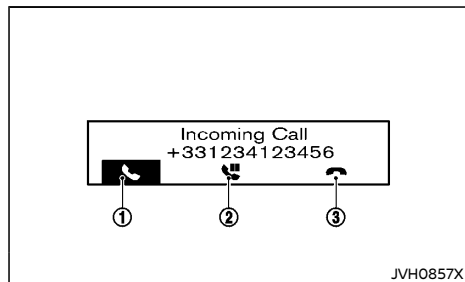

The hands-free mode can be operated using the  button on the instrument panel or the  button on the steering wheel.

#### Receiving a call







When receiving an incoming call, the display on the audio unit will show the caller's phone number (or a notification message that the caller's phone number cannot be shown) and three operation icons as illustrated. To highlight different icons, turn the MENU/ENTER dial. Push the MENU/ENTER dial to select the highlighted icon.



#### ① Answering and during a call:

Answer the call by selecting  on the display or by pushing  on the steering wheel.



During the call, the following icons are available:

-  :  
Select this item to end the call.
-  :  
Select this item to put the call on hold.
-  :  
Select this item to transfer the call from the hands-free phone system to your cellular phone.
-  :  
Select this item to transfer the call back to the hands-free phone system from the cellular phone.
- #123:  
Select this item to enter numbers during a call. For example, use this function when directed by an automated phone system to dial an extension number.

#### ② Putting a call on hold:

To put a call on hold, select . Select  to return to the call. To reject the call select .

#### ③ Rejecting a call:

To reject an incoming call, select  or by pushing  on the steering wheel.

#### Making a call



#### WARNING:

**Park the vehicle in a safe location, and apply the parking brake before making a call.**

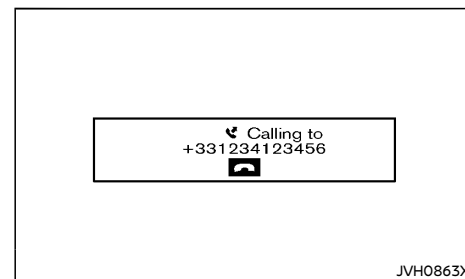

A call can be initiated using one of the following methods:

- Making a call from the phonebook
- Manually dialing a phone number
- Redialing
- Using call history (Call List menu)
  - Dialed
  - Received
  - Missed

#### Making a call from the phonebook:

Once the Bluetooth® connection has been made between the registered cellular phone and the hands-free phone system, phonebook data will be transferred automatically to the hands-free phone system. The transfer may





take a while before completion.



**NOTE:**

**Phone book data will be erased when:**

- **Switching to another registered cellular phone.**
- **Cellular phone is disconnected.**
- **The registered cellular phone is deleted from the audio system.**

1. Push the  button on instrument panel or the  button on the steering wheel.
2. Turn the MENU/ENTER dial to highlight "Phone Book" and push the MENU/ENTER dial.
3. Scroll down through the list, select the appropriate contact name (highlighted), and push the MENU/ENTER dial.
4. The screen will show the number to be dialed. Push the MENU/ENTER dial to dial the number.

If more than one number is registered, select an appropriate icon.

-  : Home
-  : Cellular phone
-  : Office

**Quick searching the phonebook:**

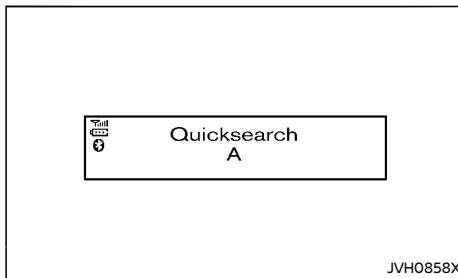



The quick search mode can be used as follows:

1. Push the A-Z button.
2. Turn the MENU/ENTER dial for the first alphabetic or numerical letter of the contact name. Once highlighted, push the MENU/ENTER dial to select the letter.
3. The display will show the corresponding contact name(s). Where necessary, use the MENU/ENTER dial to scroll further for the appropriate contact name to call.
4. The screen will show the number to be dialed. Push the MENU/ENTER dial to dial the number.

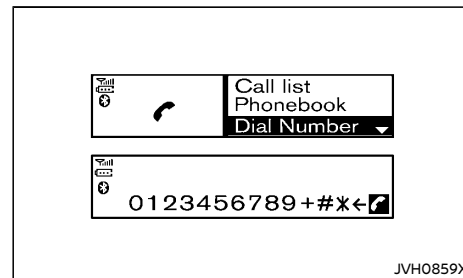
**Manually dialing a phone number:**





To dial a phone number manually, perform the following operation:

1. Push the  button on the instrument panel or the  button on the steering wheel and turn the MENU/ENTER dial to highlight "Dial Number".
2. Push the MENU/ENTER dial to select "Dial Number".
3. Turn the MENU/ENTER dial to scroll along and highlight each number of the phone number. Push the MENU/ENTER dial to select the highlighted number.

To delete the last number entered, scroll to the "<" (Backspace symbol) and once highlighted, push the MENU/ENTER dial. The last number will be deleted. Pushing the MENU/ENTER dial repeatedly will delete each subsequent number.

4. After entering the last number, highlight the  icon and push the MENU/ENTER dial to dial the number.



## Redial:

To redial or call the last number dialed, push and hold the  button on the instrument panel or the  button on the steering wheel for more than 2 seconds.

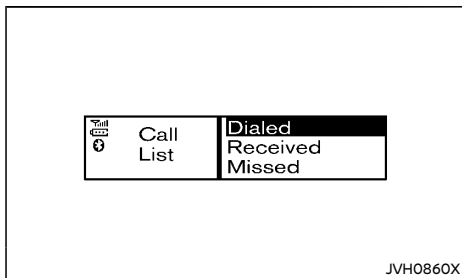
## Using call history (Call list menu):



A number from the dialed, received, or missed call lists can also be used to make a call.



1. Push the  button on the instrument panel or the  button on the steering wheel and select "Call List" on the display.
2. Turn the MENU/ENTER dial and scroll to an item, and push the MENU/ENTER dial to select an item.

### Available items:

- Dialed  
Use the dialed call mode to make a call which is based on the list of outgoing (dialed) calls.
- Received  
Use the received call mode to make a call which is based on the list of received calls.

- Missed

Use the missed call mode to make a call which is based on the list of missed calls.

3. Scroll to the preferred phone number and push the MENU/ENTER dial, the  button on the instrument panel or the  button on the steering wheel.

## Second incoming call

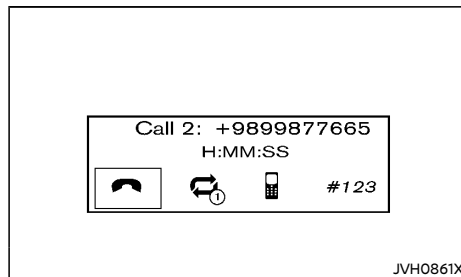



Whenever there is a second incoming call is shown in the display. By selecting the  icon the call is accepted and the current call is put on hold.

Selecting the  icon using the MENU/ENTER dial rejects the second incoming call. When this is done during the conversation it ends the call.

Selecting the  icon using the MENU/ENTER dial switches the call on line between the first and the second call.

## Ending a call

To end an active call, highlight the  icon and push the ENTER/MENU dial or push the  button on the steering wheel.

## GENERAL SETTINGS

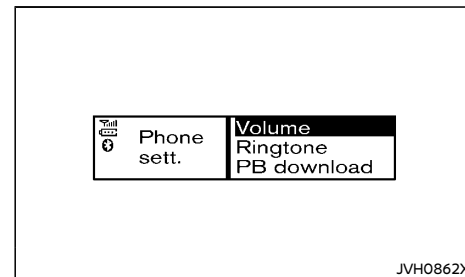

Using the MENU/ENTER dial, highlight "Settings" from the phone menu and push the MENU/ENTER dial.

Volume settings and manually downloading the phonebook can be done using this menu.

### Menu operation:

Turn the MENU/ENTER dial to change the highlighted item and to change the volume settings.

Push the MENU/ENTER dial to select the highlighted item and to apply the setting.

### Menu items:

- Volume
  - Ring  
Set the phone ringing volume.
  - Call  
Set the volume of the conversation during a call.

## Bluetooth® HANDS-FREE PHONE SYSTEM (Type B)

- Ringtone
  - Car  
Switch the ringtone to ring from the vehicle or the cellular phone.
  - Phone  
Switch the phone ringing volume on or off.
- PB download  
Download the phonebook of the mobile device to the audio unit manually.

\*This Bluetooth® Hands-Free Phone System is for models with type D or type E audio.



### WARNING:

- **Use a phone after stopping your vehicle in a safe location. If you have to use a phone while driving, exercise extreme caution at all times so full attention may be given to vehicle operation.**
- **If you find yourself unable to devote full attention to vehicle operation while talking on the phone, pull off the road to a safe location and stop your vehicle before doing so.**



### CAUTION:

**To avoid draining the vehicle battery, use a phone after starting the engine.**

### NOTE:

**Wireless LAN (Wi-Fi) and the Bluetooth® functions share the same frequency band (2.4 GHz). Using the Bluetooth® and the wireless LAN functions at the same time may slow down or disconnect communication and cause undesired noise. It is recommended that you turn off the wireless LAN (Wi-Fi) when using the Bluetooth® functions.**

Your vehicle is equipped with Bluetooth® Hands-Free Phone System. If you are an owner of a Bluetooth® enabled cellular phone, you can set up the wireless connection between your cellular phone and the in-vehicle phone module. With Bluetooth® wireless technology, you can make or receive a telephone call with your cellular phone in your pocket.

Once your cellular phone is paired to the in-vehicle phone module, no phone connecting

procedure is required. Your phone is automatically connected with the in-vehicle phone module when the ignition switch is placed in the "ON" position with the registered cellular phone turned on and carried in the vehicle.

You can register up to 5 different Bluetooth® cellular phones in the in-vehicle phone module. However, you can talk on only one cellular phone at a time.

When a call is active, the audio system and microphone (located near the map lights) are used for the handsfree communications.

If the audio system is being used at the time, the audio mode will mute and will stay muted until the active call is ended.

Before using the Bluetooth® Hands-Free Phone System, refer to the following notes.

- Set up the wireless connection between a cellular phone and the in-vehicle phone module before using the Bluetooth® Hands-Free Phone System.
- Some Bluetooth® enabled cellular phones may not be recognized by the in-vehicle phone module.
- You will not be able to use a hands-free phone under the following conditions:
  - Your vehicle is outside of the telephone service area.
  - Your vehicle is in an area where it is difficult to receive radio waves; such as in a tunnel, in an underground parking garage, behind a tall building or in a mountainous area.
  - Your cellular phone is locked in order not to be dialed.
- When the radio wave condition is not ideal or ambient sound is too loud, it may be difficult to hear the other person's voice during a call.

- Immediately after the ignition switch is placed in the "ON" position, it may be impossible to receive a call for a short period of time.
- Do not place the cellular phone in an area surrounded by metal or far away from the in-vehicle phone module to prevent tone quality degradation and wireless connection disruption.
- While a cellular phone is connected through the Bluetooth® wireless connection, the battery power of the cellular phone may discharge quicker than usual.
- If the Bluetooth® Hands-Free Phone System seems to be malfunctioning, please contact a NISSAN dealer.
- Some cellular phones or other devices may cause interference or a buzzing noise to come from the audio system speakers. Storing the device in a different location may reduce or eliminate the noise.
- Refer to the cellular phone Owner's Manual regarding the telephone pairing procedure specific to your phone, battery charging, cellular phone antenna, etc.
- The antenna display on the monitor will not coincide with the antenna display of some cellular phones.
- Keep the interior of the vehicle as quiet as possible to hear the caller's voice clearly as well as to minimize its echoes.
- If reception between callers is unclear, adjusting the incoming or outgoing call volume may improve the clarity.
- This wireless hands free car kit is based on Bluetooth® technology.
  - Frequency: 2402 MHz - 2480 MHz
  - Modulation: FHSS GFSK 8DPSK,  $\pi$ /4DQPSK

- Number of Channel: 79
- This wireless equipment cannot be used for any services related to safety due to the possibility of radio interference.

## REGULATORY INFORMATION

### CE statement

Hereby "Yangfeng Visteon Automotive Electronics Co., Ltd." declares that this Bluetooth car kit is in compliance with the essential requirements and other relevant provisions of Directive 1999/5/EC.



### Bluetooth® Trademark:



Bluetooth® is a trademark owned by Bluetooth SIG, Inc. and licensed to Visteon Corporation.

## USING THE SYSTEM

### Control buttons:

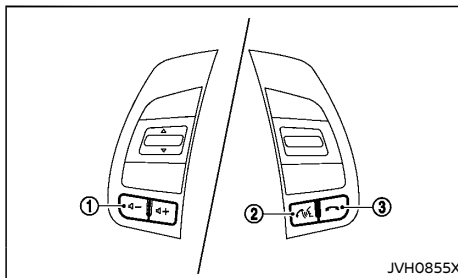

1. Volume control buttons  
Push the buttons to increase or decrease the volume of the speakers.
2. Phone send button  
Push the button to initiate a phone session or answer an incoming call.
3. Phone end button  
Push the button to end a phone call or to stop the system from providing voice prompts.

### Microphone:

Microphone is located near the map lights.

The NISSAN Voice Recognition system (if equipped) allows hands-free operation of the Bluetooth® Hands-Free Phone System.

If the vehicle is in motion, some commands may not be available so full attention may be given to vehicle operation.

## Setup

### Choosing a language:

You can interact with the Bluetooth® Hands-Free Phone System using several languages that are available. To change the language, perform the following. See "Audio main operation" (P.4-58) or "Audio main operation" (P.4-64).

### Connecting procedure:

You can register up to 5 different Bluetooth® cellular phones in the in-vehicle phone module. However, you can talk on only one cellular phone at a time.

To connect a phone to the Bluetooth® hands-free phone system. See "Connecting Bluetooth® device" (P.4-62) or "Connecting Bluetooth® device" (P.4-68).

### Selecting a registered phone:

1. Push the ENTER/SETTING button.
2. Use the TUNE-FOLDER dial to select "Bluetooth" and then push the ENTER/SETTING button.
3. Select "Select Phone", and then push the ENTER/SETTING button.
4. Select the phone you wish to use.

### Deleting a registered phone:

1. Push the ENTER/SETTING button.
2. Use the TUNE-FOLDER dial to select "Bluetooth" and then push the ENTER/SETTING button.
3. Select "Delete Phone", and then push the ENTER/SETTING button.
4. Use the TUNE-FOLDER dial to select the phone you wish to delete.

### NOTE:

**When you delete a phone, the associated phonebook for the phone will also be deleted.**

### Bluetooth® on/off:

1. Push the ENTER/SETTING button.
2. Use the TUNE-FOLDER dial to select "Bluetooth" and then push the ENTER/SETTING button.
3. Select "Bluetooth" and select "On" or "Off" to turn the vehicle's Bluetooth® system on or off.

When Bluetooth® is off, you will not be able to make or receive calls by the hands-free mode. Also, you will not have access to the phonebook.

### Phone menu

Push the  button to bring up the phone menu. The available options are:

- Call
- Phonebook
- Record Name (if equipped)
- Recent Calls
- Select Phone

### Call:

The following items are available under "Call".

- List Names  
Select this item to have the system list the names in the phonebook one by one in alphabetical order. Select "Dial" to dial the number of the currently selected name. Push the  button on the steering wheel to move through the list and select the person you wish to call.
- Redial  
Select this item to call the last number dialed.
- Call Back  
Select this item to call the number of the last incoming call to the vehicle.

### Phonebook:

The following items are available under "Phonebook".

### NOTE:

**Each phone has its own separate phonebook. You cannot access Phone A's phonebook if you are currently connected with Phone B.**

- List Names  
Select this item to have the system list the names in the phonebook one by one in alphabetical order. Select "Dial" to dial the number of the currently selected name.

Push the  button on the steering wheel to move through the list and select the person you wish to call.

- Delete Entry  
Select this item to delete an entry in the phonebook. Choose an entry to delete.

### Record Name (if equipped):

The system allows you to record custom voice tags for contact names in the phonebook. Up to 40 voice tags can be recorded to the system.

### Recent Calls:

The following items are available under "Recent Calls":

- Incoming Calls  
Select this item to list the last five incoming calls to the vehicle. If the call is from an entry in the phonebook, the name will be displayed. Otherwise, the phone number of the incoming call will be displayed.  
Select "Dial" to call the number. Select "Next Entry" or "Previous Entry" to move through the list of incoming calls.
- Missed Calls  
Select this item to list the last five missed calls to the vehicle. If the call is from an entry in the phonebook, the name will be displayed. Otherwise, the phone number of the missed call will be displayed. Select "Dial" to call the number. Select "Next Entry" or "Previous Entry" to move through the list of missed calls.
- Outgoing Calls  
Select this item to list the last five outgoing calls from the vehicle. If the call was to an entry in the phonebook, the name will be displayed. Otherwise, the phone number of the outgoing call will be displayed. Select "Dial" to call the number. Select "Next Entry"

or "Previous Entry" to move through the list of outgoing calls.





- **Redial**  
Select this item to call the last number dialed.
- **Call Back**  
Select this item to call the number of the last incoming call to the vehicle.

#### **Select Phone:**







Select this item to select a phone to use from a list of those phones connected to the vehicle.

#### **Making a call**

##### **Phonebook:**

1. Push the  button on the steering wheel and push the  button on the steering wheel to select the "Phonebook" menu.
2. Push the  button on the steering wheel to select the "List Names" menu.
3. Push the  button on the steering wheel to select the person you wish to call.
4. Push the  button to accept the selection. The system acknowledges the selection and starts dialing.

##### **Redial:**

1. Push the phone send  button.
2. Push the  button on the steering wheel or using the TUNE-FOLDER dial to select "Recent Calls", and then push the phone send  button.
3. Push the  button on the steering wheel to select "Redial", and then push the phone send  button.
4. Push the phone send  button, and then the system begins the call.

#### **Bluetooth® cellular phone keypad:**

You can also make a call by operating the cellular phone that is registered to the in-vehicle phone module to use the hands-free phone system.

#### **Receiving or rejecting a call**



When you hear the ring tone, push the phone send  button on the steering wheel.

If you do not wish to answer the call when you hear the ring tone, push the phone end  button.

#### **During a call**

During a call, push the phone send  button to access additional options. Select one of the following items:

- **"Mute On" / "Mute Off"**  
Select the item to mute or unmute the system.
- **"Transfer Call"**  
Select this item to switch the call from the Bluetooth® Hands-Free Phone System to the cellular phone when privacy is desired. Once the ignition switch is placed in the "OFF" position and the "ON" position again, the system will automatically change to the hands-free mode as a default setting.

If supported by the phone, the Bluetooth® Hands-Free Phone System allows for call waiting functionality. If a call is received while another call is already active, a message will be displayed on the screen. Push the phone send  button to hold the active call and switch to the second call. Push the  button to reject the second call.

While the second call is active, pushing the phone send  button will allow the same items that are available during any call as well

as two additional items:

- **"Switch Call"**  
Select this item to hold the second call and switch back to the original call.
- **"End Other Call"**  
Select this item to stay with the second call and end the original call.

Push the phone send  button to accept the call. Push the  button to reject the call.

#### **Ending a call**

Push the phone end  button on the steering wheel or the off button on the cellular phone.

#### **Bluetooth® SETTINGS**

To access and adjust the settings for the Bluetooth® Hands-Free Phone System;

1. Push the ENTER/SETTING button.
2. Use the TUNE-FOLDER dial to select "Bluetooth" and then push the ENTER/SETTING button.

##### **Available setting items:**

- **Bluetooth**  
Select "On" or "Off" to turn the vehicle's Bluetooth® system on or off.
- **Add Phone**  
For operation to connect a phone to the system, see "Connecting Bluetooth® device" (P.4-62) or "Connecting Bluetooth® device" (P.4-68).
- **Delete Phone**  
Select to delete a phone from the displayed list. The system will ask to confirm before deleting the phone.

## Bluetooth® HANDS-FREE PHONE SYSTEM (Type C)

### NOTE:

**When you delete a phone, the associated phonebook for the phone will also be deleted.**

- **Replace Phone**  
Select to replace a phone from the displayed list. When a selection is made, the system will ask to confirm before proceeding. The recorded phonebook for the phone being deleted will be saved as long as the new phone's phonebook is the same as the old phone's phonebook.
- **Select Phone**  
Select to connect to a previously connected phone from the displayed list.
- **Phonebook Download (if equipped)**  
Select to turn on or off the automatic download of a connected phone's phonebook.
- **Show Incoming Calls**  
Select "Driver Only" to have incoming call information displayed only in the vehicle information display. Select "Both" to have incoming call information displayed in both the vehicle information display and the center display screen.

\*This Bluetooth® Hands-Free Phone System is for models with type F audio.



### WARNING:

- **Use a phone after stopping your vehicle in a safe location. If you have to use a phone while driving, exercise extreme caution at all times so full attention may be given to vehicle operation.**
- **If you are unable to devote full attention to vehicle operation while talking on the phone, pull off the road to a safe location and stop your vehicle.**



### CAUTION:

**To avoid discharging the vehicle battery, use a phone after starting the engine.**

Your vehicle is equipped with the Bluetooth® Hands-Free Phone System. If you have a compatible Bluetooth® enabled cellular phone, you can set up the wireless connection between your cellular phone and the in-vehicle phone module. With Bluetooth® wireless technology, you can make or receive a hands-free telephone call with your cellular phone in the vehicle.

Once your cellular phone is connected to the in-vehicle phone module, no other phone connecting procedure is required. Your phone is automatically reconnected with the in-vehicle phone module when the ignition switch is placed in the ON position with the connected cellular phone turned on and carried in the vehicle.

You can register up to 5 different Bluetooth® cellular phones to the in-vehicle phone module. However, you can talk on only one cellular phone at a time.

Before using the Bluetooth® Hands-Free Phone System, refer to the following notes.

- Set up the wireless connection between a cellular phone and the in-vehicle phone module before using the Bluetooth® Hands-Free Phone System.
- Some Bluetooth® enabled cellular phones may not be recognized by the in-vehicle phone module.
- You will not be able to use a hands-free phone under the following conditions:
  - Your vehicle is outside of the cellular service area.
  - Your vehicle is in an area where it is difficult to receive cellular signal; such as in a tunnel, in an underground parking garage, near a tall building or in a mountainous area.
  - Your cellular phone is locked to prevent it from being dialed.
- When the radio wave condition is not ideal or ambient sound is too loud, it may be difficult to hear the other person's voice during a call.
- Immediately after the ignition switch is placed in the ON position, it may be impossible to receive a call for a short period of time.
- Do not place the cellular phone in an area surrounded by metal or far away from the in-vehicle phone module to prevent tone quality degradation and wireless connection disruption.
- While a cellular phone is connected through the Bluetooth® wireless connection, the battery power of the cellular phone may discharge quicker than usual. The Bluetooth® Hands-Free Phone System cannot charge cellular phones.

- Some cellular phones or other devices may cause interference or a buzzing noise to come from the audio system speakers. Storing the device in a different location may reduce or eliminate the noise.
- Refer to the cellular phone owner's manual regarding the telephone charges, cellular phone antenna and body, etc.
- The signal strength display on the monitor will not coincide with the signal strength display of some cellular phones.

## REGULATORY INFORMATION

### Bluetooth® trademark



Bluetooth® is a trademark owned by Bluetooth SIG, Inc. and licensed to Robert Bosch GmbH.

## CONTROL BUTTONS AND MICROPHONE

### Steering wheel switch:

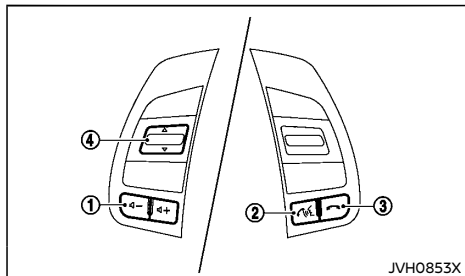

1. Volume control +/- - switch
2. Phone send button
3. Phone end button

### 4. Tuning switch

#### Control panel:

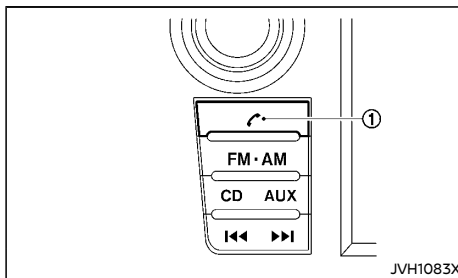

1. Phone button

#### Microphone:

Microphone is located near the map lights.

## PAIRING PROCEDURE

### NOTE:

**The connecting procedure must be performed when the vehicle is stationary. If the vehicle starts moving during the procedure, the procedure will be cancelled.**

1. Push the SETUP button on the control panel.
2. Select the "Telephone & Bluetooth" key.
3. Select the "Pair New Device" key.
4. Initiate the pairing process from the handset. The system will display the message asking if PIN is displayed on your Bluetooth® device. If the PIN is displayed on your Bluetooth® device, select "Yes" to complete the pairing process.

For more information, see the Bluetooth® device's Owner's Manual.

## PHONEBOOK

To access the vehicle phonebook:

1. Push the button on the control panel.
2. Select the "Contacts" key.
3. Choose the desired entry from the displayed list.
4. The number of the entry will be displayed on the screen. Touch the number to initiate dialing.

### NOTE:

**To scroll quickly through the list, touch the "A-Z" key in the upper right corner of the screen. Turn the ENTER/Scroll dial to choose a letter or number and then push the ENTER/Scroll dial. The list will move to the first entry that begins with that number or letter.**

## MAKING A CALL

To make a call, follow the procedure below:



1. Push the on the control panel. The "Phone" screen will appear on the display.
2. Select one of the following options to make a call:
  - "Contacts": Select the name from an entry stored in the vehicle phonebook.
  - "Call Lists": Select the name from the incoming, outgoing or missed.
  - "Redial": Dial the last outgoing call from the vehicle.
  - : Input the phone number manually using a keypad displayed on the screen. For information on how to use the touch screen, see "How to use touch screen display" in this section.





## RECEIVING A CALL

When a call is placed to the connected phone, the display will change to phone mode.

To accept the incoming call, take one of the following actions.

- Push the  button on the steering wheel.
- Touch the " " icon on the screen.

To reject the incoming call, take one of the following actions.



- Push the  button on the steering wheel.
- Touch the red phone " " icon on the screen.

## DURING A CALL

While a call is active, the following options are available on the screen:

- "Handset"  
Select this option to switch control of the phone call over to the handset.
- "Mute Mic."  
Select this option to mute the microphone. Select again to unmute the microphone.
- " " icon  
Select to end the phone call.

## ENDING A CALL

To end a phone call, select the " " icon on the screen or push the  button on the steering wheel.

## Bluetooth® SETTINGS

To access the Bluetooth® settings screen:

1. Push the SETUP button.
2. Touch the "Telephone & Bluetooth" key.

### Available setting items:

- **Telephone Setup**  
See "Telephone setup" (P.4-89) for details.
- **Pair New Device**  
Select to pair a new Bluetooth® device to the Bluetooth® Hands-Free Phone System.
- **Select Paired Device**  
Select to choose a Bluetooth® device from a list of those devices paired to the Bluetooth® Hands-Free Phone System.
- **Delete Paired Device**  
Select to delete a Bluetooth® device from a list of those devices connected/paired to the Bluetooth® Hands-Free Phone System.
- **Bluetooth**  
Select to toggle Bluetooth® on and off.

## TELEPHONE SETUP

To access the phone settings screen:

1. Push the SETUP button.
2. Touch the "Telephone & Bluetooth" key.
3. Touch the "Telephone Setup" key.

### Available setting items:

- Sort Phonebook By:  
Select "First Name" or "Last Name" to choose how phonebook entries are alphabetically displayed on the screen.
- Phonebook:  
Select "Phone" to use the handset's phonebook. Select "SIM" to use the phonebook on the SIM card. Select "Both" to use both sources.

- Download Phonebook Now:  
Select to download the phonebook to the vehicle from the chosen source.
- Phone Notifications for:  
Select "Driver" to have phone notifications shown in the vehicle information display. Select "Both" to have phone notifications shown in both the vehicle information display and the display.

**MEMO**

# 5 Starting and driving

Break-in schedule .....	5-3	Starting engine (models without Intelligent Key system) .....	5-13
Before starting engine .....	5-3	Starting engine (models with Intelligent Key system) .....	5-13
Precautions when starting and driving .....	5-3	Driving vehicle .....	5-14
Exhaust gas (carbon monoxide) .....	5-4	Driving with Automatic Transmission (AT) .....	5-14
Three-way catalyst (if equipped) .....	5-4	Driving with Manual Transmission (MT) .....	5-17
Diesel Particulate Filter (DPF) (if equipped) .....	5-5	Four-Wheel Drive (4WD) (if equipped) .....	5-17
Automatic regeneration .....	5-5	Part time 4WD system .....	5-18
Manual regeneration (models equipped with Diesel Particulate Filter (DPF) regeneration switch) .....	5-5	4WD mode switch operation .....	5-20
Turbocharger system (if equipped) .....	5-7	4WD mode indicator .....	5-21
On-pavement and off-road driving precautions .....	5-7	4WD warning .....	5-21
Driving safety precautions .....	5-7	Tire recommendation for 4WD .....	5-22
Care when driving .....	5-8	Rear differential locking system (if equipped) .....	5-23
Engine cold start period .....	5-8	Vehicle Dynamic Control (VDC) system (if equipped) .....	5-23
Loading luggage .....	5-8	Vehicle Dynamic Control (VDC) OFF switch .....	5-24
Driving in wet conditions .....	5-8	Hill descent control system (if equipped) .....	5-25
Driving in winter conditions .....	5-9	Hill descent control switch .....	5-25
Ignition switch (models without Intelligent Key system) .....	5-9	Hill start assist system (if equipped) .....	5-26
Manual Transmission (MT) .....	5-9	Cruise control (if equipped) .....	5-26
Automatic Transmission (AT) .....	5-9	Precautions on cruise control .....	5-27
Key positions .....	5-10	Cruise control operations .....	5-27
Push-button ignition switch (models with Intelligent Key system) .....	5-10	ECO drive report (if equipped) .....	5-28
Precautions on push-button ignition switch operation .....	5-10	Fuel Efficiency and Carbon Dioxide Reduction driving tips .....	5-28
Intelligent Key system .....	5-10	Increasing fuel economy and reducing Carbon Dioxide emissions .....	5-29
Automatic Transmission (AT) .....	5-11	Parking .....	5-29
Steering lock .....	5-11	Parking sensor (sonar) system (if equipped) .....	5-31
Ignition switch positions .....	5-11	Parking sensor (sonar) system OFF switch .....	5-32
Intelligent Key battery discharge .....	5-12	Parking sensor (sonar) system setting .....	5-32

Trailer towing (except for Australia, New Zealand, South Africa and Latin America) .....	5-32	Brake system .....	5-35
Trailer towing (for Australia, New Zealand, South Africa and Latin America) .....	5-33	Brake precautions .....	5-35
Operating precautions .....	5-33	Brake assist (if equipped) .....	5-35
Maximum load limits (for Australia and New Zealand) .....	5-33	Anti-lock Braking System (ABS) (if equipped) .....	5-35
Tire pressure .....	5-34	Vehicle security .....	5-36
Safety chains .....	5-34	Cold weather driving .....	5-37
Trailer brakes .....	5-34	Battery .....	5-37
Trailer detection (if equipped) .....	5-34	Engine coolant .....	5-37
Power steering .....	5-34	Tire equipment .....	5-37
		Special winter equipment .....	5-37
		Parking brake .....	5-37
		Corrosion protection .....	5-38

## BREAK-IN SCHEDULE

During the first 1,600 km (1,000 miles), follow these recommendations to obtain maximum engine performance and ensure the future reliability and economy of your new vehicle. Failure to follow these recommendations may result in shortened engine life and reduced engine performance.

- Do not drive at a constant speed, either fast or slow, for long periods of time.
- Do not run the engine over 4,000 rpm.
- Do not accelerate at full throttle in any gear.
- Do not start quickly.
- Do not brake hard as much as possible.
- Do not tow a trailer for at least the first 800 km (500 miles) (for Australia, New Zealand, South Africa and Latin America).

## BEFORE STARTING ENGINE



### WARNING:

**The driving characteristics of your vehicle will change remarkably by any additional load and its distribution, as well as by adding optional equipment (trailer coupling, roof rack, etc.). Your driving style and speed must be adjusted according to the circumstances. Especially when carrying heavy loads, your speed must be reduced adequately.**

- Make sure the area around the vehicle is clear.
- Check fluid levels such as engine oil, coolant, brake (and clutch) fluid, window washer fluid as frequently as possible, at least whenever you refuel.
- Visually inspect tires for their appearance and condition. Measure and check the tire pressure for proper inflation.
- Check that all windows and lights are clean.
- Adjust the seat and head restraint positions.
- Adjust the inside and outside rearview mirror positions.
- Fasten your seat belt and ask all passengers to do the same.
- Check that all doors are closed.
- Check the operation of the warning lights when the ignition switch is placed in the "ON" position.
- Maintenance items in the "8. Maintenance and do-it-yourself" section should be checked periodically.

## PRECAUTIONS WHEN STARTING AND DRIVING



### WARNING:

- **Never leave children or adults who would normally require the support of others alone in your vehicle. Pets should not be left alone either. They could unknowingly activate switches or controls and inadvertently become involved in a serious accident and injure themselves. On hot, sunny days, temperatures in a closed vehicle could quickly become high enough to cause severe or possibly fatal illness to people or animals.**
- **Properly secure all cargo to help prevent it from sliding or shifting. Do not place cargo higher than the seatbacks. In a sudden stop or collision, unsecured cargo could cause personal injury.**

### NOTE:

**During the first few months after purchasing a new vehicle, if you smell strong odors of Volatile Organic Compounds (VOCs) inside the vehicle, ventilate the passenger compartment thoroughly. Open all the windows before entering or while in the vehicle. In addition, when the temperature in the passenger compartment rises, or when the vehicle is parked in direct sunlight for a period of time, turn off the air recirculation mode of the air conditioner and/or open the windows to allow sufficient fresh air into the passenger compartment.**

## EXHAUST GAS (carbon monoxide)



### WARNING:

- Do not breathe exhaust gas; it contains colorless and odorless carbon monoxide. Carbon monoxide is dangerous. It can cause unconsciousness or death.
- If you suspect that exhaust fumes are entering the vehicle, drive with all windows fully open, and have the vehicle inspected immediately.
- Do not run the engine in closed spaces such as a garage.
- Do not park the vehicle with the engine running for an extended period of time.
- If electrical wiring or other cable connections must pass to a trailer through the seal of the body, follow the manufacturer's recommendations to prevent carbon monoxide entry into the vehicle.
- If a special body or other equipment is added for recreational or other usage, follow the manufacturer's recommendation to prevent carbon monoxide entry into the vehicle. (Some recreational vehicle appliances such as stoves, refrigerators, heaters, etc. may also generate carbon monoxide.)
- The exhaust system and body should be inspected by a qualified mechanic whenever:
  - Your vehicle is raised while being serviced.
  - You suspect that exhaust fumes are entering into the passenger compartment.

– You notice a change in the sound of the exhaust system.

– You have had an accident involving damage to the exhaust system, underbody, or rear of the vehicle.

## THREE-WAY CATALYST (if equipped)



### WARNING:

- The exhaust gas and the exhaust system are very hot. Keep people, animals and flammable materials away from the exhaust system components.
- Do not stop or park the vehicle over flammable materials such as dry grass, wastepaper or rags. They may ignite and cause a fire.

The three-way catalyst is an emission control device installed in the exhaust system. Exhaust gas in the three-way catalyst is burned at high temperatures to help reduce pollutants.



### CAUTION:

- Do not use leaded gasoline. (See "Recommended fluids/lubricants and capacities" (P.9-2).) Deposits from leaded gasoline seriously reduce the ability of the three-way catalyst to help reduce exhaust pollutants and/or damage the three-way catalyst.
- Keep your engine tuned up. Malfunctions in the ignition, fuel injection, or electrical systems may cause overrich fuel to flow into the three-way catalyst, causing it to overheat. Do not keep driving if the engine misfires, or if noticeable loss of performance or other unusual operating conditions are detected. Have the vehicle

inspected promptly by a NISSAN dealer.

- Avoid driving with an extremely low fuel level. Running out of fuel could cause the engine to misfire, damaging the three-way catalyst.
- Do not race the engine while warming it up.
- Do not push or tow your vehicle to start the engine.

## **DIESEL PARTICULATE FILTER (DPF) (if equipped)**



### **WARNING:**

- **Be careful not to burn yourself with exhaust gases.**
- **Do not park the vehicle over flammable materials such as dry grass, waste paper or rags, as they may burn easily.**



### **CAUTION:**

**To maintain maximum Diesel Particulate Filter (DPF) performance, follow these precautions:**

- **Use low-sulfur fuel.**
- **Use an engine oil specified by NISSAN. (See "Recommended fluids/lubricants and capacities" (P.9-2).) If an engine oil not a specified by NISSAN is used, it could cause DPF malfunction or reduced fuel efficiency.**
- **Do not modify the DPF, muffler or exhaust pipe. Otherwise it could affect the DPF performance and cause a malfunction.**
- **Do not kick or hit the DPF. The DPF has a built-in catalyst system in the muffler. Such an impact could cause DPF damage.**

The Diesel Particulate Filter (DPF) reduces the amount of materials that affect the environment by collecting particulate matter included in exhaust gases. Normally, particulate matter accumulated in the DPF is automatically burned and converted to harmless substances during driving. However, particulate matter collected in the DPF cannot be burned under the following conditions:

- When vehicle speed remains below 15 km/h (10 MPH) for a long period of time.
- When the engine is frequently stopped and restarted within 10 minutes.
- When the vehicle is frequently used for short journeys of 10 minutes or less.
- When the engine is frequently stopped before it has warmed up.

In these cases, it becomes difficult to burn particulate matter that has accumulated in the DPF automatically. As a result, the DPF warning light in the meter will illuminate and the indicator light on the DPF regeneration switch will blink. This is not a malfunction.

If the DPF warning light comes on, perform the DPF regeneration process.



### **CAUTION:**

**If the vehicle continues to be driven with the DPF warning light illuminated and without doing the regeneration process, the fail-safe will limit the engine revolutions and/or torque. In this case, the engine oil must be replaced and the process of service regeneration must be carried out by a NISSAN dealer.**

**The service regeneration is not covered by the warranty.**

## **AUTOMATIC REGENERATION**

If the DPF warning light comes on, it indicates that particulate matter has accumulated in the DPF to the specified limit. Particulate matter collected in the DPF cannot be burned under low speed driving conditions.

As soon as safely possible, drive the vehicle at a high speed (more than approximately 80 km/h (50 MPH)) until the DPF warning light turns off. Always conform to local regulations.

When the accumulated particulate matter has been completely burned, the DPF warning light will turn off.

**MANUAL REGENERATION (models equipped with Diesel Particulate Filter (DPF) regeneration switch)**



### **WARNING:**

- **Make sure that nobody is close to the exhaust area.**
- **Be careful not to burn yourself with exhaust gases.**
- **Never run the manual regeneration in an enclosed area such as a tunnel or a garage and be sure there is proper ventilation for exhaust gases.**
- **Do not park the vehicle over flammable materials such as dry grass, waste paper or rags, as they may burn easily.**
- **The filter becomes extremely hot after burning particulate matter.**

### **NOTE:**

- **During the regeneration process, white smoke may be emitted from the exhaust pipe. This smoke may smell different from the exhaust gases. This does not**

indicate a system malfunction.

- The manual regeneration will not work when the engine, the coolant temperature and ambient temperature are cold. It starts only after the engine has warmed up.
- If the DPF regeneration switch indicator light does not blink even after the engine has warmed up and DPF warning light turns on, this may indicate a system malfunction. Have your vehicle checked at a NISSAN dealer.
- During the regeneration process, the engine speed will increase first up to 3,000 rpm (during warm up of the engine) and then drop to 1,700 rpm. This engine speed will be kept until regeneration process is completed.

The regeneration process will take approximately 45 minutes. In some cases, time to completion may vary.

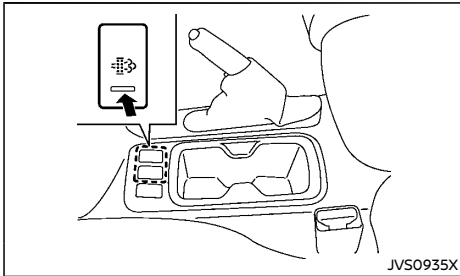

If the DPF warning light illuminates and the indicator light of the DPF regeneration switch blinks:

1. Park the vehicle safely off the road, away from traffic and in an open area.  
Do not park the vehicle over flammable materials.
2. Apply the parking brake.
3. Move the shift lever to the "P" (Park) position (Automatic transmission model) or the "N" (Neutral) position (Manual transmission model).  
DO NOT STOP THE ENGINE.
4. Push the DPF regeneration switch to start the regeneration process. The engine speed will automatically increase.  
(The indicator light of the DPF regeneration switch will turn on.)
5. The filter regeneration process is completed when the DPF warning light in the instrument panel and the indicator light of the DPF regeneration switch turn off.



#### CAUTION:

If any of the following symptoms are encountered, have your vehicle checked at a NISSAN dealer.

- The DPF warning light does not turn off and the DPF regeneration switch indicator light blinks again even after the regeneration process has been performed three consecutive times.
- A large amount of black smoke is emitted from the muffler of your vehicle.

#### Interrupting the manual regeneration process

Perform any one of the following methods to interrupt the process (if necessary):

- Depress the accelerator pedal or brake pedal.
- Depress the clutch pedal (Manual transmission model).
- Push and hold the DPF regeneration switch for about three seconds (indicator light turns off).

#### NOTE:

- When interrupting the manual regeneration process, the DPF warning light may illuminate and the DPF regeneration switch indicator light may blink. If this happens, perform the regeneration process again.
- If the DPF regeneration switch indicator light continues to blink with the DPF warning light on, even after the regeneration process has been performed three consecutive times, this may indicate a system malfunction. Have your vehicle checked at a NISSAN dealer.
- If the DPF regeneration switch indicator light does not illuminate even after the switch with the indicator light blinking is pressed, turn the ignition switch OFF and wait for approximately 3 minutes. Then turn the ignition switch back to the ON position and perform the process again from step 4.



## TURBOCHARGER SYSTEM (if equipped)

The turbocharger system uses engine oil for lubrication and cooling of its rotating components. The turbocharger turbine turns at extremely high speeds and it can reach an extremely high temperature. It is essential to maintain a flow of clean oil through the turbocharger system. A sudden interruption to the oil supply may cause a malfunction in the turbocharger.

To ensure prolonged life and performance of the turbocharger, it is essential to comply with the following maintenance procedure:



### CAUTION:

- **Change the engine oil of the turbocharged diesel engine as prescribed. See the separately provided maintenance booklet for additional information.**
- **Use only the recommended engine oil. For details, see "Recommended fluids/lubricants and capacities" (P.9-2).**
- **If the engine has been operating at high rpm for an extended period of time, let it idle for a few minutes prior to shutdown.**
- **Do not accelerate the engine to high rpm immediately after starting it.**
- **When starting the engine at ambient temperatures below -5°C (23°F), an engine protection mode may be activated. During this time, the engine output is reduced. The engine protection mode is switched off automatically after a maximum of 3 minutes (provided the accelerator pedal is released completely).**

## ON-PAVEMENT AND OFF-ROAD DRIVING PRECAUTIONS

**Pick-up vehicles have a significantly higher rollover rate than other types of vehicles.**

They have higher ground clearance than passenger cars to make them capable of performing in a wide variety of on-pavement and off-road applications. This gives them a higher center of gravity than ordinary cars. An advantage of higher ground clearance is a better view of the road, allowing you to anticipate problems. However, they are not designed for cornering at the same speeds as conventional passenger cars any more than low-slung sports cars are designed to perform satisfactorily under off-road conditions. If at all possible, avoid sharp turns or abrupt maneuvers, particularly at high speeds. As with other vehicles of this type, failure to operate this vehicle correctly may result in loss of control or vehicle rollover.

For information about driving using Four-Wheel Drive (4WD) (if equipped), see "Four-Wheel Drive (4WD)" (P.5-17).

### DRIVING SAFETY PRECAUTIONS

Please observe the following precautions:



### WARNING:

- **Drive carefully when off the road and avoid dangerous areas. Every person who drives or rides in this vehicle should be seated with their seat belt fastened. This will keep you and your passengers in position when driving over rough terrain.**
- **Do not drive across steep slopes. Instead drive either straight up or straight down the slopes. Off-road vehicles can tip over sideways much more easily than they can forward or backward.**

- **Many hills are too steep for any vehicle. If you drive down them, you may stall. If you drive down them, you may not be able to control your speed. If you drive across them, you may roll over.**
- **Do not shift ranges while driving on downhill grades as this could cause loss of control of the vehicle.**
- **Stay alert when driving to the top of a hill. At the top there could be a drop-off or other hazard that could cause an accident.**
- **If your engine stalls or you cannot make it to the top of a steep hill, never attempt to turn around. Your vehicle could tip or roll over. Always back straight down in R (Reverse) range. Never back down in N (Neutral) or with the clutch pedal depressed (MT model) using only the brake, as this could cause loss of control.**
- **Heavy braking going down a hill could cause your brakes to overheat and fade, resulting in loss of control and an accident. Apply brakes lightly and use a low range to control your speed.**
- **Unsecured cargo can be thrown around when driving over rough terrain. Properly secure all cargo so it will not be thrown forward and cause injury to you or your passengers.**
- **To avoid raising the center of gravity excessively, do not exceed the rated capacity of the roof rack (if equipped) and evenly distribute the load. Secure heavy loads in the cargo area as far forward and as low as possible. Do not equip the vehicle with tires larger than specified in this manual. This could cause your vehicle to roll over.**

- Do not grip the inside or spokes of the steering wheel when driving off-road. The steering wheel could move suddenly and injure your hands. Instead drive with your fingers and thumbs on the outside of the rim.
- Before operating the vehicle, ensure that the driver and all passengers have their seat belts fastened.
- Always drive with the floor mats in place as the floor may become hot.
- Lower your speed when encountering strong crosswinds. With a higher center of gravity, your NISSAN is more affected by strong side winds. Slower speeds ensure better vehicle control.
- Do not drive beyond the performance capability of the tires, even with 4WD engaged.
- Do not attempt to raise two wheels off the ground and shift the transmission to any drive or reverse position with the engine running. Doing so may result in drivetrain damage or unexpected vehicle movement which could result in serious vehicle damage or personal injury.
- Do not attempt to test a 4WD equipped vehicle on a 2-wheel dynamometer or similar equipment even if the other two wheels are raised off the ground. Make sure you inform test facility personnel that your vehicle is equipped with 4WD before it is placed on a dynamometer. Using the wrong test equipment may result in drivetrain damage or unexpected vehicle movement which could result in serious vehicle damage or personal injury.
- When a wheel is off the ground due to an unlevel surface, do not spin the wheel excessively.
- Accelerating quickly, sharp steering maneuvers or sudden braking may cause loss of control.
- If at all possible, avoid sharp turning maneuvers, particularly at high speeds. Your vehicle has a higher center of gravity than a conventional passenger car. The vehicle is not designed for cornering at the same speeds as conventional passenger cars. Failure to operate this vehicle correctly could result in loss of control and/or a rollover accident.
- Always use tires of the same type, size, brand, construction (bias, bias-belted or radial), and tread pattern on all four wheels. Install tire chains on the rear wheels when driving on slippery roads and drive carefully.
- Be sure to check the brakes immediately after driving in mud or water. See "Brake system" (P.5-35) for wet brakes.
- Avoid parking your vehicle on steep hills. If you get out of the vehicle and it rolls forward, backward or sideways, you could be injured.
- Whenever you drive off-road through sand, mud or water as deep as the wheel hub, more frequent maintenance may be required. See the maintenance information in a separate maintenance booklet.
- Rinse the underside of the vehicle with fresh water after driving through mud or sand. Remove any brush or sticks that are trapped.

## CARE WHEN DRIVING

Driving your vehicle to fit the circumstances is essential for your safety and comfort. As a driver, you should be the one who knows best how to drive in the given circumstances.

### ENGINE COLD START PERIOD

Due to the higher engine speeds, when the engine is cold, extra caution must be exercised when selecting a gear during the engine warm-up period after starting the engine.

### LOADING LUGGAGE

Loads and their distribution and the attachment of equipment (roof baggage carriers, etc.) will considerably change the driving characteristics of the vehicle. Your driving style and speed must be adjusted according to the circumstances.

### DRIVING IN WET CONDITIONS

- Avoid accelerating or stopping suddenly.
- Avoid sharp turning or lane changing suddenly.
- Avoid following too close to the vehicle in front.

When water covers the road surface with water puddles, small water streams, etc., reduce speed to prevent hydroplaning which can cause skidding and loss of control. Worn tires will increase this risk.

## IGNITION SWITCH (models without Intelligent Key system)

### DRIVING IN WINTER CONDITIONS

- Drive cautiously.
- Avoid accelerating or stopping suddenly.
- Avoid sharp turning or lane changing suddenly.
- Avoid sudden steering.
- Avoid following too close to the vehicle in front.



#### WARNING:

**Never remove the key or turn the ignition switch to the "LOCK" position while driving. The steering wheel will lock. This will cause the driver to lose control of the vehicle and could result in serious vehicle damage or personal injury.**

### MANUAL TRANSMISSION (MT)

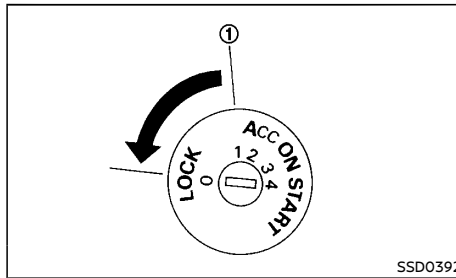

The switch includes an anti-theft steering lock device.

The ignition key can only be removed when the switch is in the "LOCK" normal parking position (0).

There is an "OFF" position ① in between "LOCK" and "ACC", although it does not show on the lock cylinder.

**To lock the steering wheel, remove the key. To unlock the steering wheel, insert the key and turn it gently while rotating the steering wheel slightly right and left.**

### AUTOMATIC TRANSMISSION (AT)

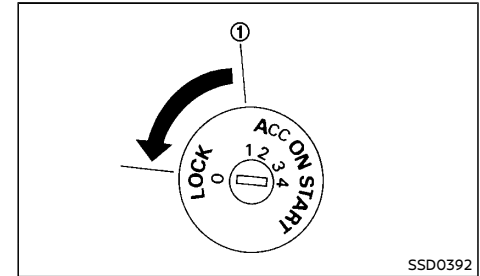

The ignition lock is designed so that the ignition switch cannot be turned to the "LOCK" position until the shift lever is moved to the "P" (Park) position. When moving the ignition switch to the "LOCK" position, to remove the key from the ignition switch, make sure the shift lever is in the "P" (Park) position.

When the ignition switch cannot be turned to the "LOCK" position:

1. Move the shift lever to the "P" (Park) position.
2. Turn the ignition switch slightly in the "ON" direction.
3. Place the ignition switch in the "LOCK" position.
4. Remove the key.

If the ignition switch is turned to the "LOCK" position, the shift lever cannot be moved from the "P" (Park) position. The shift lever can be moved if the ignition switch is in the "ON" position with the foot brake pedal depressed.

The "OFF" position ① is between the "LOCK" and "ON" positions, although it is not marked on the ignition switch.

## PUSH-BUTTON IGNITION SWITCH (models with Intelligent Key system)

### KEY POSITIONS

#### LOCK (Normal parking position) (0):

The ignition key can only be removed at this position.

#### OFF (1):

The engine can be turned off without locking the steering wheel.

#### ACC (Accessories) (2):

This position activates electrical accessories such as the radio when the engine is not running.

#### ON (Normal operating position) (3):

This position turns on the ignition system and electrical accessories.

#### START (4):

This position starts the engine. As soon as the engine has started, release the key immediately. It will automatically return to the "ON" position.

### PRECAUTIONS ON PUSH-BUTTON IGNITION SWITCH OPERATION



#### WARNING:

**Do not operate the push-button ignition switch while driving the vehicle except in an emergency. (The engine will stop when the ignition switch is pushed 3 consecutive times or the ignition switch is pushed and held for more than 2 seconds.) The steering wheel may lock and could cause the driver to lose control of the vehicle. This could result in serious vehicle damage or personal injury.**

### INTELLIGENT KEY SYSTEM

The Intelligent Key system can operate the ignition switch without taking the key out from your pocket or bag. The operating environment and/or conditions may affect the Intelligent Key system operation.

Some indicators and warnings for operation are displayed in the vehicle information display and/or in the meter. (See "Vehicle information display (models with color display)" (P.2-20) and "Warning lights, indicator lights and audible reminders" (P.2-13).)



#### CAUTION:

- **Be sure to carry the Intelligent Key with you when operating the vehicle.**
- **Never leave the Intelligent Key inside the vehicle when you leave the vehicle.**
- **If the vehicle battery is discharged, the ignition switch cannot be switched from the "LOCK" position, and if the steering lock is engaged, the steering wheel cannot be moved. Charge the battery as soon as possible. (See "Jump starting"**

#### (P.6-7.)

### Operating range

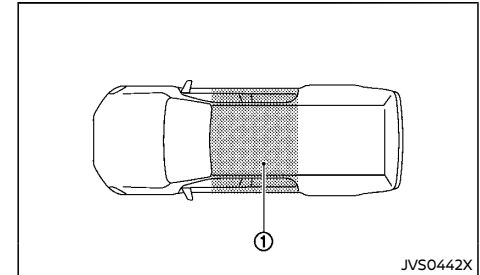

The Intelligent Key can only be used for starting the engine when the Intelligent Key is within the specified operating range ① as illustrated.

When the Intelligent Key battery is almost discharged or strong radio waves are present near the operating location, the Intelligent Key system's operating range becomes narrower and may not function properly.

If the Intelligent Key is within the operating range, it is possible for anyone, even someone who does not carry the Intelligent Key, to push the ignition switch to start the engine.

- The truck box area is not included in the operating range of the engine start function.
- If the Intelligent Key is placed on the instrument panel, inside the glove box, door pocket or the corner of the interior compartment, the Intelligent Key may not function.
- If the Intelligent Key is placed near the door or window outside the vehicle, the Intelligent Key may function.

## AUTOMATIC TRANSMISSION (AT)

The ignition lock is designed so that the ignition switch cannot be switched to the "LOCK" position until the shift lever is moved to the "P" (Park) position. When pushing the ignition switch to the "OFF" position, make sure the shift lever is in the "P" (Park) position.

When the ignition switch cannot be switched to the "LOCK" position:

1. "Shift to Park" warning appears on the vehicle information display and a chime sounds.
2. Move the shift lever to the "P" (Park) position.
3. If the ignition switch is in the "ACC" position, PUSH warning appears on the vehicle information display.
4. Push the ignition switch. The ignition switch is switched to the "OFF" position.
5. Open the door. The ignition switch turns to the "LOCK" position.

For warnings and indicators on the vehicle information display, see "Vehicle information display (models with color display)" (P.2-20).

If the ignition switch is switched to the "LOCK" position, the shift lever cannot be moved from the "P" (Park) position. The shift lever can be moved if the ignition switch is in the "ON" position with the foot brake pedal depressed.

## STEERING LOCK

The ignition switch is equipped with an anti-theft steering lock device.

### To lock steering wheel

1. Place the ignition switch in the "OFF" position where the ignition switch position indicator will not illuminate.
2. Open or close the door. The ignition switch turns to the "LOCK" position.
3. Turn the steering wheel 1/6 of a turn to the right or left from the straight up position.

### To unlock steering wheel

Push the ignition switch, and the steering wheel will be automatically unlocked.



### CAUTION:

- If the battery of the vehicle is discharged, the push-button ignition switch cannot be switched from the "LOCK" position.
- If the steering lock release malfunction indicator (if equipped) appears in the vehicle information display, push the ignition switch again while rotating the steering wheel slightly to the right and left. (See "Vehicle information display (models with color display)" (P.2-20).)

## IGNITION SWITCH POSITIONS



### WARNING:

Never place the ignition switch in the "OFF" position while driving. The steering wheel may lock and cause the driver to lose control of the vehicle, resulting in serious vehicle damage or personal injury.



### CAUTION:

- Do not leave the vehicle for extended periods of time when the ignition switch is in the "ON" position and the engine is not running. This can discharge the battery.
- Use electrical accessories with the engine running to avoid discharging the vehicle battery. If you must use accessories while the engine is not running, do not use them for extended periods of time and do not use multiple electrical accessories at the same time.

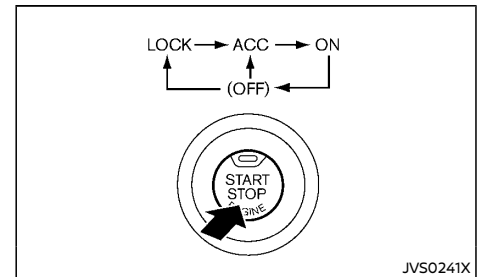

When the ignition switch is pushed without depressing the brake pedal (automatic transmission model) or the clutch pedal (manual

transmission model), the ignition switch position will change as follows:

- Push once to change to "ACC".
- Push two times to change to "ON".
- Push three times to change to "OFF".
- Push four times to return to "ACC".
- Open or close any door to return to "LOCK" from the "OFF" position.

### LOCK position

The ignition switch and steering lock can only be locked at this position.

The ignition switch will be unlocked when it is pushed to the "ACC" position while carrying the Intelligent Key.

### ACC position

The electrical accessory power activates at this position without the engine turned on.

### ON position

The ignition system and the electrical accessory power activate at this position without the engine turned on.

### OFF position

The engine is turned off with the steering wheel unlocked.

## INTELLIGENT KEY BATTERY DISCHARGE

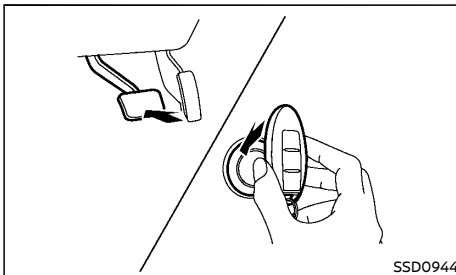

If the battery of the Intelligent Key is discharged, or environmental conditions interfere with the Intelligent Key operation, start the engine according to the following procedure:

#### 1. **Automatic Transmission (AT) model:**

Move the shift lever to the "P" (Park) position.

#### **Manual Transmission (MT) model:**

Move the shift lever to the "N" (Neutral) position.

#### 2. Firmly depress the brake pedal.

#### 3. Touch the ignition switch with the Intelligent Key as illustrated. (A chime will sound.)

#### 4. Push the ignition switch while depressing the brake pedal (AT model) or the clutch pedal (MT model) within 10 seconds after the chime sounds. The engine will start.

After step 3 is performed, when the ignition switch is pushed without depressing the brake pedal (AT model) or the clutch pedal (MT model), the ignition switch position will change to "ACC".

### NOTE:

- When the ignition switch is pushed to the "ACC" or "ON" position or the engine is started by the above procedures, the Key Battery low warning appears on the vehicle information display even if the Intelligent Key is inside the vehicle. This is not a malfunction. To turn off the warning, touch the ignition switch with the Intelligent Key again.
- If the Key Battery low warning appears on the vehicle information display, replace the battery as soon as possible. (See "Battery" (P.8-21).)

## STARTING ENGINE (models without Intelligent Key system)

1. Apply the parking brake.
2. Depress the foot brake pedal.
3. **Automatic Transmission (AT) model:**  
Move the shift lever to the "P" (Park) or the "N" (Neutral) position.

**The starter is designed to operate only when the shift lever is in the proper position.**

### Manual Transmission (MT) model:

Move the shift lever to the "N" (Neutral) position and depress the clutch pedal to the floor while starting the engine.

4. Crank the engine with your foot off the accelerator pedal by turning the ignition switch to the "START" position.

**For diesel engine models:** Turn the ignition switch to the "ON" position and wait until the glow plug indicator light  turns off.

5. Immediately release the ignition switch when the engine starts. If the engine starts, but fails to run, repeat the above procedures.

If the engine is very hard to start in extremely cold or hot weather, depress the accelerator pedal and hold it to help start the engine.



### CAUTION:

- **Do not operate the starter for more than 15 seconds at a time. If the engine does not start, turn the ignition switch off and wait 20 seconds before cranking the engine again. Otherwise, the starter could be damaged.**

- **If it becomes necessary to start the engine with a booster battery and jumper cables, the instructions and cautions contained in the "6. In case of emergency" section should be carefully followed.**
6. Allow the engine to idle for at least 30 seconds after starting the engine to warm-up. Drive at moderate speeds for a short distance first, especially in cold weather.



### CAUTION:

**Do not leave the vehicle unattended while the engine is warming up.**

## STARTING ENGINE (models with Intelligent Key system)

1. Apply the parking brake.
2. **Automatic Transmission (AT) model:**  
Move the shift lever to the "P" (Park) or the "N" (Neutral) position.

**The starter is designed to operate only when the shift lever is in the proper position.**

### Manual Transmission (MT) model:

Move the shift lever to the "N" (Neutral) position.

**The Intelligent Key must be carried when operating the ignition switch.**

3. Place the ignition switch in the "ON" position. Firmly depress the brake pedal (AT model) or the clutch pedal (MT model) and push the ignition switch to start the engine.

**For diesel engine models:** Wait until the glow plug indicator light  goes out.

If the engine is already warmed up, the glow plug indicator light may not illuminate when the engine is started.

To start the engine immediately, push and release the ignition switch while depressing the brake pedal or clutch pedal with the ignition switch in any position.

4. Immediately release the ignition switch when the engine starts. If the engine starts, but fails to run, repeat the above procedures.

If the engine is very hard to start in extremely cold or hot weather, depress the accelerator pedal and hold it. Push the ignition switch for up to 15 seconds while holding. Release the accelerator pedal when the engine starts.

## DRIVING VEHICLE

### CAUTION:

- As soon as the engine has started, release the ignition switch immediately.
  - Do not operate the starter for more than 15 seconds at a time. If the engine does not start, push the ignition switch to the "OFF" position and wait 20 seconds before cranking the engine again. Otherwise, the starter could be damaged.
  - If it becomes necessary to start the engine with a booster battery and jumper cables, the instructions and cautions contained in the "6. In case of emergency" section should be carefully followed.
5. Allow the engine to idle for at least 30 seconds after starting the engine to warm-up. Drive at moderate speeds for a short distance first, especially in cold weather.

### CAUTION:

Do not leave the vehicle unattended while the engine is warming up.

6. To stop the engine, move the shift lever to the "P" (Park) (AT model) or "N" (Neutral) (MT model) position, apply the parking brake, and push the ignition switch to the "OFF" position.

### DRIVING WITH AUTOMATIC TRANSMISSION (AT)

The Automatic Transmission (AT) in your vehicle is electronically controlled to produce maximum power and smooth operation.

The recommended operating procedures for this transmission are shown on the following pages. Follow these procedures for maximum vehicle performance and driving enjoyment.

### CAUTION:

- The cold engine idle speed is high, so use caution when shifting into a forward or reverse gear before the engine has warmed up.
- Avoid revving up the engine while the vehicle is stopped. This could cause unexpected vehicle movement.
- Do not downshift abruptly on slippery roads. This may cause a loss of control.
- Never shift to either the "P" (Park) or "R" (Reverse) position while the vehicle is moving forward and "P" (Park) or "D" (Drive) position while the vehicle is moving rearward. This could cause an accident or damage the transmission.
- Except in an emergency, do not shift to the "N" (Neutral) position while driving. Coasting with the transmission in the "N" (Neutral) position may cause serious damage to the transmission.
- Start the engine in either the "P" (Park) or "N" (Neutral) position. The engine will not start in any other gear position. If it does, have your vehicle checked by a NISSAN dealer.

- Shift into the "P" (Park) position and apply the parking brake when at a standstill for longer than a short waiting period.
- Keep the engine at idling speed while shifting from the "N" (Neutral) position to any driving position.
- When stopping the vehicle on an uphill grade, do not hold the vehicle by depressing the accelerator pedal. The foot brake pedal should be depressed in this situation.

### Starting vehicle

1. After starting the engine, fully depress the foot brake pedal before attempting to move the shift lever out of the "P" (Park) position.
2. Keep the foot brake pedal depressed and move the shift lever into a driving position.
3. Release the parking brake, the foot brake pedal, and then gradually start the vehicle in motion.

The AT is designed so the foot brake pedal **MUST** be depressed before shifting from the "P" (Park) position to any driving position while the ignition switch is in the "ON" position.

The shift lever cannot be moved out of the "P" (Park) position and into any of the other gear positions if the ignition switch is placed in the "LOCK", "OFF" or "ACC" position.

### CAUTION:

- **DEPRESS THE FOOT BRAKE PEDAL** - Shifting the shift lever to "D", "R" or manual shift mode without depressing the foot brake pedal causes the vehicle to move slowly when the engine is running. Make



sure the foot brake pedal is depressed fully and the vehicle is stopped before shifting the shift lever.

- **MAKE SURE OF THE SHIFT LEVER POSITION** - Make sure the shift lever is in the desired position. "D" and manual shift mode are used to move forward and "R" to back up. Depress the accelerator pedal to start the vehicle and merge with traffic (avoid abrupt starting and spinning the wheels).
- **WARM UP THE ENGINE** - Due to the higher idle speeds when the engine is cold, extra caution must be exercised when shifting the shift lever into the driving position immediately after starting the engine.
- **PARKING THE VEHICLE.**

Depress the foot brake pedal and, once the vehicle stops, move the shift lever into the "P" (Park) position, pull the parking brake lever and release the foot brake pedal.

### Shifting

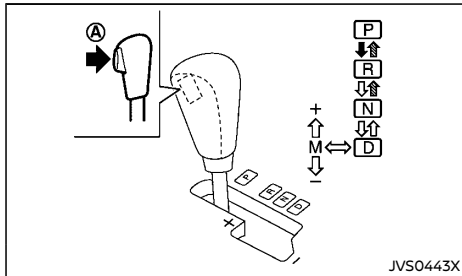

- ➔: Push the button (A) while depressing the brake pedal
- 👉: Push the button (A)
- ➔: Just move the shift lever



### WARNING:

- **Apply the parking brake if the shift lever is in any position while the engine is not running. Failure to do so could cause the vehicle to move unexpectedly or roll away and result in serious personal injury or property damage.**
- **If the shift lever cannot be moved from the "P" (Park) position while the engine is running and the foot brake pedal is depressed, the stop lights may not work. Malfunctioning stop lights could cause an accident injuring yourself and others.**

After starting the engine, fully depress the foot brake pedal, push the shift lever button and move the shift lever out of the "P" (Park) position.

If the ignition switch is placed in the "OFF" or "ACC" position for any reason while the shift lever is in any positions other than the "P" (Park) position, the ignition switch cannot be placed in the "LOCK" position.

If the ignition switch cannot be placed in the "LOCK" position, perform the following steps:

1. Apply the parking brake.
2. Place the ignition switch in the "ON" position while depressing the foot brake pedal.
3. Move the shift lever to the "P" (Park) position.
4. Place the ignition switch in the "LOCK" position.

### P (Park):

Use this position when the vehicle is parked or when starting the engine. **Make sure that the vehicle is completely stopped and move the shift lever into the "P" (Park) position.** Apply the parking brake. When parking on a hill, first depress the foot brake pedal, apply the parking brake, and then move the shift lever into the "P" (Park) position.

### R (Reverse):

Use this position to back up. Make sure that the vehicle is completely stopped before selecting the "R" (Reverse) position.

### N (Neutral):

Neither the forward nor reverse gear is engaged. The engine can be started in this position. You may shift to the "N" (Neutral) position and restart a stalled engine while the vehicle is moving.

### D (Drive):

Use this position for all normal forward driving.

### Manual shift mode

When the shift lever is shifted to the manual shift gate and moved up or down while driving, the transmission enters the manual shift mode. Shift range can be selected manually.

When shifting up, move the shift lever to the + (up) side. The transmission shifts to the higher range.

When shifting down, move the shift lever to the - (down) side. The transmission shifts to the lower range.

When canceling the manual shift mode, return the shift lever to the "D" (Drive) position. The transmission returns to the normal driving mode.

In the manual shift mode, the shift range is displayed in the vehicle information display between the speedometer and tachometer.

Shift ranges up or down one by one as follows:

M<sub>1</sub> → M<sub>2</sub> → M<sub>3</sub> → M<sub>4</sub> → M<sub>5</sub> → M<sub>6</sub> → M<sub>7</sub>  
← ← ← ← ← ← ←

M<sub>7</sub> (7th):

Use this position for all normal forward driving at highway speeds.

M<sub>6</sub> (6th) and M<sub>5</sub> (5th):

Use these positions when driving up long slopes, or for engine braking when driving down long slopes.

M<sub>4</sub> (4th), M<sub>3</sub> (3rd) and M<sub>2</sub> (2nd):

Use these positions for hill climbing or engine braking on downhill grades.

M<sub>1</sub> (1st):

Use this position when climbing steep hills slowly or driving slowly through deep snow, or for maximum engine braking on steep downhill grades.

- Remember not to drive at high speeds for extended periods of time in lower than 7th gear. This reduces fuel economy.
- Moving the shift lever to the same side twice will shift the ranges in succession. However, if this motion is rapidly done, the second shifting may not be completed properly.
- **In the manual shift mode, the transmission may not shift to the selected gear or may automatically shift to the other gear. This helps maintain driving performance and reduces the chance of vehicle damage or loss of control.**

- **When the transmission does not shift to the selected gear, the Automatic Transmission (AT) position indicator light (in the vehicle information display) will blink and the buzzer will sound.**
- **In the manual shift mode, the transmission automatically shifts down to 1st gear before the vehicle comes to a stop. When accelerating again, it is necessary to shift up to the desired range.**

Accelerator downshift - in D (Drive) position -

For passing or climbing hills, depress the accelerator pedal to the floor. This shifts the transmission down into a lower gear, depending on the vehicle speed.

Shift lock release

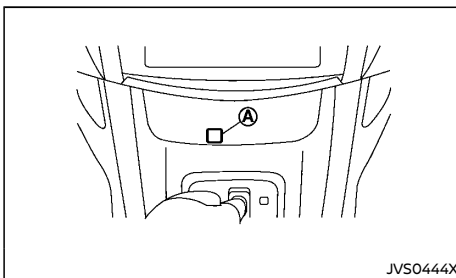

If the battery is discharged, the shift lever may not be moved from the "P" (Park) position even with the brake pedal depressed.

To release the shift lock, perform the following procedure:

1. Place the ignition switch in the "OFF" or "LOCK" position.

2. Apply the parking brake.
3. Push down the shift lock release button (A).
4. Push and hold the shift lever button and move the shift lever to the "N" (Neutral) position while holding down the shift lock release button (A).

Place the ignition switch in the "ON" position to release the steering wheel lock.

The vehicle may be moved, by pushing, to the desired location.

If the shift lever cannot be moved out of the "P" (Park) position, have a NISSAN dealer check the AT system as soon as possible.

Fail-safe

When the fail-safe operation occurs, the AT will be locked in any of the forward gears depending on conditions.

**If the vehicle is driven under extreme conditions, such as excessive wheel spinning and subsequent hard braking, the fail-safe system may be activated. This will occur even if all electrical circuits are functioning properly. In this case, place the ignition switch in the "OFF" position and wait for 3 seconds. Then place the ignition switch back in the "ON" position. The vehicle should return to its normal operating condition. If it does not return to its normal operating condition, have a NISSAN dealer check the transmission and repair it if necessary.**

## DRIVING WITH MANUAL TRANSMISSION (MT)



### WARNING:

- Do not downshift abruptly on slippery roads. This may cause a loss of control.
- Do not over-rev the engine when shifting to a lower gear. This may cause a loss of vehicle control or engine damage.



### CAUTION:

- Do not rest your foot on the clutch pedal while driving. This may damage the clutch system.
- Fully depress the clutch pedal before shifting to help prevent transmission damage.
- Stop the vehicle completely before shifting into the "R" (Reverse) position.
- When the vehicle is stopped for a period of time, for example, waiting at stoplights, shift to the "N" (Neutral) position and release the clutch pedal with the foot brake pedal depressed.

## Starting vehicle

1. After starting the engine, depress the clutch pedal to the floor and move the shift lever to the "1" (1st), "2" (2nd) or "R" (Reverse) position. NISSAN recommends to start the vehicle in 2nd gear on level, flat ground and in the unladen condition.
2. Slowly depress the accelerator pedal, releasing the clutch pedal and parking brake at the same time.

## Shifting gear

To change gears, or when upshifting or downshifting, fully depress the clutch pedal, shift into the appropriate gear, then slowly and smoothly release the clutch pedal.

Start the vehicle in the "1" (1st) or "2" (2nd) position and shift to the "3" (3rd), "4" (4th), "5" (5th) and "6" (6th) gear in sequence according to the vehicle speed.

If it is difficult to move the shift lever into the "R" (Reverse) or "1" (1st) position, shift to the "N" (Neutral) position, and then release the clutch pedal once. Fully depress the clutch pedal again and shift into "R" or "1".

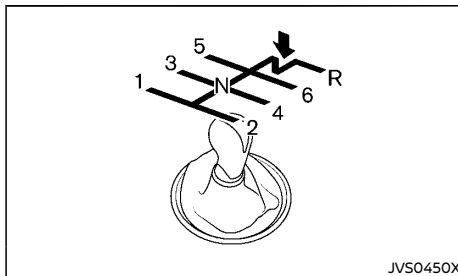

To back up, depress the shift lever and then move it to the "R" (Reverse) position after the vehicle has completely stopped.

## FOUR-WHEEL DRIVE (4WD) (if equipped)



### WARNING:

- Do not attempt to raise two wheels off the ground and shift the transmission to any drive or reverse position with the engine running. Doing so may result in drivetrain damage or unexpected vehicle movement which could result in serious vehicle damage or personal injury.
- Do not attempt to test a 4WD equipped vehicle on a 2-wheel dynamometer or similar equipment even if the other two wheels are raised off the ground. Make sure you inform test facility personnel that your vehicle is equipped with 4WD before it is placed on a dynamometer. Using the wrong test equipment may result in drivetrain damage or unexpected vehicle movement which could result in serious vehicle damage or personal injury.



### CAUTION:

- Do not drive the vehicle in the 4H or 4LO position on dry hard surface roads. Driving on dry, hard surfaces in 4H or 4LO may cause unnecessary noise, tire wear and increased fuel consumption.

If the Four-Wheel Drive (4WD) warning light turns on when driving on dry hard surface roads:

- in the 4H position, shift the 4WD mode switch to 2WD.
- in the 4LO position, stop the vehicle and shift the transmission lever to the "N" (Neutral) position with the brake pedal depressed and shift the 4WD mode switch to 2WD.

If the 4WD warning light is still on after the above operation, have your vehicle checked by a NISSAN dealer as soon as possible.

- The transfer case may be damaged if you continue driving with the 4WD warning light blinking.

See "On-pavement and off-road driving precautions" (P.5-7) for other precautions.

### PART TIME 4WD SYSTEM



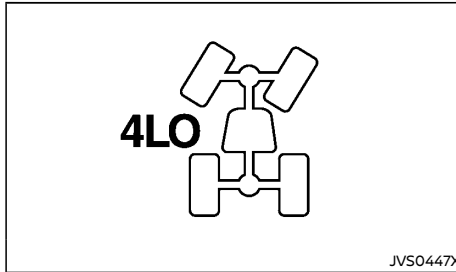

The part time 4WD system provides three drive modes: 2WD, 4H and 4LO. The desired drive mode can be selected using the 4WD mode switch according to the driving conditions.

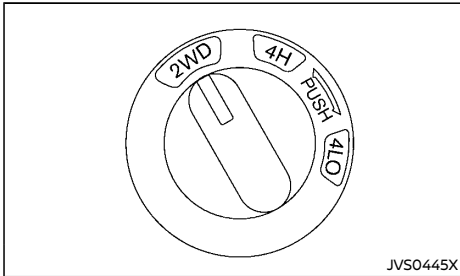

4WD mode indicator



4WD mode switch

4WD mode switch	Wheels driven	Indicator		Use conditions	Operation of 4WD mode switch (See "4WD mode switch operation" (P.5-20).)
		4WD mode	4LO		
2WD	Rear wheels		-	For driving on dry, paved roads.	Shifting between the 2WD and 4H drive modes can be done while driving. The indicator will change when the drive mode is changed. Shifting between the 2WD and 4H modes must be performed at speed below 100 km/h (60 MPH).
4H	Four wheels		-	For driving on rough, sandy or snow-covered roads.	
	Neutral		Blinking	The 4LO indicator blinks when shifting between 4H and 4LO.	Shifting between the 4H and 4LO drive modes: <ul style="list-style-type: none"> <li>• Stop the vehicle, depress the clutch pedal (MT models) and the brake pedal and shift the shift lever to the N (Neutral) position.</li> <li>• Depress and turn the 4WD mode switch. The 4WD mode switch will not shift between 4H and 4LO if the transmission is not in the N (Neutral) position or the vehicle is moving.</li> <li>• Wait for the 4LO indicator to stop blinking and stay on or off before shifting your transmission into gear or releasing the clutch pedal (MT models).</li> </ul>
4LO	Four wheels		Stay on*	For use when maximum power and traction are required at low speeds (for example, on steep grades or rocky, sandy, muddy roads).	

\*: When the 4LO position is selected, the VDC system is disabled and the VDC off indicator light illuminates. See "Vehicle Dynamic Control (VDC) off indicator light" (P.2-19).



### WARNING:

**AT model:** If the 4WD mode indicator is "OFF" or the ATP warning light is "ON", this indicates that the automatic transmission P (Park) position will not function and could result in the vehicle moving unexpectedly, causing serious personal injury or property damage. Always set the parking brake.



### CAUTION:

To avoid vehicle damage:

- Do not operate the 4WD mode switch when cornering, reversing or if the rear wheels are spinning freely. The vehicle must be moving straight ahead.
- Do not move the shift lever (AT model) or release the clutch pedal (MT model) when the 4LO indicator is blinking. Failure to do this may cause the gears to grind and damaging the powertrain.
- MT model: Do not accelerate rapidly from a stopped position when the 4LO indicator is blinking. Drive straight ahead at a low speed until the 4LO indicator is lit. The 4LO indicator blinks when shifting between 4LO and 4H.

- If the 4WD warning light comes on, perform the following procedure:

1. Turn off the engine.
2. Start the engine.
3. Check if the 4WD warning light comes on.

**If the 4WD warning light is still on after following the above procedure, have the system checked and serviced immediately by a NISSAN dealer.**

The transfer case 4WD mode switch is used to select either Two-Wheel Drive (2WD) or Four-Wheel Drive (4WD) depending on the driving conditions. Turn the 4WD mode switch to select a drive mode (2WD, 4H or 4LO).

To change into or out of 4LO mode:

1. The vehicle **MUST BE** standing still.
2. Depress the clutch pedal (MT model) and the brake pedal and move the shift lever to N (Neutral).
3. Depress and turn the 4WD mode switch to change into or out of 4LO.



#### **WARNING:**

- When parking, apply the parking brake before stopping the engine and make sure that the 4WD mode indicator is on and that the ATP warning light or ATP warning message is off, otherwise, the vehicle could unexpectedly move even if the automatic transmission is in the P (Park) position.
- The 4LO indicator must stop blinking and remain on or turn off before shifting the transmission into gear. The vehicle may move unexpectedly if the shift lever is shifted from the N (Neutral) position to any other gear while the 4LO indicator is blinking.



#### **CAUTION:**

- Never turn the 4WD mode switch between 4LO and 4H while driving.
- The 4H drive mode provides greater power and traction. Avoid excessive speed as it will cause increased fuel consumption and higher oil temperatures, and could damage power train components. Speeds over 100 km/h (60 MPH) in 4H are not recommended.
- The 4LO drive mode provides maximum power and traction. Avoid raising vehicle speed excessively. The maximum speed

is approximately 50 km/h (30 MPH).

- The 4WD mode switch can be turned between 2WD and 4H while driving straight ahead. Do not turn the 4WD mode switch while making a turn or reversing.
- Do not turn the 4WD mode switch between 2WD and 4H while driving on steep downhill grades. Use the engine brake and low transmission gears for engine braking.
- Do not turn the 4WD mode switch between 2WD and 4H with the rear wheels spinning.
- Do not drive the vehicle in 4H or 4LO mode on dry, hard surfaced roads. This may cause unnecessary noise and tire wear. NISSAN recommends driving in 2WD under these conditions.
- It is not possible to shift the 4WD transfer case between 4H and 4LO at low ambient temperatures when the engine is cold. Doing so may cause the 4LO indicator to blink. Wait until the 4WD transfer case has reached operational temperature (after driving for a while) before using the 4WD mode switch to change between 4H and 4LO.

When driving on rough roads

- Set the 4WD mode switch to 4H or 4LO.
- Drive carefully and according to the road surface conditions.

If the vehicle gets stuck

- Place stones or wooden blocks under the tires to free the vehicle.
- Set the 4WD mode switch to 4H or 4LO.
- If it is difficult to free the vehicle, drive the vehicle forwards and backwards to increase the momentum. If the vehicle is stuck deep in mud, tire chains may be effective.



#### **CAUTION:**

- Do not spin the wheels excessively. The wheels will sink deep into the mud and it will be difficult to free the vehicle from the mud.
- Avoid shifting gears with the engine running at high speeds as this may cause a malfunction.

#### 4WD MODE SWITCH OPERATION

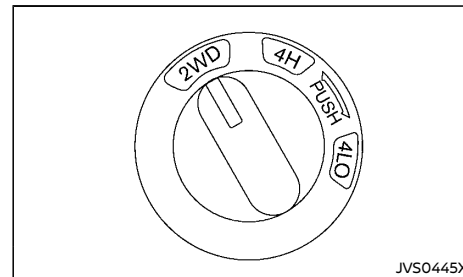

- Set the 4WD mode switch to 2WD, 4H or 4LO, depending on driving conditions.
- You may feel a slight vehicle movement if the 4WD mode switch is operated while making a turn, accelerating or decelerating, or if the ignition switch is placed in the

"OFF" position while the 4WD mode switch is set to 4H or 4LO. This is normal.

**CAUTION:**

- The 4WD mode switch can be turned between 2WD and 4H while driving straight ahead. Do not turn the 4WD mode switch while making a turn or reversing.
- Do not operate the 4WD mode switch while driving on steep downhill grades. Use the engine brake by setting a low transmission gear.
- Do not operate the 4WD mode switch with the rear wheels spinning.
- Before turning the 4WD mode switch to 4H from 2WD, make sure that the vehicle speed is less than 100 km/h (60 MPH). Failure to do so can damage the 4WD system.
- Never turn the 4WD mode switch between 4LO and 4H while driving.

**4WD MODE INDICATOR**

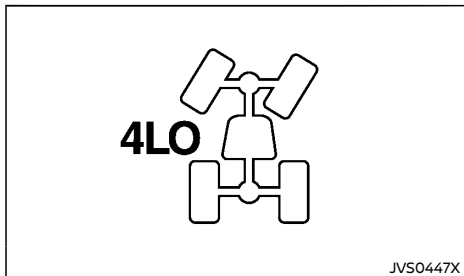



The 4WD mode indicator is displayed in the vehicle information display.

While the engine is running, the 4WD mode indicator will illuminate the position selected by the 4WD mode switch.

- The 4WD mode indicator may blink while shifting from one drive mode to the other. When the shifting is completed, the 4WD mode indicator will come on. If the indicator does not come on immediately, make sure the area around the vehicle is safe, and drive the vehicle straight, accelerate or decelerate or move the vehicle in reverse, then shift the 4WD mode switch.
- If the 4WD warning light comes on or 4WD Error warning (if equipped) appears, the 4WD mode indicator turns off.

**4WD WARNING**

**Warning light**

Warning light	Comes on or blinks when:
 Illuminates	There is a malfunction in the 4WD system
 Blinks	The difference in wheel rotation is large

If the 4WD warning light comes on, the 4WD mode indicator turns off.

A large difference between the diameters of front and rear wheels will make the 4WD warning light blink. Change the 4WD mode switch to 2WD and do not drive fast.

**CAUTION:**

- If the 4WD warning light comes on or blinks during operation for a while, have your vehicle checked by a NISSAN dealer as soon as possible.
- Shifting between 4H and 4LO is not recommended when the 4WD warning light turns on.
- When the 4WD warning light comes on, the 2WD mode may be engaged even if the 4WD mode switch is in 4H. Be especially careful when driving. If corresponding parts are malfunctioning, the 4WD mode will not be engaged even if the 4WD mode switch is shifted.
- Do not drive the vehicle in the 4H or 4LO position on dry hard surface roads. Driving on dry, hard surfaces in 4H or 4LO may cause unnecessary noise, tire wear and increased fuel consumption.

If the Four-Wheel Drive (4WD) warning light turns on when driving on dry hard surface roads:

- in the 4H position, shift the 4WD mode switch to 2WD.
- in the 4LO position, stop the vehicle and shift the transmission lever to the "N" (Neutral) position with the brake pedal depressed and shift the 4WD mode switch to 2WD.

If the 4WD warning light is still on after the above operation, have your vehicle checked by a NISSAN dealer as soon as possible.

- The transfer case may be damaged if you continue driving with the warning light

blinking.

Warning indicator (models with color display)

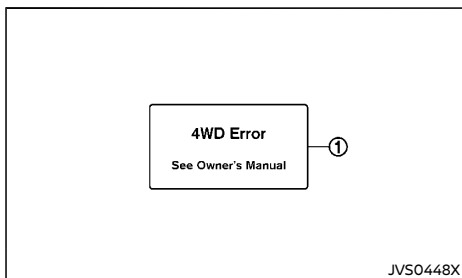

If any malfunction occurs in the Four-Wheel Drive (4WD) system while the engine is running, a warning message appears in the vehicle information display.

If the "4WD Error" warning ① appears, there may be a malfunction in the 4WD system. Reduce vehicle speed and have your vehicle checked by a NISSAN dealer as soon as possible.



#### CAUTION:

- **Do not operate the engine on a free roller when any of the wheels raised.**
- **If the "4WD Error" warning appears while driving, there may be a malfunction in the 4WD system. Reduce the vehicle speed and have your vehicle checked by a NISSAN dealer as soon as possible. Be especially careful when driving.**
- **The power train may be damaged if you continue driving with the "4WD Error" warning on.**

## TIRE RECOMMENDATION FOR 4WD



#### CAUTION:

- **Always use tires of the same size, brand, construction (bias, bias-belted or radial), and tread pattern on all four wheels. Failure to do so may result in a circumference difference between tires on the front and rear axles, which will cause excessive tire wear and may damage the transmission, transfer case and differential gears.**
- **ONLY use spare tires specified for the Four-Wheel Drive (4WD) models.**

If excessive tire wear is found, it is recommended that all four tires be replaced with tires of the same size, brand, construction and tread pattern. The tire pressure and wheel alignment should also be checked and corrected as necessary. Contact a NISSAN dealer.

### Snow tires

If you install snow tires, they must also be of the same size, brand, construction and tread pattern on all four wheels.

### Tire inflation pressure

Periodically check the pressures of all tires, including the spare, with a gauge while at a service station. If necessary, adjust to the specified pressure. Tire pressures are shown on the tire placard affixed to the driver's side center pillar or rear access door.

### Tire rotation

NISSAN recommends that tires should be rotated every 5,000 km (3,000 miles).

### Snow chains

**Snow chains must be installed only on the rear wheels and not on the front wheels.**

Do not drive with snow chains on paved roads that are clear of snow. Driving with chains in such conditions can cause damage to the various mechanisms of the vehicle due to overstress. When driving on clear paved roads, be sure to change to Two-Wheel Drive (2WD) mode.



## REAR DIFFERENTIAL LOCKING SYSTEM (if equipped)

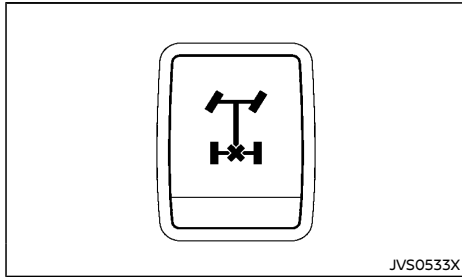

The rear differential lock is designed to transmit engine power to the left and right wheels equally.

If your vehicle is stuck in sand, snow, mud, etc. or one wheel is off the ground and the differential lock is not on, engine power is transmitted to one wheel causing it to spin, so leaving insufficient traction on the other wheel. The rear differential lock allows the left and right wheels to rotate as a unit, enabling your vehicle to free itself.

To lock the rear differential gear, reduce the vehicle speed below 7 km/h (4 MPH) and turn the 4WD mode switch to the 4LO position. Then push the differential lock mode switch to the "ON" position. The differential lock indicator light "  " will blink in the meter and then stay on when the differential gear is completely locked.

After using the rear differential lock, or during normal driving, push the differential lock mode switch to the "OFF" position. The differential lock indicator light will turn off after the differential lock is released.

- **The rear differential lock-up device operates only when the engine is running.**

- In 4H mode, the rear differential lock-up device does not operate when the differential lock mode switch is turned to the "ON" position. (The differential lock indicator light will flash.)





### WARNING:

- Use the rear differential lock only in an emergency when it is not possible to free a stuck vehicle even using the 4LO position.
- When the differential lock is in operation, turning the vehicle becomes hard and, especially at high speeds, is dangerous.
- While differential lock is on, the Anti-lock Braking System (ABS) warning light and the Vehicle Dynamic Control (VDC) off indicator light illuminate. This indicates that anti-lock function may not fully operate.
- Do not operate the differential lock when the vehicle is turning or when one side wheel is rotating. Otherwise the power train system parts could be damaged.
- Avoid quick starts while the differential lock is in operation. Otherwise the power train system parts could be damaged.

Observe the above precautions. Otherwise, loss of normal steering control may result.

## VEHICLE DYNAMIC CONTROL (VDC) SYSTEM (if equipped)

### WARNING:

- The Vehicle Dynamic Control (VDC) system is designed to help the driver maintain stability but does not prevent accidents due to abrupt steering operation at high speeds or by careless or dangerous driving techniques. Reduce vehicle speed and be especially careful when driving and cornering on slippery surfaces and always drive carefully.
- Do not modify the vehicle's suspension. If suspension parts such as shock absorbers, struts, springs, stabilizer bars, bushings and wheels are not NISSAN recommended for your vehicle or are extremely deteriorated, the VDC system may not operate properly. This could adversely affect vehicle handling performance, and the VDC warning light  may illuminate.
- If brake related parts such as brake pads, rotors and calipers are not NISSAN recommended or are extremely deteriorated, the VDC system may not operate properly and the VDC warning light  may illuminate.
- If engine control related parts are not NISSAN recommended or are extremely deteriorated, the VDC warning light  may illuminate.
- When driving on extremely inclined surfaces such as higher banked corners, the VDC system may not operate properly and the VDC warning light  may illuminate. Do not drive on these types of roads.
- When driving on an unstable surface such as a turntable, ferry, elevator or ramp, the

**VDC warning light  may illuminate. This is not a malfunction. Restart the engine after driving onto a stable surface.**

- **If wheels or tires other than the NISSAN recommended ones are used, the VDC system may not operate properly and the VDC warning light  may illuminate.**
- **The VDC system is not a substitute for winter tires or tire chains on a snow covered road.**

The Vehicle Dynamic Control (VDC) system uses various sensors to monitor driver inputs and vehicle motion. Under certain driving conditions, the VDC system helps to perform the following functions.



- Controls brake pressure to reduce wheel slip on one slipping drive wheel so power is transferred to a non slipping drive wheel on the same axle.
- Controls brake pressure and engine output to reduce drive wheel slip based on vehicle speed (traction control function).
- Controls brake pressure at individual wheels and engine output to help the driver maintain control of the vehicle in the following conditions:
  - understeer (vehicle tends to not follow the steered path despite increased steering input)
  - oversteer (vehicle tends to spin due to certain road or driving conditions).

The VDC system can help the driver to maintain control of the vehicle, but it cannot prevent loss of vehicle control in all driving situations.

When the VDC system operates, the VDC warning light  in the instrument panel flashes so note the following:

- The road may be slippery or the system may determine some action is required to help the vehicle on the steered path.
- You may feel a pulsation in the brake pedal and hear a noise or vibration from under the hood. This is normal and indicates that the VDC system is working properly.
- Adjust your speed and driving to the road conditions.

If a malfunction occurs in the system, the VDC warning light  illuminates in the instrument panel. The VDC system automatically turns off.

The VDC OFF switch is used to turn off the VDC system. The VDC off indicator light  illuminates to indicate the VDC system is off. When the VDC OFF switch is used to turn off the system, the VDC system still operates to prevent one drive wheel from slipping by transferring power to a non slipping drive wheel. The VDC warning light  flashes if this occurs. All other VDC functions are off and the VDC warning light  will not flash. The VDC system is automatically reset to on when the ignition switch is placed in the "OFF" position then back to the "ON" position.

When the 4LO position is selected with the Four-Wheel Drive (4WD) mode switch, the VDC system is disabled and the VDC off indicator light illuminates.

See "Vehicle Dynamic Control (VDC) warning light" (P.2-17) and "Vehicle Dynamic Control (VDC) off indicator light" (P.2-19).

The computer has a built-in diagnostic feature that tests the system each time you start the engine and move the vehicle forward or in reverse at a slow speed. When the self-test occurs, you may hear a "clunk" noise and/or feel a pulsation in the brake pedal. This is normal and is not an indication of a malfunction.

## VEHICLE DYNAMIC CONTROL (VDC) OFF SWITCH

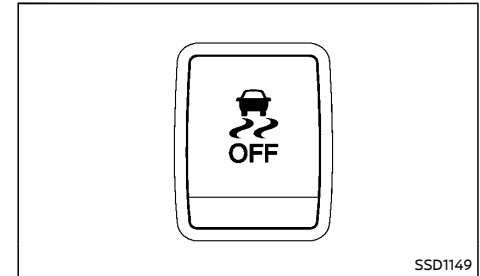

The vehicle should be driven with the Vehicle Dynamic Control (VDC) system ON for most driving conditions.

When the vehicle is stuck in mud or snow, the VDC system reduces the engine output to reduce wheel spin. The engine speed will be reduced even if the accelerator is depressed to the floor. If maximum engine power is needed to free a stuck vehicle, turn the VDC system off.

To turn off the Vehicle Dynamic Control (VDC) system, push the VDC OFF switch. The VDC off indicator light  will illuminate.

Push the VDC OFF switch again or restart the engine to turn ON the system.

## HILL DESCENT CONTROL SYSTEM (if equipped)



### WARNING:

- Never rely solely on the hill descent control system to control vehicle speed when driving on steep downhill grades. Always drive carefully when using the hill descent control system and decelerate the vehicle speed by depressing the brake pedal if necessary. Be especially careful when driving on frozen, muddy or extremely steep downhill roads. Failure to control vehicle speed may result in a loss of control of the vehicle and possible serious injury or death.
- The hill descent control system may not control the vehicle speed on a hill under all load or road conditions. Always be prepared to depress the brake pedal to control vehicle speed. Failure to do so may result in a collision or serious personal injury.

When the hill descent control system is activated, it automatically applies smooth brakes to control speed on a steep and slippery descent or off the road without brake or accelerator operation. The hill descent control system helps maintain vehicle speed when driving under 25 km/h (16 MPH) on a steep descent that engine braking alone in the 4H or 4LO mode cannot control the speed.

### NOTE:

When the hill descent control system operates continuously for a long time, the temperature of the Vehicle Dynamic Control (VDC) system actuator may increase and the hill descent control system may be temporarily disabled. The hill descent control system on indicator light will turn off. The hill descent control system will resume operat-

ing automatically and the indicator light will illuminate again when the temperature of the VDC system actuator is reduced. If the indicator light does not illuminate, turn off the system.

### HILL DESCENT CONTROL SWITCH

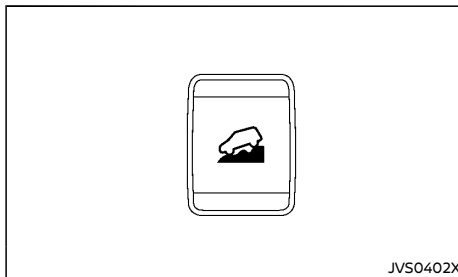

When additional braking is required on steep downhill roads, activate the hill descent control system by pushing the hill descent control switch on.

When the hill descent control system is activated, the hill descent control system on indicator light will illuminate. (See "Hill descent control system ON indicator light" (P.2-18).) Also, the stop/tail lights illuminate while the hill descent control system is applying the brakes to control the vehicle speed.

To activate the hill descent control system, satisfy all of the following conditions:

- Shift the transmission to the forward (only 1st gear for MT model) or reverse gear.
- Shift the 4WD mode switch to the 4H or 4LO position and drive the vehicle at a speed under 25 km/h (16 MPH).

- Push the hill descent control switch to the "ON" position.

If the accelerator or brake pedal is depressed while the hill descent control system is on, the system will stop operating temporarily. As soon as the accelerator or brake pedal is released, the hill descent control system begins to function again if the hill descent control operating conditions are fulfilled.

The hill descent control system on indicator light blinks if the hill descent control switch is on and all conditions for system activation are not met, or if the system becomes disengaged for any reason.

To turn off the hill descent control system, push the hill descent control switch to the "OFF" position.

## HILL START ASSIST SYSTEM (if equipped)



### WARNING:

- **Never rely solely on the hill start assist system to prevent the vehicle from moving backward on a hill. Always drive carefully and attentively. Depress the brake pedal when the vehicle is stopped on a steep hill. Be especially careful when stopped on a hill on frozen or muddy roads. Failure to prevent the vehicle from rolling backwards may result in a loss of control of the vehicle and possible serious injury or death.**
- **The hill start assist system is not designed to hold the vehicle at a standstill on a hill. Depress the brake pedal when the vehicle is stopped on a steep hill. Failure to do so may cause the vehicle to roll backwards and may result in a collision or serious personal injury.**
- **The hill start assist system may not prevent the vehicle from rolling backwards on a hill under all load or road conditions. Always be prepared to depress the brake pedal to prevent the vehicle from rolling backwards. Failure to do so may result in a collision or serious personal injury.**

The hill start assist system automatically keeps the brakes applied to help prevent the vehicle from rolling backwards in the time it takes the driver to release the brake pedal and apply the accelerator when the vehicle is stopped on a hill.

The hill start assist system will operate automatically under the following conditions:

- The transmission is shifted to a forward or reverse gear.

- The vehicle is stopped completely on a hill by applying the brake.

The maximum holding time is 2 seconds. After 2 seconds the vehicle will begin to roll back and the hill start assist system will stop operating completely.

The hill start assist system will not operate when the transmission is shifted to the "N" (Neutral) or "P" (Park) position or on a flat and level road.

When the Vehicle Dynamic Control (VDC) warning light illuminates in the meter, the hill start assist system will not operate. (See "Warning lights, indicator lights and audible reminders" (P.2-13).)

## CRUISE CONTROL (if equipped)

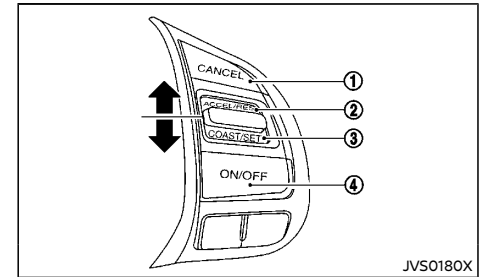

1. CANCEL switch
2. ACCELERATE/RESUME switch
3. COAST/SET switch
4. Cruise control MAIN switch



### WARNING:

- **Always observe the posted speed limits and do not set the speed over them.**
- **Do not use the cruise control when driving under the following conditions. Doing so could cause a loss of vehicle control and result in an accident.**
  - **When it is not possible to keep the vehicle at a constant speed**
  - **When driving in heavy traffic**
  - **When driving in traffic that varies speed**
  - **When driving in windy areas**
  - **When driving on winding or hilly roads**
  - **When driving on slippery (rain, snow, ice, etc.) roads**



### CAUTION:

**On manual Transmission (MT) model, do not shift to the "N" (Neutral) position without depressing the clutch pedal when the cruise control is operated. Should this occur, depress the clutch pedal and turn the cruise control MAIN switch off immediately. Failure to do so may cause engine damage.**

### PRECAUTIONS ON CRUISE CONTROL

- If the cruise control system malfunctions, it will cancel automatically. The CRUISE or SET (if equipped) indicator in the vehicle information display will then blink to warn the driver.
- If the CRUISE or SET indicator blinks, turn the cruise control MAIN switch off and have the system checked by a NISSAN dealer.
- The CRUISE or SET indicator may blink when the cruise control MAIN switch is turned ON while pushing the ACCELERATE/RESUME, COAST/SET or CANCEL switch. To properly set the cruise control system, perform the following procedures.

### CRUISE CONTROL OPERATIONS

The cruise control allows driving at speeds above 40 km/h (25 MPH) without keeping your foot on the accelerator pedal.

Except for YS23DDT/DDTT engine models, the cruise control will automatically be canceled if the vehicle slows down more than approximately 13 km/h (8 MPH) below the set speed.

For YS23DDT/DDTT engine models, the cruise control will automatically be canceled if the vehicle speed slows to less than approximately 33 km/h (21 MPH).

Moving the shift lever to the "N" (Neutral)

position (Automatic Transmission models) or depressing the clutch pedal (Manual Transmission models) will cancel the cruise control.

### Turning on cruise control

Push the cruise control MAIN switch ④. The CRUISE indicator appears.

### Setting cruising speed

1. Accelerate to the desired speed.
2. Push the COAST/SET switch ③ and release it.
3. Take your foot off the accelerator pedal.

The vehicle will maintain the set speed.

### Passing another vehicle:

Depress the accelerator pedal to accelerate. After releasing the accelerator pedal, the vehicle will return to the previously set speed.

The vehicle may not maintain the set speed when going up or down steep hills. In such cases, drive without the cruise control.

### Resetting to slower speed:

Use any one of the following methods to reset to a slower speed.

- Lightly tap the foot brake pedal. When the vehicle reaches the desired speed, push and release the COAST/SET switch ③.
- Push and hold the COAST/SET switch ③. When the vehicle reaches the desired speed, release the COAST/SET switch ③.
- Quickly push and release the COAST/SET switch ③. This will reduce the vehicle speed by about 1 km/h (0.6 MPH).

### Resetting to faster speed:

Use any one of the following methods to reset to a faster speed.

- Depress the accelerator pedal. When the vehicle reaches the desired speed, push and release the COAST/SET switch ③.
- Push and hold the ACCELERATE/RESUME switch ②. When the vehicle reaches the desired speed, release the ACCELERATE/RESUME switch ②.
- Quickly push and release the ACCELERATE/RESUME switch ②. This will increase the vehicle speed by about 1 km/h (0.6 MPH).

### Resuming at preset speed:

Push and release the ACCELERATE/RESUME switch ②.

The vehicle will resume the last set cruising speed when the vehicle speed is over 40 km/h (25 MPH).

### Canceling cruising speed

Use any one of the following methods to cancel the set speed.

- Push the CANCEL switch ①.
- Tap the foot brake pedal.
- Push the cruise control MAIN switch ④. The CRUISE indicator will turn off.

## ECO DRIVE REPORT (if equipped)

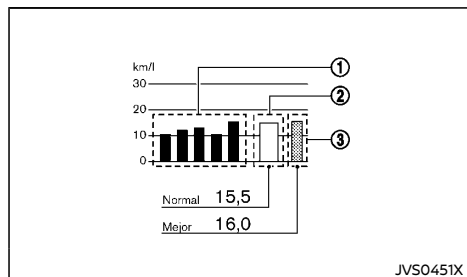

When the ignition switch is in the "OFF" position, ECO management display appears.

- ① Previous 5 times (History)
- ② Current fuel economy
- ③ Best fuel economy

The result of ECO evaluation is displayed 30 seconds after the ignition switch is placed in the on position and the vehicle is driven at least 500 meters (1/3 miles).

- ①: The average fuel economy for the previous 5 times will be displayed.
- ②: The average fuel economy since the last reset will be displayed.
- ③: The best fuel economy of the past history will be displayed.

The ECO drive report can be set to be "ON" or "OFF". See "Settings" (P.2-27).

## FUEL EFFICIENCY AND CARBON DIOXIDE REDUCTION DRIVING TIPS

Follow these easy-to-use Fuel Efficiency and Carbon Dioxide Reduction Driving Tips to help you achieve the most fuel economy from your vehicle and reduce carbon dioxide emissions.

1. Use smooth accelerator and brake pedal application.
  - Avoid rapid starts and stops.
  - Use smooth, gentle accelerator and brake application whenever possible.
  - Maintain constant speed while commuting and coast whenever possible.
2. Maintain constant speed.
  - Look ahead to try and anticipate and minimize stops.
  - Synchronizing your speed with traffic lights allows you to reduce your number of stops.
  - Maintaining a steady speed can minimize red light stops and improve fuel efficiency.
3. Drive at economical speeds and distances.
  - Observing the speed limit and not exceeding 97 km/h (60 MPH) (where legally allowed) can improve fuel efficiency due to reduced aerodynamic drag.
  - Maintaining a safe following distance behind other vehicles reduces unnecessary braking.
  - Safely monitoring traffic to anticipate changes in speed permits reduced braking and smooth acceleration changes.
  - Select a gear range suitable to road conditions.
4. Use cruise control (if equipped).
  - Using cruise control during highway driving helps maintain a steady speed.

- Cruise control is particularly effective in providing fuel savings when driving on flat terrains.
5. Plan for the shortest route.
  - Utilize a map or navigation system (if equipped) to determine the best route to save time.
6. Avoid idling.
  - Shutting off your engine when safe for stops exceeding 30-60 seconds saves fuel and reduces emissions.
7. Buy an automated pass for toll roads.
  - Automated passes permit drivers to use special lanes to maintain cruising speed through the toll and avoid stopping and starting.
8. Winter warm up.
  - Limit idling time to minimize impact to fuel economy.
  - Vehicles typically need no more than 30 seconds of idling at start-up to effectively circulate the engine oil before driving.
  - Your vehicle will reach its ideal operating temperature more quickly while driving versus idling.
9. Keeping your vehicle cool.
  - Park your vehicle in a covered parking area or in the shade whenever possible.
  - When entering a hot vehicle, opening the windows will help to reduce the inside temperature faster, resulting in reduced demand on your A/C system.
10. Do not carry excessive weight.
  - Remove unnecessary objects from the vehicle to reduce vehicle weight.

## INCREASING FUEL ECONOMY AND REDUCING CARBON DIOXIDE EMISSIONS

- Keep your engine tuned up.
- Follow the recommended scheduled maintenance.
- Keep the tires inflated to the correct pressure. Low tire pressure increases tire wear and lowers fuel economy.
- Keep the wheels in correct alignment. Improper alignment increases tire wear and lowers fuel economy.
- Use the recommended viscosity engine oil. (See "Recommended fluids/lubricants and capacities" (P.9-2).)

## PARKING



### WARNING:

- **Do not stop or park the vehicle over flammable materials such as dry grass, waste paper or rags. They may ignite and cause a fire.**
- **Safe parking procedures require that both the parking brake be applied and the shift lever placed into the "P" (Park) position for Automatic Transmission (AT) model or in an appropriate gear for Manual Transmission (MT) model. Failure to do so could cause the vehicle to move unexpectedly or roll away and result in an accident.**
- **When parking the vehicle, make sure the shift lever is moved to the "P" (Park) position. The shift lever cannot be moved out of the "P" (Park) position without depressing the foot brake pedal (AT model).**
- **Never leave the engine running while the vehicle is unattended.**
- **Do not leave children unattended inside the vehicle. They could unknowingly activate switches or controls. Unattended children could become involved in serious accidents.**
- **To help avoid risk of injury or death through unintended operation of the vehicle and/or its systems, do not leave children, people who require the assistance of others or pets unattended in your vehicle. Additionally, the temperature inside a closed vehicle on a warm day can quickly become high enough to cause a significant risk of injury or death to people and pets.**

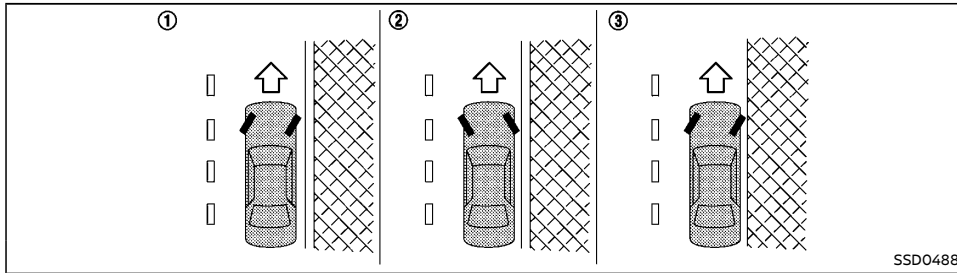

Left-Hand Drive (LHD) model

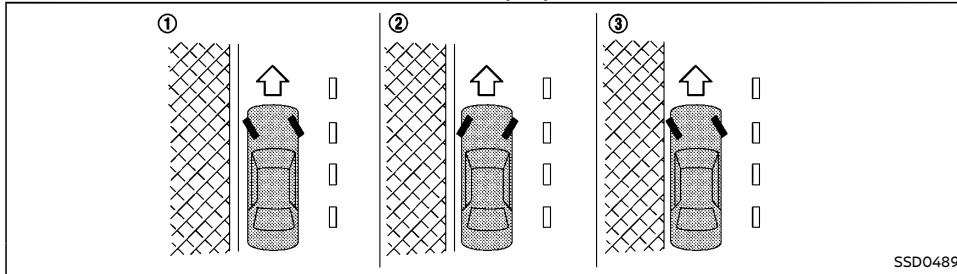

Right-Hand Drive (RHD) model

1. Firmly apply the parking brake.
2. Automatic Transmission (AT) model: Move the shift lever to the "P" (Park) position.  
Manual Transmission (MT) model: Move the shift lever to the "R" (Reverse) position. When parking on an uphill grade, move the shift lever to the "1" (1st) position.
3. To help prevent the vehicle from moving into traffic when parked on an incline, it is a good practice to turn the wheels as illustrated.  
HEADED DOWNHILL WITH CURB ①  
Turn the wheels into the curb and move

the vehicle forward until the curb side wheel gently touches the curb. Then apply the parking brake.

HEADED UPHILL WITH CURB ②

Turn the wheels away from the curb and allow the vehicle to move back until the curb side wheel gently touches the curb. Then apply the parking brake.

HEADED UPHILL OR DOWNHILL, WITHOUT CURB ③

Turn the wheels toward the side of the road so the vehicle will move away from the center of the road if the vehicle moves.

Then apply the parking brake.

4. **Model with Intelligent Key:**

Place the ignition switch in the "OFF" position.

**Model without Intelligent Key:**

Place the ignition switch in the "LOCK" position and remove the key.



## PARKING SENSOR (sonar) SYSTEM (if equipped)

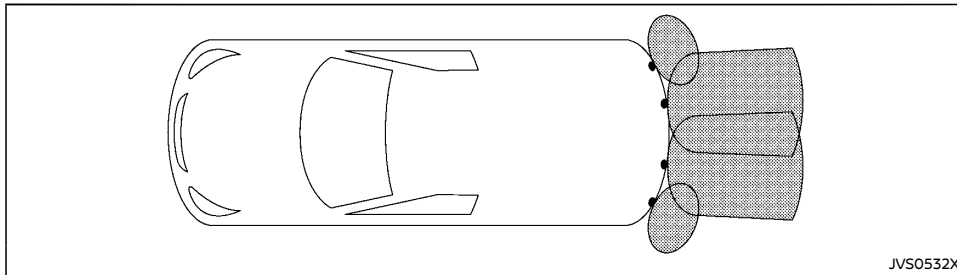

JVS0532X

The parking sensor (sonar) system sounds a tone to inform the driver of obstacles near the bumper.

When the "Display" key is ON, the sensor view will automatically appear in the vehicle information display.



### WARNING:

- The parking sensor (sonar) system is a convenience but it is not a substitute for proper parking. The driver is always responsible for safety during parking and other manoeuvres. Always look around and check that it is safe to do so before parking.
- Read and understand the limitations of the parking sensor (sonar) system as contained in this section. The colors of the corner sensor indicator and the distance guide lines in the rear view indicate different distances to the object. Inlement weather or ultrasonic sources such as an automatic car wash, a truck's compressed-air brakes or a pneumatic drill may affect the function of the system; this may include reduced perfor-

mance or a false activation.

- **This function is designed as an aid to the driver in detecting large stationary objects to help avoid damaging the vehicle. The system is not designed to prevent contact with small or moving objects. Always move slowly.**
- The system will not detect small objects below the bumper, and may not detect objects close to the bumper or on the ground.
- The system may not detect the following objects.
  - Fluffy objects such as snow, cloth, cotton, glass-wool, etc.
  - Thin objects such as rope, wire and chain, etc.
  - Wedge-shaped objects
- If your vehicle sustains damage to the bumper fascia, leaving it misaligned or bent, the sensing zone may be altered causing inaccurate measurement of obstacles or false alarms.



### CAUTION:

- Keep the interior of the vehicle as quiet as possible to hear the tone clearly.
- Keep the sensors (located on the bumper fascia) free from snow, ice and large accumulations of dirt. Do not clean the sensors with sharp objects. If the sensors are covered, the accuracy of the sensor function will be diminished.

The system inform with visual and audible signal of rear obstacles when the shift lever is in the "R" (Reverse) position.

The system is deactivated at speeds above 10 km/h (6 MPH). It is reactivated at lower speeds.

The intermittent tone will stop after 3 seconds when an obstacle is detected by only the corner sensor and the distance does not change. The tone will stop when the obstacle get away from the vehicle.

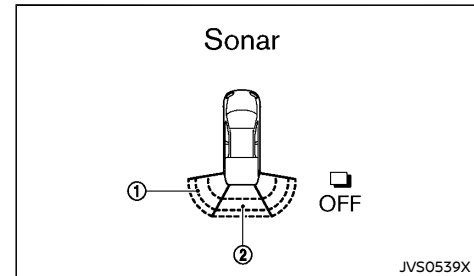

JVS0539X

When the corner of the vehicle moves closer to an object, the corner sensor indicators ① appears.

When the center of the vehicle moves close to an object, the center sensor indicator ② appears.

When the object is detected, the indicator (green) appears and the tone sounds intermittently. When the vehicle moves closer to the object, the color of the indicator turns yellow. When the vehicle is very close to the object, the indicator turns red, and the tone sounds continuously.

## PARKING SENSOR (sonar) SYSTEM OFF SWITCH

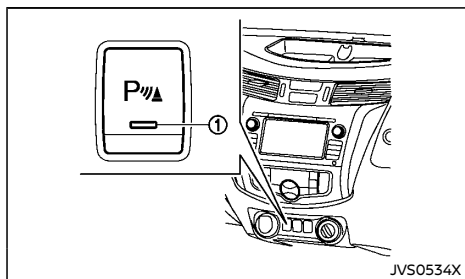

The parking sensor (sonar) system OFF switch on the instrument panel allows the driver to turn the parking sensor (sonar) system on and off. To turn the parking sensor (sonar) system on and off, the ignition switch must be in the "ON" position.

The indicator light ① on the switch will illuminate when the system is turned on.

If the indicator light flashes when the parking sensor (sonar) system is not turned off, it may indicate a malfunction in the parking sensor (sonar) system.

The parking sensor (sonar) system will be turned on automatically under the following conditions:

- When the ignition switch is switched from the "OFF" position to the "ON" position.
- When the shift lever is shifted into the "R" (Reverse) position.
- When the vehicle speed increases to 10 km/h (6 MPH) and decreases.

The automatic turning on function can be turned on and off by "Sensor" key in the setting menu. See "Settings" (P.2-27).

## PARKING SENSOR (sonar) SYSTEM SETTING

The following status of the parking sensor (sonar) system can be changed by switches on the steering-wheel-mounted controls. For details, see "Trip computer" (P.2-25).

### Sensor

Activate or deactivate the use of sensor.

ON (default) - OFF

### Volume

Adjust the volume of the tone.

High - Med. (default) - Low

### Range

Adjust the detection range of the sensor.

Far - Mid. (default) - Near

## TRAILER TOWING (except for Australia, New Zealand, South Africa and Latin America)

Your vehicle was designed to be used to carry passengers and luggage. NISSAN does not recommend trailer towing, because it places additional loads on your vehicle's engine, drive-train, steering, braking, and other systems.



### CAUTION:

**Vehicle damage resulting from towing a trailer is not covered by the warranties.**

## TRAILER TOWING (for Australia, New Zealand, South Africa and Latin America)

Your new vehicle was designed to be used primarily to carry passengers and luggage.

Towing a trailer will place additional loads on your vehicle's engine, drive train, steering, braking and other systems. The towing of a trailer will exaggerate other conditions such as sway caused by crosswinds, rough road surfaces or passing trucks.

Your driving style and speed must be adjusted according to the circumstances. Before towing a trailer, see a NISSAN dealer for an explanation about the proper use of towing equipment.

### OPERATING PRECAUTIONS

- Avoid towing a trailer during the break-in period.
- Before driving, make sure that the lighting system of the trailer works properly.
- Observe the legal maximum speeds for trailer operation.
- Avoid abrupt starts, accelerations and stops.
- Avoid sharp turns and lane changes.
- Always drive your vehicle at a moderate speed.
- Follow the trailer manufacturer's instructions.
- Choose proper coupling devices (trailer hitch, safety chain, roof carrier, etc.) for your vehicle and trailer. These devices are available from a NISSAN dealer where you can also obtain more detailed information about trailer towing.
- Never allow the total trailer load (trailer weight plus its cargo weight) to exceed the maximum set for the vehicle and the coupling device. See a NISSAN dealer for more information.

- The trailer must be loaded so that heavy goods are placed over the axle. The maximum allowable vertical load on the trailer hitch must not be exceeded.
- Have your vehicle serviced more often than at the intervals specified in a separate maintenance booklet.
- Trailer towing requires more fuel than under normal circumstances because of a considerable increase in traction power and resistance.

**While towing a trailer, check the engine coolant temperature indicator to prevent the vehicle from overheating.**

### MAXIMUM LOAD LIMITS (for Australia and New Zealand)

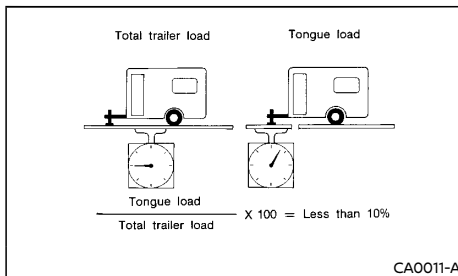

Maximum trailer loads (including tires and other loaded equipment):

1. Never allow the total trailer load to exceed:
  - The maximum 750 kg (1,654 lb) for a trailer without brakes.
  - The maximum 3,500 kg (7,718 lb) for a trailer with brakes.

2. The total trailer load must be lower than the following three values even if it does not exceed the maximum permissible trailer loads.
  - Towing capacity displayed on a tow-bar.
  - Trailer's gross vehicle mass marked on a coupling body.
  - Gross vehicle mass marked on a trailer data plate.

The maximum trailer load which can be towed by your vehicle depends on the towing equipment fitted to the vehicle. Therefore, it is important to not only have the correct equipment fitted but also to use it correctly. Towing loads greater than the value specified for your vehicle or using towing equipment which is not provided by NISSAN could seriously affect the handling and/or performance of your vehicle.

Vehicle damage resulting from improper towing procedures is not covered by NISSAN warranties. Information on trailer towing and the required equipment should be obtained from a NISSAN dealer.

**"Never exceed the Gross Vehicle Mass (GVM), Gross Combination Mass (GCM) or Front/Rear Gross Axle Weight Rating (GAWR)"**

### Maximum tongue load

Never allow the tongue load to exceed 10% of the total trailer load. If the tongue load exceeds 10%, rearrange the cargo in the trailer.

## Maximum rear gross axle weight

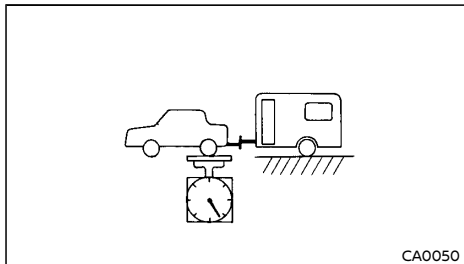

The rear gross axle weight must not exceed the Gross Axle Weight Rating (GAWR).

### **GAWR:**

#### **Rear**

**YS23DDT/DDTT engine with 195R15C and 255/60R18 tire equipped models  
1,700 kg (3,749 lb)**

**Except for YS23DDT/DDTT engine with 195R15C and 255/60R18 tire equipped models**

**1,750 kg (3,859 lb)**

The trailer must be loaded so that heavy goods are placed over the axle.

## TIRE PRESSURE

When towing a trailer, inflate the vehicle tires to the maximum recommended COLD tire pressure (for full loading) indicated on the tire placard.

Do not tow a trailer when the vehicle is installed with a temporary spare tire or a compact spare tire.

## SAFETY CHAINS

Always use a suitable chain between the vehicle and trailer. The chain should be crossed and should be attached to the hitch, not to the vehicle bumper or axle. Be sure to leave enough slack in the chain to permit turning corners.

## TRAILER BRAKES

Ensure that trailer brakes are installed as required by local regulations. Also check that all other trailer equipment conforms to local regulations.

Always block the wheels on both the vehicle and trailer when parking. Apply the hand brake on the trailer if equipped. Parking on a steep slope is not recommended.

If parking on a steep slope is unavoidable, place the shift lever in the "P" (Park) position (Automatic transmission model), or in an appropriate position (Manual transmission model), and turn the front wheels towards the curb.

## TRAILER DETECTION (if equipped)

When towing a trailer with a genuine NISSAN tow bar electrical kit and the turn signal switch is used, the electrical system of the vehicle will detect the additional electrical load of the trailer lighting. As a result, the direction indicator tone will be different.

## POWER STEERING



### **WARNING:**

**If the engine is not running or is turned off while driving, the power assist for the steering will not work. The steering will be much harder to operate.**

The power assisted steering is designed to use a hydraulic pump driven by the engine, to assist steering.

If the engine stops or the drive belt breaks, you will still have control of the vehicle. However, greater steering effort is needed, especially in sharp turns and at low speeds.

## BRAKE SYSTEM

The brake system has two separate hydraulic circuits. If one circuit malfunctions, you will still have braking ability at two wheels.

### BRAKE PRECAUTIONS

#### Vacuum assisted brakes

The brake booster aids braking by using engine vacuum. If the engine stops, you can stop the vehicle by depressing the foot brake pedal. However, greater foot pressure on the foot brake pedal will be required to stop the vehicle. The stopping distance will be longer.

If the engine is not running or is turned off while driving, the power assisted brakes will not function. Braking will be harder.



#### **WARNING:**

**Do not coast with the engine stopped.**

#### Using brakes

Avoid resting your foot on the foot brake pedal while driving. This will overheat the brakes, wear out the brake linings/pads faster, and increase fuel consumption.

To help reduce brake wear and to prevent the brakes from overheating, reduce speed and downshift to a lower gear before going down a slope or long grade. Overheated brakes may reduce braking performance and could result in loss of vehicle control.

While driving on a slippery surface, be careful when braking, accelerating or downshifting. Abrupt braking or acceleration could cause the wheels to skid and result in an accident.

#### Wet brakes

When the vehicle is washed or driven through water, the brakes may get wet. As a result, your braking distance will be longer and the vehicle may pull to one side during braking.

To dry the brakes, drive the vehicle at a safe speed while lightly depressing the foot brake pedal to heat up the brakes. Do this until the brakes return to normal. Avoid driving the vehicle at high speeds until the brakes function correctly.

#### Parking brake break-in

Break in the parking brake shoes whenever the stopping effect of the parking brake is weakened or whenever the parking brake shoes and/or drums/rotors are replaced, in order to assure the best braking performance.

This procedure is described in the vehicle service manual and can be performed by a NISSAN dealer.

#### BRAKE ASSIST (if equipped)

When the force applied to the brake pedal exceeds a certain level, the Brake Assist is activated generating greater braking force than a conventional brake booster even with light pedal force.



#### **WARNING:**

**The Brake Assist is only an aid to assist braking operation and is not a collision warning or avoidance device. It is the driver's responsibility to stay alert, drive safely and be in control of the vehicle at all times.**

#### ANTI-LOCK BRAKING SYSTEM (ABS) (if equipped)



#### **WARNING:**

**The Anti-lock Braking System (ABS) is a sophisticated device, but it cannot prevent accidents resulting from careless or dangerous driving techniques. It can help maintain vehicle control during braking on slippery surfaces. Remember that stopping distances on slippery surfaces will be longer than on normal surfaces even with ABS. Stopping distances may also be longer on rough, gravel or snow covered roads, or if you are using tire chains. Always maintain a safe distance from the vehicle in front of you. Ultimately, the driver is responsible for safety.**

**Tire type and condition may also affect braking effectiveness.**

- **When replacing tires, install the specified size of tires on all four wheels.**
- **When installing a spare tire, make sure that it is the proper size and type as specified on the tire placard. (See "Tire placard" (P.9-15).)**
- **For detailed information, see "Tires and wheels" (P.8-32).**

The Anti-lock Braking System (ABS) controls the brakes so the wheels do not lock during hard braking or when braking on slippery surfaces. The system detects the rotation speed at each wheel and varies the brake fluid pressure to prevent each wheel from locking and sliding. By preventing each wheel from locking, the system helps the driver maintain steering control and helps to minimize swerving and spinning on slippery surfaces.

## Using system

Depress the brake pedal and hold it down. Depress the brake pedal with firm steady pressure, but do not pump the brakes. The ABS will operate to prevent the wheels from locking up. Steer the vehicle to avoid obstacles.



### **WARNING:**

**Do not pump the brake pedal. Doing so may result in increased stopping distances.**

## Self-test feature

The ABS includes electronic sensors, electric pumps, hydraulic solenoids and a computer. The computer has a built-in diagnostic feature that tests the system each time you start the engine and move the vehicle at a low speed in forward or reverse. When the self-test occurs, you may hear a “clunk” noise and/or feel a pulsation in the brake pedal. This is normal and does not indicate a malfunction. If the computer senses a malfunction, it switches the ABS off and illuminates the ABS warning light on the instrument panel. The brake system then operates normally, but without anti-lock assistance. If the ABS warning light illuminates during the self-test or while driving, have the vehicle checked by a NISSAN dealer.

## Normal operation

The ABS operates at speeds above 5 to 10 km/h (3 to 6 MPH). The speed varies according to road conditions.

When the ABS senses that one or more wheels are close to locking up, the actuator rapidly applies and releases hydraulic pressure. This action is similar to pumping the brakes very quickly. You may feel a pulsation in the brake pedal and hear a noise from under the hood or

feel a vibration from the actuator when it is operating. This is normal and indicates that the ABS is operating properly. However, the pulsation may indicate that road conditions are hazardous and extra care is required while driving.

When the differential lock (if equipped) is engaged, the ABS warning light illuminates. This indicates that the anti-lock function is not fully operating. (See “Rear differential locking system” (P.5-23) for the rear differential lock function.)

## VEHICLE SECURITY

When leaving your vehicle unoccupied:

- Always take the key with you - even when leaving the vehicle in your own garage.
- Close all windows completely and lock all doors.
- Always park your vehicle where it can be seen. Park in a well lit area during the night.
- If the security system is equipped, use it - even for a short period.
- Never leave children or pets in the vehicle unattended.
- Never leave valuables inside the vehicle. Always take valuables with you.
- Never leave the vehicle documents in the vehicle.
- Never leave articles on a roof rack. Remove them from the rack and keep and lock them inside the vehicle.
- Never leave the spare key in the vehicle.

## COLD WEATHER DRIVING



### WARNING:

- **Whatever the condition, drive with caution. Accelerate and decelerate with great care. If accelerating or decelerating too fast, the drive wheels will lose even more traction.**
- **Allow more stopping distance in cold weather driving. Braking should be started sooner than on dry pavement.**
- **Keep at a greater distance from the vehicle in front of you on slippery roads.**
- **Wet ice (0°C, 32°F and freezing rain), very cold snow and ice can be slick and very difficult to drive on. The vehicle will have a lot less traction or grip under these conditions. Try to avoid driving on wet ice until the road is salted or sanded.**
- **Watch for slippery spots (glaring ice). These may appear on an otherwise clear road in shaded areas. If a patch of ice is seen ahead, brake before reaching it. Try not to brake while actually on the ice, and avoid any sudden steering maneuvers.**
- **Do not use cruise control on slippery roads.**
- **Snow can trap dangerous exhaust gas under your vehicle. Keep snow clear of the exhaust pipe and from around your vehicle.**

## BATTERY

If the battery is not fully charged during extremely cold weather conditions, the battery fluid may freeze and damage the battery. To maintain maximum efficiency, the battery should be checked regularly. For details, see "Battery" (P.8-21) of this manual.

## ENGINE COOLANT

If the vehicle is to be left outside without anti-freeze, drain the cooling system, including the engine block. Refill before operating the vehicle. For details, see "Changing engine coolant" (P.8-8) of this manual.

## TIRE EQUIPMENT

1. If you have snow tires installed on the front/rear wheels of your vehicle, they should be of the same size, loading range, construction and type (bias, bias-belted or radial) as the rear/front tires.
2. If the vehicle is to be operated in severe winter conditions, snow tires should be installed on all four wheels.
3. For additional traction on icy roads, studded tires may be used. However, some countries, provinces and states prohibit their use. Check local, state and provincial laws before installing studded tires.  
**Skid and traction capabilities of studded snow tires, on wet or dry surfaces, may be poorer than that of non-studded snow tires.**
4. Snow chains may be used if desired. Make sure they are the proper size for the tires on your vehicle and are installed according to the chain manufacturer's instructions. Use chain tensioners when recommended by the tire chain manufacturer to ensure a

tight fit. Loose end links of the tire chains must be secured or removed to prevent the possibility of whipping action damage to the fenders or underbody. In addition, drive at a reduced speed, otherwise, your vehicle may be damaged and/or vehicle handling and performance may be adversely affected.

## SPECIAL WINTER EQUIPMENT

It is recommended that the following items be carried in the vehicle during the winter:

- A scraper and stiff-bristled brush to remove ice and snow from the windows.
- A sturdy, flat board to be placed under the jack to give it firm support.
- A shovel to dig the vehicle out of snow-drifts.

## PARKING BRAKE

When parking in the area where the outside temperature is below 0°C (32°F), do not apply the parking brake to prevent it from freezing. For safe parking:

- Place the shift lever in the "P" (Park) position (Automatic transmission model).
- Place the shift lever in the "1" (1st) or "R" (Reverse) gear (Manual transmission model).
- Securely block the wheels.

## CORROSION PROTECTION

Chemicals used for road surface deicing are extremely corrosive and will accelerate corrosion and the deterioration of underbody components such as the exhaust system, fuel and brake lines, brake cables, floor pan and fenders.

**In the winter, the underbody must be cleaned periodically. For additional information, see "Corrosion protection" (P.7-5) of this manual.**

For additional protection against rust and corrosion, which may be required in some areas, consult a NISSAN dealer.



# 6 In case of emergency

Hazard indicator flasher switch .....	6-2	Jump starting .....	6-7
Flat tire .....	6-2	Push starting .....	6-11
Stopping vehicle .....	6-2	If your vehicle overheats .....	6-11
Preparing tools .....	6-2	Towing your vehicle .....	6-12
Removing the spare tire .....	6-3	Towing precautions .....	6-12
Blocking wheels .....	6-4	Towing recommended by NISSAN .....	6-13
Removing tire .....	6-4		
Installing spare tire .....	6-6		
Stowing damaged tire and tools .....	6-7		



## HAZARD INDICATOR FLASHER SWITCH

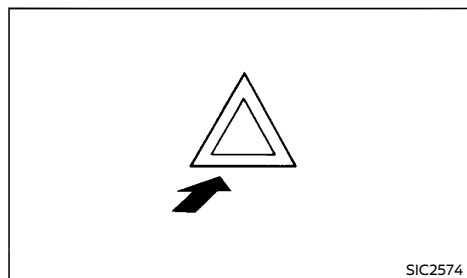

The hazard indicator flasher switch operates regardless of the ignition switch position except when the battery is discharged.

The hazard indicator flasher is used to warn other drivers when you have to stop or park under emergency conditions.

When the hazard indicator flasher switch is pushed, all turn signal lights will flash. To turn off the hazard indicator flasher, push the hazard indicator flasher switch again.

## FLAT TIRE

If you have a flat tire, follow the instructions in this section.

### STOPPING VEHICLE

#### **WARNING:**

- **Be sure to apply the parking brake firmly.**
- **Be sure to move the shift lever to the "P" (Park) position (automatic transmission model).**
- **Be sure to move the shift lever to the "R" (Reverse) position (manual transmission model).**
- **Never change tires when the vehicle is on a slope, ice or slippery area. This is hazardous.**
- **Never change tires when the oncoming traffic is close to your vehicle. Call for professional road assistance.**

1. Safely move the vehicle off the road away from traffic.
2. Turn on the hazard indicator flasher lights.
3. Park on a level surface.
4. Apply the parking brake.
5. **Automatic transmission model:**  
Move the shift lever to the "P" (Park) position.  
**Manual transmission model:**  
Move the shift lever to the "R" (Reverse) position.
6. Turn off the engine.
7. Open the hood:
  - To warn other traffic.
  - To signal professional road assistance personnel that you need assistance.

8. Have all passengers get out from the vehicle and stand in a safe place, away from other traffic and clear of the vehicle.

### PREPARING TOOLS

For King Cab model

**Models not equipped with jump seat:**

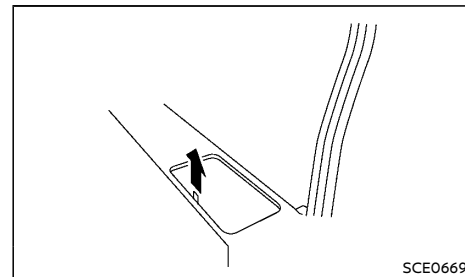

The tool storage compartment is located in the tier behind the front seat.

Open the lid of the tool storage compartment and remove the jack and necessary tools.

**Models equipped with jump seat:**

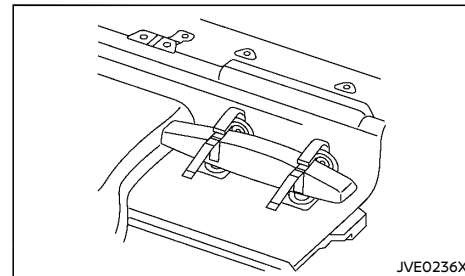

The jack and tools are stored under the jump seat.

### For Double Cab model

The tool storage compartment is located under the rear seats.

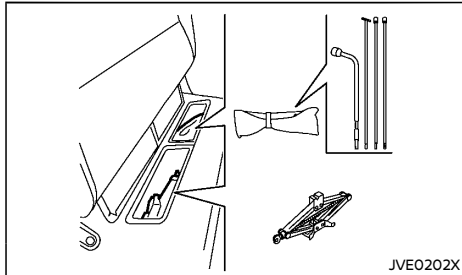
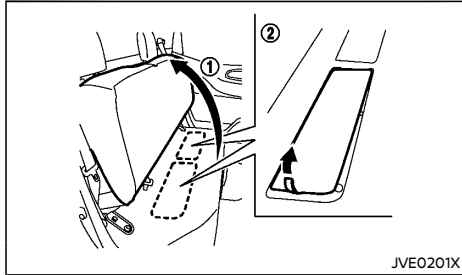

1. Fold the rear seat up ① and remove tool storage compartment lids ②.
2. Remove the jack and necessary tools.

### For Single Cab model

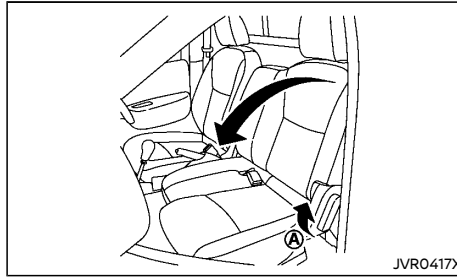

The tool storage compartment is located behind the front seat.

1. Pull the lever up ① and recline the front passenger's seat.
2. Remove the jack and necessary tools.

### REMOVING THE SPARE TIRE

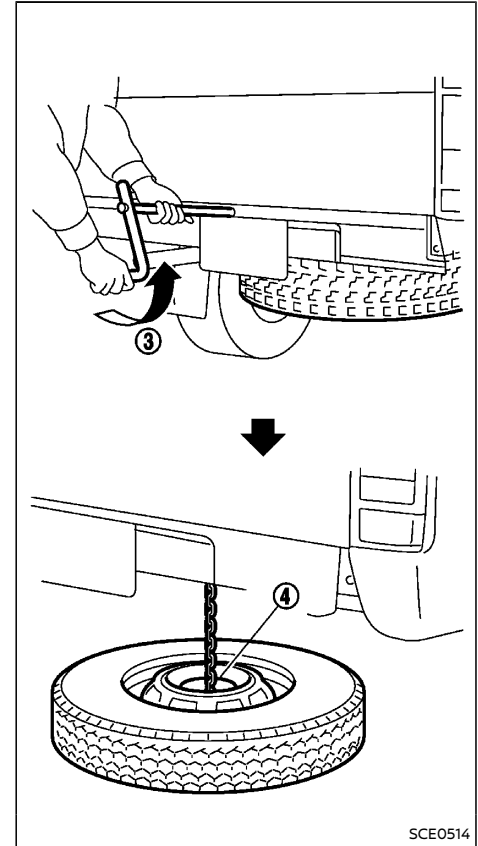

Find the oval shaped opening under the middle

**In case of emergency 6-3**

of the tailgate (if equipped) or under the license plate. Pass the T-shaped end of the jack rod through the opening and direct it towards the spare tire winch, located directly above the spare tire.

Seat the T-shaped end of the jack rod into the T-shaped opening of the spare tire winch, and turn the jack rod counterclockwise ③ to lower the spare tire.

Once the spare tire is completely lowered ④, reach under the vehicle, remove the retainer chain, and carefully slide the tire from under the rear of the vehicle.

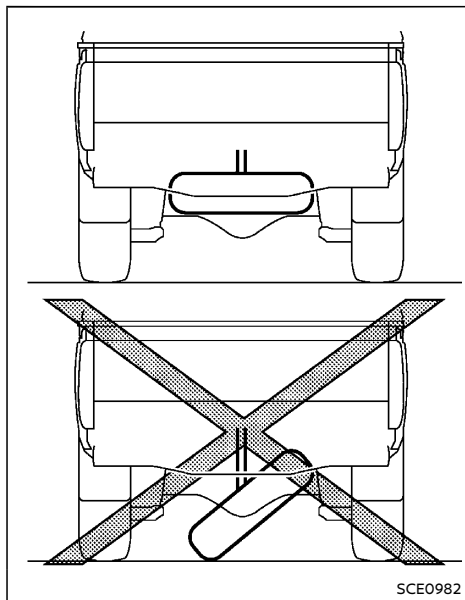

**⚠ CAUTION:**

When storing the wheel, be sure to mount the wheel horizontally. Securing a wheel that is in a tilted position as illustrated may cause looseness and dropping of the wheel while driving. Lower the wheel on the ground again, and make sure that the hanging plate is properly set. Hang the wheel again and make sure that the wheel is held horizontally, then store the wheel.

**BLOCKING WHEELS**

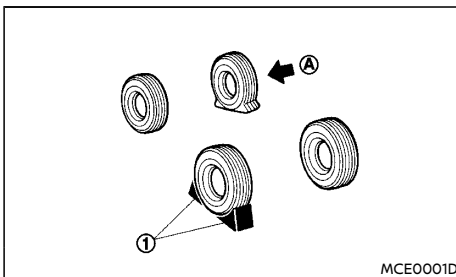

**⚠ WARNING:**

Be sure to block the appropriate wheel to prevent the vehicle from moving, which may cause personal injury.

Place suitable blocks ① at both the front and back of the wheel diagonally opposite the flat tire ④ to prevent the vehicle from moving when it is jacked up.

**REMOVING TIRE**

**⚠ WARNING:**

- Be sure to read and follow the instructions in this section.
- **DO NOT GET UNDER A VEHICLE THAT IS SUPPORTED BY A JACK.**
- Never use a jack which was not provided with your vehicle.
- The jack, which is provided with your vehicle, is designed only to lift your vehicle during a tire change.
- Never jack up the vehicle at a location other than the jack-up point that is specified.
- Never lift the vehicle more than necessary.
- Never use blocks on or under the jack.
- Never start or run the engine while the vehicle is on the jack. The vehicle may move suddenly, and this may cause an accident.
- Never allow passengers to remain in the vehicle while the tire is off the ground.
- Be sure to read the caution label attached to the jack body before using.

### Removing the wheel cap (if equipped)

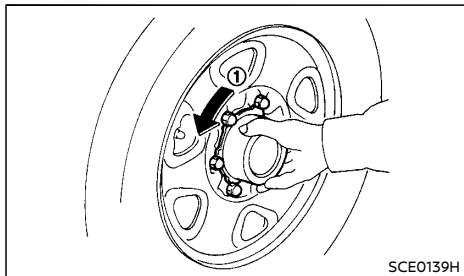

Remove the center wheel cap ① as illustrated.

### Jacking up vehicle

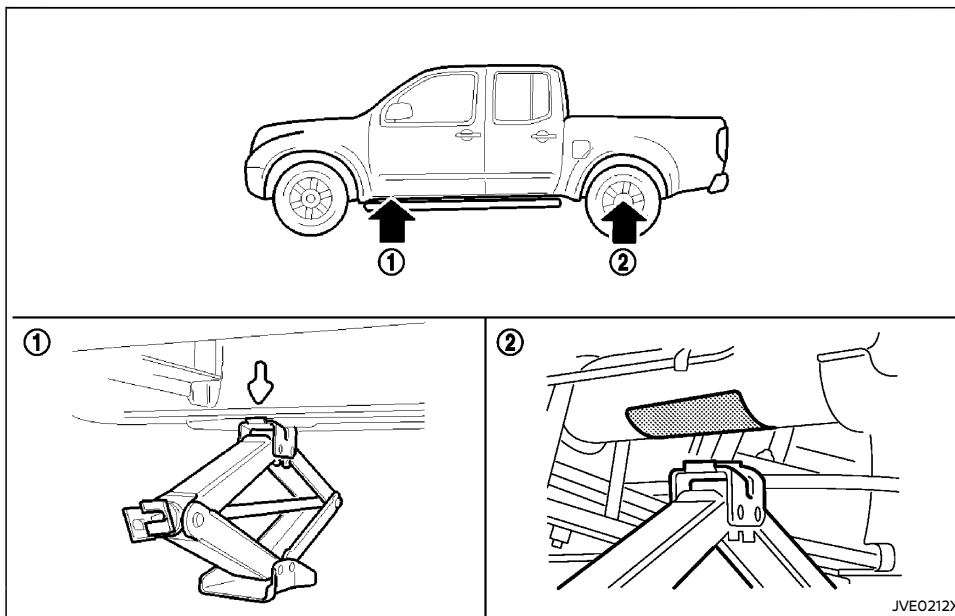

For leaf suspension models

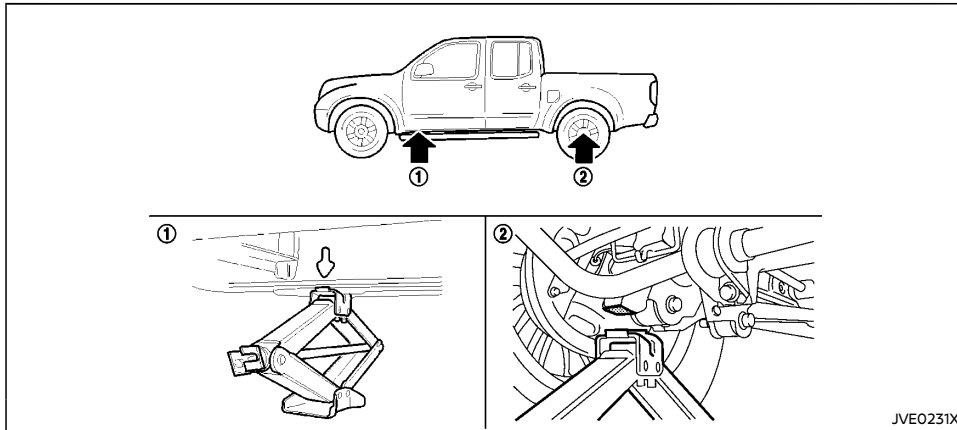

For coil suspension models

- ① For front wheel
- ② For rear wheel

1. Place the jack directly under the jack-up points ① or ② as illustrated.

**The jack should be placed on firm level ground.**

2. Loosen each wheel nut, counterclockwise, one or two turns with the wheel nut wrench.

**Do not remove the wheel nuts until the tire is off the ground.**

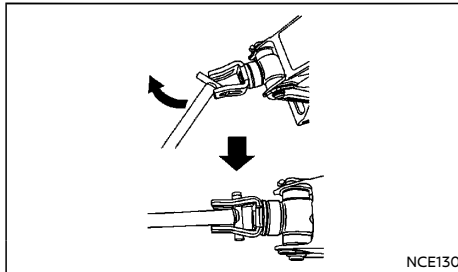

3. Install the assembled jack rod into the jack as shown.
4. Carefully raise the vehicle until the clearance between the tire and ground is achieved.

5. To lift the vehicle, securely hold the jack lever and rod with both hands and turn the jack lever.

### Removing tire

1. Remove the wheel nuts.
2. Remove the damaged tire.



### CAUTION:

**The tire is heavy. Be sure that your feet are clear from the tire and use gloves as necessary to avoid injury.**

### INSTALLING SPARE TIRE

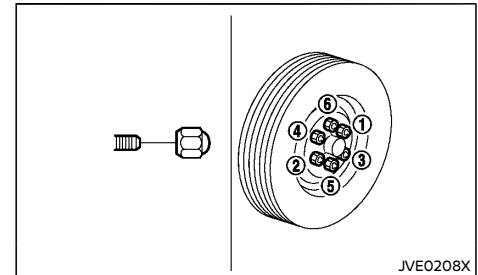

### WARNING:

- **Never use wheel nuts which are not provided with your vehicle. Incorrect wheel nuts or improperly tightened wheel nuts may cause the wheel to become loose or come off. This could cause an accident.**
- **Never use oil or grease on the wheel studs or nuts. This may cause the wheel nuts to become loose.**

- **The temporary-use spare tire (if equipped) is designed for emergency use only.**

1. Clean any mud or dirt from the surface between the wheel and hub.
2. Carefully put the spare tire on and tighten the wheel nuts with your fingers. Check that all the wheel nuts contact the wheel surface horizontally.
3. Tighten the wheel nuts alternately and evenly in the sequence illustrated (① - ⑥), more than 2 times with the wheel nut wrench, until they are tight.
4. Lower the vehicle slowly until the tire touches the ground.
5. Tighten the wheel nuts securely, with the wheel nut wrench, in the sequence illustrated.
6. Lower the vehicle completely.

**Tighten the wheel nuts to the specified torque with a torque wrench as soon as possible.**

**Wheel nut tightening torque:  
133 N·m (13.6 kg·m, 98 ft·lb)**

**The wheel nuts must be kept tightened to specification at all times. It is recommended that the wheel nuts be tightened to specification at each lubrication interval.**



**WARNING:**

**Retighten the wheel nuts when the vehicle has been driven for 1,000 km (600 miles) (also in case of a flat tire, etc.).**

## STOWING DAMAGED TIRE AND TOOLS



**WARNING:**

- **Be sure that the tire, jack and tools are properly stored after use. Such items can become dangerous projectiles in an accident or sudden stop.**
- **The temporary-use spare tire (if equipped) is designed for emergency use only.**

Securely store the damaged tire, jack and tools in the storage area in the reverse order of removal. (See "Preparing tools" (P.6-2) and "Removing the spare tire" (P.6-3).)

## JUMP STARTING



**WARNING:**

- **Incorrect jump starting can lead to a battery explosion. The battery explosion may result in severe injury or death. It may also result in damage to the vehicle. Be sure to follow the instructions in this section.**
- **Explosive hydrogen gas is always present in the vicinity of the battery. Keep all sparks and flames away from the battery.**
- **Always wear suitable eye protection and remove rings, bracelets, and any other jewelry whenever working on or near a battery.**
- **Never lean over the battery while jump starting.**
- **Never allow battery fluid to come into contact with eyes, skin, clothes or the vehicle's painted surfaces. Battery fluid is a corrosive sulfuric acid which can cause severe burns. If the fluid comes into contact with anything, immediately flush the contacted area with plenty of water.**
- **Keep the battery out of the reach of children.**
- **The booster battery must be rated at 12 volts. Use of an incorrectly rated battery will damage your vehicle.**
- **Never attempt to jump start a frozen battery. It could explode and cause serious injury.**

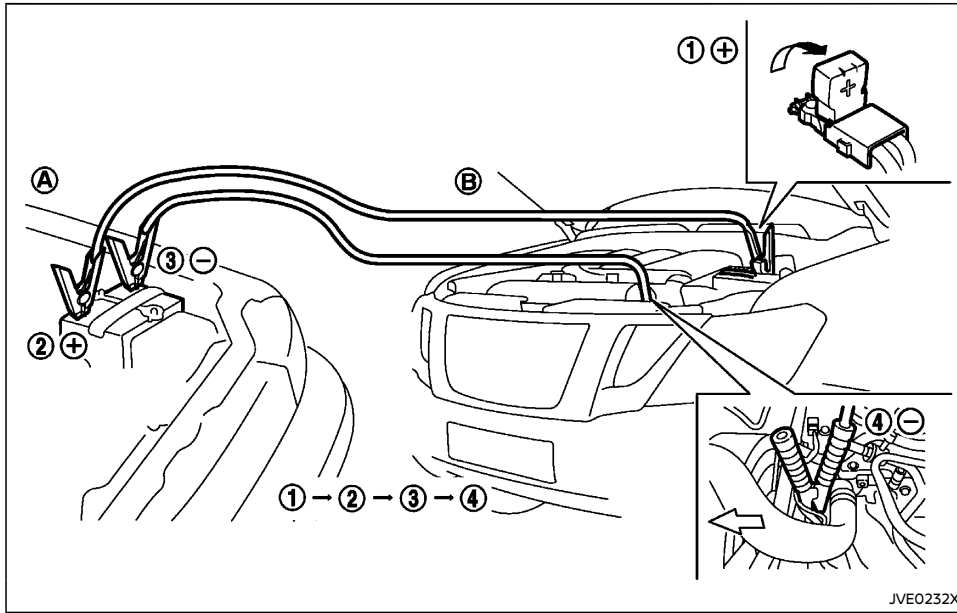

JVE0232X

QR25DE engine models



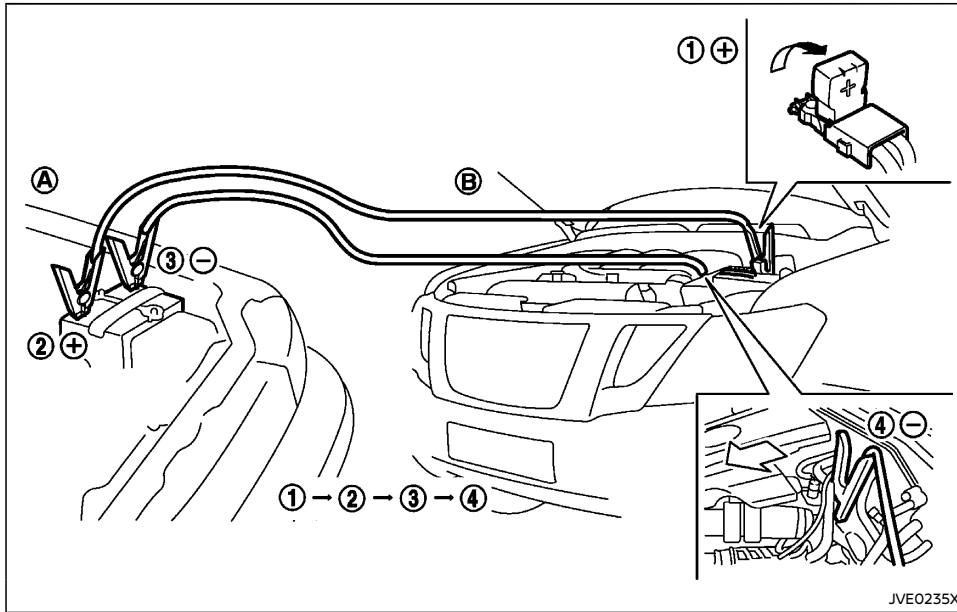

YD25DDTi engine models

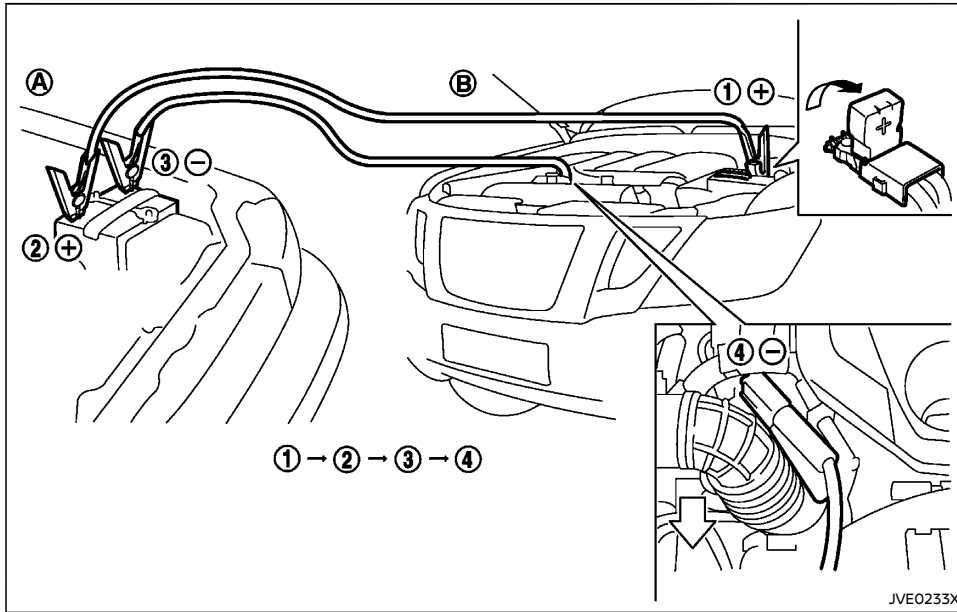

Y523DDT/DDTT engine models

1. If the booster battery is in another vehicle **A**, position the two vehicles **A** and **B** to bring the batteries into close proximity to each other.



**CAUTION:**

- Do not allow the two vehicles to touch.
- If the battery of vehicle **B** equipped with the Intelligent Key system is discharged, the steering wheel will lock and cannot be turned with the ignition switch in the

**"OFF" position. Supply power using jumper cables before pushing the ignition switch to any position other than the "OFF" position and disengaging the steering lock.**

2. Apply the parking brake.
3. **Automatic transmission (AT) model:**  
Move the shift lever to the "P" (Park) position.  
**Manual transmission (MT) model:**

Move the shift lever to the "N" (Neutral) position.

4. Switch off all unnecessary electrical systems (headlights, heater, air conditioner, etc.).
5. Place the ignition switch in the "OFF" position.
6. Remove the vent caps, if equipped, on the battery.
7. Cover the battery with a firmly wrung out moist cloth to reduce the hazard of an explosion.
8. Connect the jumper cables in the sequence as illustrated (①, ②, ③, ④).



**CAUTION:**

- Always connect positive  $\oplus$  to positive  $\oplus$  and negative  $\ominus$  to body ground, **NOT** to the battery's negative  $\ominus$ .
- Be sure that the jumper cables do not touch moving parts in the engine compartment.
- Be sure that the jumper cable's clamps do not contact any other metal.

9. Start the engine of the booster vehicle **A** and let it run for a few minutes.
10. Depress the accelerator pedal of the booster vehicle **A** at about 2,000 rpm.
11. Start the engine of the jumped vehicle **B** in the normal manner.



**CAUTION:**

**Never keep the starter motor engaged for more than 10 seconds. If the engine does not start right away, place the ignition switch in the "LOCK" position and wait at least 10**

## PUSH STARTING

Do not attempt to start the engine by pushing the vehicle.



### CAUTION:

- **Automatic Transmission (AT) model cannot be started by pushing. Attempting to do so may cause damage to the transmission.**
- **Three-way catalyst equipped model should not be started by pushing. Attempting to do so may cause damage to the three-way catalyst.**
- **Diesel Oxidation Catalyst equipped model should not be started by pushing. Attempting to do so may cause damage to the catalyst.**
- **Never try to start the engine by towing. When the engine starts, the forward surge could cause the vehicle to collide with the towing vehicle.**

### seconds before trying again.

12. After the engine is started, carefully disconnect the jumper cables in the opposite sequence from that illustrated (④, ③, ②, ①).
13. Remove and dispose of the cloth properly as it may be contaminated with corrosive acid.
14. Replace the vent caps, if removed.

## IF YOUR VEHICLE OVERHEATS



### WARNING:

- **Never continue driving if your vehicle overheats. Doing so could cause engine damage and/or a vehicle fire.**
- **Never open the hood if steam is coming out.**
- **Never remove the radiator or coolant reservoir cap while the engine is hot. If the radiator or coolant reservoir cap is removed when the engine is hot, pressurized hot water will spurt out and possibly cause burning, scalding or serious injury.**
- **If steam or coolant is coming from the engine, stand clear of the vehicle to prevent getting scalded.**
- **The engine cooling fan can start at any time when the coolant temperature exceeds preset degrees.**
- **Be careful not to allow your hands, hair, jewelry or clothing to come into contact with, or to get caught in the cooling fan or drive belts.**

If your vehicle is overheating, or if you feel a lack of engine power, detect unusual noise, etc., take the following steps:

1. Safely move the vehicle off the road away from traffic.
2. Turn on the hazard indicator flashers.
3. Apply the parking brake.
4. **Automatic transmission model:**

Move the shift lever to the "P" (Park) position.

### **Manual transmission model:**

Move the shift lever to the "N" (Neutral)

position.

**DO NOT STOP THE ENGINE.**

5. Open all the windows.
6. Turn off the air conditioner. Move the temperature control to maximum hot and the fan control to high speed.
7. Get out from the vehicle.
8. Visually inspect and listen for steam or coolant escaping from the radiator before opening the hood. Wait until no steam or coolant can be seen before proceeding.
9. Open the engine hood.
10. Visually inspect if the cooling fan is running.
11. Visually inspect the radiator and radiator hoses for leakage. If the cooling fan is not running or the coolant is leaking, stop the engine.
12. After the engine cools down, check the coolant level in the reservoir with the engine running. **Do not open the radiator or coolant reservoir cap.**
13. Add coolant to the reservoir if necessary.

Have your vehicle inspected/repared at a NISSAN dealer.

## TOWING YOUR VEHICLE

When towing your vehicle, local regulations for towing must be followed. Incorrect towing equipment could damage your vehicle. To assure proper towing and to prevent accidental damage to your vehicle, NISSAN recommends that you have professional road assistance personnel tow your vehicle. It is advisable to have the professional road assistant carefully read the following precautions.

### TOWING PRECAUTIONS

- Be sure that the transmission, steering system and powertrain are in working condition before towing. If any units are damaged, the vehicle must be towed using a dolly or flatbed tow truck. (Two- Wheel Drive (2WD) model)
- NISSAN recommends that your vehicle be towed with the driving wheels off the ground. (Two- Wheel Drive (2WD) model)
- Always attach safety chains before towing.
- Never tow Four-Wheel Drive (4WD) model with any of the wheels on the ground as this may cause serious and expensive damage to the drivetrain.

## TOWING RECOMMENDED BY NISSAN

### Towing Two-Wheel Drive (2WD) models

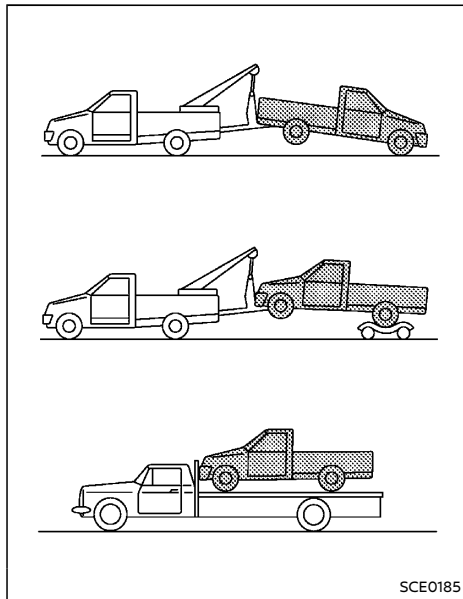

#### Front wheels on the ground:

1. Place the ignition switch in the "ON" position and turn all accessories off.
2. Secure the steering wheel in a straight ahead position with rope or similar device.
3. Move the shift lever to the "N" (Neutral) position.

4. Release the parking brake.
5. Attach safety chains before towing.

#### Rear wheels on the ground:

NISSAN recommends that towing dollies be used under the rear wheels when towing your vehicle or the vehicle be placed on a flatbed tow truck as illustrated.

#### CAUTION:

**Never tow Automatic Transmission (AT) model with the rear wheels on the ground. Doing so will cause serious and expensive damage to the transmission.**

Manual Transmission (MT) model:

If you have to tow a MT vehicle with rear wheel on the ground, perform the following procedures.

#### CAUTION:

**Observe the following restricted towing speeds and distances.**

- **Speed: Below 50 km/h (30 MPH)**
- **Distance: Less than 65 km (40 miles)**

1. Place the ignition switch in the "ON" position and turn all accessories off.
2. Move the shift lever to the "N" (Neutral) position.
3. Release the parking brake.
4. Attach safety chains whenever towing.

#### All four wheels on the ground:

NISSAN recommends that the vehicle be placed on a flatbed tow truck as illustrated.

#### CAUTION:

**Never tow Automatic Transmission (AT) model with all four wheels on the ground. Doing so will cause serious and expensive damage to the drivetrain.**

Manual Transmission (MT) model:

If you have to tow a MT vehicle with all four wheels on the ground, perform the following procedures.

#### CAUTION:

- **Never tow a Manual Transmission (MT) model backward with all four wheels on the ground.**
  - **Observe the following restricted towing speeds and distances.**
    - **Speed: Below 50 km/h (30 MPH)**
    - **Distance: Less than 65 km (40 miles)**
1. Place the ignition switch in the "ON" position and turn all accessories off.
  2. Move the shift lever to the "N" (Neutral) position.
  3. Release the parking brake.

## Towing Four-Wheel Drive (4WD) models

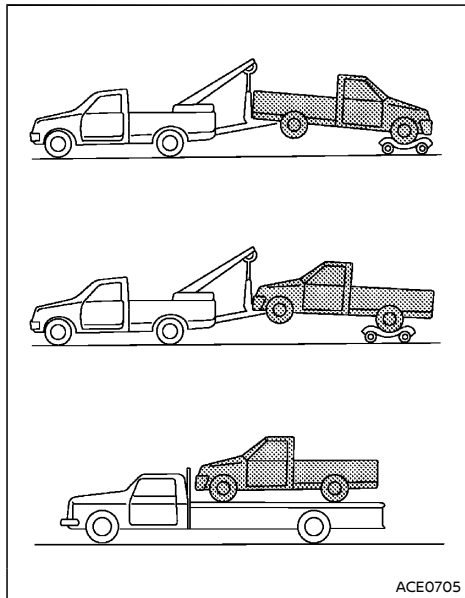

ACE0705

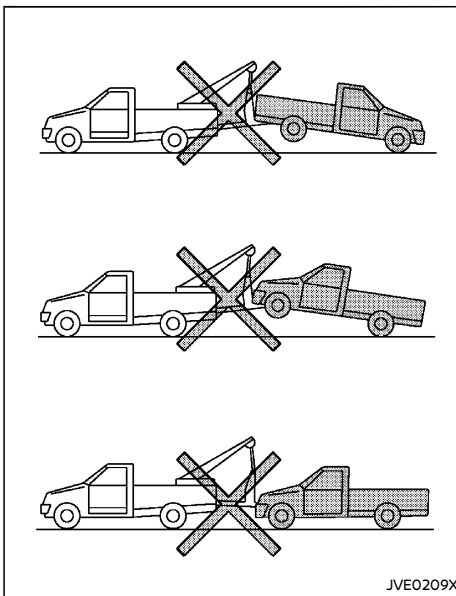

JVE0209X

NISSAN recommends that your vehicle be towed with all wheels off the ground as illustrated or place the vehicle on a flatbed truck.



### CAUTION:

**Never tow 4WD models with any of the wheels on the ground. Doing so will cause serious and expensive damage to the drivetrain.**

## Freeing trapped vehicle

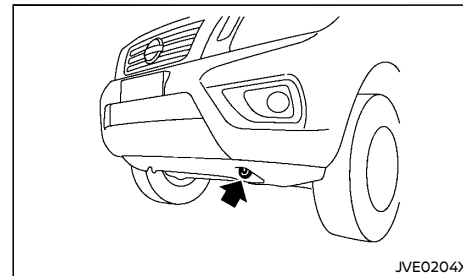

JVE0204X

### Right-Hand Drive model

The layout illustrated is for the Right-Hand Drive (RHD) model. On the Left-Hand Drive (LHD) model, the towing hook is located on the opposite side.



### WARNING:

- **Never allow anyone to stand near the towing line during the pulling operation.**
- **Never spin the tires at high speed. This could cause them to explode and result in serious injury. Parts of the vehicle could also overheat and be damaged.**

In the event that your vehicle's tires become trapped in sand, snow, or mud, and the vehicle is unable to free itself without being pulled, use the towing hook.

- Use the towing hook only. Do not attach the pulling device to any other part of the vehicle body. Otherwise, the vehicle body may be damaged.
- Use the towing hook to free a vehicle only. Never tow a vehicle using only the towing hook.

- The towing hook is under tremendous stress when used to free a trapped vehicle. Always pull the pulling device straight out from the vehicle. Never pull on the towing hook at an angle.



**CAUTION:**

**In order to not break the towing line, tension it slowly.**

**MEMO**



# 7 Appearance and care

Cleaning exterior .....	7-2	Cleaning interior .....	7-4
Washing .....	7-2	Air fresheners .....	7-4
Removing spots .....	7-2	Floor mats .....	7-4
Waxing .....	7-2	Glass .....	7-4
Glass .....	7-3	Seat belts .....	7-5
Underbody .....	7-3	Corrosion protection .....	7-5
Wheels .....	7-3	Most common factors contributing to vehicle corrosion .....	7-5
Aluminum alloy wheels .....	7-3	Environmental factors influence the rate of corrosion .....	7-5
Side step boards (if equipped) .....	7-3	To protect your vehicle from corrosion .....	7-5
Chrome parts .....	7-3		



## CLEANING EXTERIOR

In order to maintain the appearance of your vehicle, it is important to take proper care of it.

Whenever possible, park your vehicle inside a garage or in a covered area to minimize the chances of damaging the paint surface of your vehicle.

When it is necessary to park outside, park in a shady area or protect the vehicle with a body cover. **Be careful not to scratch the paint surface when putting on or removing the body cover.**

### WASHING

In the following instances, wash your vehicle as soon as possible to protect the paint surface:

- After a rainfall, which may cause the paint surface damage from acid rain.
  - After driving on coastal roads, which may cause rusting from the sea breeze.
  - When contaminants such as soot, bird droppings, tree sap, metal particles or bugs get on the paint surface.
  - When dust or mud builds up on the paint surface.
1. Wash the vehicle surface with a wet sponge and plenty of water.
  2. Clean the vehicle surface gently and thoroughly using a mild soap, a special vehicle soap or a general purpose dishwashing liquid mixed with clean, lukewarm (never hot) water.



#### CAUTION:

- **Do not wash the vehicle with strong household soap, strong chemical detergents, gasoline or solvents.**

- **Do not wash the vehicle in direct sunlight or while the vehicle body is hot, as the paint surface may become water-spotted.**
- **Avoid using tight-napped or rough cloths, such as washing mitts. Care must be taken when removing caked-on dirt or other foreign substances so the paint surface is not scratched or damaged.**
- **Lock all doors before going through automatic car wash. Locking doors helps prevent fuel-filler lid from opening and becoming damaged.**
- **For models with decorative sticker, observe the following:**
  - **Wash dirt off the vehicle with a wet sponge and plenty of water. Then wipe the vehicle gently using a soft cloth.**
  - **Do not apply direct water pressure, such as high-pressure sprayer, on the vehicle body around the sticker. This may cause the sticker edges to peel away or come off from the vehicle.**

3. Rinse the vehicle thoroughly with plenty of clean water.
4. Use a dampened chamois to dry the paint surface and avoid leaving water spots.

When washing the vehicle, take care of the following:

- Inside flanges, joints and folds on the doors, hatches and hood are particularly vulnerable to the effects of road salt. Therefore, these areas must be cleaned regularly.
- Be sure that the drain holes in the lower edge of the doors are not clogged.

- Spray water to the underbody and in the wheel wells to loosen the dirt and/or wash away road salt.

### REMOVING SPOTS

Remove tar and oil spots, industrial dust, insects, and tree sap as quickly as possible from the paint surface to avoid lasting damage or staining. Special cleaning products are available at a NISSAN dealer or any automotive accessory store.

### WAXING

Regular waxing protects the paint surface and helps maintain a new vehicle appearance.

After waxing, polishing is recommended to remove built-up residue and to avoid a weathered appearance.

A NISSAN dealer can assist you in choosing the appropriate waxing products.



#### CAUTION:

- **Wash your vehicle thoroughly and completely before applying wax to the paint surface.**
- **Always follow the manufacturer's instructions supplied with the wax.**
- **Do not use a wax containing any abrasives, cutting compounds or cleaners that may damage the vehicle finish.**

Machine compounding or aggressive polishing on a base coat/clear coat paint finish may dull the finish or leave swirl marks.

## GLASS

Use glass cleaner to remove smoke and dust film from the glass surfaces. It is normal for glass to become coated with a film after the vehicle is parked in the hot sun. Glass cleaner and a soft cloth will easily remove this film.

## UNDERBODY

In areas where road salt is used in the winter, it is necessary to clean the vehicle's underbody regularly in order to prevent dirt and salt from building up and causing the acceleration of corrosion on the underbody and suspension.

Before the winter and again in the spring, the underseal must be checked and, if necessary, re-treated.

## WHEELS

- Wash the wheels when washing the vehicle to maintain their appearance.
- Clean the inner side of the wheels when the wheel is changed or the underside of the vehicle is washed.
- Do not use abrasive cleaners when washing the wheels.
- Inspect wheel rims regularly for dents or corrosion. This may cause loss of pressure or damage the tire bead.
- NISSAN recommends that the road wheels be waxed to protect against road salt in areas where it is used during winter.

## ALUMINUM ALLOY WHEELS

Wash the wheels regularly with a sponge dampened in a mild soap solution, especially during winter in areas where road salt is used. The salt residue from road salt could discolor the wheels if it is not washed off regularly.



### CAUTION:

**Follow the directions below to avoid staining or discoloring the wheels:**

- **Do not use a cleaner that uses strong acid or alkali contents to clean the wheels.**
- **Do not apply wheel cleaners to the wheels when they are hot. The wheel temperature should be the same as ambient temperature.**
- **Rinse the wheel to completely remove the cleaner within 15 minutes after the cleaner is applied.**

## SIDE STEP BOARDS (if equipped)



### CAUTION:

**When cleaning the side step boards, follow the instruction below:**

- **Do not use a cleaner that uses strong acid or alkali contents to clean the side step boards. Using strong acid or alkali contents may damage the side step board surface.**
- **Rinse the side step boards to completely remove the cleaner within 15 minutes after the cleaner is applied.**

## CHROME PARTS

Clean all chrome parts regularly with a non-abrasive chrome polish to maintain the finish.

## CLEANING INTERIOR

Occasionally remove loose dust from the interior trim, plastic parts and seats using a vacuum cleaner or soft bristled brush. Wipe the vinyl and leather surfaces with a clean, soft cloth dampened in mild soap solution, then wipe clean with a dry, soft cloth.

Regular care and cleaning is required in order to maintain the appearance of the leather.

Before using any fabric protector, read the manufacturer's recommendations. Some fabric protectors contain chemicals that may stain or bleach the seat material.

Use a soft cloth dampened only with water to clean the meter and gauge lens covers.



### CAUTION:

- **Never use benzine, thinner or any similar material.**
- **Small dirt particles can be abrasive and damaging to leather surfaces and should be removed promptly. Do not use saddle soap, car waxes, polishes, oils, cleaning fluids, solvents, detergents or ammonia-based cleaners as they damage the leather natural finish.**
- **Never use fabric protectors unless recommended by the manufacturer.**
- **Do not use glass or plastic cleaner on meter or gauge lens covers. It may damage the lens covers.**

## AIR FRESHENERS

Most air fresheners use a solvent that could affect the vehicle interior. If you use an air freshener, take the following precautions:

- Hanging-type air fresheners can cause permanent discoloration when they contact vehicle interior surfaces. Place the air freshener in a location that allows it to hang free and not contact an interior surface.
- Liquid-type air fresheners typically clip on the vents. These products can cause immediate damage and discoloration when spilled on interior surfaces.

Carefully read and follow the manufacturer's instructions before using air fresheners.

## FLOOR MATS

The use of genuine NISSAN floor mats (if equipped) can extend the life of your vehicle carpet and make it easier to clean the interior. Regardless of what mats are used, be sure they are fitted for your vehicle and are properly positioned in the foot well to prevent interference with pedal operation. Mats should be maintained with regular cleaning and replaced if they become excessively worn.

## Floor mat positioning aid

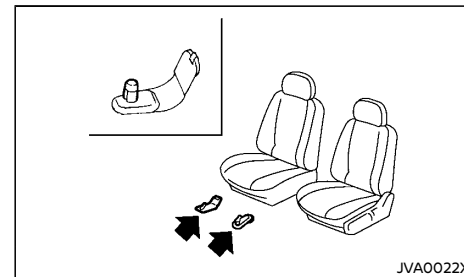

### Example

This vehicle includes floor mat brackets to act as a floor mat positioning aid. NISSAN floor mats have been specially designed for your vehicle model.

Position the mat by placing the floor mat bracket hook through the floor mat grommet hole while centering the mat in the foot area.

Periodically check that the mats are properly positioned.

## GLASS

Use glass cleaner to remove smoke and dust film from the glass surfaces. It is normal for glass to become coated with a film after the vehicle is parked in the hot sun. Glass cleaner and a soft cloth will easily remove this film.



### CAUTION:

**When cleaning the inside of the windows, do not use sharp-edged tools, abrasive cleaners or chlorine-based disinfectant cleaners. They could damage the electrical conductors, such as radio antenna elements or rear window defogger elements.**

## CORROSION PROTECTION

### SEAT BELTS



#### WARNING:

- **Do not allow wet seat belts to roll up in the retractor.**
- **Never use bleach, dye or chemical solvents to clean the seat belts, since these materials may severely weaken the seat belt webbing.**

The seat belts can be cleaned by wiping them with a sponge dampened in a mild soap solution.

Allow the belts to dry completely in the shade before using them. (See "Seat belts" (P.1-8).)

### MOST COMMON FACTORS CONTRIBUTING TO VEHICLE CORROSION

- The accumulation of moisture-retaining dirt and debris in body panel sections, cavities, and other areas.
- Damage to the paint surface and other protective coatings caused by gravel and stone chips or minor traffic accidents.

### ENVIRONMENTAL FACTORS INFLUENCE THE RATE OF CORROSION

#### Moisture

The accumulation of sand, dirt and water on the inside floor of the vehicle can accelerate corrosion. Wet floor carpet/floor mats will not dry completely inside the vehicle. They should be removed and completely dried to avoid floor panel corrosion.

#### Relative humidity

Corrosion will be accelerated in areas of high relative humidity.

#### Temperature

High temperatures accelerate the rate of corrosion to those parts which are not well ventilated.

Corrosion will also be accelerated in areas where the temperatures stay above freezing.

#### Air pollution

Industrial pollution, the presence of salt in the air in coastal areas, or heavy road salt use accelerates the corrosion process. Road salt also accelerates the disintegration of paint surfaces.

### TO PROTECT YOUR VEHICLE FROM CORROSION

- Wash and wax your vehicle often to keep the vehicle clean.
- Always check for minor damage to the paint surface and if any exists, repair it as soon as possible.
- Keep the drain holes in the lower edge of the doors open to avoid water accumulation.
- Check the vehicle underbody for accumulation of sand, dirt or salt. If present, wash with water as soon as possible.



#### CAUTION:

- **Never remove dirt, sand or other debris from the passenger compartment by washing it out with a hose. Remove dirt with a vacuum cleaner.**
- **Never allow water or other liquids to come in contact with electronic components inside the vehicle as this may damage them.**

Chemicals used for road surface deicing are extremely corrosive. They accelerate corrosion and deterioration of underbody components such as the exhaust system, fuel and brake lines, brake cables, floor pan and fenders.

**In the winter, the underbody must be cleaned periodically.**

For additional protection against rust and corrosion, which may be required in some areas, consult a NISSAN dealer.

**MEMO**

# 8 Maintenance and do-it-yourself

Maintenance requirements .....	8-2	Automatic Transmission Fluid (ATF) (if equipped) .....	8-17
Scheduled maintenance .....	8-2	7-speed Automatic Transmission (AT) model .....	8-17
General maintenance .....	8-2	Power steering fluid .....	8-18
Where to go for service .....	8-2	Air cleaner filter .....	8-18
General maintenance .....	8-2	Wiper blades .....	8-18
Explanation of general maintenance items .....	8-2	Windshield wiper blades .....	8-18
Maintenance precautions .....	8-4	Window washer fluid .....	8-20
Engine compartment check locations .....	8-5	Battery .....	8-21
QR25DE engine .....	8-5	Vehicle battery .....	8-21
YD25DDTi engine .....	8-6	Remote controller battery (if equipped) .....	8-22
YS23DDT/DDTT engine .....	8-7	Intelligent Key battery (if equipped) .....	8-23
Engine cooling system .....	8-7	Variable voltage control system (if equipped) .....	8-24
Checking engine coolant level .....	8-8	Fuses .....	8-24
Changing engine coolant .....	8-8	Engine compartment .....	8-24
Engine oil .....	8-9	Passenger compartment .....	8-25
Checking engine oil level .....	8-9	Lights .....	8-26
Changing engine oil and oil filter .....	8-10	Headlights .....	8-26
Protect environment .....	8-13	Exterior lights .....	8-27
Fuel filter (YD25DDTi engine model) .....	8-13	Interior lights .....	8-27
Draining water .....	8-13	Light locations .....	8-28
Bleeding the fuel system .....	8-13	Tires and wheels .....	8-32
Drive belt .....	8-14	Tire inflation pressure .....	8-32
Spark plugs (QR25DE engine model) .....	8-14	Types of tires .....	8-32
Iridium-tipped spark plugs .....	8-14	Tire chains .....	8-33
Brakes .....	8-15	Tire rotation .....	8-33
Checking parking brake .....	8-15	Tire wear and damage .....	8-33
Checking foot brake .....	8-15	Tire age .....	8-34
Brake booster .....	8-15	Changing tires and wheels .....	8-34
Brake fluid .....	8-16	Wheel balance .....	8-34
Clutch fluid (if equipped) .....	8-17	Spare tire .....	8-34

## MAINTENANCE REQUIREMENTS

Some day-to-day and regular maintenance is essential to maintain your vehicle's good mechanical condition, as well as its emission and engine performance.

It is the owner's responsibility to make sure that the specified maintenance, as well as general maintenance, is performed.

As the vehicle owner, you are the only one who can ensure that your vehicle receives the proper maintenance care.

### SCHEDULED MAINTENANCE

For your convenience, the required scheduled maintenance items are described and listed in a separate Warranty Information and Maintenance booklet. You must refer to that booklet to ensure that necessary maintenance is performed on your vehicle at regular intervals.

### GENERAL MAINTENANCE

General maintenance includes those items which should be checked during normal day-to-day operation of the vehicle. They are essential if your vehicle is to continue to operate properly. It is your responsibility to perform these procedures regularly as prescribed.

Performing general maintenance checks requires minimal mechanical skill and only a few general automotive tools.

These checks or inspections can be done by yourself, a qualified technician, or if you prefer, your NISSAN dealer.

### WHERE TO GO FOR SERVICE

If maintenance service is required or your vehicle appears to malfunction, have the systems checked and tuned by an authorized NISSAN dealer.

## GENERAL MAINTENANCE

During normal day-to-day operation of the vehicle, general maintenance should be performed regularly as prescribed in this section. If you detect any unusual sounds, vibrations or smells, be sure to check for the cause or have a NISSAN dealer do it promptly. In addition, you should notify a NISSAN dealer if you think that repairs are required.

When performing any checks or maintenance work, closely observe "Maintenance precautions" (P.8-4).

### EXPLANATION OF GENERAL MAINTENANCE ITEMS

**Additional information on the following items with "" is found later in this section.**

#### Outside vehicle

The maintenance items listed here should be performed from time to time, unless otherwise specified.

#### **Doors and hood:**

Check that all doors and the hood operate smoothly as well as the back door, trunk lid and hatch. Also make sure that all latches lock securely. Lubricate if necessary. Make sure that the secondary latch keeps the hood from opening when the primary latch is released. When driving in areas using road salt or other corrosive materials, check lubrication frequently.

#### **Lights\*:**

Clean the headlights on a regular basis. Make sure that the headlights, stop lights, tail lights, turn signal lights, and other lights are all operating properly and installed securely. Also check the aim of the headlights.



**Tires\*:**

Check the pressure with a gauge often and always prior to long distance trips. Adjust the pressure in all tires, including the spare, to the pressure specified. Check carefully for damage, cuts or excessive wear.

**Tire rotation\*:**

In the case that Two-Wheel Drive (2WD) and front and rear tires are same size; tires should be rotated every 10,000 km (6,000 miles). Tires marked with directional indicators can only be rotated between front and rear. Make sure that the directional indicators point in the direction of wheel rotation after the tire rotation is completed.

In the case that Four-Wheel Drive and All Wheel Drive (4WD/AWD) and front and rear tires are same size; tires should be rotated every 5,000 km (3,000 miles). Tires marked with directional indicators can only be rotated between front and rear. Make sure that the directional indicators point in the direction of wheel rotation after the tire rotation is completed.

In the case that front tires are different size from rear tires; tires cannot be rotated.

The timing for tire rotation may vary according to your driving habits and the road surface conditions.

**Tire Pressure Monitoring System (TPMS) transmitter components (if so equipped):**

Replace the TPMS transmitter grommet seal, valve core and cap when the tires are replaced due to wear or age.

**Wheel alignment and balance:**

If the vehicle should pull to either side while driving on a straight and level road, or if you detect uneven or abnormal tire wear, there may be a need for wheel alignment. If the steering wheel or seat vibrates at normal highway speeds, wheel balancing may be needed.

**Windshield:**

Clean the windshield on a regular basis. Check the windshield at least every six months for cracks or other damage. Repair as necessary.

**Wiper blades\*:**

Check for cracks or wear if not functioning correctly. Replace as necessary.

**Inside vehicle**

The maintenance items listed here should be checked on a regular basis, such as when performing periodic maintenance, cleaning the vehicle, etc.

**Accelerator pedal:**

Check the pedal for smooth operation and make sure that the pedal does not catch or require uneven effort. Keep the floor mats away from the pedal.

**Brake pedal\*:**

Check the pedal for smooth operation and make sure that it is the proper distance from the floor mat when depressed fully. Check the brake booster function. Be sure to keep the floor mats away from the pedal.

**Parking brake\*:**

Check the parking brake operation regularly. Check that the lever (if so equipped) or the pedal (if so equipped) has the proper travel. Also make sure that the vehicle is held securely on a fairly steep hill when only the parking brake is applied.

**Seat belts:**

Check that all parts of the seat belt system (for example, buckles, anchors, adjusters and retractors) operate properly and smoothly, and are installed securely. Check the belt webbing for cuts, fraying, wear or damage.

**Steering wheel:**

Check for changes in the steering condition, such as excessive play, hard steering or strange noises.

**Warning lights and chimes:**

Make sure that all warning lights and chimes are operating properly.

**Windshield defogger:**

Check that the air comes out of the defogger outlets properly and in good quantity when operating the heater or air conditioner.

**Windshield wiper and washer\*:**

Check that the wipers and washer operate properly and that the wipers do not streak.

**Under hood and vehicle**

The maintenance items listed here should be checked periodically (for example, each time you check the engine oil or refuel).

### **Battery (except for maintenance free batteries)\*:**

Check the fluid level in each cell. It should be between the UPPER and LOWER lines. Vehicles operated in high temperatures or under severe conditions require frequent checks of the battery fluid level.

### **Brake (and clutch) fluid level(s)\*:**

For Manual Transmission (MT) model; make sure that the brake and clutch fluid levels are between the MAX and MIN lines on the reservoirs.

Except for Manual Transmission (MT) model; make sure that the brake fluid level is between the MAX and MIN lines on the reservoir.

### **Engine coolant level\*:**

Check the coolant level when the engine is cold. Make sure that the coolant level is between the MAX and MIN lines on the reservoir.

### **Engine drive belt(s)\*:**

Make sure that drive belt(s) is not frayed, worn, cracked or oily.

### **Engine oil level\*:**

Check the level after parking the vehicle (on a level ground) and turning off the engine.

### **Fluid leaks:**

Check under the vehicle for fuel, oil, water or other fluid leaks after the vehicle has been parked for a while. Water dripping from the air conditioner after use is normal. If you should notice any leaks or if fuel fumes are evident, check for cause and have it corrected immediately.

### **Power steering fluid level and lines\*:**

Check the level when the fluid is cold with the engine off. Check the lines for proper attachment, leaks, cracks, etc.

### **Windshield washer fluid\*:**

Check that there is adequate fluid in the reservoir.

## **MAINTENANCE PRECAUTIONS**

When performing any inspection or maintenance work on your vehicle, always take care to prevent serious accidental injury to yourself or damage to the vehicle. The following are general precautions which should be closely observed.



### **WARNING:**

- **Park the vehicle on a level surface, apply the parking brake securely and block the wheels to prevent the vehicle from moving.** Move the shift lever to the "P" (Park) position (AT model) or the shift lever to the "N" (Neutral) position (MT model).
- **Be sure the ignition switch is in the "LOCK" position when performing any parts replacement or repairs.**
- **Do not work under the hood while the engine is hot. Always turn off the engine and wait until it cools down.**
- **If you must work with the engine running, keep your hands, clothing, hair and tools away from moving fans, belts and any other moving parts.**
- **It is advisable to secure or remove any loose clothing and any jewelry, such as rings, watches, etc. before working on your vehicle.**

- **If you must run the engine in an enclosed space such as a garage, be sure there is proper ventilation for exhaust gases to escape.**
- **Never get under the vehicle while it is supported by a jack.**
- **Keep smoking materials, flame and sparks away from fuel and the battery.**
- **Never connect or disconnect either the battery or any transistorized component connector while the ignition switch is in the "ON" position.**
- **On gasoline engine models with the Multiport Fuel Injection (MFI) system, the fuel filter and fuel lines should be serviced by a NISSAN dealer because the fuel lines are under high pressure even when the engine is turned off.**
- **Your vehicle is equipped with an automatic engine cooling fan. It may come on at any time without warning, even if the ignition switch is in the "OFF" position and the engine is not running. To avoid injury, always disconnect the negative battery cable before working near the fan.**
- **Always wear eye protection whenever you work on your vehicle.**
- **Never leave the engine or the transmission related component harness connector disconnected while the ignition switch is in the "ON" position.**
- **Avoid direct contact with used engine oil and coolant. Improperly disposed engine oil, engine coolant, and/or other vehicle fluids can hurt the environment. Always conform to local regulations for disposal of vehicle fluids.**

This "8. Maintenance and do-it-yourself" section

## ENGINE COMPARTMENT CHECK LOCATIONS

provides instructions regarding only those items which are relatively easy for an owner to perform.

You should be aware that incomplete or improper servicing may result in operating difficulties or excessive emissions, and could affect your warranty coverage. **If in doubt about any servicing, have it done by a NISSAN dealer.**

### QR25DE ENGINE

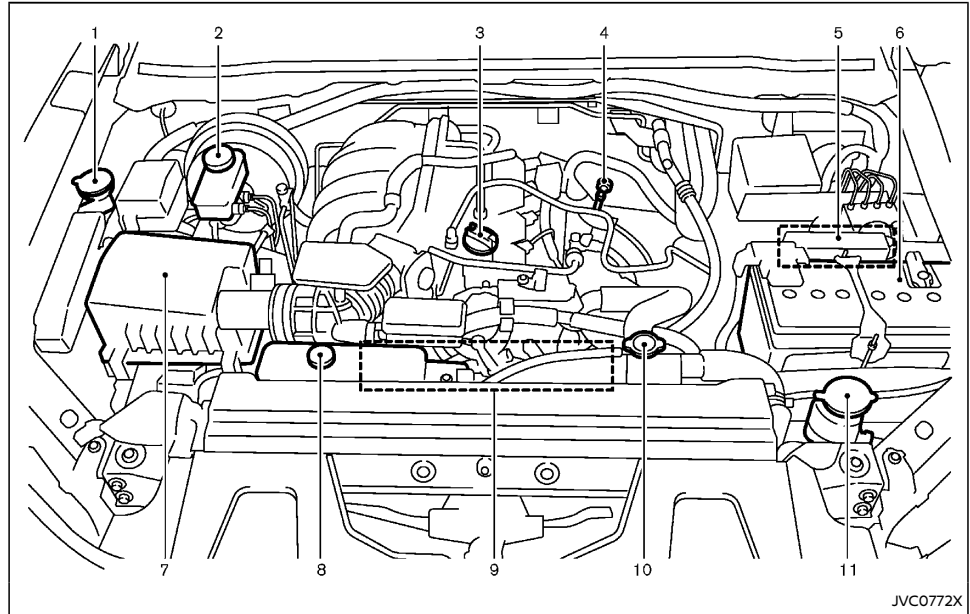

- |                                      |                                       |
|--------------------------------------|---------------------------------------|
| 1. Window washer fluid reservoir     | 8. Engine coolant reservoir           |
| 2. Brake and clutch* fluid reservoir | 9. Engine drive belt location         |
| 3. Engine oil filler cap             | 10. Radiator filler cap               |
| 4. Engine oil dipstick               | 11. Power steering fluid reservoir    |
| 5. Fuse/fusible link holder          | *: For Manual Transmission (MT) model |
| 6. Battery                           |                                       |
| 7. Air cleaner                       |                                       |

## YD25DDTi ENGINE

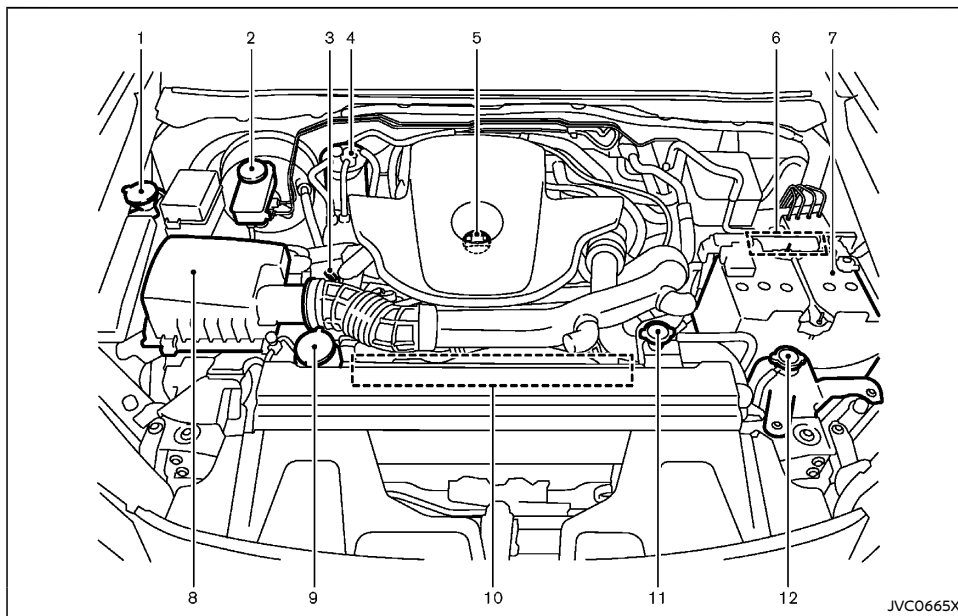

1. Window washer fluid reservoir
2. Brake and clutch\*1 fluid reservoir\*2
3. Engine oil dipstick
4. Fuel filter
5. Engine oil filler cap
6. Fuse/fusible link holder
7. Battery
8. Air cleaner

9. Power steering fluid reservoir
10. Engine drive belt location
11. Radiator filler cap
12. Engine coolant reservoir

\*1: For Manual Transmission (MT) model

\*2: The layout illustrated is for the Right-Hand Drive (RHD) model. On the Left-Hand Drive (LHD) model, brake (and clutch) fluid reservoir is located on the opposite side.

## ENGINE COOLING SYSTEM

### YS23DDT/DDTT ENGINE

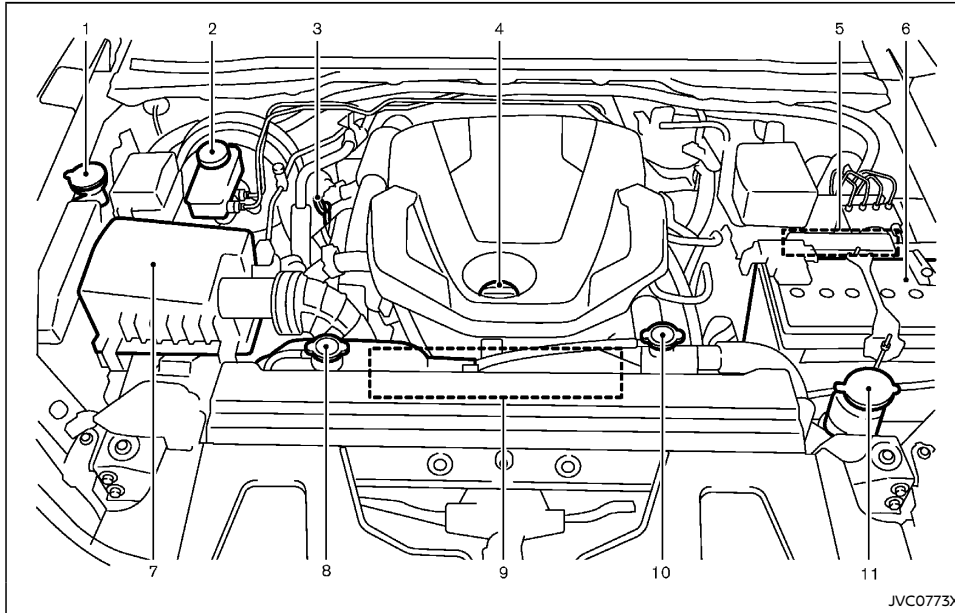

- |                                      |                                       |
|--------------------------------------|---------------------------------------|
| 1. Window washer fluid reservoir     | 9. Engine drive belt location         |
| 2. Brake and clutch* fluid reservoir | 10. Radiator filler cap               |
| 3. Engine oil dipstick               | 11. Power steering fluid reservoir    |
| 4. Engine oil filler cap             | *: For Manual Transmission (MT) model |
| 5. Fuse/fusible link holder          |                                       |
| 6. Battery                           |                                       |
| 7. Air cleaner                       |                                       |
| 8. Engine coolant reservoir          |                                       |

#### **WARNING:**

- Never remove the radiator or coolant reservoir cap when the engine is hot. Serious burns could be caused by high-pressure fluid escaping from the radiator. Wait until the engine and radiator cool down.
- Engine coolant is poisonous and should be stored carefully in marked containers out of the reach of children.

The engine cooling system is filled at the factory with a high-quality, year-round, anti-freeze coolant solution. The anti-freeze solution contains rust and corrosion inhibitors, therefore additional cooling system additives are not necessary.

#### **CAUTION:**

- Never use any cooling system additives such as radiator sealer. Additives may clog the cooling system and cause damage to the engine, transmission and/or cooling system.
- When adding or replacing coolant, be sure to use only Genuine NISSAN Engine Coolant or equivalent in its quality with the proper mixture ratio. Examples of the mixture ratio of coolant and water are shown in the following table:

### For QR25DE and YD25DDTi engine model

Outside temperature down to		Engine coolant (concentrated)	Demineralized or distilled water
°C	°F		
-15	5	30%	70%
-35	-30	50%	50%

### For YS23DDT/YS23DDTT engine model

Outside temperature down to		Engine coolant (concentrated)	Demineralized or distilled water
°C	°F		
-35	-30	50%	50%

Use Genuine NISSAN Engine Coolant or equivalent in its quality. Genuine NISSAN Engine Coolant is a pre-mixed (mixture ratio 50%) type coolant.

The use of other types of coolant solutions may damage the engine cooling system.

The radiator is equipped with a pressure cap. To prevent engine damage, use only a Genuine NISSAN radiator cap or its equivalent when replacement is required.

### CHECKING ENGINE COOLANT LEVEL

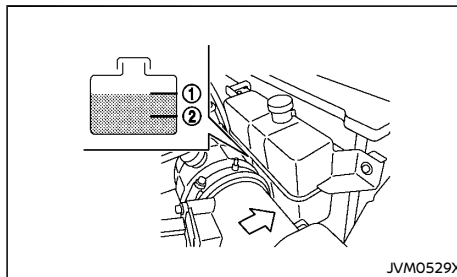

QR25DE engine

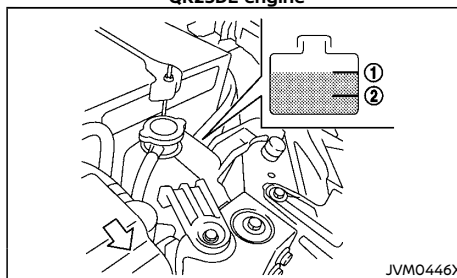

YD25DDTi engine

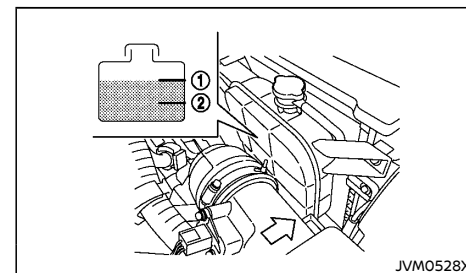

YS23DDT/DDTT engine

Check the coolant level in the reservoir when the engine is cold. If the coolant level is below the MIN level ②, add coolant up to the MAX level ①. If the reservoir is empty, check the coolant level in the radiator **when the engine is cold**. If there is insufficient coolant in the radiator, fill the radiator with coolant up to the filler opening and also add it to the reservoir up to the MAX level ①. Tighten the cap securely after adding engine coolant.

**If the cooling system frequently requires coolant, have it checked by a NISSAN dealer.**

### CHANGING ENGINE COOLANT

Contact a NISSAN dealer if replacement is required.

Major engine cooling system repair should be performed by a NISSAN dealer. The service procedures can be found in the appropriate NISSAN Service Manual.

Improper servicing can result in reduced heater performance and engine overheating.

## ENGINE OIL



### WARNING:

- To avoid being scalded, never change the coolant when the engine is hot.
- Never remove the radiator or coolant reservoir cap when the engine is hot. Serious burns could be caused by high pressure fluid escaping from the radiator.
- Avoid direct skin contact with used coolant. If skin contact is made, wash thoroughly with soap or hand cleaner as soon as possible.
- Keep coolant out of reach of children and pets.

Engine coolant must be disposed of properly. Check your local regulations.

### CHECKING ENGINE OIL LEVEL

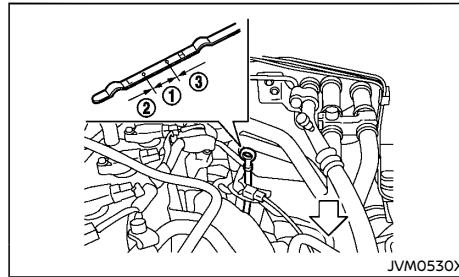

QR25DE engine

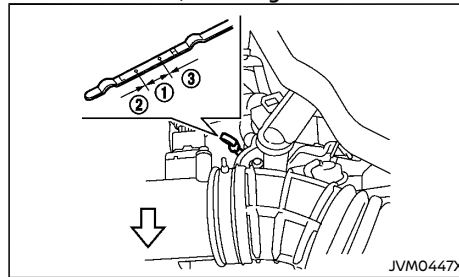

YD25DDTi engine

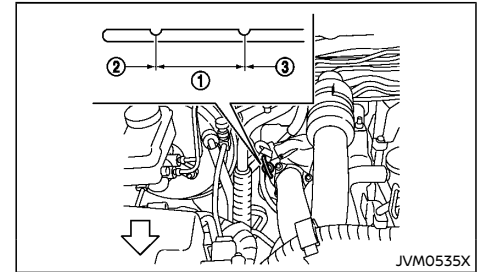

YS23DDT/DDTT engine

1. Park the vehicle on a level surface and apply the parking brake.
2. Start the engine and warm it up until the engine temperature reaches the normal operating temperature (approximately 5 minutes).
3. Stop the engine.
4. Wait at least 10 minutes for the engine oil to drain back to the oil pan.
5. Remove the dipstick and wipe it clean.
6. Reinsert the dipstick all the way.
7. Remove the dipstick and check the oil level. It should be within the range ①.
8. If the oil level is below ②, remove the oil filler cap and pour the recommended oil into the opening. Do not overfill ③.  
When filling the engine oil, do not remove the dipstick.
9. Recheck the oil level with the dipstick.



### CAUTION:

- The oil level should be checked regularly. Operating your vehicle with an insufficient amount of oil can damage the

engine, and such damage is not covered by the warranty.

- It is normal to add some oil between oil maintenance intervals or during the break-in period, depending on the severity of operating conditions.

## CHANGING ENGINE OIL AND OIL FILTER



### WARNING:

- Used oil must be disposed of properly. Never pour or dump oil into the ground, canals, rivers, etc. It should be disposed of at proper waste facilities. NISSAN recommends having your oil changed by a NISSAN dealer.
- Be careful not to burn yourself, as the engine oil may be hot.
- Prolonged and repeated contact with used engine oil may cause skin cancer.
- Avoid direct skin contact with used oil. If contacted, wash thoroughly with soap or hand cleaner and plenty of water as soon as possible.
- Store used engine oil in marked containers out of the reach of children.

### Vehicle set-up

1. Park the vehicle on a level surface and apply the parking brake.
2. Start the engine and warm it up until the engine temperature reaches the normal operating temperature (approximately 5 minutes).
3. Stop the engine.
4. Wait at least 10 minutes for the engine oil to drain back to the oil pan.

## Engine oil and filter

For QR25DE and YD25DDTi engine model:

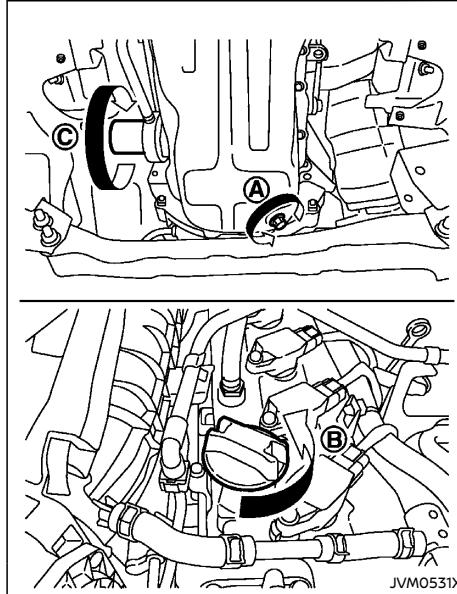

QR25DE engine (except for 2WD with Manual Transmission for Australia and New Zealand)

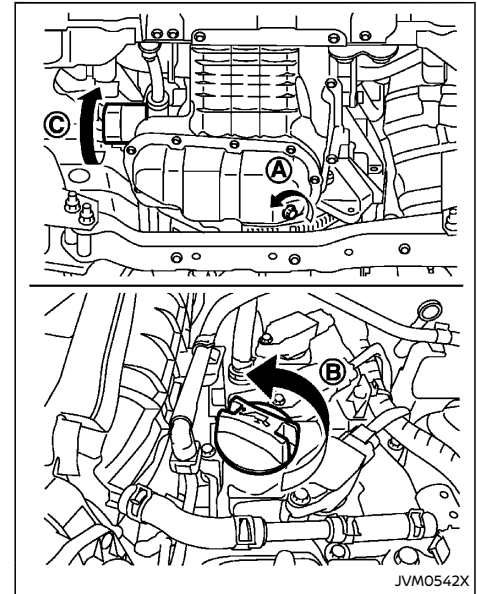

QR25DE engine (for 2WD with Manual Transmission for Australia and New Zealand)



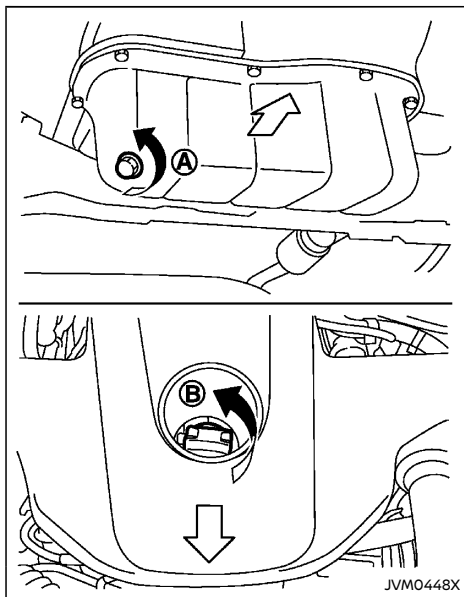

YD25DDTi engine

JVM0448X

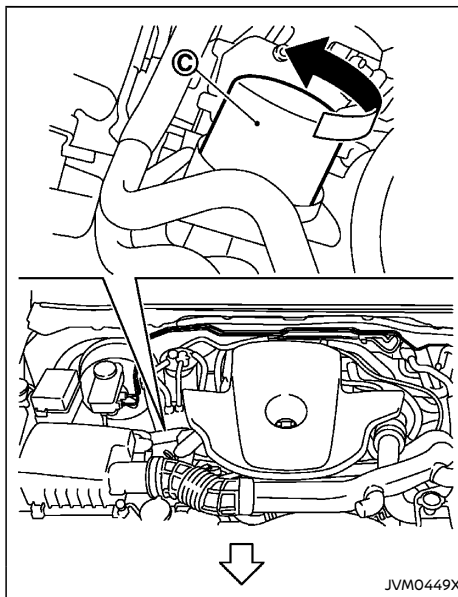

YD25DDTi engine

JVM0449X

1. Place a large drain pan under the drain plug **A**.
2. Remove the oil filler cap **B** and completely drain the oil.
3. Remove the drain plug **A** with a wrench.  
**Waste oil must be disposed of properly. Check your local regulations.**
4. (Perform steps 4 to 8 only when the engine oil filter change is needed.)  
Loosen the oil filter **C** with an oil filter wrench.

5. Remove the oil filter by turning it by hand.
6. Wipe the engine oil filter mounting surface with a clean cloth.  
**Be sure to remove any old gasket remaining on the mounting surface.**
7. Apply new engine oil to the gasket of a new oil filter.

8. Screw in the oil filter clockwise until a slight resistance is felt, and then tighten an additional 2/3 of a turn to secure the oil filter.

**Oil filter tightening torque:**

**YD25DDTi engine**

**16 to 20 N·m**

**(1.6 to 2.0 kg·m, 12 to 15 ft·lb)**

**QR25DE engine**

**15 to 20 N·m**

**(1.5 to 2.0 kg·m, 11 to 15 ft·lb)**

9. Clean and reinstall the drain plug and new washer. Securely tighten the drain plug with a wrench. Do not use excessive force.

**Drain plug tightening torque:**

**29 to 39 N·m**

**(3.0 to 4.0 kg·m, 22 to 29 ft·lb)**

10. Sufficiently refill with the recommended engine oil. (See "Recommended fluids/Lubricants and capacities" (P.9-2).)
11. Securely install the oil filler cap.
12. Start the engine.
13. Check the drain plug and the oil filter for any sign of leakage. Correct as required.
14. Stop the engine.
15. Wait at least 10 minutes. Check the engine oil level according to the proper procedure. (See "Checking engine oil level" (P.8-9).) Add engine oil if necessary.

**For YS23DDT/DDTT engine model:**

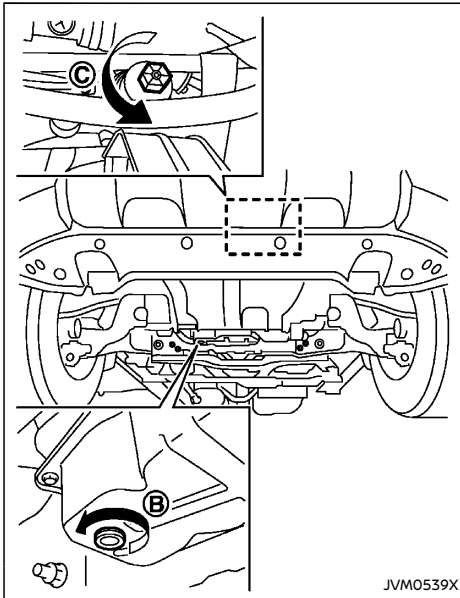
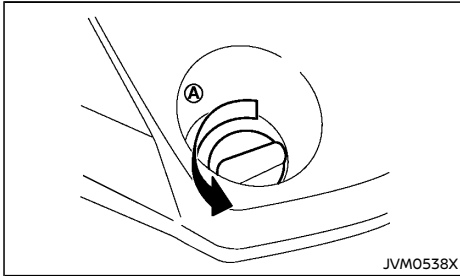

- Ⓐ Oil filler cap
- Ⓑ Oil drain plug
- Ⓒ Oil filter

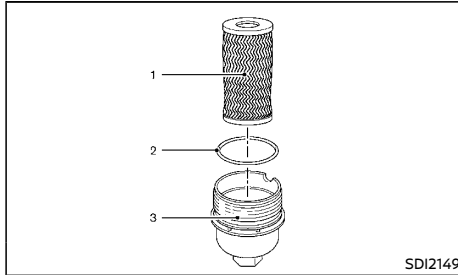

- 1 Oil filler element
  - 2 O-ring (mounted on the cover)
  - 3 Oil filter cover/cap
1. Place a large drain pan under the drain plug Ⓑ.
  2. Remove the drain plug Ⓑ with a wrench.
  3. Remove the oil filler cap Ⓐ and completely drain the oil.

If the oil filter is to be changed, remove and replace it at this time.



**CAUTION:**

**Waste oil must be disposed of properly. Check your local regulations.**

4. Remove the front spoiler and the engine under cover.
5. Loosen the oil filter cover Ⓒ with a wrench.

6. Remove the oil filter cover Ⓒ then the oil filter element.
7. Remove the rubber O-ring from the filter cover.
8. Wipe the entire oil filter cover with a clean cloth.

Be sure to remove any old O-ring remaining on the mounting surface.

9. Apply new engine oil to the O-ring. Install the new O-ring on the oil filter cap.
10. Insert the oil filter element into the engine oil filter cover.
11. Screw in the oil filter cover until a slight resistance is felt, and then tighten the filter completely.

**Oil filter cover tightening torque:**

**25 N·m  
(2.6 kg-m, 18 ft-lb)**

12. Clean and reinstall the drain plug and new washer. Securely tighten the drain plug with a wrench. Do not use excessive force.

**Drain plug tightening torque:**

**50 N·m  
(5.1 kg-m, 36.9 ft-lb)**

13. Refill the recommended engine oil and quantity. (See "Recommended fluids/lubricants and capacities" (P.9-2).)
14. Securely install the oil filler cap.
15. Start the engine.
16. Check the drain plug for any sign of leakage.
17. Dispose of the used oil in the proper manner. Check your local regulations.
18. Check the engine oil level according to the proper procedure. (See "Checking engine oil level" (P.8-9).)

## FUEL FILTER (YD25DDTi engine model)

19. Reinstall the engine under cover and the front spoiler.

### After operation

Dispose of waste oil and filter properly. Check your local regulations.

### PROTECT ENVIRONMENT

It is illegal to pollute drains, watercourses and soil. Use authorized waste collection facilities, including civil amenity sites and garages providing facilities for disposal of used oil and used oil filters. If in doubt, contact your local authority for advice on disposal.

**The regulations concerning the pollution of the environment will vary from country to country.**

### DRAINING WATER

If the water-in-fuel warning light "☹" comes on while the engine is running, drain water in the fuel filter as follows:

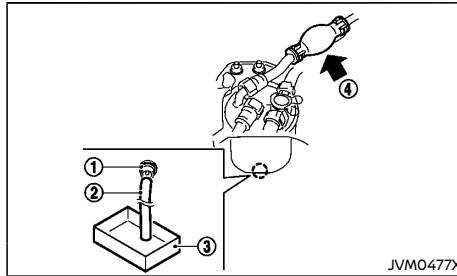

1. Connect a suitable drain hose ② to the drain plug ①.
2. Place a drain pan ③ under the hose ②.
3. Loosen manually the drain plug ① with 4 to 5 turns and operate the priming valve ④ to drain the water out of the fuel filter.
4. After draining, close the drain plug manually.



#### CAUTION:

- If the drain plug is tightened excessively, it can be damaged and as a result, fuel will leak.
  - Do not use tools to tighten the drain plug.
5. Bleed air from the fuel system. For details, see "Bleeding the fuel system" (P.8-13).
  6. Start the engine and make sure there is no fuel leakage. Correct as required.

### BLEEDING THE FUEL SYSTEM

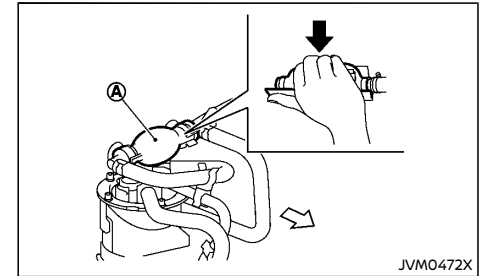

Bleed the air out of the fuel system after refilling an empty fuel tank by the following procedure:

1. Operate the priming valve ① several times until there is a sudden resistance felt in the pressure, then stop.
2. Crank the engine until the engine starts.



#### CAUTION:

**Do not crank the engine for more than 30 seconds.**

#### NOTE:

- If the engine does not start, stop cranking and repeat step 1 of the procedure.
- If the engine does not operate smoothly after it has started, race it two or three times.

## DRIVE BELT

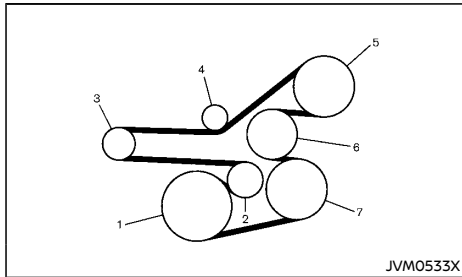

**QR25DE engine**

1. Crankshaft pulley
2. Automatic tensioner
3. Alternator
4. Idler pulley
5. Power steering fluid pump
6. Water pump
7. Air conditioner compressor

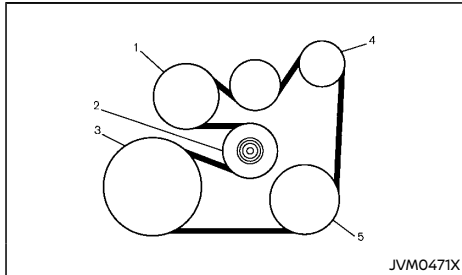

**YD25DDTi engine**

1. Water pump
2. Automatic tensioner
3. Crankshaft pulley
4. Alternator

5. Air conditioner compressor

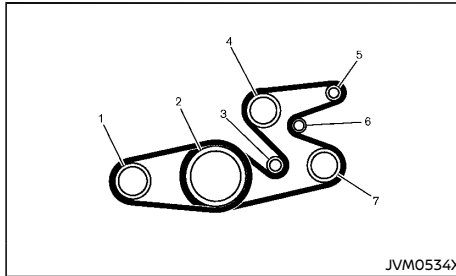

**YS23DDT/DDTT engine**

1. Air conditioner compressor
2. Crankshaft pulley
3. Idler pulley
4. Water pump
5. Alternator
6. Automatic tensioner
7. Power steering fluid pump

Be sure the ignition switch is in the "LOCK" position.

Visually inspect the belt for signs of unusual wear, cuts, fraying or looseness. Check the condition regularly. If the belt is in poor condition or loose, have it replaced or adjusted by a NISSAN dealer.

## SPARK PLUGS (QR25DE engine model)



### WARNING:

**Be sure the engine and ignition switch are off and that the parking brake is applied.**

Replace the spark plugs according to the maintenance schedule log in a separate maintenance booklet.

If replacement is required, contact a NISSAN dealer.

### IRIDIUM-TIPPED SPARK PLUGS

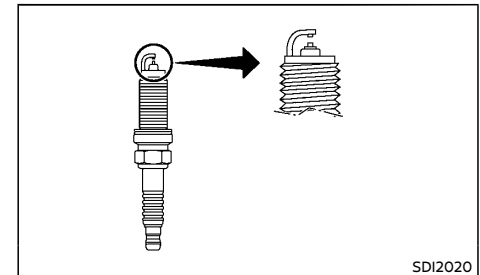

It is not necessary to replace the iridium-tipped spark plugs as frequently as the conventional type of spark plugs. These spark plugs are designed to last much longer than the conventional type of spark plug.



### CAUTION:

- Do not reuse the iridium-tipped spark plugs by cleaning or re-gapping.
- Always replace with the recommended iridium-tipped spark plugs.

## BRAKES

### CHECKING PARKING BRAKE

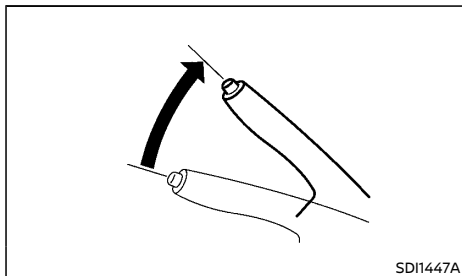

From the released position, pull the parking brake lever slowly and firmly. If the number of clicks is out of the range listed, see a NISSAN dealer.

**8 to 9 clicks under a pulling force of 196 N (20 kg, 44 lb)**

### CHECKING FOOT BRAKE

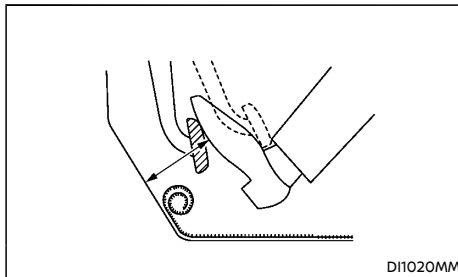

#### **WARNING:**

**See a NISSAN dealer for a brake system check if the brake pedal height does not return to normal.**

With the engine running, check the distance between the upper surface of the pedal and the metal floor. If it is out the range listed, see a NISSAN dealer.

**Depressing force  
490 N (50 kg, 110 lb)**

	LHD model	RHD model
Diesel engine model	110 mm (4.3 in) or more	100 mm (3.9 in) or more
Gasoline engine model	-	109 mm (4.3 in) or more

### Brake pad wear warning

The disc brake pads have audible wear warnings. When a brake pad requires replacement, it will make a high pitched scraping sound when the vehicle is in motion. This scraping sound will first occur only when the brake pedal is depressed. After more wear of the brake pad, the sound will always be heard even if the brake pedal is not depressed. Have the brakes checked as soon as possible if the wear warning sound is heard.

Under some driving or climate conditions, occasional brake squeaks, squeals or other noises may be heard. Occasional brake noise during light to moderate stops is normal and does not affect the function or performance of the brake system.

The rear drum brakes do not have audible wear indicators. Should you ever hear an unusually loud noise from the rear drum brakes, have them checked as soon as possible by a NISSAN dealer.

Proper brake inspection intervals should be followed. For additional information, see a separate maintenance booklet.

### BRAKE BOOSTER

Check the brake booster function as follows:

1. With the engine off, depress and release the foot brake pedal several times. When the brake pedal movement (distance of travel) remains the same from one pedal application to the next, continue on to the next step.
2. While depressing the foot brake pedal, start the engine. The pedal height should drop a little.

## BRAKE FLUID

3. With the foot brake pedal depressed, stop the engine. Keep the pedal depressed for about 30 seconds. The pedal height should not change.
4. Run the engine for 1 minute without depressing the foot brake pedal, then turn it off. Depress the foot brake pedal several times. The pedal travel distance will decrease gradually with each depression as the vacuum is released from the booster.

If the brakes do not operate properly, have the brakes checked by a NISSAN dealer.



### WARNING:

- Use only new fluid from a sealed container. Old, inferior, or contaminated fluid may damage the brake system. The use of improper fluids can damage the brake system and affect the vehicle's stopping ability.
- Clean the filler cap before removing.
- Brake fluid is poisonous and should be stored carefully in marked containers out of the reach of children.



### CAUTION:

- Refilling and checking the brake system should be left to a NISSAN dealer who will have the necessary brake fluid and technical knowledge.
- Do not spill the fluid on painted surfaces. This will damage the paint. If fluid is spilled, wash with water.

See "Recommended fluids/lubricants and capacities" (P.9-2) for recommended types of fluid.

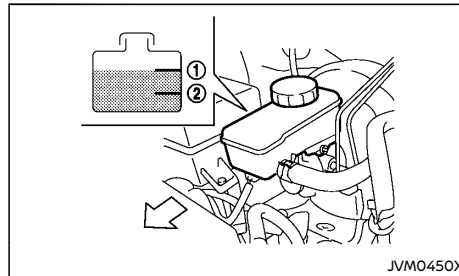

Check the fluid level in the reservoir. If the fluid is below the MIN line ②, the brake warning light

will illuminate. Add fluid up to the MAX line ①. If fluid must be added frequently, the system should be thoroughly checked by your NISSAN dealer.

## CLUTCH FLUID (if equipped)



### WARNING:

- Use only new fluid from a sealed container. Old, inferior, or contaminated fluid may damage the clutch system.
- Clean the filler cap before removing.
- Clutch fluid is poisonous and should be stored carefully in marked containers out of the reach of children.



### CAUTION:

- Refilling and checking the clutch system should be left to a NISSAN dealer who will have the necessary clutch fluid and technical knowledge.
- Do not spill the fluid on painted surfaces. This will damage the paint. If fluid is spilled, wash with water.

NISSAN dealer.

See "Recommended fluids/lubricants and capacities" (P.9-2) for recommended types of fluid.

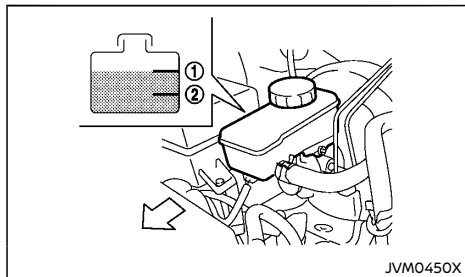

Check the fluid level in the reservoir. If the fluid is below the MIN line ②, add fluid up to the MAX line ①.

If the fluid must be added frequently, the clutch system should be thoroughly checked by a

## AUTOMATIC TRANSMISSION FLUID (ATF) (if equipped)

### 7-SPEED AUTOMATIC TRANSMISSION (AT) MODEL

Contact a NISSAN dealer if checking or replacement is required.



### CAUTION:

- Use only Genuine NISSAN Matic S ATF. Do not mix with other fluids.
- Using Automatic Transmission Fluid (ATF) other than Genuine NISSAN Matic S ATF will cause deterioration in driveability and automatic transmission durability, and may damage the automatic transmission, which is not covered by the warranty.

## POWER STEERING FLUID

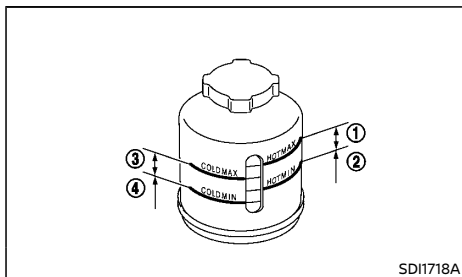

### WARNING:

Power steering fluid is poisonous and should be stored carefully in marked containers out of the reach of children.

Check the fluid level in the reservoir. The fluid level should be checked in the HOT range (①: HOT MAX., ②: HOT MIN.) at fluid temperatures of 50 to 80°C (122 to 176°F) or in the COLD range (③: COLD MAX., ④: COLD MIN.) at fluid temperatures of 0 to 30°C (32 to 86°F).

If it is necessary to add fluid, use only specified fluid. **Do not overfill.** (See "Recommended fluids/lubricants and capacities" (P.9-2) for recommended types of fluid.)

## AIR CLEANER FILTER

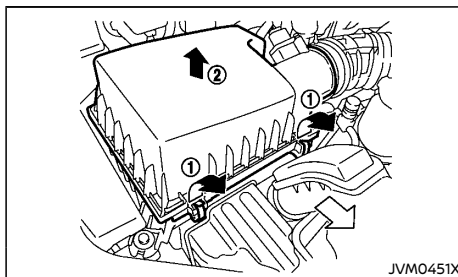

### WARNING:

- **Operating the engine with the air cleaner filter off can cause you or others to be burned. The air cleaner filter not only cleans the intake air, it also stops flame if the engine backfires. If the air cleaner filter is not installed and the engine backfires, you could be burned. Never drive with the air cleaner filter off. Be cautious working on the engine when the air cleaner filter is off.**
- **Never pour fuel into the throttle body or attempt to start the engine with the air cleaner removed. Doing so could result in serious injury.**

To remove the filter, release the lock pins ① and pull the unit upward ②.

The dry paper type filter element may be cleaned and reused. Replace the air filter according to the maintenance schedule shown in a separate maintenance booklet.

When replacing the filter, wipe the inside of the air cleaner housing and the cover with a damp cloth.

## WIPER BLADES

### WINDSHIELD WIPER BLADES

#### Cleaning

If the windshield does not become clear after using the windshield washer or if the wiper blades chatter when operating the windshield wipers, wax or other materials may be on the windshield and/or wiper blades.

Clean the outside of the windshield surface with a washer solution or mild detergent. Your windshield is clean if beads do not form when rinsing with water.

Clean the blade by wiping it with a cloth soaked in a washer solution or a mild detergent. Rinse the blade with water. If your windshield is still not clear after cleaning the blades and using the wipers, replace the blades.



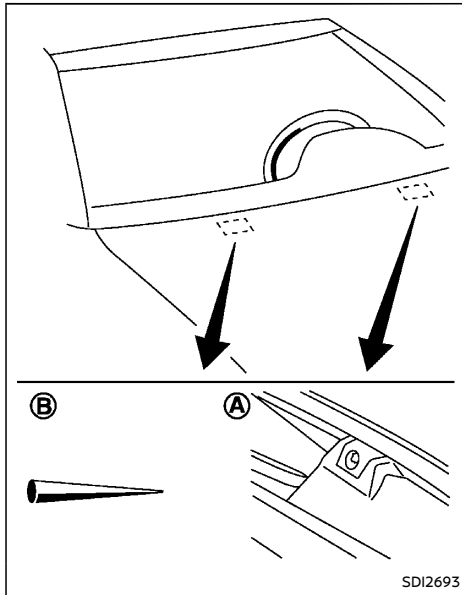

Be careful not to clog the washer nozzle (A). This may cause improper windshield washer operation. If the nozzle is clogged, remove any objects with a needle or small pin (B). Be careful not to damage the nozzle.

## Replacing

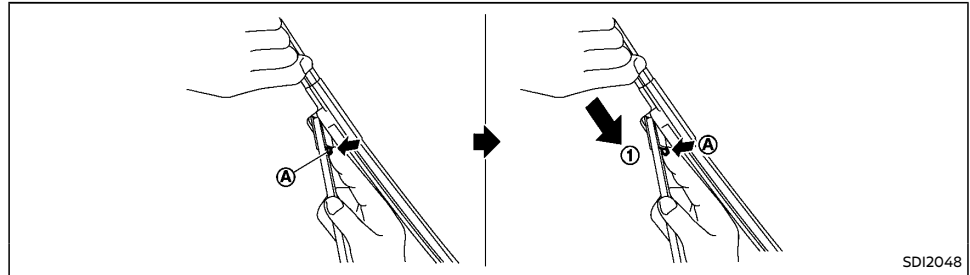

Replace the wiper blades if they are worn.

1. Pull the wiper arm.
2. Push and hold the release tab (A), and then move the wiper blade down (1) the wiper arm to remove.
3. Remove the wiper blade.
4. Insert the new wiper blade onto the wiper arm until it clicks into place.



### CAUTION:

- **After wiper blade replacement, return the wiper arm to its original position. Otherwise the wiper arm or the engine hood may be scratched and may cause damage.**
- **Worn windshield wiper blades can damage the windshield and impair driver vision.**

## WINDOW WASHER FLUID

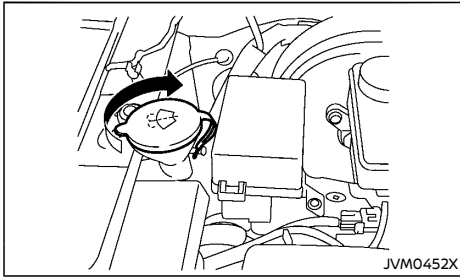

### **WARNING:**







**Anti-freeze is poisonous and should be stored carefully in marked containers out of the reach of children.**

Check the fluid level in the reservoir tank and add fluid if necessary.

If your vehicle is equipped with the low washer fluid warning (in the vehicle information display), the warning appears when the washer fluid is at a low level in the reservoir tank. Add washer fluid as necessary.

Add a washer solvent to the water for better cleaning. In the winter season, add windshield washer antifreeze. Follow the manufacturer's instructions for the mixture ratio.

## BATTERY

Caution symbols for battery			⚠ WARNING
①		No smoking, No exposed flames, No sparks	Never smoke around battery. Never expose battery to open flames or electrical sparks.
②		Shield eyes	Handle the battery cautiously. Always wear eye protection glasses to protect against explosion or battery acid.
③		Keep away from children	Never allow children to handle battery. Keep the battery out of the reach of children.
④		Battery acid	Do not allow battery fluid to contact your skin, eyes, fabrics, or painted surfaces. After handling the battery or battery cap, immediately wash your hands thoroughly. If the battery fluid gets into your eyes, or onto your skin or clothing, flush with water immediately for at least 15 minutes and seek medical attention. Battery fluid is acid. If the battery fluid gets into your eyes or onto your skin, it could cause loss of your eyesight or burns.
⑤		Note operating instructions	Before handling the battery, read this instruction carefully to ensure correct and safe handling.
⑥		Explosive gas	Hydrogen gas, generated by battery fluid, is explosive.

SDI1573

## VEHICLE BATTERY



### WARNING:

**Do not operate the vehicle if the fluid in the battery is low. Low battery fluid can cause a higher load on the battery which can generate heat, reduce battery life, and in some cases lead to an explosion.**

## Checking battery fluid level

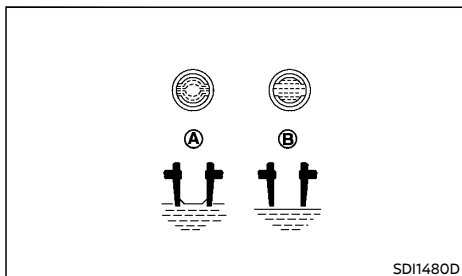
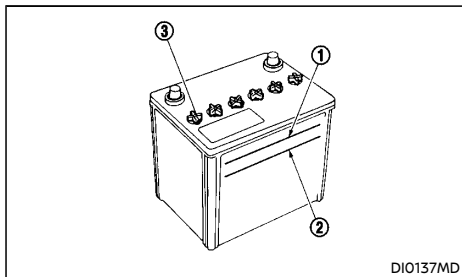

Check the fluid level in each cell. The battery fluid level should be between the UPPER LEVEL ① and LOWER LEVEL ② lines.

If it is necessary to add fluid, add only demineralized/distilled water to bring the level to the indicator in each filler opening. Do not overfill.

1. Remove the cell plugs ③ using a suitable tool.
2. Add demineralized/distilled water up to the UPPER LEVEL ① line.

If the side of the battery is not clear, check the distilled water level by looking directly

above the cell; the condition ④ indicates OK and the condition ⑤ needs more to be added.

3. Replace and tighten the cell plugs.
- Vehicles operated in high temperatures or under severe conditions require frequent checks of the battery fluid level.
  - Keep the battery surface clean and dry. Any corrosion should be cleared with a firmly wrung out moist cloth.
  - Make certain the terminal connections are clean and securely tightened.
  - If the vehicle is not to be used for more than 30 days, disconnect the negative (-) battery terminal cable to prevent battery discharge.

## Jump starting

If jump starting is necessary, see "Jump starting" (P.6-7). If the engine does not start by jump starting or the battery does not charge, the battery may have to be replaced. Contact a NISSAN dealer for replacing the battery.

REMOTE CONTROLLER BATTERY (if equipped)

## Battery replacement

### CAUTION:

- **Be careful not to allow children to swallow the battery and removed parts.**
- **An improperly disposed battery can harm the environment. Always confirm local regulations for battery disposal.**
- **When changing batteries, do not let dust or oil get on the components.**

- **There is danger of explosion if lithium battery is incorrectly replaced. Replace only with the same or equivalent type.**
- **Do not expose the battery to excessive heat such as sunshine, fire, etc.**

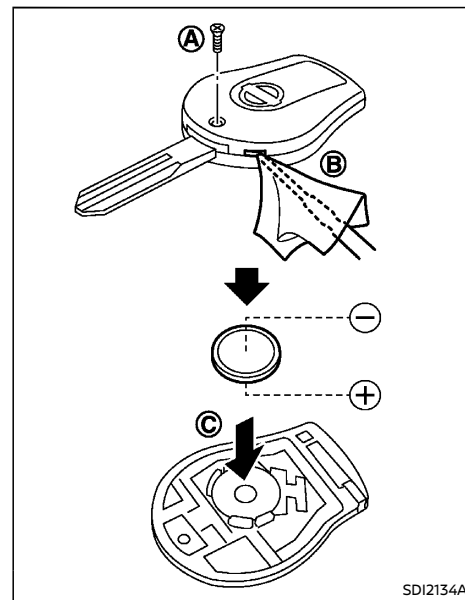

To replace the battery:

1. Use an appropriate tool to remove the screw ④ and open the lid ⑤.
2. Replace the battery with a new one.  
Recommended battery: CR1620 or equivalent

- Do not touch the internal circuit and electric terminals as doing so could cause a malfunction.
- Make sure that the + side faces the bottom of the case ☺.

3. Close the lid and install the screw securely.
4. Operate the buttons to check its operation. See a NISSAN dealer if you need assistance for replacement.

**FCC Notice:**

This device complies with Part 15 of the FCC Rules. Operation is subject to the following two conditions: (1) this device may not cause harmful interference, and (2) this device must accept any interference received, including interference that may cause undesired operation.

**Note:** Changes or modifications not expressly approved by the party responsible for compliance could void the user's authority to operate the equipment.

INTELLIGENT KEY BATTERY (if equipped)

Battery replacement



**CAUTION:**

- Be careful not to allow children to swallow the battery and removed parts.
- An improperly disposed battery can harm the environment. Always confirm local regulations for battery disposal.
- When changing batteries, do not let dust or oil get on the components.
- There is danger of explosion if lithium battery is incorrectly replaced. Replace only with the same or equivalent type.

- **Do not expose the battery to excessive heat such as sunshine, fire, etc.**

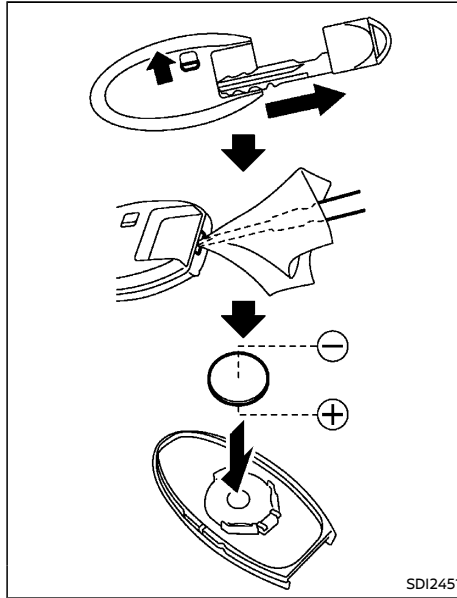

SDI2451

To replace the battery:

1. Release the lock knob at the back of the Intelligent Key and remove the mechanical key.
2. Insert a small screwdriver into the slit of the corner and twist it to separate the upper part from the lower part. Use a cloth to protect the casing.

3. Replace the battery with a new one.
  - Recommended battery: CR2025 or equivalent
  - Do not touch the internal circuit and electric terminals as doing so could cause a malfunction.
  - Make sure that the ⊕ side faces the bottom of the case.

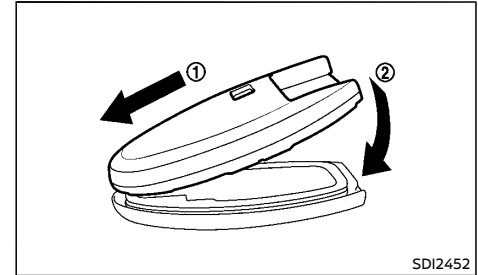

SDI2452

4. Align the tips of the upper and lower parts ①, and then push them together until it is securely closed ②.
5. Operate the buttons to check its operation. See a NISSAN dealer if you need assistance for replacement.

**FCC Notice:**

This device complies with Part 15 of the FCC Rules. Operation is subject to the following two conditions: (1) this device may not cause harmful interference, and (2) this device must accept any interference received, including interference that may cause undesired operation.

**Note:** Changes or modifications not expressly approved by the party responsible for compliance could void the user's authority to operate the equipment.

## VARIABLE VOLTAGE CONTROL SYSTEM (if equipped)

The variable voltage control system measures the amount of electrical discharge from the battery and controls voltage generated by the alternator.



### CAUTION:

- Do not ground accessories directly to the battery terminal. Doing so will bypass the variable voltage control system and the vehicle battery may not charge completely.
- Use electrical accessories with the engine running to avoid discharging the vehicle battery.

## FUSES

### ENGINE COMPARTMENT

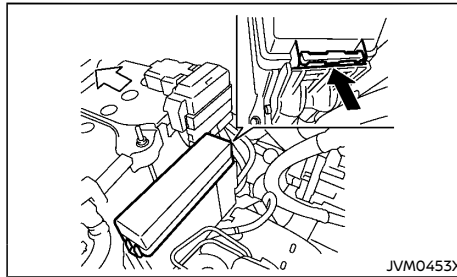

### CAUTION:

Never use a fuse of a higher or lower amperage rating than that specified on the fuse box cover. This could damage the electrical system or cause a fire.

The location and the amperage rating of fuses are shown on the backside of the fuse box lid.

The number of fuses may vary depending on the features equipped to the vehicle.

If any electrical equipment does not operate, check for an open fuse.

1. Be sure the ignition switch is in the "OFF" or "LOCK" position.
2. Be sure the headlight switch is in the "OFF" position.
3. Open the engine hood.
4. Remove the fuse/fusible link cover by pushing the tab.
5. Locate the fuse which needs to be replaced.

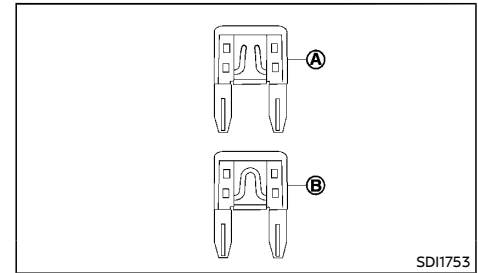

6. Remove the fuse using the fuse puller located in the passenger compartment fuse box.
7. If the fuse is open **A**, replace it with a new fuse **B**.

If the new fuse also opens, after installing, have the electrical system checked, and if necessary repaired, by a NISSAN dealer.

### Fusible links

If any electrical equipment does not operate and the fuses are in good condition, check the fusible links. If any of these fusible links are melted, replace only with genuine NISSAN parts.

## PASSENGER COMPARTMENT

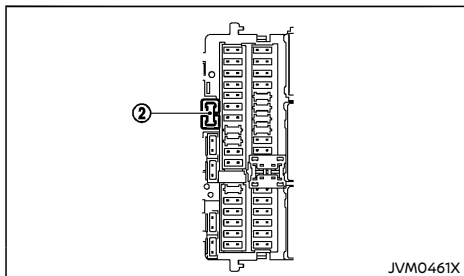
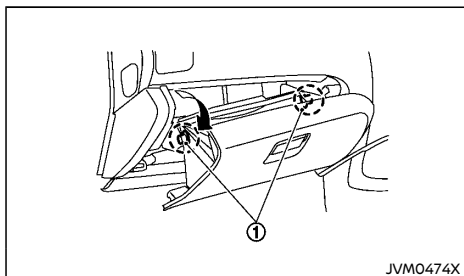
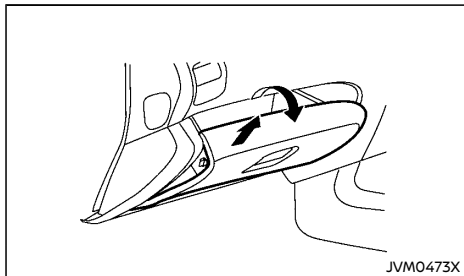

1. Be sure the ignition switch is in the "OFF" position.
2. Be sure the headlight switch is in the "OFF" position.
3. Open the glove box.
4. Hold the glove box lid and pull it up to release the hinges located on the underside of the glove box.
5. Carefully release the left and right stoppers ① and remove the glove box.
6. Locate the fuse that needs to be replaced.
7. Remove the fuse using the fuse puller ②.

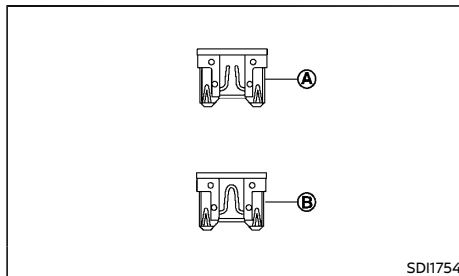

8. If the fuse is open (A), replace it with a new fuse (B).
9. Install the glove box following removal steps in opposite sequence.

If the new fuse also opens, after installing, have the electrical system checked, and if necessary repaired, by a NISSAN dealer.

## Extended storage fuse switch (if equipped)

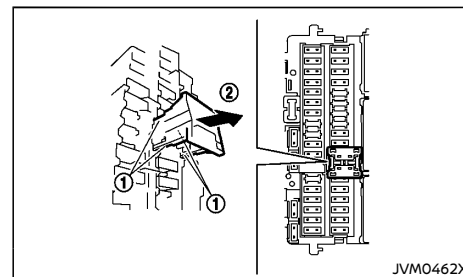

To reduce battery drain, the extended storage fuse switch comes from the factory switched off. Prior to delivery of your vehicle, the switch is pushed in (switched on) and should always remain on.

If the extended storage fuse switch is not pushed in (switched on), the "Shipping Mode On Push Storage Fuse" warning may appear in the vehicle information display (models with color display). See "Indicators for operation" (P.2-21).

If any electrical equipment does not operate, remove the extended storage fuse switch and check for an open fuse.

### NOTE:

**If the extended storage fuse switch malfunctions or if the fuse is open, it is not necessary to replace the switch. In this case, remove the extended storage fuse switch and replace it with a new fuse of the same rating.**

## LIGHTS

### How to remove the extended storage fuse switch:

1. To remove the extended storage fuse switch, be sure the ignition switch is in the "OFF" or "LOCK" position.
2. Be sure the headlight switch is in the "OFF" position.
3. Remove the fuse box cover.
4. Pinch the locking tabs ① found on each side of the storage fuse switch.
5. Pull the extended storage fuse switch straight out from the fuse box ②.

### HEADLIGHTS

Fog may temporarily form inside the lens of the exterior lights in the rain or in a car wash. A temperature difference between the inside and the outside of the lens causes the fog. This is not a malfunction. If large drops of water collect inside the lens, contact a NISSAN dealer.

### Replacing LED headlight

If replacement is required, contact a NISSAN dealer.

### Replacing halogen headlight bulb

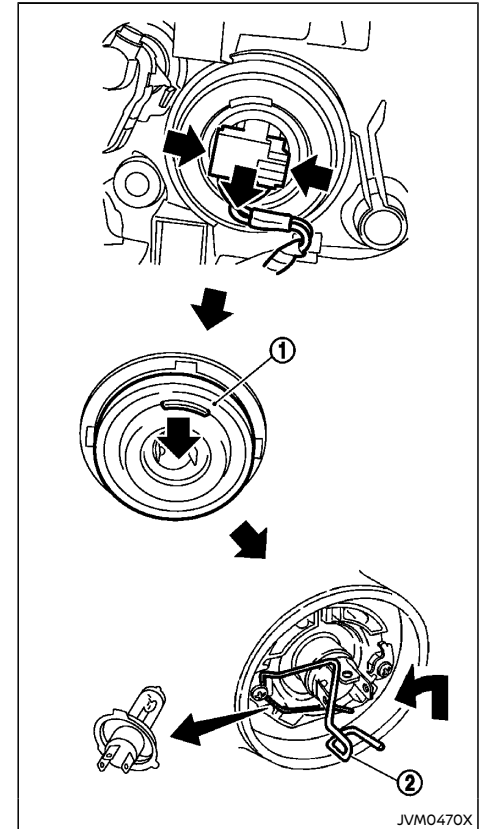

The halogen headlight is a semi-sealed beam type which uses replaceable headlight (halo-



gen) bulbs. They can be replaced from inside the engine compartment without removing the headlight assembly.

 **CAUTION:**

**High-pressure halogen gas is sealed inside the bulb. The bulb may break if the glass envelope is scratched or the bulb is dropped.**

1. Disconnect the battery negative cable.
2. Disconnect the electrical connector from the rear end of the bulb.
3. Pull off the rubber cap ①.
4. Push and turn the retaining pin ② to loosen it.
5. Remove the headlight bulb. Do not shake or rotate the bulb when removing it.
6. Install the new bulb in the reverse order of removal.

 **CAUTION:**

- **When handling the bulb, do not touch the glass envelope.**
- **Use the same number and wattage as originally installed:**

**Halogen headlight model**  
**High/low beam bulb: 60W/55W (H4)**

- **Do not leave the bulb out of the headlight reflector for a long period of time as dust, moisture and smoke may enter the headlight body and affect the performance of the headlight.**

Aiming adjustment is not necessary if only the bulbs are replaced. When aiming adjustment is necessary, contact a NISSAN dealer.

## EXTERIOR LIGHTS

Item	Wattage (W)
Front turn signal	21
Clearance light (Halogen headlight models)	5
Clearance light and daytime running light (LED headlight models)*	LED
Front fog light (if equipped)	55
Daytime running light (if equipped for halogen headlight models)	19
Side turn signal light* (on the outside rearview mirror) (if equipped)	LED
Side turn signal light (on the front fender) (if equipped)	5
Rear combination light	
Turn signal	21
Stop/tail	21/5
Reverse	21
Rear fog light (if equipped)	21
License plate light	5
High-mounted stop light (if equipped)*	LED
Cargo light (if equipped)*	LED

\*: See a NISSAN dealer for replacement.

## INTERIOR LIGHTS

Item	Wattage (W)
Map light (LED type)*	LED
Map light (bulb type)	5
Room light (if equipped)	10
Rear personal light (if equipped)	LED
Step light (if equipped)	3.4
Vanity mirror light (if equipped)	1.8

\*: See a NISSAN dealer for replacement.

## LIGHT LOCATIONS

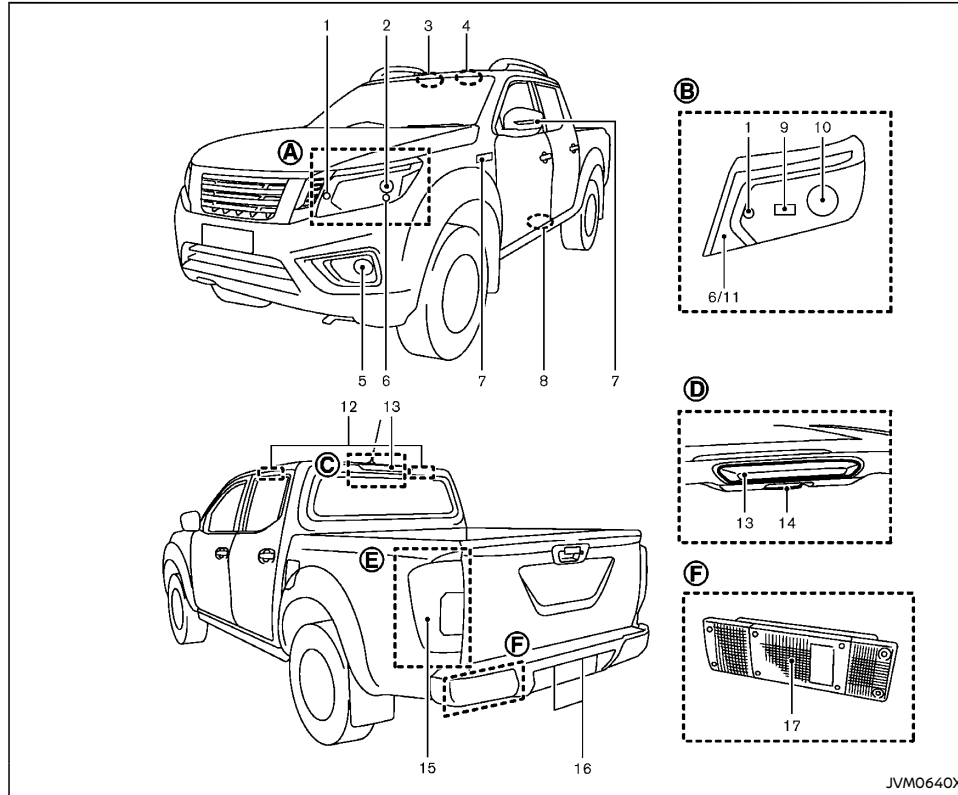

1. Front turn signal light
2. Headlight (halogen type)
3. Map light
4. Room light (if equipped)
5. Front fog light (if equipped) or Daytime running light (if equipped for halogen headlight model)
6. Clearance light
7. Side turn signal light (if equipped)
8. Step light (if equipped)
9. Headlight (high beam) (LED type)
10. Headlight (low beam) (LED type)
11. Daytime running light (LED type)
12. Rear personal light (if equipped)
13. High-mounted stop light (if equipped)
14. Cargo light (if equipped)
15. Rear combination light (turn signal/stop/tail/reverse or rear fog light (if equipped))
16. License plate light
17. Rear combination light (turn signal/stop/tail/reverse)

Ⓐ: Halogen headlight model

Ⓑ: LED headlight model

Ⓒ: Except for Sportech models (for Thailand) and SPORT EDITION models (for Philippines)

Ⓓ: For Sportech models (for Thailand) and SPORT EDITION models (for Philippines)

Ⓔ: Models with truck box

Ⓕ: Models without truck box

JVM0640X

## Replacement procedures

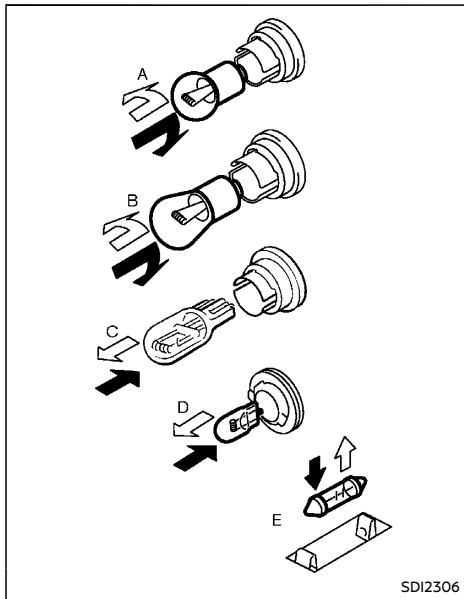

- REMOVE  
 INSTALL

All other lights are either type A, B, C, D or E. When replacing a bulb, first remove the lens and/or cover.

## Removal of the front grille before replacing bulbs:

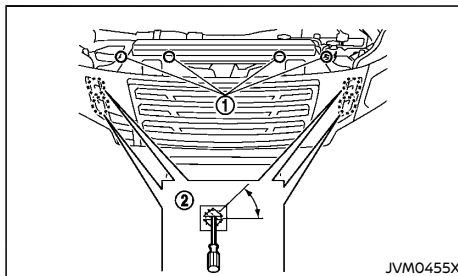

Remove the front grille if necessary to replace bulbs.

1. Remove the clips ①.
2. Unlock the turn fasteners ② by rotating 45 degrees with a flat-blade screwdriver.
3. Remove the front grille.

## Installation of the grille after replacing bulbs:

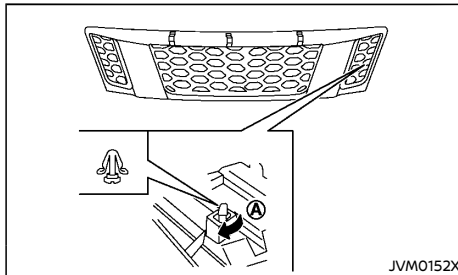

1. Remove the turn fasteners ① from the vehicle.

2. Install the turn fasteners on the front grille.
3. Lock the turn fasteners by rotating 45 degrees.
4. Push the grille into the vehicle to install it.

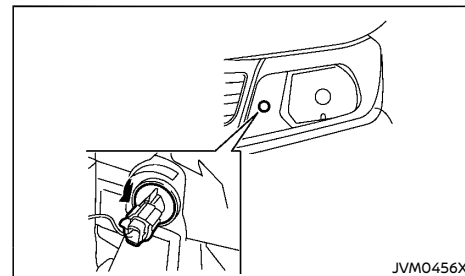

Front turn signal light

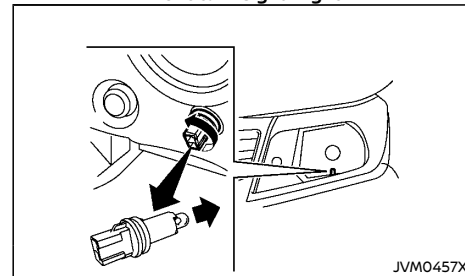

Clearance light (bulb type)

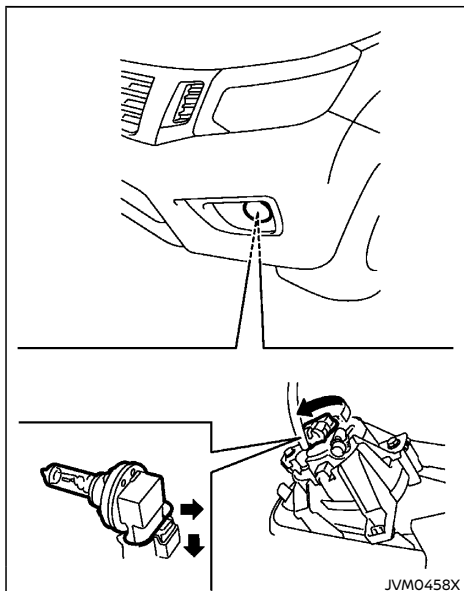

JVM0458X

Front fog light (if equipped) or daytime running light (if equipped)

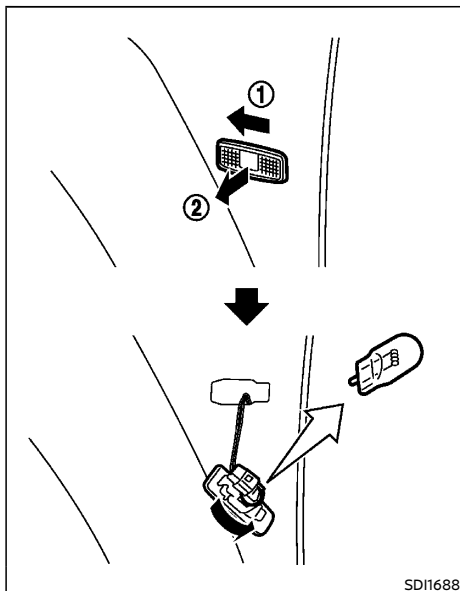

SDI1688

Side turn signal light (on the front fender) (if equipped)

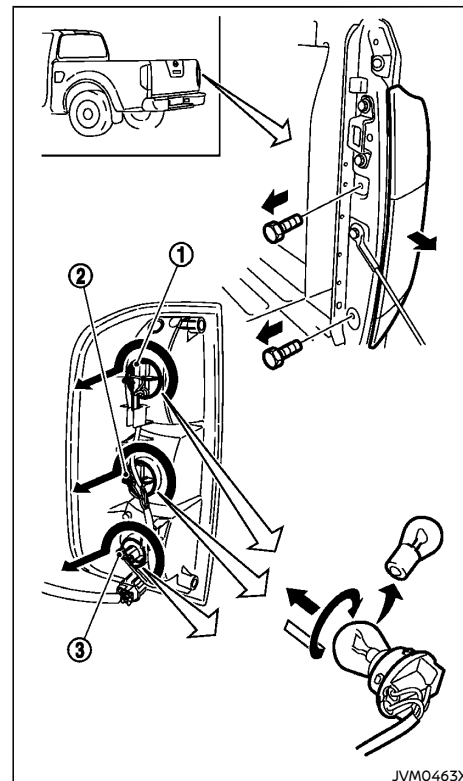

JVM0463X

Rear combination light (turn signal, stop and reverse or rear fog (if equipped)) (models with truck box)

- ①: Stop/tail light
- ②: Turn signal light

- ③: Reverse light or Rear fog light (if equipped)

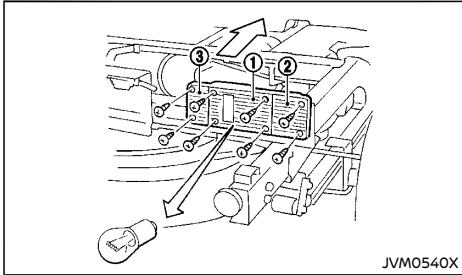

**Rear combination light (turn signal, stop and reverse) (models without truck box)**

- ①: Stop/tail light
- ②: Turn signal light
- ③: Reverse light

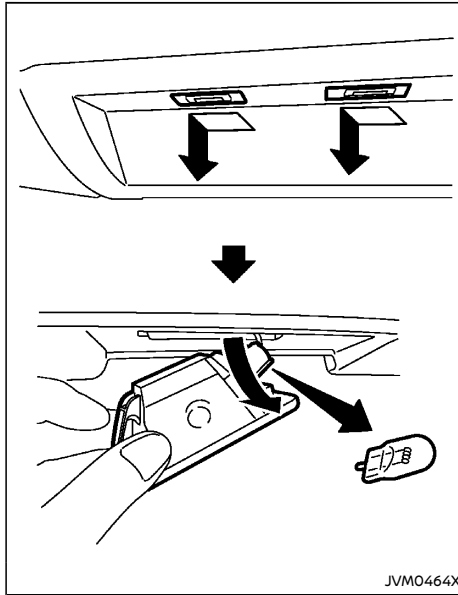

**License plate light**

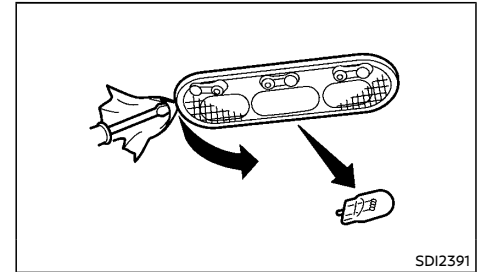

**Front map light (bulb type)**

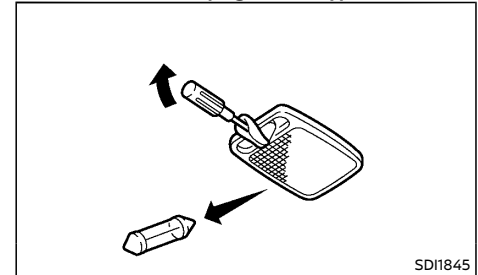

**Room light (if equipped)**

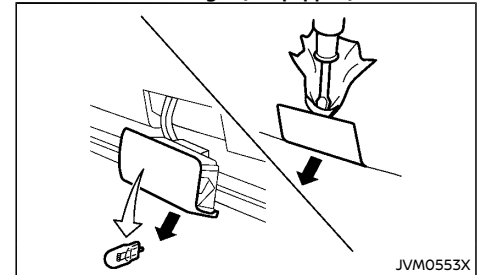

**Step light (if equipped)**

## TIRES AND WHEELS

If you have a flat tire, see "Flat tire" (P.6-2).

### TIRE INFLATION PRESSURE

Periodically check the pressure of the tires, including the spare. An incorrect tire pressure may adversely affect tire life and vehicle handling. The tire pressure should be checked when tires are COLD. Tires are considered COLD after the vehicle has been parked for 3 or more hours, or driven less than 1.6 km (1 mile). COLD tire pressures are shown on the tire placard.

Insufficient pressure can lead to an overheating of the tire and subsequent internal damage. At high speeds, this could result in tread separation and even bursting of the tire.

### TYPES OF TIRES



#### CAUTION:

**When changing or replacing tires, be sure all four tires are of the same type (that is, summer, all season or snow) and construction. A NISSAN dealer may be able to help you with information about tire type, size, speed rating and availability.**

Replacement tires may have a lower speed rating than the factory equipped tires, and they may not match the potential maximum vehicle speed. Never exceed the maximum speed rating of the tire.

#### All season tires

NISSAN specifies all season tires on some models to provide good performance all year, including snowy and icy road conditions. All season tires are identified by ALL SEASON and/or M&S on the tire sidewall. Snow tires have better snow traction than all season tires and may be more appropriate in some areas.

#### Summer tires

NISSAN specifies summer tires on some models to provide superior performance on dry roads. Summer tire performance is substantially reduced in snow and ice. Summer tires do not have the tire traction rating M&S on the tire sidewall.

If you plan to operate your vehicle in snowy or icy conditions, NISSAN recommends the use of snow or all season tires on all four wheels.

#### Snow tires

If snow tires are needed, it is necessary to select tires equivalent in size and load rating to the original equipment tires. If you do not, it can adversely affect the safety and handling of your vehicle.

Generally, snow tires have lower speed ratings than factory equipped tires and may not match the potential maximum vehicle speed. Never exceed the maximum speed rating of the tire. If you install snow tires, they must be the same size, brand, construction and tread pattern on all four wheels.

For additional traction on icy roads, studded tires may be used. However, some states and provinces prohibit their use. Check local, state and provincial laws before installing studded tires. Skid and traction capabilities of studded snow tires on wet or dry surfaces may be poorer than that of non-studded snow tires.

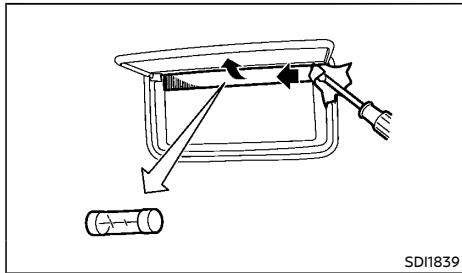

Vanity mirror light (if equipped)

## Four-Wheel Drive (4WD) model



### CAUTION:

- **Always use tires of the same type, size, brand, construction (bias, bias-belted or radial), and tread pattern on all four wheels. Failure to do so may result in a circumference difference between tires on the front and rear axles which will cause excessive tire wear and may damage the transmission, transfer case and differential gears.**
- **ONLY use spare tires specified for the 4WD model.**

If excessive tire wear is found, it is recommended that all four tires be replaced with tires of the same size, brand, construction and tread pattern. The tire pressure and wheel alignment should also be checked and corrected as necessary. Contact a NISSAN dealer.

## TIRE CHAINS

Use of tire chains may be prohibited according to location. Check the local laws before installing tire chains. When installing tire chains, make sure that they are of proper size for the tires on your vehicle and are installed according to the chain manufacturer's instructions.

Use chain tensioners when recommended by the tire chain manufacturer to ensure a tight fit. Loose end links of the tire chains must be secured or removed to prevent the possibility of whipping action damage to the fenders or underbody. If possible, avoid fully loading your vehicle when using tire chains. In addition, drive at a reduced speed. Otherwise, your vehicle may be damaged and/or vehicle handling and performance may be adversely affected.

**Tire chains must be installed only on the rear**

## wheels and not on the front wheels.

Never install tire chains on a temporary-use spare tire (if equipped).

Do not drive with tire chains on paved roads which are clear of snow. Driving with chains in such conditions can cause damage to the various mechanisms of the vehicle due to some overstress.

## TIRE ROTATION

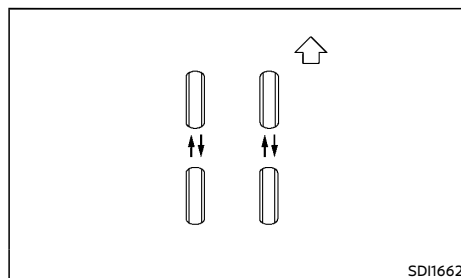

NISSAN recommends that tires be rotated every 5,000 km (3,000 miles) for Four-Wheel Drive (4WD) or every 10,000 km (6,000 miles) for Two-Wheel Drive (2WD) model. However, the timing for tire rotation may vary according to your driving habits and the road surface conditions. (See "Flat tire" (P.6-2) for the tire replacement.)



### WARNING:

- **After rotating the tires, adjust the tire pressure.**
- **Retighten the wheel nuts when the vehicle has been driven for 1,000 km (600 miles) (also in cases of a flat tire, etc.).**

- **Do not include the spare tire in tire rotation.**
- **Incorrect tire selection, fitting, care or maintenance can affect vehicle safety with risk of accident and injury. If in doubt, consult a NISSAN dealer or the tire manufacturer.**

## TIRE WEAR AND DAMAGE

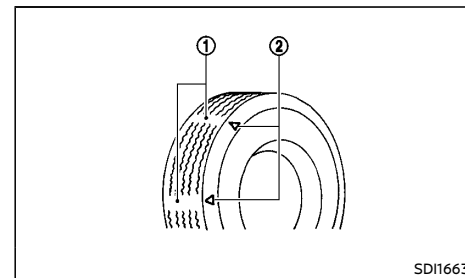

- ① : Wear indicator
- ② : Wear indicator location marks. The locations are shown by "△", "TWI", etc. depending on tire types.

Tires should be periodically inspected for wear, cracking, bulging or objects caught in the tread. If excessive wear, cracks, bulging or deep cuts are found, the tire should be replaced immediately.

The original tires have a built-in tread wear indicator. When the wear indicator is visible, the tire should be replaced.

Improper service of a spare tire may result in serious personal injury. If it is necessary to repair the spare tire, contact a NISSAN dealer.

## TIRE AGE

Never use a tire over six years old, regardless of whether it has been used or not.

Tires degrade with age as well as with the vehicle usage. Have your tires checked and balanced often by a repair shop or, if you prefer, a NISSAN dealer.

## CHANGING TIRES AND WHEELS



### WARNING:

**Do not install a deformed wheel or tire even if it has been repaired. Such wheels or tires could have structural damage and could fail without warning.**

When replacing a tire, use the same size, speed rating and load carrying capacity as originally equipped. (See "Tires and wheels" (P.9-7) for recommended types and sizes of tires and wheels.) The use of tires other than those recommended or the mixed use of tires of different brands, construction (bias, bias-belted, or radial), or tread patterns can adversely affect the ride, braking, handling, ground clearance, body-to-tire clearance, snow chain clearance, speedometer calibration, headlight aim and bumper height. Some of these effects may lead to accidents and could result in serious personal injury.

If the wheels are changed for any reason, always replace with wheels which have the same offset dimension. Wheels of a different offset could cause early tire wear, possibly degraded vehicle handling characteristics and/or interference with the brake discs/drums. Such interference can lead to decreased braking efficiency and/or early brake pad/shoe wear.

## WHEEL BALANCE

Unbalanced wheels may affect vehicle handling and tire life. Even with regular use, wheels can get out of balance. Therefore, they should be balanced as required.

## SPARE TIRE

The spare tire supplied with your vehicle varies depending on the model. See "Tires and wheels" (P.9-7) for applicable spare tire.

### Temporary-use spare tire (if equipped)

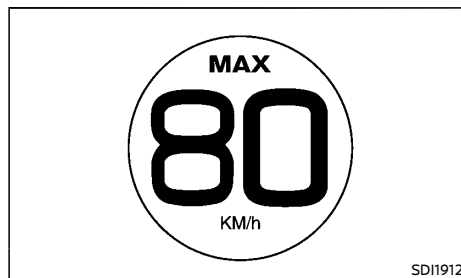

Spare tire label

A temporary-use spare tire (different size from the original tire) is supplied with your vehicle.

Observe the following precautions if the spare tire must be used, otherwise your vehicle could be damaged or involved in an accident.



### CAUTION:

- **The spare tire should be used only for emergency. It should be replaced by the standard tire at the first opportunity.**
- **Drive carefully while the spare tire is installed.**

- **Avoid sharp turns and abrupt braking while driving.**
- **Periodically check the spare tire inflation pressure. See the tire placard on your vehicle for the recommended tire inflation pressure.**
- **Do not drive your vehicle at speeds faster than 80 km/h (50 MPH).**
- **Do not use tire chains on a spare tire. Tire chains will not fit properly on the spare tire and may cause damage to the vehicle.**
- **When driving on roads covered with snow or ice, the spare tire should be used on the front wheel and the original tire used on the rear wheels (drive wheels). Use tire chains only on the rear two original tires.**
- **Because the spare tire is smaller than the original tire, ground clearance is reduced. To avoid damage to the vehicle do not drive over obstacles. Also do not drive the vehicle through an automatic car wash since it may get caught.**
- **Do not use the spare tire on other vehicles.**
- **Do not use more than one spare tire at the same time.**

### Conventional spare tire (if equipped)

A standard tire (the same size as the road wheels) is supplied with your vehicle.



# 9 Technical information

Recommended fluids/lubricants and capacities .....	9-2	Engine serial number .....	9-15
Fuel information .....	9-4	Tire placard .....	9-15
Recommended SAE viscosity number (except for YS23DDT/DDTT engine model) .....	9-4	Air conditioner specification label .....	9-15
Air conditioner system refrigerant and lubricant .....	9-5	Installation of an RF-transmitter .....	9-16
Engine .....	9-6	Radio approval number and information .....	9-16
Tires and wheels .....	9-7	For Thailand .....	9-16
Dimensions .....	9-8	For Indonesia .....	9-16
When travelling or registering in another country .....	9-14	For Vietnam .....	9-17
Vehicle identification .....	9-14	For Western Samoa .....	9-17
Vehicle identification label .....	9-14	For Pakistan .....	9-17
Vehicle Identification Number (VIN) label (if equipped) .....	9-14	For Surinam .....	9-17
Vehicle Identification Number (VIN) .....	9-14	For Jamaica .....	9-18
		For Tahiti, Montserrat and New Caledonia .....	9-18
		For South Africa .....	9-21

## RECOMMENDED FLUIDS/ LUBRICANTS AND CAPACITIES

The following are approximate capacities. The actual refill quantities may be slightly different. When refilling, follow the procedures instructed in the "8. Maintenance and do-it-yourself" section to determine the proper refill capacity.

Fluid type			Capacity (approximate)			Recommended Fluids/Lubricants
			Metric Measure	US Measure	Imperial Measure	
Fuel			80 L	21-1/8 gal	17-5/8 gal	· See "Fuel information" (P.9-4).
Engine oil <sup>1</sup> Drain and refill <sup>1</sup> : For additional information, see "Changing engine oil and oil filter" (P.8-10).	QR25DE	With oil filter change	4.7 L	5 qt	4-1/8 qt	· Genuine "NISSAN Motor Oil OW-20 SN" is recommended. · If the above motor oil is not available, use "NISSAN Motor Oil" or equivalent that matches the following grade and viscosity. · Oil grade: API SM or SN, ILSAC GF-4 or GF-5 · SAE Viscosity: See "Recommended SAE viscosity number (except for YS23DDT/DDTT engine model)" (P.9-4).
		Without oil filter change	4.4 L	4-7/8 qt	3-7/8 qt	
	YD25DDTi	With oil filter change	5.3 L	5-5/8 qt	4-5/8 qt	· Genuine "NISSAN Motor Oil 5W-30 CF-4 or B1" is recommended. · If the above motor oil is not available, use "NISSAN Motor Oil" or equivalent that matches the following grade and viscosity. · Oil grade: – API CF-4 <sup>2</sup> – ACEA B1, B3, B4 or B5 <sup>2</sup> : Never use API CG-4. · SAE Viscosity: See "Recommended SAE viscosity number (except for YS23DDT/DDTT engine model)" (P.9-4).
		Without oil filter change	4.8 L	5-1/8 qt	4-1/4 qt	
	YS23DDT	With oil filter change	6.7 L	7-1/8 qt	5-7/8 qt	· Genuine "NISSAN Motor Oil 5W-30 C3 or C4" is recommended. · If the above motor oil is not available, use "NISSAN Motor Oil" or equivalent that matches the following grade and viscosity. · Oil grade: ACEA C3 or C4 · SAE Viscosity: 5W-30
		Without oil filter change	6.4 L	6-3/4 qt	5-5/8 qt	
YS23DDTT	With oil filter change	6.3 L	6-5/8 qt	5-1/2 qt		
	Without oil filter change	6.0 L	6-3/8 qt	5-1/4 qt		
Engine coolant with reservoir	QR25DE	With heater	8.1 L	8-5/8 qt	7-1/8 qt	· Genuine NISSAN Engine Coolant (blue) or equivalent · Use Genuine NISSAN Engine Coolant or equivalent in its quality, in order to avoid possible aluminum corrosion within the engine cooling system caused by the use of non-genuine engine coolant. Note that any repairs for the incidents within the engine cooling system while using non-genuine engine coolant may not be covered by the warranty even if such incidents occurred during the warranty period.
		Without heater	7.3 L	7-3/4 qt	6-3/8 qt	
	YD25DDTi	With heater	10.6 L	11-1/4 qt	9-3/8 qt	
		Without heater	9.8 L	10-3/8 qt	8-5/8 qt	
	YS23DDT/DDTT		11.1 L	11-3/4 qt	9-3/4 qt	
Automatic Transmission Fluid (ATF)			-	-	-	· Genuine NISSAN Matic S ATF · NISSAN recommends using Genuine NISSAN Matic S ATF ONLY in NISSAN automatic transmissions. Do not mix with other fluids. Using fluids that are not equivalent to Genuine NISSAN Matic S ATF may damage the automatic transmission. Damage caused by the use of fluids other than as recommended is not covered under the warranty.
Manual transmission (MT) gear oil	2WD		3.0 L	3-1/8 qt	2-5/8 qt	· Genuine NISSAN Manual Transmission Fluid (MTF) HQ Multi 75W-85 · If Genuine NISSAN Manual Transmission Fluid (MTF) HQ Multi is not available, API GL-4, Viscosity SAE 75W-85 may be used as a temporary replacement. However, use Genuine NISSAN Manual Transmission Fluid (MTF) HQ Multi as soon as it is available.
	4WD		3.4 L	3-5/8 qt	3 qt	

Fluid type		Capacity (approximate)			Recommended Fluids/Lubricants
		Metric Measure	US Measure	Imperial Measure	
Transfer fluid		1.5 L	1-5/8 qt	1-3/8 qt	<ul style="list-style-type: none"> <li>· Genuine NISSAN ATF D3M</li> <li>· Using fluid other than Genuine NISSAN ATF D3M may cause deterioration in driveability and transfer durability, and may damage the transfer, which is not covered by the warranty.</li> </ul>
Power steering fluid		Refill to the proper fluid level according to the instructions in the "8. Maintenance and do-it-yourself" section.			<ul style="list-style-type: none"> <li>· Genuine NISSAN PSF or equivalent</li> <li>· DEXRON™ VI type ATF may also be used.</li> </ul>
Brake and clutch fluid					<ul style="list-style-type: none"> <li>· Genuine NISSAN Brake Fluid or equivalent DOT3 or DOT4</li> <li>· Never mix different types of fluids (DOT3 and DOT4).</li> </ul>
Differential gear oil	Front	0.85 L	7/8 qt	3/4 qt	<ul style="list-style-type: none"> <li>· Genuine NISSAN Differential Oil Hypoid Super GL-5 80W-90 (mineral oil)</li> <li>· NISSAN recommends using Genuine NISSAN Differential Oil Hypoid Super GL-5 80W-90 ONLY in NISSAN final drive. Do not mix with other fluids. Using fluids that are not equivalent to Genuine NISSAN Differential Oil Hypoid Super GL-5 80W-90 may damage the final drive. Damage caused by the use of fluids other than as recommended is not covered under the warranty.</li> </ul>
	Rear	2.85 L	3 qt	2-1/2 qt	<ul style="list-style-type: none"> <li>· Genuine NISSAN Differential Oil Hypoid Super-S GL-5 synthetic 75W-90</li> <li>· NISSAN recommends using Genuine NISSAN Differential Oil Hypoid Super-S GL-5 synthetic 75W-90 ONLY in NISSAN final drive. Do not mix with other fluids. Using fluids that are not equivalent to Genuine NISSAN Differential Oil Hypoid Super-S GL-5 synthetic 75W-90 may damage the final drive. Damage caused by the use of fluids other than as recommended is not covered under the warranty.</li> </ul>
Multi-purpose grease		-	-	-	<ul style="list-style-type: none"> <li>· NLGI No. 2 (Lithium soap base)</li> </ul>
Air conditioner system refrigerant		-	-	-	<ul style="list-style-type: none"> <li>· HFC-134a (R-134a)</li> </ul>
Air conditioner system lubricants		-	-	-	<ul style="list-style-type: none"> <li>· NISSAN A/C System Oil Type S or equivalent</li> </ul>

## FUEL INFORMATION

Gasoline engine (model with three-way catalyst)



### CAUTION:

**Do not use leaded gasoline. Using leaded gasoline will damage the three-way catalyst.**

Use UNLEADED REGULAR gasoline with an octane rating of at least 91 (RON).

For Thailand: Use UNLEADED REGULAR gasoline or gasohol (up to E10\*) with an octane rating of at least 91 (RON).

\*: Gasohol is alcohol blended gasoline. For example, "E10" is a mixture of approximately 10% fuel ethanol and 90% unleaded gasoline.

### Diesel engine\*

#### YD25DDTi engine:

Diesel fuel above 50 cetane must be used.

#### YS23DDT/DDTT engine:

Diesel fuel above 50 cetane and with a maximum of 10 ppm of sulfur (EN590) must be used. (except for South Africa)

Diesel fuel above 50 cetane and with a maximum of 50 ppm of sulfur (EN590) must be used. (for South Africa)

\* If two types of diesel fuel are available, use summer or winter fuel properly according to the following temperature conditions.

- Above  $-7^{\circ}\text{C}$  ( $20^{\circ}\text{F}$ ) ... Summer type diesel fuel.
- Below  $-7^{\circ}\text{C}$  ( $20^{\circ}\text{F}$ ) ... Winter type diesel fuel.



### CAUTION:

- **Do not use home heating oil, gasoline or other alternate fuels in your diesel engine. The use of those or adding those to diesel fuel can cause engine damage.**
- **Do not use summer fuel at temperatures below  $-7^{\circ}\text{C}$  ( $20^{\circ}\text{F}$ ). The cold temperatures will cause wax to form in the fuel. As a result, it may prevent the engine from running smoothly.**

RECOMMENDED SAE VISCOSITY NUMBER (except for YS23DDT/DDTT engine model)

Gasoline engine oil

**0W-20 is preferable. If 0W-20 is not available, select the viscosity, from the chart below, that is suitable for the outside temperature range.**

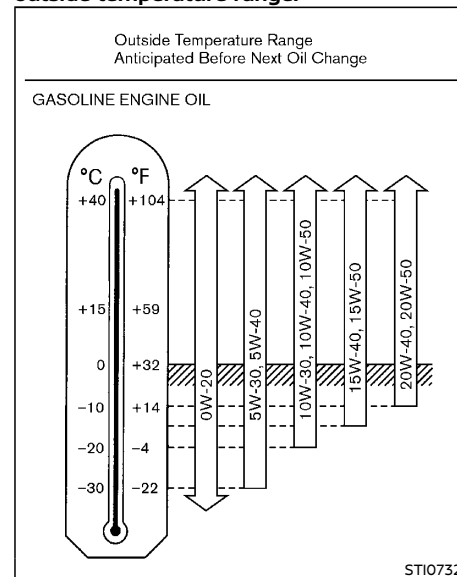

## Diesel engine oil

For YD25DDTi engine model

**5W-30 is preferable.**

**If 5W-30 is not available, select the viscosity, from the chart below, that is suitable for the outside temperature range.**

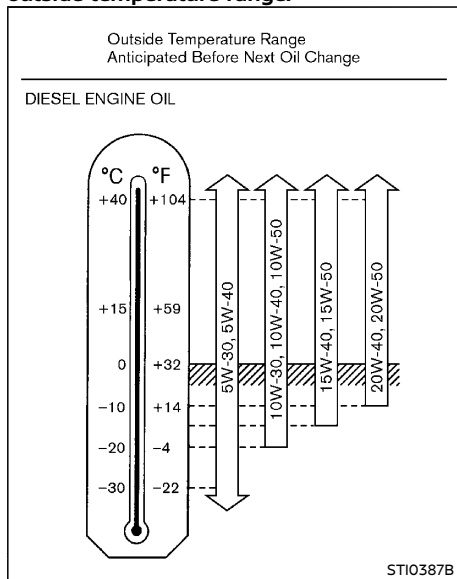

## AIR CONDITIONER SYSTEM REFRIGERANT AND LUBRICANT

The air conditioner system of your vehicle must be charged with the refrigerant HFC-134a (R134a) and the lubricant NISSAN A/C System Oil Type S or equivalents.



### CAUTION:

**Use of any other refrigerants or lubricants will cause severe damage, and you may need to replace your vehicle's entire air conditioner system.**

The release of refrigerants into the atmosphere is prohibited in many countries and regions. The refrigerant HFC-134a (R-134a) in your vehicle will not harm the Earth's ozone layer. However, it may contribute in a small part to the global warming effect. NISSAN recommends that the refrigerant be appropriately recovered and recycled. Contact a NISSAN dealer when servicing the air conditioner system.

## ENGINE

Engine Model		QR25DE	YD25DDTi	YS23DDT/DDTT
Type		Gasoline, 4-cycle, DOHC	Diesel, 4-cycle	Diesel, 4-cycle
Cylinder arrangement		4-cylinder, in-line	4-cylinder, in-line	4-cylinder, in-line
Bore × Stroke	mm (in)	89.0 × 100.0 (3.504 × 3.937)	89 × 100 (3.504 × 3.937)	85 × 101.3 (3.346 × 3.988)
Displacement	cm <sup>3</sup> (cu in)	2,488 (151.82)	2,488 (151.82)	2,298 (140.22)
Idle speed at the "N" (Neutral) position	rpm	625±60 (MT) 700±50 (AT)	750±50*1	750±50
Ignition timing (B.T.D.C.) at the "N" (Neutral) position		10°±2	-	-
Spark plugs				
Type	Standard	FXE20HE11	-	-
Gap	mm (in)	1.0-1.1 (0.043)		
Camshaft operation		Timing chain	Timing chain	Timing chain

\*1: When driving at high altitude, idling speed will increase.

## TIRES AND WHEELS

Tire	Conventional	Size	195R15C	205R16C	255/70R16	255/60R18	
	Spare	Size	Conventional			Conventional	255/70R16*1
Road wheel	Conventional	Size	15 × 5-1/2J	16 × 6J	16 × 7J 16 × 7JJ	18 × 7J	
		Offset mm (in)	50 (1.97)	55 (2.17)	45 (1.77)	45 (1.77)	
	Spare	Size	Conventional			Conventional	16 × 7JJ*1
		Offset	Conventional			Conventional	45 (1.77)*1

\*1: Temporary use only

See the tire placard on your vehicle for the recommended COLD tire pressure.

## DIMENSIONS

mm (in)

Destination		Thailand (except for Sportech models)		
Body type		Single Cab	King Cab	Double Cab
Overall length	Models without bed and rear bumper	5,120 (201.6)	5,210 (205.1)	5,120 (201.6)
	Models with bed and without rear bumper	5,240 (206.3)	5,230 (205.9)	5,230 (205.9)
	Models with bed and rear bumper	5,330 (209.8)	5,255 (206.9)	5,255 (206.9)
Overall width	Narrow body models	1,790 (70.5)	1,790 (70.5)	1,790 (70.5)
	Wide body models	—	1,850 (72.8)	1,850 (72.8)
Overall height	Two-Wheel Drive (2WD ) models	1,725 (67.9)*1*4*5 1,715 (67.5)*2*4*5	1,720 (67.7)*2*4*5 1,745 (68.7)*2*4*6 1,755 (69.1)*2*4*7 1,755 (69.1)*2*4*8	1,750 (68.9)*2*4*5 1,775 (69.9)*2*4*6 1,785 (70.3)*2*4*7 1,820 (71.7)*2*3*8
	Four-Wheel Drive (4WD) models	1,730 (68.1)*1*4*5	1,760 (69.3)*2*4*7 1,760 (69.3)*2*4*8	1,810 (71.3)*2*4*7 1,840 (72.4)*2*3*8
Front tread		1,560 (61.4)*5	1,560 (61.4)*5 1,550 (61.0)*6 1,570 (61.8)*7	1,560 (61.4)*5 1,550 (61.0)*6 1,570 (61.8)*7*8
Rear tread		1,560 (61.4)*5	1,560 (61.4)*5 1,550 (61.0)*6 1,570 (61.8)*7	1,560 (61.4)*5 1,550 (61.0)*6 1,570 (61.8)*7*8
Wheelbase		3,150 (124.0)	3,150 (124.0)	3,150 (124.0)

\*1: Model with guard frame

\*2: Model without guard frame

\*3: Models with roof rack

\*4: Models without roof rack

\*5: 195R15C tire equipped models

\*6: 205R16C tire equipped models

\*7: 255/70R16 tire equipped models

\*8: 255/60R18 tire equipped models



Destination		Australia (except for N-SPORT models) and New Zealand		
Body type		Single Cab	King Cab	Double Cab
Overall length	Models without bed and rear bumper	5,120 (201.6)	5,210 (205.1)	5,120 (201.6)
	Models with bed and without rear bumper	5,240 (206.3)	5,230 (205.9)	5,230 (205.9)
	Models with bed and rear bumper	5,330 (209.8)	5,255 (206.9)	5,255 (206.9)
Overall width	Narrow body models	1,790 (70.5)	1,790 (70.5)	1,790 (70.5)
	Wide body models	—	1,850 (72.8)	1,850 (72.8)
Overall height	Two-Wheel Drive (2WD) models	1,720 (67.7)*2*3 1,745 (68.7)*2*4	1,750 (68.9)*2*4	1,760 (69.3)*2*3 1,785 (70.3)*2*4 1,815 (71.5)*2*5 1,845 (72.6)*1*6
	Four-Wheel Drive (4WD) models	1,735 (68.3)*2*3 1,765 (69.5)*2*4	1,770 (69.7)*2*4 1,780 (70.1)*2*5*6	1,800 (70.9)*2*4 1,825 (71.9)*2*5 1,855 (73.0)*1*6
Front tread		1,560 (61.4)*3 1,550 (61.0)*4	1,550 (61.0)*4 1,570 (61.8)*5*6	1,560 (61.4)*3 1,550 (61.0)*4 1,570 (61.8)*5*6
Rear tread		1,560 (61.4)*3 1,550 (61.0)*4	1,550 (61.0)*4 1,570 (61.8)*5*6	1,560 (61.4)*3 1,550 (61.0)*4 1,570 (61.8)*5*6
Wheelbase		3,150 (124.0)	3,150 (124.0)	3,150 (124.0)

\*1: Models with roof rack

\*2: Models without roof rack

\*3: 195R15C tire equipped models

\*4: 205R16C tire equipped models

\*5: 255/70R16 tire equipped models

\*6: 255/60R18 tire equipped models

mm (in)

Destination		Philippines (except for SPORT EDI- TION models)	Indonesia	Vietnam and Myanmar	Laos and Cambodia
Body type		Double Cab	Double Cab	Double Cab	Double Cab
Overall length	Models without bed and rear bumper	5,120 (201.6)	—	—	—
	Models without rear bumper	5,230 (205.9)	—	—	—
	Models with rear bumper	5,255 (206.9)	5,255 (206.9)	5,255 (206.9)	5,255 (206.9)
Overall width	Narrow body models	1,790 (70.5)	—	1,790 (70.5)	1,790 (70.5)
	Wide body models	1,850 (72.8)	1,850 (72.8)	1,850 (72.8)	1,850 (72.8)
Overall height	Two-Wheel Drive (2WD) models	1,760 (69.3)*2*3 1,795 (70.7)*2*5 1,825 (71.9)*1*6	—	1,780 (70.1)*2*4 1,825 (71.9)*1*6	1,785 (70.3)*2*4 1,795 (70.7)*2*5
	Four-Wheel Drive (4WD) models	1,810 (71.3)*2*5 1,840 (72.4)*1*6	1,810 (71.3)*2*5 1,840 (72.4)*1*6	1,810 (71.3)*2*6 1,840 (72.4)*1*6	1,810 (71.3)*2*6
Front tread		1,560 (61.4)*3 1,570 (61.8)*5*6	1,570 (61.8)*5*6	1,550 (61.0)*4 1,570 (61.8)*6	1,550 (61.0)*4 1,570 (61.8)*5*6
Rear tread		1,560 (61.4)*3 1,570 (61.8)*5*6	1,570 (61.8)*5*6	1,550 (61.0)*4 1,570 (61.8)*6	1,550 (61.0)*4 1,570 (61.8)*5*6
Wheelbase		3,150 (124.0)	3,150 (124.0)	3,150 (124.0)	3,150 (124.0)

\*1: Models with roof rack

\*2: Models without roof rack

\*3: 195R15C tire equipped models

\*4: 205R16C tire equipped models

\*5: 255/70R16 tire equipped models

\*6: 255/60R18 tire equipped models

Destination		Brunei	Type A*8		Type B*9	Type C*10
Body type		Double Cab	Single Cab	Double Cab	Double Cab	Double Cab
Overall length	Models without rear bumper	—	—	—	—	5,230 (205.9)
	Models with rear bumper	5,255 (206.9)	5,330 (209.8)	5,255 (206.9)	5,255 (206.9)	5,255 (206.9)
Overall width	Narrow body models	—	1,790 (70.5)	—	1,790 (70.5)	1,790 (70.5)
	Wide body models	1,850 (72.8)	—	1,850 (72.8)	1,850 (72.8)	1,850 (72.8)
Overall height	Two-Wheel Drive (2WD) models	—	1,760 (69.3)*1*4*5	1,785 (70.3)*1*4*5 1,795 (70.7)*2*4*6	1,780 (70.1)*2*4*5	—
	Four-Wheel Drive (4WD) models	1,810 (71.3)*2*4*6*7	—	1,810 (71.3)*2*4*6 1,840 (72.4)*2*3*6	1,800 (70.9)*2*4*5 1,810 (71.3)*2*4*6	1,800 (70.9)*2*4*5 1,810 (71.3)*2*4*6 1,840 (72.4)*2*3*7
Front tread		1,570 (61.8)*6*7	1,550 (61.0)*5	1,550 (61.0)*5 1,570 (61.8)*6	1,550 (61.0)*5 1,570 (61.8)*6	1,550 (61.0)*5 1,570 (61.8)*6*7
Rear tread		1,570 (61.8)*6*7	1,550 (61.0)*5	1,550 (61.0)*5 1,570 (61.8)*6	1,550 (61.0)*5 1,570 (61.8)*6	1,550 (61.0)*5 1,570 (61.8)*6*7
Wheelbase		3,150 (124.0)	3,150 (124.0)	3,150 (124.0)	3,150 (124.0)	3,150 (124.0)

\*1: Model with guard frame

\*2: Model without guard frame

\*3: Models with roof rack

\*4: Models without roof rack

\*5: 205R16C tire equipped models

\*6: 255/70R16 tire equipped models

\*7: 255/60R18 tire equipped models

\*8: For Bahamas, Grand Cayman, Trinidad Tobago, Antigua, Grenada, Surinam, Barbados, Bermuda, Commonwealth of Dominica, Guyana, Jamaica, Montserrat, St. Kitts, St. Lucia and St. Vincent

\*9: For New Caledonia, Tahiti, Mongol and Vanuatu

\*10: For Nepal, Fiji, Bangladesh, Sri Lanka, Bhutan, Cook Island, Kiribati, Nauru, Norfolk Island, Solomon, Tuvalu, Pakistan and Western Samoa

mm (in)

Destination		Malaysia		South Africa and Sub Saharan Africa
Body type		Single Cab	Double Cab	Double Cab
Overall length	Models with bed and rear bumper	5,235 (206.0)	5,255 (206.9)	5,261 (207.1)
Overall width	Narrow body models	1,790 (70.5)	—	—
	Wide body models	—	1,850 (72.8)	1,850 (72.8)
Overall height	Two-Wheel Drive (2WD) models	—	—	1,815 (71.5)*2*5 1,850 (72.8)*3*4
	Four-Wheel Drive (4WD) models	1,775 (69.9)	1,800 (70.9)*1 1,810 (71.3)*2 1,840 (72.4)*3	1,830 (72.0)*2*5 1,865 (73.4)*3*4
Front tread		1,550 (61.0)	1,550 (61.0)*1 1,570 (61.8)*2*3	1,570 (61.8)
Rear tread		1,550 (61.0)	1,550 (61.0)*1 1,570 (61.8)*2*3	1,570 (61.8)
Wheelbase		3,150 (124.0)	3,150 (124.0)	3,150 (124.0)

- \*1: 205R16C tire equipped models
- \*2: 255/70R16 tire equipped models
- \*3: 255/60R18 tire equipped models
- \*4: Model with roof rack
- \*5: Model without roof rack

mm (in)

Destination		Thailand (for Sportech models)		Australia (for N-SPORT models)	Philippines (for SPORT EDITION models)
Body type		King Cab	Double Cab	Double Cab	Double Cab
Overall length		5,255 (206.9)	5,260 (207.1)	5,260 (207.1)	5,260 (207.1)
Overall width		1,850 (72.8)	1,850 (72.8)	1,850 (72.8)	1,850 (72.8)
Overall height	Two-Wheel Drive (2WD) models	1,755 (69.1)	1,785 (70.3)	—	1,825 (71.9)
	Four-Wheel Drive (4WD) models	—	1,790 (70.5)	1,810 (71.3)	1,840 (72.4)
Front tread		1,570 (61.8)	1,570 (61.8)	1,570 (61.8)	1,570 (61.8)
Rear tread		1,570 (61.8)	1,570 (61.8)	1,570 (61.8)	1,570 (61.8)
Wheelbase		3,150 (124.0)	3,150 (124.0)	3,150 (124.0)	3,150 (124.0)

## WHEN TRAVELLING OR REGISTERING IN ANOTHER COUNTRY

When planning to travel in another country or region, find out whether the fuel required for your vehicle is available in that country or region. Using a low octane/cetane rated fuel may cause engine damage. Therefore, be sure that the required fuel is available wherever you go. For additional information regarding recommended fuel, see earlier in this section.

When transferring the registration of your vehicle to another country, state, province or district, contact the appropriate authorities to find out that the vehicle complies with the local legal requirements. In some cases, a vehicle cannot meet the legal requirements, and it may be necessary to modify the vehicle to meet local laws and regulations. In addition, there may be possibilities that a vehicle cannot be adapted in certain areas.

The laws and regulations for motor vehicle emission control and safety standards vary according to the country, state, province or district; therefore, the vehicle specification may differ.

When any vehicles are to be taken into another country, state, province or district, its modification, transportation, registration, and any other expenses which may result, are the responsibility of the user. NISSAN is not responsible for any inconveniences that may result.

## VEHICLE IDENTIFICATION

It is prohibited to cover, paint, weld, cut, drill, alter or remove Vehicle Identification Number (VIN).

### VEHICLE IDENTIFICATION LABEL

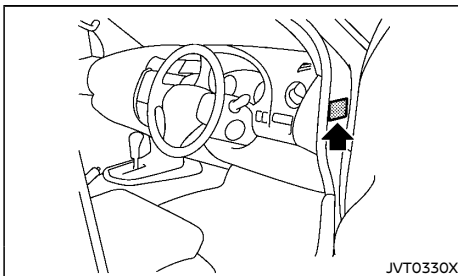

The vehicle identification label is affixed as illustrated.

### Built date (if equipped)

Built date is stamped on the vehicle identification label.

The built date means the calendar month and the year in which the body shell and power train subassemblies are conjoined and the vehicle is driven or moved from the production line.

### VEHICLE IDENTIFICATION NUMBER (VIN) LABEL (if equipped)

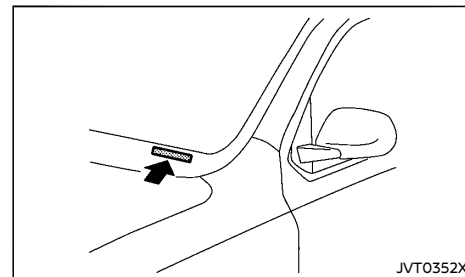

The vehicle identification number label is attached as shown.

### VEHICLE IDENTIFICATION NUMBER (VIN)

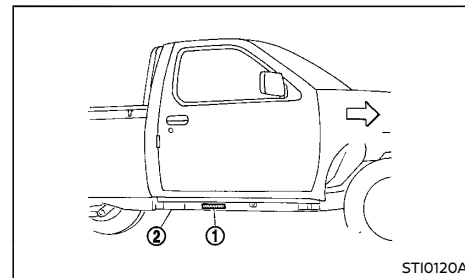

The vehicle identification number (chassis number) ① is stamped on the frame ② as shown.

## ENGINE SERIAL NUMBER

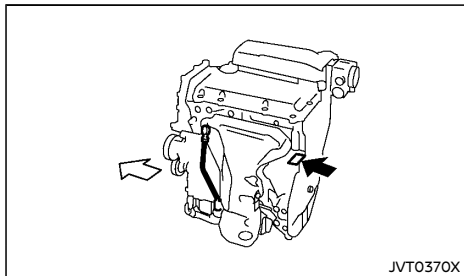

**QR25DE engine**

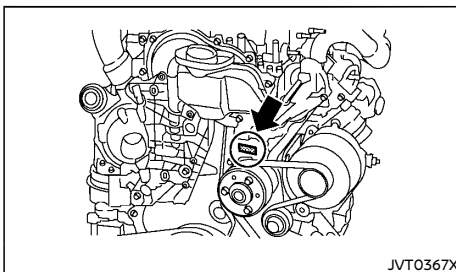

**YS23DDT/DDTT engine**

The number is stamped on the engine as shown.

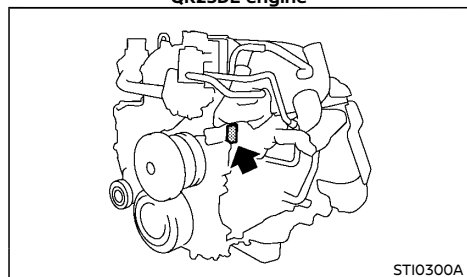

**YD25DDTi engine**

## TIRE PLACARD

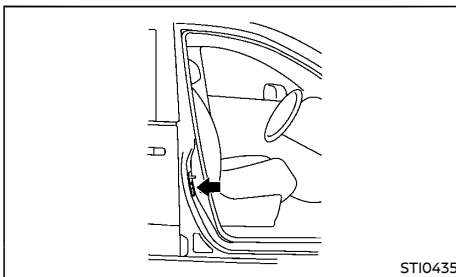

The cold tire pressures are shown on the tire placard affixed to the driver's side center pillar (Single Cab model and Double Cab model) or the driver's side rear access door (King Cab model).

## AIR CONDITIONER SPECIFICATION LABEL

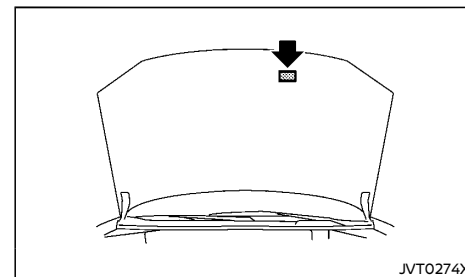

The air conditioner specification label is attached to the underside of the hood as shown.

## INSTALLATION OF AN RF-TRANSMITTER

### For countries conforming to UN regulation No.10 or equivalent:

The installation of an RF transmitter in your vehicle could affect electric equipment systems. Be sure to check with your NISSAN dealer for precautionary measures or special instructions regarding installation. Upon request, your NISSAN dealer will provide the detailed information (frequency band, power, antenna position, installation guide, etc.) regarding installation.

## RADIO APPROVAL NUMBER AND INFORMATION

### FOR THAILAND

This telecommunication equipment is in compliance with NTC requirements.

- Remote keyless entry system (if equipped)
- Intelligent Key system (if equipped)
- NISSAN Anti-Theft System (NATS) (if equipped)

### FOR INDONESIA

Remote keyless entry system (if equipped)

31574/SDPPI/2013  
1710

JVT0375X

14619/I/SDPPI/2013  
2425

JVT0376X

### Intelligent Key system (if equipped)

32926/SDPPI/2014  
1710

JVT0377X

33880/SDPPI/2014  
1710

JVT0378X



NISSAN Anti-Theft System (NATS) (if equipped)

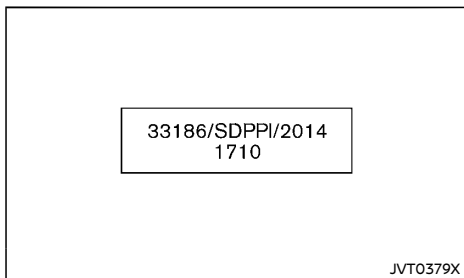

FOR VIETNAM

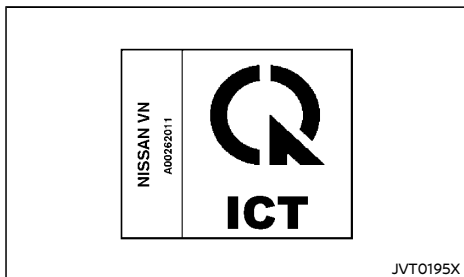

- Remote keyless entry system (if equipped)
- Intelligent Key system (if equipped)
- NISSAN Anti-Theft System (NATS) (if equipped)

FOR WESTERN SAMOA

Remote keyless entry system (if equipped)

**Approval No.**

T-318/13

T-280/13

Intelligent Key system (if equipped)

**Approval No.**

T-319/13

T-320/13

NISSAN Anti-Theft System (NATS) (if equipped)

**Approval No.**

T-279/13

FOR PAKISTAN

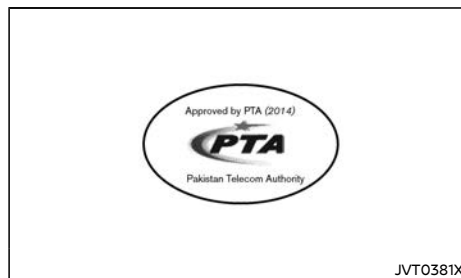

- Remote keyless entry system (if equipped)
- Intelligent Key system (if equipped)
- NISSAN Anti-Theft System (NATS) (if equipped)

FOR SURINAM

Remote keyless entry system (if equipped)

**Manufacturer:**

ALPS ELECTRIC CO., LTD.

**Brand:**

ALPS

**Model:**

TWB1U761

**Country of manufacture:**

China

**Manufacturer:**

ALPS ELECTRIC CO., LTD.

**Brand:**

NISSAN

**Model:**

TWC1G124

**Country of manufacture:**

Japan

Intelligent Key system (if equipped)

**Manufacturer:**

ALPS ELECTRIC CO., LTD.

**Brand:**

NISSAN

**Model:**

TWB1G662

**Country of manufacture:**

China

**Manufacturer:**  
ALPS ELECTRIC CO., LTD.  
**Brand:**  
NISSAN  
**Model:**  
TWC1G135  
**Country of manufacture:**  
China

NISSAN Anti-Theft System (NATS) (if equipped)

**Manufacturer:**  
ALPS ELECTRIC CO., LTD.  
**Brand:**  
NISSAN  
**Model:**  
TWK1A002  
**Country of manufacture:**  
China

**Manufacturer:**  
CALSONIC KANSEI CORPORATION  
**Brand:**  
NISSAN  
**Model:**  
MW1014  
**Country of manufacture:**  
Tunisia

FOR JAMAICA

Remote keyless entry system (if equipped)

This product contains a Type Approved Module by Jamaica : TWB1U761

**Manufacturer:**  
ALPS ELECTRIC CO., LTD.  
**Approved for use in Jamaica SMA EI:**  
TWB1U761

This product contains a Type Approved Module by Jamaica : TWC1G124

**Manufacturer:**  
ALPS ELECTRIC CO., LTD.  
**Approved for use in Jamaica SMA EI:**  
TWC1G124

Intelligent Key system (if equipped)

This product contains a Type Approved Module by Jamaica : TWB1G662

**Manufacturer:**  
ALPS ELECTRIC CO., LTD.  
**Approved for use in Jamaica SMA EI:**  
TWB1G662

This product contains a Type Approved Module by Jamaica : TWC1G135

**Manufacturer:**  
ALPS ELECTRIC CO., LTD.  
**Approved for use in Jamaica SMA EI:**  
TWC1G135

NISSAN Anti-Theft System (NATS) (if equipped)

This product contains a Type Approved Module by Jamaica : TWK1A002

**Manufacturer:**  
ALPS ELECTRIC CO., LTD.  
**Approved for use in Jamaica SMA EI:**  
TWK1A002

This product contains a Type Approved Module by Jamaica : MW1014

**Manufacturer:**  
Calsonic Kansei Corporation  
**Approved for use in Jamaica SMA EI:**  
MW1014

FOR TAHITI, MONTSERRAT AND NEW CALEDONIA

Remote keyless entry system (if equipped)



**DECLARATION OF CONFORMITY**  
For



Product: keyless transmitter  
Model: TWB1U761  
Type: Transceiver

Supplied by  
Alps Electric Co., Ltd

Technical Construction File held by  
Alps Electric Co., Ltd

6-3-36, Nakazato, Furukawa, Osaka-city,  
Miyagi-pref. JAPAN 989-6181

6-3-36, Nakazato, Furukawa, Osaka-city,  
Miyagi-pref. JAPAN 989-6181

Notified Body - R&TTE Directive

N/A

Standard used for comply  
EN 60955:2002+Amd 1:2006+Amd 11:2008  
+Amd 2:2010+Amd 12:2011

R&TTE Directive  
(Article 3.1(a) Safety)

R&TTE Directive  
(Article 3.1(b) EMC)

R&TTE Directive  
(Article 3.2 Spectrum)

Means of Conformity  
We declare under our sole responsibility that the Product (s) is conformity with the  
essential requirements and other relevant requirements of the  
Radio and Telecommunication Terminal Equipment (R&TTE) Directive (1999/5/EC).

Date of Issue: August 9, 2013

Signature of Responsible Person:

Toru Kinoshita  
Group Manager  
GROUP 2 ENGINEERING DEPT. M5

*T. Kinoshita*

JVT0382X

**DECLARATION OF CONFORMITY**  
For



Product: TPMS/Keyless Tuner  
Model: TWC1G124  
Type: Receiver

Supplied by  
Alps Electric Co., Ltd

Technical Construction File held by  
Alps Electric Co., Ltd

6-3-36, Nakazato, Furukawa, Osaka-city,  
Miyagi-pref. JAPAN 989-6181

6-3-36, Nakazato, Furukawa, Osaka-city,  
Miyagi-pref. JAPAN 989-6181

Notified Body - R&TTE Directive

N/A

Standard used for comply  
EN 60955:2002+Amd 1:2006+Amd 11:2008  
+Amd 2:2010+Amd 12:2011

R&TTE Directive  
(Article 3.1(a) Safety)

R&TTE Directive  
(Article 3.1(b) EMC)

R&TTE Directive  
(Article 3.2 Spectrum)

Means of Conformity  
We declare under our sole responsibility that the Product (s) is conformity with the  
essential requirements and other relevant requirements of the  
Radio and Telecommunication Terminal Equipment (R&TTE) Directive (1999/5/EC).

Date of Issue: August 9, 2013

Signature of Responsible Person:

Toru Kinoshita  
Group Manager  
GROUP 2 ENGINEERING DEPT. M5

*T. Kinoshita*

JVT0383X

**DECLARATION OF CONFORMITY**  
For



Product: Passive Entry System (Hand  
Use)  
Model: TWB1G662  
Type: Transceiver

Supplied by  
Alps Electric Co., Ltd

Technical Construction File held by  
Alps Electric Co., Ltd

6-3-36, Nakazato, Furukawa, Osaka-city,  
Miyagi-pref. JAPAN 989-6181

6-3-36, Nakazato, Furukawa, Osaka-city,  
Miyagi-pref. JAPAN 989-6181

Notified Body - R&TTE Directive

N/A

Standard used for comply  
EN 60955:2002+Amd 1:2006+Amd 11:2008  
+Amd 2:2010+Amd 12:2011

R&TTE Directive  
(Article 3.1(a) Safety)

R&TTE Directive  
(Article 3.1(b) EMC)

R&TTE Directive  
(Article 3.2 Spectrum)

Means of Conformity  
We declare under our sole responsibility that the Product (s) is conformity with the  
essential requirements and other relevant requirements of the  
Radio and Telecommunication Terminal Equipment (R&TTE) Directive (1999/5/EC).

Date of Issue: September 3, 2013

Signature of Responsible Person:

Toru Kinoshita  
Group Manager  
GROUP 2 ENGINEERING DEPT. M5

*T. Kinoshita*

JVT0384X

Intelligent Key system (if equipped)



**DECLARATION OF CONFORMITY**  
For



Product: Passive Entry System (Timer)  
Model: TWK1G135  
Type: Receiver

Supplied by  
Alps Electric Co., Ltd  
6-3-36, Nakazono, Furokawa, Otsu-city,  
Miyagi-ken, JAPAN 985-6181

Technical Construction File held by  
Alps Electric Co., Ltd  
6-3-36, Nakazono, Furokawa, Otsu-city,  
Miyagi-ken, JAPAN 985-6181

Notified Body - R&TTE Directive

N/A

	<b>Standard used for comply</b>
<b>R&amp;TTE Directive</b> (Article 3.1(a) Safety)	EN60950:2002+Amd.1:2006+Amd.11:2008 +Amd.2:2010+Amd.12:2011
<b>R&amp;TTE Directive</b> (Article 3.1(b) EMC)	EN 301 489-1 V1.8.2:2011-09 EN 301 489-3 V1.4.1:2002-08
<b>R&amp;TTE Directive</b> (Article 3.2 Spectrum)	EN 300 220-1 V2.4.1:2012-03 EN 300 220-2 V2.4.1:2012-03

**Means of Conformity**  
We declare under our sole responsibility that the Product (s) is conformity with the essential requirements and other relevant requirements of the Radio and Telecommunication Terminal Equipments (R&TTE) Directive (1999/5/EC).

Date of issue: September 3, 2013

Signature of Responsible Person: *T. Kato*  
Tetsu Katohita  
Group Manager  
GROUP 2 ENGINEERING DEPT. MS

JVT0385X

**DECLARATION OF CONFORMITY**  
For



Product: Immobilizer Antenna  
Model: TWK1A002  
Type: Transceiver

Supplied by  
Alps Electric Co., Ltd  
6-3-36, Nakazono, Furokawa, Otsu-city,  
Miyagi-ken, JAPAN 985-6181

Technical Construction File held by  
Alps Electric Co., Ltd  
6-3-36, Nakazono, Furokawa, Otsu-city,  
Miyagi-ken, JAPAN 985-6181

Notified Body - R&TTE Directive

N/A

	<b>Standard used for comply</b>
<b>R&amp;TTE Directive</b> (Article 3.1(a) Safety)	EN60950:2002+Amd.1:2006+Amd.11:2008 +Amd.2:2010+Amd.12:2011
<b>R&amp;TTE Directive</b> (Article 3.1(b) EMC)	EN 301 489-1 V1.9.2:2011-09 EN 301 489-3 V1.4.1:2002-08
<b>R&amp;TTE Directive</b> (Article 3.2 Spectrum)	EN 300 330-1 V1.3.1:2010-02 EN 300 330-2 V1.3.1:2010-02

**Means of Conformity**  
We declare under our sole responsibility that the Product (s) is conformity with the essential requirements and other relevant requirements of the Radio and Telecommunication Terminal Equipments (R&TTE) Directive (1999/5/EC).

Date of issue: September 3, 2013

Signature of Responsible Person: *T. Kato*  
Tetsu Katohita  
Group Manager  
GROUP 2 ENGINEERING DEPT. MS

JVT0386X



Calsonic Kasei Corp.  
2-1917, Nishim-cho, Kita-ku, Sakai-shi, Sakai-ken  
591-8501, Japan  
TEL: +81-48-660-4073 FAX: +81-48-661-1026

Date: January 24, 2013

**DECLARATION OF CONFORMITY**

We, Calsonic Kasei Corp., hereby declare, at our sole responsibility, that the following product conforms to the Essential Requirements of the Radio and Telecommunications Terminal Equipment Directive 1999/5/EC in accordance with the tests conducted to the appropriate requirements of the relevant standards, as listed herewith:

Product	Immobilizer System
Model / Type Number	MW1914
Directive and Standards used	<b>Radio</b> : EN300 336-1 V1.5.1 (2010-02) EN300 336-1 V1.7.1 (2010-02) <b>EMC</b> : EN301 489-3 V1.4.1 (2002-08) EN301 489-3 V1.4.1 (2002-08) <b>Safety</b> : EN60950:2002 + A1 : 2006 + A2 : 2010 (incl. A12:2011)

Signature: *Haruyoshi Hayashi*  
Name: Haruyoshi Hayashi  
Position: Senior Manager  
Electronic Design Group

JVT0387X

NISSAN Anti-Theft System (NATS) (if equipped)



FOR SOUTH AFRICA

Remote keyless entry system (if equipped)



Intelligent Key system (if equipped)



NISSAN Anti-Theft System (NATS)



**MEMO**

# 10 Index

## A

ABS (Anti-lock Braking System).....	5-35
Air bag system	
Supplemental curtain side-impact air bag system.....	1-25, 1-31
Supplemental driver's knee air bag system.....	1-25, 1-31
Supplemental front-impact air bag system.....	1-25, 1-31
Supplemental side-impact air bag system.....	1-25, 1-31
Air conditioner.....	4-22
Air conditioner operation.....	4-21
Air conditioner service.....	4-30
Air conditioner specification label.....	9-15
Air conditioning system refrigerant and lubricant recommendations.....	4-30
Antenna.....	4-76
Anti-lock Braking System (ABS).....	5-35
Anti-lock braking system (ABS) warning light.....	2-14
Appearance care	
Exterior appearance care.....	7-2
Interior appearance care.....	7-4
Around View Monitor.....	4-13
Audible reminders.....	2-19
Audio operation precautions.....	4-31
Audio system.....	4-31
Audio control steering switch.....	4-75
FM-AM radio with compact disc (CD) player.....	4-39, 4-44, 4-51, 4-57, 4-63, 4-69
Automatic	
Automatic sunroof.....	2-41
Automatic air conditioner.....	4-29
Auxiliary input jack.....	4-43, 4-62, 4-75

## B

Battery.....	8-4, 8-21
Battery saver system.....	2-35, 2-49
Intelligent Key battery.....	8-23
Intelligent Key battery replacement.....	8-23
Remote controller battery.....	8-22
Remote controller battery replacement.....	8-22
Variable voltage control system.....	8-24
Bleeding the fuel system.....	8-13
Bluetooth® audio player operation.....	4-62
Bluetooth® Hands-Free Phone System.....	4-77, 4-83, 4-87
Brake	
Anti-lock Braking System (ABS).....	5-35
Brake assist.....	5-35
Brake booster.....	8-15
Brake fluid.....	8-16
Brake system.....	5-35
Parking brake check.....	8-15
Parking brake operation.....	5-37
Warning light.....	2-14
Break-in schedule.....	5-3
Brightness control	
Instrument panel.....	2-10
Bulb check/instrument panel.....	2-14
Bulb replacement.....	8-2, 8-26

## C

C-Channel system.....	3-20
Card holder.....	2-46
Cargo light switch.....	2-37
Catalytic converter, Three way catalyst.....	5-4
CD player operation.....	4-41
CD/USB memory care and cleaning.....	4-75
Center ventilators.....	4-20
Child restraint installation using ISOFIX....	1-18

Child restraint installation using three-point type seat belt.....	1-19
Child restraint installation using two-point type seat belt.....	1-23
Child restraints.....	1-13
Child safety.....	1-10
Child safety rear door lock.....	3-5
Chimes, Audible reminders.....	2-19
Circuit breaker, Fusible link.....	8-24
Cleaning exterior and interior.....	7-2, 7-4
Clack.....	2-30
Clutch	
Clutch fluid.....	8-17
Cockpit.....	2-3
Cold weather driving.....	5-37
Compass.....	2-11
Console box.....	2-44
Console light.....	2-47
Coolant	
Changing engine coolant.....	8-8
Checking engine coolant level.....	8-8
Corrosion protection.....	7-5
Cruise control.....	5-26
Cup holders.....	2-44

## D

Daytime running light system.....	2-34
Defogger switch.....	2-38
Diesel Particulate Filter (DPF).....	5-5
Dimensions.....	9-8
Display	
Vehicle information display (models with color display).....	2-20
Vehicle information display (models without color display).....	2-30
Door open warning light.....	2-15
Draining water.....	8-13
Drive belt.....	8-14

Driving	
Cold weather driving.....	5-37
On-pavement and off-road driving.....	5-7
Precautions when starting and driving.....	5-3
Safety precautions.....	5-7

## E

ECO drive report.....	5-28
Economy, Fuel.....	5-29
Elapsed time.....	2-26
Engine	
Break-in schedule.....	5-3
Changing engine coolant.....	8-8
Checking engine coolant level.....	8-8
Checking engine oil level.....	8-9
Coolant temperature gauge.....	2-9
Engine compartment check locations.....	8-5
Engine cooling system.....	8-7
Engine oil.....	8-9
Engine serial number.....	9-15
Engine specifications.....	9-6
Engine start operation indicator (for Automatic Transmission (AT) models).....	2-22
Engine start operation indicator (for Manual Transmission (MT) models).....	2-22
Fuel filter.....	8-13
If your vehicle overheats.....	6-11
Exhaust gas (carbon monoxide).....	5-4

## F

Flat tire.....	6-2
Floor mat cleaning.....	7-4
Fluid	
Brake fluid.....	8-16
Clutch fluid.....	8-17

Engine coolant.....	8-7
Engine oil.....	8-9
Power steering fluid.....	8-18
Window washer fluid.....	8-4, 8-20
FM-AM radio with compact disc (CD) player.....	4-39, 4-44, 4-51, 4-57, 4-63, 4-69
Fog light switch.....	2-36
Front seat, Front seat adjustment.....	1-2
Fuel	
Bleeding the fuel system.....	8-13
Fuel economy.....	5-29
Fuel filter.....	8-13
Fuel information.....	9-4
Fuel octane (cetane) rating.....	9-4
Gauge.....	2-9
Fuel Efficiency and Carbon Dioxide Reduction driving tips.....	5-28
Fuel-filler lid and cap.....	3-17
Fuses.....	8-24
Fusible links.....	8-24

## G

Gauge.....	2-7
Engine coolant temperature gauge.....	2-9
Fuel gauge.....	2-9
Odometer.....	2-8
Speedometer.....	2-8
Tachometer.....	2-8
Trip computer (with color display).....	2-25
Trip computer (without color display).....	2-31
General maintenance.....	8-2
Glove box.....	2-44

## H

Hands-Free Phone System, Bluetooth®.....	4-77, 4-83, 4-87
Head restraints.....	1-6

Headlights	
Aiming control.....	2-34
Bulb replacement.....	8-26
Headlight switch.....	2-33
Heater	
Heater and air conditioner operation.....	4-21
Hill start assist system.....	5-26
Hood release.....	3-16
Horn.....	2-39

## I

Ignition switch.....	5-9
Ignition switch (Push-button).....	5-10
Indicator	
Vehicle information display (models with color display).....	2-20
Vehicle information display (models without color display).....	2-30
Indicator lights.....	2-17
Instrument brightness control.....	2-10
Instrument panel.....	2-5
Intelligent Key.....	3-3
Intelligent Key battery.....	8-23
Intelligent Key system.....	3-7
Key operating range.....	3-8
Interior light switch.....	2-47
Interior lights.....	2-47
ISOFIX child restraint system.....	1-16

## J

Jump starting.....	6-7
--------------------	-----

## K

Key	
Intelligent Key.....	3-3
NISSAN Anti-Theft System (NATS*) key.....	3-2



Keys.....	3-2
For Intelligent Key system.....	3-7

## L

Labels	
Air conditioner specification label.....	9-15
Engine serial number.....	9-15
Vehicle Identification Number (VIN).....	9-14

Light	
Bulb replacement.....	8-2, 8-26
Fog light switch.....	2-36
Headlight switch.....	2-33
Headlights bulb replacement.....	8-26
Indicator lights.....	2-17
Interior lights.....	2-47
Map lights.....	2-47
Rear personal light.....	2-48
Replacement.....	8-2, 8-26
Room light.....	2-48
Warning/indicator lights and audible reminders.....	2-14
Low fuel warning.....	2-23
Low fuel warning light.....	2-16

## M

Maintenance	
Battery.....	8-4, 8-21
General maintenance.....	8-2
Maintenance precautions.....	8-4
Maintenance requirements.....	8-2
Seat belt maintenance.....	1-12
Malfunction indicator light (MIL).....	2-18
Manual air conditioner and heater.....	4-24, 4-26
Map light control switch.....	2-47
Map lights.....	2-47
Master warning light.....	2-16
Maximum load limits.....	5-33
Mechanical key (Intelligent Key system).....	3-3

Meter	
Trip computer (with color display).....	2-25
Trip computer (without color display).....	2-31
Meters and gauges.....	2-7
Instrument brightness control.....	2-10
Mirror, Vanity mirror.....	3-25

## N

New vehicle break-in.....	5-3
NISSAN Anti-Theft System (NATS*) key.....	3-2
NissanConnect Owner's Manual.....	4-3

## O

Odometer.....	2-8
Odometer (models with color display).....	2-8
Odometer (models without color display).....	2-8
Oil	
Checking engine oil level.....	8-9
Engine oil.....	8-9
Oil and Filter replacement indicator.....	2-25
Oil control system.....	2-29, 2-31
Oil Filter replacement indicator.....	2-25
Operating precautions.....	5-33
Operation	
Indicators for operation.....	2-21
Outside air temperature.....	2-30, 2-31
Overheat, if your vehicle overheats.....	6-11

## P

Parking	
Brake break-in.....	5-35
Parking brake operation.....	5-37
Parking sensor (sonar) function.....	4-18
Parking sensor (sonar) system.....	5-31

Phone	
Bluetooth® Hands-Free Phone System.....	4-77, 4-83, 4-87

Power	
Auto slide back window system.....	2-41
Power outlet.....	2-42
Power steering fluid.....	8-18
Power windows.....	2-39
Pre-tensioner seat belt system.....	1-28, 1-34

Precautions	
Audio operation.....	4-31
Cruise control.....	5-27
Driving safety.....	5-7
Maintenance.....	8-4
On-pavement and off-road driving.....	5-7
Seat belt usage.....	1-8
When starting and driving.....	5-3
Push starting.....	6-11
Push-button ignition switch.....	5-10

## R

Rear access doors (King Cab models).....	3-5
Rear differential locking system.....	5-23
Rear door lock, Child safety rear door lock.....	3-5
Rear fog light.....	2-37
Rear personal light.....	2-48
Rear ventilators.....	4-21
Rear view monitor.....	4-7
Remote controller battery.....	8-22
Remote keyless entry system.....	3-6
Roof, Roof rack.....	2-45
Room light.....	2-48

## S

Safety chains.....	5-34
Safety, Child seat belts.....	1-10
Seat	
ISOFIX child restraint system.....	1-16

Seat adjustment, Front seats.....	1-2
Seat belt	
Child restraint installation using three-point type seat belt.....	1-19
Child restraint installation using two-point type seat belt.....	1-23
Seat belt(s)	
Child safety.....	1-10
Injured persons.....	1-11
Pre-tensioner seat belt system.....	1-28, 1-34
Precautions on seat belt usage.....	1-8
Pregnant women.....	1-10
Seat belt cleaning.....	7-5
Seat belt maintenance.....	1-12
Seat belt warning light.....	2-17
Seat belts.....	1-8
Shoulder belt height adjustment.....	1-11
Seat(s)	
Seats.....	1-2
Servicing air conditioner.....	4-30
Shift lever	
Shift lock release.....	5-16
Shift lock release	
Transmission.....	5-16
Shoulder belt height adjustment.....	1-11
Side ventilators.....	4-20
Smartphone integration.....	4-73
SOURCE select switch.....	4-76
Spare tire.....	8-34
Spark plugs.....	8-14
Speedometer.....	2-8
SRS air bag deployment conditions.....	1-31
Starting	
Jump starting.....	6-7
Precautions when starting and driving.....	5-3
Push starting.....	6-11
Steering	
Audio control steering switch.....	4-75
Power steering fluid.....	8-18
Steering lock.....	5-11

Steering lock release malfunction indicator.....	2-22
Tilting steering wheel.....	3-23
Sun visors.....	2-46
Sunglasses holder.....	2-44
Sunroof.....	2-41
Automatic sunroof.....	2-41
Supplemental air bag systems	
Supplemental curtain side-impact air bag system.....	1-31
Supplemental driver's knee air bag system.....	1-31
Supplemental front-impact air bag system.....	1-31
Supplemental side-impact air bag system.....	1-31
Supplemental curtain side-impact air bag system.....	1-25
Supplemental driver's knee air bag system.....	1-25
Supplemental front-impact air bag system.....	1-25
Supplemental side-impact air bag system.....	1-25
Switch	
Fog light switch.....	2-36
Headlight aiming control.....	2-34
Headlight switch.....	2-33
Ignition switch.....	5-9
Power door lock switch.....	3-5
Turn signal switch.....	2-35

## T

Tachometer.....	2-8
Tailgate.....	3-19
Temperature gauge, Engine coolant temperature gauge.....	2-9
Three-way catalyst.....	5-4
Tie down hooks.....	3-20
Tilting steering wheel.....	3-23

Tire	
Tire replacement indicator.....	2-25
Tire recommendation for 4WD.....	5-22
Tires	
Flat tire.....	6-2
Tire chains.....	8-33
Tire pressure.....	5-34
Tire rotation.....	8-3, 8-33
Types of tires.....	8-32
Towing, Tow truck towing.....	6-12
Trailer towing.....	5-32, 5-33
Transmission, Transmission shift lever lock release.....	5-16
Trip computer (with color display).....	2-25
Trip computer (without color display).....	2-31
Trip odometer.....	2-26
Truck box.....	3-19
Turbocharger system.....	5-7
Turn signal switch.....	2-35

## U

Underbody cleaning.....	7-3
Universal child restraints for rear seats....	1-14
USB (Universal Serial Bus) connection port.....	4-74
Using remote keyless entry system.....	3-6

## V

Vanity mirror.....	3-25
Vanity mirror light.....	2-48
Variable voltage control system.....	8-24
Vehicle	
Dimensions.....	9-8
Identification Number (VIN).....	9-14
Vehicle dynamic control (VDC) system.....	5-23
Vehicle information display (models with color display).....	2-20

Vehicle information display (models without color display).....	2-30
Ventilators.....	4-20

## W

<b>Warning</b>	
4WD warning .....	5-21
Lights.....	2-14
Vehicle information display (models with color display).....	2-20
Vehicle information display (models without color display).....	2-30
Warning lights, indicator lights and audible reminders.....	2-13
<b>Warning light</b>	
Anti-lock braking system (ABS) warning light.....	2-14
Brake warning light.....	2-14
Door open warning light.....	2-15
Low fuel warning light.....	2-16
Seat belt warning light.....	2-17
<b>Washer switch, Windshield wiper and washer switch.....</b>	
	2-37
<b>Washing.....</b>	7-2
<b>Waxing.....</b>	7-2
<b>Wheels and tires</b>	
Care of wheels.....	7-3
Cleaning aluminum alloy wheels.....	7-3
Tires and wheels.....	8-32, 9-7
Window washer fluid.....	8-4, 8-20
<b>Window(s)</b>	
Auto slide back window system.....	2-41
Cleaning.....	7-3, 7-4
Manual windows.....	2-39
Power windows.....	2-39
Windshield wiper and washer switch.....	2-37
<b>Wiper</b>	
Windshield wiper and washer switch.....	2-37
Wiper blades.....	8-18

## GAS STATION INFORMATION

### FUEL INFORMATION

Gasoline engine (model with three-way catalyst)



#### CAUTION:

**Do not use leaded gasoline. Using leaded gasoline will damage the three-way catalyst.**

Use UNLEADED REGULAR gasoline with an octane rating of at least 91 (RON).

For Thailand: Use UNLEADED REGULAR gasoline or gasohol (up to E10\*) with an octane rating of at least 91 (RON).

\*: Gasohol is alcohol blended gasoline. For example, "E10" is a mixture of approximately 10% fuel ethanol and 90% unleaded gasoline.

Diesel engine\*

**YD25DDTi engine:**

Diesel fuel above 50 cetane must be used.

**YS23DDT/DDTT engine:**

Diesel fuel above 50 cetane and with a maximum of 10 ppm of sulfur (EN590) must be used. (except for South Africa)

Diesel fuel above 50 cetane and with a maximum of 50 ppm of sulfur (EN590) must be used. (for South Africa)

\* If two types of diesel fuel are available, use summer or winter fuel properly according to the following temperature conditions.

- Above  $-7^{\circ}\text{C}$  ( $20^{\circ}\text{F}$ ) ... Summer type diesel fuel.
- Below  $-7^{\circ}\text{C}$  ( $20^{\circ}\text{F}$ ) ... Winter type diesel fuel.

## QUICK REFERENCE



#### CAUTION:

- **Do not use home heating oil, gasoline or other alternate fuels in your diesel engine. The use of those or adding those to diesel fuel can cause engine damage.**
- **Do not use summer fuel at temperatures below  $-7^{\circ}\text{C}$  ( $20^{\circ}\text{F}$ ). The cold temperatures will cause wax to form in the fuel. As a result, it may prevent the engine from running smoothly.**

### RECOMMENDED ENGINE OIL

See "Recommended fluids/lubricants and capacities" (P.9-2).

### TIRE COLD PRESSURE

See the tire placard affixed to the driver's side center pillar (Single Cab model and Double Cab model) or the driver's side rear access door (King Cab model).

- In case of emergency ... 6-1  
(Flat tire, engine will not start, overheating, towing)
- How to start the engine ... 5-1
- How to read the meters and gauges ... 2-1
- Maintenance and do-it-yourself ... 8-1
- Technical information ... 9-1