

Foreword

Welcome to the growing family of new NISSAN owners. This vehicle has been delivered to you with confidence. It has been produced using the latest techniques and strict quality control.

This manual was prepared to help you understand the operation and maintenance of your vehicle so that you may enjoy many kilometers (miles) of driving pleasure. Please read through this manual before operating your vehicle.

A separate Warranty Information & Maintenance Booklet explains details about the warranties covering your vehicle.

Your NISSAN dealer knows your vehicle best. When you require any service or have any questions, we will be glad to assist you with the extensive resources available for you.

IMPORTANT SAFETY INFORMATION

Reminders for safety!

Follow these important driving rules to help ensure a safe and complete trip for you and your passengers!

- **NEVER drive under the influence of alcohol or drugs.**
- **ALWAYS observe posted speed limits and never drive too fast for conditions.**
- **ALWAYS use your seat belts and appropriate child restraint systems. Preteen children should be seated in the rear seat.**
- **ALWAYS provide information about the proper use of vehicle safety features to all occupants of the vehicle.**
- **ALWAYS review this Owner's Manual for important safety information.**

When reading the manual

This manual includes information for all options available on this model. Therefore, you may find some information that does not apply to your vehicle.

All information, specifications and illustrations in this manual are those in effect at the time of printing. NISSAN reserves the right to change specifications or designs without notice and without obligation.

MODIFICATION OF YOUR VEHICLE

This vehicle should not be modified. Modification could affect its performance, safety or durability, and may even violate governmental regulations. In addition, damage or performance problems resulting from modifications may not be covered under NISSAN warranties.

Read first - then drive safely

Before driving your vehicle, read this Owner's Manual carefully. This will ensure familiarity with controls and maintenance requirements, assisting you in the safe operation of your vehicle.

Throughout this manual we have used the symbol  followed by the word **WARNING**. This is used to indicate the presence of a hazard that could cause death or serious personal injury. To avoid or reduce the risk, the procedures must be followed precisely.

The symbol  followed by the word **CAUTION** is also used throughout this manual to indicate the presence of a hazard that could cause minor or moderate personal injury or damages to your vehicle. To avoid or reduce the risk, the procedures must be followed carefully.

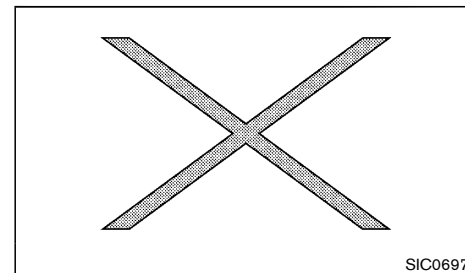

If you see this symbol, it means **“Do not do this”** or **“Do not let this happen”**.

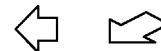

If you see a symbol similar to these in an illustration, it means the arrow points to the front of the vehicle.



Arrows in an illustration that are similar to these indicate movement or action.



Arrows in an illustration that are similar to these call attention to an item in the illustration.

Air bag warning labels (if equipped):



“NEVER use a rearward facing child restraint on a seat protected by an ACTIVE AIRBAG in front of it, DEATH or SERIOUS INJURY to the CHILD can occur.”

Be sure to read “Air bag warning labels” (P:1-25).

© 2016 NISSAN MOTOR CO., LTD.

Table of Contents

Illustrated table of contents	0
Safety — seats, seat belts and supplemental restraint system	1
Instruments and controls	2
Pre-driving checks and adjustments	3
Monitor, Heater and air conditioner, and audio system	4
Starting and driving	5
In case of emergency	6
Appearance and care	7
Maintenance and do-it-yourself	8
Technical information	9
Index	10

0 Illustrated table of contents

Seats, seat belts and supplemental restraint system (SRS)	0-2	Instrument panel	0-7
Exterior front	0-3	Meters and gauges	0-8
Exterior rear	0-4	Engine compartment	0-10
Passenger compartment	0-5	HR12DE engine model	0-10
Cockpit	0-6	HR12DDR engine model	0-11

SEATS, SEAT BELTS AND SUPPLEMENTAL RESTRAINT SYSTEM (SRS)

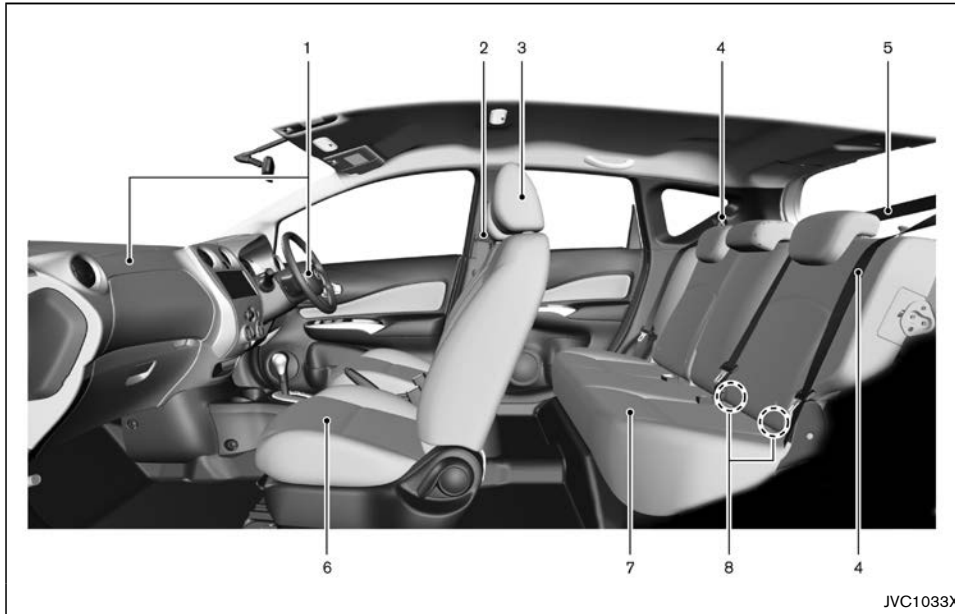

1. Supplemental front-impact air bags (Page 1-23)
2. Front seat belts (P.1-6)
3. Head restraints (P.1-4)
4. Rear seat belts (P.1-6)
5. Rear center seat belt (P.1-6)
6. Front seats (P.1-2)
7. Rear seats (P.1-3)
8. ISOFIX child restraint system (P.1-17)

EXTERIOR FRONT

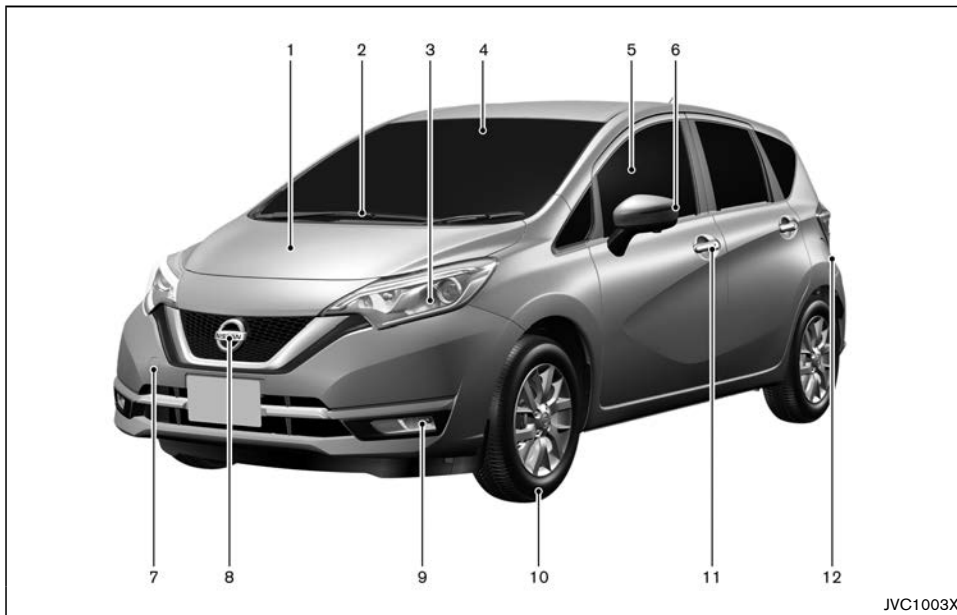

JVC1003X

- | | |
|---|---|
| <p>1. Hood (P.3-12)</p> <p>2. Windshield wiper and washer
— Wiper and washer switch (P.2-21)
— Wiper replacement (P.8-14)
— Washer fluid (P.8-15)</p> <p>3. Headlights
— Switch operation (P.2-18)
— Bulb replacement (P.8-21)
Front turn signal lights
— Switch operation (P.2-20)</p> | <p>— Bulb replacement (P.8-21)
Clearance lights
— Switch operation (P.2-18)
— Bulb replacement (P.8-21)</p> <p>4. Multi-sensing front camera unit* (P.5-14, P.5-17)</p> <p>5. Windows (P.2-23)</p> <p>6. Outside rearview mirrors (P.3-16)
— Side turn signal lights (P.2-20)
— Side view camera* (P.4-2)</p> |
|---|---|

7. Recovery hook (P.6-11)
8. Front view camera* (P.4-2)
9. Fog lights*
— Switch operation (P.2-20)
— Bulb replacement (P.8-21)
10. Tires
— Tires and wheels (P.8-26, P.9-5)
— Flat tire (P.6-2)
11. Doors
— Keys (P.3-2)
— Door locks (P.3-3)
— Intelligent Key system (P.3-4)
12. Fuel-filler lid (P.3-15)

*: if equipped

EXTERIOR REAR

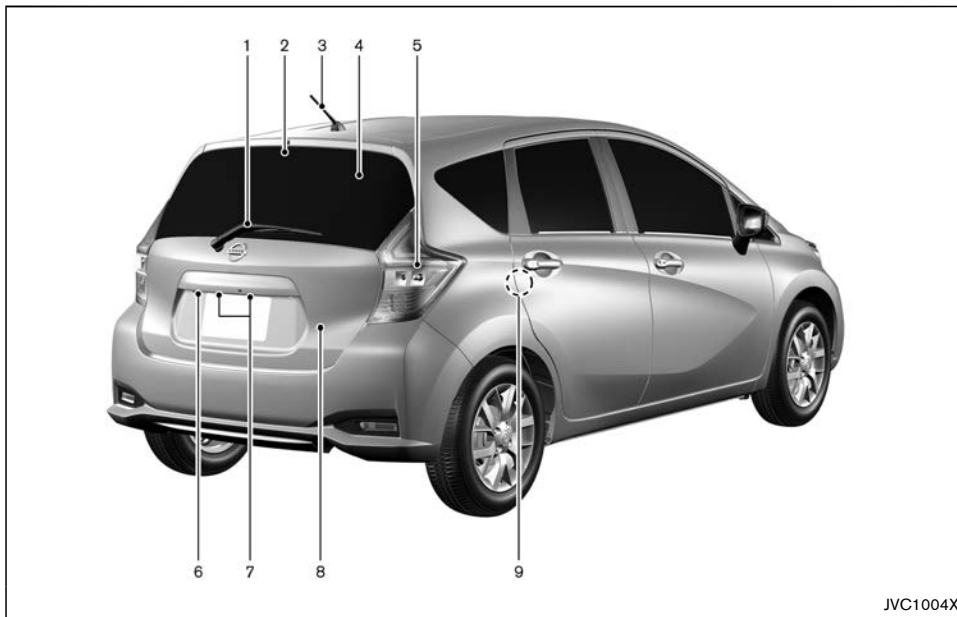

JVC1004X

- | | |
|-------------------------------------|--|
| 1. Rear window wiper and washer | — Switch operation (P.2-20) |
| — Switch operation (P.2-21) | — Bulb replacement (P.8-21) |
| — Window washer fluid (P.8-15) | Reverse light (P.8-21) |
| 2. High-mounted stop light (P.8-21) | Stop lights (P.8-21) |
| 3. Antenna (P.4-19) | 6. Rear view camera* (P.4-2) |
| 4. Rear window defogger (P.2-22) | 7. License plate light (P.8-21) |
| 5. Tail lights | 8. Rear hatch (P.3-13) |
| — Switch operation (P.2-18) | — Intelligent Key system (P.3-4) |
| — Bulb replacement (P.8-21) | 9. Child safety rear door lock (P.3-4) |
| Turn signal lights | |

*: if equipped

PASSENGER COMPARTMENT

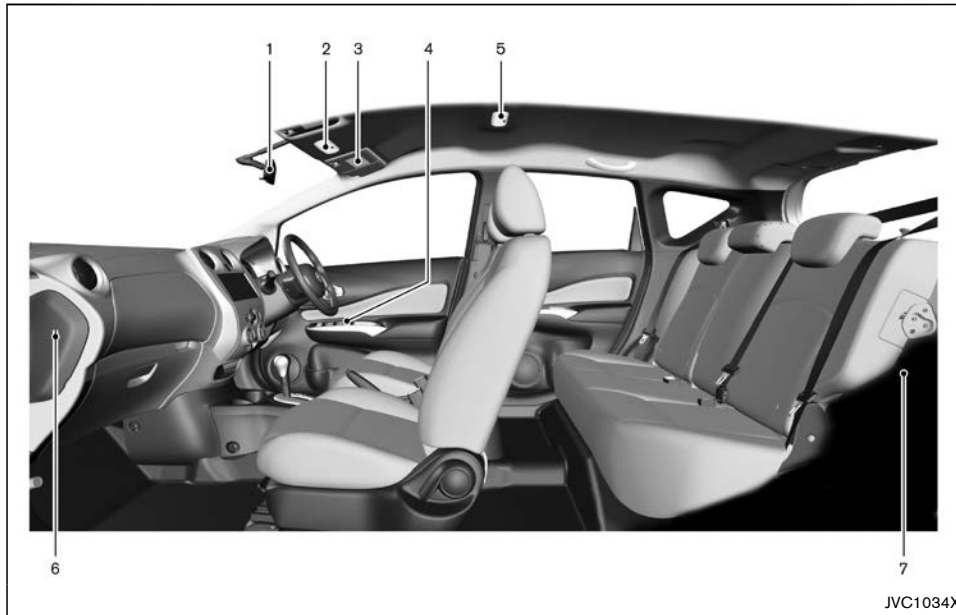

1. Inside rearview mirror (P.3-16)
 - Around View Monitor* (P.4-2)
 2. Map light (P.2-28, P.8-22)
 3. Sun visor (P.2-28)
 4. Door armrest
 - Power window switch (P.2-23)
 - Power door lock switch (P.3-4)
 5. Room light (P.2-28, P.8-22)
 6. Fuse box (P.8-19)
 7. Luggage room
 - Luggage hooks (P.2-27)
- *: if equipped

JVC1034X

COCKPIT

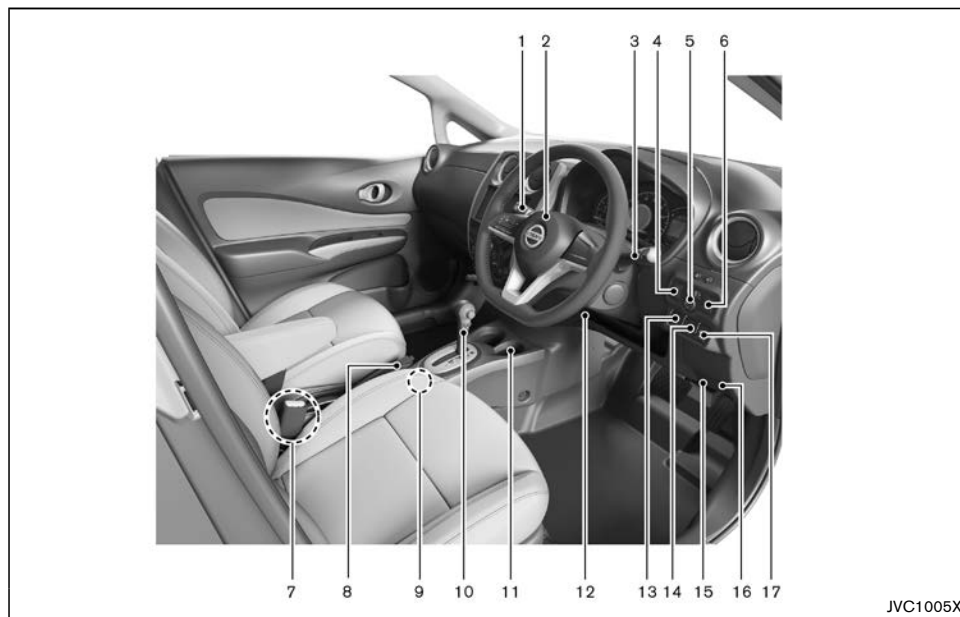

- | | |
|---|--|
| 1. Wiper and washer switch (P.2-21) | 4. Idling Stop OFF switch* (P.5-10) |
| 2. Steering wheel | 5. Outside mirror remote control switch (P.3-16) |
| — Electric power steering (P.5-23) | 6. Forward emergency braking system OFF switch* (P.5-19) or Idling Stop OFF switch* (P.5-10) |
| — Horn (P.2-23) | 7. Power outlet (P.2-26) |
| — Driver's supplemental front-impact air bag (P.1-23) | 8. Parking brake (P.3-17) |
| 3. Headlight, fog light and turn signal switch | 9. ECO mode switch* (P.5-20) |
| — Headlight and turn signal switch (P.2-18) | 10. Shift lever (P.5-8) |
| — Fog light switch* (P.2-20) | — Continuously Variable Transmission (CVT) (P.5-5) |

11. Front cup holders (P.2-27)
12. Tilting steering wheel lever (P.3-15)
13. Vehicle Dynamic Control (VDC) OFF switch* (P.5-12)
14. Headlight aiming control switch* (P.2-19)
15. Hood release handle (P.3-12)
16. Fuel-filler lid release handle (P.3-15)
17. Lane Departure Warning (LDW) switch* (P.5-16) or Vehicle Dynamic Control (VDC) OFF switch* (P.5-12)

*: if equipped

INSTRUMENT PANEL

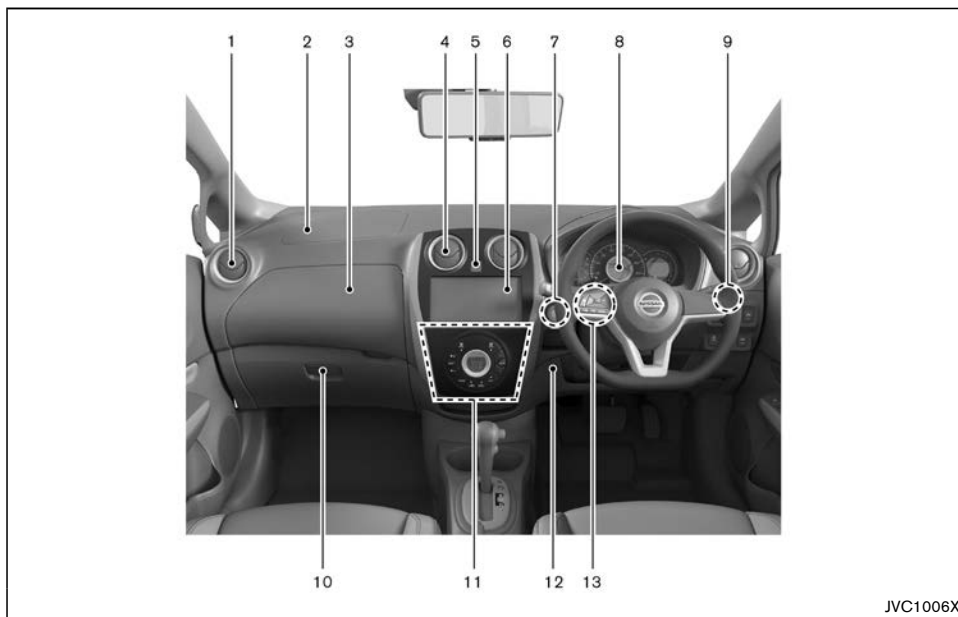

- | | |
|---|--|
| 1. Side ventilator (P.4-8) | 8. Meters and gauges (P.2-4) |
| 2. Passenger's front-impact air bag (P.1-23) | 9. Trip computer mode switch* (P.2-7)/Clock settings switch* (P.2-25) |
| 3. Upper instrument box (P.2-27)
— USB (Universal Serial Bus) Connection Port (P.4-23) | 10. Glove box (P.2-26) |
| 4. Center ventilator (P.4-8) | 11. Heater and air conditioner control (P.4-9)
— Rear window defogger switch (P.2-22) |
| 5. Hazard indicator flasher switch (P.6-2) | 12. Fuse box (P.8-19) |
| 6. Audio system* (P.4-14) | 13. Steering-wheel-mounted controls* (P.4-25) |
| 7. Push-button ignition switch (P.5-4) | *: if equipped |

METERS AND GAUGES

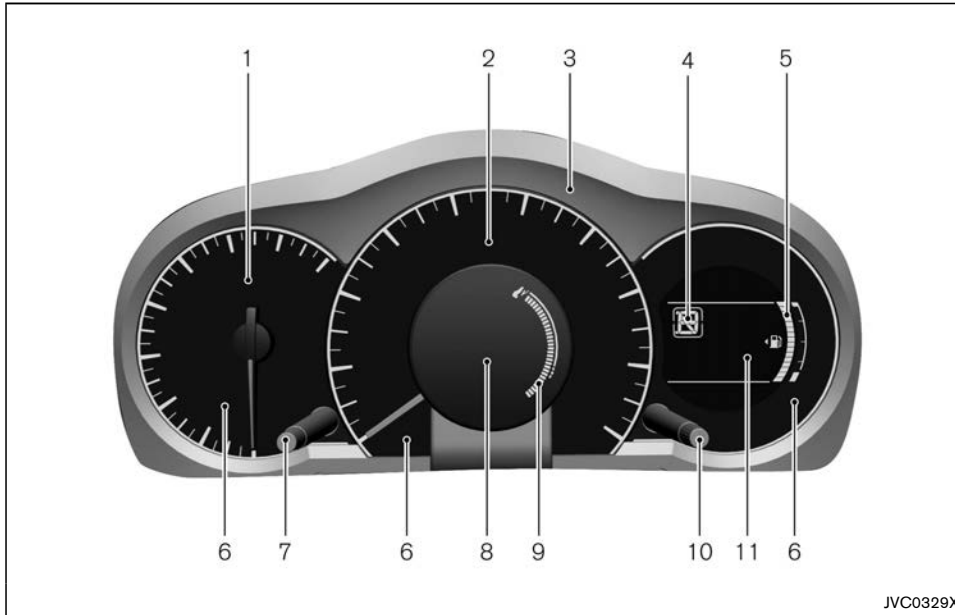

Type A

- | | |
|--|--|
| 1. Tachometer (P.2-8) | 8. Vehicle information display (P.2-6)
— Trip computer (P.2-7)
— Clock (P.2-25) |
| 2. Speedometer (P.2-6) | 9. ECO pedal guide (P.2-11) |
| 3. ECO drive indicator (P.2-10) | 10. Trip odometer switch (P.2-6)/Instrument brightness control switch (P.2-10)/Maintenance interval setting switch (P.2-8) |
| 4. Continuously Variable Transmission (CVT) position indicator (P.2-9) | 11. Odometer/Twin trip odometer (P.2-6)/Outside air temperature (P.2-10) |
| 5. Fuel gauge (P.2-9) | |
| 6. Warning/indicator lights (P.2-12) | |
| 7. ECO drive indicator switch (P.2-10)/ECO pedal guide switch (P.2-11) | |

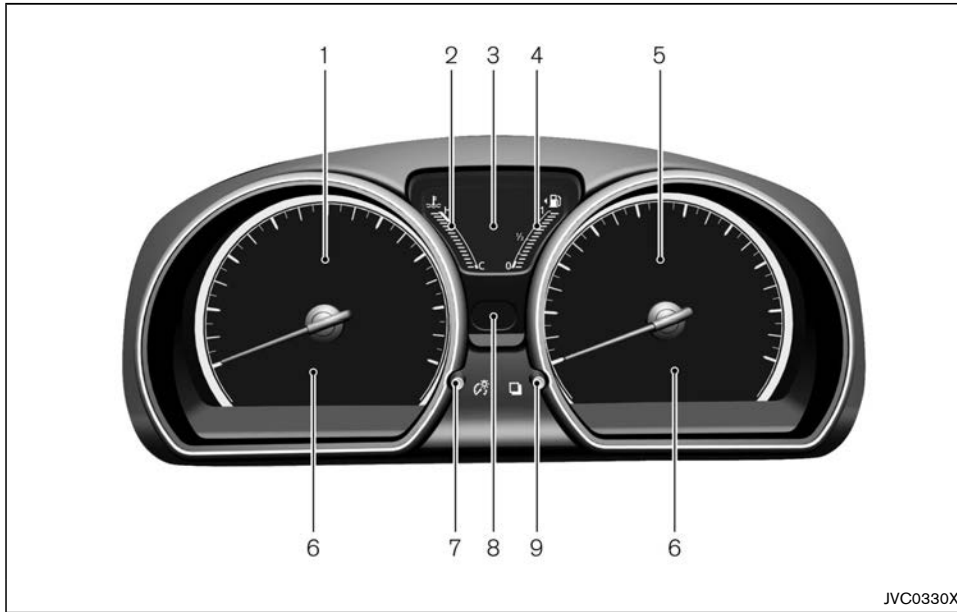

JVC0330X

Type B

- | | |
|--|--|
| <ol style="list-style-type: none"> 1. Tachometer (P.2-8) 2. Engine coolant temperature gauge (P.2-9) 3. Vehicle information display (P.2-6) <ul style="list-style-type: none"> — Odometer/Twin trip odometer (P.2-6) — Trip computer (P.2-7) — Clock (P.2-25) — Instrument brightness control display (P.2-10) — Outside air temperature* (P.2-8) | <ol style="list-style-type: none"> 4. Fuel gauge (P.2-9) 5. Speedometer (P.2-6) 6. Warning/indicator lights (P.2-12) 7. Instrument brightness control switch (P.2-10) 8. Continuously Variable Transmission (CVT) position indicator (P.2-9) 9. Trip odometer switch (P.2-6)/Trip computer mode switch (P.2-7)/Maintenance interval setting switch (P.2-8) |
|--|--|
- *: if equipped

ENGINE COMPARTMENT

HR12DE ENGINE MODEL

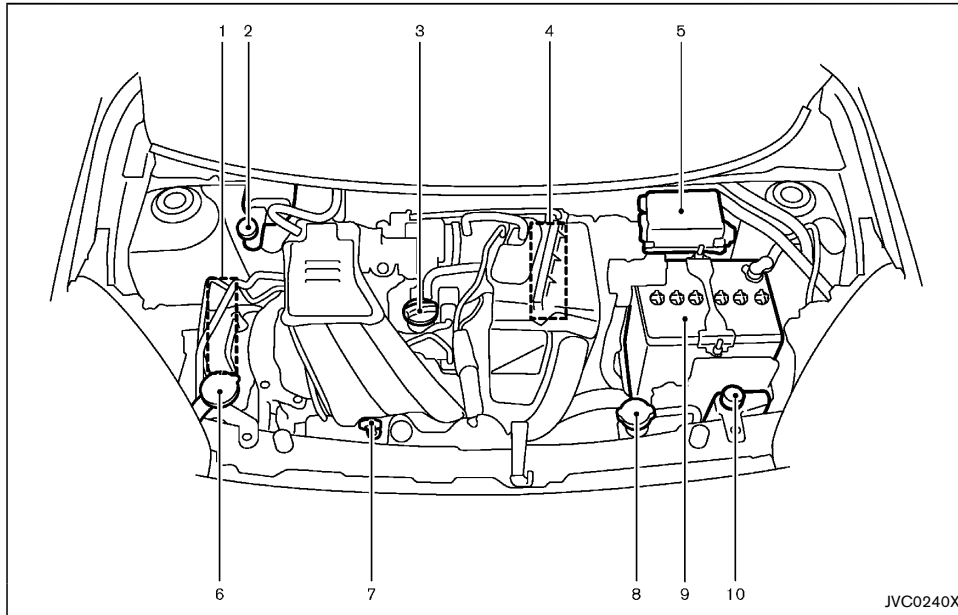

- | | |
|---|--------------------------------------|
| 1. Engine drive belts (P.8-10) | 8. Radiator cap (P.8-6) |
| 2. Brake fluid reservoir (P.8-12) | — Vehicle overheat (P.6-10) |
| 3. Engine oil filler cap (P.8-7) | 9. Battery (P.8-17) |
| 4. Air cleaner (P.8-13) | — Jump starting (P.6-8) |
| 5. Fuse/fusible link box (P.8-19) | 10. Engine coolant reservoir (P.8-7) |
| 6. Window washer fluid reservoir (P.8-15) | |
| 7. Engine oil dipstick (P.8-7) | |

HR12DDR ENGINE MODEL

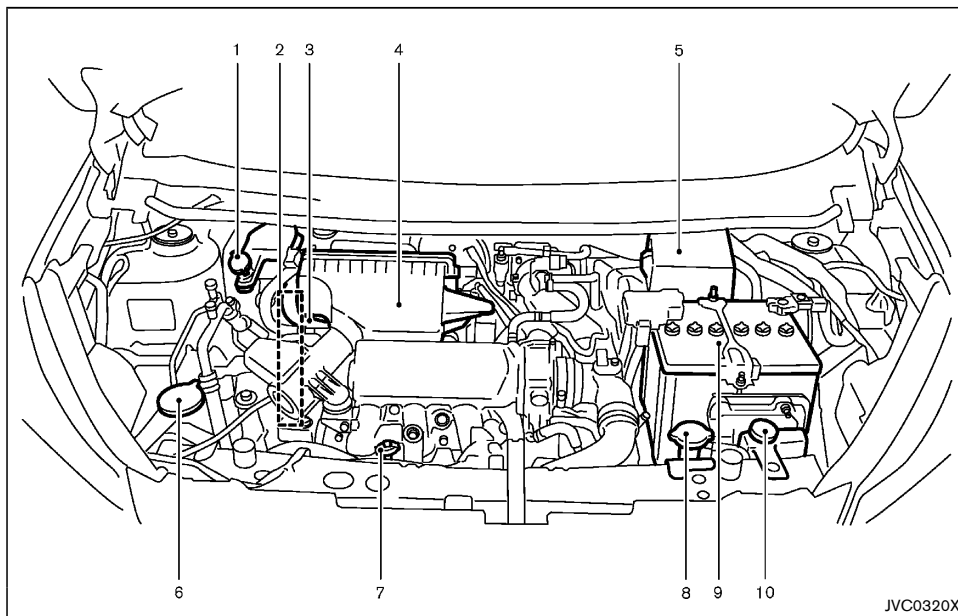

- | | |
|---|--------------------------------------|
| 1. Brake fluid reservoir (P.8-12) | 9. Battery (P.8-17) |
| 2. Engine drive belts (P.8-10) | — Jump starting (P.6-8) |
| 3. Engine oil filler cap (P.8-7) | 10. Engine coolant reservoir (P.8-7) |
| 4. Air cleaner (P.8-13) | |
| 5. Fuse/fusible link box (P.8-19) | |
| 6. Window washer fluid reservoir (P.8-15) | |
| 7. Engine oil dipstick (P.8-7) | |
| 8. Radiator cap (P.8-6) | |
| — Vehicle overheat (P.6-10) | |

MEMO

1 Safety — seats, seat belts and supplemental restraint system

Seats	1-2	Child restraints	1-12
Front seats	1-2	Precautions on child restraint usage	1-12
Rear seats	1-3	Universal child restraints for front seat and rear seats (for Thailand)	1-13
Head restraints	1-4	ISOFIX child restraint system	1-17
Adjustable head restraint	1-4	Child restraint anchorage	1-17
Non-adjustable head restraint	1-4	Child restraint installation using ISOFIX	1-18
Remove	1-5	Child restraint installation using seat belt	1-20
Install	1-5	Supplemental Restraint System (SRS)	1-23
Adjust	1-5	Precautions on Supplemental Restraint System (SRS)	1-23
Seat belts	1-6	Supplemental air bag systems	1-26
Precautions on seat belt usage	1-6	SRS air bag deployment conditions	1-27
Child safety	1-8	Pre-tensioner seat belt system	1-28
Pregnant women	1-9	Repair and replacement procedure	1-29
Injured persons	1-9		
Three-point type seat belts	1-9		
Seat belt maintenance	1-11		

SEATS

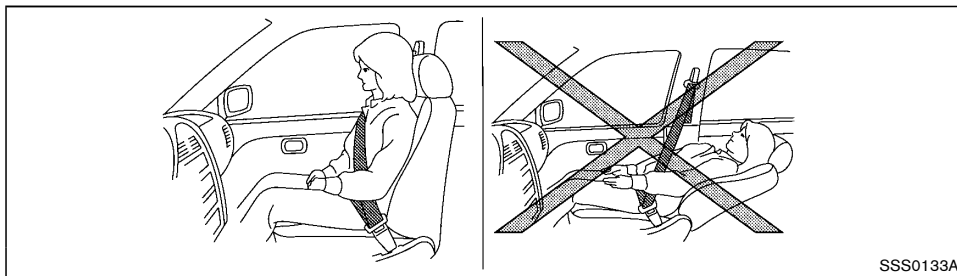

WARNING:

- Do not drive and/or ride in the vehicle with the seatback reclined. This can be dangerous. The shoulder belt will not be properly against the body. In an accident, you and your passengers could be thrown into the shoulder belt and receive neck or other serious injuries. You and your passengers could also slide under the lap belt and receive serious injuries.
- For the most effective protection while the vehicle is in motion, the seatback should be upright. Always sit well back and upright in the seat and adjust the seat belt properly. (See "Seat belts" (P.1-6).)
- Do not leave children unattended inside the vehicle. They could unknowingly activate switches or controls. Unattended children could become involved in serious accidents.
- To help avoid risk of injury or death through unintended operation of the vehicle and/or its systems, do not leave children, people who require the assistance of others or pets

unattended in your vehicle. Additionally, the temperature inside a closed vehicle on a warm day can quickly become high enough to cause a significant risk of injury or death to people and pets.

CAUTION:

When adjusting the seat positions, be sure not to contact any moving parts to avoid possible injuries and/or damages.

FRONT SEATS

WARNING:

Do not adjust the driver's seat while driving so that full attention may be given to vehicle operation.

Adjustment

WARNING:

After adjusting a seat, gently shake the seat to confirm that the seat is locked securely. If the seat is not locked securely, it may move suddenly and could cause the loss of control of the vehicle.

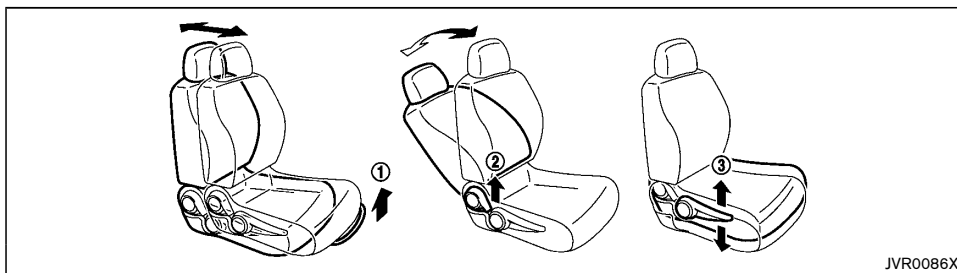

Forward and backward:

1. Pull up the adjusting lever ①.
2. Slide the seat to the desired position.
3. Release the adjusting lever to lock the seat in position.

Reclining:

1. Pull up the adjusting lever ②.
2. Tilt the seatback to the desired position.
3. Release the adjusting lever to lock the seatback in position.

The reclining feature allows the adjustment of the seatback for occupants of different sizes to help obtain the proper seat belt fit. (See "Seat belts" (P.1-6).)

The seatback may be reclined to allow occupants to rest when the vehicle is parked.

Seat lifter (if equipped):

Pull up or push down the adjusting lever ③ to adjust the seat height until the desired position is achieved.

REAR SEATS

Adjustment



WARNING:

- **Never allow anyone to ride in the luggage area or on the rear seats when they are in the fold-down position. Use of these areas by passengers without proper restraints could result in serious injury in an accident or sudden stop.**
- **Do not fold down the rear seats when occupants are in the rear seat area or any luggage is on the rear seats.**
- **Properly secure all luggage to help prevent it from sliding or shifting. Do not place luggage higher than the seatbacks.**
- **When returning the seatbacks to the upright position, be certain they are completely secured in the latched position. If they are not completely secured, passengers may be injured in an accident or sudden stop.**

Folding:

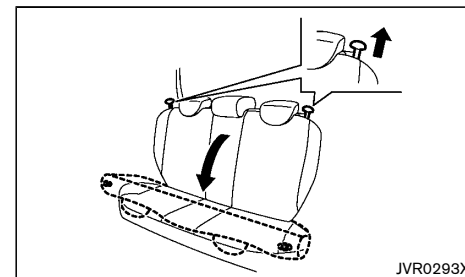

Type A

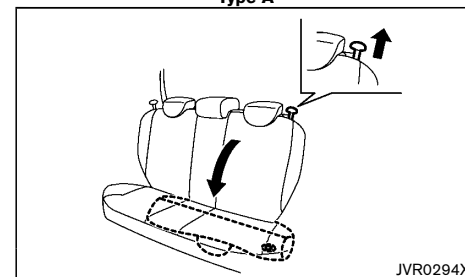

Type B

1. Store the seat belts in the proper position.
 - Secure the seat belts on the seat belt hooks on the side wall. (See "Seat belt hooks" (P.1-10).)
 - Disconnect and store the center seat belt and tongue into the retractor base. (See "Rear center seat belt" (P.1-10).)
2. Pull the knob to fold the seatback down.

HEAD RESTRAINTS

⚠ CAUTION:

- When loading the luggage in the luggage room, be careful not to scratch or damage the seat belt.

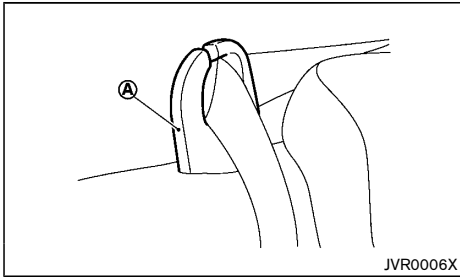

- If the rear seatback needs to be folded without passing the seat belt through the path **A**, be sure to observe the following items.
 - After returning the rear seatback to its original position, pass the seat belt through the path **A**.
 - When operating the seatback, be careful not to scratch or damage the seat belt.

⚠ WARNING:

Head restraints supplement the other vehicle safety systems. They may provide additional protection against injury in certain rear end collisions. Adjustable head restraints must be adjusted properly, as specified in this section. Check the adjustment after someone else uses the seat. Do not attach anything to the head restraint stalks or remove the head restraint. Do not use the seat if the head restraint has been removed. If the head restraint was removed, reinstall and properly adjust the head restraint before an occupant uses the seating position. Failure to follow these instructions can reduce the effectiveness of the head restraint. This may increase the risk of serious injury or death in a collision.

- Your vehicle is equipped with a head restraint that may be integrated, adjustable or non-adjustable.
- Adjustable head restraints have multiple notches along the stalk to lock them in a desired adjustment position.
- The non-adjustable head restraints have single locking notch to secure them to the seat frame.
- Proper Adjustment:
 - For the adjustable type, align the head restraint so the center of your ear is approximately level with the center of the head restraint.
 - If your ear position is still higher than the recommended alignment, place the head restraint at the highest position.
- If the head restraint has been removed, ensure that it is reinstalled and locked in place before riding in that designated seating position.

ADJUSTABLE HEAD RESTRAINT

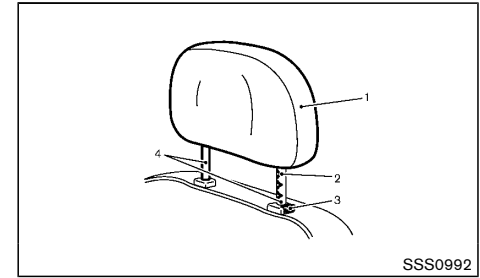

1. Removable head restraint
2. Multiple notches
3. Lock knob
4. Stalks

NON-ADJUSTABLE HEAD RESTRAINT

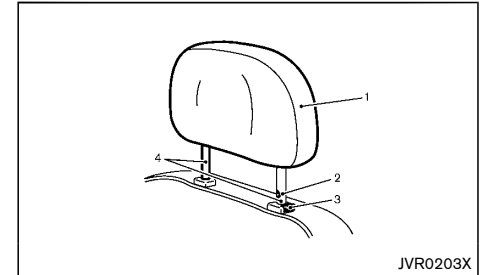

1. Removable head restraint
2. Single notch
3. Lock knob

4. Stalks

REMOVE

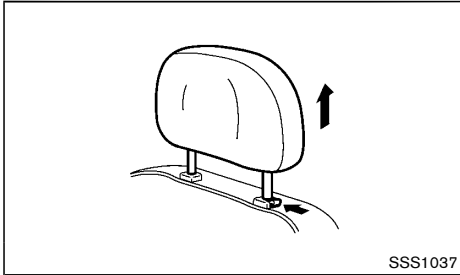

Use the following procedure to remove the head restraint.

1. Pull the head restraint up to the highest position.
2. Push and hold the lock knob.
3. Remove the head restraint from the seat.
4. Store the head restraint properly in a secure place so it is not loose in the vehicle.
5. Reinstall and properly adjust the head restraint before an occupant uses the seating position.

INSTALL

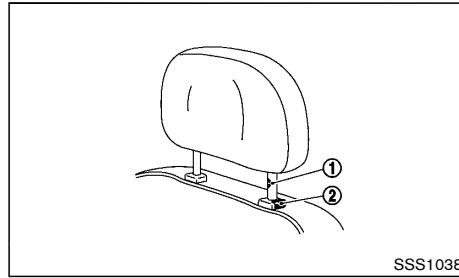

1. Align the head restraint stalks with the holes in the seat. Make sure that the head restraint is facing the correct direction. The stalk with the adjustment notch ① must be installed in the hole with the lock knob ②.
2. Push and hold the lock knob and push the head restraint down.
3. Properly adjust the head restraint before an occupant uses the seating position.

ADJUST

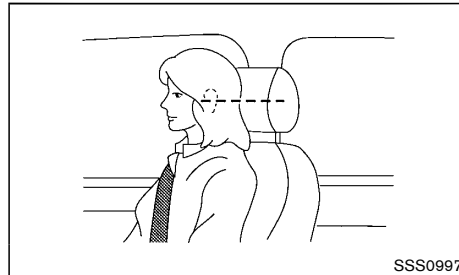

For adjustable head restraint

Adjust the head restraint so the center is level with the center of your ears. If your ear position is still higher than the recommended alignment, place the head restraint at the highest position.

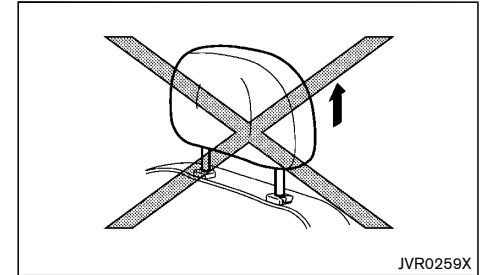

For non-adjustable head restraint

Make sure the head restraint is positioned from the stored position or any non-latch position so the lock knob is engaged in the notch before riding in that designated seating position.

Raise

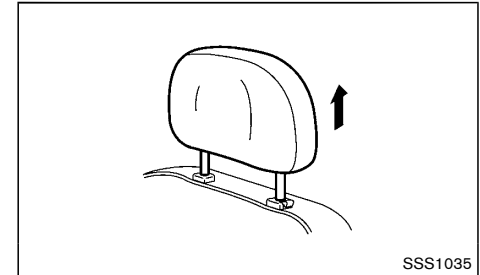

To raise the head restraint, pull it up.

SEAT BELTS

Make sure the head restraint is positioned from the stored position or any non-latch position so the lock knob is engaged in the notch before riding in that designated seating position.

Lower

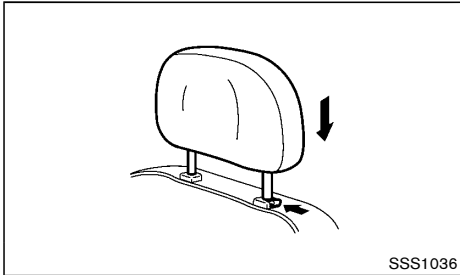

To lower, push and hold the lock knob and push the head restraint down.

Make sure the head restraint is positioned so the lock knob is engaged in the notch before riding in that designated seating position.

PRECAUTIONS ON SEAT BELT USAGE

If you are wearing the seat belt properly adjusted and sitting upright and well back in the seat, chances of being injured or killed in an accident and/or the severity of injury may be greatly reduced. NISSAN strongly encourages you and all of your passengers to buckle up every time you drive, even if your seating position includes the supplemental air bag systems.

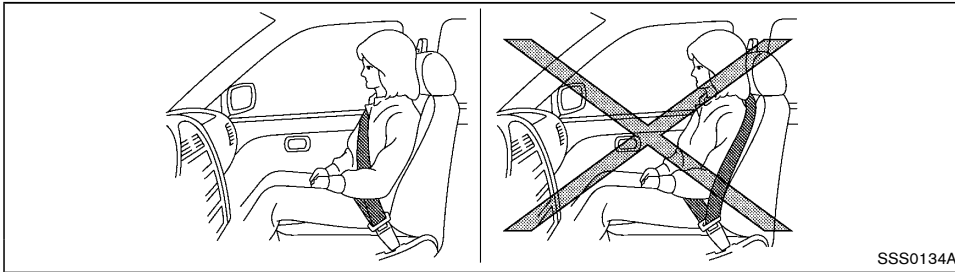

SSS0134A

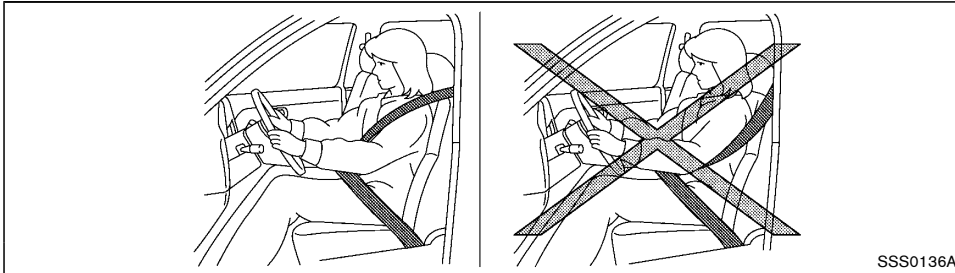

SSS0136A

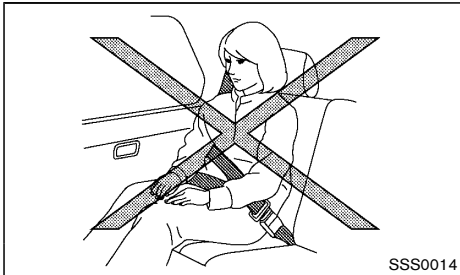

SSS0014

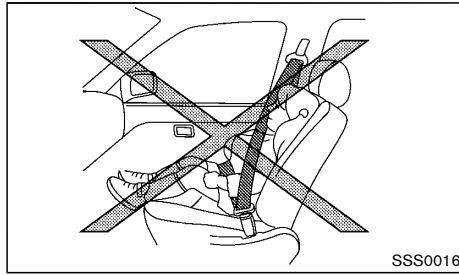

SSS0016

⚠ WARNING:

- Seatbelts are designed to bear upon the bony structure of the body, and should be worn low across the front of the pelvis or the pelvis, chest and shoulders, as applicable; wearing the lap section of the belt across the abdominal area must be avoided. Serious injury may occur if a seat belt is not worn properly.
- Position the lap belt as low and snug as possible around the hips, not the waist. A lap belt worn too high could increase the risk of internal injuries in an accident.
- Do not allow more than one person to use the same seat belt. Each belt assembly must only be used by one occupant; it is dangerous to put a belt around a child being carried on the occupant's lap.
- Never carry more people in the vehicle than there are seat belts.
- Never wear seat belts inside out. Belts should not be worn with straps twisted. Doing so may reduce their effectiveness.
- Seatbelts should be adjusted as firmly as possible, consistent with comfort, to provide the protection for which they have been designed. A slack belt will greatly reduce the protection afforded to the wearer.
- Every person who drives or rides in this vehicle should use a seat belt at all times. Children should be properly restrained in the rear seat and, if appropriate, in a child restraint system.

- Do not put the belt behind your back or under your arm. Always route the shoulder belt over your shoulder and across your chest. The belt should be away from your face and neck, but not falling off your shoulder. Serious injury may occur if a seat belt is not worn properly.
- No modifications or additions should be made by the user which will either prevent the seat belt adjusting devices from operating to remove slack, or prevent the seat belt assembly from being adjusted to remove slack.
- Care should be taken to avoid contamination of the webbing with polishes, oils and chemicals, and particularly battery acid. Cleaning may safely be carried out using mild soap and water. The belt should be replaced if webbing becomes frayed, contaminated or damaged.
- All seat belt assemblies including retractors and attaching hardware should be inspected after any collision by a NISSAN dealer. NISSAN recommends that all seat belt assemblies in use during a collision be replaced unless the collision was minor and the belts show no damage and continue to operate properly. Seat belt assemblies not in use during a collision should also be inspected and, when necessary, replaced if either damage or improper operation is noted.
- It is essential to replace the entire assembly after it has been worn in a severe impact even if damage to the assembly is not obvious.

- Once the pre-tensioner seat belt has activated, it cannot be reused. It must be replaced together with the retractor. Contact a NISSAN dealer.
- Removal and installation of the pre-tensioner seat belt system components should be done by a NISSAN dealer.

CHILD SAFETY



WARNING:

- Infants and children need special protection. The vehicle's seat belts may not fit them properly. The shoulder belt may come too close to the face or neck. The lap belt may not fit over their small hipbones. In an accident, an improperly fitted seat belt could cause serious or fatal injury.
- Always use an appropriate child restraint system.

Children need adults to help protect them. They need to be properly restrained. The proper restraint depends on the child's size.

Infants and small children

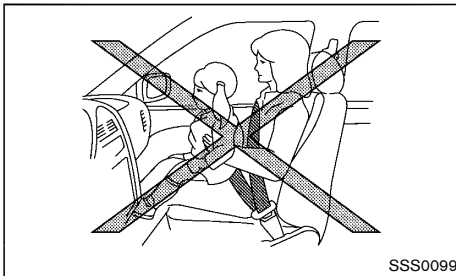

SSS0099

NISSAN recommends that infants and small children be seated in a child restraint system. You should choose a child restraint system that fits your vehicle and the child, and always follow the manufacturer's instructions for installation and use.

Large children



WARNING:

- Never allow children to stand or kneel on any seats.
- Never allow children in the luggage area while the vehicle is moving. A child could be seriously injured in an accident or sudden stop.

Children who are too large for a child restraint system should be seated and restrained by the seat belts that are provided.

If the child's seating position has a shoulder belt that fits close to the face or neck, the use of a booster seat (commercially available) may help overcome this. The booster seat should raise the child so that the shoulder belt is properly positioned across the top, middle portion of the shoulder and the lap belt is low on the hips. The booster seat should also fit the vehicle seat. Once the child has grown so that the shoulder belt is no longer on or near the face or neck of the child, use the shoulder belt without the booster seat. In addition, there are many types of child restraint systems available for larger children that should be used for maximum protection.

PREGNANT WOMEN

NISSAN recommends that pregnant women use seat belts. The seat belt should be worn snug, and always position the lap belt as low as possible around the hips, not the waist. Place the shoulder belt over your shoulder and across your chest. Never run the lap/shoulder belt over your abdominal area. Contact your doctor for specific recommendations.

INJURED PERSONS

NISSAN recommends that injured persons use seat belts. Contact your doctor for specific recommendations.

THREE-POINT TYPE SEAT BELTS

Fastening seat belts

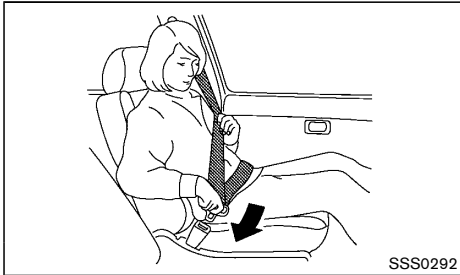

WARNING:

The seatback should not be in a reclined position any more than needed for comfort. Seat belts are most effective when the passenger sits well back and straight up in the seat.

1. Adjust the seat. (See "Seats" (P.1-2).)
2. Slowly pull the seat belt out of the retractor and insert the tongue into the buckle until you hear and feel the latch engage.
 - **The retractor is designed to lock during a sudden stop or on impact. A slow pulling motion permits the belt to move, and allows you some freedom of movement in the seat.**
 - **If the seat belt cannot be pulled from its fully retracted position, firmly pull the belt and release it. Then smoothly pull the belt out of the retractor.**

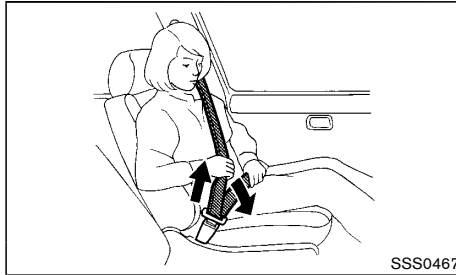

3. Position the lap belt portion low and snug on the hips as shown.
4. Pull the shoulder belt portion toward the retractor to take up extra slack. Be sure the shoulder belt is routed over your shoulder and is snug across your chest.

Shoulder belt height adjustment (front seats)

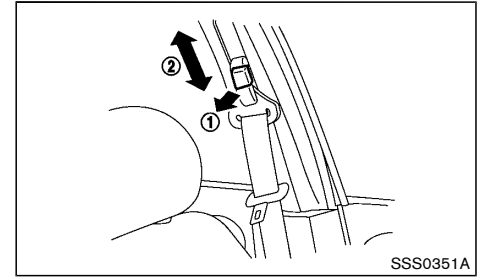

WARNING:

- **The shoulder belt anchor height should be adjusted to the position best for you. Failure to do so may reduce the effectiveness of the entire restraint system and increase the chance or severity of injury in an accident.**
- **The shoulder belt should rest on the middle of the shoulder. It must not rest against the neck.**
- **Be sure that the seat belt is not twisted in any way.**
- **Be sure that the shoulder belt anchor is secured by trying to move the shoulder belt anchor up and down after adjustment.**

The shoulder belt anchor height should be adjusted to the position best for you.

The belt should be away from your face and neck, but not falling off your shoulder.

To adjust, pull the release button ① and move the shoulder belt anchor to the proper position ②, so that the belt passes over the center of the shoulder.

Release the button to lock the shoulder belt anchor into position.

Unfastening seat belts

Push the button on the buckle. The seat belt automatically retracts.

Seat belt hooks

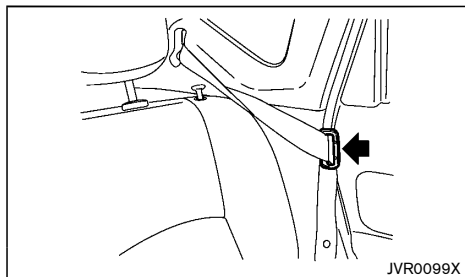

Hook the seat belt at the seat belt hooks when folding down the rear seat.

Checking seat belt operation

Seat belt retractors are designed to lock seat belt movement:

- When the seat belt is pulled quickly from the retractor.
- When the vehicle slows down rapidly.

To increase your confidence in the seat belts, check the operation by grasping the shoulder belt and pulling forward quickly. The retractor should lock and restrict further belt movement. If the retractor does not lock during this check, contact a NISSAN dealer immediately.

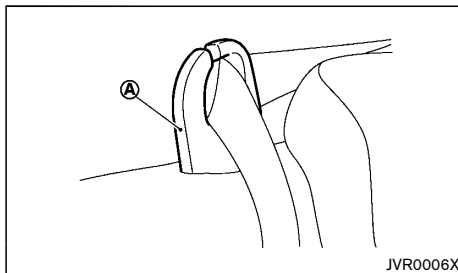

Rear center seat belt

 **CAUTION:**

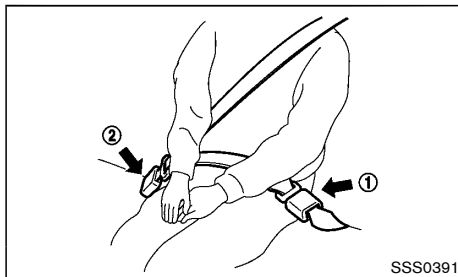

Make sure to wear the rear center seat belt with the seat belt passing through the path .



The rear center seat belt has a connector tongue  and a seat belt tongue . Both the connector tongue and the seat belt tongue must be securely latched for proper seat belt operation.

NOTE:

When fastening the rear center seat belt while the seatback of the right-hand seat is in the folded position, pull out seat belt tongue  passing it underneath the folded seatback, and then fasten the seat belt.

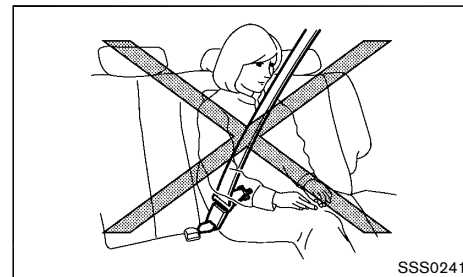

 **WARNING:**

- **Always fasten the connector tongue and the seat belt in the order shown.**
- **Always make sure both the connector tongue and the seat belt tongue are secured when using the seat belt. Do not use it with only the seat belt tongue attached. This could result in serious personal injury in case of an accident or a sudden stop.**

Stowing rear center seat belt:

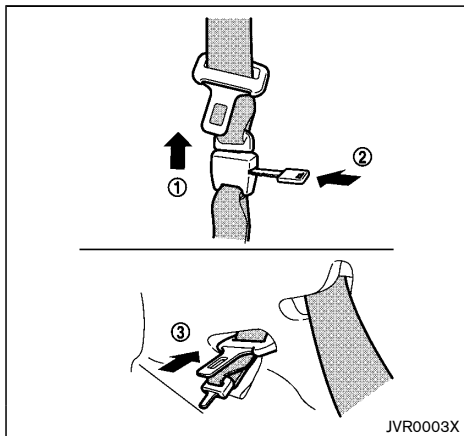

When folding down the rear seat, the rear center seat belt can be retracted into a stowed position.

1. Hold the connector tongue (1) so that the seat belt does not retract suddenly when the tongue is released from the connector buckle. Release the connector tongue by inserting a suitable tool such as key (2) into the connector buckle.
2. Remove the seat belt from the path (A).
3. Retract the seat belt and store the seat belt tongue and connector tongue on the stowed position (3).



WARNING:

- Do not unfasten the rear center seat belt connector except when folding down the rear seat.

Attaching rear center seat belt:

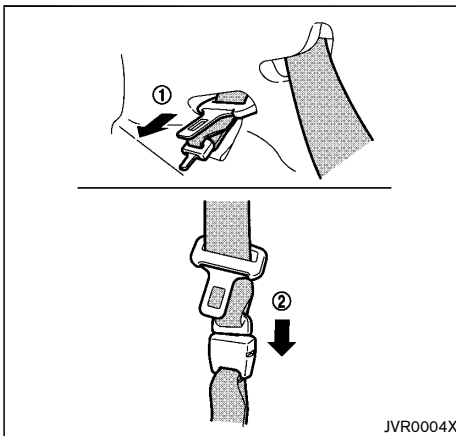

Always be sure the rear center seat belt connector tongue and connector buckle are attached. Disconnect only when folding down the rear seat.

To connect the buckle:

1. Pull the seat belt tongue and connector tongue from the stowed position (1).
2. Install the seat belt to the path (A).
3. Pull the seat belt and secure the connector buckle until it clicks (2).

The center seat belt buckle is identified by the CENTER mark. The center seat belt tongue can be fastened only into the center seat belt buckle.

To fasten the seat belt, see "Fastening seat belts" (P.1-9).



WARNING:

- When attaching the rear center seat belt connector, be certain that the seatbacks are completely secured in the latched position and the rear center seat belt connector is completely secured.
- If the rear center seat belt connector and the seatbacks are not secured in the correct position, serious personal injury may result in an accident or sudden stop.

SEAT BELT MAINTENANCE

Periodically check that the seat belt and all the metal components, such as buckles, tongues, retractors, flexible wires and anchors, work properly. If loose parts, deterioration, cuts or other damage on the seat belt webbing is found, the entire seat belt assembly should be replaced.

If dirt builds up in the shoulder belt guide of the seat belt anchors, the seat belts may retract slowly. Wipe the shoulder belt guide with a clean, dry cloth.

To clean the seat belt webbing, apply a mild soap solution or any solution recommended for cleaning upholstery or carpet. Then wipe with a cloth and allow the seat belts to dry in the shade. Do not allow the seat belts to retract until they are completely dry.

CHILD RESTRAINTS

PRECAUTIONS ON CHILD RESTRAINT USAGE

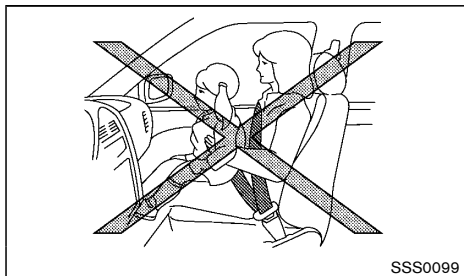

WARNING:

- Infants and small children should never be carried on your lap. It is not possible for even the strongest adult to resist the forces of a severe accident. The child could be crushed between the adult and parts of the vehicle. Also, it is dangerous to put a seat belt around a child being carried on the occupant's lap.
- Infants and children need special protection. The vehicle's seat belts may not fit them properly. The shoulder belt may come too close to the face or neck. The lap belt may not fit over their small hip bones. In an accident, an improperly fitting seat belt could cause serious or fatal injury.
- Infants and small children should always be placed in an appropriate child restraint system while riding in the vehicle. Failure to use a child restraint system can result in serious injury or death.

- Child restraint systems specially designed for infants and small children are available from several manufacturers. When selecting any child restraint systems, place your child in the child restraint system and check the various adjustments to be sure that the child restraint system is compatible with your child. Always follow the manufacturer's instructions for installation and use.
- NISSAN recommends that the child restraint system be installed in the rear seat. According to accident statistics, children are safer when properly restrained in the rear seat rather than in the front seat.
- Follow all of the child restraint system manufacturer's instructions for installation and use. When purchasing a child restraint system, be sure to select one which will fit your child and vehicle. It may not be possible to properly install some types of child restraint systems in your vehicle.
- For a front-facing child restraint system, check to make sure the shoulder belt does not fit close to child's face or neck. If it does, put the shoulder belt behind the child restraint system.
- Never install a rear-facing child restraint system in the front seat. An inflating supplemental front-impact air bag could seriously injure or kill your child. A rear-facing child restraint system must only be used in the rear seat.
- Adjustable seatbacks should be positioned to fit a child restraint system, but as upright as possible.

- If the seat belt in the position where a child restraint system is installed requires a locking clip and if it is not used, injuries could result from a child restraint system tipping over during normal vehicle braking or cornering.
- After attaching a child restraint system, test it before you place the child in it. Tilt it from side to side. Try to tug it forward and check if it is held securely in place. The child restraint system should not move more than 25 mm (1 in). If the restraint is not secure, tighten the belt as necessary, or install the restraint in another seat and test it again.
- Check the child restraint system in your vehicle to be sure that it is compatible with the vehicle's seat belt system.
- If a child restraint system is not anchored properly, the risk of a child being injured in a collision or a sudden stop greatly increases.
- Improper use of a child restraint system can increase the risk or severity of injury for both the child and other occupants in the vehicle.
- Always use an appropriate child restraint system. An improperly installed child restraint system could lead to serious injury or death in an accident.
- When the child restraint system is not in use, keep it secured with a seat belt to prevent it from being thrown around in case of a sudden stop or accident.

NISSAN recommends that infants and small children be seated in a child restraint system. You should choose a child restraint system that fits your vehicle and always follow the manufacturer's instructions for installation and use. In addition, there are many types

of child restraint systems available for larger children that should be used for maximum protection.



CAUTION:

Remember that a child restraint system left in a closed vehicle can become very hot. Check the seating surface and buckles before placing your child in a child restraint system.

UNIVERSAL CHILD RESTRAINTS FOR FRONT SEAT AND REAR SEATS (for Thailand)

When selecting any child restraint, keep the following points in mind:

- Place your child in the child restraint and check the various adjustments to be sure the child restraint is compatible with your child. Always follow all of the recommended procedures.
- Check the child restraint in your vehicle to be sure it is compatible with vehicle's seat belt system.
- Refer to the tables later in this section for a list of the recommended fitment positions and the approved child restraints for your vehicle.

Mass group of child seat

Mass group	Child's weight
Group 0	up to 10 kg
Group 0+	up to 13 kg
Group I	9 to 18 kg
Group II	15 to 25 kg
Group III	22 to 36 kg

Kind of child seats (example):

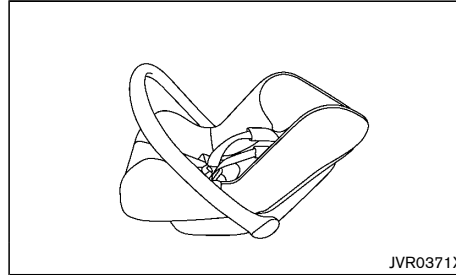

Child safety seat categories 0 and 0+

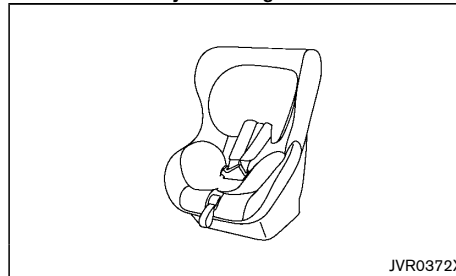

Child safety seat categories 0+ and I

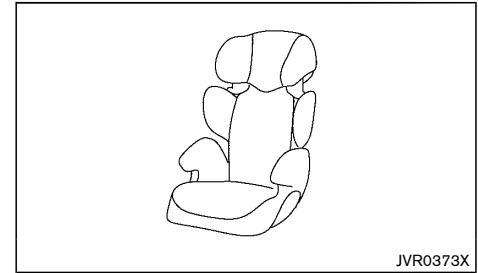

Child safety seat categories II and III

1) Child seat installation using the vehicle's seat belt

This is a regulatory table, indicating seat belt and universally approved child seats for various approved seating positions.

Mass Group		Seating position		
		Front passenger	Rear Outboard seat	Rear Centre seat
0	<10 kg	X	X	U
0 +	<13 kg	X	L	U
I	9 - 18 kg	UF*1, 2	UF*1	U*1
II	15 - 25 kg	UF*1, 2	UF*1	UF*1
III	22 - 36 kg	UF*1, 2	UF*1	UF*1

U: Suitable for "universal" category restraints, forward and rearward facing, approved for use in this mass group.

UF: Suitable for forward facing "universal" category restraints approved for use in this mass group.

L: Suitable for particular child restraints shown by table 2) or those which are shown in CRS manufacturer vehicle list.

X: Seat position not suitable for children in this mass group.

*1: If you install the child seat, remove the head restraint.

*2: If you install the child seat, set the front passenger seat to the most rearward side position.

2) List of child seats recommended by NISSAN, secured using three-point type seat belt

Please carefully read installation manual of your child seat.

Mass group		Seating position					
		Front passenger		Rear Outboard seat		Rear Centre seat	
0	<10 kg	-	-	-	-	-	-
0+	<13 kg	-	-	Combi Malgot	Belted Rearward Facing	Combi Malgot	Belted Rearward Facing
I	9 - 18 kg	Combi Malgot	Belted Forward Facing	Combi Malgot	Belted Forward Facing	Combi Malgot	Belted Forward Facing
II	15 - 25 kg	Combi Malgot	Belted Forward Facing	Combi Malgot	Belted Forward Facing	Combi Malgot	Belted Forward Facing
II	15 - 25 kg	Combi Buon Junior Air	Belted Forward Facing	Combi Buon Junior Air	Belted Forward Facing	Combi Buon Junior Air	Belted Forward Facing
III	22 - 36 kg	Combi Buon Junior Air	Belted Forward Facing	Combi Buon Junior Air	Belted Forward Facing	Combi Buon Junior Air	Belted Forward Facing

3) Child seat installation using ISOFIX

This is a regulatory table, indicating ISOFIX and semi-universally approved ISOFIX child seats for various approved seating positions.

Mass Group		Size Class	Fixture	Seating position		
				Front passenger	Rear Outboard seat	Rear Centre seat
Carrycot		F	ISO/L1	X	X	X
		G	ISO/L2	X	X	X
0	<10 kg	E	ISO/R1	X	IL	X
0+	<13 kg	E	ISO/R1	X	IL	X
		D	ISO/R2	X	IL	X
		C	ISO/R3	X	IL	X
I	9 - 18 kg	D	ISO/R2	X	IL	X
		C	ISO/R3	X	IL	X
		B	ISO/F2	X	IUF*1	X
		B1	ISO/F2X	X	IUF*1	X
		A	ISO/F3	X	IUF*1	X
II	15 - 25 kg	-	-	X	IL*1	X
III	22 - 36 kg	-	-	X	IL*1	X

X: ISOFIX position not suitable for installation of ISOFIX child restraint systems (CRS) in these seating positions.

IUF: Suitable for ISOFIX forward facing CRS of universal category approved for use in the mass group.

IL: Suitable for particular child restraints shown by table 4) or those which are shown in CRS manufacturer vehicle list.

*1: If you install the child seat, remove the head restraint.

4) List of child seats recommended by NISSAN, secured using ISOFIX

Please carefully read installation manual of your child seat.

Mass group		Seating position					
		Front passenger		Rear Outboard seat		Rear Center seat	
0	<10 kg	-	-	-	-	-	-
0+	<13 kg	-	-	Romer Baby safe plus SHR II	ISOFIX & Support Leg Rearward Facing	-	-
0+	<13 kg	-	-	Maxi Cosi Milofix	ISOFIX & Strap Rearward Facing	-	-
I	9 - 18 kg	-	-	Maxi Cosi Milofix	ISOFIX & Strap Forward Facing	-	-
I	9 - 18 kg	-	-	Romer Duo Plus	ISOFIX & Strap Forward Facing	-	-
II	15 - 25 kg	-	-	Britax Parkway SGL	Beled & ISOFIX Forward Facing	-	-
III	22 - 36 kg	-	-	Britax Parkway SGL	Beled & ISOFIX Forward Facing	-	-

ISOFIX CHILD RESTRAINT SYSTEM

Your vehicle is equipped with special anchor points that are used with ISOFIX child restraint systems.

ISOFIX lower anchor point locations

The ISOFIX anchor points are provided to install child restraints in the rear outboard seating positions only. **Do not attempt to install a child restraint in the center position using the ISOFIX anchors.**

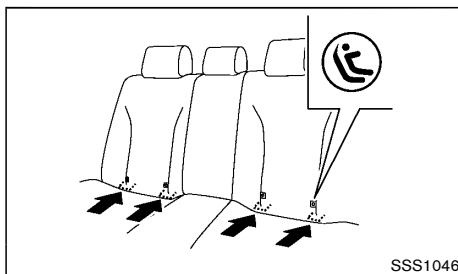

ISOFIX label location

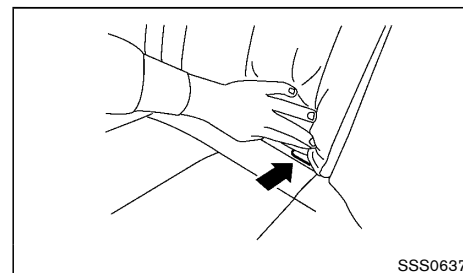

ISOFIX lower anchor location

The ISOFIX anchors are located at the rear of the seat cushion near the seatback. A label is attached to the seatback to help you locate the ISOFIX anchors.

CHILD RESTRAINT ANCHORAGE

Your vehicle is designed to accommodate a child restraint system on the rear seat. When installing a child restraint system, carefully read and follow the instructions in this manual and those supplied with the child restraint system.



WARNING:

- **Child restraint anchorages are designed to withstand only those loads imposed by correctly fitted child restraints. Under no circumstances are they to be used for adult seat belts, harnesses or for attaching other items or equipment to the vehicle. Doing so could damage the child restraint anchorages. The child restraint will not be properly installed using the damaged anchorage, and a child could be seriously injured or killed in a collision.**

- The child restraint top tether strap may be damaged by contact with the items in the luggage area. Your child could be seriously injured or killed in a collision if the top tether strap is damaged.

Anchorage location

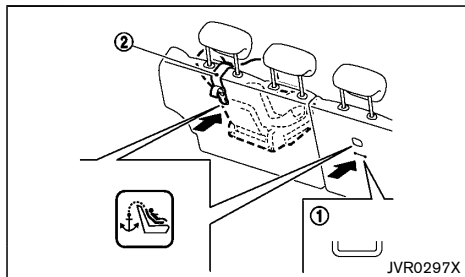

The anchor points ① are located on the seat behind the rear seats outboard seating positions.

CAUTION:

- Pull up the rear head restraint to raise to the proper position and make sure it is securely locked.
- Depending on the shape of the child restraint system, either the child restraint system or the child restraint top tether strap ② may interfere with the head restraint. When this occurs, remove the head restraint and then install the child restraint system.

CHILD RESTRAINT INSTALLATION USING ISOFIX

WARNING:

- Attach ISOFIX child restraints only at the specified locations. For the ISOFIX lower anchor locations, see “ISOFIX child restraint system” (P.1-17). If a child restraint is not secured properly, your child could be seriously injured or killed in an accident.
- Do not install child restraints that require the use of a top tether strap to seating positions that do not have a top tether anchor.
- Do not secure a child restraint in the center rear seating position using the ISOFIX lower anchors. The child restraint will not be secured properly.
- Inspect the lower anchors by inserting your fingers into the lower anchor area and feeling to make sure there are no obstructions over the ISOFIX anchors, such as seat belt webbing or seat cushion material. The child restraint will not be secured properly if the ISOFIX anchors are obstructed.
- Child restraint anchorages are designed to withstand only those loads imposed by correctly fitted child restraints. Under no circumstances are they to be used for adult seat belts, harnesses or for attaching other items or equipment to the vehicle. Doing so could damage the child restraint anchorages. The child restraint will not be properly installed using the damaged anchorage, and a child could be seriously injured or killed in a collision.

Installation on rear outboard seats

Front-facing:

Be sure to follow the manufacturer's instructions for the proper use of your child restraint. Follow these steps to install a front-facing child restraint on the rear outboard seats using ISOFIX:

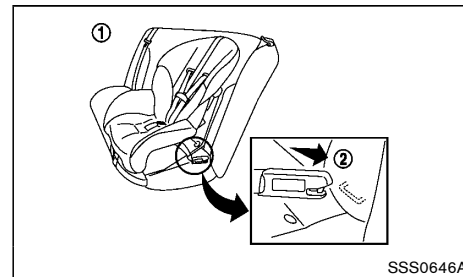

Steps 1 and 2

1. Position the child restraint on the seat ①.
2. Secure the child restraint anchor attachments to the ISOFIX lower anchors ②.
3. The back of the child restraint should be secured against the vehicle seatback. If necessary, adjust or remove the head restraint to obtain the correct child restraint fit. (See “Head restraints” (P.1-4).) If the head restraint is removed, store it in a secure place. Be sure to install the head restraint when the child restraint is removed. If the seating position does not have an adjustable head restraint and it is interfering with the proper child restraint fit, try another seating position or a different child restraint.

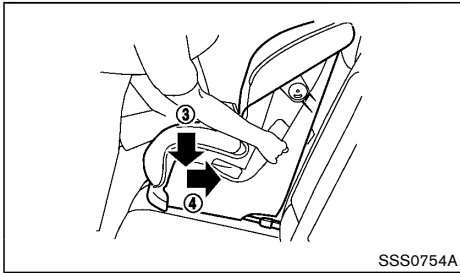

Step 4

4. Shorten the rigid attachment to have the child restraint firmly tightened; press downward (3) and rearward (4) firmly in the center of the child restraint with your knee to compress the vehicle seat cushion and seatback.
5. If the child restraint is equipped with a top tether strap, route the top tether strap and secure the tether strap to the tether anchor point. (See "Child restraint anchorage" (P.1-17).)
6. If the child restraint is equipped with other anti-rotation devices such as support legs, use them instead of the top tether strap following the child restraint manufacturer's instructions.

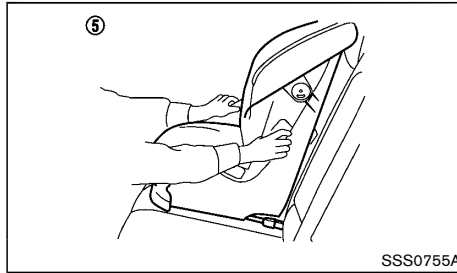

Step 7

7. Test the child restraint before you place the child in it (5). Push the child restraint from side to side and tug it forward to make sure that it is held securely in place.
8. Check to make sure that the child restraint is properly secured prior to each use. If the child restraint is loose, repeat steps 3 through 7.

Rear-facing:

Be sure to follow the manufacturer's instructions for the proper use of your child restraint. Follow these steps to install a rear-facing child restraint on the rear outboard seats using ISOFIX:

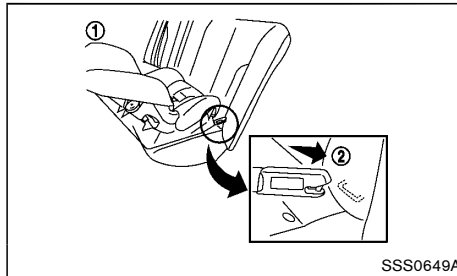

Steps 1 and 2

1. Position the child restraint on the seat (1).
2. Secure the child restraint anchor attachments to the ISOFIX lower anchors (2).



Step 3

3. Shorten the rigid attachment to have the child restraint firmly tightened; press downward (3) and rearward (4) firmly in the center of the child restraint with your hand to compress the vehicle seat cushion and seatback.
4. If the child restraint is equipped with a top tether strap, route the top tether strap and secure the tether strap to the tether anchor point. (See "Child restraint anchorage" (P.1-17).)
5. If the child restraint is equipped with other anti-rotation devices such as support legs, use them instead of the top tether strap following the child restraint manufacturer's instructions.

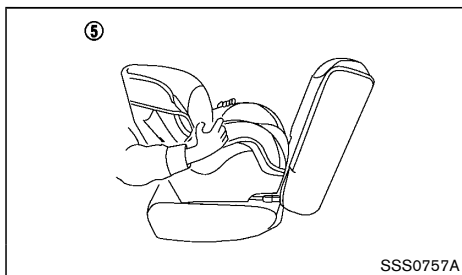

Step 6

6. Test the child restraint before you place the child in it in it ⑤ . Push the child restraint from side to side and tug it forward to make sure that it is held securely in place.
7. Check to make sure that the child restraint is properly secured prior to each use. If the child restraint is loose, repeat steps 3 through 6.

CHILD RESTRAINT INSTALLATION USING SEAT BELT

Installation on rear seats - seat belts without automatic locking mode

WARNING:

- The three-point type seat belt on your vehicle is not equipped with an automatic locking mode retractor.
- The direction of the child restraint system depends on the type of the child restraint system and the size of the child.

Front-facing:

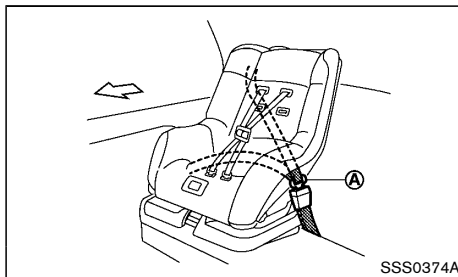

If you must install a front-facing child restraint system on the rear seat, follow these steps:

1. Position the front-facing child restraint system on the rear seat.
Always follow the child restraint system manufacturer's instructions for installation and use.
2. Route the seat belt tongue through the child restraint system and insert it into the buckle until you hear and feel the latch engage.

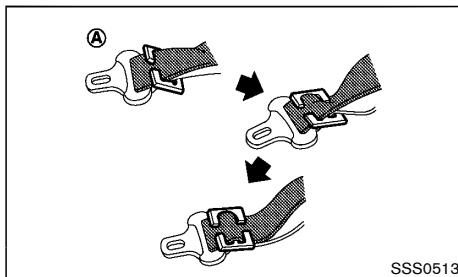

To prevent slack in the lap belt, it is necessary to secure the shoulder belt in place with a locking

clip ① . Use the locking clip attached to the child restraint system or one which is equivalent in dimension and strength.

Be sure to follow the child restraint system manufacturer's instructions for belt routing.

3. Test the child restraint system before you place the child in it. Tilt it from side to side. Try to tug it forward and check if it is held securely in place.
4. Make sure that the child restraint system is properly secured prior to each use.

Rear-facing:

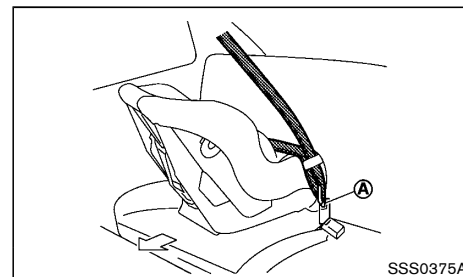

If you must install a rear-facing child restraint system on the rear seat, follow these steps:

1. Position the rear-facing child restraint system on the rear seat.
Always follow the child restraint system manufacturer's instructions for installation and use.
2. Route the seat belt tongue through the child restraint system and insert it into the buckle until you hear and feel the latch engage.

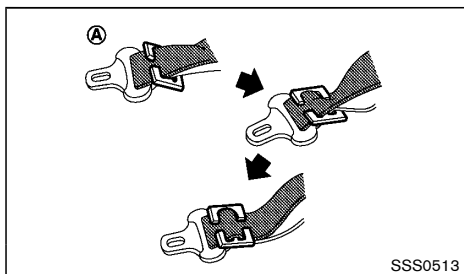

To prevent slack in the lap belt, it is necessary to secure the shoulder belt in place with a locking clip (A). Use the locking clip attached to the child restraint system or one which is equivalent in dimension and strength.

Be sure to follow the child restraint system manufacturer's instructions for belt routing.

3. Test the child restraint system before you place the child in it. Tilt it from side to side. Try to tug it forward and check if it is held securely in place.
4. Make sure that the child restraint system is properly secured prior to each use.

Installation on front seat - seat belts without automatic locking mode

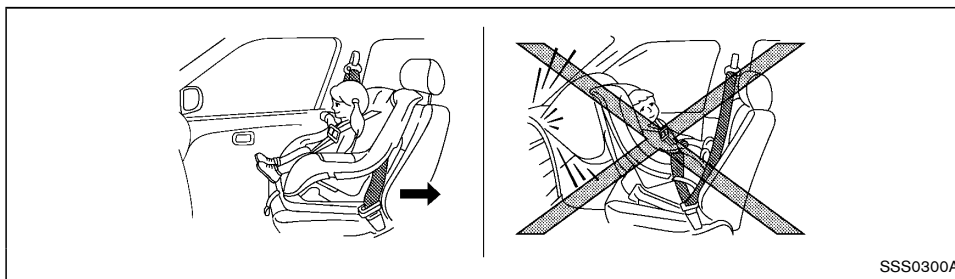

WARNING:

- **Never install a rear-facing child restraint on the front passenger's seat when the front passenger's air bag is equipped. Supplemental front-impact air bags inflate with great force. A rear-facing child restraint could be struck by the supplemental front-impact air bags in an accident and could seriously injure or kill your child.**
- **Never install a child restraint system with a top tether strap on the front seat.**
- **NISSAN recommends that a child restraint system be installed on the rear seat. However, if you must install a front-facing child restraint system on the front passenger's seat, move the passenger's seat to the rearmost position.**
- **Child restraints for infants must be used in the rear-facing direction and therefore must not be used on the front passenger's seat when the front passenger's air bag is**

equipped.

Front-facing:

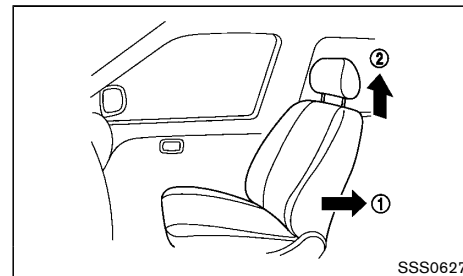

If you must install a front-facing child restraint system on the front seat, follow these steps:

1. Move the seat to the rearmost position (1).
2. **Except for Thailand:** Adjust the head restraint to its highest position (2).

For Thailand:

Remove the head restraint ②.

3. Position the front-facing child restraint system on the front passenger's seat. It should be placed in the front-facing direction only.

Always follow the child restraint system manufacturer's instructions for installation and use.

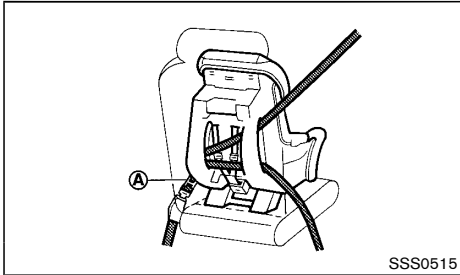

4. Route the seat belt tongue through the child restraint system and insert it into the buckle until you hear and feel the latch engage.

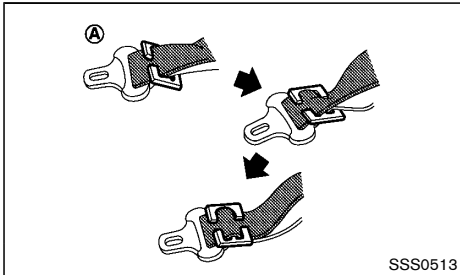

Locking clip

5. To prevent slack in the lap belt, it is necessary to secure the shoulder belt in place with a locking clip ①. Use the locking clip attached to the child

restraint system, or one which is equivalent in dimensions and strength.

Be sure to follow the child restraint system manufacturer's instructions for belt routing.

6. Slide the seat forward so that the seat belt fully tightens the child restraint system.
7. Test the child restraint system before you place the child in it. Tilt it from side to side. Try to tug it forward and check if it is held securely in place.
8. Make sure that the child restraint system is properly secured prior to each use.

SUPPLEMENTAL RESTRAINT SYSTEM (SRS)

PRECAUTIONS ON SUPPLEMENTAL RESTRAINT SYSTEM (SRS)

This Supplemental Restraint System (SRS) section contains important information concerning the driver's and passenger's supplemental front-impact air bags, and pre-tensioner seat belts.

Supplemental front-impact air bag system

This system can help cushion the impact force to the head and chest area of the driver and/or front passenger in certain frontal collisions. The supplemental front-impact air bag is designed to inflate on the front where the vehicle is impacted.

The SRS is designed to **supplement** the accident protection provided by the driver's seat belt and **is not** designed to **substitute** for it. The SRS can help save lives and reduce serious injuries. However, inflating air bags may cause abrasions or other injuries. Air bags do not provide protection to the lower body. Seat belts should always be correctly worn and the occupants should always be seated a suitable distance away from the steering wheel. (See "Seat belts" (P.1-6).) The air bags inflate quickly in order to help protect the occupants. The force of the air bags inflating can increase the risk of injury if the occupants are too close to, or are against, the air bag modules during inflation.

The air bags will deflate quickly after deployment.

The SRS operates only when the ignition switch is in the "ON" position.

When the ignition switch is in the "ON" position, the SRS air bag warning light illuminates for about 7 seconds and then turns off. This indicates that the SRS is operational. See "SRS air bag warning light" (P.1-25).

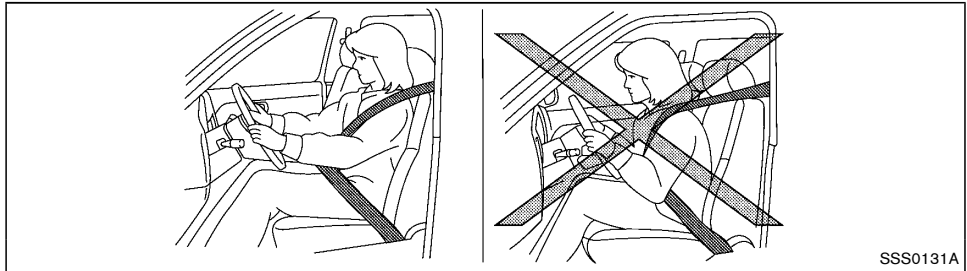

SSS0131A

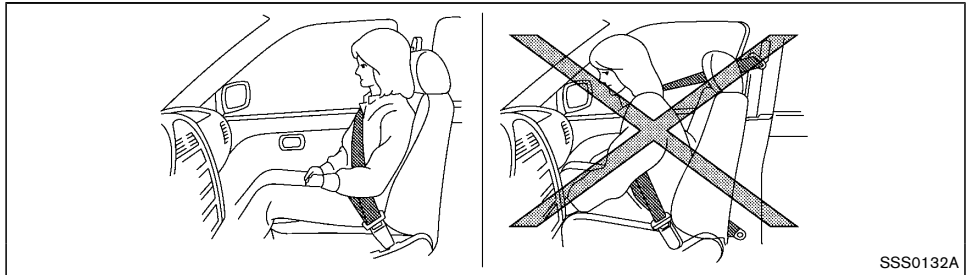

SSS0132A



WARNING:

- **The supplemental front-impact air bags ordinarily will not inflate in the event of a side impact, rear impact, rollover, or lower severity frontal collision. Always wear the seat belts to help reduce the risk or severity of injury in accidents.**
- **The seat belts and the supplemental front-impact air bags are most effective when you are sitting well back and upright in the seat. The front-impact air bags inflate with great force. If you are unrestrained, leaning for-**

ward, sitting sideways, or out of position in any way, you are at greater risk of injury or death in an accident. You may also receive serious or fatal injuries from the supplemental front-impact air bag if you are up against it when it inflates. Always sit back against the seatback and as far away as practical from the steering wheel. Always use the seat belts.

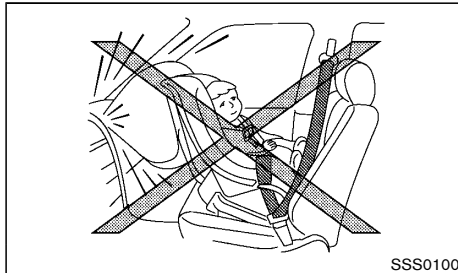
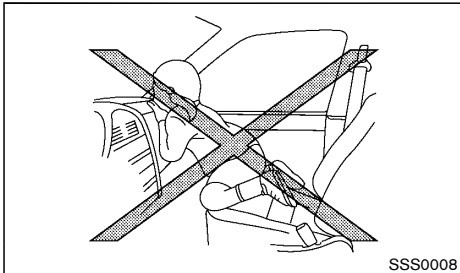
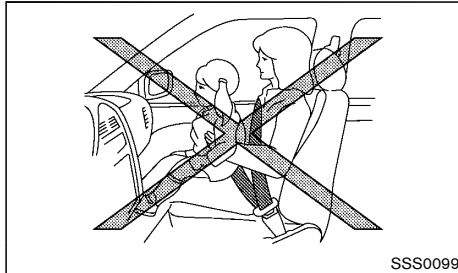
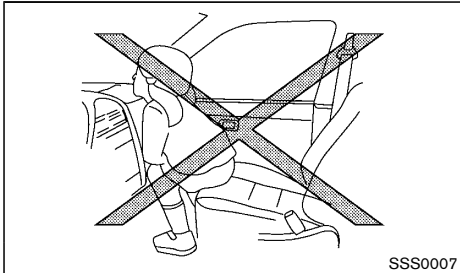
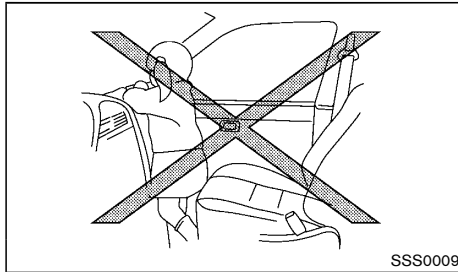
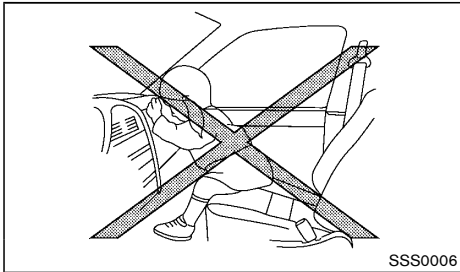

⚠ WARNING:

- **Never let children ride unrestrained or extend their hands or face out of the window. Do not attempt to hold them in your lap or arms. Some examples of dangerous riding positions are shown in the illustrations.**
- **Children may be severely injured or killed when the air bags inflate if they are not properly restrained.**
- **Never install a rear-facing child restraint system in the front seat. An inflating supplemental front-impact air bag could seriously injure or kill your child. (See “Child restraints” (P.1-12).)**

Pre-tensioner seat belt system

The pre-tensioner seat belt system may activate with the supplemental air bag system in certain types of collisions.

Working with the seat belt retractor and anchor, it helps tighten the seat belt the instant the vehicle becomes involved in certain types of collisions, helping to restrain front seat occupants. (See “Pre-tensioner seat belt system” (P.1-28).)

Air bag warning labels

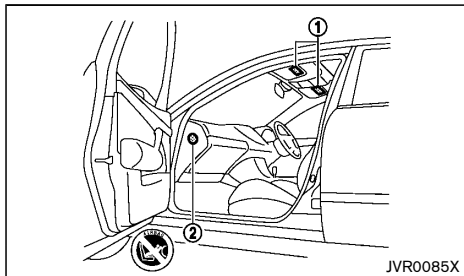

Warning labels about the supplemental air bag system are placed in the vehicle as shown in the illustration.

The warning label ① is located on the surface of the driver's and/or passenger's sun visor.

The warning label ② (if equipped) is located on the side of the passenger's side body panel.

The label(s) warn you not to fit a rear-facing child restraint system on the front passenger seat as such a restraint system used in this position could cause serious injury to the infant in case of air bag deployment during a collision.

Type A:



① Air bag warning label (sample)

The label ① design varies depending on the model.

The label warns:

"Extreme Hazard! Do not use a rearward facing child restraint on a seat protected by an airbag in front of it!"

Type B:



① Air bag warning label

The label ① warns:

"NEVER use a rearward facing child restraint on a seat protected by an ACTIVE AIRBAG in front of it, DEATH or SERIOUS INJURY to the CHILD can occur."

In vehicles equipped with a front-impact passenger air bag system, use a rear-facing child restraint system only on the rear seats.

When installing a child restraint system in your vehicle, always follow the child restraint system manufacturer's instructions for installation. For additional information, see "Child restraints" (P.1-12).

SRS air bag warning light



The SRS air bag warning light, displaying  in the instrument panel, monitors the circuits for the air bag systems, pre-tensioner seat belt systems and all related wiring.

When the ignition switch is in the "ON" position, the SRS air bag warning light illuminates for about 7 seconds and then turns off. This indicates that the SRS air bag systems are operational.

If any of the following conditions occur, the air bag and/or pre-tensioner seat belt systems need servicing:

- The SRS air bag warning light remains on after approximately 7 seconds.
- The SRS air bag warning light flashes intermittently.

- The SRS air bag warning light does not illuminate at all.

Under these conditions, the air bag system and/or pretensioner seat belt systems may not operate properly. They must be checked and repaired. Contact a NISSAN dealer immediately.

SUPPLEMENTAL AIR BAG SYSTEMS

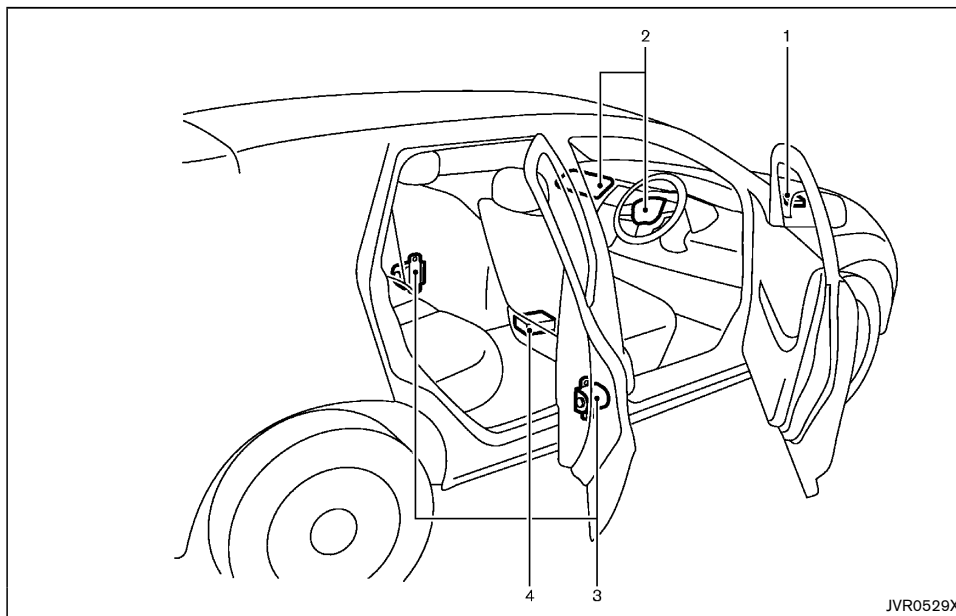

1. Crash zone sensor
2. Supplemental front-impact air bag modules
3. Seat belt pre-tensioner retractors
4. Supplemental air bag diagnosis sensor unit



WARNING:

- Do not place any objects on the steering wheel pad. Do not place any objects between the driver and steering wheel pad.

Such objects may become dangerous projectiles and cause injury if a supplemental air bag inflates.

- Immediately after inflation, several supplemental air bag system components will be hot. Do not touch them: you may severely burn yourself.
- No unauthorized changes should be made to any components or wiring of the supple-

mental air bag systems. This is to prevent accidental inflation of the supplemental air bags or damage to the supplemental air bag systems.

- **Do not make unauthorized changes to your vehicle's electrical system, suspension system or front end structure. This could affect proper operation of the supplemental air bag systems.**
- **Tampering with the supplemental air bag systems may result in serious personal injury. Tampering includes changes to the steering wheel by placing materials over the steering wheel pad and above, and by installing additional trim materials around the supplemental air bag systems.**
- **Work around and on the supplemental air bag systems should be done by a NISSAN dealer. The SRS wiring should not be modified or disconnected. Unauthorized electrical test equipment and probing devices should not be used on the supplemental air bag systems.**
- **The SRS wiring harness connectors are yellow and/or orange for easy identification.**

When the air bags inflate, a fairly loud noise may be heard, followed by the release of smoke. This smoke is not harmful and does not indicate a fire. Care should be taken not to inhale it, as it may cause irritation and choking. Those with a history of a breathing condition should get fresh air promptly.

Supplemental front-impact air bag system

The driver's supplemental front-impact air bag is located at the center of the steering wheel. The passenger's supplemental front-impact air bag is located at the instrument panel above the glove box.

The supplemental front-impact air bag system is designed to inflate in higher severity frontal collisions, although it may inflate if the forces in another type of collision are similar to those of a higher severity frontal impact. It may not inflate in certain frontal collisions. Vehicle damage (or lack of it) is not always an indication of proper supplemental front-impact air bag system operation.

SRS AIR BAG DEPLOYMENT CONDITIONS

The SRS air bags activate in the event of a front impact in which the vehicle occupants may be severely injured even if they are wearing the seat belts properly.

They may not activate when the crash energy is absorbed and/or distributed by the vehicle body. Vehicle damage (or lack of it) is not always an indication of proper SRS air bag system operation.

When the SRS air bag will deploy

Supplemental front-impact air bags:

The supplemental front-impact air bag system is designed to inflate in higher severity frontal collisions. Some examples are shown in the following illustrations.

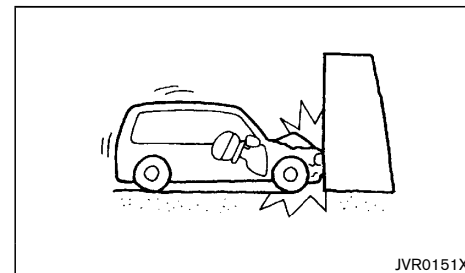

The supplemental front-impact air bag system will deploy in the event of an impact which exceeds a 25 km/h (16 MPH) frontal collision with a solid wall that does not move or deform.

The supplemental front-impact air bag system may also deploy when the vehicle receives severe damage to the undercarriage.

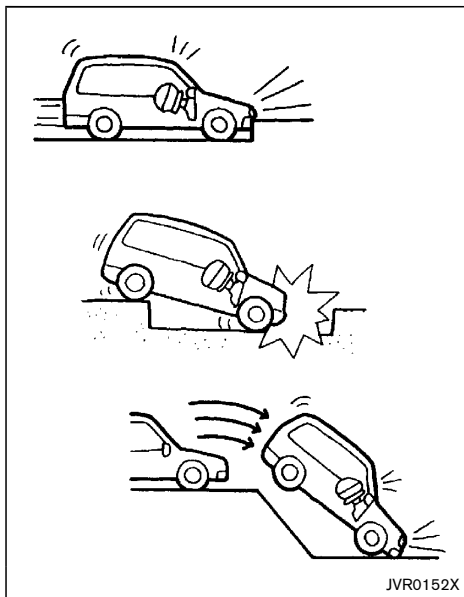

- Hitting a curb, pavement edge or hard surface at high speed
- Falling into a deep hole or ditch
- Landing hard on the ground after jumping

When the SRS air bag is unlikely to deploy

The SRS air bags may not deploy in cases where the impact is not forceful enough to inflate the SRS air bags.

For example, if the vehicle strikes an object, such as a parked vehicle or sign pole, which can move or deform on impact, the SRS air bags are unlikely to deploy.

Supplemental front-impact air bags:

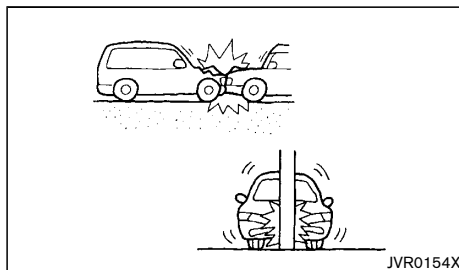

- Striking a vehicle of the same class that is parked
- Crashing into a solid utility pole

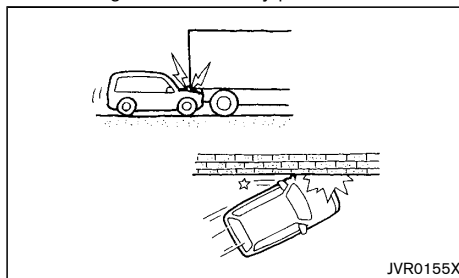

- Running under the tail gate of a truck

- A frontal offset impact to the guard rails

When the SRS air bag will not deploy

Once the SRS air bag has inflated, the air bag module will not function again if your vehicle collides with another vehicle or an object.

Other examples where the SRS air bag will not deploy are shown in the following illustrations.

Supplemental front-impact air bags:

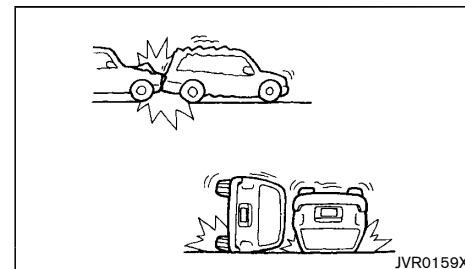

- A collision from the side or rear
- Vehicle rollover

PRE-TENSIONER SEAT BELT SYSTEM



WARNING:

- The pre-tensioner seat belt cannot be re-used after activation. It must be replaced together with the retractor and buckle as a unit.
- If the vehicle becomes involved in a collision but the pre-tensioner is not activated, be sure to have the pre-tensioner system

checked and, if necessary, replaced by a NISSAN dealer.

- **No unauthorized changes should be made to any components or wiring of the pre-tensioner seat belt system. This is to prevent accidental activation of the pre-tensioner seat belt or damage to the pre-tensioner seat belt system.**
- **Work around or on the pre-tensioner seat belt system should be done by a NISSAN dealer. The SRS wiring should not be modified or disconnected. Unauthorized electrical test equipment and probing devices should not be used on the pre-tensioner seat belt system.**
- **If you need to dispose of the pre-tensioner seat belt system, or scrap the vehicle, contact a NISSAN dealer. Correct pre-tensioner disposal procedures are set forth in the appropriate NISSAN Service Manual. Incorrect disposal procedures could cause personal injury.**

The pre-tensioner seat belt system may activate with the supplemental air bag system in certain types of collisions.

Working with the seat belt retractor, it helps tighten the seat belt when the vehicle becomes involved in certain types of collisions, helping to restrain front seat occupants.

The pre-tensioner is encased with the front seat belt's retractor and anchor. These seat belts are used the same as conventional seat belts.

When the pre-tensioner seat belt activates, a fairly loud noise may be heard, followed by the release of smoke. This smoke is not harmful and does not indicate a fire. Care should be taken not to inhale it, as it may cause

irritation and choking. Those with a history of a breathing condition should get fresh air promptly.

REPAIR AND REPLACEMENT PROCEDURE



WARNING:

- **Once the air bags have been inflated, the air bag modules will not function and must be replaced. The air bag modules must be replaced by a NISSAN dealer. The inflated air bag modules cannot be repaired.**
- **The air bag systems should be inspected by a NISSAN dealer if there is any damage to the front end or side portion of the vehicle.**
- **If you need to dispose of the SRS or scrap the vehicle, contact a NISSAN dealer. Correct disposal procedures are set forth in the appropriate NISSAN Service Manual. Incorrect disposal procedures could cause personal injury.**

The air bags and pre-tensioner seat belts are designed to activate on a one-time-only basis. As a reminder, unless the SRS air bag warning light is damaged, the SRS air bag warning light remains illuminated after inflation has occurred. The repair and replacement of the SRS should be done only by a NISSAN dealer.

When maintenance work is required on the vehicle, information about the air bags, pre-tensioner seat belts and related parts should be pointed out to the person performing the maintenance. The ignition switch should always be in the "LOCK" position when working under the hood or inside the vehicle.

MEMO

2 Instruments and controls

Cockpit	2-2	Headlight aiming control	2-19
Instrument panel	2-3	Turn signal switch	2-20
Meters and gauges	2-4	Fog light switch (if equipped)	2-20
Vehicle information display	2-6	Front fog lights	2-20
Speedometer	2-6	Wiper and washer switch	2-21
Odometer/Twin trip odometer	2-6	Windshield wiper and washer switch	2-21
Trip computer	2-7	Rear window wiper and washer switch	2-21
Maintenance information	2-8	Defogger switch	2-22
Tachometer	2-8	Horn	2-23
Engine coolant temperature gauge (for Type B)	2-9	Windows	2-23
Fuel gauge	2-9	Power windows	2-23
Continuously Variable Transmission (CVT) position indicator	2-9	Clock	2-25
Instrument brightness control	2-10	Adjusting time	2-25
Outside air temperature (for Type A)	2-10	Power outlet	2-26
ECO meters (for Type A)	2-10	Storage	2-26
Warning lights, indicator lights and audible reminders	2-12	Glove box	2-26
Checking lights	2-13	Upper instrument box	2-27
Warning lights	2-13	Card holder	2-27
Indicator lights	2-16	Cup holders	2-27
Audible reminders	2-17	Soft bottle holder	2-27
Headlight and turn signal switch	2-18	Luggage hooks	2-27
Headlight switch	2-18	Sun visors	2-28
Battery saver system	2-19	Interior lights	2-28
		Map light / Room light	2-28

COCKPIT

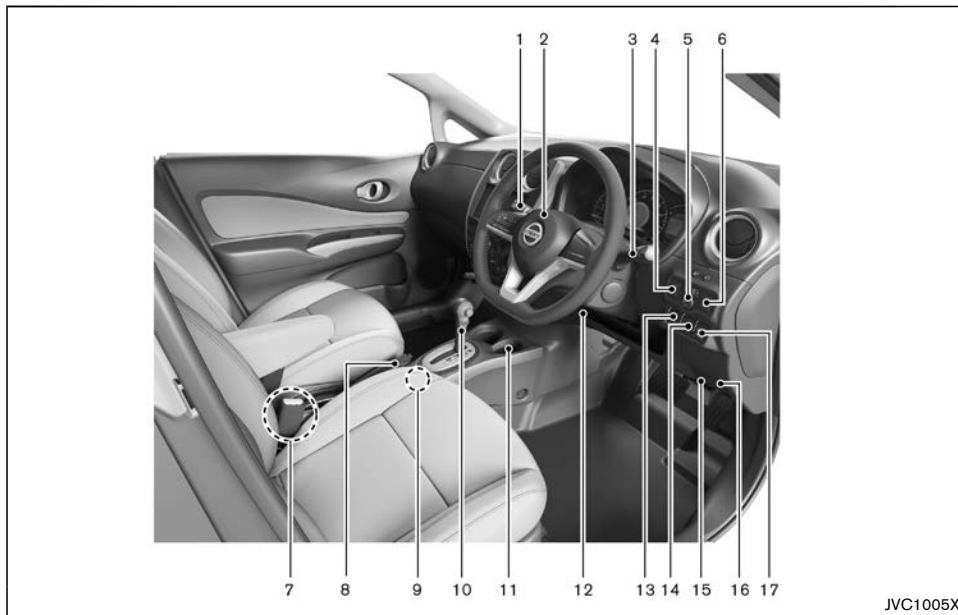

- | | |
|--|---|
| 1. Wiper and washer switch | 5. Outside mirror remote control switch |
| 2. Steering wheel | 6. Forward emergency braking system OFF switch*
or Idling Stop OFF switch* |
| — Electric power steering | 7. Power outlet |
| — Horn | 8. Parking brake |
| — Driver's supplemental front-impact air bag | 9. ECO mode switch* |
| 3. Headlight, fog light and turn signal switch | 10. Shift lever |
| — Headlight and turn signal switch | — Continuously Variable Transmission (CVT) |
| — Fog light switch* | 11. Front cup holders |
| 4. Idling Stop OFF switch* | |

12. Tilting steering wheel lever
13. Vehicle Dynamic Control (VDC) OFF switch*
14. Headlight aiming control switch*
15. Hood release handle
16. Fuel-filler lid release handle
17. Lane Departure Warning (LDW) switch* or
Vehicle Dynamic Control (VDC) OFF switch*

*: if equipped

INSTRUMENT PANEL

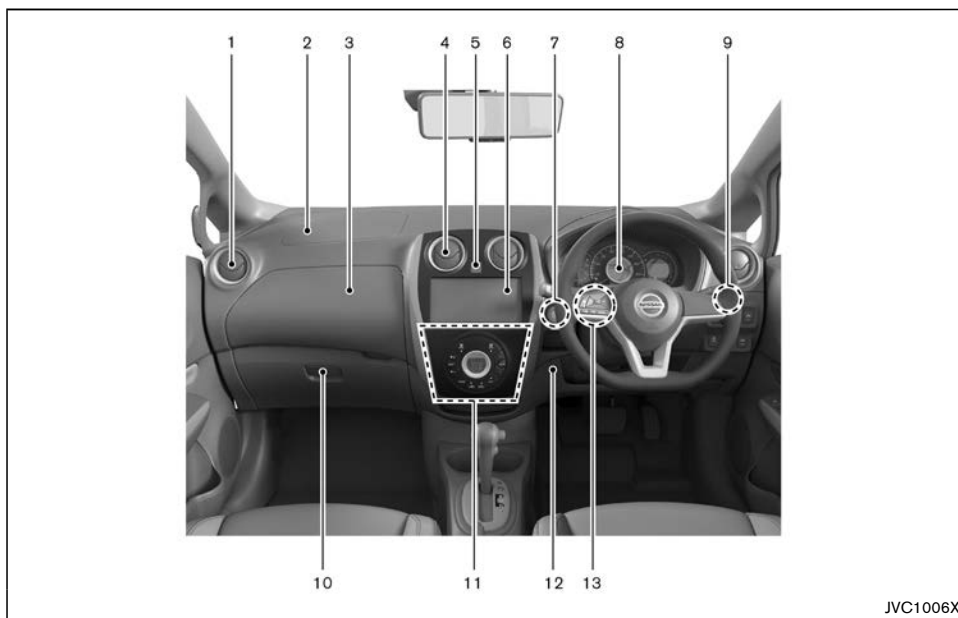

JVC1006X

- | | |
|---|---|
| 1. Side ventilator | 9. Trip computer mode switch* /Clock settings switch* |
| 2. Passenger's front-impact air bag | 10. Glove box |
| 3. Upper instrument box
— USB (Universal Serial Bus) Connection Port | 11. Heater and air conditioner control
— Rear window defogger switch |
| 4. Center ventilator | 12. Fuse box |
| 5. Hazard indicator flasher switch | 13. Steering-wheel-mounted controls* |
| 6. Audio system* | *: if equipped |
| 7. Push-button ignition switch | |
| 8. Meters and gauges | |

METERS AND GAUGES

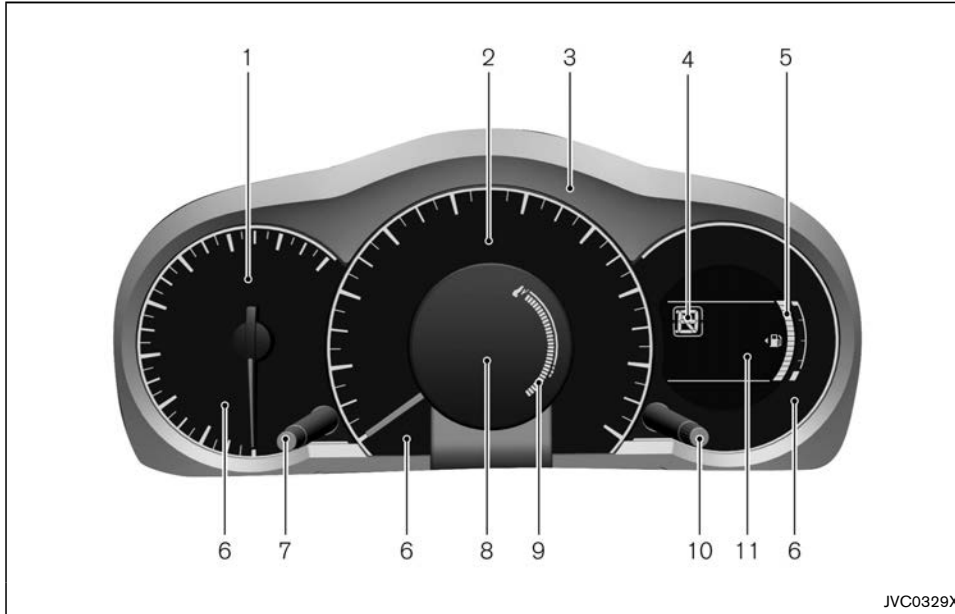

the ignition switch is placed in the “OFF” or “LOCK” position. This is not a malfunction.

Type A

1. Tachometer
2. Speedometer
3. ECO drive indicator
4. Continuously Variable Transmission (CVT) position indicator
5. Fuel gauge
6. Warning/indicator lights
7. ECO drive indicator switch/ECO pedal guide switch
8. Vehicle information display
 - Trip computer
 - Clock
9. ECO pedal guide
10. Trip odometer switch/Instrument brightness control switch/Maintenance interval setting switch
11. Odometer/Twin trip odometer/Outside air temperature

The needle indicators may move slightly after

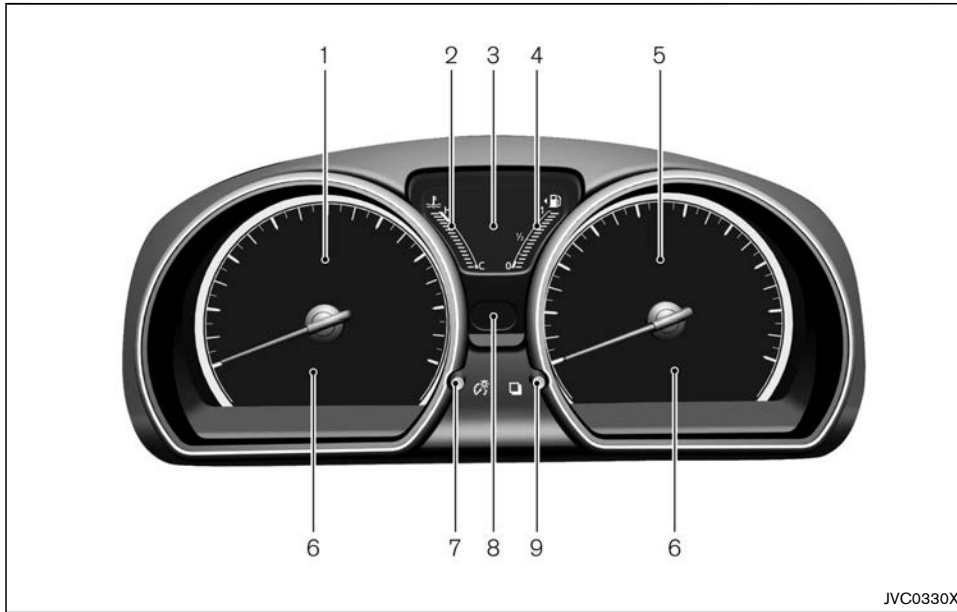

JVC0330X

Type B

- | | |
|---|---|
| <ol style="list-style-type: none"> 1. Tachometer 2. Engine coolant temperature gauge 3. Vehicle information display <ul style="list-style-type: none"> — Odometer/Twin trip odometer — Trip computer — Clock — Instrument brightness control display — Outside air temperature* 4. Fuel gauge | <ol style="list-style-type: none"> 5. Speedometer 6. Warning/indicator lights 7. Instrument brightness control switch 8. Continuously Variable Transmission (CVT) position indicator 9. Trip odometer switch/Trip computer mode switch/Maintenance interval setting switch <p>*: if equipped</p> |
|---|---|

The needle indicators may move slightly after the ignition switch is placed in the "OFF" or "LOCK" position. This is not a malfunction.

VEHICLE INFORMATION DISPLAY

Type A

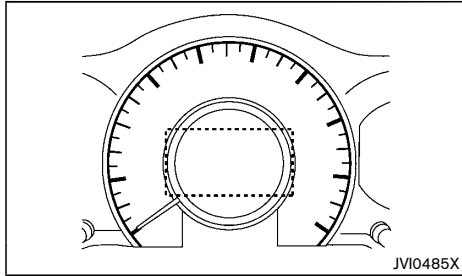

When the ignition switch is placed in the "ON" position, the vehicle information display shows the following information.

- Trip computer
- Clock

Type B

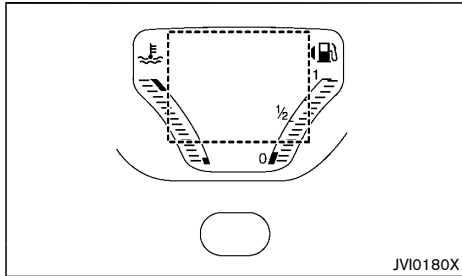

When the ignition switch is placed in the "ON" position, the vehicle information display shows the following information.

- Odometer/twin trip odometer
- Trip computer
- Clock
- Outside air temperature (if equipped)
- Instrument brightness control display

SPEEDOMETER

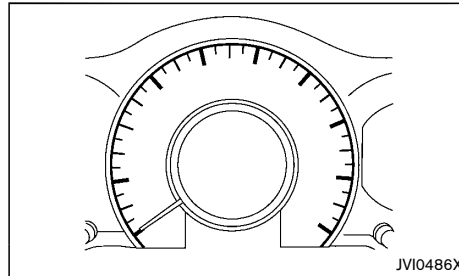

Type A

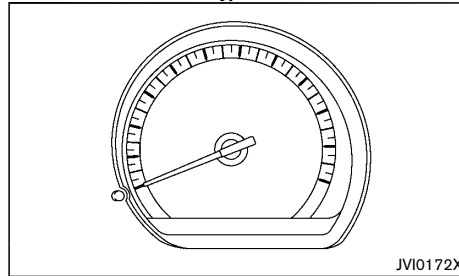

Type B

The speedometer indicates the vehicle speed.

ODOMETER/TWIN TRIP ODOMETER

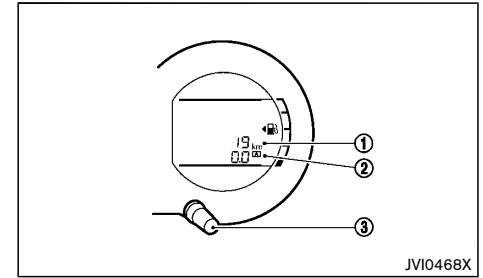

Type A

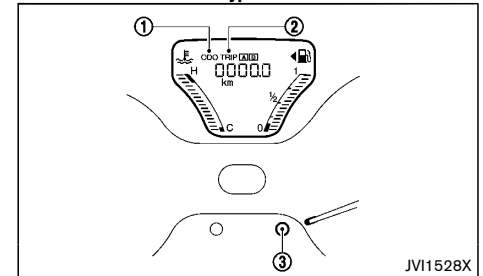

Type B

The odometer/twin trip odometer is displayed:

- when the ignition switch is in the "ON" position.
- for 30 seconds after the ignition switch was placed in the "OFF" position. (Type A)

The odometer ① displays the total distance the vehicle has been driven.

The twin trip odometer ② displays the distance of individual trips.

Changing twin trip odometer display

Push the trip odometer switch (3) to change the display as follows:

Type A:

TRIP A → TRIP B → TRIP A

Type B:

ODO → TRIP A → TRIP B → Trip computer mode → ODO

For trip computer information, see "Trip computer" (P.2-7).

Resetting twin trip odometer

Push the trip odometer switch (3) for more than 1 second to reset the trip odometer to zero.

TRIP COMPUTER

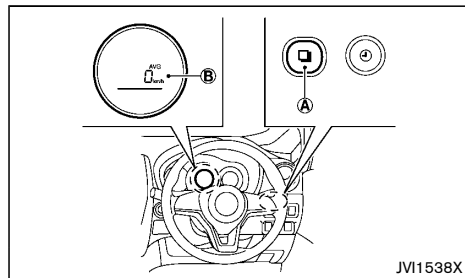

Type A

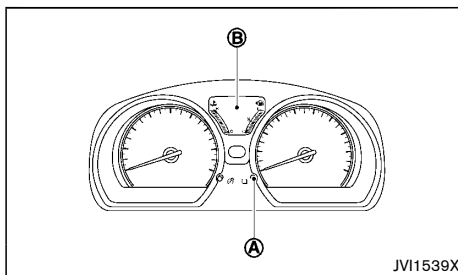

Type B

The trip computer mode switch (A) located the right side of the meter (Type A) or the meter panel (Type B).

Trip computer appears on the display (B).

When the ignition switch is placed in the "ON" position, the trip computer can be selected by pushing the trip computer mode switch (A).

Each time the trip computer mode switch (A) is pushed, the display will change as follows:

Type A:

Current fuel consumption → Average fuel consumption → Distance to empty → Average speed → Elapsed time

Type B:

ODO → (TRIP A → TRIP B) → Current fuel consumption → Average fuel consumption → Distance to empty → Outside air temperature (if equipped) → Clock settings mode

Current fuel consumption (km/l)

The current fuel consumption mode shows the current fuel consumption.

Average fuel consumption (km/l)AVG

The average fuel consumption mode shows the average fuel consumption since the last reset. Resetting is done by pushing the trip computer mode switch (A) for longer than 1 second.

The display is updated every 30 seconds. At about the first 500 m (1/3 miles) after a reset, the display shows "----".

Distance to empty (dte — km) →

The distance to empty (dte) mode provides you with an estimation of the distance that can be driven before refueling. The dte is constantly being calculated, based on the amount of fuel in the fuel tank and the actual fuel consumption.

The display is updated every 30 seconds.

The dte mode includes a low range warning feature: when the fuel level is low, the dte mode is automatically selected and the digits blink in order to draw the driver's attention. Push the trip computer mode switch (A) to return to the mode that was selected before the warning occurred.

When the fuel level drops even lower, the dte display will change to "----".

- If the amount of fuel added is small, the display just before the ignition switch is turned off may continue to be displayed.
- When driving uphill or rounding curves, the fuel in the tank shifts, which may momentarily change the display.

Average speed (for Type A) **AVG**

The average speed mode shows the average vehicle speed since the last reset. Resetting is done by pushing the trip computer mode switch (A) for longer than 1 second.

Elapsed time (for Type A) **→→**

The elapsed time mode shows the time since the last reset. The displayed time can be reset by pushing the trip computer mode switch (A) for longer than 1 second.

Outside air temperature (if equipped for Type B)

The outside air temperature is displayed in °C .

When the outside air temperature decreases to 3°C (37 °F) or lower, the outside air temperature display blinks to give a warning.

The display will stop blinking after 1 minute or when the outside air temperature increases to 4°C (39°F) or above.

For information regarding the outside air temperature (for Type A), see "Outside air temperature (for Type A)" (P.2-10).

Clock settings mode (for Type B)

For clock adjustment, see "Clock" (P.2-25).

Resetting displays

Type A:

When average fuel consumption, average speed or elapsed time is displayed, push the trip computer mode switch (A) for longer than 3 seconds. Average fuel consumption, average speed and elapsed time will be reset at the same time.

Type B:

When the average fuel consumption or TRIP B is displayed, push the trip computer mode switch (A) for longer than 3 seconds. The display of average fuel consumption and trip odometer (TRIP B only) will be reset at the same time.

MAINTENANCE INFORMATION

When the ignition switch is placed in the "ON" position, maintenance information (the wrench symbol  and distance to change a maintenance item) comes on for about 5 seconds and then turns off.

To set the distance to change an item:

1. Within 5 seconds of placing the ignition switch in the "ON" position, push the maintenance interval setting switch for about 3 seconds or more. (Maintenance information blinks.)
2. Each time the maintenance interval setting switch is pushed, the distance to change is extended. The distance is extended by 1,000 km (500 miles) each time the switch is pushed. The distance to change can be set to within a range of 0 to 30,000 km (18,000 miles).
3. A new distance to change is set when no operation is performed for 5 seconds.

If the distance to change is set to 0 (zero), the maintenance information will not be displayed when the ignition switch is placed in the "ON" position.

TACHOMETER

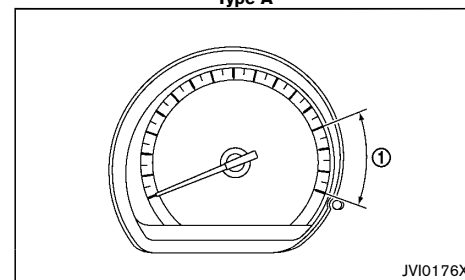
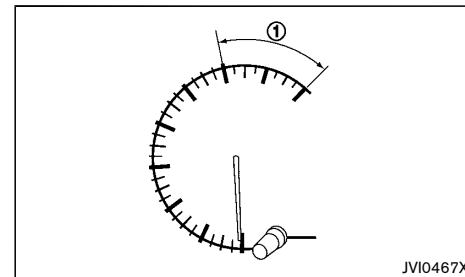

The tachometer indicates the engine speed in revolutions per minute (rpm).

Do not rev the engine into the red zone ① .

ENGINE COOLANT TEMPERATURE GAUGE (for Type B)

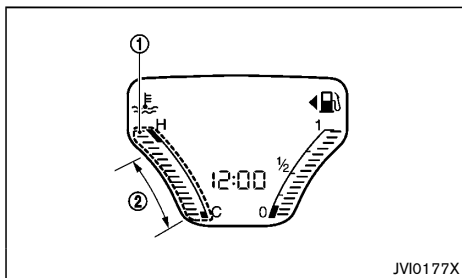

The engine coolant temperature gauge ① indicates the engine coolant temperature.

The engine coolant temperature is normal when the gauge is within the zone ② shown in the illustration. The engine coolant temperature will vary with the outside air temperature and driving conditions.

CAUTION:

- If the gauge indicates engine coolant temperature near the hot (H) end of the normal range, reduce vehicle speed to decrease temperature.
- If the gauge is over the normal range, stop the vehicle as soon as safely possible.
- If the engine is overheated, continued operation of the vehicle may seriously damage the engine. (See “If your vehicle overheats” (P.6-10) for immediate action required.)

FUEL GAUGE

The arrow, , indicates that the fuel-filler lid is located on the left side of the vehicle.

CAUTION:

Refuel before the gauge reads the empty (0) position.

There is a small reserve of fuel in the tank when the fuel gauge reads the empty (0) position.

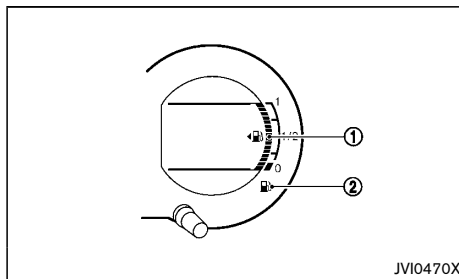

Type A

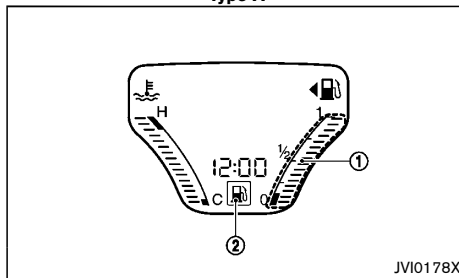

Type B

The fuel gauge ① indicates the approximate fuel level in the tank when the ignition switch is in the “ON”

position.

The gauge may move slightly during braking, turning, accelerating, or going up and down hills due to movement of fuel in the tank.

The low fuel warning light ② illuminates when the fuel level in the tank is getting low. Refuel as soon as it is convenient, preferably before the gauge reads the empty (0) position.

CONTINUOUSLY VARIABLE TRANSMISSION (CVT) POSITION INDICATOR

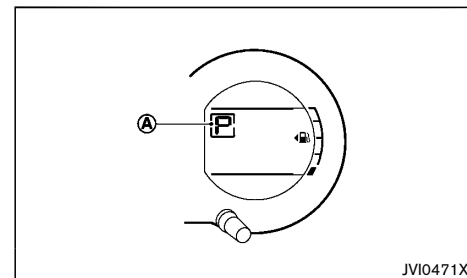

Type A

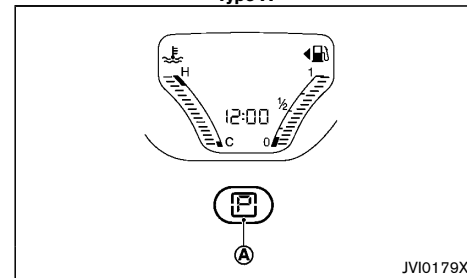

Type B

The Continuously Variable Transmission (CVT) position

indicator (A) indicates the shift lever position when the ignition switch is in the "ON" position.

INSTRUMENT BRIGHTNESS CONTROL

Type A

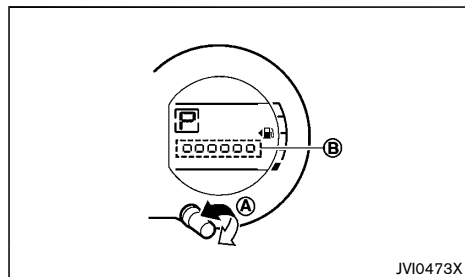

The instrument brightness control operates when the ignition switch is in the "ON" position.

Turn the brightness control switch (A) clockwise or counterclockwise to increase or decrease the brightness. The brightness indicator (B) will be shown briefly in the display when the brightness control switch (A) is turned.

When the brightness level reaches the maximum or minimum, a beep will sound.

Type B

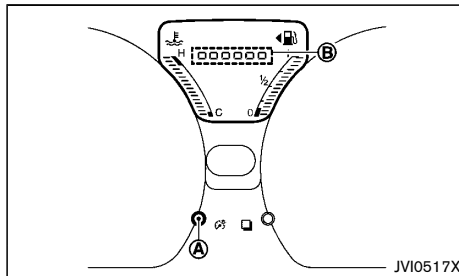

The instrument brightness control operates when the ignition switch is in the "ON" position.

Push the brightness control switch (A) to decrease the brightness of the meter panel lights. The brightness indicator (B) will be shown briefly in the display when the brightness control switch (A) is pushed.

If the brightness mode reaches the minimum level, the next time the switch is pressed, the brightness will return to the maximum level.

When the brightness level reaches the minimum, a beep will sound.

OUTSIDE AIR TEMPERATURE (for Type A)

The outside air temperature is displayed in °C .

When the outside air temperature decreases to 3°C (37 °F) or lower, the outside air temperature display blinks to give a warning.

The display will stop blinking after 1 minute or when the outside air temperature increases to 4°C (39°F) or above.

For information regarding the outside air temperature (if equipped for Type B), see "Outside air temperature (if equipped for Type B)" (P.2-8).

ECO METERS (for Type A)



Keeping a close watch on the display while driving may cause a traffic accident. Never keep a close watch on the display while driving the vehicle. When driving, minimize the amount of time spent looking at the display to avoid causing an accident.

ECO drive indicator

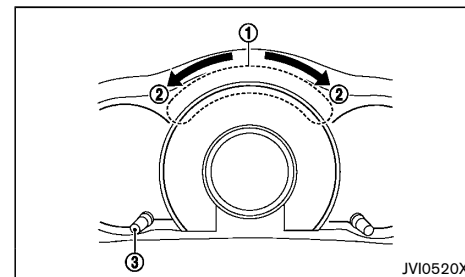

ECO drive indicator (1) is displayed in three steps according to the accelerator pedal operation, while driving the vehicle in ECO mode. (ECO drive indicator is not displayed when the shift lever is in the "R" (Reverse) position.)

The indicator will illuminate in the directions of (2) as the driving pattern becomes more ECO friendly .

The ECO drive indicator can be switched between displaying/not displaying, when pushing switch (3) for more than 2 seconds.

ECO pedal guide

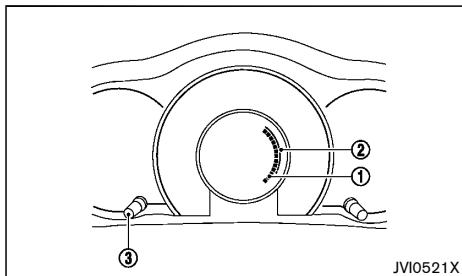

Accelerator pedal depressing levels are displayed on ①, while driving the vehicle in ECO mode. (Accelerator pedal depressing levels are not displayed when the shift lever in the "R" (Reverse) position.)

Fuel consumption can be improved when accelerator pedal depressing levels displayed on ① are adjusted to within the ECO drive area ②.

The ECO pedal guide can be switched between displaying/not displaying, when pushing switch ③ for a short period of time.

ECO drive report

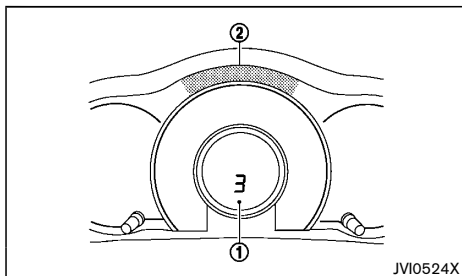

The level of ECO driving achieved while driving the vehicle (from the moment the ignition switch is placed in the "ON" position until the moment it is placed in the "OFF" position) is evaluated after driving.

The achieved level (Score) is displayed on the vehicle information display ① and ECO drive indicator ② when the ignition switch is placed in the "OFF" position.

Score		ECO level
Vehicle information display	ECO drive indicator	
5		Good
3		Normal
1		Low

Score is not indicated in the following conditions.





























- The duration of driving the vehicle in ECO mode was 10 minutes or less.
- ECO mode system was turned off before the ignition switch was placed in the "OFF" position.
- The driver's door was opened before the ignition switch was placed in the "OFF" position.







CAUTION:









The duration of driving the vehicle does not include the duration of stopping such as idling, waiting at traffic lights, etc.

WARNING LIGHTS, INDICATOR LIGHTS AND AUDIBLE REMINDERS

	Anti-lock Braking System (ABS) warning light		Lane Departure Warning (LDW) warning light (if equipped)		High beam indicator light
	Brake warning light		Low fuel warning light		Idling Stop System indicator light
	Charge warning light		P position selecting warning light		Low temperature indicator light (green) (if equipped)
	Door open warning light		Seat belt warning light		Malfunction Indicator Light (MIL)
	Electric power steering warning light		Supplemental Restraint System (SRS) air bag warning light		Security indicator light
	Engine oil pressure warning light		Vehicle Dynamic Control (VDC) warning light		Small light indicator light
	Forward emergency braking system warning light (if equipped)		ECO mode system indicator light (if equipped)		SPORT mode indicator light
	Headlight warning light (if equipped)		Engine start operation indicator light		Turn signals/hazard indicator lights
	High temperature warning light (red) (if equipped)		Forward emergency braking system off indicator light (if equipped)		Vehicle Dynamic Control (VDC) off indicator light
	Intelligent Key system warning light		Front fog lights indicator light (if equipped)		

CHECKING LIGHTS

With all doors closed, apply the parking brake, fasten the seat belts and place the ignition switch in the "ON" position without starting the engine. The following lights (if equipped) will come on: , , , .

The following lights (if equipped) will come on briefly and then go off: , SPORT, , , , ,  (red),  (green), .

If any light does not come on or operates in a way other than described, it may indicate a burned-out bulb and/or a system malfunction. Have the system checked, and if necessary repaired, by a NISSAN dealer promptly.

WARNING LIGHTS

Anti-lock Braking System (ABS) warning light

When the ignition switch is in the "ON" position, the Anti-lock Braking System (ABS) warning light illuminates and then turns off. This indicates the ABS is operational.

If the ABS warning light illuminates while the engine is running, or while driving, it may indicate the ABS is not functioning properly. Have the system checked by a NISSAN dealer promptly.

If an ABS malfunction occurs, the anti-lock function is turned off. The brake system then operates normally, but without anti-lock assistance. (See "Anti-lock Braking System (ABS)" (P.5-24).)

Brake warning light

WARNING:

- **If the brake fluid level is below the minimum mark on the brake fluid reservoir, do not drive the vehicle until the brake system has been checked by a NISSAN dealer.**
- **Even if you judge it to be safe, have your vehicle towed because driving it could be dangerous.**
- **Depressing the foot brake pedal without the engine running and/or with a low brake fluid level could increase the stopping distance and require greater pedal travel distance and effort.**

The brake warning light indicates the parking brake system operation, a low brake fluid level of the brake system and an Anti-lock Braking System (ABS) malfunction.

Parking brake warning indicator:

When the ignition switch is in the "ON" position, and the parking brake is applied, the brake warning light illuminates. When the engine is running, and parking brake is released, the brake warning light turns off.

If the parking brake is not fully released, the brake warning light remains on. Be sure that the brake warning light has turned off before driving. (See "Parking brake" (P.3-17).)

Low brake fluid warning indicator:

If the brake warning light illuminates while the engine is running, or while driving, and the parking brake is released, it may indicate the brake fluid level is low.

When the brake warning light illuminates while driving,

stop the vehicle safely as soon as possible. Stop the engine and check the brake fluid level. If the brake fluid level is below the minimum mark on the reservoir, add brake fluid as necessary. (See "Brake fluid" (P.8-12).)

If the brake fluid level is sufficient, have the brake system checked by a NISSAN dealer promptly.

Anti-lock Braking System (ABS) warning indicator:

When the parking brake is released and the brake fluid level is sufficient, if both the brake warning light and the Anti-lock Braking System (ABS) warning light illuminate, it may indicate the ABS is not functioning properly. Have the brake system checked, and if necessary repaired, by a NISSAN dealer promptly. (See "Anti-lock Braking System (ABS) warning light" (P.2-13).)

Charge warning light

When the ignition switch is in the "ON" position, the charge warning light illuminates. After starting the engine, the charge warning light turns off. This indicates the charging system is operational.

If the charge warning light illuminates while the engine is running, or while driving, it may indicate the charging system is not functioning properly and may need servicing. Have the system checked by a NISSAN dealer promptly.

When the charge warning light illuminates while driving, stop the vehicle safely as soon as possible. Stop the engine and check the alternator belt. If the alternator belt is loose, broken or missing, the charging system needs repair. (See "Drive belts" (P.8-10).)

If the alternator belt appears to be functioning correctly but the charge warning light remains illuminated, have the charging system checked by a NISSAN dealer

promptly.



CAUTION:

Do not continue driving if the alternator belt is loose, broken or missing.



Door open warning light

When the ignition switch is in the “ON” position, the door open warning light illuminates if any of the doors or the rear hatch is open or not closed securely.



Electric power steering warning light

When the ignition switch is in the “ON” position, the electric power steering warning light illuminates. After starting the engine, the electric power steering warning light turns off. This indicates the electric power steering is operational.

If the electric power steering warning light illuminates while the engine is running, it may indicate the electric power steering is not functioning properly and may need servicing. Have the electric power steering checked by a NISSAN dealer.

When the electric power steering warning light illuminates with the engine running, the power assist to the steering will cease operation but you will still have control of the vehicle. At this time, greater steering efforts are required to operate the steering wheel, especially in sharp turns and at low speeds.

(See “Electric power steering” (P.5-23).)



Engine oil pressure warning light

When the ignition switch is in the “ON” position, the engine oil pressure warning light illuminates. After starting the engine, the engine oil pressure warning light turns off. This indicates that the oil pressure sensors in the engine are operational.

If the engine oil pressure warning light illuminates or blinks while the engine is running, it may indicate that the engine oil pressure is low.

Stop the vehicle safely as soon as possible. Stop the engine immediately and call a NISSAN dealer.



CAUTION:

- **Running the engine with the engine oil pressure warning light illuminated could cause serious damage to the engine.**
- **The engine oil pressure warning light is not designed to indicate a low oil level. The oil level should be checked using the dipstick. (See “Engine oil” (P.8-7).)**



Forward emergency braking system warning light (if equipped)

When the ignition switch is in the “ON” position, the forward emergency braking system warning light illuminates. After starting the engine, the forward emergency braking system warning light turns off.

This light illuminates when the Vehicle Dynamic Control (VDC) system is turned off.

If the light illuminates when the forward emergency braking system is ON, it may indicate that the system is unavailable. See “Forward emergency braking system” (P.5-17) for more details.



Headlight warning light (if equipped)

This light illuminates if the LED headlights are malfunctioning. Contact a NISSAN dealer.



High temperature warning light (red) (if equipped)

When the ignition switch is in the “ON” position, the high temperature warning light illuminates and then turns off. This indicates that the high temperature sensor in the engine coolant system is operational.



CAUTION:

If the high temperature warning light illuminates while the engine is running, it may indicate the engine temperature is extremely high. Stop the vehicle safely as soon as possible.

If the vehicle is overheated, continuing vehicle operation may seriously damage the engine. (See “If your vehicle overheats” (P.6-10) for the immediate action required.)



Intelligent Key system warning light

After the ignition switch is placed in the “ON” position, this light comes on for about 2 seconds and then turns off.

This light illuminates or blinks as follows:

- The light blinks in yellow when the door is closed with the Intelligent Key left outside the vehicle and the ignition switch in the “ACC” or “ON” position. Make sure that the Intelligent Key is inside the vehicle.

- The light blinks in green when the Intelligent Key battery is running out of power. Replace the battery with a new one. See “Intelligent Key battery” (P.8-18).
- The light illuminates in yellow when it warns of a malfunction with the electrical steering lock system or the Intelligent Key system.

If the warning light illuminates in yellow while the engine is stopped, it may be impossible to free the steering lock or to start the engine. If the light comes on while the engine is running, you can drive the vehicle. However in these cases, contact a NISSAN dealer for repair as soon as possible.

Lane Departure Warning (LDW) warning light (if equipped)

When the ignition switch is in the “ON” position, the Lane Departure Warning (LDW) warning light illuminates and then turns off.

When the vehicle approaches either the left or the right side of the traveling lane, a warning chime will sound and the LDW warning light will blink to alert the driver.

If the light illuminates when the LDW system is ON, it may indicate that the system is unavailable. See “Lane Departure Warning (LDW) system” (P.5-14) for more details.

Low fuel warning light

The low fuel warning light illuminates when the fuel level in the tank is getting low. Refuel as soon as it is convenient, preferably before the fuel gauge reaches the empty (0) position. There will be a small reserve of fuel remaining in the tank when the fuel gauge reaches the empty (0) position.

P position selecting warning light

The warning light blinks in red when the ignition switch is pushed to stop the engine with the shift lever in any position except the “P” (Park) position.

If this warning appears, move the shift lever to the “P” (Park) position or push the ignition switch to the “ON” position.

An inside warning chime will also sound.

(See “Intelligent Key system” (P.3-4).)

Seat belt warning light

When the ignition switch is in the “ON” position, the seat belt warning light illuminates. The light will continue to illuminate until the driver’s seat belt is fastened. (See “Seat belts” (P.1-6).)

When the vehicle speed exceeds 15 km/h (10 MPH), the light will blink and the chime will sound unless the driver’s seat belt is securely fastened. The chime will continue to sound for about 90 seconds until the seat belt is fastened.

Supplemental Restraint System (SRS) air bag warning light

When the ignition switch is in the “ON” position, the Supplemental Restraint System (SRS) air bag warning light illuminates for about 7 seconds and then turns off. This indicates that the SRS air bag system is operational.

If any of the following conditions occur, the SRS air bag system and pre-tensioner seat belt need servicing. Have the system checked, and if necessary repaired, by a NISSAN dealer promptly.

- The SRS air bag warning light remains illuminated after about 7 seconds.
- The SRS air bag warning light flashes intermittently.
- The SRS air bag warning light does not illuminate at all.

Unless checked and repaired, the SRS air bag system and/or pre-tensioner seat belt may not function properly. (See “Supplemental Restraint System (SRS)” (P.1-23).)

Vehicle Dynamic Control (VDC) warning light

When the ignition switch is in the “ON” position, the Vehicle Dynamic Control (VDC) warning light illuminates and then turns off.

The warning light blinks when the VDC system is operating.

When the warning light blinks while driving, the driving condition is slippery and the vehicle’s traction limit is about to be exceeded.

If the warning light illuminates when the ignition switch is placed in the “ON” position, it may indicate that the VDC or hill start assist system is not functioning properly and may need servicing. Have the system checked, and if necessary repaired, by a NISSAN dealer promptly.

If a malfunction occurs the VDC or hill start assist function is turned off, but the vehicle is still driveable. (See “Vehicle Dynamic Control (VDC) system” (P.5-12) and “Hill start assist system” (P.5-14).)

INDICATOR LIGHTS

 ECO mode system indicator light (if equipped)

The ECO mode system indicator light illuminates when the ECO mode system is turned on.

(See "ECO mode system" (P.5-20).)

 Engine start operation indicator light

This light appears when the shift lever is in the "P" (Park) position. This light means that the engine will start by pushing the ignition switch with the brake pedal depressed. You can start the engine directly in any position.

 Forward emergency braking system off indicator light (if equipped)

The forward emergency braking system off indicator light illuminates when the forward emergency braking system is turned off.

(See "Forward emergency braking system" (P.5-17).)

 Front fog lights indicator light (if equipped)

The front fog lights indicator light illuminates when the front fog lights are on. (See "Fog light switch" (P.2-20).)

 High beam indicator light

The high beam indicator light illuminates when the headlight high beam is "ON". The indicator turns off when the low beam is selected. (See "Headlight and turn signal switch" (P.2-18).)

 Idling Stop System indicator light

The Idling Stop System indicator light illuminates in the meter when the Idling Stop System is activated or is in the ready state.

The Idling Stop System indicator light blinks at a high speed when the engine hood is open.

The Idling Stop System indicator light blinks at a low speed, when the Idling Stop System is malfunctioning.

NOTE:

- **When the Idling Stop System indicator light blinks at a high speed (twice approximately every 1 second), be sure to check if the engine hood is open. When the engine hood is opened the engine will be in the normal stopped state. In this case, restart the engine with the ignition switch.**
- **When the Idling Stop System indicator light blinks at a low speed (once approximately every 2 seconds), have the system checked, and if necessary repaired, by a NISSAN dealer promptly.**
- **Even if the Idling Stop System indicator light illuminates before stopping your vehicle, the Idling Stop System may not activate when you are driving on an uphill or downhill grade, or when the steering wheel is operated, etc.**

 Low temperature indicator light (green) (if equipped)

The low temperature indicator light illuminates when the engine coolant temperature is low.

When the ignition switch is in the "ON" position, after the high temperature warning light (red) illuminates for 1 second, the low temperature indicator light illuminates and then turns off. After this indicators that the engine coolant has warmed up.

If the low temperature indicator light stays illuminated after the engine has sufficiently warmed up, it may indicate the low temperature sensor in the engine coolant system is not functioning properly and may need servicing. Have the system checked, and if necessary repaired, by a NISSAN dealer promptly.

If the light illuminates in red, it may indicate that the engine temperature is extremely high. (See "High temperature warning light (red)" (P.2-14).)

 Malfunction Indicator Light (MIL)



CAUTION:

- **Continuing vehicle operation without proper servicing of the engine control system could lead to poor driveability, reduced fuel economy, and damage to the engine control system, which may affect the vehicle's warranty coverage.**
- **Incorrect setting of the engine control system may lead to non-compliance of local and national emission laws and regulations.**

When the ignition switch is in the "ON" position, the Malfunction Indicator Light (MIL) illuminates. After starting the engine, the MIL turns off. This indicates

that the engine control system is operational.

If the MIL illuminates while the engine is running, it may indicate that the engine control system is not functioning properly and may need servicing. Have the vehicle checked, and if necessary repaired, by a NISSAN dealer promptly.

If the MIL blinks while the engine is running, it may indicate a potential malfunction in the emission control system. In this case, the emission control system may not function properly and may need servicing. Have the system checked, and if necessary repaired, by a NISSAN dealer promptly.

To reduce or avoid possible damage to the engine control system when the MIL blinks:

- Avoid driving at speeds above 70 km/h (45 MPH).
- Avoid sudden acceleration or deceleration.
- Avoid going up steep uphill grades.
- Avoid carrying or towing unnecessary loads.



Security indicator light

The security indicator light blinks when the ignition switch is in the "LOCK", "OFF" or "ACC" position. This function indicates the security system equipped on the vehicle is operational.

If security system is malfunctioning, this light will remain on while the ignition switch is in the "ON" position. (See "Security system" (P.3-12) for additional information.)



Small light indicator light

The small light indicator light illuminates when the front clearance lights, instrument panel lights, rear combination lights and license plate lights are on. The indicator light turns off when these lights are turned off.



SPORT mode indicator light

When the ignition switch is in the "ON" position, the SPORT mode indicator light illuminates and then turns off.

The SPORT mode indicator light illuminates when the SPORT mode is turned "ON". (See "Driving with Continuously Variable Transmission (CVT)" (P.5-7) for the use of the SPORT mode switch.)



Turn signals/hazard indicator lights

The turn signals/hazard indicator lights blink when the turn signal switch lever or hazard indicator flasher switch is "ON". (See "Headlight and turn signal switch" (P.2-18) or "Hazard indicator flasher switch" (P.6-2).)



Vehicle Dynamic Control (VDC) off indicator light

When the ignition switch is in the "ON" position, the Vehicle Dynamic Control (VDC) off indicator light illuminates and then turns off.

The Vehicle Dynamic Control (VDC) off indicator light illuminates when the VDC off switch is pushed to the "OFF" position.

When the VDC off switch is pushed to the "OFF" position, the VDC system is turned off. (See "Vehicle Dynamic Control (VDC) system" (P.5-12).)

AUDIBLE REMINDERS

Brake pad wear warning

The disc brake pads have audible wear warnings. When a brake pad requires replacement, it will make a high pitched scraping sound when the vehicle is in motion. This scraping sound will first occur only when the brake pedal is depressed. After more wear of the brake pad, the sound will always be heard even if the brake pedal is not depressed. Have the brakes checked as soon as possible if the wear warning sound is heard.

Have the system checked, and if necessary repaired, by a NISSAN dealer promptly. (See "Brakes" (P.8-11).)



Key reminder chime

The key reminder chime will sound if the driver's door is opened while the ignition switch is in the "ACC" position.

Be sure that the ignition switch is switched to the "LOCK" position when the door is opened, and carry the Intelligent Key with you when leaving the vehicle.

For the Intelligent Key system, an inside or outside chime will sound under some conditions. When a chime sounds, be sure to check both the vehicle and the Intelligent Key. (See "Intelligent Key system" (P.3-4).)

Light reminder chime

The light reminder chime will sound if the driver's door is opened while the headlight switch is in the  or  position and the ignition switch is in the "ACC", "OFF" or "LOCK" position.

Be sure to turn the light switch to the "OFF" position when you leave the vehicle.

HEADLIGHT AND TURN SIGNAL SWITCH

Parking brake reminder chime

The parking brake reminder chime will sound if the vehicle is driven at more than 7 km/h (4 MPH) with the parking brake applied. Stop the vehicle and release the parking brake.

Seat belt warning chime (if equipped)

When the vehicle speed exceeds 15 km/h (9 MPH), the chime will sound unless the driver's seat belt is securely fastened. The chime will continue to sound for about 90 seconds until the seat belt is fastened.

Idling Stop System reminder buzzer

The Idling Stop System reminder buzzer will sound if the engine hood is opened while the Idling Stop System is activated.

Be sure to check if the engine hood is open. When the engine hood is opened the engine will be in the normal stopped state. In this case, restart the engine with the ignition switch.

HEADLIGHT SWITCH

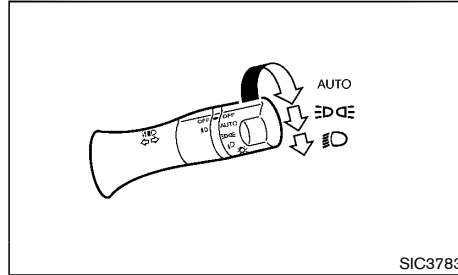

NISSAN recommends that you consult the local regulations concerning the use of lights.

AUTO position (if equipped)

When the ignition switch is in the "ON" position and the headlight switch is in the "AUTO" position, the headlights, front clearance lights, instrument panel lights, rear combination light, and other lights turn on automatically depending on the brightness of the surroundings.

The headlights will turn on automatically at twilight or in rainy weather (when the windshield wiper is operated continuously).

When the ignition switch is placed in the "OFF" position, the lights will turn off automatically.

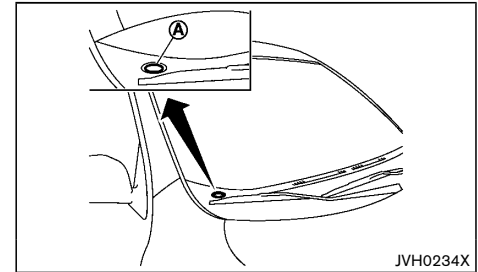

Example



CAUTION:

Do not place any objects on top of the sensor (A). The sensor senses the brightness level and controls the autolight function. If the sensor is covered, it reacts as if it is dark, and the headlights will illuminate.

☰☲☱ position

The ☰☲☱ position turns on the front clearance lights, instrument panel lights, rear combination lights and other lights.

☰☲ position

The ☰☲ position turns on the headlights in addition to the other lights.

Headlight beam

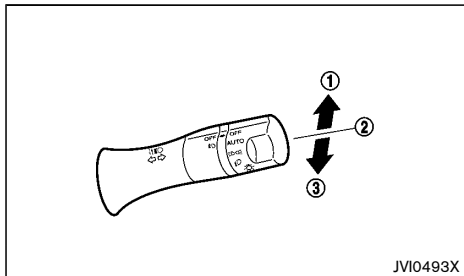

To turn on the high beam, push the lever towards the front position ①.

To turn off the high beam, return the lever to the neutral position ②.

To flash the headlights, pull the lever towards the rearmost position ③. The headlights can be flashed even when the headlights are not on.

BATTERY SAVER SYSTEM

The light reminder chime will sound if the driver's door is opened while the following operation is found:

- The headlight switch is in either the ㄇㄨㄛ or ㄇㄨㄛ position, and the ignition switch in the "ACC", "OFF" or "LOCK" position.

Be sure to turn the headlight switch to the "OFF" position when you leave the vehicle.

If the doors are closed and locked with the remote controller, the Intelligent Key or the door request switch while the headlight switch is in either the ㄇㄨㄛ or ㄇㄨㄛ position, the battery saver function will turn off the lights to prevent the battery from being discharged. The lights will turn on when the doors are being opened.

⚠ CAUTION:

Do not leave the lights on when the engine is not running for extended periods of time to prevent the battery from being discharged.

HEADLIGHT AIMING CONTROL

Manual type

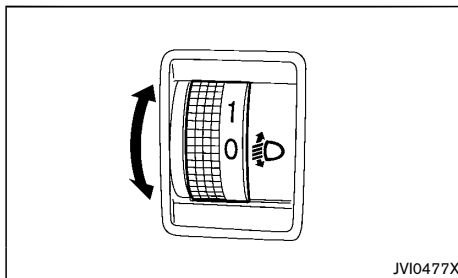

The headlight aiming control operates when the ignition switch is in the "ON" position and the headlight is on to allow the headlight axis to be adjusted according to the driving condition.

When driving with no heavy load/luggage or driving on a flat road, select the normal position "0".

If the number of occupants and load/luggage in the vehicle changes, the headlight axis may become higher than normal.

If the vehicle is traveling on a hilly road, the headlights may directly shine on the rearview and outside mirrors of a vehicle ahead or the windshield of an oncoming vehicle, which may obscure other drivers' vision.

To adjust to the proper aiming height, turn the switch accordingly. The higher the number designated on the switch, the lower the headlight axis.

Select the switch position by referring to the following samples.

For Thailand:

Switch position	Number of front seat occupants	Number of rear seat occupants	Weight of load in luggage compartment
0	1 or 2	No occupants	No load
1	2	3	No load to approximately 29 kg (13.15 lb)
2	1	No occupants	Approximately 248 kg (112.49 lb)

Except for Thailand:

Switch position	Number of front seat occupants	Number of rear seat occupants	Weight of load in luggage compartment
0	1 or 2	No occupants	No load
1	2	3	No load
2	2	3	Approximately 126 kg (278 lb)
3	1	No occupants	Approximately 343 kg (756 lb)

Automatic type

For the vehicle equipped with the automatic leveling system, the headlight axis is controlled automatically.

TURN SIGNAL SWITCH

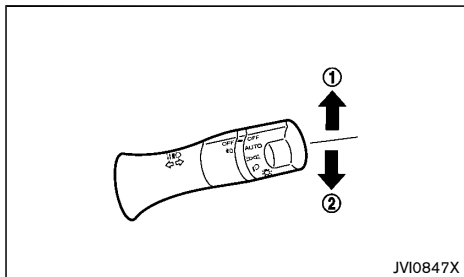

CAUTION:

The turn signal switch will not be cancelled automatically if the steering wheel turning angle does not exceed the preset amount. After the turn or lane change, make sure that the turn signal switch is returned to its original position.

Turn signal

To turn on the turn signals, move the lever up ① or down ② towards the desired direction. When the turn is completed, the turn signal cancels automatically.

Lane change signal



To turn on the lane change signals, move the lever up ① or down ② towards the desired direction.

To cancel the flashing, move the lever to the opposite direction.

FOG LIGHT SWITCH (if equipped)

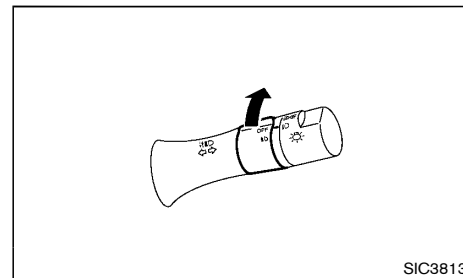
FRONT FOG LIGHTS



To turn on the front fog lights, turn the fog light switch to the  position with the headlight switch in the  or  position.

To turn off the fog lights, turn the fog light switch to the "OFF" position.

WIPER AND WASHER SWITCH

WARNING:

In freezing temperatures, the washer fluid may freeze on the windshield and obscure your vision. Warm the windshield with the defogger before you wash the windshield.

CAUTION:

- Do not operate the washer continuously for longer than 30 seconds.
- Do not operate the washer if the window washer fluid reservoir is empty.
- If the wiper operation is interrupted by snow or ice, the wiper may stop moving to protect its motor. If this occurs, turn the wiper switch to the “OFF” position and remove the snow or ice on and around the wiper arms. In approximately 1 minute, turn the switch on again to operate the wiper.

WINDSHIELD WIPER AND WASHER SWITCH

The windshield wiper and washer operate when the ignition switch is in the “ON” position.

Wiper operation

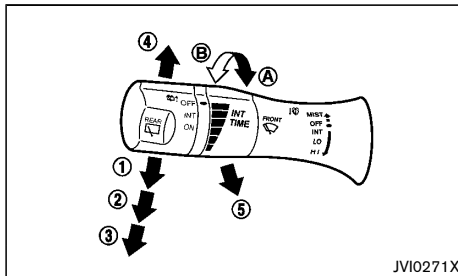

The lever position ① operates the wiper intermittently.

- The intermittent operation can be adjusted by turning the adjustment control knob, (longer) A or (shorter) B .
- The speed of the intermittent operation varies depending on the vehicle speed.

The lever position “LO” ② operates the wiper at low speed.

The lever position “HI” ③ operates the wiper at high speed.

To stop the wiper operation, move the lever up to the “OFF” position.

The lever position “MIST” ④ operates the wiper for one sweep. The lever automatically returns to its original position.

Washer operation

To operate the washer, pull the lever toward the back of the vehicle ⑤ until the desired amount of washer fluid is spread on the windshield. The wiper will automatically operate several times.

REAR WINDOW WIPER AND WASHER SWITCH

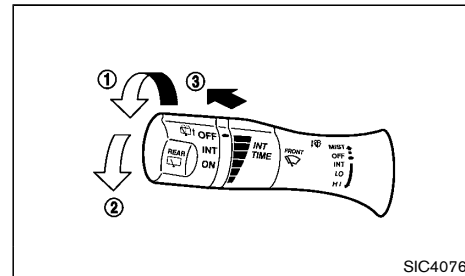

The rear window wiper and washer operates when the ignition switch is in the “ON” position.

Wiper operation

The switch position “INT” ① operates the wiper intermittently.

The switch position “ON” ② operates the wiper continuously.

To stop the wiper operation, turn the switch to the “OFF” position.

DEFOGGER SWITCH

Washer operation

To operate the washer, push the lever toward the front of the vehicle ③ until the desired amount of washer fluid is spread on the rear window. The wiper will automatically operate several times.

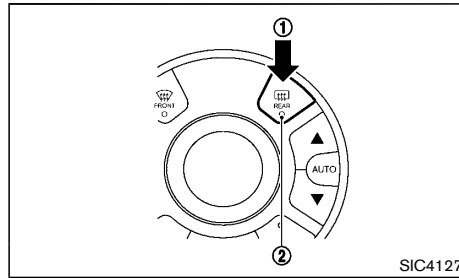

Type A

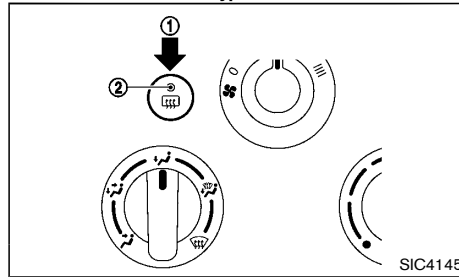

Type B

The rear window defogger switch operates when the ignition switch is in the "ON" position.

The defogger is used to reduce the moisture, fog or frost on the rear window surface to improve the rear view.

When the defogger switch ① is pushed, the indicator light ② illuminates and the defogger operates for approximately 15 minutes. After the preset time has passed, the defogger will turn off automatically.

To turn off the defogger manually, push the defogger switch again.



CAUTION:

- When operating the defogger continuously, be sure to start the engine. Otherwise, it may cause the battery to discharge.
- When cleaning the inner side of the window, be careful not to scratch or damage the electrical conductors on the surface of the window.

HORN

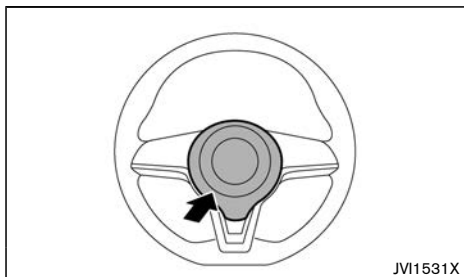

The horn switch operates regardless of the ignition switch position except when the battery is discharged.

When the horn switch is pushed and held, the horn will sound. Releasing the horn switch will cease the horn sound.

WINDOWS

POWER WINDOWS



WARNING:

- **Make sure that all passengers have their hands, etc. inside the vehicle before operating the power windows.**
- **To help avoid risk of injury or death through unintended operation of the vehicle and or its systems, including entrapment in windows or inadvertent door lock activation, do not leave children, people who require the assistance of others or pets unattended in your vehicle. Additionally, the temperature inside a closed vehicle on a warm day can quickly become high enough to cause a significant risk of injury or death to people and pets.**

The power windows operate when the ignition switch is in the "ON" position.

To open a window, push down the power window switch.

To close a window, pull up the power window switch.

Driver's window switch

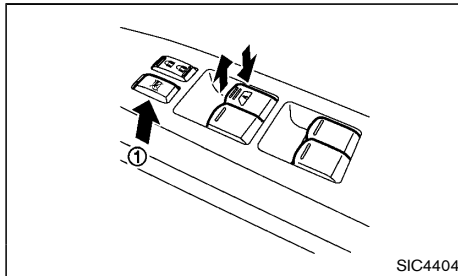

The driver's switch, which is the main switch, can control all windows.

Locking passengers' windows:

When the lock button ① is pushed in, the passengers' windows cannot be operated.

To cancel the passengers' windows lock, push the lock button ① again.

Passenger's window switch

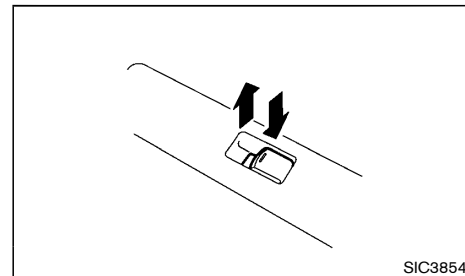

The passenger's switch can control its corresponding window.

When the passenger's windows lock button on the driver's switch is pushed in, the passenger's switch cannot be operated.

Automatic function

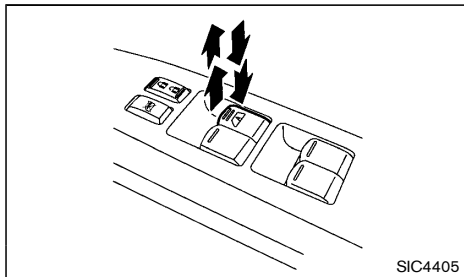

Automatic function is available for the switch that has an **A** mark on its surface.

The automatic function enables a window to fully open or close without holding the switch down or up.

To fully open the window, push the power window switch down to the second detent and release the switch. To fully close the window, pull the power window switch up to the second detent and release the switch. The switch does not have to be held during window operation.

To stop the window open/close operation during the automatic function, push down or pull up the switch in opposite directions.

Window timer (if equipped):

The window timer allows the driver's window to be operated for approximately 15 minutes even if the ignition switch is pushed to the "ACC", "OFF" or "LOCK" position. The window timer will be cancelled when the corresponding door is opened and closed, or the preset time has been exceeded.

Auto-reverse function:



WARNING:

There is a small distance just before the closed position which cannot be detected. Make sure that all passengers have their hands, etc. inside the vehicle before closing the windows.

The auto-reverse function enables a window to automatically reverse when something is caught in the window as it is closing by the automatic function. When the control unit detects an obstacle, the window will be lowered immediately.

Depending on the environment or driving conditions, the auto-reverse function may activate if an impact or load similar to something being caught in the window occurs.

When power window switch does not operate

Some power window functions (automatic close function, auto-reverse function) will not operate as described after the battery cable is disconnected and the electrical supply is interrupted. Perform the following procedure to initialize the power window functions.

1. Place the ignition switch in the "ON" position.
2. If the driver's window is closed, open it completely by operating the driver's window switch.
3. Pull up and hold the driver's window switch to close the driver's window. Hold the switch for approximately 3 seconds after the window has been fully closed, and then release it.
4. Check if the power window functions operate properly.

If you open or close the power window continuously, it

may cause the power window not to operate properly. Perform the above procedure.

If the power window functions do not operate properly after performing the above procedure, repeat the steps. See a NISSAN dealer, if necessary, for checking the power window system.

CLOCK

If the battery cable is disconnected, the clock will be reset and the correct time will not be indicated. Readjust the time.

ADJUSTING TIME

Type A

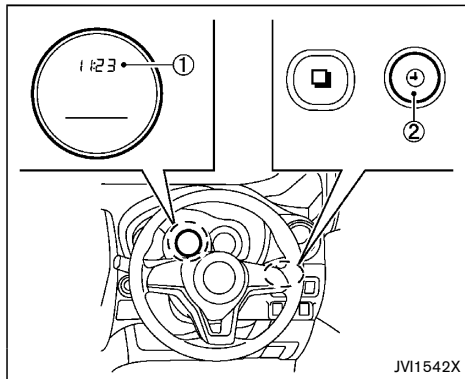

The digital clock (1) in the vehicle information display the time when the ignition switch is in the "ON" position.

To display the clock, push the clock settings switch (2). To adjust the time, perform the following procedure.

1. Push the clock settings switch (2) for 1.5 seconds or more to enter clock adjusting mode.
2. Push the clock settings switch (2) to adjust the hour.
Wait at least 3 seconds for the minute display to flash.

3. Push the clock settings switch (2) to adjust the minutes.
To advance the time, hold down the switch (2).
Wait at least 3 seconds for the second display ":" to flash.

The selected values will be stored if no user input is detected for 60 seconds, or can be reset by using the clock settings switch (2).

The digital clock can be switched between 24-hour display and 12-hour display when the clock settings switch (2) is pushed briefly.

Type B

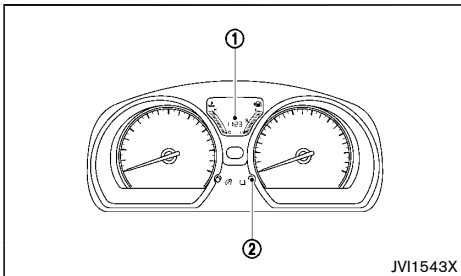

The digital clock (1) in the vehicle information display the time when the ignition switch is in the "ON" position. To adjust the time, perform the following procedure:

1. If the clock settings switch (2) is pushed while the distance to empty is displayed, the clock display will blink.
2. Push the clock settings switch (2) for 1.5 seconds. The hours display will start to flash.

3. Push the clock settings switch (2) to adjust the hour. To advance the time, hold down the switch (2).
Wait at least 3 seconds for the minute display to flash.
4. Push the clock settings switch (2) to adjust the minutes. To advance the time, hold down the switch (2). Wait at least 3 seconds for the second display ":" to flash.
The selected values will be stored if no user input is detected for 60 seconds, or can be reset by using the clock settings switch (2).

POWER OUTLET

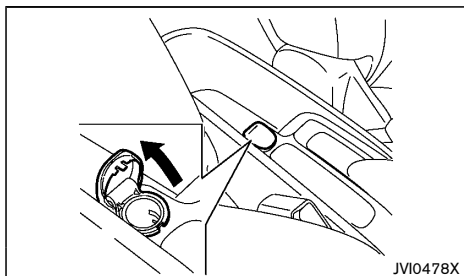

The power outlet is for powering electrical accessories such as cellular telephone.

CAUTION:

- The outlet and plug may be hot during or immediately after use.
- This power outlet is not designed for use with a cigarette lighter unit.
- Do not use with accessories that exceed a 12 volt, 120W (10A) power draw. Do not use double adapters or more than one electrical accessory.
- Use power outlet with the engine running to avoid discharging the vehicle battery.
- Avoid using power outlet when the air conditioner, headlights or rear window defogger is on.
- Before inserting or disconnecting a plug, be sure to turn off the power switch of electrical accessory being used and the ignition switch.
- Push the plug in as far as it will go. If good contact is not made, the plug may overheat or the internal temperature fuse may open.

- Do not allow water to contact the outlet.
- When not in use, be sure to close the cap.

STORAGE

WARNING:

- The storages should not be used while driving so full attention may be given to vehicle operation.
- Keep the storage lids closed while driving to help prevent injury in an accident or a sudden stop.

GLOVE BOX

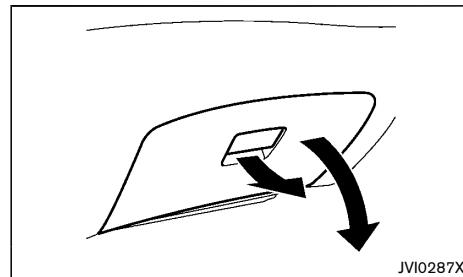

To open the glove box, pull the handle.

To close, push the lid in until the lock latches.

The card holder is on the back side of the lid.

UPPER INSTRUMENT BOX

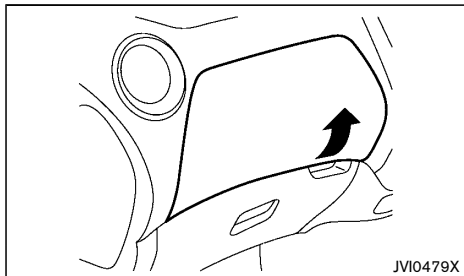

To open the upper instrument box, pull the lid.

To close, push the lid down.

CARD HOLDER

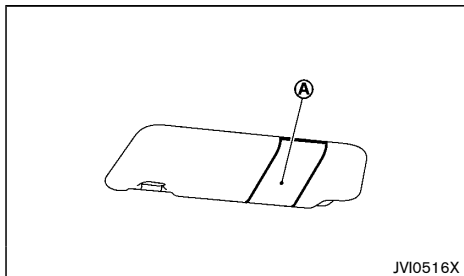

Slide a card in the card holder **A** .

CUP HOLDERS

CAUTION:

Avoid abrupt starting and braking especially when the cup holder is being used to prevent spilling the contents. If the contents are hot, they could scald you or your passengers.

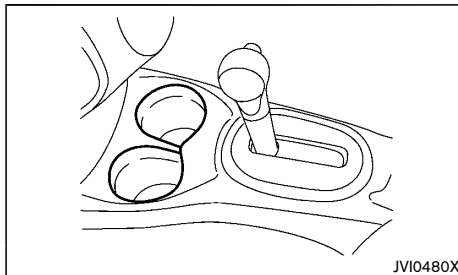

SOFT BOTTLE HOLDER

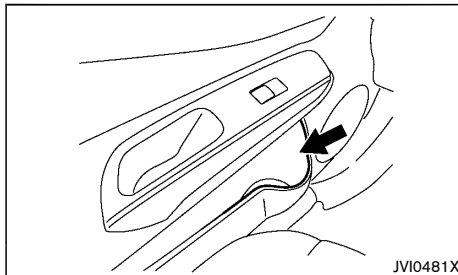

CAUTION:

- Do not use bottle holder for any other objects that could be thrown about in the vehicle and possibly injure people during sudden braking or an accident.
- Do not use bottle holder for open liquid containers.

LUGGAGE HOOKS

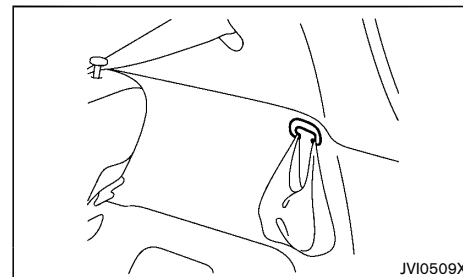

The luggage hooks are for shopping bags, etc.

WARNING:

- Do not apply a total load of more than 3 kg (7 lb) to the hook.

SUN VISORS

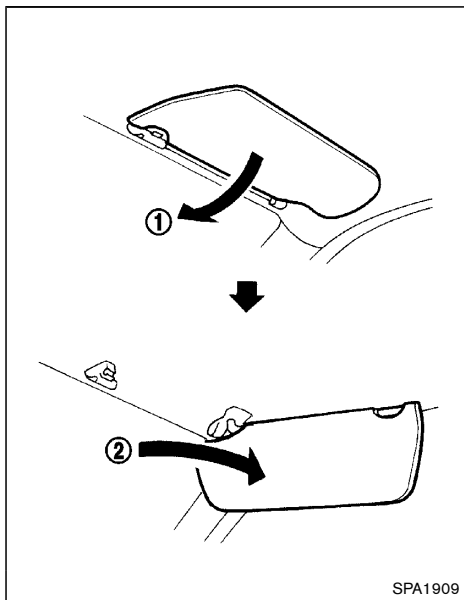

1. To block out glare from the front, swing down the sun visor ①.
2. To block glare from the side, remove the sun visor from the center mount and swing it to the side ②.

INTERIOR LIGHTS



CAUTION:

- Do not leave the light switch on when the engine is not running for extended periods of time to prevent the battery from being discharged.
- Turn off the lights when you leave the vehicle.

MAP LIGHT / ROOM LIGHT

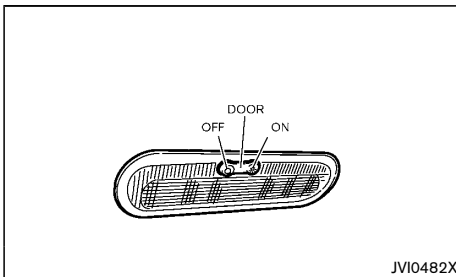

The map light or room light control switch has three positions: ON , OFF, DOOR.

ON position

When the switch is in the ON position, the map light or room light will illuminate.

OFF position

When the switch is in the OFF position, the map light or room light will not illuminate, regardless of the condition.

Center position (DOOR)

When the switch is in the DOOR position, the map light or room light will illuminate under the following conditions:

- ignition switch is placed in the "OFF" position
 - remain on for about 15 seconds.
- doors are unlocked by pushing the "UN-LOCK"  button (on the Intelligent Key) or the request switch , with the ignition switch in the "LOCK" position
 - remain on for about 15 seconds.
- any door is opened and then closed with the ignition switch in the "LOCK" position
 - remain on for about 15 seconds.
- any door is opened with the ignition switch in the "ACC" or "ON" position
 - remain on while the door is opened. When the door is closed, the lights turn off.

Battery saver system

If any door is left open for a period of time with the map light or room light switch in the DOOR position, the map light or room light will automatically turn off.

3 Pre-driving checks and adjustments

Keys	3-2	Hood	3-12
Intelligent Key	3-2	Opening hood	3-13
Doors	3-3	Closing hood	3-13
Locking with key	3-3	Rear hatch	3-13
Locking with inside lock knob	3-3	Opening rear hatch	3-14
Locking with power door lock switch	3-4	Closing rear hatch	3-14
Child safety rear door lock	3-4	Secondary rear hatch unlock/lock	3-14
Intelligent Key system	3-4	Fuel-filler lid	3-15
Operating range	3-6	Opening fuel-filler lid	3-15
Using Intelligent Key system	3-6	Fuel-filler cap	3-15
Battery saver system	3-8	Steering wheel	3-15
Warning and audible reminders	3-8	Mirrors	3-16
Troubleshooting guide	3-9	Inside rearview mirror	3-16
Using remote keyless entry system	3-10	Outside rearview mirrors	3-16
Hazard indicator and outside chime operation	3-10	Vanity mirror	3-17
Security system	3-12	Parking brake	3-17
NISSAN anti-theft system (NATS)	3-12		

KEYS

Your vehicle can only be driven with the keys specific to your vehicle. A key number plate is supplied with your key. Record the key number and keep the key number plate in a safe place, except in the vehicle, in case of the need to duplicate the keys.

The key can only be duplicated using an original key or the original key number. The key number is required when you have lost all of the keys and do not have the original key to duplicate from. If the key is lost, or you need extra keys, provide an original key or the key number to a NISSAN dealer.



CAUTION:

Do not leave the keys inside the vehicle when leaving the vehicle.

INTELLIGENT KEY

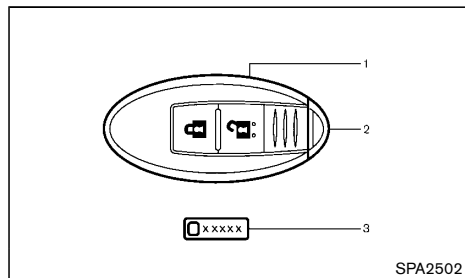

1. Intelligent Key (2 sets)
2. Mechanical key (inside the Intelligent Key) (2 sets)
3. Key number plate

Your vehicle can only be driven with the Intelligent Keys, which are registered to your vehicle's Intelligent Key system components and NISSAN Anti-Theft

System (NATS*) components. As many as 4 Intelligent Keys can be registered and used with one vehicle. The new keys must be registered by a NISSAN dealer prior to use with the Intelligent Key system and NATS of your vehicle. Since the registration process requires erasing all memory in the Intelligent Key components when registering new keys, be sure to take all Intelligent Keys that you have to the NISSAN dealer.

*: Immobilizer



CAUTION:

- **Be sure to carry the Intelligent Key with you. Do not leave the vehicle with the Intelligent Key inside.**
- **Be sure to carry the Intelligent Key with you when driving. The Intelligent Key is a precision device with a built-in transmitter. To avoid damaging it, please note the following.**
 - The Intelligent Key is water resistant; however, wetting may damage the Intelligent Key. If the Intelligent Key gets wet, immediately wipe until it is completely dry.
 - Do not bend, drop or strike it against another object.
 - If the outside temperature is below -10°C (14°F), the battery of the Intelligent Key may not function properly.
 - Do not place the Intelligent Key for an extended period in a place where temperatures exceed 60°C (140°F).
 - Do not change or modify the Intelligent Key.

- Do not use a magnet key holder.
- Do not place the Intelligent Key near equipment that produces a magnetic field such as a TV, audio equipment and personal computers or cellular phones.
- Do not allow the Intelligent Key to come into contact with water or salt water, and do not wash it in a washing machine. This could affect the system function.
- If an Intelligent Key is lost or stolen, NISSAN recommends erasing the ID code of that Intelligent Key. This will prevent the Intelligent Key from unauthorized use to unlock the vehicle. For information regarding the erasing procedure, please contact a NISSAN dealer.

Mechanical key

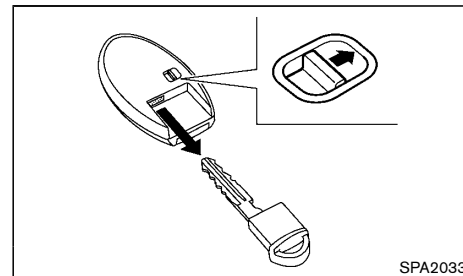

To remove the mechanical key, release the lock knob at the back of the Intelligent Key.

To install the mechanical key, firmly insert it into the Intelligent Key until the lock knob returns to the lock

3-2 Pre-driving checks and adjustments

DOORS

position.

Use the mechanical key to lock or unlock the doors. See "Doors" (P.3-3).



WARNING:

- **Always look before opening any doors, to avoid an accident with oncoming traffic.**
- **To help avoid risk of injury or death through unintended operation of the vehicle and or its systems, including entrapment in windows or inadvertent door lock activation, do not leave children, people who require the assistance of others or pets unattended in your vehicle. Additionally, the temperature inside a closed vehicle on a warm day can quickly become high enough to cause a significant risk of injury or death to people and pets.**

LOCKING WITH KEY

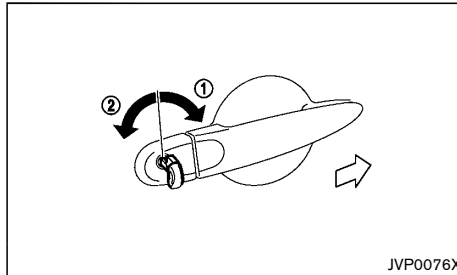

To lock the driver's door, insert the key to the door cylinder located on the driver's side door and turn the key to the front of the vehicle ①.

For locking other doors and the rear hatch, use the power door lock switch. (See "Locking with power door lock switch" (P.3-4).)

To unlock the driver's door, turn the key to the rear of the vehicle ②.

For unlocking other doors and the rear hatch, use the power door lock switch. (See "Locking with power door lock switch" (P.3-4).)

LOCKING WITH INSIDE LOCK KNOB

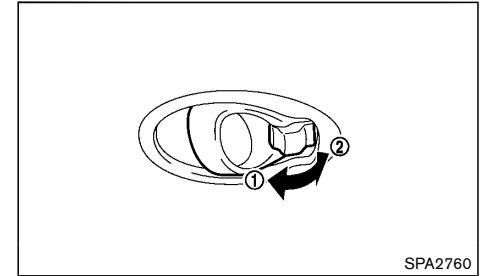

CAUTION:

When locking the doors using the inside lock knob, be sure not to leave the key in the vehicle.

To lock the front doors, push the inside lock knob to the lock position ①, and then close the door while pulling the door handle.

To lock the rear doors, push the inside lock knob to the lock position ① and then close the door.

To unlock, pull the inside lock knob to the unlock position ②.

When the driver's door is locked, pulling the driver's side door handle will unlock the door.

LOCKING WITH POWER DOOR LOCK SWITCH

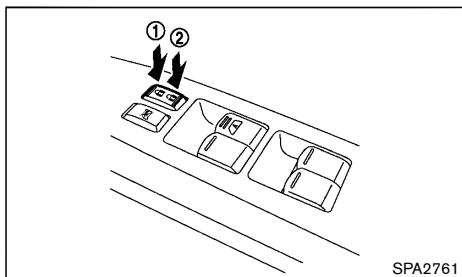

CAUTION:

When locking the doors using the power door lock switch, be sure not to leave the key in the vehicle.

To lock the doors, push the power door lock switch to the lock position ①.

To unlock, push the power door lock switch to the unlock position ②.

CHILD SAFETY REAR DOOR LOCK

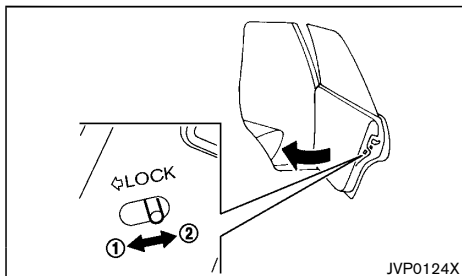

The child safety rear door locks help prevent rear doors from being opened accidentally, especially when small children are in the vehicle.

When the levers are in the lock position ①, the child safety rear door locks engage and the rear doors can only be opened by the outside door handles.

To disengage, move the levers to the unlock position ②.

INTELLIGENT KEY SYSTEM

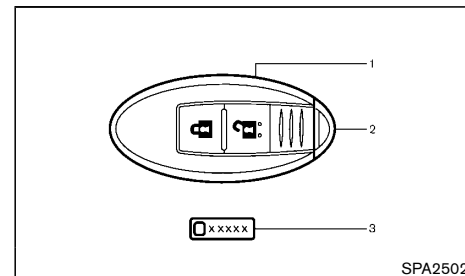

1. Intelligent Key (2 sets)
2. Mechanical key (inside the Intelligent Key) (2 sets)
3. Key number plate



WARNING:

- **Radio waves could adversely affect electric medical equipment. Those who use a pace-maker should contact the electric medical equipment manufacturer for the possible influences before use.**
- **The Intelligent Key transmits radio waves when the buttons are pushed. The radio waves may affect aircraft navigation and communication systems. Do not operate the Intelligent Key while on an airplane. Make sure the buttons are not operated unintentionally when the unit is stored during a flight.**

The Intelligent Key system can be used to operate all the doors and the rear hatch locks using the remote controller function or pushing the request switch on the vehicle without taking the key out from a pocket or purse. The operating environment and/or conditions

may affect the Intelligent Key system operation.

Be sure to read the following before using the Intelligent Key system.



CAUTION:

- **Be sure to carry the Intelligent Key with you when operating the vehicle.**
- **Never leave the Intelligent Key in the vehicle when you leave the vehicle.**
- **When the outside temperature is extremely low, the Intelligent Key system may not function properly.**

The Intelligent Key is always communicating with the vehicle as it receives radio waves. The Intelligent Key system transmits weak radio waves. Environmental conditions may interfere with the operation of the Intelligent Key system under the following operating conditions.

- When operating near a location where strong radio waves are transmitted, such as a TV tower, power station and broadcasting station.
- When in possession of wireless equipment, such as a cellular telephone, transceiver, and CB radio.
- When the Intelligent Key is in contact with or covered by metallic materials.
- When any type of radio wave remote control is used nearby.
- When the Intelligent Key is placed near an electric appliance such as a personal computer.
- When the vehicle is parked near a parking meter.

In such cases, correct the operating conditions before using the Intelligent Key function or use the mechanical key.

Although the life of the battery varies depending on the

operating conditions, the battery's life is approximately 2 years. If the battery is discharged, replace it with a new one.

For information regarding replacement of a battery, see "Intelligent Key battery" (P.8-18).

Since the Intelligent Key is continuously receiving radio waves, if the key is left near equipment which transmits strong radio waves, such as signals from a TV and personal computer, the battery life may become shorter.

When the battery is discharged, firmly apply the foot brake and touch the ignition switch with the Intelligent Key. Then push the ignition switch while depressing the brake pedal within 10 seconds after the chime sound. (See "Push-button ignition switch" (P.5-4).)

Because the steering wheel is locked electrically, unlocking the steering wheel with the ignition switch in the "LOCK" position is impossible when the vehicle battery is completely discharged. Pay special attention that the vehicle battery is not completely discharged.

As many as 4 Intelligent Keys can be used with one vehicle. For information about the purchase and use of additional Intelligent Keys, contact a NISSAN dealer.



CAUTION:

- **Do not allow the Intelligent Key, which contains electrical components, to come into contact with water or salt water. This could affect the system function.**
- **Do not drop the Intelligent Key.**
- **Do not strike the Intelligent Key sharply against another object.**
- **Do not change or modify the Intelligent Key.**

- **Wetting may damage the Intelligent Key. If the Intelligent Key gets wet, immediately wipe until it is completely dry.**
- **If the outside temperature is below -10°C (14°F), the battery of the Intelligent Key may not function properly.**
- **Do not place the Intelligent Key for an extended period in an area where temperatures exceed 60°C (140°F).**
- **Do not attach the Intelligent Key with a key holder that contains a magnet.**
- **Do not place the Intelligent Key near equipment that produces a magnetic field, such as a TV, audio equipment and personal computers or cellular phones.**

If an Intelligent Key is lost or stolen, NISSAN recommends erasing the ID code of that Intelligent Key from the vehicle. This may prevent the unauthorized use of the Intelligent Key to operate the vehicle. For information regarding the erasing procedure, contact a NISSAN dealer.

The Intelligent Key function can be disabled. For information about disabling the Intelligent Key function, contact a NISSAN dealer.

OPERATING RANGE

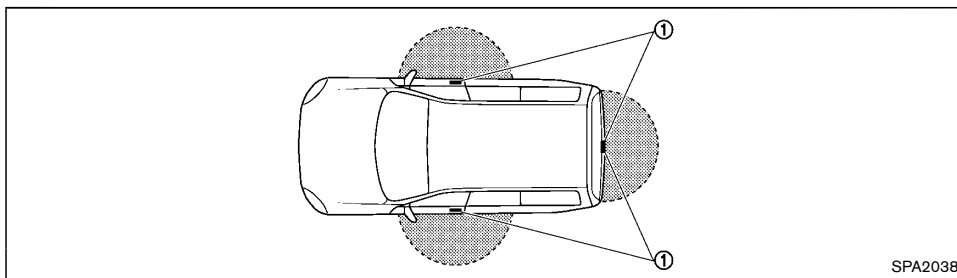

The Intelligent Key functions can only be used when the Intelligent Key is within the specified operating range from the request switch ①.

When the Intelligent Key battery is discharged or strong radio waves are present near the operating location, the Intelligent Key system's operating range becomes narrower, and the Intelligent Key may not function properly.

The operating range is within 80 cm (31.50 in) from each request switch ①.

If the Intelligent Key is too close to the door glass, handle or rear bumper the request switches may not function.

When the Intelligent Key is within the operating range, it is possible for anyone, even someone who does not carry the Intelligent Key, to push the request switch and lock/unlock the doors and the rear hatch.

USING INTELLIGENT KEY SYSTEM

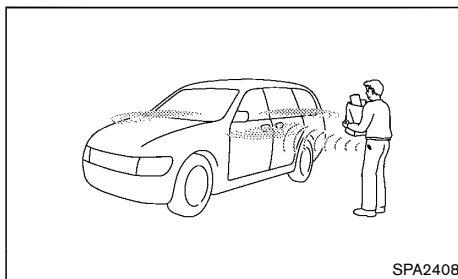

The request switch will not function under the following conditions:

- When the Intelligent Key is left inside the vehicle
- When the Intelligent Key is not within the operational range
- When any door is open or not closed securely
- When the Intelligent Key battery is discharged
- When the ignition switch is in the "ACC" or "ON" position

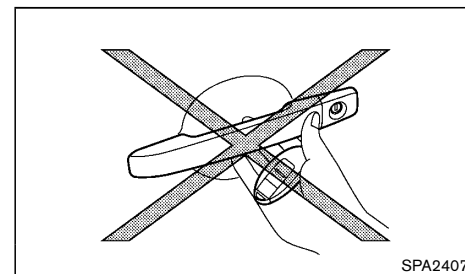

- Do not push the door handle request switch with the Intelligent Key held in your hand as illustrated. The close distance to the door handle will cause the Intelligent Key system to have difficulty recognizing that the Intelligent Key is outside the vehicle.
- After locking the doors using the door handle request switch, make sure that the doors have been securely locked by operating the door handles.
- When locking the doors using the door handle request switch, make sure to have the Intelligent Key in your possession before operating the door handle request switch to prevent the Intelligent Key from being left in the vehicle.
- The door handle request switch is operational only when the Intelligent Key has been detected by the Intelligent Key system.
- Do not pull the door handle before pushing the door handle request switch. The door will be unlocked but will not open. Release the door handle once and pull it again to open the door.

Request switch locations

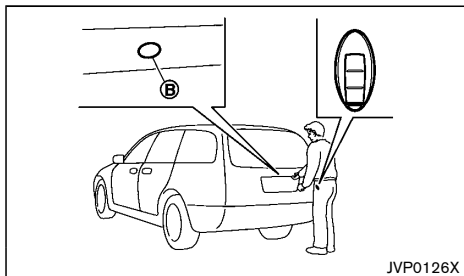
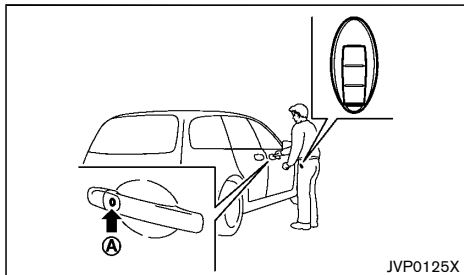

When you carry the Intelligent Key with you, you can lock or unlock all doors and the rear hatch by pushing the door handle request switch (driver's or front passenger's) **(A)** or rear hatch request switch **(B)** within the range of operation.

When you lock or unlock the doors and the rear hatch, the hazard indicator will flash and the outside chime will sound as a confirmation. For details, see "Hazard indicator and outside chime operation" (P.3-10).

Locking doors and rear hatch

1. Push the ignition switch to the "OFF" position.
2. Carry the Intelligent Key with you.
3. Close all doors and the rear hatch.
4. Push the door handle request switch **(A)** (driver's or front passenger's) or rear hatch request switch **(B)**.
5. All doors and the rear hatch will be locked.
6. Operate door handles to confirm that the doors have been securely locked.

Lockout protection:

To prevent the Intelligent Key from being accidentally locked in the vehicle, lockout protection is equipped with the Intelligent Key system.

- When the Intelligent Key is left in the vehicle and you try to lock the door using the driver's inside lock knob after getting out of the vehicle, all the doors will unlock automatically and a chime will sound after the door is closed.
- When the Intelligent Key is left in the vehicle while the driver's door is opened and you try to lock the door using the power door lock switch after getting out of the vehicle, all the doors will unlock automatically after the power door lock switch or the driver's inside lock knob is operated.



CAUTION:

The lockout protection may not function under the following conditions:

- **When the Intelligent Key is placed on top of the instrument panel.**
- **When the Intelligent Key is placed inside of the glove box.**

- **When the Intelligent Key is placed inside of the door pockets.**
- **When the Intelligent Key is placed on or under the luggage room area.**
- **When the Intelligent Key is placed inside or near metallic materials.**

The lockout protection may function when the Intelligent Key is outside the vehicle but is too close to the vehicle.

Unlocking doors and rear hatch

1. Carry the Intelligent Key with you.
2. Push the door handle request switch **(A)** or rear hatch request switch **(B)**.
3. All doors and the rear hatch will be unlocked.

If a door handle is pulled while unlocking the doors, that door may not be unlocked. Returning the door handle to its original position will unlock the door. If the door does not unlock, after returning the door handle, push the door handle request switch to unlock the door.

Automatic reload:

All doors and the rear hatch will be locked automatically unless one of the following operations is performed within 30 seconds after pushing the request switch while the doors are locked.

- Opening any doors.
- Pushing the ignition switch.

If during the preset time period the "UNLOCK"  button on the Intelligent Key is pushed, all doors and the rear hatch will be locked automatically after the next preset time.

BATTERY SAVER SYSTEM

When all the following conditions are met for a period of time, the battery saver system will cut off the power supply to prevent battery discharge.

- The ignition switch is in the "ACC" position, and
- All doors and the rear hatch are closed, and
- The shift lever is in the "P" (Park) position.

WARNING AND AUDIBLE REMINDERS

The Intelligent Key system is equipped with a function that is designed to minimize improper operations of the Intelligent Key and to help prevent the vehicle from being stolen. A chime or beep sounds inside and outside the vehicle and a warning light illuminates or blinks.

See the troubleshooting guide on the next page and "Warning lights, indicator lights and audible reminders" (P.2-12).

Intelligent Key system warning light: 

P position selecting warning light: 



CAUTION:

When the chime or beep sounds or the warning light illuminates or blinks, be sure to check both the vehicle and the Intelligent Key.

TROUBLESHOOTING GUIDE

Symptom	Possible cause	Action to take	
When pushing the ignition switch to stop the engine	The P position selecting warning light in the meter and the inside warning chime sounds continuously.	The shift lever is not in the "P" (Park) position.	Shift the shift lever to the "P" (Park) position.
When shifting the shift lever to the P (Park) position.	The inside warning chime sounds continuously.	The ignition switch is in the "ACC" or "ON" position.	Push the ignition switch to the "OFF" position.
When opening the driver's door to get out of the vehicle	The inside warning chime sounds continuously.	The ignition switch is in the "ACC" position.	Push the ignition switch to the "OFF" position.
When closing the door after getting out of the vehicle	The Intelligent Key system warning light in the meter blinks in yellow, the outside chime sounds 3 times and the inside warning chime sounds for a few seconds.	The ignition switch is in the "ACC" or "ON" position.	Push the ignition switch to the "OFF" position.
	The P position selecting warning light in the meter illuminates and the outside chime sounds continuously).	The ignition switch is in the "ACC" or "OFF" position and the shift lever is not in the "P" (Park) position.	Move the shift lever to the "P" (Park) position and push the ignition switch to the "OFF" position.
When closing the door with the inside lock knob turned to the "LOCK" position	The outside chime sounds for a few seconds and all the doors unlock.	The Intelligent Key is inside the vehicle.	Carry the Intelligent Key with you.
When pushing the request switch or the "LOCK"  button on the Intelligent Key to lock the door	The outside chime sounds for a few seconds and all the doors unlock.	The Intelligent Key is inside the vehicle.	Carry the Intelligent Key with you.
		The ignition switch is in the "ACC" or "ON" position.	Push the ignition switch to the "OFF" position.
		A door is not closed securely.	Close the door securely.
When pushing the door handle request switch to lock the door	The outside chime sounds for a few seconds.	The Intelligent Key is inside the vehicle.	Carry the Intelligent Key with you.
		A door is not closed securely.	Close the door securely.
When pushing the ignition switch to start the engine	The Intelligent Key system warning light in the meter blinks in green.	The battery charge is low.	Replace the battery with a new one. (See "Intelligent Key battery" (P.8-18).)
	The Intelligent Key system warning light in the meter blinks in yellow.	The Intelligent Key is not in the vehicle.	Carry the Intelligent Key with you.

USING REMOTE KEYLESS ENTRY SYSTEM

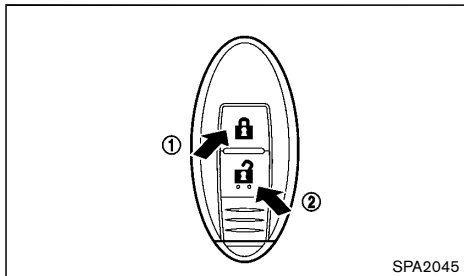

Operating range

The remote keyless entry system allows you to lock/unlock all doors and the rear hatch. The operating distance depends upon the conditions around the vehicle. To securely operate the lock and unlock buttons, approach the vehicle to about 1 m (3.3 ft) from the door.

The remote keyless entry system will not function under the following conditions:

- When the Intelligent Key is not within the operational range.
- When the Intelligent Key battery is discharged.

For information regarding the replacement of a battery, see "Intelligent Key battery" (P.8-18).

Locking doors and rear hatch

When you lock or unlock the doors and the rear hatch, the hazard indicator will flash and the outside chime will sound as a confirmation.

1. Place the ignition switch in the "OFF" position and carry the Intelligent Key.

2. Close all doors and the rear hatch.
3. Push the "LOCK"  button ① on the Intelligent Key.
4. All doors and the rear hatch will be locked.
5. Operate the door handles to confirm that the doors have been securely locked.





CAUTION:

After locking the doors using the Intelligent Key, be sure that the doors have been securely locked by operating the door handles.

Unlocking doors and rear hatch

1. Push the "UNLOCK"  button ② on the Intelligent Key.
2. All doors and the rear hatch will be unlocked.

Automatic relock :



All doors and the rear hatch will be locked automatically unless one of the following operations is performed within 30 seconds after pushing the "UNLOCK"  button on the Intelligent Key while the doors are locked. If during this 30-second time period, the "UNLOCK"  button on the Intelligent Key is pushed, all doors and the rear hatch will be locked automatically after another 30 seconds.

- Opening any doors and the rear hatch.
- Pushing the ignition switch.

HAZARD INDICATOR AND OUTSIDE CHIME OPERATION

When you lock or unlock the doors and the rear hatch with the request switch or the remote keyless entry function, the hazard indicator will flash and the outside chime will sound as a confirmation.

The following descriptions show how the hazard indicator and outside chime will activate when locking or unlocking the doors and the rear hatch.

Operation	DOOR LOCK	DOOR UNLOCK
Intelligent Key system (using door handle or rear hatch request switch)	HAZARD - once OUTSIDE CHIME - once	HAZARD - twice OUTSIDE CHIME - twice
Remote keyless entry system (using  or  button)	HAZARD - once OUTSIDE CHIME - once	HAZARD - twice OUTSIDE CHIME - twice

SECURITY SYSTEM

Your vehicle is equipped with NISSAN Anti-Theft System (NATS).

NISSAN ANTI-THEFT SYSTEM (NATS)

The NISSAN Anti-Theft System (NATS) will not allow the engine to start without the use of the registered NATS key.

If the engine does not start using the registered NATS key, it may be due to interference caused by:

- Another NATS key.
- Automated toll road device.
- Automated payment device.
- Other devices that transmit similar signals.

Start the engine using the following procedure:

1. Remove any items that may be causing the interference away from the NATS key.
2. Leave the ignition switch in the "ON" position for approximately 5 seconds.
3. Place the ignition switch in the "OFF" or "LOCK" position, and wait approximately 10 seconds.
4. Repeat steps 2 and 3 again.
5. Start the engine.
6. Repeat the steps above until all possible interferences are eliminated.

If this procedure allows the engine to start, NISSAN recommends placing the registered NATS key separate from other devices to avoid interference.

Security indicator light

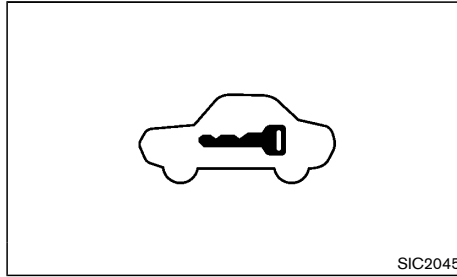

The security indicator light is located on the meter panel. It indicates the status of NATS.

The light operates whenever the ignition switch is in the "LOCK", "OFF" or "ACC" position. The security indicator light indicates that the security systems on the vehicle are operational.

If NATS is malfunctioning, this light will remain on while the ignition switch is in the "ON" position.

If the light remains on and/or the engine does not start, contact a NISSAN dealer for NATS service as soon as possible. Be sure to bring all NATS keys that you have when visiting a NISSAN dealer for service.

HOOD



WARNING:

- The hood must be closed and latched securely before driving. Failure to do so could cause the hood to fly open and result in an accident.
- Never open the hood if steam or smoke is coming from the engine compartment to avoid injury.

OPENING HOOD

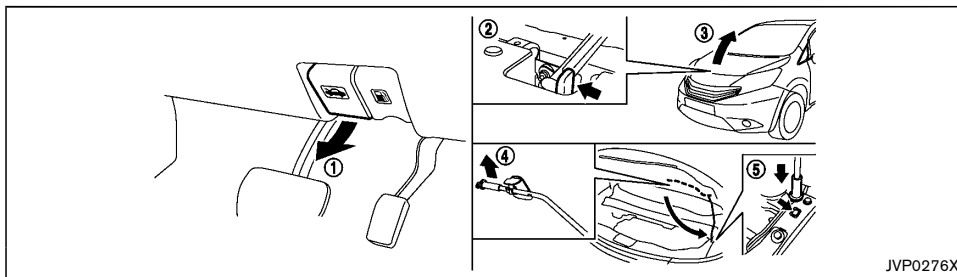

1. Pull the hood lock release handle ① located below the instrument panel until the hood springs up.
2. Locate the lever ② in between the hood and grille and push the lever sideways with your fingertips.
3. Raise the hood ③.
4. Remove the support rod ④ and insert it into the slot ⑤.

Avoid direct contact with the metal parts, as they may be hot immediately after the engine has been stopped.

CLOSING HOOD

1. While supporting the hood, return the support rod to its original position.
2. Slowly lower the hood to about 20 to 30 cm (8 to 12 in) above the hood lock, then let it drop.
3. Make sure it is securely latched.

REAR HATCH



WARNING:

- Make sure the rear hatch has been closed securely to prevent it from opening while driving.
- Do not drive with the rear hatch open. This could allow dangerous exhaust gases to be drawn into the vehicle.



CAUTION:

- Before opening the rear hatch, be sure to clear away snow, ice or dust that may be stuck to the rear hatch. If the rear hatch is opened while materials are still stuck to it, it may suddenly close again due to the weight of these materials.
- Always be sure to fully open the rear hatch. If it is not fully opened, it may suddenly shut.
- Be especially careful when opening the rear hatch in strong wind. The door could be caught by a gust of wind and may close suddenly.

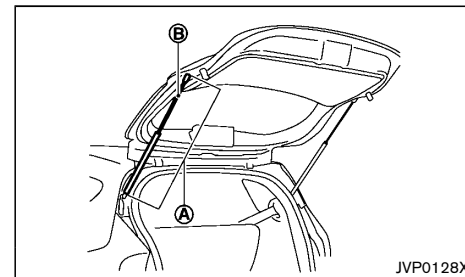

CAUTION:

- The rear hatch gas stays (A) are installed in order to support the weight of the rear hatch. In order to prevent the gas stays being damaged or not operating properly, be sure to observe the following points.
 - Do not insert hands or cords into the gas stays (A) or apply any force to them laterally.
 - Do not attach any adhesive foreign materials such as pieces of plastic or stickers to the rod (B) portion.
- Do not close the rear hatch while holding the gas stays or hang anything on them. Doing so may lead to hands or arms becoming trapped in the rear hatch and could result in an injury.

OPENING REAR HATCH

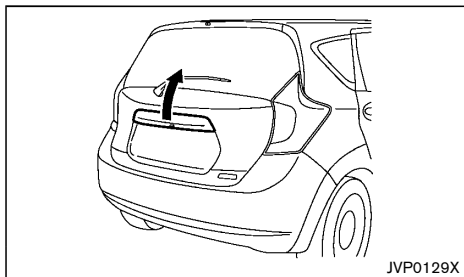

To open the rear hatch, unlock it with one of the following operations, then pull the handle.

- Push the rear hatch request switch. (See “Intelligent Key system” (P.3-4).)
- Push the “UNLOCK” button on the Intelligent Key. (See “Intelligent Key system” (P.3-4).)
- Push the power door lock switch to the “UNLOCK” position.

CLOSING REAR HATCH

WARNING:

- Do not shut the rear hatch with one hand and the other hand remaining on the rear hatch or vehicle body. Doing so may lead to your hand becoming trapped and could result in an injury.
- When closing the rear hatch, do not place your hands near the edge of the rear hatch. Always be sure to close the rear hatch from the outside.
- After closing the rear hatch, be sure to check that it has been closed securely. If the rear hatch opens while the vehicle is being driven, this could result in a serious accident.

To close the rear hatch, pull down until it securely locks.

SECONDARY REAR HATCH UNLOCK/LOCK

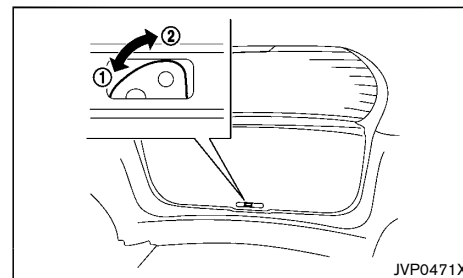

Follow the following steps to unlock/lock the rear hatch when the battery is discharged.

NOTE:

Contact a NISSAN dealer as soon as possible for inspection.

Unlocking rear hatch

1. Move the lever toward the direction (1) indicated by the arrow, using a screwdriver or a similar tool available on hand. The rear hatch will unlock.
2. Pull the rear hatch handle and open the rear hatch.

Locking rear hatch

1. Close the rear hatch.
2. Move the lever toward the direction (2) indicated by the arrow, using a screwdriver or a similar tool available on hand. The rear hatch will lock.

FUEL-FILLER LID

WARNING:

- Gasoline is extremely flammable and highly explosive under certain conditions. You could be burned or seriously injured if it is misused or mishandled. Always stop the engine and do not smoke or allow open flames or sparks near the vehicle when refueling.
- Fuel may be under pressure. Turn the cap a half of a turn, and wait for any “hissing” sound to stop to prevent fuel from spraying out and possibly causing personal injury. Then remove the cap.
- Use only an original equipment type fuel-filler cap as a replacement. It has a built-in safety valve needed for proper operation of the fuel system and emission control system. An incorrect cap can result in a serious malfunction and possible injury.

OPENING FUEL-FILLER LID

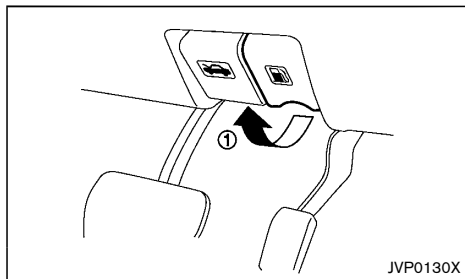

To open the fuel-filler lid, pull the fuel-filler lid release handle ①.

FUEL-FILLER CAP

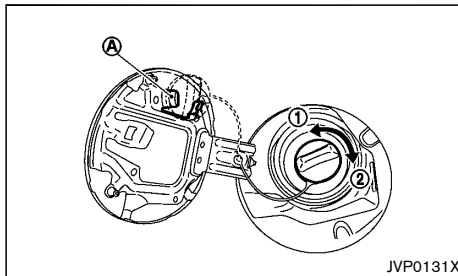

The fuel-filler cap is a ratcheting type. Turn the cap counterclockwise ① to remove. Tighten the cap clockwise ② until ratchet clicks, more than twice, after refueling.

Put the fuel-filler cap on the cap holder ① while refueling.

CAUTION:

If fuel is spilled on the vehicle body, flush it away with water to avoid paint damage.

STEERING WHEEL

WARNING:

Never adjust the steering wheel while driving so that full attention may be given to vehicle operation.

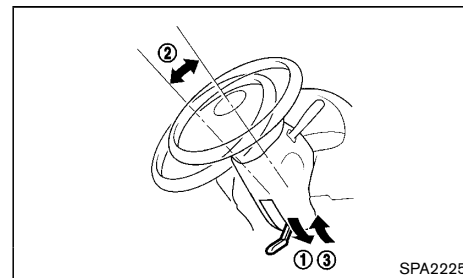

While pushing the lock lever down ①, adjust the steering wheel up or down ② until the desired position is achieved.

Pull the lock lever up ③ firmly to lock the steering wheel in place.

MIRRORS



WARNING:

Adjust the position of all mirrors before driving. Do not adjust the mirror positions while driving so that full attention may be given to vehicle operation.

INSIDE REARVIEW MIRROR

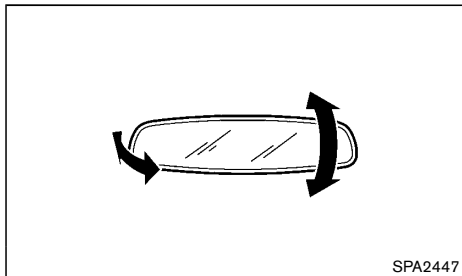

While holding the inside rearview mirror, adjust the mirror angles until the desired position is achieved.

Do not attach any accessories or electrical devices to or around the inside rearview mirror. Otherwise, the Intelligent Key system and remote keyless entry system may not function properly.

Manual anti-glare type

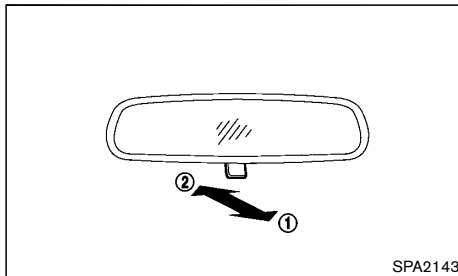

Pull the adjusting lever ① when the glare from the headlights of the vehicle behind you obstructs your vision at night.

Push the adjusting lever ② during the day for the best rearward visibility.

Automatic anti-glare type

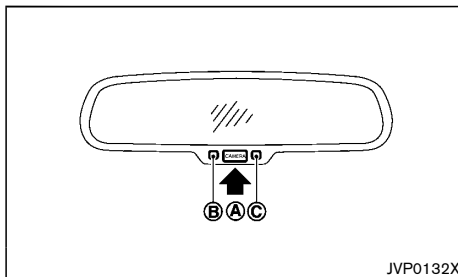

The inside rearview mirror is designed so that it automatically changes reflection according to the intensity of the headlights of the vehicle following you.

The anti-glare system will be automatically turned on when you place the ignition switch in the "ON"

position.

When the system is turned on, the indicator light ② will illuminate and excessive glare from the headlights of the vehicle behind you will be reduced.

Push the button ① for 3 seconds to make the inside rearview mirror operate normally and the indicator light will turn off. Push the button again for 3 seconds to turn the system on.

When the shift lever is moved into the "R" (Reverse) position, the monitor display shows the view to the rear of the vehicle. (See "Around View Monitor" (P.4-2).)

Do not hang any objects on the mirror or apply glass cleaner. Doing so will reduce the sensitivity of the sensor ③, resulting in improper operation.

OUTSIDE REARVIEW MIRRORS



WARNING:

- **Never touch the outside rearview mirrors while they are in motion. Doing so may pinch your fingers or damage the mirror.**
- **Never drive the vehicle with the outside rearview mirrors folded. This reduces rear view visibility and may lead to an accident.**
- **Objects viewed in the outside mirror are closer than they appear. (if equipped)**
- **The picture dimensions and distance in the outside mirrors are not real.**

Adjusting

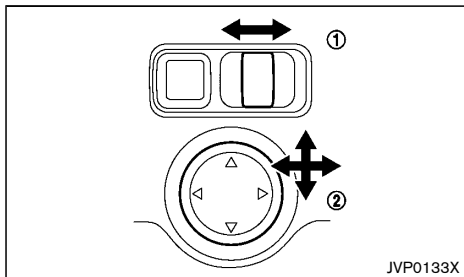

The outside rearview mirror remote control operates when the ignition switch is in the "ACC" or "ON" position.

1. Move the switch ① to select the right or left mirror.
2. Adjust each mirror until the desired position is achieved. ②

Folding

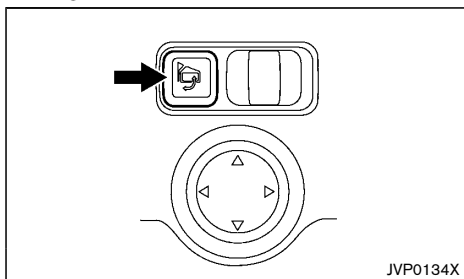

The outside rearview mirror remote control operates when the ignition switch is in the "ACC" or "ON" position.

The outside rearview mirrors automatically fold when the outside rearview mirror folding switch is pushed. To unfold, push the switch again.

CAUTION:

- Continuously performing the fold/unfold operation of the outside rearview mirror may cause the switch to stop the operation.
- Do not touch the mirrors while they are moving. Your hand may be pinched, and the mirror may malfunction.
- Do not drive with the mirrors stored. You will be unable to see behind the vehicle.
- If the mirrors were folded or unfolded by hand, there is a chance that the mirror will move forward or backward during driving. If the mirrors were folded or unfolded by hand, be sure to adjust them again electrically before driving.

VANITY MIRROR

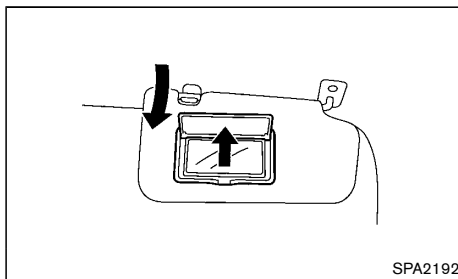

To access the vanity mirror, pull the sun visor down and pull up the mirror cover.

PARKING BRAKE

WARNING:

- Never drive the vehicle with the parking brake applied. The brake will overheat and fail to operate and will lead to an accident.
- Never release the parking brake from outside the vehicle. If the vehicle moves, it will be impossible to push the foot brake pedal and will lead to an accident.
- Never use the shift lever in place of the parking brake. When parking, be sure the parking brake is fully applied.
- To help avoid risk of injury or death through unintended operation of the vehicle and/or its systems, do not leave children, people who require the assistance of others or pets unattended in your vehicle. Additionally, the temperature inside a closed vehicle on a warm day can quickly become high enough to cause a significant risk of injury or death to people and pets.

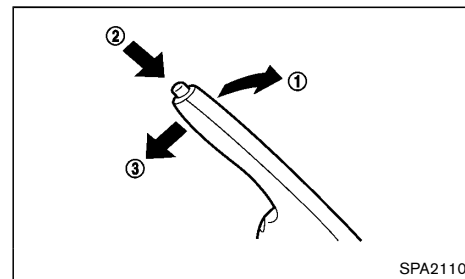

To apply the parking brake, pull the parking brake lever up ①.

To release the parking brake, firmly depress and hold

the foot brake pedal. Pull up the parking brake lever slightly, push the button ② and lower the lever completely ③.

Before driving, be sure that the brake warning light has turned off.

4 Monitor, Heater and air conditioner, and audio system

Safety precautions	4-2	Automatic air conditioner	4-12
Around View Monitor (if equipped)	4-2	Servicing air conditioner	4-13
Available views	4-3	Audio system (if equipped)	4-14
Difference between predictive and actual distances	4-5	Audio operation precautions	4-14
How to switch the display	4-6	Antenna	4-19
Language select operation	4-6	FM-AM Radio with Compact Disc (CD) player	4-20
Moving Object Detection (MOD) function	4-6	CD/USB memory care and cleaning	4-25
Operating tips	4-8	Steering wheel switch (if equipped)	4-25
Ventilators	4-8	Volume control switch	4-25
Center and side ventilators	4-8	Tuning switch	4-25
Heater and air conditioner	4-9	Phone send/phone end switch	4-26
Operating tips (for automatic air conditioner)	4-9	SOURCE select switch	4-26
Manual air conditioner	4-10	Car phone or CB radio	4-26

SAFETY PRECAUTIONS

WARNING:

- Do not adjust the heater and air conditioner controls or audio controls (if equipped) while driving so that full attention may be given to vehicle operation.
- If you noticed any foreign objects entering the system hardware, spilled liquid on the system, or noticed smoke or fumes coming out from the system, or any other unusual operation is observed, stop using the system immediately and contact the nearest NISSAN dealer. Ignoring such conditions may lead to an accident, fire or electric shock.

AROUND VIEW MONITOR (if equipped)

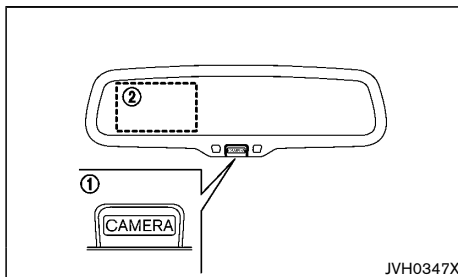

The CAMERA button ① is located below the inside rearview mirror.

The around view is displayed on the left side of the inside rearview mirror ②.

When you push the CAMERA button or move the shift lever to the "R" (Reverse) position while the ignition switch is in the ON position, the Around View Monitor operates. The monitor displays various views of the position of the vehicle.

Available views:

- Bird's-eye View
The surrounding view of the vehicle.
- Front-side View
The view around and ahead of the front passenger's side wheel.
- Front View
The view to the front of the vehicle.
- Rear View
The view to the rear of the vehicle.

The system is designed as an aid to the driver in situations such as slot parking or parallel parking.

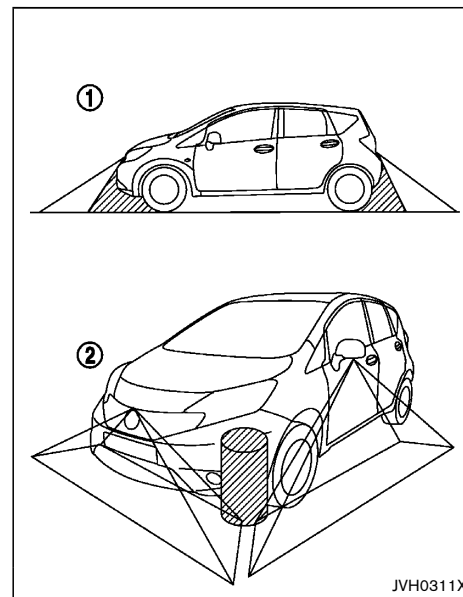

There are some areas where the system will not detect objects. When in the front or the rear view display, an object below the bumper or on the ground may not be detected ①. When in the bird's-eye view, a tall object near the seam of the camera detecting areas will not appear in the monitor ②.

WARNING:

- The Around View Monitor is a convenience but it is not a substitute for proper vehicle operation because it has areas where objects cannot be viewed. The four corners of

the vehicle in particular, are blind spots where objects do not appear in the bird's-eye, front, or rear views. Always look out the windows and check with your own eyes to be sure that it is safe to move before operating the vehicle. Always operate the vehicle slowly.

- Do not use the Around View Monitor with the outside mirror in the stored position, and make sure that the rear hatch is securely closed when operating the vehicle using the Around View Monitor.
- The distance between objects viewed on the Around View Monitor differs from the actual distance.
- The cameras are installed above the front grille, the outside mirrors and above the rear license plate. Do not put anything on the cameras.
- When washing the vehicle with highpressure water, be sure not to spray it around the cameras. Otherwise, water may enter the camera unit causing water condensation on the lens, a malfunction, fire or an electric shock.
- Do not strike the cameras. They are precision instruments. Doing so could cause a malfunction or cause damage resulting in a fire or an electric shock.



CAUTION:

Do not scratch the lens when cleaning dirt or snow from the front of the camera.

AVAILABLE VIEWS



WARNING:

- The distance guide line and the vehicle width line should be used as a reference only when the vehicle is on a paved, level surface. The distance viewed on the monitor is for reference only and may be different than the actual distance between the vehicle and displayed objects.
- Use the displayed lines and the bird's-eye view as a reference. The lines and the bird's-eye view are greatly affected by the number of occupants, fuel level, vehicle position, road condition and road grade.
- If the tires are replaced with different sized tires, the predictive course line and the bird's-eye view may be displayed incorrectly.
- When driving the vehicle up a hill, objects viewed in the monitor are further than they appear. When driving the vehicle down a hill, objects viewed in the monitor are closer than they appear. Use the mirrors or actually look to properly judge distances to other objects.
- Use the mirrors or actually look to properly judge distances to other objects.
- The vehicle width and predictive course lines are wider than the actual width and course.

Front and rear view

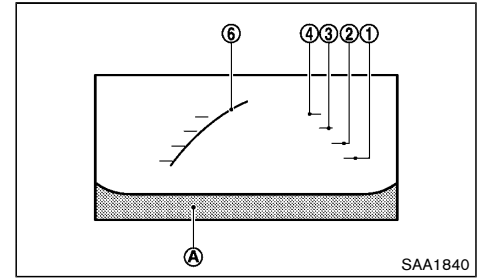

Front view

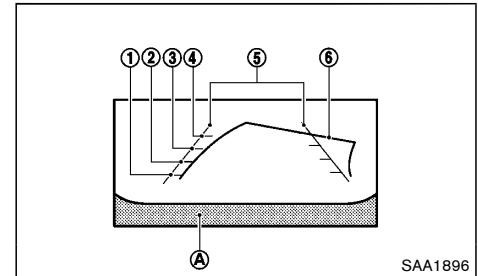

Rear view

Guiding lines, which indicate the vehicle width and distances to objects with reference to the vehicle body line (A), are displayed on the monitor.

Distance guide lines:

Indicate distances from the vehicle body.

- Red line ① : approx. 0.5 m (1.5 ft)
- Yellow line ② : approx. 1 m (3 ft)
- Green line ③ : approx. 2 m (7 ft)
- Green line ④ : approx. 3 m (10 ft)

Vehicle width guide lines ⑤ :

Indicate the vehicle width when backing up.

Predictive course lines ⑥ :

Indicate the predictive course when operating the vehicle. The predictive course lines will be displayed on the monitor when the steering wheel is turned (only for the rear view). The predictive course lines will move depending on how much the steering wheel is turned and will not be displayed while the steering wheel is in the neutral position.

The front view will not be displayed when the vehicle speed is above 10 km/h (6 MPH).



WARNING:

- **The distance between objects viewed in the rear view may differ from the actual distance. Objects in the rear view will appear visually opposite in the same way for those viewed in the inside and outside mirrors.**
- **On a snow-covered or slippery road, there may be a difference between the predictive course line and the actual course line.**
- **The displayed lines on the rear view will appear slightly off to the right because the rear view camera is not installed in the rear center of the vehicle.**



CAUTION:

When the monitor displays the front view and the steering wheel turns about 90 degrees or less from the neutral position, both the right and left predictive course lines ⑥ are displayed. When the steering wheel turns about 90 degrees or more, a predictive course line is displayed only on the opposite side of the turn.

Bird's-eye view

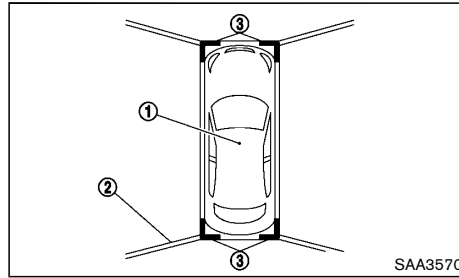

The bird's-eye view shows the overhead view of the vehicle which helps confirm the vehicle position and the predictive course to a parking space.

The vehicle icon ① shows the position of the vehicle. Note that the distance between objects viewed in the bird's-eye view differs from the actual distance.

The areas that the cameras cannot cover ② are indicated in black.

After the ignition switch is turned on, the non-viewable area ② is highlighted in yellow for 3 seconds after the bird's-eye view is displayed.

In addition, the non-viewable corners are displayed in red (blink for the first 3 seconds) ③ to remind the drivers to be cautious.



WARNING:

- **Objects in the bird's-eye view will appear further than the actual distance because the bird's-eye view is a pseudo view that is processed by combining the views from the cameras on the outside mirrors, the front and the rear of the vehicle.**

- **Tall objects, such as a curb or vehicle, may be misaligned or not displayed at the seam of the views.**
- **Objects that are above the camera cannot be displayed.**
- **The view for the bird's-eye view may be misaligned when the camera position alters.**
- **A line on the ground may be misaligned and is not seen as being straight at the seam of the views. The misalignment will increase as the line proceeds away from the vehicle.**

Front-side view

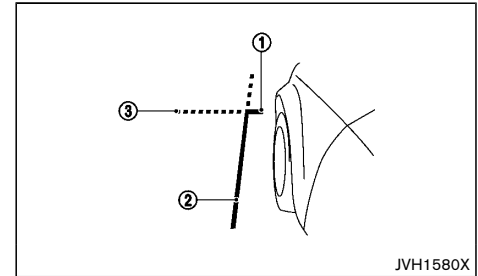

Guiding lines:

Guiding lines that indicate the width and the front end of the vehicle are displayed on the monitor.

The front-of-vehicle line ① shows the front part of the vehicle.

The side-of-vehicle line ② shows the vehicle width including the outside mirrors.

The extensions ③ of both the front ① and side ② lines are shown with a green dotted line.

CAUTION:

- Do not scratch the camera lens when cleaning dirt or snow.
- The turn signal light may overlap with the side-of-vehicle line. This is not a malfunction.

DIFFERENCE BETWEEN PREDICTIVE AND ACTUAL DISTANCES

Backing up on a steep uphill

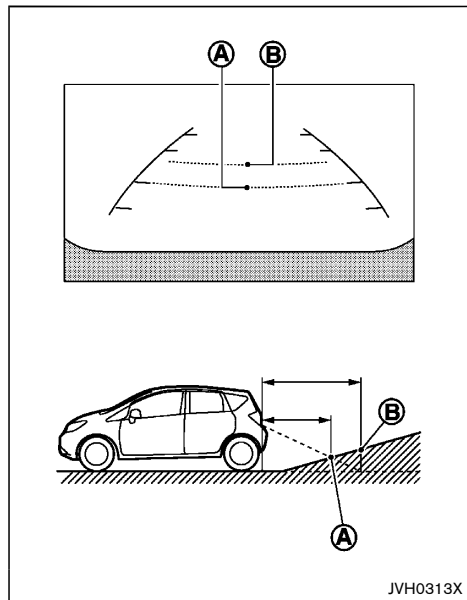

When backing up the vehicle up a hill, the distance guide lines and the vehicle width guide lines are shown closer than the actual distance. For example, the display shows 1 m (3 ft) to the place (A), but the actual 1 m (3 ft) distance on the hill is the place (B). Note that any object on the hill is viewed in the monitor further than it appears.

Backing up on a steep downhill

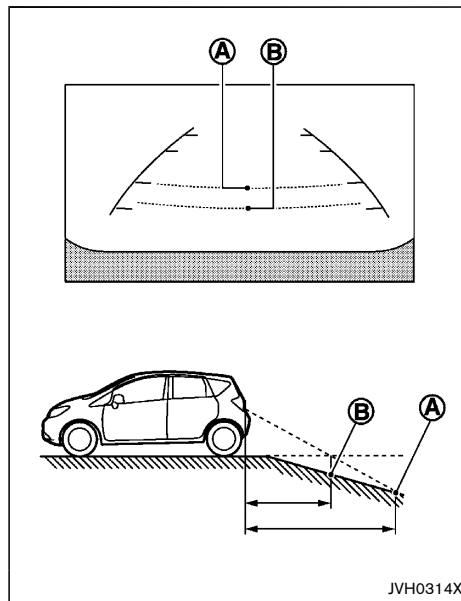

When backing up the vehicle down a hill, the distance guide lines and the vehicle width guide lines are shown further than the actual distance. For example, the

display shows 1 m (3 ft) to the place (A), but the actual 1 m (3 ft) distance on the hill is the place (B). Note that any object on the hill is viewed in the monitor closer than it appears.

Backing up near a projecting object

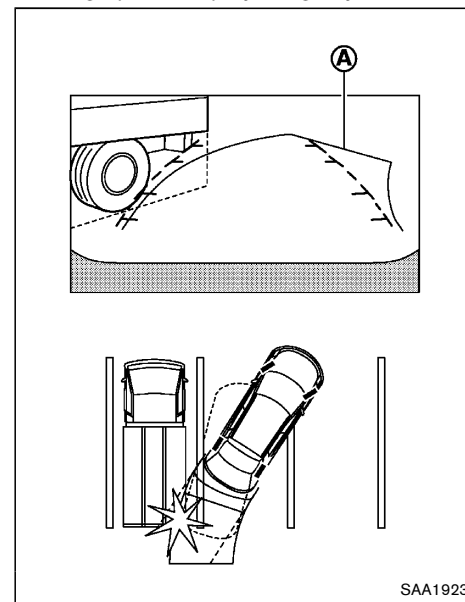

The predictive course lines (A) do not touch the object on the display. However, the vehicle may hit the object if it projects over the actual moving course.

Backing up behind a projecting object

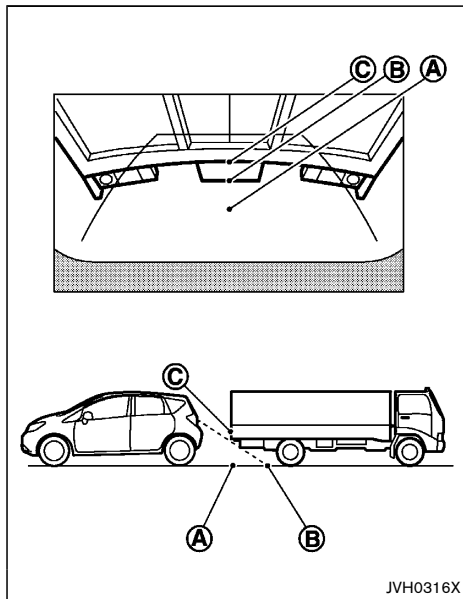

The position ③ is shown further than the position ② in the display. However, the position ③ is actually at the same distance as the position ①. The vehicle may hit the object when backing up to the position ① if the object projects over the actual moving course.

HOW TO SWITCH THE DISPLAY

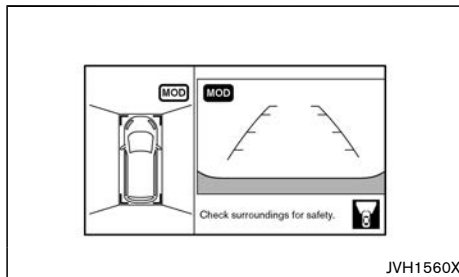

The Around View Monitor can display two split views. If the shift lever is not in the "R" (Reverse) position, the available views are:

- Bird's-eye view/Front view split screen
- Front-side view/Front view split screen

When the bird's-eye view/front view is displayed, pushing the CAMERA button will switch the view on the bird's-eye view to the front-side view. When the CAMERA button is pushed again, the screen will return to the screen which was displayed before.

If the shift lever is in the "R" (Reverse) position, the available views are:

- Bird's-eye view/Rear view split screen
- Front-side view/Rear view split screen

When the rear view is displayed, the view on the left side switches between the bird's-eye view and the front-side view each time the CAMERA button is pushed.

LANGUAGE SELECT OPERATION

To change the language of the warning text displayed on the mirror display, push and hold the CAMERA button until the warning text starts blinking. When the language select screen is displayed, push the CAMERA button repeatedly until the preferred language is displayed.

If the button is not pushed before the warning text blinking stops, the language select mode will automatically end and the display will return to the normal mode.

MOVING OBJECT DETECTION (MOD) FUNCTION

The Moving Object Detection (MOD) system can inform the driver of moving objects when driving out of garages, maneuvering into parking lots and in other such instances.

The MOD system detects moving objects by using image processing technology on the image shown on the display. The rear view camera is equipped with the automatic washer function using window washer fluid.

The MOD system operates in the following conditions when the camera view is displayed:

- When the shift lever is in the "P" (Park) or "N" (Neutral) position and the vehicle is stopped, the MOD system detects the moving objects in the bird's-eye view. The MOD system will not operate if the outside mirror is moving in or out or if either door is opened.
- When the shift lever is in the "D" (Drive) position, and the vehicle speed is below approximately 8 km/h (5 MPH), the MOD system detects moving objects in the front view.

- When the shift lever is in the “R” (Reverse) position and the vehicle speed is below approximately 8 km/h (5 MPH), the MOD system detects moving objects in the rear view. The MOD system will not operate if the rear hatch is open.

The MOD system does not detect moving objects in the front-side view. The MOD icon is not displayed on the screen when in this view.

WARNING:

- **The MOD system is not a substitute for proper vehicle operation and does not prevent contact with the objects surrounding the vehicle. When maneuvering, always use the outside mirror and inside rearview mirror and turn and look to check the surroundings to make sure it is safe to maneuver.**
- **The system is deactivated at speeds above 10 km/h (6 MPH). It is reactivated at lower speeds.**
- **The system is not designed to prevent contact with all objects.**
- **The MOD system is not designed to detect surrounding stationary objects.**

When the MOD system detects a moving object surrounding the vehicle, the yellow frame will be displayed on the view where the objects are detected and a chime will sound once. While the MOD system continues to detect moving objects, the yellow frame continues to be displayed.

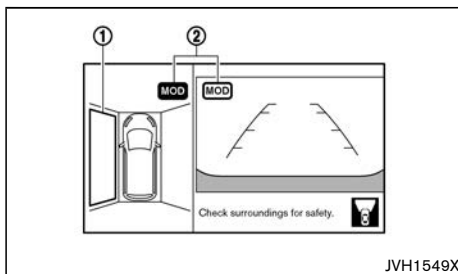

bird's-eye view

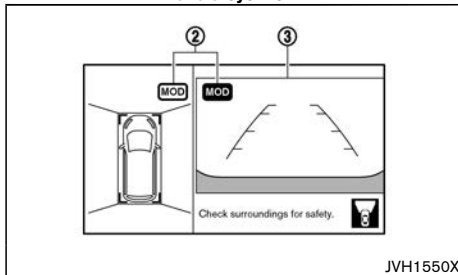

front view / rear view

In the bird's-eye view, the yellow frame ① is displayed on each camera image (front, rear, right, left) depending on where moving objects are detected.

In the front view or rear view, the yellow frame ③ is displayed when detected moving object.

The MOD icon ② is displayed in blue in the view where the MOD system is operative. The MOD icon ② is displayed in gray in the view where the MOD system is not operative.

The MOD system will activate automatically under the following conditions:

- When the shift lever is in the “R” (Reverse) position.
- When the CAMERA button is pushed to switch from a different screen to the camera view on the display.
- When vehicle speed decreases below approximately 8 km/h (5 MPH).

WARNING:

- **Excessive noise (for example, audio system volume or open vehicle window) will interfere with the chime sound, and it may not be heard.**
- **The MOD system performance will be limited according to environmental conditions and surrounding objects such as:**
 - When there is low contrast between background and the moving objects.
 - When there is blinking source of light.
 - When strong light such as another vehicle's headlight or sunlight is present.
 - When there is dirt, water drops or snow on the camera lens.
 - When the position of the moving objects in the display is not changed.
- **The MOD system might detect flowing water droplets on the camera lens, white smoke from the muffler, moving shadows, etc.**
- **The MOD system may not function properly depending on the speed, direction, distance or shape of the moving objects.**

- **If your vehicle sustains damage to the parts where the camera is installed, leaving it misaligned or bent, the sensing zone may be altered and the MOD system may not detect objects properly.**
- **When the temperature is extremely high or low, the screen may not display objects clearly. This is not a malfunction.**

MOD malfunction

When the orange MOD icon is displayed in the view, the system is not functioning properly. This will not hinder normal driving operation but the system should be inspected by a NISSAN dealer.

Camera maintenance

If dirt, rain or snow accumulates on the camera, the MOD system may not operate properly. Clean the camera.

The camera washer operates automatically when dirt is detected on the camera during driving. The washer then stops operation after a period of time.

OPERATING TIPS



CAUTION:

- **Do not use alcohol, benzene or thinner to clean the camera. This will cause discoloration. To clean the camera, wipe with a cloth dampened with a diluted mild cleaning agent and then wipe with a dry cloth.**
- **Do not damage the camera as the monitor screen may be adversely affected.**
- The Around View Monitor display will disappear automatically when no operation takes place for 3 minutes after the CAMERA button has been

pushed while the shift lever is in a position other than the "R" (Reverse) position.

- The display of images on the screen may be delayed after screens are switched. Objects in the Around View Monitor may be distorted momentarily until the Around View Monitor screen is displayed completely.
- When the temperature is extremely high or low, the screen may not display objects clearly. This is not a malfunction.
- When strong light directly shines on the camera, objects may not be displayed clearly. This is not a malfunction.
- The screen may flicker under fluorescent light. This is not a malfunction.
- The colors of objects on the Around View Monitor may differ somewhat from those of the actual object.
- Objects on the monitor may not be clear and the color of the object may differ in a dark location or at night. This is not a malfunction.
- There may be differences in clearness between each camera view of the bird's-eye view.
- If dirt, rain or snow attaches to the camera, the Around View Monitor may not display objects clearly. Clean the camera.
- Do not use wax on the camera window. Wipe off any wax with a clean cloth that has been dampened with a mild detergent diluted with water.
- While the Around View Monitor screen is displayed, the automatic anti-glare function will not operate. For more details, see "Automatic anti-glare type" (P.3-16).

VENTILATORS

CENTER AND SIDE VENTILATORS

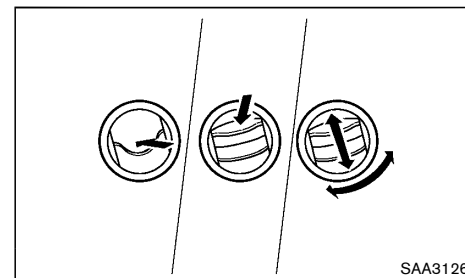

Adjust the air flow direction of the ventilators by opening, closing or rotating.

The side ventilators can be used for the side window defogger.

HEATER AND AIR CONDITIONER

WARNING:

- The heater and air conditioner operate only when the engine is running.
- Never leave children or adults who would normally require the support of others alone in the vehicle. Pets should not be left alone either. They could unknowingly activate switches or controls and inadvertently become involved in a serious accident and injure themselves. On hot, sunny days, temperatures in a closed vehicle could quickly become high enough to cause severe or possibly fatal injuries to people or animals.
- Do not use the recirculation mode for long periods as it may cause the interior air to become stale and the windows to fog up.
- Do not adjust the heating and air conditioning controls while driving so that full attention may be given to vehicle operation.

The heater and air conditioner operate when the engine is running. The air blower will operate when the ignition switch is in the "ON" position even if the engine is turned off.

When the engine is stopped by the Idling Stop System, heating, cooling and dehumidifying functions will be deactivated. To avoid the air conditioning functions from being deactivated, turn off the Idling Stop mode by pressing the Idling Stop OFF switch. For more details, see "Idling Stop System" (P.5-10).

NOTE:

- Odors from inside and outside the vehicle can build up in the air conditioner unit. Odor can enter the passenger compartment

through the vents.

- When parking, set the heater and air conditioner controls to turn off air recirculation to allow fresh air into the passenger compartment. This should help reduce odors inside the vehicle.

OPERATING TIPS (for automatic air conditioner)

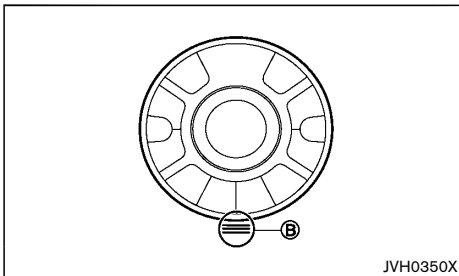
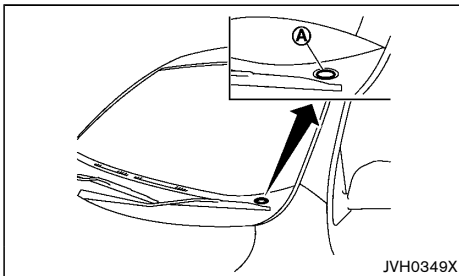





outlets will operate normally.

The sensors (A) and (B), located on the instrument panel, help maintain a constant temperature. Do not put anything on or around the sensors.

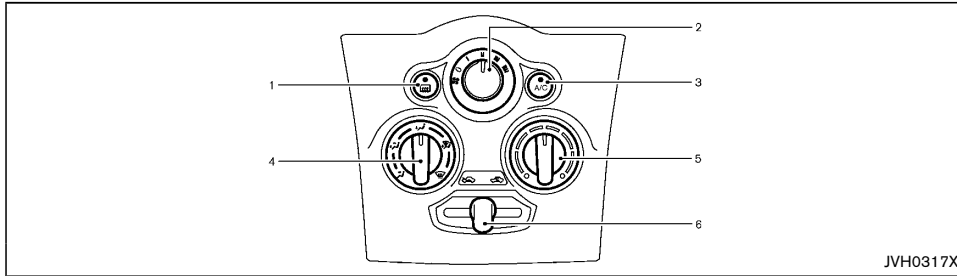
When the engine coolant temperature and outside air temperature are low, the air flow from the foot outlets may not operate for a maximum of 150 seconds. However, this is not a malfunction. After the coolant temperature warms up, the air flow from the foot

MANUAL AIR CONDITIONER



1. Rear window defogger switch (See “Defogger switch” (P.2-22).)
2. Fan speed control “ ” dial
3. “A/C” (Air Conditioner) button
4. Air flow control dial
5. Temperature control dial
6. Air intake lever (Outside air circulation “ ” /Air recirculation “ ”)

To turn off the heater and air conditioner, turn the fan speed control “ ” dial to the “OFF” (0) position.

NOTE:

The idling Stop System will not activate under the following conditions:

- When the air flow control dial is in the front defogger position and the fan speed control dial is on
- When rear window defogger switch is turned on

Controls

Outside air circulation:





Move the air intake lever to the “ ” position. The air flow is drawn from outside the vehicle.

Air recirculation:

Move the air intake lever to the “ ” position. The air flow is circulated inside the vehicle.

Air flow control:

Turn the air flow control dial to change the air flow mode.

-  — Air flows from the center and side ventilators.
-  — Air flows from the center and side ventilators and foot outlets.
-  — Air flows mainly from the foot outlets.
-  — Air flows from the defogger and foot outlets.
-  — Air flows mainly from the defogger outlets.

Fan speed control:

Turn the fan speed control “ ” dial clockwise to increase the fan speed.

Turn the fan speed control “ ” dial counterclockwise to decrease the fan speed.



Temperature control:

Turn the temperature control dial to set the desired temperature. Turn the dial between the middle and the right position to select the hot temperature. Turn the dial between the middle and the left position to select the cool temperature.

Heater operation



Heating:

This mode is used to direct heated air to the foot outlets.

1. Move the air intake lever to the “ ” position for normal heating.
2. Turn the air flow control dial to the “ ” position.
3. Turn the fan speed control “ ” dial to the desired position.
4. Turn the temperature control dial to the desired position between the middle and the hot (right) position.





Ventilation:

This mode directs outside air to the side and center ventilators.

1. Move the air intake lever to the “ ” position.
2. Turn the air flow control dial to the “ ” position.
3. Turn the fan speed control “ ” dial to the desired position.
4. Turn the temperature control dial to the desired position.



Defrosting or defogging:

This mode directs the air to the defogger outlets to defrost/defog the windows.

1. Move the air intake lever to the “” position.
 2. Turn the air flow control dial to the “” position.
 3. Turn the fan speed control “” dial to the desired position.
 4. Turn the temperature control dial to the desired position between the middle and the hot (right) position.
 5. Turn the side ventilators to the side windows to defrost or defog for a clear view to the side mirrors.
- To remove frost from the outside surface of the windshield quickly, turn the temperature control dial to the maximum hot position and the fan speed control “” dial to the maximum position.
 - If it is difficult to defog the windshield, turn the “A/C” button on.



Bi-level heating:

This mode directs cool air from the side and center vents and warm air from the foot outlets. When the temperature control dial is turned to the maximum hot or cool position, the air between the ventilators and the foot outlets is the same temperature.

1. Move the air intake lever to the “” position.
2. Turn the air flow control dial to the “” position.
3. Turn the fan speed control “” dial to the desired position.
4. Turn the temperature control dial to the desired position.

Heating and defogging:

This mode heats the interior and defogs the windows.





1. Move the air intake lever to the “” position.
2. Turn the air flow control dial to the “” position.
3. Turn the fan speed control “” dial to the desired position.
4. Turn the temperature control dial to the maximum hot (right) position.
5. Turn the side ventilators to the side windows to defrost or defog for a clear view to the side mirrors.

Air conditioner operation

The air conditioner system should be operated for approximately 10 minutes at least once a month. This helps prevent damage to the air conditioner system due to the lack of lubrication.

Cooling:



This mode is used to cool and dehumidify the air.

1. Move the air intake lever to the “” position.
 2. Turn the air flow control dial to the “” position.
 3. Turn the fan speed control “” dial to the desired position.
 4. Push the “A/C” button on. (The “A/C” indicator light will illuminate.)
 5. Turn the temperature control dial to the desired position between the middle and the cool (left) position.
- For quick cooling when the outside temperature is high, move the air intake lever to the “” position. Be sure to move the air intake lever to the “” position for normal cooling.

- A visible mist may be seen coming from the ventilators in hot, humid conditions as the air is cooled rapidly. This does not indicate a malfunction.



Dehumidified heating:

This mode is used to heat and dehumidify the air.

1. Move the air intake lever to the “” position.
2. Turn the air flow control dial to the “” position.
3. Turn the fan speed control “” dial to the desired position.
4. Push the “A/C” button on. (The “A/C” indicator light will illuminate.)
5. Turn the temperature control dial to the desired position between the middle and the hot (right) position.

Dehumidified defogging:

This mode is used to defog the windows and dehumidify the air.

1. Move the air intake lever to the “” position.
2. Turn the air flow control dial to the “” position.
3. Turn the fan speed control “” dial to the desired position.
4. Push the “A/C” button on. (The “A/C” indicator light will illuminate.)
5. Turn the temperature control dial to the desired position.
6. Turn the side ventilators to the side windows to defrost or defog for a clear view to the side mirrors.

AUTOMATIC AIR CONDITIONER

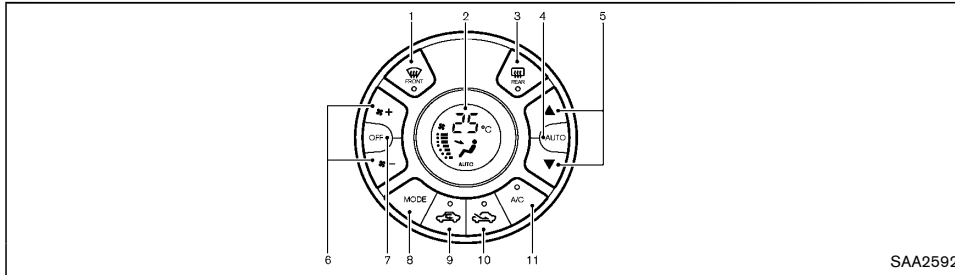

1. Front defogger “ ” button
2. Display
3. Rear window defogger “ ” button (See “Defogger switch” (P.2-22).)
4. “AUTO” button
5. Temperature control “ ”/“ ” buttons
6. Fan speed control “ ” and “ ” buttons
7. “OFF” button
8. “MODE” (air flow control) button
9. Air recirculation “ ” button
10. Outside air circulation “ ” button
11. “A/C” (Air Conditioner) button

NOTE:

Except for Thailand:

The idling Stop System will not activate when the front defogger button or rear window defogger button is turned on.

Automatic operation (AUTO)

The AUTO mode may be used year-round as the system automatically controls constant temperature, air flow distribution and fan speed after the desired temperature is set manually.

To turn off the heater and air conditioner, push the “OFF” button.

Cooling and dehumidified heating:

1. Push the “AUTO” button. (“AUTO” will appear on the display.)
2. If the “A/C” indicator light does not illuminate, push the “A/C” button. (The “A/C” indicator light will illuminate.)
3. Push the temperature control “ ”/“ ” button to set the desired temperature.
4. If the indicator light on either the outside air circulation “ ” button or the air recirculation “ ” button is illuminated, push and hold the button with the light illuminated to switch to the automatic air intake control mode. (The “ ” and “ ” indicator lights will blink twice.)

A visible mist may be seen coming from the ventilators

in hot, humid conditions as the air is cooled rapidly. This does not indicate a malfunction.

Heating (A/C off):

1. Push the “AUTO” button. (“AUTO” will appear on the display.)
 2. If the “A/C” indicator light illuminates, push the “A/C” button. (The “A/C” indicator light will turn off.)
 3. Push the temperature control “ ”/“ ” button to set the desired temperature.
- Do not set the temperature lower than the outside air temperature. Doing so may cause the temperature to not be controlled properly.
 - If the windows fog up, use dehumidified heating instead of the A/C off heating.

Dehumidified defrosting/defogging:





1. Push the front defogger “ ” button. (The “ ” indicator light will illuminate.)
 2. Push the temperature control “ ”/“ ” button to set the desired temperature.
- To remove frost from the outside surface of the windshield quickly, set the temperature to a high temperature and the fan speed to the maximum level.
 - After the windshield is cleared, push the front defogger “ ” button again. (The indicator light will turn off.)
 - When the front defogger “ ” button is pushed, the air conditioner will automatically turn on when the outside air temperature is above -2°C (28°F) to defog the windshield. The air recirculation mode will automatically turn off. The outside air circulation mode “ ” will be selected to improve the defogging performance.

Manual operation

The manual mode can be used to control the heater and air conditioner to your desired settings. ("MANUAL" will appear on the display.)

To turn off the heater and air conditioner, push the "OFF" button.





Fan speed control:

Push the fan speed control " +"/" -" button. Push the " +" button to increase the fan speed. Push the " -" button to decrease the fan speed.





Push the "AUTO" button to change the fan speed to the automatic mode.

Air flow control:





Push the "MODE" button to change the air flow mode.





-  — Air flows from the center and side ventilators.
-  — Air flows from the center and side ventilators and foot outlets.
-  — Air flows mainly from the foot outlets
-  — Air flows from the defogger outlets and foot outlets.

Temperature control:

Push the temperature control ""/"" button to set the desired temperature. Push the "" button to increase the temperature. Push the "" button to decrease the temperature.

Air intake control:

- Push the outside air circulation "" button to draw the air flow from outside the vehicle. (The "" indicator light will illuminate.)
- Push the air recirculation "" button to circulate the air flow inside the vehicle. (The "" indicator light will illuminate.)

- If the indicator light on either the outside air circulation "" button or the air recirculation "" button is illuminated, push and hold the button with the light illuminated. (The "" and "" indicator lights will blink twice.) The automatic air intake control mode is set.

SERVICING AIR CONDITIONER



WARNING:

The air conditioner system contains refrigerant under high pressure. To avoid personal injury, any air conditioner service should be done only by an experienced technician with the proper equipment.

The air conditioner system in your vehicle is charged with a refrigerant designed with the environment in mind.

This refrigerant will not harm the earth's ozone layer. However, it may contribute in a small part to global warming.

Special charging equipment and lubricant are required when servicing your vehicle's air conditioner. Using improper refrigerants or lubricants will cause severe damage to the air conditioner system.

See "Recommended fluids/lubricants and capacities" (P.9-2).

A NISSAN dealer will be able to service your environmentally friendly air conditioner system.

Air conditioner filter

The air conditioning system is equipped with an air conditioner filter which collects dirt, dust, etc. To make sure the air conditioner heats, defogs and ventilates efficiently, replace the filter in accordance with the specified maintenance intervals listed in the separate maintenance booklet. To replace the filter, contact a NISSAN dealer.

The filter should be replaced if air flow is extremely decreased or when windows fog up easily when operating heater or air conditioning system.

AUDIO SYSTEM (if equipped)

AUDIO OPERATION PRECAUTIONS



WARNING:

Do not adjust the audio system while driving so that full attention may be given to vehicle operation.

The audio system operates when the ignition switch is in the "ACC" or "ON" position.

Radio

- Radio reception is affected by station signal strength, distance from radio transmitter, buildings, bridges, mountains and other external influences. Intermittent changes in reception quality normally are caused by these external influences.
- Using a cellular phone in or near the vehicle may influence radio reception quality.

Compact Disc (CD) player

- During cold weather or rainy days, the player may malfunction due to the humidity. If this occurs, remove the CD from CD player and dehumidify or ventilate the player completely.
- The player may skip while driving on rough roads.
- The CD player sometimes may not function when the passenger compartment temperature is extremely high. Lower the temperature before use.
- Do not expose the CD to direct sunlight.
- CDs that are of poor quality, or are dirty, scratched, covered with fingerprints, or that have pin holes may not work properly.
- The following CDs may not work properly.
 - Copy control compact discs (CCCD)

- Recordable compact discs (CD-R)
- Rewritable compact discs (CD-RW)

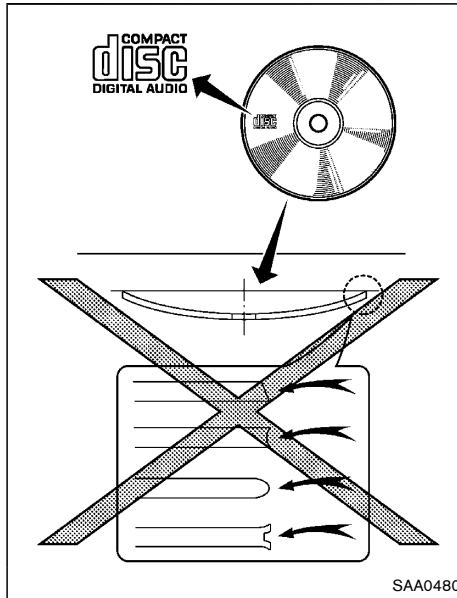

- Do not use the following CDs as they may cause the CD player to malfunction.
 - 8 cm (3.1 in) discs
 - CDs that are not round
 - CDs with a paper label
 - CDs that are warped, scratched or have unusual edges.
- This audio system can only play prerecorded CDs. It has no capabilities to record or burn CDs.

- If the CD cannot be played, one of the following messages will be displayed.

Check disc:

- Confirm that the CD is inserted correctly (the label side is facing up, etc.).
- Confirm that the CD is not bent or warped and it is free of scratches.

Push eject:

This is a malfunction due to the temperature inside the player is too high. Remove the CD by pushing the EJECT button, and after a short time reinsert the CD. The CD can be played when the temperature of the player returns to normal.

Unplayable:

The file is unplayable in this audio system.

USB (Universal Serial Bus) Connection Port



WARNING:

Do not connect, disconnect or operate the USB device while driving. Doing so can be a distraction. If distracted you could lose control of your vehicle and cause an accident or serious injury.



CAUTION:

- **Do not force the USB device into the USB connection port. Inserting the USB device tilted or up-side-down into the port may damage the port. Make sure that the USB device is connected correctly into the USB connection port.**
- **Do not grab the USB connection port cover when pulling the USB device out of the port. This could damage the port and the cover.**

- **Do not leave the USB cable in a place where it can be pulled unintentionally. Pulling the cable may damage the port.**

The vehicle is not equipped with a USB device. USB devices should be purchased separately as necessary. This system cannot be used to format USB devices. To format a USB device, use a personal computer.

In some states/area, the USB device for the front seats plays only sound without images for regulatory reasons, even when the vehicle is parked.

This system supports various USB memory devices, USB hard drives and iPod players. Some USB devices may not be supported by this system.

- Partitioned USB devices may not be played correctly.
- Some characters used in other languages (Chinese, Japanese, etc.) are not displayed properly on display. Using English language characters with a USB device is recommended.

General notes for USB use:

Refer to your device manufacturer's owner information regarding the proper use and care of the device.

Notes for iPod use:

"Made for iPod", "Made for iPhone", and "Made for iPad" mean that an electronic accessory has been designed to connect specifically to iPod, iPhone, or iPad, respectively, and has been certified by the developer to meet Apple performance standards.

Apple is not responsible for the operation of this device or its compliance with safety and regulatory standards.

Please note that the use of this accessory with iPod, iPhone, or iPad may affect wireless performance.

iPad, iPhone, iPod, iPod classic, iPod nano, iPod shuffle, and iPod touch are trademarks of Apple Inc.,

registered in the U.S. and other countries. Lightning is a trademark of Apple Inc.

- Improperly plugging in the iPod may cause a checkmark to be displayed on and off (flickering). Always make sure that the iPod is connected properly.
- An iPod nano (1st Generation) may remain in fast forward or rewind mode if it is connected during a seek operation. In this case, please manually reset the iPod.
- An iPod nano (2nd Generation) will continue to fast-forward or rewind if it is disconnected during a seek operation.
- An incorrect song title may appear when the Play Mode is changed while using an iPod nano (2nd Generation)
- Audiobooks may not play in the same order as they appear on an iPod.
- Large video files cause slow responses in an iPod. The vehicle center display may momentarily black out, but will soon recover.
- If an iPod automatically selects large video files while in the shuffle mode, the vehicle center display may momentarily black out, but will soon recover.

Compact Disc (CD)/USB device with MP3/WMA

Explanation of terms:

- MP3 — MP3 is short for Moving Pictures Experts Group Audio Layer 3. MP3 is the most well known compressed digital audio file format. This format allows for near "CD quality" sound, but at a fraction of the size of normal audio files. MP3 conversion of an audio track from CD can reduce the file size by approximately 10:1 ratio (Sampling:

44.1 kHz, Bit rate: 128 kbps) with virtually no perceptible loss in quality. MP3 compression removes the redundant and irrelevant parts of a sound signal that the human ear doesn't hear.

- WMA — Windows Media Audio (WMA) is a compressed audio format created by Microsoft as an alternative to MP3. The WMA codec offers greater file compression than the MP3 codec, enabling storage of more digital audio tracks in the same amount of space when compared to MP3s at the same level of quality. This product is protected by certain intellectual property rights of Microsoft Corporation and third parties. Use or distribution of such technology outside of this product is prohibited without a license from Microsoft or an authorized Microsoft subsidiary and third parties.
 - Bit rate — Bit rate denotes the number of bits per second used by a digital music files. The size and quality of a compressed digital audio file is determined by the bit rate used when encoding the file.
 - Sampling frequency — The rate at which the samples of a signal are converted from analog to digital (A/D conversion) per second.
 - Multisession — Multisession is one of the methods for writing data to media. Writing data once to the media is called a single session, and writing more than once is called a multisession.
 - ID3/WMA Tag — The ID3/WMA tag is the part of the encoded MP3 or WMA file that contains information about the digital music file such as song title, artist, album title, encoding bit rate, track time duration, etc. ID3 tag information is displayed on the Album/Artist/Song title line on the display.
- * Windows® and Windows Media® are registered

trademarks and/or trademarks of Microsoft Corporation in the United States of America and/or other countries.

- The playback order is the order in which the files were written by the writing software. Therefore, the files might not play in the desired order.

Playback order:

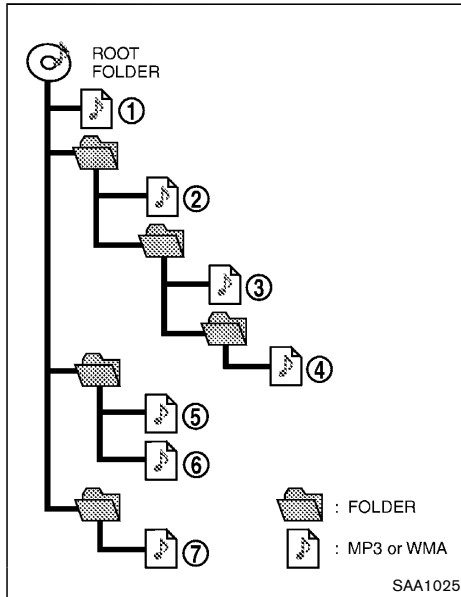

Playback order chart

The music playback order of the CD with MP3 or WMA is as illustrated.

- The names of folders not containing MP3 or WMA files are not shown in the display.
- If there is a file in the top level of the disc, "Root Folder" is displayed.

Specification chart:

Supported media		CD, CD-R, CD-RW, USB2.0	
Supported file systems		CD, CD-R, CD-RW: ISO9660 LEVEL1, ISO9660 LEVEL2, Romeo, Joliet * ISO9660 Level 3 (packet writing) is not supported. * Files saved using the Live File System component (on a Windows Vista-based computer) are not supported. USB memory: FAT16, FAT32	
Supported versions*1	MP3	Version	MPEG1 Audio Layer 3
		Sampling frequency	32 kHz - 48 kHz
		Bit rate	32 kbps - 320 kbps, VBR*4
	WMA*2	Version	WMA7, WMA8, WMA9
		Sampling frequency	32 kHz - 48 kHz
		Bit rate	32 kbps - 192 kbps, VBR4, 32 kbps - 320 kbps (WMA9 only)
Tag information (Song title and Artist name)		ID3 tag VER1.0, VER1.1, VER2.2, VER2.3, VER2.4 (MP3 only) WMA tag (WMA only)	
Folder levels		CD, CD-R, CD-RW Folder levels: 8, Folders: 255, Files: 999 (Max. 255 files for one folder)	
		USB Folder levels: 8, Folders: 255, Files: 2500 (Max. 255 files for one folder) Memory size: 4GB	
Displayable character codes*3		01: ASCII, 02: ISO-8859-1, 03: UNICODE (UTF-16 BOM Big Endian), 04: UNICODE (UTF-16 Non-BOM Big Endian), 05: UNICODE (UTF-8)	

*1 Files created with a combination of 48 kHz sampling frequency and 64 kbps bit rate cannot be played.

*2 Protected WMA files (DRM) cannot be played.

*3 Available codes depend on what kind of media, versions and information are going to be displayed.

*4 When VBR files are played, the playback time may not be displayed correctly.

Troubleshooting guide:

Symptom	Cause and Countermeasure
Cannot play	Check if the disc was inserted correctly.
	Check if the disc is scratched or dirty.
	Check if there is condensation inside the player, and if there is, wait until the condensation is gone (about 1 hour) before using the player.
	If there is a temperature increase error, the CD player will play correctly after it returns to the normal temperature.
	If there is a mixture of music CD files (CD-DA data), MP3/WMA files on a CD, only the music CD files (CD-DA data) will be played.
	Files with extensions other than “.MP3”, “.WMA”, “.mp3” or “.wma” cannot be played. In addition, the character codes and number of characters for folder names and file names should be in compliance with the specifications.
	Check if the disc or the file is generated in an irregular format. This may occur depending on the variation or the setting of MP3/WMA writing applications or other text editing applications.
	Check if the finalization process, such as session close and disc close, is done for the disc.
	Check if the disc is protected by copyright.
Poor sound quality	Check if the disc is scratched or dirty.
It takes a relatively long time before the music starts playing.	If there are many folder or file levels on the MP3/WMA disc, or if it is a multisession disc, some time may be required before the music starts playing.
Music cuts off or skips	The writing software and hardware combination might not match, or the writing speed, writing depth, writing width, etc., might not match the specifications. Try using the slowest writing speed.
Skipping with high bit rate files	Skipping may occur with large quantities of data, such as for high bit rate data.
Move immediately to the next song when playing.	When a non-MP3/WMA file has been given an extension of “.MP3”, “.WMA”, “.mp3”, “.wma”, or when play is prohibited by copyright protection, there will be approximately 5 seconds of no sound and then the player will skip to the next song.
The songs do not play back in the desired order.	The playback order is the order in which the files were written by the writing software, so the files might not play in the desired order.

ANTENNA

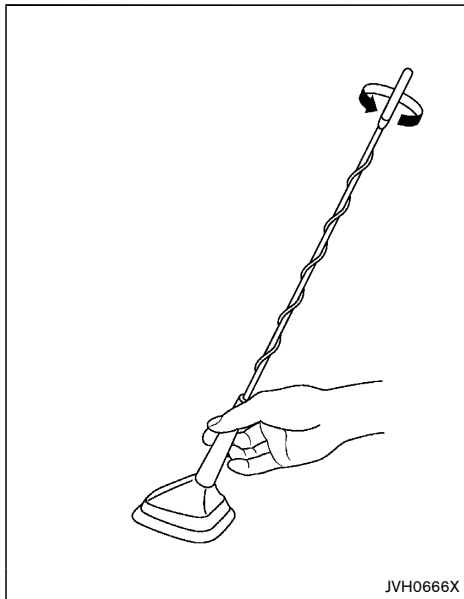

Type A

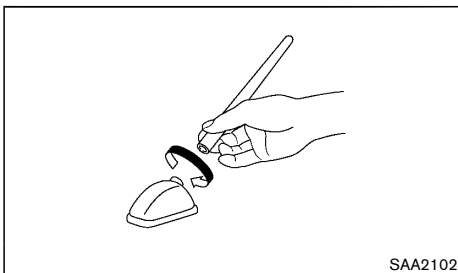

Type B

The antenna can be removed if necessary.

Hold the bottom of the antenna and remove by turning counterclockwise.

To install the antenna, turn the antenna clockwise and tighten.



CAUTION:

To avoid damaging or deforming the antenna, be sure to remove the antenna under the following conditions.

- The vehicle enters an automatic car wash.
- The vehicle enters a garage with a low ceiling.
- The vehicle is covered with a car cover.

FM-AM RADIO WITH COMPACT DISC (CD) PLAYER

17. ENTER/SETTING button

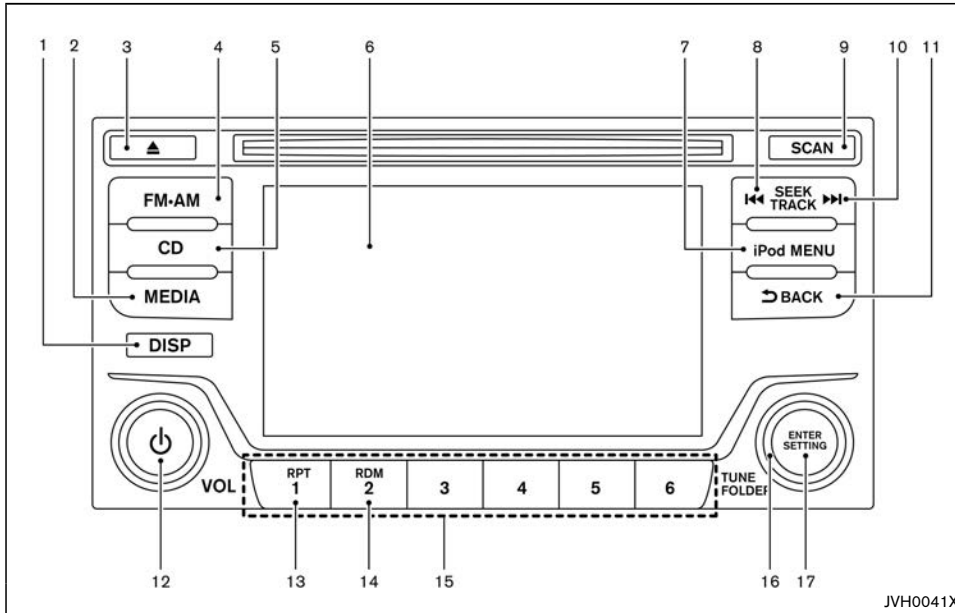

- | | |
|-------------------------------|--------------------------------------|
| 1. DISP (display) button | 9. SCAN button |
| 2. MEDIA button | 10. SEEK TRACK (forward) button |
| 3. CD eject button | 11. BACK button |
| 4. FM-AM button | 12. Power button/Volume control knob |
| 5. CD button | 13. RPT (repeat) button |
| 6. Color display | 14. RDM (random) button |
| 7. iPod MENU button | 15. Radio memory buttons |
| 8. SEEK TRACK (rewind) button | 16. TUNE FOLDER knob |

Audio main operation

Head unit:

The auto loudness circuit enhances the low and high frequency ranges automatically in radio reception, CD playback and AUX volume.



Power button/Volume control knob:

Push the Power button to turn the audio system on and off while the ignition switch is placed in the "ON" or "ACC" position.

Turn the Volume control knob to adjust the volume.

Audio settings:

The settings screen will appear when the ENTER/SETTING button is pushed.

The following items are available in the settings screen.

- **Bass, Treble, Balance and Fade**
Controls the sound of the audio system. Balance adjusts the sound between the left and right speakers. Fade adjusts the sound between the front and rear speakers.
Select the "Bass", "Treble", "Balance" or "Fade" using the TUNE FOLDER knob, and then push the ENTER/SETTING button. Turn the TUNE FOLDER knob to adjust the Bass, Treble, balance and Fade of the screen to the preferred level.
- **Speed Sensitive Vol.**
To change the Speed Sensitive Volume (Speed Sensitive Vol.) level from off (0) to 5, turn the TUNE FOLDER knob.
- **AUX Vol.**
Controls the volume level of incoming sound when an auxiliary device is connected to the system. Choose a setting between 1 and 3 or choose 0 to disable the feature entirely.

- **Brightness and Contrast**
Adjust the brightness and contrast of the screen. Select "brightness" or "contrast" using the TUNE FOLDER knob and then push the ENTER/SETTING button. Turn the TUNE FOLDER knob to adjust the brightness and contrast of the screen to the preferred level.
- **Clock Adjust**
Adjust the clock according to the following procedure.

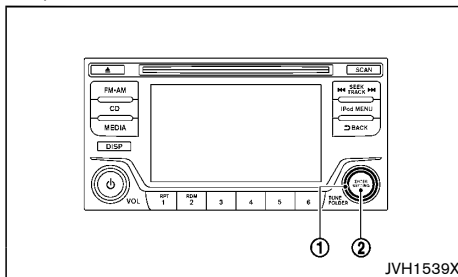

- 1) Select "Clock Adjust" using the TUNE FOLDER knob ① and then push the ENTER/SETTING button ②.
 - 2) Adjust the hour with the TUNE FOLDER knob ① and then push the ENTER/SETTING button ②.
 - 3) Adjust the minute with the TUNE FOLDER knob ① and then push the ENTER/SETTING button ②.
- 24 hour clock is not available.
- **On-Screen Clock**
When this item is turned on, a clock is always displayed in the upper right corner of the screen. Select the "On-Screen Clock" using the TUNE

FOLDER knob and then push the ENTER/SETTING button. You can toggle between ON and OFF using the TUNE FOLDER knob.

- **RDS Display**
RDS (radio data system) information can be shown on the display. Select "RDS Display" using the TUNE FOLDER knob and then push the ENTER/SETTING button. You can toggle between ON and OFF using the TUNE FOLDER knob.
- **Language Select**
The language settings can be changed. Select "Language Select" using the TUNE FOLDER knob and then push the ENTER/SETTING button. Use the TUNE FOLDER knob to select the preferred language.

DISP DISP button:

Display of the screen can be canceled by pushing the DISP button. You can still listen to music that is being played back even while the screen display is turned off. If you want to display the screen again, either push the DISP button once more or push the FM-AM, CD, MEDIA or iPod/MENU button.

MEDIA MEDIA button:

Pushing the MEDIA button will switch the displays as follows:

USB/iPod → AUX → USB/iPod

Radio operation



FM-AM button:

Push the button to change the band as follows:

AM → FM1 → FM2 → AM

TUNE (Tuning):

Turn the radio TUNE FOLDER knob for manual tuning.

Radio Data System (RDS):

RDS stands for Radio Data System, and is a data information service transmitted by some radio stations on the FM band (not AM band) encoded within a regular radio broadcast. Currently, most RDS stations are in large cities, but many stations are now considering broadcasting RDS data.

RDS can display

- Station name, such as “The Groove”.
- Music or programming type such as “Classical”, “Country” or “Rock”.



SEEK TRACK buttons:

Push the or button to tune from low to high or high to low frequencies and to stop at the next broadcasting station.



SCAN buttons:

Push the button to tune from low to high frequencies and stop at each broadcasting station for 5 seconds. Pushing the button again during this 5 seconds period will stop SCAN tuning and the radio will remain tuned to that station.

If the button is not pushed within 5 seconds, SCAN tuning moves to the next station.

1

to **6**

Radio memory buttons:

Up to 12 stations can be set for the FM band (6 each for FM1 and FM2) and 6 stations can be set for the AM band.

1. Choose the radio band using the button.
2. Tune to the desired station using the button or the TUNE FOLDER knob.
3. Push and hold the desired station preset button to until a beep sounds.
4. The station indicator will then come on and the sound will resume. The station is now set to the button memory.
5. Other buttons can be set in the same manner.

If the battery cable is disconnected, or if the fuse opens, the station memory will be erased. In that case, reset the desired stations.

CD player operation

Place the ignition switch in the “ON” or “ACC” position, and insert the compact disc (CD) into the slot with the label side facing up. The CD will be guided automatically into the slot and start playing.

After loading the CD, the number of tracks on the CD and the play time will appear on the display.

If the radio is already operating, it will automatically turn off and the CD will play.

If the system was turned off while the CD was playing, pushing the Power button will start the CD.



CD button:

When the button is pushed with the system off and the CD loaded, the system will turn on and the CD will start to play.

When the button is pushed with the CD loaded

and the radio playing, the radio will automatically be turned off and the CD will start to play.



SEEK TRACK (rewind/forward)

buttons:

When the or button is pushed and held while the CD is being played, the CD will play while fast forwarding or rewinding. When the button is released, the CD will return to normal play speed.

When the or button is pushed for less than 1.5 seconds while the CD is being played, the next track or the beginning of the current track on the CD will be played.



RPT (REPEAT) button:

When the button is pushed while the CD is played, the play pattern can be changed as follows: (CD)

(Normal) ⇔ 1 Track Repeat

(CD with compressed audio files)

(Normal) → 1 Folder Repeat → 1 Track Repeat → (Normal)



RDM (RANDOM) button:

When the button is pushed while a CD is being played, the play pattern can be changed as follows: (CD)

(Normal) ⇔ 1 Disc Random

(CD with compressed audio files)

(Normal) → 1 Disc Random → 1 Folder Random → (Normal)

 **CD eject button:**

When the  button is pushed while a CD loaded, the CD will be ejected.

If the CD comes out and is not removed, it will be pulled back into the slot to protect it.

USB (Universal Serial Bus) Connection Port

USB main operation:

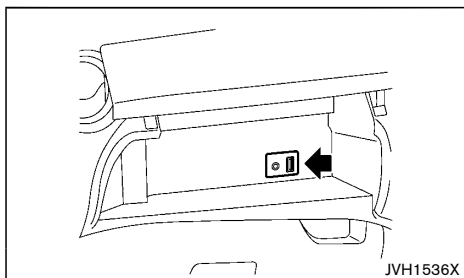

 **WARNING:**

Do not connect, disconnect or operate the USB device while driving. Doing so can be a distraction. If distracted you could lose control of your vehicle and cause an accident or serious injury.

 **CAUTION:**

- **Do not force the USB device into the USB connection port. Inserting a USB device tilted or upside-down into the port may damage the port. Make sure that the USB device is connected correctly to the USB connection port.**

- **Do not leave a USB cable in a place where it can be pulled unintentionally. Pulling the cable may damage the port.**

Refer to your device manufacturer's owner information regarding the proper use and care of the device.

The USB connection port is located inside the upper instrument box. Connect a USB memory device into the connection port. When the audio system operates the system will switch to the USB memory device mode automatically.

If the system has been turned off while the USB memory device was playing, pushing the ENTER/SETTING button will start the USB memory device.

The following operations are identical to the audio main operation of the Compact Disc (CD) operation. For details, see "CD player operation" (P.4-22).

-  
- RDM (Random play)
- RPT (Repeat track)

iPod player operation

Connecting iPod:

The USB connection port is located inside the upper instrument box. Connect the iPod with a USB connection port using a cable. See "USB (Universal Serial Bus) Connection Port" (P.4-23). The battery of the iPod is charged while the cable is connected to the vehicle.

Depending on the version of the iPod, the display on the iPod shows a NISSAN or Accessory Attached screen when the connection is completed. When the iPod is connected to the vehicle, the iPod music library can only be operated by the vehicle audio controls.

* iPod and iPhone are a trademark of Apple Inc., registered in the U.S. and other countries.

Refer to your device manufacturer's owner information regarding the proper use and care of the device.

Compatibility:

The following models are compatible:

- iPod nano 1G (Firmware version 1.3.1 -)
- iPod nano 2G (Firmware version 1.1.3 -)
- iPod nano 3G (Firmware version 1.0.0 -)
- iPod nano 4G (Firmware version 1.0.2 -)
- iPod nano 5G (Firmware version 1.0.1 -)
- iPod nano 6G (Firmware version 1.0 -)
- iPod nano 7G (Firmware version 1.0.0 -)
- iPod 5G (Firmware version 1.2.1 -)
- iPod classic (Firmware version 1.0.0 -)
- iPod Touch (iOS 1.1 -)
- iPod Touch 2G (iOS 2.1.1 -)
- iPod Touch 3G (iOS 3.1 -)
- iPod Touch 4G (iOS 4.1 -)
- iPod Touch 5G (iOS 6.0.0 -)
- iPhone (iOS 1.0.0 - 2.2.1)
- iPhone 3G (iOS 2.1 -)
- iPhone 3GS (iOS 3.0 -)
- iPhone 4/4S (iOS 4.0 -)
- iPhone 5 (iOS 6.0.0 -)
- iPhone 6/6 Plus (iOS 8.0 -)
- iPhone 6s/6s Plus (iOS 9.0 -)
- iPhone 7/7 Plus (iOS 10.0.1 -)

Operations attributable to firmware update by Apple are not guaranteed.

iPod main operation:

The system operates when the ignition switch is in the "ON" or "ACC" position. Push the **MEDIA** button repeatedly or push the **iPod MENU** button to switch to the iPod mode.

If the system was turned off while the iPod was playing, pushing the Power button will start the iPod.

If another audio source is playing and the iPod is connected, pushing the **iPod MENU** button or the **MEDIA** button repeatedly will change the system to the iPod mode.

When the **iPod MENU** button is pushed while the iPod is connected, the interface for iPod operation is shown on the audio display. The items on the menu list can be scrolled by turning the TUNE FOLDER knob while the iPod is operating. To select an item, push the ENTER/SETTING button. Items in the iPod menu appear on the display in the following order.

- Now playing
- Playlists
- Artists
- Albums
- Songs
- Podcasts
- Genres
- Composers
- Audiobooks
- Shuffle Songs

For more information about each item, see the iPod Owner's Manual.

SEEK TRACK (rewind/forward) buttons:

When the **SEEK TRACK (rewind)** or **SEEK TRACK (forward)** button is pushed for more than 1.5 seconds while the iPod is playing, the iPod will play while fast forwarding or rewinding. When the button is released, the iPod will return to the normal play speed.

When the **SEEK TRACK (rewind)** or **SEEK TRACK (forward)** button is pushed for less than 1.5 seconds while the iPod is playing, the next track or the beginning of the current track on the iPod will be played.

RPT RPT (REPEAT) button:

When the **RPT** button is pushed while a track is being played, the play pattern can be changed as follows:

Repeat Off → 1 Track Repeat → All Repeat → Repeat Off

RDM RDM (RANDOM) button:

When the **RDM** button is pushed while a track is being played, the play pattern can be changed as follows:

Shuffle Off → Track Shuffle → Shuffle Off

BACK BACK button:

The display will return to the previous screen.

Auxiliary input jack

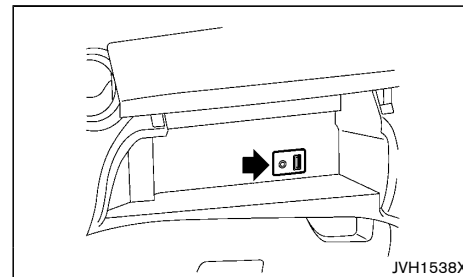

The AUX input jack is located inside the upper instrument box. The AUX input jack accepts any standard analog audio input such as from a portable cassette tape/CD player, MP3 player or laptop computer.

Push the **MEDIA** button repeatedly until the AUX mode is selected, to play a compatible device when it is plugged into the AUX input jack.

NISSAN strongly recommends using a stereo mini plug cable when connecting your music device to the audio system. Music may not play properly when a monaural cable is used.



WARNING:

Do not allow the cable or an external device connected to the AUX terminal to affect your driving.

NOTE:

- Depending on the external device, please note that the volume may be louder or quieter than that of the external device.

- When the AUX contacts the plug of the connector cable, noise may be heard.
- The connected external device cannot be operated with the main audio system. The volume and sound quality can be adjusted.
- The song title in the external device cannot be displayed on the audio display.
- For the power source of the external device, use the special battery. The external device cannot be charged with the AUX terminal. Noise may be heard if the CD, radio etc. is operated while charging the battery with the power socket of the vehicle.

CD/USB MEMORY CARE AND CLEANING

CD

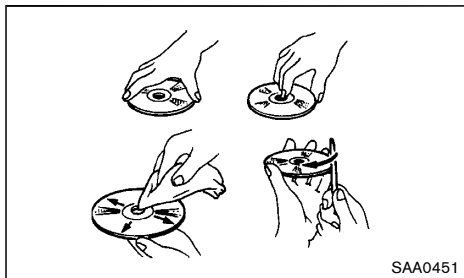

- Handle a disc by its edges. Never touch the surface of the disc. Do not bend the disc.
- Always place the discs in the storage case when they are not being used.
- To clean a disc, wipe the surface from the center to the outer edge using a clean, soft cloth. Do not wipe the disc using a circular motion.

Do not use a conventional record cleaner or alcohol intended for industrial use.

- A new disc may be rough on the inner and outer edges. Remove the rough edges by rubbing the inner and outer edges with the side of a pen or pencil as illustrated.

USB memory device

- Do not touch the terminal portion of the USB memory device.
- Do not place heavy objects on the USB memory device.
- Do not store the USB memory device in highly humid locations.
- Do not expose the USB memory device to direct sunlight.
- Do not spill any liquids on the USB memory device.

Refer to the USB memory device Owner's Manual for the details.

STEERING WHEEL SWITCH (if equipped)

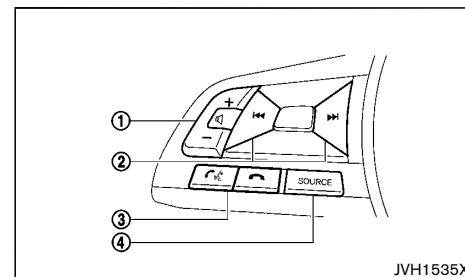

1. Volume control switch
2. Tuning switch
3. Phone send/phone end switch
4. SOURCE select switch

The audio and the hands-free phone system can be operated using the controls on the steering wheel.

Functional availability may vary depending on the system.

VOLUME CONTROL SWITCH

Push + or - side of the volume control switch to increase or decrease the volume.

TUNING SWITCH

Push the tuning switch to operate the audio system, etc. Functional availability may vary depending on the system.

CAR PHONE OR CB RADIO

PHONE SEND/PHONE END SWITCH

Push this switch to operate the hands-free phone system. Functional availability may vary depending on the hands-free phone system.

SOURCE SELECT SWITCH

Push the SOURCE select switch to change the mode to available audio source.

When installing a CB, ham radio or a car phone in your vehicle, be sure to observe the following cautions, otherwise the new equipment may adversely affect the Engine Control System and other electronic parts.



CAUTION:

- **Keep the antenna as far away as possible from the Electronic Control Module.**
- **Keep the antenna wire at least 20 cm (8 in) away from the Engine Control harnesses. Do not route the antenna wire next to any harnesses.**
- **Adjust the antenna standing wave ratio as recommended by the manufacturer.**
- **Connect the ground wire from the radio chassis to the body.**
- **For details, consult a NISSAN dealer.**

5 Starting and driving

Break-in schedule	5-2	Lane Departure Warning (LDW) system (if equipped)	5-14
Before starting engine	5-2	Precautions on LDW system	5-15
Precautions when starting and driving	5-2	LDW system operation	5-15
Exhaust gas (carbon monoxide)	5-3	Forward emergency braking system (if equipped)	5-17
Three-way catalyst	5-3	System operation	5-17
Care when driving	5-4	ECO mode system (if equipped)	5-20
Engine cold start period	5-4	Fuel Efficiency and Carbon Dioxide Reduction driving tips	5-21
Loading luggage	5-4	Increasing fuel economy and reducing Carbon	
Driving in wet conditions	5-4	Dioxide emissions	5-21
Driving in winter conditions	5-4	Parking	5-22
Avoiding body damage (for models with front spoiler)	5-4	Trailer towing	5-23
Push-button ignition switch	5-4	Electric power steering	5-23
Precautions on push-button ignition switch operation	5-4	Brake system	5-24
Intelligent Key system	5-4	Brake precautions	5-24
Steering lock	5-5	Brake assist	5-24
Ignition switch positions	5-5	Anti-lock Braking System (ABS)	5-24
Intelligent Key battery discharge	5-6	Using system	5-25
Starting engine	5-7	Self-test feature	5-25
Driving vehicle	5-7	Normal operation	5-25
Driving with Continuously Variable Transmission (CVT)	5-7	Vehicle security	5-25
Idling Stop System	5-10	Cold weather driving	5-26
Operating Idling Stop System	5-11	Battery	5-26
Retrograde movement control function	5-12	Engine coolant	5-26
Idling Stop OFF switch	5-12	Tire equipment	5-26
Vehicle Dynamic Control (VDC) system	5-12	Special winter equipment	5-26
Vehicle Dynamic Control (VDC) OFF switch	5-13	Parking brake	5-26
Hill start assist system	5-14	Corrosion protection	5-26

BREAK-IN SCHEDULE

During the first 1,600 km (1,000 miles), follow these recommendations to obtain maximum engine performance and ensure the future reliability and economy of your new vehicle. Failure to follow these recommendations may result in shortened engine life and reduced engine performance.

- Do not drive at a constant speed, either fast or slow, for long periods of time.
- Do not run the engine over 4,000 rpm.
- Do not accelerate at full throttle in any gear.
- Do not start quickly.
- Do not brake hard as much as possible.

BEFORE STARTING ENGINE



WARNING:

The driving characteristics of your vehicle will change remarkably by any additional load and its distribution, as well as by adding optional equipment (trailer coupling, roof racks, etc.). Your driving style and speed must be adjusted according to the circumstances. Especially when carrying heavy loads, your speed must be reduced adequately.

- Make sure the area around the vehicle is clear.
- Visually inspect tires for their appearance and condition. Measure and check the tire pressure for proper inflation.
- Check that all windows and lights are clean.
- Adjust the seat and head restraint positions.
- Adjust the inside and outside rearview mirror positions.
- Fasten your seat belt and ask all passengers to do the same.
- Check that all doors and the rear hatch are closed.
- Check the operation of the warning lights when the ignition switch is placed in the "ON" position.
- Maintenance items in the "8. Maintenance and do-it-yourself" section should be checked periodically.

PRECAUTIONS WHEN STARTING AND DRIVING



WARNING:

- **Never leave children or adults who would normally require the support of others alone in your vehicle. Pets should not be left alone either. They could unknowingly activate switches or controls and inadvertently become involved in a serious accident and injure themselves. On hot, sunny days, temperatures in a closed vehicle could quickly become high enough to cause severe or possibly fatal illness to people or animals.**
- **Properly secure all luggage to help prevent it from sliding or shifting. Do not place luggage higher than the seatbacks. In a sudden stop or collision, unsecured luggage could cause personal injury.**

NOTE:

During the first few months after purchasing a new vehicle, if you smell strong odors of Volatile Organic Compounds (VOCs) inside the vehicle, ventilate the passenger compartment thoroughly. Open all the windows before entering or while in the vehicle. In addition, when the temperature in the passenger compartment rises, or when the vehicle is parked in direct sunlight for a period of time, turn off the air recirculation mode of the air conditioner and/or open the windows to allow sufficient fresh air into the passenger compartment.

EXHAUST GAS (carbon monoxide)



WARNING:

- Do not breathe exhaust gas; it contains colorless and odorless carbon monoxide. Carbon monoxide is dangerous. It can cause unconsciousness or death.
- If you suspect that exhaust fumes are entering the vehicle, drive with all windows fully open, and have the vehicle inspected immediately.
- Do not run the engine in closed spaces such as a garage.
- Do not park the vehicle with the engine running for an extended period of time.
- Keep the rear hatch closed while driving, otherwise exhaust gas could be drawn into the passenger compartment. If you must drive with the rear hatch open, follow these precautions:
 - Open all the windows.
 - Turn the air recirculation mode off and set the fan speed control to the highest level to circulate the air.
- If electrical wiring or other cable connections must pass to a trailer through the seal of the rear hatch or the body, follow the manufacturer's recommendation to prevent carbon monoxide entry into the vehicle.
- If a special body or other equipment is added for recreational or other usage, follow the manufacturer's recommendation to prevent carbon monoxide entry into the vehicle. (Some recreational vehicle appliances such as stoves, refrigerators, heaters, etc. may

also generate carbon monoxide.)

- The exhaust system and body should be inspected by a qualified mechanic whenever:
 - Your vehicle is raised while being serviced.
 - You suspect that exhaust fumes are entering into the passenger compartment.
 - You notice a change in the sound of the exhaust system.
 - You have had an accident involving damage to the exhaust system, underbody, or rear of the vehicle.

THREE-WAY CATALYST



WARNING:

- The exhaust gas and the exhaust system are very hot. Keep people, animals and flammable materials away from the exhaust system components.
- Do not stop or park the vehicle over flammable materials such as dry grass, wastepaper or rags. They may ignite and cause a fire.

The three-way catalyst is an emission control device installed in the exhaust system. Exhaust gas in the three-way catalyst is burned at high temperatures to help reduce pollutants.



CAUTION:

- Do not use leaded gasoline. (See "Recommended fluids/lubricants and capacities" (P.9-2).) Deposits from leaded gasoline ser-

iously reduce the ability of the three-way catalyst to help reduce exhaust pollutants and/or damage the three-way catalyst.

- Keep your engine tuned up. Malfunctions in the ignition, fuel injection, or electrical systems may cause overrich fuel to flow into the three-way catalyst, causing it to overheat. Do not keep driving if the engine misfires, or if noticeable loss of performance or other unusual operating conditions are detected. Have the vehicle inspected promptly by a NISSAN dealer.
- Avoid driving with an extremely low fuel level. Running out of fuel could cause the engine to misfire, damaging the three-way catalyst.
- Do not race the engine while warming it up.
- Do not push or tow your vehicle to start the engine.

CARE WHEN DRIVING

Driving your vehicle to fit the circumstances is essential for your safety and comfort. As a driver, you should be the one who knows best how to drive in the given circumstances.

ENGINE COLD START PERIOD

Due to the higher engine speeds, when the engine is cold, extra caution must be exercised when selecting a gear during the engine warm-up period after starting the engine.

LOADING LUGGAGE

Loads and their distribution and the attachment of equipment (coupling devices, roof baggage carriers, etc.) will considerably change the driving characteristics of the vehicle. Your driving style and speed must be adjusted according to the circumstances.

DRIVING IN WET CONDITIONS

- Avoid accelerating or stopping suddenly.
- Avoid sharp turning or lane changing suddenly.
- Avoid following too close to the vehicle in front.

When water covers the road surface with water puddles, small water streams, etc., reduce speed to prevent hydroplaning which can cause skidding and loss of control. Worn tires will increase this risk.

DRIVING IN WINTER CONDITIONS

- Drive cautiously.
- Avoid accelerating or stopping suddenly.
- Avoid sharp turning or lane changing suddenly.
- Avoid sudden steering.
- Avoid following too close to the vehicle in front.

AVOIDING BODY DAMAGE (for models with front spoiler)

Note that the lower part of the front spoiler is close to the ground and may be damaged if it comes into contact with objects, especially uneven roads with slants, bumps, or curbstones.

PUSH-BUTTON IGNITION SWITCH

PRECAUTIONS ON PUSH-BUTTON IGNITION SWITCH OPERATION



WARNING:

Do not operate the push-button ignition switch while driving the vehicle except in an emergency. (The engine will stop when the ignition switch is pushed 3 consecutive times or the ignition switch is pushed and held for more than 2 seconds.) The steering wheel will lock and could cause the driver to lose control of the vehicle. This could result in serious vehicle damage or personal injury.

Before operating the push-button ignition switch, be sure to move the shift lever to the “P” (Park) position.

INTELLIGENT KEY SYSTEM

The Intelligent Key system can operate the ignition switch without taking the key out from your pocket or bag. The operating environment and/or conditions may affect the Intelligent Key system operation.



CAUTION:

- **Be sure to carry the Intelligent Key with you when operating the vehicle.**
- **Never leave the Intelligent Key inside the vehicle when you leave the vehicle.**
- **If the vehicle battery is discharged, the ignition switch cannot be switched from the “LOCK” position, and if the steering lock is engaged, the steering wheel cannot be moved. Charge the battery as soon as possible (See “Jump starting” (P.6-8).)**

Operating range

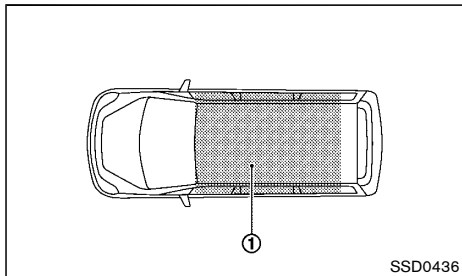

The Intelligent Key can only be used for starting the engine when the Intelligent Key is within the specified operating range ① as illustrated.

When the Intelligent Key battery is almost discharged or strong radio waves are present near the operating location, the Intelligent Key system's operating range becomes narrower and may not function properly.

If the Intelligent Key is within the operating range, it is possible for anyone, even someone who does not carry the Intelligent Key, to push the ignition switch to start the engine.

- The luggage room area is not included in the operating range, but the Intelligent Key may function.
- If the Intelligent Key is placed on the instrument panel, inside the glove box, door pocket or the corner of the interior compartment, the Intelligent Key may not function.
- If the Intelligent Key is placed near the door or window outside the vehicle, the Intelligent Key may function.

Continuously Variable Transmission (CVT) model

The ignition lock is designed so that the ignition switch cannot be switched to the "LOCK" position until the shift lever is moved to the "P" (Park) position. When pushing the ignition switch to the "OFF" position, make sure the shift lever is in the "P" (Park) position.

When the ignition switch cannot be switched to the "LOCK" position:

1. Move the shift lever to the "P" (Park) position.
2. Push the ignition switch to the "OFF" position.
3. Open the door. The ignition switch will change to the "LOCK" position.

If the ignition switch is switched to the "LOCK" position, the shift lever cannot be moved from the "P" (Park) position. The shift lever can be moved if the ignition switch is in the "ON" position with the foot brake depressed.

STEERING LOCK

The ignition switch is equipped with an anti-theft steering lock device.

To lock steering wheel

1. Push the ignition switch to the "OFF" position where the ignition switch position indicator will not illuminate.
2. Open or close the door. The ignition switch turns to the "LOCK" position.
3. Turn the steering wheel 1/6 of a turn to the right or left from the straight up position.

To unlock steering wheel

Push the ignition switch, and the steering wheel will be automatically unlocked.



CAUTION:

- If the battery of the vehicle is discharged, the push-button ignition switch cannot be switched from the "LOCK" position.
- If the ignition switch position does not change from the "LOCK" position, push the ignition switch again while rotating the steering wheel slightly to the right and left.

IGNITION SWITCH POSITIONS

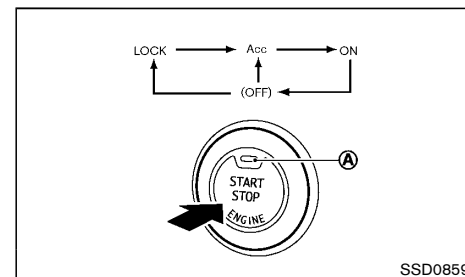

When the ignition switch is pushed without depressing the brake pedal, the ignition switch position will change as follows:

- Push once to change to "ACC".
- Push two times to change to "ON".
- Push three times to change to "OFF".
- Push four times to return to "ACC".
- Open or close any door to return to "LOCK" when in the "OFF" position.

The indicator light **(A)** on the ignition switch illuminates when the ignition switch is in the "ACC" or "ON" position.

LOCK position

The ignition switch and steering lock can only be locked at this position.

The ignition switch will be unlocked when it is pushed to the "ACC" position while carrying the Intelligent Key.

ACC position

The electrical accessory power activates at this position without the engine turned on.

ON position

The ignition system and the electrical accessory power activate at this position without the engine turned on.

OFF position

The engine is turned off with the steering wheel unlocked.



WARNING:

Never push the ignition switch to the "OFF" position while driving. The steering wheel may lock and cause the driver to lose control of the vehicle, resulting in serious vehicle damage or personal injury.



CAUTION:

Do not leave the vehicle for extended periods of time when the ignition switch is in the "ACC" or "ON" position and the engine is not running. This can discharge the battery.

NOTE:

When the ignition switch is pushed while the Idling Stop System is activated, the ignition switch will be placed in the "OFF" position.

INTELLIGENT KEY BATTERY DISCHARGE

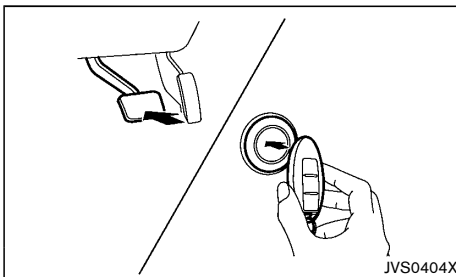

If the battery of the Intelligent Key is discharged, or environmental conditions interfere with the Intelligent Key operation, start the engine according to the following procedure:

1. Move the shift lever to the "P" (Park) position.
2. Firmly apply the foot brake.
3. Touch the ignition switch with the Intelligent Key as illustrated. (A chime will sound.)
4. Push the ignition switch while depressing the brake pedal within 10 seconds after the chime sounds. The engine will start.

After step 3 is performed, when the ignition switch is pushed without depressing the brake pedal, the ignition switch position will change to "ACC".

NOTE:

- When the ignition switch is pushed to the "ACC" or "ON" position or the engine is started by the above procedures, the Intelligent Key system warning light may blink in yellow (on the meter) even if the Intelligent Key is inside the vehicle. This is not a malfunction. To stop the warning light from blinking, touch the ignition switch with the Intelligent Key again.
- If the Intelligent Key system warning light in the meter is blinking in green, replace the battery as soon as possible. (See "Intelligent Key battery" (P.8-18).)

STARTING ENGINE

1. Apply the parking brake.
2. Move the shift lever to the "P" (Park) or "N" (Neutral) position.

The starter is designed to operate only when the shift lever is in the proper position.

The Intelligent Key must be carried when operating the ignition switch.

3. Push the ignition switch to the "ON" position. Depress the brake pedal and push the ignition switch to start the engine.

To start the engine immediately, push and release the ignition switch while depressing the brake pedal or clutch pedal with the ignition switch in any position.

4. Immediately release the ignition switch when the engine starts. If the engine starts, but fails to run, repeat the above procedures.

If the engine is very hard to start in extremely cold or hot weather, depress the accelerator pedal and hold it. Push the ignition switch for up to 15 seconds while holding. Release the accelerator pedal when the engine starts.



CAUTION:

- **As soon as the engine has started, release the ignition switch immediately.**
- **Do not operate the starter for more than 15 seconds at a time. If the engine does not start, push the ignition switch to the "OFF" position and wait 10 seconds before cranking the engine again. Otherwise, the starter could be damaged.**
- **If it becomes necessary to start the engine with a booster battery and jumper cables, the instructions and cautions contained in**

the "6. In case of emergency" section should be carefully followed.

5. Allow the engine to idle for at least 30 seconds after starting the engine to warm-up. Drive at moderate speeds for a short distance first, especially in cold weather.



CAUTION:

Do not leave the vehicle unattended while the engine is warming up.

6. To stop the engine, move the shift lever to the "P" (Park) position, apply the parking brake and push the ignition switch to the "OFF" position.

DRIVING VEHICLE

DRIVING WITH CONTINUOUSLY VARIABLE TRANSMISSION (CVT)

The Continuously Variable Transmission (CVT) in your vehicle is electronically controlled to produce maximum power and smooth operation.

The recommended operating procedures for this transmission are shown on the following pages. Follow these procedures for maximum vehicle performance and driving enjoyment.



WARNING:

Do not downshift abruptly on slippery roads. This may cause a loss of control.



CAUTION:

- **The cold engine idle speed is high, so use caution when shifting the transmission into a forward or reverse position before the engine has warmed up.**
- **Avoid revving up the engine while the vehicle is stopped. This could cause unexpected vehicle movement.**
- **Never shift to either the "P" (Park) or "R" (Reverse) position while the vehicle is moving forward and "P" (Park) or "D" (Drive) position while the vehicle is reversing. This could cause an accident or damage the transmission.**
- **Except in an emergency, do not shift to the "N" (Neutral) position while driving. Coasting with the transmission in the "N" (Neutral) position may cause serious damage to the transmission.**

- Start the engine in either the “P” (Park) or “N” (Neutral) position. The engine will not start in any other position. If it does, have your vehicle checked by a NISSAN dealer.
- Shift into the “P” (Park) position and apply the parking brake when at a standstill for longer than a short waiting period.
- Keep the engine at idling speed while shifting from the “N” (Neutral) position to any driving position.
- When stopping the vehicle on an uphill grade, do not hold the vehicle by depressing the accelerator pedal. The foot brake pedal should be depressed in this situation.

Starting vehicle

1. After starting the engine, fully depress the foot brake pedal before moving the shift lever out of the “P” (Park) position.
2. Keep the foot brake pedal depressed and move the shift lever to a driving position.
3. Release the parking brake, the foot brake pedal, and then gradually start the vehicle in motion.

The CVT is designed so the foot brake pedal MUST be depressed before shifting from the “P” (Park) position to any driving position while the ignition switch is in the “ON” position.

The shift lever cannot be moved out of the “P” (Park) position and into any of the other positions if the ignition switch is placed in the “LOCK”, “OFF” or “ACC” position.

CAUTION:

- **DEPRESS THE FOOT BRAKE PEDAL** - Shifting the shift lever to “D”, “R” or “L” without depressing the foot brake pedal causes the vehicle to move slowly when the engine is running. Make sure the foot brake pedal is depressed fully and the vehicle is stopped before shifting the shift lever.
- **MAKE SURE OF THE SHIFT LEVER POSITION** - Make sure the shift lever is in the desired position. “D” and “L” are used to move forward and “R” to back up.
- **WARM UP THE ENGINE** - Due to the higher idle speeds when the engine is cold, extra caution must be exercised when shifting the shift lever into the driving position immediately after starting the engine.

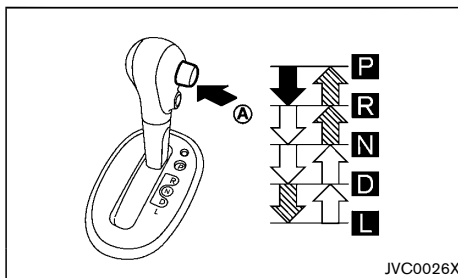

- ➔: Push the button (A) while depressing the foot brake pedal.
- ▨: Push the button (A) .
- ➔: Just move the shift lever.

Shifting

WARNING:

- Apply the parking brake if the shift lever is in any position while the engine is not running. Failure to do so could cause the vehicle to move unexpectedly or roll away and result in serious personal injury or property damage.
- If the shift lever cannot be moved from the “P” (Park) position while the engine is running and the foot brake pedal is depressed, the stop lights may not work. Malfunctioning stop lights could cause an accident injuring yourself and others.

After starting the engine, fully depress the foot brake pedal, push the shift lever button and move the shift lever out of the “P” (Park) position.

If the ignition switch is placed in the “OFF” or “ACC” position for any reason while the shift lever is in any positions other than the “P” (Park) position, the ignition switch cannot be placed in the “LOCK” position.

When it is hard to shift the shift lever from the “P” (Park) position to other position, first check that the parking brake is applied, then release the foot brake pedal and depress the foot brake pedal again.

If the ignition switch cannot be placed in the “LOCK” position, perform the following steps:

1. Apply the parking brake.
2. Place the ignition switch in the “ON” position while depressing the foot brake pedal.
3. Move the shift lever to the “P” (Park) position.
4. Place the ignition switch in the “OFF” position.

P (Park):

Use this position when the vehicle is parked or when starting the engine. **Make sure that the vehicle is completely stopped and move the shift lever into the “P” (Park) position.** Apply the parking brake. When parking on a hill, first depress the foot brake pedal, apply the parking brake, and then move the shift lever into the “P” (Park) position.

R (Reverse):

Use this position to back up. Make sure that the vehicle is completely stopped before selecting the “R” (Reverse) position.

N (Neutral):

Neither the forward nor reverse gear is engaged. The engine can be started in this position. You may shift to the “N” (Neutral) position and restart a stalled engine while the vehicle is moving.

D (Drive):

Use this position for all normal forward driving.

L (Low):

Use this position when climbing steep hills slowly or driving slowly through deep snow, sand or mud, or for maximum engine braking on steep downhill grades.

SPORT mode switch

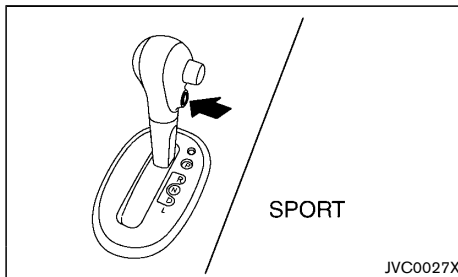

To select the SPORT mode, push the SPORT mode switch with the shift lever in the “D” (Drive) position. The SPORT mode indicator light **SPORT** in the meter panel illuminates. To turn off the SPORT mode, push the SPORT mode switch again. The SPORT mode indicator light will turn off. When the shift lever is shifted to any position other than “D”, the SPORT mode will be automatically turned off.

“OFF” position:

For normal driving and fuel economy, use the “OFF” position.

“ON” position:

For driving up or down long slopes where engine braking is necessary, or for powerful acceleration, use the “ON” position. The transmission will automatically select a different gear ratio, allowing the engine to provide high output.

When driving conditions change, push the switch to turn the SPORT mode off.

Remember not to drive at high speeds for extended periods of time with the SPORT mode in the “ON” position. This reduces fuel economy.

Accelerator downshift - in D (Drive) position -

For passing or climbing hills, depress the accelerator pedal to the floor. This shifts the transmission down into a lower gear, depending on the vehicle speed.

Shift lock release

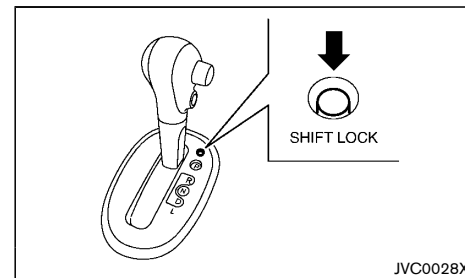

If the battery charge is low or discharged, the shift lever may not be moved from the “P” (Park) position even with the brake pedal depressed and the shift lever button pushed.

To move the shift lever, perform the following procedure:

1. Place the ignition switch in the “OFF” or “LOCK” position.
2. Apply the parking brake.
3. Depress the shift lock release button.
4. Push the shift lever button and move the shift lever to the “N” (Neutral) position while holding down the shift lock release.

Place the ignition switch in the “ON” position to unlock the steering wheel. The vehicle may be moved to the desired location.

If the battery is discharged completely, the steering

wheel cannot be unlocked. Do not move the vehicle with the steering wheel locked.

If the shift lever cannot be moved out of the "P" (Park) position, have a NISSAN dealer check the CVT system as soon as possible.



WARNING:

If the shift lever cannot be moved from the "P" (Park) position while the engine is running and the brake pedal is depressed, the stop lights may not work. Malfunctioning stop lights could cause an accident injuring yourself and others.

High fluid temperature protection mode

This transmission has a high fluid temperature protection mode. If the fluid temperature becomes too high (for example, when climbing steep grades in high temperature with heavy loads), engine power and, under some conditions, vehicle speed will be decreased automatically to reduce the chance of transmission damage. Vehicle speed can be controlled with the accelerator pedal, but engine and vehicle speed may be limited.

Fail-safe

When the fail-safe operation occurs, the CVT will not be shifted to the selected driving position.

If the vehicle is driven under extreme conditions, such as excessive wheel spinning and subsequent hard braking, the fail-safe system may be activated. This will occur even if all electrical circuits are functioning properly. In this case, place the ignition switch in the "OFF" position and wait for 10 seconds. Then turn the ignition switch back to the "ON" position. The vehicle should return to its normal operating condition.

If it does not return to its normal operating condition, have a NISSAN dealer check the transmission and repair it if necessary.



WARNING:

When the fail-safe operation occurs, vehicle speed may be gradually reduced. The reduced speed may be lower than other traffic, which could increase the chance of a collision. Be especially careful when driving. If necessary, pull to the side of the road at a safe place and allow the transmission to return to normal operation, or have it repaired if necessary.

IDLING STOP SYSTEM

The Idling Stop System activates to prevent unnecessary fuel consumption, exhaust emissions and noise.

- The Idling Stop System stops the engine automatically when the vehicle stops.
- When you start the vehicle again, the engine is turned on automatically.



CAUTION:

When the vehicle is moved while the engine is stopped by the system, such as on a downhill grade, the engine restarts automatically. To avoid an accident, be sure to depress the brake pedal.

NOTE:

The Idling Stop System will not operate under the following conditions:

- when the engine is kept idling without any driving after the engine is turned on.
- when the engine coolant temperature is low.
- when the battery capacity is low.
- when the battery temperature is low or extremely high.
- when a negative pressure booster decreases.
- when the engine hood is opened with the engine running.
- when the engine is turned on with the engine hood open.
- when the driver's seat belt is not fastened.
- when the driver's door is open.
- when the steering wheel is operated.
- when the Idling Stop System indicator blinks at a low speed.

- when the accelerator pedal is depressed.
- when the shift lever is in the “R” (Reverse) position.
- when the fan speed control dial is in any position other than “OFF” (0) while the air flow control dial is in the front defogger position (manual air conditioner). (except for Thailand)
- when the front defogger switch is on (automatic air conditioner). (except for Thailand)
- when the rear defogger switch is on. (except for Thailand)
- when the Idling Stop OFF switch is turned on.
- when the electric power steering warning light, the Anti-lock Braking System (ABS) warning light, or the Vehicle Dynamic Control (VDC) warning light illuminates.
- when the brake pedal is not fully depressed.
- when the power consumption is large.
- when the vehicle is traveling at altitudes higher than 2,000 m (6,562 ft).
- when the vehicle is moved.
- when stopping the vehicle on steep sloping roads.

NOTE:

It may take some time until the Idling Stop System activates under the following conditions:

- when the battery is discharged.
- when the outside temperature is low.
- when the battery is replaced or the battery terminal is disconnected for extended periods and then reconnected.

NOTE:

The engine will not restart even if the brake pedal is released while the Idling Stop System is activated under the following condition:

- when the shift lever is in the “P” (Park) position.

NOTE:

Under the following conditions, when the Idling Stop System is active, the engine will restart even if the driver does not release the brake pedal.

- when the Idling Stop OFF switch is pushed.
- when the fan speed control dial is in any position other than “OFF” (0) while the air flow control dial is in the front defogger position (manual air conditioner). (except for Thailand)
- when the front defogger switch is set to ON (automatic air conditioner). (except for Thailand)
- when the rear defogger switch is set to ON. (except for Thailand)
- when the accelerator pedal is depressed.
- when the steering wheel is operated. (The steering wheel operation may become heavy, but this is not a malfunction.)
- when the battery capacity is low.
- when the power consumption is large.
- when the negative pressure of the brake system is not sufficiently applied by depressing the brake pedal several times.
- when the driver’s seat belt is released or the driver’s door is open.
- when the brake pedal is released on sloping roads and the vehicle is moved.
- when the force to the brake pedal is reduced while the shift lever is in the “D” (Drive) or “N” (Neutral)

position.

- when the shift lever is placed in the “L” (Low), “D” (Drive) or “R” (Reverse) position from the “N” or “P” position.

Use this system while waiting at stoplight, etc. When the vehicle is stopped for long periods of time, turn off the engine.

When the engine hood is opened with the Idling Stop System on, the engine will be in the normal stopped state with the buzzer sounding. In this case, restart the engine with the ignition switch.

When the engine is stopped by the Idling Stop System, heating, cooling and dehumidifying functions will be deactivated. To avoid the air conditioning functions from being deactivated, turn off the Idling Stop mode by pressing the Idling Stop OFF switch.

OPERATING IDLING STOP SYSTEM

NOTE:

The Idling Stop System indicator light illuminates in the meter while driving if any of the Idling Stop System conditions are met.

- **When the brake pedal is depressed to stop the vehicle with the shift lever in the “D” (Drive) position, the engine will stop automatically.**
- **When you release your foot from the brake pedal, the engine will start automatically.**
- **The Idling Stop System indicator light and a buzzer will inform you of the Idling Stop System status. For more details, see “Idling Stop System indicator light” (P.2-16) or “Idling Stop System reminder buzzer” (P.2-18).**

RETROGRADE MOVEMENT CONTROL FUNCTION

This system is designed to reduce the retrograde movement that occurs while the driver's foot changes from depressing the brake pedal to the accelerator pedal when moving the vehicle while the Idling Stop System is active on a hilly road.

Because this function uses the VDC brake control, if the VDC warning light illuminates in the meter, the retrograde movement control function will not operate. (See "Vehicle Dynamic Control (VDC) system" (P.5-12) and "Vehicle Dynamic Control (VDC) warning light" (P.2-15).)

IDLING STOP OFF SWITCH

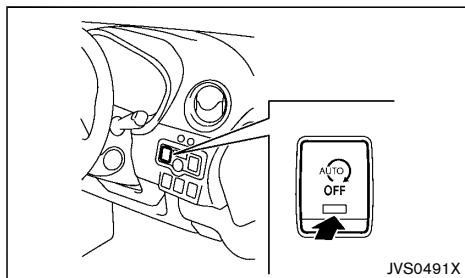

Example

Use this when you would like to cancel operation of the Idling Stop System.

- When the Idling Stop System is deactivated while the engine is running, the engine is prevented from automatically stopping.
- Push the switch again, or push the ignition switch to the OFF position (power position) once, restart the engine and the Idling Stop System will become active. (The switch indicator light will turn





off.)

- If the ignition switch is pushed while the Idling Stop System is active, the engine will restart.

VEHICLE DYNAMIC CONTROL (VDC) SYSTEM



WARNING:

- The VDC system is designed to help the driver maintain stability but does not prevent accidents due to abrupt steering operation at high speeds or by careless or dangerous driving techniques. Reduce vehicle speed and be especially careful when driving and cornering on slippery surfaces and always drive carefully.
- Do not modify the vehicle's suspension. If suspension parts such as shock absorbers, struts, springs, stabilizer bars, bushings and wheels are not NISSAN recommended for your vehicle or are extremely deteriorated, the VDC system may not operate properly. This could adversely affect vehicle handling performance, and the VDC warning light  may illuminate.
- If brake related parts such as brake pads, rotors and calipers are not NISSAN recommended or are extremely deteriorated, the VDC system may not operate properly and the VDC warning light  may illuminate.
- If engine control related parts are not NISSAN recommended or are extremely deteriorated, the VDC warning light  may illuminate.
- When driving on extremely inclined surfaces such as higher banked corners, the VDC system may not operate properly and the VDC warning light  may illuminate. Do not drive on these types of roads.
- When driving on an unstable surface such as a turntable, ferry, elevator or ramp, the VDC warning light  may illuminate. This is not

a malfunction. Restart the engine after driving onto a stable surface.

- **If wheels or tires other than the NISSAN recommended ones are used, the VDC system may not operate properly and the VDC warning light  may illuminate.**
- **The VDC system is not a substitute for winter tires or tire chains on a snow covered road.**

The Vehicle Dynamic Control (VDC) system uses various sensors to monitor driver inputs and vehicle motion. Under certain driving conditions, the VDC system helps to perform the following functions.

- Controls brake pressure to reduce wheel slip on one slipping drive wheel so power is transferred to a non slipping drive wheel on the same axle.
- Controls brake pressure and engine output to reduce drive wheel slip based on vehicle speed (traction control function).
- Controls brake pressure at individual wheels and engine output to help the driver maintain control of the vehicle in the following conditions:
 - understeer (vehicle tends to not follow the steered path despite increased steering input)
 - oversteer (vehicle tends to spin due to certain road or driving conditions).



The VDC system can help the driver to maintain control of the vehicle, but it cannot prevent loss of vehicle control in all driving situations.

When the VDC system operates, the VDC warning light  in the instrument panel flashes so note the following:

- The road may be slippery or the system may determine some action is required to help the vehicle on the steered path.

- You may feel a pulsation in the brake pedal and hear a noise or vibration from under the hood. This is normal and indicates that the VDC system is working properly.
- Adjust your speed and driving to the road conditions.

If a malfunction occurs in the system, the VDC warning light  illuminates in the instrument panel. The VDC system automatically turns off.

The VDC OFF switch is used to turn off the VDC system. The VDC off indicator light  illuminates to indicate the VDC system is off. When the VDC OFF switch is used to turn off the system, the VDC system still operates to prevent one drive wheel from slipping by transferring power to a non slipping drive wheel. The VDC warning light  flashes if this occurs. All other VDC functions are off and the VDC warning light  will not flash. The VDC system is automatically reset to on when the ignition switch is placed in the "OFF" position then back to the "ON" position.

See "Vehicle Dynamic Control (VDC) warning light" (P.2-15) and "Vehicle Dynamic Control (VDC) off indicator light" (P.2-17).

The computer has a built-in diagnostic feature that tests the system each time you start the engine and move the vehicle forward or in reverse at a slow speed. When the self-test occurs, you may hear a "clunk" noise and/or feel a pulsation in the brake pedal. This is normal and is not an indication of a malfunction.

VEHICLE DYNAMIC CONTROL (VDC) OFF SWITCH

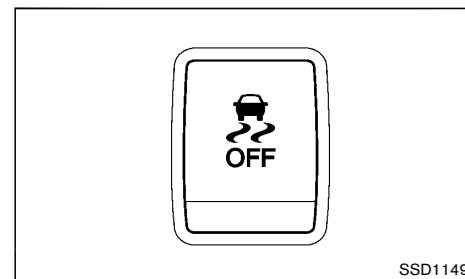

The vehicle should be driven with the Vehicle Dynamic Control (VDC) system ON for most driving conditions.

When the vehicle is stuck in mud or snow, the VDC system reduces the engine output to reduce wheel spin. The engine speed will be reduced even if the accelerator is depressed to the floor. If maximum engine power is needed to free a stuck vehicle, turn the VDC system off.

To turn off the VDC system, push the VDC OFF switch. The VDC off indicator light  will illuminate.

Push the VDC OFF switch again or restart the engine to turn ON the system.

HILL START ASSIST SYSTEM



WARNING:

- **Never rely solely on the hill start assist system to prevent the vehicle from moving backward on a hill. Always drive carefully and attentively. Depress the brake pedal when the vehicle is stopped on a steep hill. Be especially careful when stopped on a hill on frozen or muddy roads. Failure to prevent the vehicle from rolling backwards may result in a loss of control of the vehicle and possible serious injury or death.**
- **The hill start assist system is not designed to hold the vehicle at a standstill on a hill. Depress the brake pedal when the vehicle is stopped on a steep hill. Failure to do so may cause the vehicle to roll backwards and may result in a collision or serious personal injury.**
- **The hill start assist system may not prevent the vehicle from rolling backwards on a hill under all load or road conditions. Always be prepared to depress the brake pedal to prevent the vehicle from rolling backwards. Failure to do so may result in a collision or serious personal injury.**

The hill start assist system automatically keeps the brakes applied to help prevent the vehicle from rolling backwards in the time it takes the driver to release the brake pedal and apply the accelerator when the vehicle is stopped on a hill.

The hill start assist system will operate automatically under the following conditions:

- The transmission is shifted to a forward or reverse gear.

- The vehicle is stopped completely on a hill by applying the brake.

The maximum holding time is 2 seconds. After 2 seconds the vehicle will begin to roll back and the hill start assist system will stop operating completely.

The hill start assist system will not operate when the transmission is shifted to the "N" (Neutral) or "P" (Park) position or on a flat and level road.

When the Vehicle Dynamic Control (VDC) warning light illuminates in the meter, the hill start assist system will not operate. (See "Vehicle Dynamic Control (VDC) warning light" (P.2-15).)

LANE DEPARTURE WARNING (LDW) SYSTEM (if equipped)

The Lane Departure Warning (LDW) system helps alert the driver when the vehicle is traveling close to either the left or the right of a traveling lane.

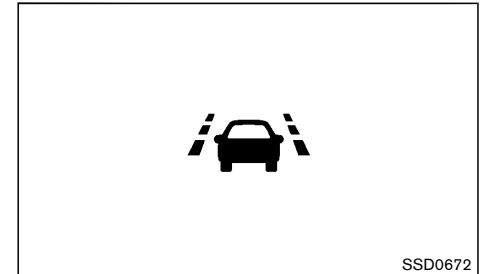
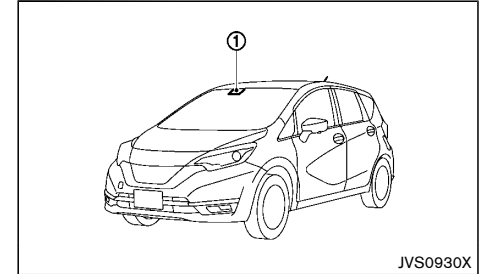

The LDW system uses the multi-sensing front camera unit ① located on the upper side of the windshield.

PRECAUTIONS ON LDW SYSTEM



WARNING:

- This system is only a warning device to inform the driver of a potential unintended lane departure. It will not steer the vehicle or prevent loss of control. It is the driver's responsibility to stay alert, drive safely, keep the vehicle in the traveling lane, and be in control of the vehicle at all times.
 - The system will not operate at speeds below approximately 60 km/h (37 MPH) or if it cannot detect lane markers.
 - If the LDW system malfunctions, it will cancel automatically, and the LDW indicator light will illuminate in the meter. If the indicator light illuminates, pull off the road to a safe location and stop the vehicle. Turn the engine off and restart the engine. If the indicator light continues to illuminate, have the system checked by a NISSAN dealer.
 - Excessive noise will interfere with the warning chime sound, and the chime may not be heard.
- The system may not function properly under the following conditions:
- On roads where there are multiple parallel lane markers; lane markers that are faded or not painted clearly; yellow painted lane markers; non-standard lane markers; or lane markers covered with water, dirt, snow, etc.
 - On roads where the discontinued lane markers are still detectable.

- On roads where there are sharp curves.
- On roads where there are sharply contrasting objects, such as shadows, snow, water, wheel ruts, seams or lines remaining after road repairs. (The Lane Departure Warning (LDW) system could detect these items as lane markers.)
- On roads where the traveling lane merges or separates.
- When the vehicle's traveling direction does not align with the lane marker.
- When traveling close to the vehicle in front of you, which obstructs the multi-sensing front camera unit detection range.
- When rain, snow or dirt adheres to the windshield in front of the multi-sensing front camera unit.
- When the headlights are not bright due to dirt on the lens or if the aiming is not adjusted properly.
- When strong light enters the multi-sensing front camera unit. (For example, the light directly shines on the front of the vehicle at sunrise or sunset.)
- When a sudden change in brightness occurs. (For example, when the vehicle enters or exits a tunnel or under a bridge.)

LDW SYSTEM OPERATION

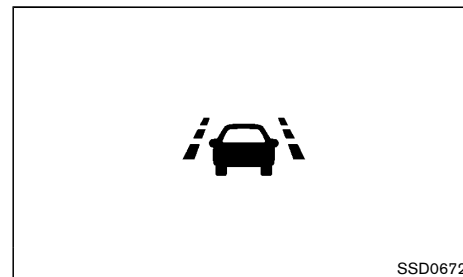
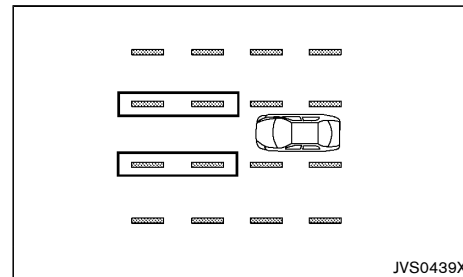

LDW warning light

The LDW system provides a lane departure warning function when the vehicle is driven at speeds approximately 60 km/h (37 MPH) and above.

When the vehicle approaches either the left or the right side of the traveling lane, a warning chime will sound and the LDW warning light in the meter will blink to alert the driver.

The warning function will stop when the vehicle returns inside of the lane markers.

The LDW system is not designed to warn under the following conditions.

- When you operate the lane change signal and change traveling lanes in the direction of the signal. (The LDW system will become operable again approximately 2 seconds after the lane change signal is turned off.)
- When the vehicle speed lowers to less than approximately 60 km/h (37 MPH).

After the above conditions have finished and the necessary operating conditions are satisfied, the LDW functions will resume.

Turning on or off the LDW system

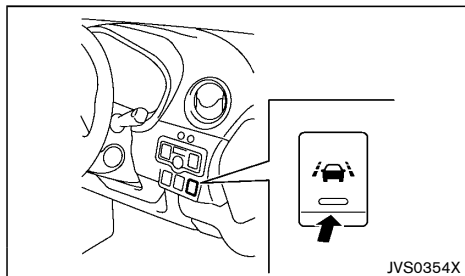

LDW switch

The LDW system can be turned on or off using the LDW switch on the instrument panel.

When the system is on, the LDW system ON indicator light on the switch illuminates. To cancel the LDW system, push the LDW switch. The LDW system ON indicator light will turn off. To turn on the system, push the LDW switch again.

The on/off status of the system will remain the same even if the engine is restarted.

System temporarily unavailable

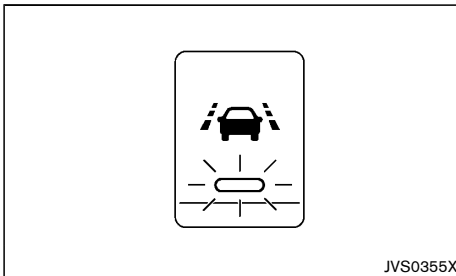

- In the following conditions, the LDW system ON indicator light on the switch will blink and the LDW system may be deactivated automatically.
 - The multi-sensing front camera unit cannot recognize the front view because the windshield glass is covered with dirt, etc.
 - The temperature of the multi-sensing front camera unit is high because the vehicle is parked under the direct sunlight. (When the interior temperature is reduced, the system will resume operating automatically.)

LDW malfunction

When the LDW system malfunctions, it will be turned off automatically and the LDW warning light will illuminate.

Action to take:

Stop the vehicle in a safe location, turn off and restart the engine. If the LDW warning light continues to illuminate, have the LDW system checked by a NISSAN dealer.

Multi-sensing front camera unit maintenance

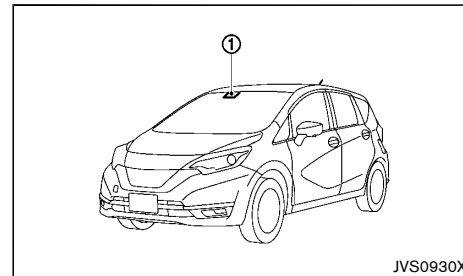

The multi-sensing front camera unit ① for the LDW system is located on the upper side of the windshield. To maintain the proper operation of the LDW system and prevent a system malfunction, be sure to observe the following:

- Always keep the windshield clean.
- Do not attach a sticker (including transparent material) or install an accessory near the multi-sensing front camera unit.
- Do not place reflective materials, such as white paper or a mirror, on the instrument panel. The reflection of sunlight may adversely affect the multi-sensing front camera unit's detection capability.
- Do not strike or damage the areas around the camera unit. Do not touch the camera lens or remove the screw located on the camera unit. If the camera unit is damaged due to an accident, contact a NISSAN dealer.

FORWARD EMERGENCY BRAKING SYSTEM (if equipped)

The forward emergency braking system can assist the driver when there is a risk of a forward collision with the vehicle ahead or pedestrian in the travelling lane.

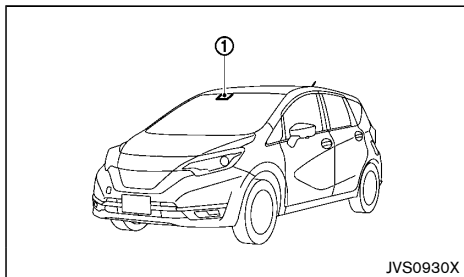

The forward emergency braking system detects a vehicle ahead and pedestrian using a multi-sensing front camera unit (1) located on the upper side of the windshield.

WARNING:

- **The forward emergency braking system is a supplemental aid to the driver. It is not a replacement for the driver's attention to traffic conditions or responsibility to drive safely. It cannot prevent accidents due to carelessness or dangerous driving techniques.**
- **The forward emergency braking system does not function in all driving, traffic, weather and road conditions.**

SYSTEM OPERATION

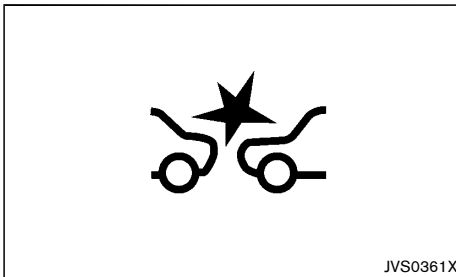

The forward emergency braking system operates when vehicle speed is within the range of approximately 10 to 80 km/h (5 to 50 MPH). (The system will not activate for a stationary vehicle or a pedestrian when the vehicle is driven at speeds faster than approximately 60 km/h (37 MPH).)

If a risk of a forward collision is detected, the forward emergency braking system will provide the first warning to the driver by flashing the warning light, providing an audible warning and applying partial braking.

If the driver's collision avoidance operation is not sufficient and the risk of collision is increased, the system issues the audible warning and applies harder braking immediately before the collision.

NOTE:

The vehicle's stop lights come on when braking is performed by the forward emergency braking system.

Depending on vehicle speed and distance to the vehicle ahead or pedestrian, as well as driving and roadway conditions, the system may help the driver avoid a forward collision or may help mitigate the

consequences of a collision, should one be unavoidable.

If the driver is handling the steering wheel, accelerating or braking, the forward emergency braking system will function later or will not function.

The automatic braking will cease under the following conditions:

- When the steering wheel is turned as far as necessary to avoid a collision.
- When the accelerator pedal is depressed.
- When there is no longer a vehicle or a pedestrian detected ahead.

If the forward emergency braking system has stopped the vehicle, the vehicle will remain at a standstill for approximately 2 seconds before the brakes are released.

WARNING:

- **The multi-sensing front camera unit does not detect the following objects:**
 - Children and other people who are of short stature, animals, and bicycles
 - Pedestrians walking at night or in dark areas such as tunnels
 - Oncoming vehicles
 - Crossing vehicles
 - Vehicles parked diagonally
- **The multi-sensing front camera unit may not detect a vehicle or pedestrian ahead in the following conditions:**
 - Visibility is poor because of bad weather conditions such as rain, snow, fog, dust storms, sandstorms, and snowstorms.

- Snow, sand or road spray from traveling vehicles.
- The windshield glass in front of the camera unit is covered with dirt, water drops, ice, snow, etc.
- The windshield glass in front of the camera unit is fogged up.
- Strong light (for example, sunlight or high beams from oncoming vehicles) enters from the front.
- The headlights did not illuminate during the nighttime or in a tunnel, or the headlight lenses are extremely dirty.
- Both tail lights of the vehicle ahead do not illuminate at night or inside a tunnel.
- When a sudden change in brightness occurs. (For example, when the vehicle enters or exits a tunnel or a shaded area.)
- On roads where there are sharp curves.
- The vehicle drives on a slope where the gradient changes.
- The vehicle drives on a bumpy road surface, such as an uneven dirt road.
- The system cannot recognize the outline of a person because the pedestrian is carrying large luggage or is wearing clothes that are the same color as the background.
- Depending on the ambient noise, the audible warning may not be heard.
- In the following conditions, the system may not be able to function normally:
 - The vehicle is driven on a slippery road.
 - The vehicle drives on a slope.
 - When excessively heavy baggage is loaded in the rear seat or the luggage room of your vehicle.

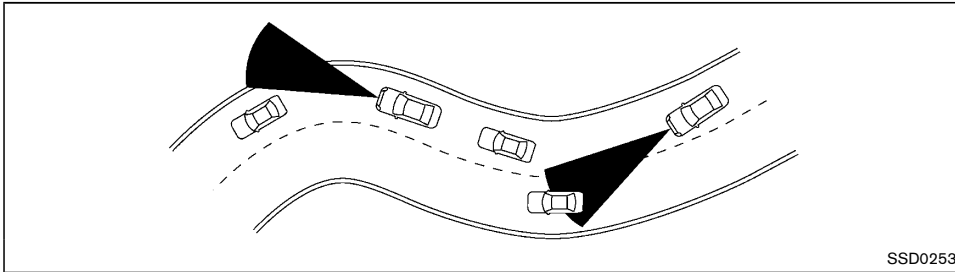

SSD0253

When driving on some roads, such as winding, hilly, curved, narrow roads, or roads which are under construction, the camera may detect vehicles in a different lane, or may temporarily not detect a vehicle traveling ahead. This may cause the system to work inappropriately.

The detection of vehicles may also be affected by vehicle operation (steering maneuver or traveling position in the lane, etc.) or vehicle condition. **If this occurs, the system may warn you by blinking the system indicator and sounding the chime unexpectedly. You will have to manually control the proper distance away from the vehicle traveling ahead.**

Turning on or off the forward emergency braking system

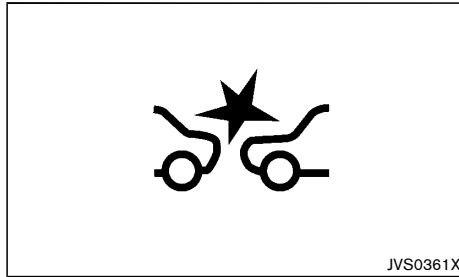

JVS0361X

Forward emergency braking system warning light

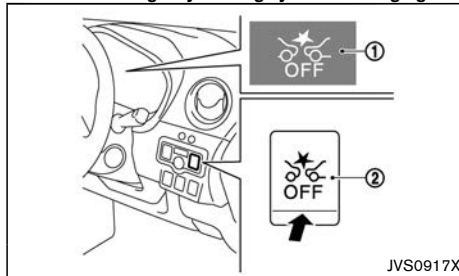

JVS0917X

The forward emergency braking system can be turned on or off using the forward emergency braking system OFF switch ② on the instrument panel.

When the system is off, the forward emergency braking system off indicator light ① will illuminate.

The forward emergency braking system will be automatically turned ON when the engine is restarted.

To turn the system on or off, push the forward emergency braking system OFF switch on the instrument panel. The ignition switch must be in the "ON" position when turning on or off the system.

NOTE:

- **When the Vehicle Dynamic Control (VDC) system is turned off, the forward emergency braking system is also turned off and the forward emergency braking system warning light illuminates. For details about the VDC system, see "Vehicle Dynamic Control (VDC) system" (P.5-12).**

System temporarily unavailable

- In the following conditions, the forward emergency braking system warning light blinks and the system will be turned off automatically.
 - The multi-sensing front camera unit cannot recognize the front view because the windshield glass is covered with dirt, etc.
 - The multi-sensing front camera unit cannot recognize the front view because strong light is shining from the front.
 - The temperature of the multi-sensing front camera unit is high because the vehicle is parked under the direct sunlight. (When the interior temperature is reduced, the system will resume operating automatically.)

System malfunction

If the forward emergency braking system malfunctions, it will be turned off automatically, the forward emergency braking system warning light will illuminate.

Action to take:

If the warning light illuminates, park the vehicle in a safe location, turn the engine off and restart the engine. If the warning light continues to illuminate, have the forward emergency braking system checked by a NISSAN dealer.

Multi-sensing front camera unit maintenance

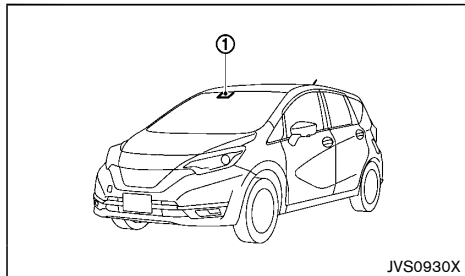

The multi-sensing front camera unit ① for the forward emergency braking system is located on the upper side of the windshield. To maintain the proper operation of the forward emergency braking system and prevent a system malfunction, be sure to observe the following:

- Always keep the windshield clean.
- Do not attach a sticker (including transparent material) or install an accessory near the multi-sensing front camera unit.

- Do not place reflective materials, such as white paper or a mirror, on the instrument panel. The reflection of sunlight may adversely affect the multi-sensing front camera unit's detection capability.
- Do not strike or damage the areas around the camera unit. Do not touch the camera lens or remove the screw located on the camera unit. If the camera unit is damaged due to an accident, contact a NISSAN dealer.

ECO MODE SYSTEM (if equipped)

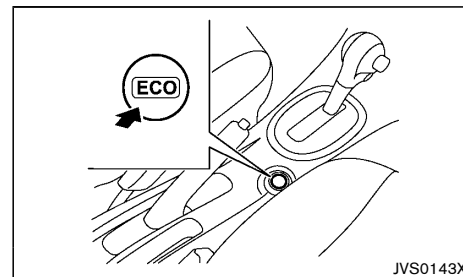

ECO mode switch

The ECO mode system helps to enhance the fuel economy by controlling the engine and CVT operation automatically to avoid rapid acceleration.

NISSAN recommends using ECO mode.

To turn on the ECO mode system, push the ECO mode switch. The ECO mode system indicator light will illuminate on the vehicle information display.

To turn off the ECO mode system, push the ECO mode switch again. The ECO mode system indicator will turn off.

- The ECO mode system cannot be turned off while the accelerator pedal is depressed, even if the ECO mode switch is pushed to OFF. Release the accelerator pedal to turn off the ECO mode system.
- The ECO mode system will turn off automatically if a malfunction occurs in the system.
- Turn off the ECO mode system when acceleration is required, such as when:
 - driving with a heavy load of passengers or cargo in the vehicle
 - driving on a steep uphill slope

FUEL EFFICIENCY AND CARBON DIOXIDE REDUCTION DRIVING TIPS

Follow these easy-to-use Fuel Efficiency and Carbon Dioxide Reduction Driving Tips to help you achieve the most fuel economy from your vehicle and reduce carbon dioxide emissions.

1. Use smooth accelerator and brake pedal application.
 - Avoid rapid starts and stops.
 - Use smooth, gentle accelerator and brake application whenever possible.
 - Maintain constant speed while commuting and coast whenever possible.
2. Maintain constant speed.
 - Look ahead to try and anticipate and minimize stops.
 - Synchronizing your speed with traffic lights allows you to reduce your number of stops.
 - Maintaining a steady speed can minimize red light stops and improve fuel efficiency.
3. Drive at economical speeds and distances.
 - Observing the speed limit and not exceeding 97 km/h (60 MPH) (where legally allowed) can improve fuel efficiency due to reduced aerodynamic drag.
 - Maintaining a safe following distance behind other vehicles reduces unnecessary braking.
 - Safely monitoring traffic to anticipate changes in speed permits reduced braking and smooth acceleration changes.
 - Select a gear range suitable to road conditions.
4. Use cruise control.
 - Using cruise control during highway driving helps maintain a steady speed.
 - Cruise control is particularly effective in providing fuel savings when driving on flat terrains.
5. Plan for the shortest route.
 - Utilize a map or navigation system (if equipped) to determine the best route to save time.
6. Avoid idling.
 - Shutting off your engine when safe for stops exceeding 30-60 seconds saves fuel and reduces emissions.
7. Buy an automated pass for toll roads.
 - Automated passes permit drivers to use special lanes to maintain cruising speed through the toll and avoid stopping and starting.
8. Winter warm up.
 - Limit idling time to minimize impact to fuel economy.
 - Vehicles typically need no more than 30 seconds of idling at start-up to effectively circulate the engine oil before driving.
 - Your vehicle will reach its ideal operating temperature more quickly while driving versus idling.
9. Keeping your vehicle cool.
 - Park your vehicle in a covered parking area or in the shade whenever possible.
 - When entering a hot vehicle, opening the windows will help to reduce the inside temperature faster, resulting in reduced demand on your A/C system.
10. Do not carry excessive weight.
 - Remove unnecessary objects from the vehicle to reduce vehicle weight.

INCREASING FUEL ECONOMY AND REDUCING CARBON DIOXIDE EMISSIONS

- Keep your engine tuned up.
- Follow the recommended scheduled maintenance.
- Keep the tires inflated to the correct pressure. Low tire pressure increases tire wear and lowers fuel economy.
- Keep the wheels in correct alignment. Improper alignment increases tire wear and lowers fuel economy.
- Use the recommended viscosity engine oil. (See “Recommended fluids/lubricants and capacities” (P.9-2).)

PARKING



WARNING:

- Do not stop or park the vehicle over flammable materials such as dry grass, waste paper or rags. They may ignite and cause a fire.
- Safe parking procedures require that both the parking brake be applied and the shift lever placed in the "P" (Park) position. Failure to do so could cause the vehicle to move unexpectedly or roll away and result in an accident.
- When parking the vehicle, make sure the shift lever is moved to the "P" (Park) position. The shift lever cannot be moved out of the "P" (Park) position without depressing the foot brake pedal.
- Never leave the engine running while the vehicle is unattended.
- Do not leave children unattended inside the vehicle. They could unknowingly activate switches or controls. Unattended children could become involved in serious accidents.
- To help avoid risk of injury or death through unintended operation of the vehicle and/or its systems, do not leave children, people who require the assistance of others or pets unattended in your vehicle. Additionally, the temperature inside a closed vehicle on a warm day can quickly become high enough to cause a significant risk of injury or death to people and pets.

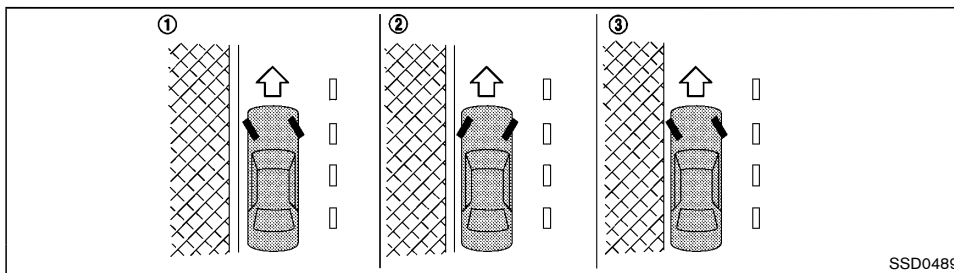

SSD0489

1. Firmly apply the parking brake.
2. Move the shift lever to the "P" (Park) position.
3. To help prevent the vehicle from moving into traffic when parked on an incline, it is a good practice to turn the wheels as illustrated.

HEADED DOWNHILL WITH CURB ①

Turn the wheels into the curb and move the vehicle forward until the curb side wheel gently touches the curb. Then apply the parking brake.

HEADED UPHILL WITH CURB ②

Turn the wheels away from the curb and allow the vehicle to move back until the curb side wheel gently touches the curb. Then apply the parking brake.

HEADED UPHILL OR DOWNHILL, WITHOUT CURB ③

Turn the wheels toward the side of the road so the vehicle will move away from the center of the road if the vehicle moves. Then apply the parking brake.

4. Push the ignition switch in the "OFF" position.

NOTE:

Use the Idling Stop System when the vehicle is stopped for a period of time, for example waiting at stoplights.

Stop the engine with the ignition switch when parking, etc. for an extended period of time.

TRAILER TOWING

Your vehicle was designed to be used to carry passengers and luggage. NISSAN does not recommend trailer towing, because it places additional loads on your vehicle's engine, drivetrain, steering, braking, and other systems.



CAUTION:

Vehicle damage resulting from towing a trailer is not covered by the warranty.

ELECTRIC POWER STEERING



WARNING:

- **If the engine is not running or is turned off while driving, the power assist for the steering will not work. The steering will be harder to operate.**
- **When the electric power steering warning light illuminates with the engine running, the power assist for the steering will cease operation. You will still have control of the vehicle but the steering will be harder to operate.**

The electric power steering is designed to provide power assist while driving to operate the steering wheel with light force.

When the steering wheel is operated repeatedly or continuously while parking or driving at a very low speed, the power assist for the steering wheel will be reduced. This is to prevent overheating of the electric power steering and protect it from getting damaged. While the power assist is reduced, steering wheel operation will become heavy. When the temperature of the electric power steering goes down, the power assist level will return to normal. Avoid repeating such steering wheel operations that could cause the electric power steering to overheat.

You may hear a fricative sound when the steering wheel is operated quickly. However, this is not a malfunction.

If the electric power steering warning light **PS** illuminates while the engine is running, it may indicate the electric power steering is not functioning properly and may need servicing. Have the electric power steering checked by a NISSAN dealer. (See "Electric power steering warning light" (P.2-14).)

When the electric power steering warning light

illuminates with the engine running, the power assist for the steering will cease operation. You will still have control of the vehicle. However, greater steering effort is needed, especially in sharp turns and at low speeds.

BRAKE SYSTEM

The brake system has two separate hydraulic circuits. If one circuit malfunctions, you will still have braking ability at two wheels.

BRAKE PRECAUTIONS

Vacuum assisted brakes

The brake booster aids braking by using engine vacuum. If the engine stops, you can stop the vehicle by depressing the foot brake pedal. However, greater foot pressure on the foot brake pedal will be required to stop the vehicle. The stopping distance will be longer.

If the engine is not running or is turned off while driving, the power assisted brakes will not function. Braking will be harder.



WARNING:

Do not coast with the engine stopped.

When the brake pedal is depressed slowly and firmly, you may hear a clicking noise and feel a slight pulsation. This is normal and indicates that the Brake Assist System is operating.

Using brakes

Avoid resting your foot on the foot brake pedal while driving. This will overheat the brakes, wear out the brake linings/pads faster, and increase fuel consumption.

To help reduce brake wear and to prevent the brakes from overheating, reduce speed and downshift to a lower gear before going down a slope or long grade. Overheated brakes may reduce braking performance and could result in loss of vehicle control.

While driving on a slippery surface, be careful when braking, accelerating or downshifting. Abrupt braking

or acceleration could cause the wheels to skid and result in an accident.

Wet brakes

When the vehicle is washed or driven through water, the brakes may get wet. As a result, your braking distance will be longer and the vehicle may pull to one side during braking.

To dry the brakes, drive the vehicle at a safe speed while lightly depressing the foot brake pedal to heat up the brakes. Do this until the brakes return to normal. Avoid driving the vehicle at high speeds until the brakes function correctly.

Driving downhill

The engine braking action is effective for controlling the vehicle while descending hills. The “L” position should be selected prior to descending.

BRAKE ASSIST

When the force applied to the brake pedal exceeds a certain level, the Brake Assist is activated, generating greater braking force than a conventional brake booster even with light pedal force.



WARNING:

The Brake Assist is only an aid to assist braking operation and is not a collision warning or avoidance device. It is the driver's responsibility to stay alert, drive safely and be in control of the vehicle at all times.

ANTI-LOCK BRAKING SYSTEM (ABS)



WARNING:

- **The Anti-lock Braking System (ABS) is a sophisticated device, but it cannot prevent accidents resulting from careless or dangerous driving techniques. It can help maintain vehicle control during braking on slippery surfaces. Remember that stopping distances on slippery surfaces will be longer than on normal surfaces even with ABS. Stopping distances may also be longer on rough, gravel or snow covered roads, or if you are using tire chains. Always maintain a safe distance from the vehicle in front of you. Ultimately, the driver is responsible for safety.**
- **Tire type and condition may also affect braking effectiveness.**
 - **When replacing tires, install the specified size of tires on all four wheels.**
 - **When installing a spare tire (if equipped), make sure that it is the proper size and type as specified on the tire placard. (See “Tire placard” (P.9-6).)**
 - **For detailed information, see “Tires and wheels” (P.8-26).**

The Anti-lock Braking System (ABS) controls the brakes so the wheels do not lock during hard braking or when braking on slippery surfaces. The system detects the rotation speed at each wheel and varies the brake fluid pressure to prevent each wheel from locking and sliding. By preventing each wheel from locking, the system helps the driver maintain steering control and helps to minimize swerving and spinning on slippery surfaces.

VEHICLE SECURITY

USING SYSTEM

Depress the brake pedal and hold it down. Depress the brake pedal with firm steady pressure, but do not pump the brakes. The ABS will operate to prevent the wheels from locking up. Steer the vehicle to avoid obstacles.



WARNING:

Do not pump the brake pedal. Doing so may result in increased stopping distances.

SELF-TEST FEATURE

The ABS includes electronic sensors, electric pumps, hydraulic solenoids and a computer. The computer has a built-in diagnostic feature that tests the system each time you start the engine and move the vehicle at a low speed in forward or reverse. When the self-test occurs, you may hear a “clunk” noise and/or feel a pulsation in the brake pedal. This is normal and does not indicate a malfunction. If the computer senses a malfunction, it switches the ABS off and illuminates the ABS warning light on the instrument panel. The brake system then operates normally, but without anti-lock assistance.

If the ABS warning light illuminates during the self-test or while driving, have the vehicle checked by a NISSAN dealer.

NORMAL OPERATION

The ABS operates at speeds above 5 to 10 km/h (3 to 6 MPH). The speed varies according to road conditions.

When the ABS senses that one or more wheels are close to locking up, the actuator rapidly applies and releases hydraulic pressure. This action is similar to pumping the brakes very quickly. You may feel a pulsation in the brake pedal and hear a noise from under the hood or feel a vibration from the actuator when it is operating. This is normal and indicates that the ABS is operating properly. However, the pulsation may indicate that road conditions are hazardous and extra care is required while driving.

When leaving your vehicle unoccupied:

- Always take the key with you - even when leaving the vehicle in your own garage.
- Close all windows completely and lock all doors and the rear hatch.
- Always park your vehicle where it can be seen. Park in a well lit area during the night.
- If the security system is equipped, use it - even for a short period.
- Never leave children or pets in the vehicle unattended.
- Never leave valuables inside the vehicle. Always take valuables with you.
- Never leave the vehicle documents in the vehicle.
- Never leave articles on a roof rack. Remove them from the rack and keep and lock them inside the vehicle.
- Never leave the spare key in the vehicle.

COLD WEATHER DRIVING



WARNING:

- **Whatever the condition, drive with caution. Accelerate and decelerate with great care. If accelerating or decelerating too fast, the drive wheels will lose even more traction.**
- **Allow more stopping distance in cold weather driving. Braking should be started sooner than on dry pavement.**
- **Keep at a greater distance from the vehicle in front of you on slippery roads.**
- **Wet ice (0°C, 32°F and freezing rain), very cold snow and ice can be slick and very difficult to drive on. The vehicle will have a lot less traction or grip under these conditions. Try to avoid driving on wet ice until the road is salted or sanded.**
- **Watch for slippery spots (glaring ice). These may appear on an otherwise clear road in shaded areas. If a patch of ice is seen ahead, brake before reaching it. Try not to brake while actually on the ice, and avoid any sudden steering maneuvers.**
- **Do not use cruise control on slippery roads.**
- **Snow can trap dangerous exhaust gas under your vehicle. Keep snow clear of the exhaust pipe and from around your vehicle.**

BATTERY

If the battery is not fully charged during extremely cold weather conditions, the battery fluid may freeze and damage the battery. To maintain maximum efficiency, the battery should be checked regularly. For details, see “Battery” (P.8-17).

ENGINE COOLANT

If the vehicle is to be left outside without anti-freeze, drain the cooling system, including the engine block. Refill before operating the vehicle. For details, see “Changing engine coolant” (P.8-7).

TIRE EQUIPMENT

1. If you have snow tires installed on the front/rear wheels of your vehicle, they should be of the same size, loading range, construction and type (bias, bias-belted or radial) as the rear/front tires.
2. If the vehicle is to be operated in severe winter conditions, snow tires should be installed on all four wheels.
3. For additional traction on icy roads, studded tires may be used. However, some countries, provinces and states prohibit their use. Check local, state and provincial laws before installing studded tires.
Skid and traction capabilities of studded snow tires, on wet or dry surfaces, may be poorer than that of non-studded snow tires.
4. Snow chains may be used if desired. Make sure they are the proper size for the tires on your vehicle and are installed according to the chain manufacturer’s instructions. (See “Tire chains” (P.8-26).)

SPECIAL WINTER EQUIPMENT

It is recommended that the following items be carried in the vehicle during the winter:

- A scraper and stiff-bristled brush to remove ice and snow from the windows.
- A sturdy, flat board to be placed under the jack to give it firm support.
- A shovel to dig the vehicle out of snowdrifts.

PARKING BRAKE

When parking in the area where the outside temperature is below 0°C (32°F), do not apply the parking brake to prevent it from freezing. For safe parking:

- Place the shift lever in the “P” (Park) position.
- Securely block the wheels.

CORROSION PROTECTION

Chemicals used for road surface deicing are extremely corrosive and will accelerate corrosion and the deterioration of underbody components such as the exhaust system, fuel and brake lines, brake cables, floor pan and fenders.

In the winter, the underbody must be cleaned periodically. For additional information, see “Corrosion protection” (P.7-5).

For additional protection against rust and corrosion, which may be required in some areas, consult a NISSAN dealer.

6 In case of emergency

Hazard indicator flasher switch	6-2	Jump starting	6-8
Flat tire	6-2	Push starting	6-10
Stopping vehicle	6-2	If your vehicle overheats	6-10
Preparing tools	6-2	Towing your vehicle	6-11
Changing flat tire (for model with spare tire)	6-3	Towing precautions	6-11
Repairing flat tire (for model with emergency tire puncture repair kit)	6-5	Towing recommended by NISSAN	6-11

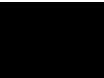

HAZARD INDICATOR FLASHER SWITCH

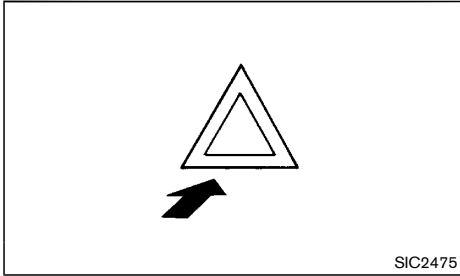

The hazard indicator flasher switch operates with the ignition switch in any position except when the battery is discharged.

The hazard indicator flasher is used to warn other drivers when you have to stop or park under emergency conditions.

When the hazard indicator flasher switch is pushed, all turn signal lights will flash. To turn off the hazard indicator flasher, push the hazard indicator flasher switch again.

FLAT TIRE

If you have a flat tire, follow the instructions as follows.

STOPPING VEHICLE



WARNING:

- **Be sure to apply the parking brake firmly.**
 - **Be sure to move the shift lever to the "P" (Park) position.**
 - **Never change tires when the vehicle is on a slope, ice or slippery area. This is hazardous.**
 - **Never change tires when the oncoming traffic is close to your vehicle. Call for professional road assistance.**
1. Safely move the vehicle off the road away from traffic.
 2. Turn on the hazard indicator flasher lights.
 3. Park on a level surface.
 4. Apply the parking brake.
 5. Move the shift lever to the "P" (Park) position.
 6. Turn off the engine.
 7. Open the hood and set up the warning triangle (if equipped):
 - To warn other traffic.
 - To signal professional road assistance personnel that you need assistance.
 8. Have all passengers get out from the vehicle and stand in a safe place, away from other traffic and clear of the vehicle.

PREPARING TOOLS

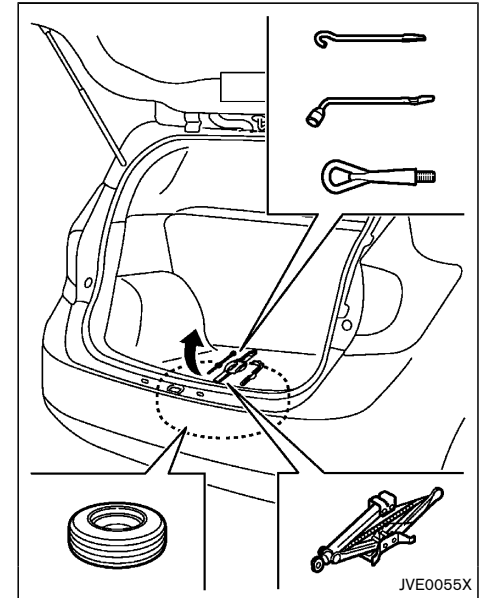

Open the rear hatch. Raise the rear hatch floor cover.

Your vehicle is equipped with either a spare tire or an emergency tire puncture repair kit. Carefully read the instructions provided in the appropriate section.

- For model with spare tire: See "Changing flat tire (for model with spare tire)" (P.6-3).
- For model with emergency tire puncture repair kit: See "Repairing flat tire (for model with emergency tire puncture repair kit)" (P.6-5).

CHANGING FLAT TIRE (for model with spare tire)

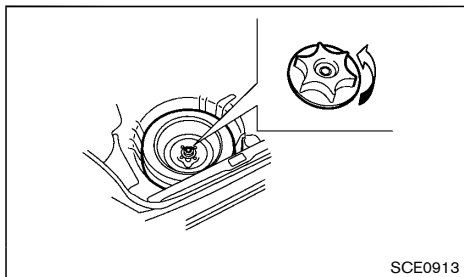

Remove the jack, necessary tools and the spare tire from the storage area.

If spacers are equipped, remove them before removing the spare tire.

Blocking wheels

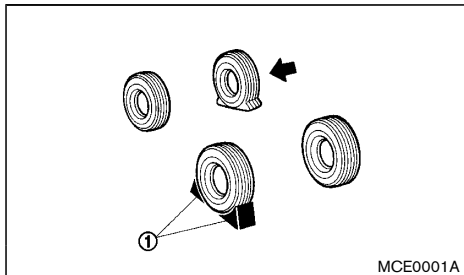

WARNING:

Be sure to block the appropriate wheel to prevent the vehicle from moving, which may cause personal injury.

Place suitable blocks (1) at both the front and back of the wheel diagonally opposite the flat tire ← to prevent the vehicle from moving when it is jacked up.

Removing tire

Removing wheel cover (if equipped):

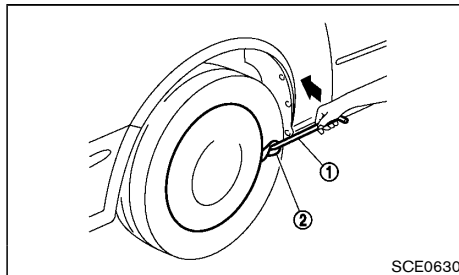

Type A

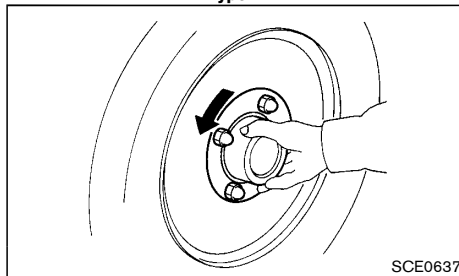

Type B

Type A:

WARNING:

Never use your hands to remove the wheel cover. This may cause personal injury.

To remove the wheel cover, use the jack rod (1) as illustrated.

Apply cloth (2) between the wheel and jack rod to prevent damaging the wheel and wheel cover.

Type B:

Remove the center wheel cap as illustrated.

Jacking up vehicle:

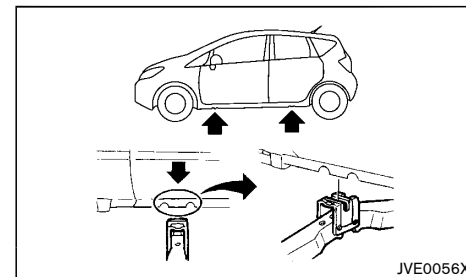

jack-up points

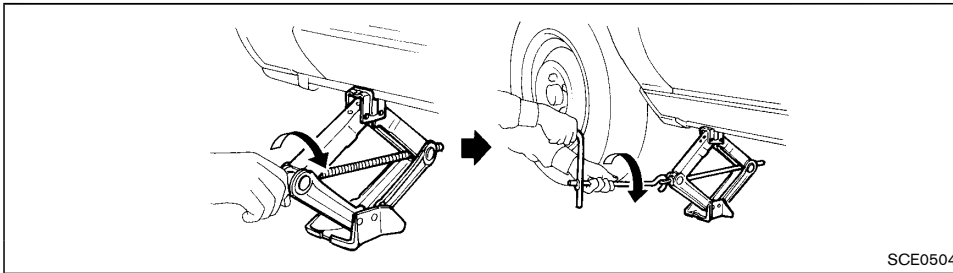

SCE0504

WARNING:

- Be sure to read and follow the instructions in this section.
- **DO NOT GET UNDER A VEHICLE THAT IS SUPPORTED BY A JACK.**
- Never use a jack which was not provided with your vehicle.
- The jack, which is provided with your vehicle, is designed only to lift your vehicle during a tire change. Do not use the jack provided with your vehicle on other vehicles.
- Never jack up the vehicle at a location other than the jack-up point that is specified.
- Never lift the vehicle more than necessary.
- Never use blocks on or under the jack.
- Never start or run the engine while the vehicle is on the jack. The vehicle may move suddenly, and this may cause an accident.
- Never allow passengers to remain in the vehicle while the tire is off the ground.

- Be sure to read the caution label attached to the jack body before using.
- When jacking up the vehicle, be sure to apply the parking brake.

1. Place the jack directly under the jack-up point as illustrated so that the top of the jack contacts the vehicle at the jack-up point.

The jack should be placed on firm level ground.

2. Align the jack head between the two notches located at the jack-up point of either the front or the rear section.
3. Fit the groove of the jack head between the notches as shown.
4. Loosen each wheel nut, counterclockwise, one or two turns with the wheel nut wrench.

Do not remove the wheel nuts until the tire is off the ground.

5. Carefully raise the vehicle until the clearance between the tire and ground is achieved.
6. To lift the vehicle, securely hold the jack lever and rod with both hands and turn the jack lever.

Removing tire:

1. Remove the wheel nuts.
2. Remove the damaged tire.



CAUTION:

The tire is heavy. Be sure that your feet are clear from the tire and use gloves as necessary to avoid injury.

Installing spare tire

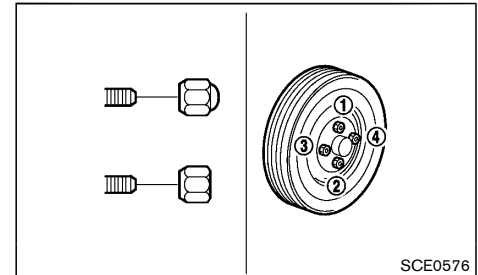

SCE0576



WARNING:

- Never use wheel nuts which are not provided with your vehicle. Incorrect wheel nuts or improperly tightened wheel nuts may cause the wheel to become loose or come off. This could cause an accident.
- Never use oil or grease on the wheel studs or nuts. This may cause the wheel nuts to become loose.
- The temporary-use spare tire is designed for emergency use only.

1. Clean any mud or dirt from the surface between the wheel and hub.
2. Carefully put the spare tire on and tighten the wheel nuts with your fingers. Check that all the wheel nuts contact the wheel surface horizontally.
3. Tighten the wheel nuts alternately and evenly, more than 2 times in the sequence illustrated (① - ④), with the wheel nut wrench, until they are tight.
4. Lower the vehicle slowly until the tire touches the ground.
5. Tighten the wheel nuts securely, with the wheel nut wrench, in the sequence illustrated.
6. Lower the vehicle completely.

Tighten the wheel nuts to the specified torque with a torque wrench as soon as possible.

**Wheel nut tightening torque:
108 N·m (11 kg·m, 80 ft·lb)**

The wheel nuts must be kept tightened to specification at all times. It is recommended that the wheel nuts be tightened to specification at each lubrication interval.



WARNING:

Retighten the wheel nuts when the vehicle has been driven for 1,000 km (600 miles). (also in cases of a flat tire, etc.)

Stowing damaged tire and tools



WARNING:

- **Be sure that the tire, jack and tools used are properly stored after use. Such items can become dangerous projectiles in an accident or sudden stop.**
 - **The temporary-use spare tire is designed for emergency use only.**
1. Securely store the damaged tire, jack and tools used in the storage area.
 2. Replace the floor cover.
 3. Close the rear hatch.

REPAIRING FLAT TIRE (for model with emergency tire puncture repair kit)

The emergency tire puncture repair kit is supplied with the vehicle instead of a spare tire. This repair kit must be used for temporarily fixing a minor tire puncture. After using the repair kit, see a NISSAN dealer as soon as possible for tire inspection and repair/replacement.

For the vehicle jack-up procedures and the tire replacement, see "Changing flat tire (for model with spare tire)" (P.6-3).



CAUTION:

- **NISSAN recommends using only Genuine NISSAN Emergency Tire Sealant provided with your vehicle. Other tire sealants may damage the valve stem seal which can cause the tire to lose air pressure.**
- **Do not use the emergency tire puncture repair kit provided with your vehicle on other vehicles.**

- **Keep the emergency tire puncture repair kit out of the reach of children.**
- **Do not use the emergency tire puncture repair kit for a purpose other than to inflate and check the tire pressure for the vehicle.**
- **Use the emergency tire puncture repair kit only on DC12V.**
- **Keep water and dust off the emergency tire puncture repair kit.**
- **Do not disassemble or modify the emergency tire puncture repair kit.**
- **Do not galvanize the emergency tire puncture repair kit.**
- **Do not use the emergency tire puncture repair kit under the following conditions. Contact a NISSAN dealer or professional road assistance.**
 - **when the sealant has passed its expiration date (shown on the label attached to the bottle)**
 - **when the cut or the puncture is approximately 4 mm (0.16 in) or longer**
 - **when the side of the tire is damaged**
 - **when the vehicle has been driven with a considerable loss of air from the tire**
 - **when the tire is completely displaced inside or outside the rim**
 - **when the tire rim is damaged**
 - **when two or more tires are flat**

Getting emergency tire puncture repair kit

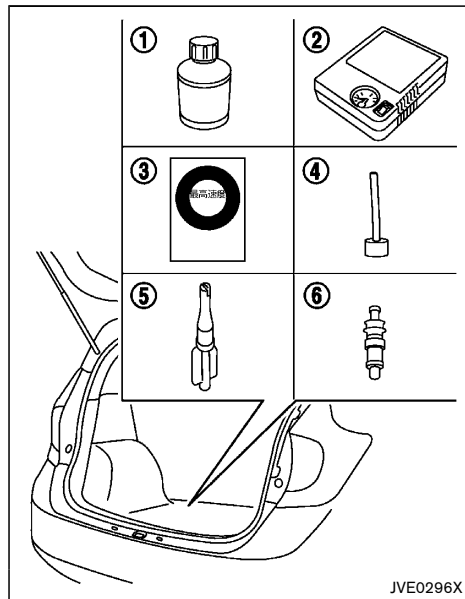

Take out the emergency tire puncture repair kit from the storage under the luggage room. The repair kit consists of the following items:

- ① Tire sealant bottle
- ② Air compressor
- ③ Speed restriction sticker
- ④ Sealant filler tube
- ⑤ Valve core tool
- ⑥ Valve core (for spare)

Before using emergency tire puncture repair kit

- If any foreign object (for example, a screw or nail) is embedded in the tire, do not remove it.
- Check the expiration date of the sealant (shown on the label attached to the bottle). Never use a sealant whose expiration date has passed.

Repairing tire

WARNING:

Observe the following precautions when using the emergency tire puncture repair kit.

- **Swallowing the compound is dangerous. Immediately drink as much water as possible and seek prompt medical assistance.**
- **Rinse well with lots of water if the compound comes into contact with skin or eyes. If irritation persists, seek prompt medical attention.**
- **Keep the repair compound out of the reach of children.**

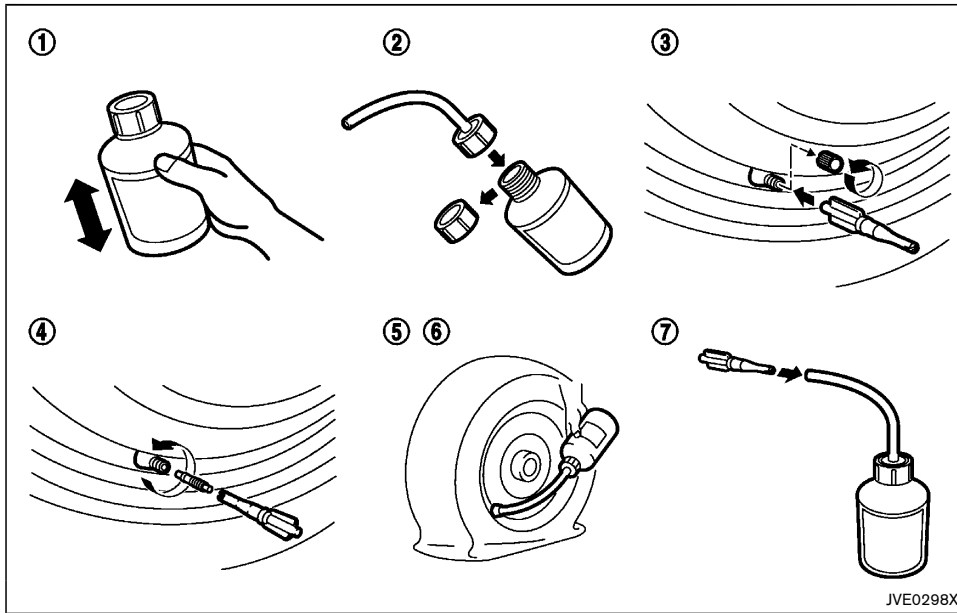

1. Shake the sealant bottle well.
2. Remove the cap on the bottle and screw the sealant filler tube into the bottle.
3. Remove the cap of the valve on the flat tire, and deflate the tire completely by pushing the valve core using the valve core tool.
4. Remove the valve core carefully using the valve core tool. Keep it free of dirt.
5. Insert the tube into the tire valve.

6. Hold the bottle upside down and squeeze it repeatedly until the sealant is injected into the tire. After the sealant is completely injected, pull the tube out of the valve. Install the tire valve core securely into the valve using the valve core tool.

Do not throw away the empty sealant bottle. This bottle is necessary when the tire is repaired or replaced by a NISSAN dealer.

7. Firmly screw the tire valve core tool into the end of the tube to prevent the sealant from leaking out of the empty sealant bottle.

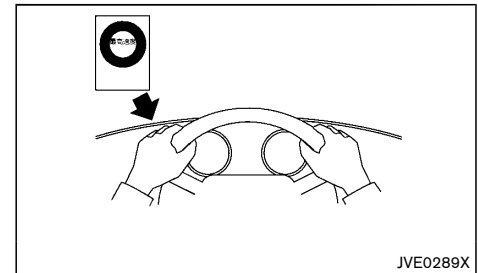

8. Put the speed restriction sticker in a location where the driver can see it while driving.



CAUTION:

Do not put the speed restriction label on the steering wheel pad, the speedometer or the warning light locations.

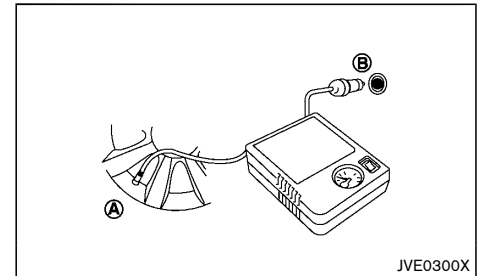

9. Screw the tube of the air compressor securely into the tire valve (A). Insert its power plug to the power outlet (B) in the vehicle. Place the ignition switch in the "ACC" position. Then turn on the compressor, and inflate the tire to the pressure that is specified on the tire placard affixed to the

driver's side center pillar.



CAUTION:

Do not operate the compressor for more than 15 minutes.

If the tire pressure does not increase to the specified pressure or to the minimum of 180 kPa (26 psi) **within 15 minutes**, the tire may be seriously damaged and **the tire cannot be repaired with this tire puncture repair kit**. Contact a NISSAN dealer.

10. When the tire pressure is at the specified amount or at the minimum of 180 kPa (26 psi), remove the air compressor from the tire valve. Immediately drive the vehicle at a speed of 80 km/h (50 MPH) or less.
11. After a 10-minute or 5-km (3 mile) drive, check the tire pressure with the pressure gauge of the air compressor. Make sure that the air compressor switch is in the OFF position.

If the tire pressure drops under 130 kPa (19 psi):
The tire cannot be repaired with this tire puncture repair kit. Contact a NISSAN dealer.

If the tire pressure is 130 kPa (19 psi) or more but less than the specified pressure:

Turn on the compressor and inflate the tire up to the specified pressure. Then repeat the steps from 9.

If the pressure drops again, **the tire cannot be repaired with this tire puncture repair kit**. Contact a NISSAN dealer.

When the tire pressure is the specified pressure:

The temporary repair is completed.

See a NISSAN dealer for tire repair/replacement as soon as possible.



CAUTION:

Do not reuse the tire sealant bottle or the hose.

For a new tire sealant bottle and hose, see a NISSAN dealer.

After repairing tire

See a NISSAN dealer for tire repair/replacement as soon as possible.

JUMP STARTING



WARNING:

- **Incorrect jump starting can lead to a battery explosion. The battery explosion may result in severe injury or death. It may also result in damage to the vehicle. Be sure to follow the instructions in this section.**
- **Explosive hydrogen gas is always present in the vicinity of the battery. Keep all sparks and flames away from the battery.**
- **Always wear suitable eye protection and remove rings, bracelets, and any other jewelry whenever working on or near a battery.**
- **Never lean over the battery while jump starting.**
- **Never allow battery fluid to come into contact with eyes, skin, clothes or the vehicle's painted surfaces. Battery fluid is a corrosive sulfuric acid which can cause severe burns. If the fluid comes into contact with anything, immediately flush the contacted area with plenty of water.**
- **Keep the battery out of the reach of children.**
- **The booster battery must be rated at 12 volts. Use of an incorrectly rated battery will damage your vehicle.**
- **Never attempt to jump start a frozen battery. It could explode and cause serious injury.**

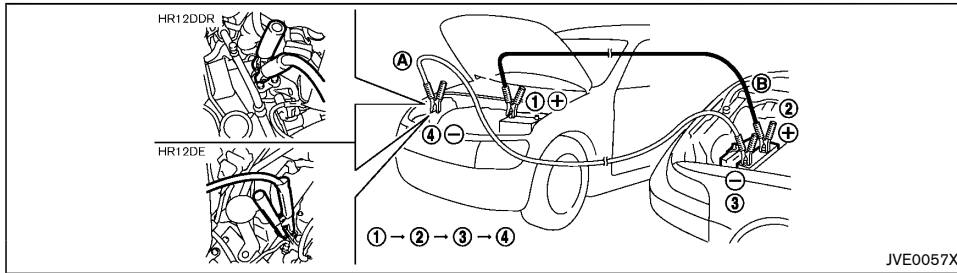

1. If the booster battery is in another vehicle (B), position the two vehicles (A) and (B) to bring the batteries into close proximity to each other.

⚠ CAUTION:

If the battery of vehicle (A) equipped with the Intelligent Key system is discharged, the ignition switch cannot be moved from the “LOCK” position and, if the steering lock is engaged, the steering wheel cannot be moved. Connect the jumper cables to the booster vehicle (B) before turning the ignition switch and disengaging the steering lock.

2. Apply the parking brake.
3. Move the shift lever to the “P” (Park) position.
4. Switch off all unnecessary electrical systems (headlights, heater, air conditioner, etc.).
5. Place the ignition switch in the “LOCK” position.
6. Remove the vent caps, if equipped, on the battery.
7. Cover the battery with a firmly wrung out moist cloth to reduce the hazard of an explosion.

8. Connect the jumper cables in the sequence as illustrated (1, 2, 3, 4).

⚠ CAUTION:

- Always connect positive ⊕ to positive ⊕ and negative ⊖ to body ground, NOT to the battery’s negative ⊖.
- Be sure that the jumper cables do not touch moving parts in the engine compartment.
- Be sure that the jumper cable’s clamps do not contact any other metal.

9. Start the engine of the booster vehicle (B) and let it run for a few minutes.
10. Depress the accelerator pedal of the booster vehicle (B) at about 2,000 rpm.
11. Start the engine of the jumped vehicle (A) in the normal manner.

⚠ CAUTION:

- Never keep the starter motor engaged for more than 10 seconds. If the engine does not start right away, place the ignition switch in the “OFF” position and wait at least 10

seconds before trying again.

- If the starter motor does not start by pushing the ignition switch, push the ignition switch to the OFF position before trying again.
12. After the engine is started, carefully disconnect the jumper cables in the opposite sequence from that illustrated ((4), (3), (2), (1)).
 13. Remove and dispose of the cloth as it may be contaminated with corrosive acid.
 14. Replace the vent caps, if removed.

NOTE:

- Use the special battery that is enhanced in regard to the charge-discharge capacity and life performance. Avoid using a non-special battery for the Idling Stop system, as this may cause early deterioration of the battery or a malfunction of the Idling Stop system. For the battery, it is recommended to use Genuine NISSAN parts. For more information, contact a NISSAN dealer.
- It may take some time until the Idling Stop System activates when the battery is replaced or the battery terminal is disconnected for extended periods and then reconnected.

PUSH STARTING

Do not attempt to start the engine by pushing the vehicle.



CAUTION:

- **Continuously Variable Transmission (CVT) model cannot be started by pushing. Attempting to do so may cause damage to the transmission.**
- **Three-way catalyst equipped model should not be started by pushing. Attempting to do so may cause damage to the three-way catalyst.**
- **Never try to start the engine by towing. When the engine starts, the forward surge could cause the vehicle to collide with the towing vehicle.**

IF YOUR VEHICLE OVERHEATS



WARNING:

- **Never continue driving if your vehicle overheats. Doing so could cause a vehicle fire.**
- **Never open the hood if steam is coming out.**
- **Never remove the radiator cap while the engine is hot. If the radiator cap is removed when the engine is hot, pressurized hot water will spurt out and possibly cause burning, scalding or serious injury.**
- **If steam or coolant is coming from the engine, stand clear of the vehicle to prevent getting burned.**
- **Be careful not to allow your hands, hair, jewelry or clothing to come into contact with, or to get caught in the cooling fan or drive belts. The engine cooling fan will start at any time.**

If your vehicle is overheating (indicated by the high temperature indicator), or if you feel a lack of engine power, detect unusual noise, etc., take the following steps:

1. Safely move the vehicle off the road away from traffic.
2. Turn on the hazard indicator flasher lights.
3. Apply the parking brake.
4. Move the shift lever to the "P" (Park) position.

DO NOT STOP THE ENGINE.

5. Open all windows.
6. Turn off the air conditioner. Set the temperature control to maximum hot and fan control to maximum speed.

7. Get out from the vehicle.
8. Visually inspect and listen for steam or coolant escaping from the radiator before opening the hood. Wait until no steam or coolant can be seen before proceeding.
9. Open the engine hood.
10. Visually inspect if the cooling fan is running.
11. Visually inspect the radiator and radiator hoses for leakage.
If the cooling fan is not running or the coolant is leaking, stop the engine.
12. After the engine cools down, check the coolant level in the reservoir with the engine running. **Do not open the radiator cap.**
13. Add coolant to the reservoir if necessary.

Have your vehicle inspected/repaired at a NISSAN dealer.

TOWING YOUR VEHICLE

Incorrect towing equipment could damage your vehicle. To assure proper towing and to prevent accidental damage to your vehicle, NISSAN recommends that you have professional road assistance personnel tow your vehicle. It is advisable to have the professional road assistant carefully read the following precautions.

TOWING PRECAUTIONS

- Be sure that the transmission, steering system and powertrain are in working condition before towing. If any units are damaged, the vehicle must be towed using a dolly or flatbed tow truck.
- NISSAN recommends that your vehicle be towed with the driving (front) wheels off the ground.
- Always attach safety chains before towing.

TOWING RECOMMENDED BY NISSAN

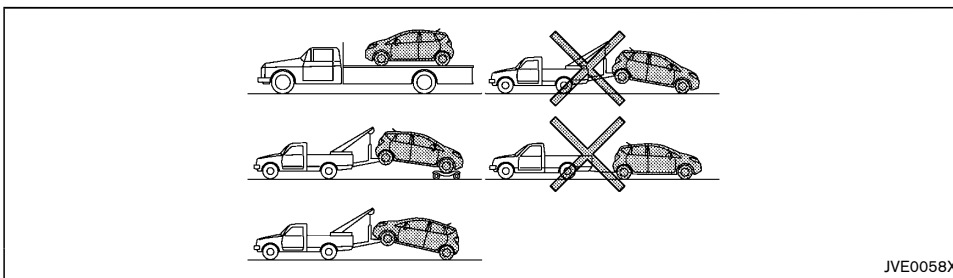

JVE0058X

NISSAN recommends that towing dollies be used under the front wheels when towing your vehicle or the vehicle be placed on a flatbed tow truck as illustrated.

Front wheels on the ground:



CAUTION:

Never tow Continuously Variable Transmission (CVT) model with the front wheels on the ground. Doing so will cause serious and expensive damage to the drivetrain.

Rear wheels on the ground:

1. Place the ignition switch to the "OFF" position.
2. Secure the steering wheel in a straight-ahead position with rope or a similar device.
3. Move the shift lever to the "N" (Neutral) position.
4. Release the parking brake.
5. Attach safety chains whenever towing.

All four wheels on the ground:

NISSAN recommends that the vehicle be placed on a flatbed tow truck as illustrated.



CAUTION:

Never tow Continuously Variable Transmission (CVT) model with all four wheels on the ground. Doing so will cause serious and expensive damage to the transmission.

Freeing trapped vehicle



WARNING:

- **Never allow anyone to stand near the towing line during the pulling operation.**
- **Never spin the tires at high speed. This could cause them to explode and result in serious injury. Parts of the vehicle could also overheat and be damaged.**
- **Do not pull the vehicle using the rear hook. The rear hook is not designed to pull the vehicle out in the event that the vehicle**

becomes trapped.

In the event that your vehicle's tires become trapped in sand, snow, or mud, and the vehicle is unable to free itself without being pulled, use the recovery hooks.

- Use the recovery hooks only. Do not attach the pulling device to any other part of the vehicle body. Otherwise, the vehicle body may be damaged.
- Use the recovery hooks to free a vehicle only. Never tow a vehicle using only the recovery hooks.
- The recovery hooks are under tremendous stress when used to free a trapped vehicle. Always pull the pulling device straight out from the vehicle. Never pull on the recovery hooks at an angle.

Front:

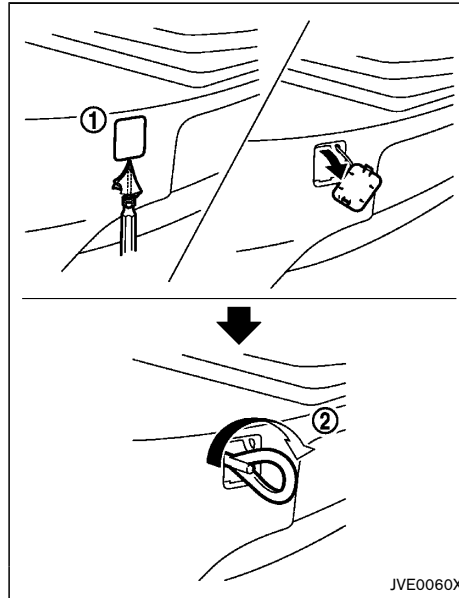

- ① Remove the hook cover from the bumper with a suitable tool.
- ② Securely install the recovery hook as illustrated. (The hook is stored with the jacking tools.)

Make sure that the recovery hook is properly secured in its storage area after use.

Rear:

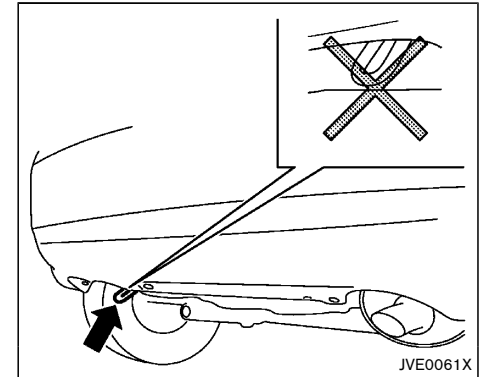

Rear
Do not use the hook to tow the vehicle.

7 Appearance and care

Cleaning exterior	7-2	Cleaning interior	7-3
Washing	7-2	Air fresheners	7-4
Removing spots	7-2	Floor mats	7-4
Waxing	7-2	Glass	7-4
Glass	7-2	Seat belts	7-4
Underbody	7-3	Corrosion protection	7-5
Wheels	7-3	Most common factors contributing to vehicle corrosion	7-5
Aluminum alloy wheels	7-3	Environmental factors influence rate of corrosion	7-5
Chrome parts	7-3	To protect your vehicle from corrosion	7-5



CLEANING EXTERIOR

In order to maintain the appearance of your vehicle, it is important to take proper care of it.

Whenever possible, park your vehicle inside a garage or in a covered area to minimize the chances of damaging the paint surface of your vehicle.

When it is necessary to park outside, park in a shady area or protect the vehicle with a body cover. **Be careful not to scratch the paint surface when putting on or removing the body cover.**

WASHING

In the following instances, wash your vehicle as soon as possible to protect the paint surface:

- After a rainfall, which may cause the paint surface damage from acid rain.
 - After driving on coastal roads, which may cause rusting from the sea breeze.
 - When contaminants such as soot, bird droppings, tree sap, metal particles or bugs get on the paint surface.
 - When dust or mud builds up on the paint surface.
1. Wash the vehicle surface with a wet sponge and plenty of water.
 2. Clean the vehicle surface gently and thoroughly using a mild soap, a special vehicle soap or a general purpose dishwashing liquid mixed with clean, lukewarm (never hot) water.



CAUTION:

- **Do not wash the vehicle with strong household soap, strong chemical detergents, gasoline or solvents.**
- **Do not wash the vehicle in direct sunlight or while the vehicle body is hot, as the paint surface may become water-spotted.**

- **Avoid using tight-napped or rough cloths, such as washing mitts. Care must be taken when removing caked-on dirt or other foreign substances so the paint surface is not scratched or damaged.**
3. Rinse the vehicle thoroughly with plenty of clean water.
 4. Use a dampened chamois to dry the paint surface and avoid leaving water spots.

When washing the vehicle, take care of the following:

- Inside flanges, joints and folds on the doors, hatches and hood are particularly vulnerable to the effects of road salt. Therefore, these areas must be cleaned regularly.
- Be sure that the drain holes in the lower edge of the doors are not clogged.
- Spray water to the underbody and in the wheel wells to loosen the dirt and/or wash away road salt.

REMOVING SPOTS

Remove tar and oil spots, industrial dust, insects, and tree sap as quickly as possible from the paint surface to avoid lasting damage or staining. Special cleaning products are available at a NISSAN dealer or any automotive accessory store.

WAXING

Regular waxing protects the paint surface and helps maintain a new vehicle appearance.

After waxing, polishing is recommended to remove built-up residue and to avoid a weathered appearance.

A NISSAN dealer can assist you in choosing the appropriate waxing products.



CAUTION:

- **Wash your vehicle thoroughly and completely before applying wax to the paint surface.**
- **Always follow the manufacturer's instructions supplied with the wax.**
- **Do not use a wax containing any abrasives, cutting compounds or cleaners that may damage the vehicle finish.**

Machine compounding or aggressive polishing on a base coat/clear coat paint finish may dull the finish or leave swirl marks.

GLASS

Use glass cleaner to remove smoke and dust film from the glass surfaces. It is normal for glass to become coated with a film after the vehicle is parked in the hot sun. Glass cleaner and a soft cloth will easily remove this film.

UNDERBODY

In areas where road salt is used in the winter, it is necessary to clean the vehicle's underbody regularly in order to prevent dirt and salt from building up and causing the acceleration of corrosion on the underbody and suspension.

Before the winter and again in the spring, the underseal must be checked and, if necessary, re-treated.

WHEELS

- Wash the wheels when washing the vehicle to maintain their appearance.
- Clean the inner side of the wheels when the wheel is changed or the underside of the vehicle is washed.
- Do not use abrasive cleaners when washing the wheels.
- Inspect wheel rims regularly for dents or corrosion. This may cause loss of pressure or damage the tire bead.
- NISSAN recommends that the road wheels be waxed to protect against road salt in areas where it is used during winter.

ALUMINUM ALLOY WHEELS

Wash the wheels regularly with a sponge dampened in a mild solution, especially during winter in areas where road salt is used.

The salt residue from road salt could discolor the wheels if it is not washed off regularly.



CAUTION:

Follow the directions below to avoid staining or discoloring the wheels:

- **Do not use a cleaner that uses strong acid or alkali contents to clean the wheels.**
- **Do not apply wheel cleaners to the wheels when they are hot. The wheel temperature should be the same as ambient temperature.**
- **Rinse the wheel to completely remove the cleaner within 15 minutes after the cleaner is applied.**

CHROME PARTS

Clean all chrome parts regularly with a nonabrasive chrome polish to maintain the finish.

CLEANING INTERIOR

Occasionally remove loose dust from the interior trim, plastic parts and seats using a vacuum cleaner or soft bristled brush. Wipe the vinyl and leather surfaces with a clean, soft cloth dampened in mild soap solution, then wipe clean with a dry, soft cloth.

Regular care and cleaning is required in order to maintain the appearance of the leather.

Before using any fabric protector, read the manufacturer's recommendations. Some fabric protectors contain chemicals that may stain or bleach the seat material.

Use a soft cloth dampened only with water to clean the meter and gauge lens covers.



CAUTION:

- **Never use benzine, thinner or any similar material.**
- **Small dirt particles can be abrasive and damaging to leather surfaces and should be removed promptly. Do not use saddle soap, car waxes, polishes, oils, cleaning fluids, solvents, detergents or ammonia-based cleaners as they may damage the leather natural finish.**
- **Never use fabric protectors unless recommended by the manufacturer.**
- **Do not use glass or plastic cleaner on meter or gauge lens covers. It may damage the lens covers.**

AIR FRESHENERS

Most air fresheners use a solvent that could affect the vehicle interior. If you use an air freshener, take the following precautions:

- Hanging-type air fresheners can cause permanent discoloration when they contact vehicle interior surfaces. Place the air freshener in a location that allows it to hang free and not contact an interior surface.
- Liquid-type air fresheners typically clip on the vents. These products can cause immediate damage and discoloration when spilled on interior surfaces.

Carefully read and follow the manufacturer's instructions before using air fresheners.

FLOOR MATS

The use of genuine NISSAN floor mats (if equipped) can extend the life of your vehicle carpet and make it easier to clean the interior. Regardless of what mats are used, be sure they are fitted for your vehicle and are properly positioned in the foot well to prevent interference with pedal operation. Mats should be maintained with regular cleaning and replaced if they become excessively worn.

Floor mat positioning aid (driver's side)

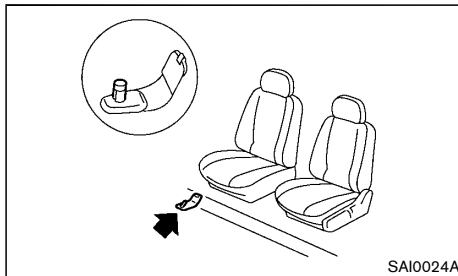

Example

This vehicle includes a front floor mat bracket to act as a floor mat positioning aid. NISSAN floor mats have been specially designed for your vehicle model. The driver's floor mat has a grommet hole incorporated in it.

Position the mat by placing the floor mat bracket hook through the floor mat grommet hole while centering the mat in the foot area.

Periodically check that the mats are properly positioned.

GLASS

Use glass cleaner to remove smoke and dust film from the glass surfaces. It is normal for glass to become coated with a film after the vehicle is parked in the hot sun. Glass cleaner and a soft cloth will easily remove this film.



CAUTION:

When cleaning the inside of the windows, do not use sharp-edged tools, abrasive cleaners or chlorine-based disinfectant cleaners. They could damage the electrical conductors, such as rear window defogger elements.

The inside of the front door glass is treated with a UV cut coating. When cleaning the inside of the front door glass, remove dirt, dust, etc. immediately with a soft cloth moistened with cold or warm water.



CAUTION:

To prevent damage or deterioration of the UV cut coating, observe the following.

- **When the front door glass is heavily soiled, do not open or close the window glass.**
- **When cleaning the front door glass, do not use glass cleaners containing polishing compounds (abrasives) or alcohol based cleaners.**
- **Do not clean the window glass using a cloth to which sand, etc. has adhered.**

SEAT BELTS



WARNING:

- **Do not allow wet seat belts to roll up in the retractor.**
- **Never use bleach, dye or chemical solvents to clean the seat belts, since these materials may severely weaken the seat belt webbing.**

The seat belts can be cleaned by wiping them with a sponge dampened in a mild soap solution.

Allow the belts to dry completely in the shade before using them. (See "Seat belts" (P.1-6).)

CORROSION PROTECTION

MOST COMMON FACTORS CONTRIBUTING TO VEHICLE CORROSION

- The accumulation of moisture-retaining dirt and debris in body panel sections, cavities, and other areas.
- Damage to the paint surface and other protective coatings caused by gravel and stone chips or minor traffic accidents.

ENVIRONMENTAL FACTORS INFLUENCE RATE OF CORROSION

Moisture

The accumulation of sand, dirt and water on the inside floor of the vehicle can accelerate corrosion. Wet floor carpet/floor mats will not dry completely inside the vehicle. They should be removed and completely dried to avoid floor panel corrosion.

Relative humidity

Corrosion will be accelerated in areas of high relative humidity.

Temperature

High temperatures accelerate the rate of corrosion to those parts which are not well ventilated.

Corrosion will also be accelerated in areas where the temperatures stay above freezing.

Air pollution

Industrial pollution, the presence of salt in the air in coastal areas, or heavy road salt use accelerates the corrosion process. Road salt also accelerates the disintegration of paint surfaces.

TO PROTECT YOUR VEHICLE FROM CORROSION

- Wash and wax your vehicle often to keep the vehicle clean.
- Always check for minor damage to the paint surface and if any exists, repair it as soon as possible.
- Keep the drain holes in the lower edge of the doors open to avoid water accumulation.
- Check the vehicle underbody for accumulation of sand, dirt or salt. If present, wash with water as soon as possible.



CAUTION:

- **Never remove dirt, sand or other debris from the passenger compartment by washing it out with a hose. Remove dirt with a vacuum cleaner or broom.**
- **Never allow water or other liquids to come in contact with electronic components inside the vehicle as this may damage them.**

Chemicals used for road surface deicing are extremely corrosive. They accelerate corrosion and deterioration of underbody components such as the exhaust system, fuel and brake lines, brake cables, floor pan and fenders.

In the winter, the underbody must be cleaned periodically.

For additional protection against rust and corrosion, which may be required in some areas, consult a NISSAN dealer.

MEMO

8 Maintenance and do-it-yourself

Maintenance requirements	8-2	Air cleaner filter	8-13
Scheduled maintenance	8-2	Wiper blades	8-14
General maintenance	8-2	Windshield wiper blades	8-14
Where to go for service	8-2	Rear window wiper blade	8-15
General maintenance	8-2	Window washer fluid	8-15
Explanation of general maintenance items	8-2	Battery	8-17
Maintenance precautions	8-4	Vehicle battery	8-17
Engine compartment check locations	8-5	Intelligent Key battery	8-18
HR12DE engine model	8-5	Fuses	8-19
HR12DDR engine model	8-6	Engine compartment	8-19
Engine cooling system	8-6	Passenger compartment	8-20
Checking engine coolant level	8-7	Lights	8-21
Changing engine coolant	8-7	Headlights	8-21
Engine oil	8-7	Exterior lights	8-21
Checking engine oil level	8-7	Interior lights	8-22
Changing engine oil and oil filter	8-8	Light locations	8-23
Protect environment	8-10	Tires and wheels	8-26
Drive belts	8-10	Tire inflation pressure	8-26
HR12DE engine model	8-10	Types of tires	8-26
HR12DDR engine model	8-10	Tire chains	8-26
Spark plugs	8-11	Tire rotation	8-26
Iridium-tipped spark plugs	8-11	Tire wear and damage	8-27
Brakes	8-11	Tire age	8-27
Checking parking brake	8-11	Changing tires and wheels	8-27
Checking foot brake pedal	8-11	Wheel balance	8-27
Brake booster	8-12	Spare tire (if equipped)	8-27
Brake fluid	8-12	Emergency tire puncture repair kit (if equipped)	8-28
Continuously Variable Transmission (CVT) fluid	8-13		

MAINTENANCE REQUIREMENTS

Some day-to-day and regular maintenance is essential to maintain your vehicle's good mechanical condition, as well as its emission and engine performance.

It is the owner's responsibility to make sure that the specified maintenance, as well as general maintenance, is performed.

As the vehicle owner, you are the only one who can ensure that your vehicle receives the proper maintenance care.

SCHEDULED MAINTENANCE

For your convenience, the required scheduled maintenance items are described and listed in a separate Warranty Information and Maintenance booklet. You must refer to that booklet to ensure that necessary maintenance is performed on your vehicle at regular intervals.

GENERAL MAINTENANCE

General maintenance includes those items which should be checked during normal day-to-day operation of the vehicle. They are essential if your vehicle is to continue to operate properly. It is your responsibility to perform these procedures regularly as prescribed.

Performing general maintenance checks requires minimal mechanical skill and only a few general automotive tools.

These checks or inspections can be done by yourself, a qualified technician, or if you prefer, your NISSAN dealer.

WHERE TO GO FOR SERVICE

If maintenance service is required or your vehicle appears to malfunction, have the systems checked and tuned by an authorised NISSAN dealer.

GENERAL MAINTENANCE

During normal day-to-day operation of the vehicle, general maintenance should be performed regularly as prescribed in this section. If you detect any unusual sounds, vibrations or smells, be sure to check for the cause or have a NISSAN dealer do it promptly. In addition, you should notify a NISSAN dealer if you think that repairs are required.

When performing any checks or maintenance work, closely observe "Maintenance precautions" (P.8-4).

EXPLANATION OF GENERAL MAINTENANCE ITEMS

Additional information on the following items with "*" is found later in this section.

Outside vehicle

The maintenance items listed here should be performed from time to time, unless otherwise specified.

Doors and hood:

Check that all doors and the hood operate smoothly as well as the back door, trunk lid and hatch. Also make sure that all latches lock securely. Lubricate if necessary. Make sure that the secondary latch keeps the hood from opening when the primary latch is released. When driving in areas using road salt or other corrosive materials, check lubrication frequently.

Lights*:

Clean the headlights on a regular basis. Make sure that the headlights, stop lights, tail lights, turn signal lights, and other lights are all operating properly and installed securely. Also check the aim of the headlights.

Tires*:

Check the pressure with a gauge often and always prior to long distance trips. Adjust the pressure in all tires, including the spare, to the pressure specified. Check carefully for damage, cuts or excessive wear.

Tire rotation*:

In the case that Two-Wheel Drive (2WD) and front and rear tires are same size; tires should be rotated every 10,000 km (6,000 miles). Tires marked with directional indicators can only be rotated between front and rear. Make sure that the directional indicators point in the direction of wheel rotation after the tire rotation is completed.

In the case that Four-Wheel Drive and All-Wheel Drive (4WD/AWD) and front and rear tires are same size; tires should be rotated every 5,000 km (3,000 miles). Tires marked with directional indicators can only be rotated between front and rear. Make sure that the directional indicators point in the direction of wheel rotation after the tire rotation is completed.

In the case that front tires are different size from rear tires; tires cannot be rotated.

However, the timing for tire rotation may vary according to your driving habits and the road surface conditions.

Tire Pressure Monitoring System (TPMS) transmitter components (if so equipped):

Replace the TPMS transmitter grommet seal, valve core and cap when the tires are replaced due to wear or age.

Wheel alignment and balance:

If the vehicle should pull to either side while driving on a straight and level road, or if you detect uneven or abnormal tire wear, there may be a need for wheel alignment. If the steering wheel or seat vibrates at normal highway speeds, wheel balancing may be

needed.

Windshield:

Clean the windshield on a regular basis. Check the windshield at least every six months for cracks or other damage. Repair as necessary.

Wiper blades*:

Check for cracks or wear if not functioning correctly. Replace as necessary.

Inside vehicle

The maintenance items listed here should be checked on a regular basis, such as when performing periodic maintenance, cleaning the vehicle, etc.

Accelerator pedal:

Check the pedal for smooth operation and make sure that the pedal does not catch or require uneven effort. Keep the floor mats away from the pedal.

Brake pedal*:

Check the pedal for smooth operation and make sure that it is the proper distance from the floor mat when depressed fully. Check the brake booster function. Be sure to keep the floor mats away from the pedal.

Parking brake*:

Check the parking brake operation regularly. Check that the lever (if so equipped) or the pedal (if so equipped) has the proper travel. Also make sure that the vehicle is held securely on a fairly steep hill when only the parking brake is applied.

Seat belts:

Check that all parts of the seat belt system (for example, buckles, anchors, adjusters and retractors) operate properly and smoothly, and are installed securely. Check the belt webbing for cuts, fraying, wear or damage.

Steering wheel:

Check for changes in the steering condition, such as excessive play, hard steering or strange noises.

Warning lights and chimes:

Make sure that all warning lights and chimes are operating properly.

Windshield defogger:

Check that the air comes out of the defogger outlets properly and in good quantity when operating the heater or air conditioner.

Windshield wiper and washer*:

Check that the wipers and washer operate properly and that the wipers do not streak.

Under hood and vehicle

The maintenance items listed here should be checked periodically (for example, each time you check the engine oil or refuel).

Battery* (except for maintenance free batteries) :

Check the fluid level in each cell. It should be between the UPPER and LOWER lines. Vehicles operated in high temperatures or under severe conditions require frequent checks of the battery fluid level.

Brake (and clutch) fluid level(s)*:

For Manual Transmission (MT) model; make sure that the brake and clutch fluid levels are between the MAX and MIN lines on the reservoirs.

Except for Manual Transmission (MT) model; make sure that the brake fluid level is between the MAX and MIN lines on the reservoir.

Engine coolant level* :

Check the coolant level when the engine is cold. Make sure that the coolant level is between the MAX and MIN lines on the reservoir.

Engine drive belt(s)*:

Make sure that drive belt(s) is not frayed, worn, cracked or oily.

Engine oil level*:

Check the level after parking the vehicle (on a level ground) and turning off the engine.

Fluid leaks:

Check under the vehicle for fuel, oil, water or other fluid leaks after the vehicle has been parked for a while. Water dripping from the air conditioner after use is normal. If you should notice any leaks or if fuel fumes are evident, check for cause and have it corrected immediately.

Window washer fluid*:

Check that there is adequate fluid in the reservoir.

MAINTENANCE PRECAUTIONS

When performing any inspection or maintenance work on your vehicle, always take care to prevent serious accidental injury to yourself or damage to the vehicle. The following are general precautions which should be closely observed.



WARNING:

- **Park the vehicle on a level surface, apply the parking brake securely and block the wheels to prevent the vehicle from moving. Move the shift lever to the "P" (Park) position.**

- **Be sure the ignition switch is in the "OFF" or "LOCK" position when performing any parts replacement or repairs.**
- **Do not work under the hood while the engine is hot. Always turn off the engine and wait until it cools down.**
- **If you must work with the engine running, keep your hands, clothing, hair and tools away from moving fans, belts and any other moving parts.**
- **It is advisable to secure or remove any loose clothing and any jewelry, such as rings, watches, etc. before working on your vehicle.**
- **If you must run the engine in an enclosed space such as a garage, be sure there is proper ventilation for exhaust gases to escape.**
- **Never get under the vehicle while it is supported by a jack.**
- **Keep smoking materials, flame and sparks away from fuel and the battery.**
- **Never connect or disconnect either the battery or any transistorized component connector while the ignition switch is in the "ON" position.**
- **On gasoline engine models with the Multi-port Fuel Injection (MFI) system, the fuel filter and fuel lines should be serviced by a NISSAN dealer because the fuel lines are under high pressure even when the engine is turned off.**
- **Your vehicle is equipped with an automatic engine cooling fan. It may come on at any time without warning, even if the ignition**

switch is in the "OFF" position and the engine is not running. To avoid injury, always disconnect the negative battery cable before working near the fan.

- **Always wear eye protection whenever you work on your vehicle.**
- **Never leave the engine or the transmission related component harness connector disconnected while the ignition switch is in the "ON" position.**
- **Avoid direct contact with used engine oil and coolant. Improperly disposed engine oil, engine coolant, and/or other vehicle fluids can hurt the environment. Always conform to local regulations for disposal of vehicle fluids.**

This "8. Maintenance and do-it-yourself" section provides instructions regarding only those items which are relatively easy for an owner to perform.

You should be aware that incomplete or improper servicing may result in operating difficulties or excessive emissions, and could affect your warranty coverage. **If in doubt about any servicing, have it done by a NISSAN dealer.**

ENGINE COMPARTMENT CHECK LOCATIONS

HR12DE ENGINE MODEL

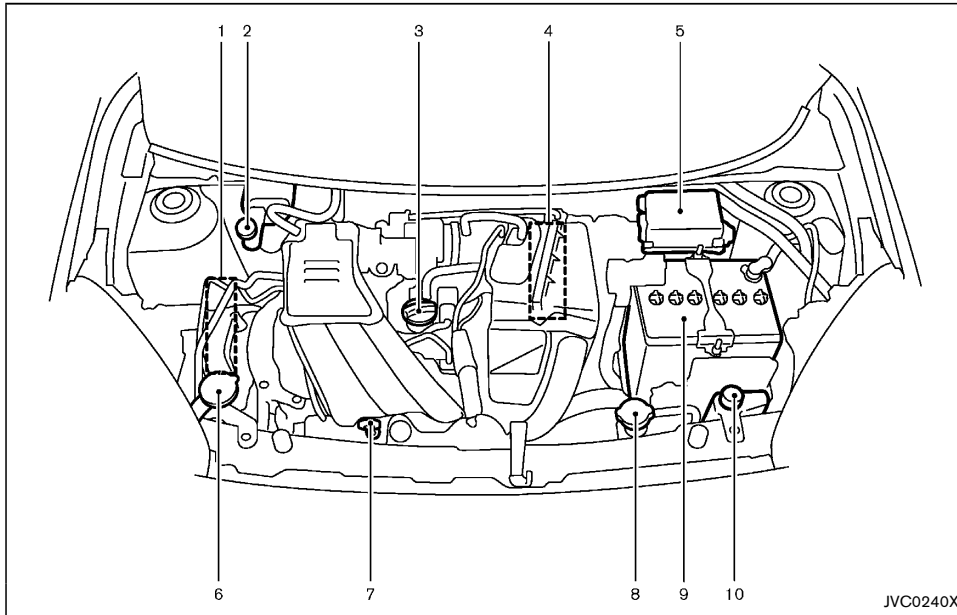

- | | |
|----------------------------------|------------------------------|
| 1. Engine drive belts | 8. Radiator cap |
| 2. Brake fluid reservoir | 9. Battery |
| 3. Engine oil filler cap | 10. Engine coolant reservoir |
| 4. Air cleaner | |
| 5. Fuse/fusible link box | |
| 6. Window washer fluid reservoir | |
| 7. Engine oil dipstick | |

ENGINE COOLING SYSTEM

HR12DDR ENGINE MODEL

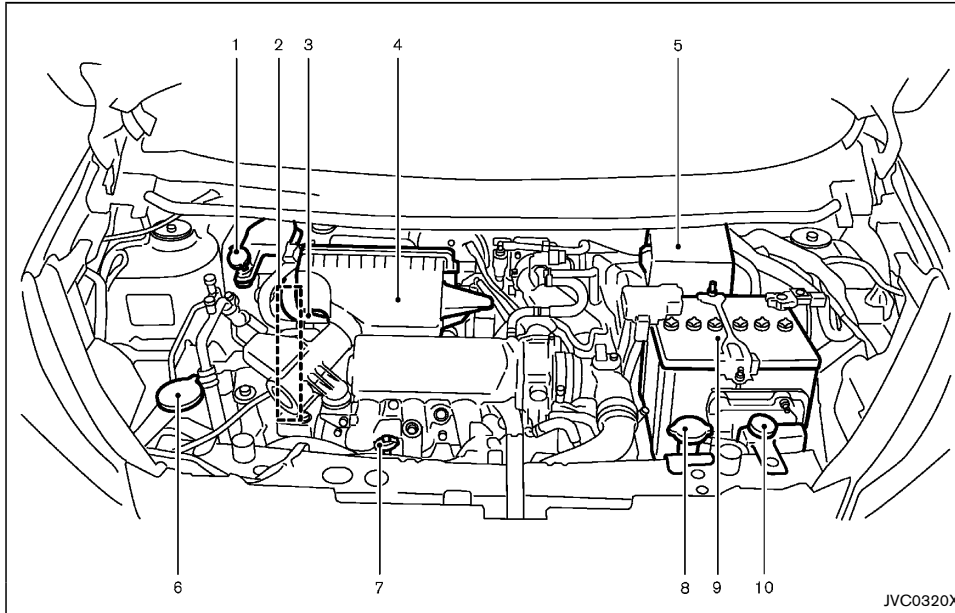

- | | |
|----------------------------------|------------------------------|
| 1. Brake fluid reservoir | 9. Battery |
| 2. Engine drive belts | 10. Engine coolant reservoir |
| 3. Engine oil filler cap | |
| 4. Air cleaner | |
| 5. Fuse/fusible link box | |
| 6. Window washer fluid reservoir | |
| 7. Engine oil dipstick | |
| 8. Radiator cap | |



WARNING:

- Never remove the radiator or coolant reservoir cap when the engine is hot. Serious burns could be caused by high-pressure fluid escaping from the radiator. Wait until the engine and radiator cool down.
- Engine coolant is poisonous and should be stored carefully in marked containers out of the reach of children.

The engine cooling system is filled at the factory with a high-quality, year-round, anti-freeze coolant solution. The anti-freeze solution contains rust and corrosion inhibitors, therefore additional cooling system additives are not necessary.



CAUTION:

- Never use any cooling system additives such as radiator sealer. Additives may clog the cooling system and cause damage to the engine, transmission and/or cooling system.
- When adding or replacing coolant, be sure to use only Genuine NISSAN Engine Coolant or equivalent in its quality with the proper mixture ratio. Examples of the mixture ratio of coolant and water are shown in the following table:

Outside temperature down to		Composition	
°C	°F	Engine coolant (concentrated)	Demineralized or distilled water
-15	5	30%	70%
-35	-30	50%	50%

The use of other types of coolant solutions may damage the engine cooling system.

The radiator is equipped with a pressure cap. To prevent engine damage, use only a Genuine NISSAN radiator cap or its equivalent when replacement is required.

CHECKING ENGINE COOLANT LEVEL

HR12DE and HR12DDR engine model

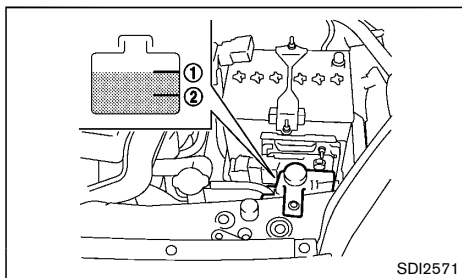

Check the coolant level in the reservoir when the engine is cold. If the coolant level is below the MIN level (2), add coolant up to the MAX level (1). If the reservoir is empty, check the coolant level in the radiator **when the engine is cold**. If there is insufficient coolant in the radiator, fill the radiator with coolant up to the filler opening and also add it to the

reservoir up to the MAX level (1).

If the cooling system frequently requires coolant, have it checked by a NISSAN dealer.

CHANGING ENGINE COOLANT

Contact a NISSAN dealer if replacement is required.

Major engine cooling system repair should be performed by a NISSAN dealer. The service procedures can be found in the appropriate NISSAN Service Manual.

Improper servicing can result in reduced heater performance and engine overheating.



WARNING:

- **To avoid being scalded, never change the coolant when the engine is hot.**
- **Never remove the radiator cap when the engine is hot. Serious burns could be caused by high pressure fluid escaping from the radiator.**
- **Avoid direct skin contact with used coolant. If skin contact is made, wash thoroughly with soap or hand cleaner as soon as possible.**
- **Keep coolant out of reach of children and pets.**

Engine coolant must be disposed of properly. Check your local regulations.

ENGINE OIL

CHECKING ENGINE OIL LEVEL

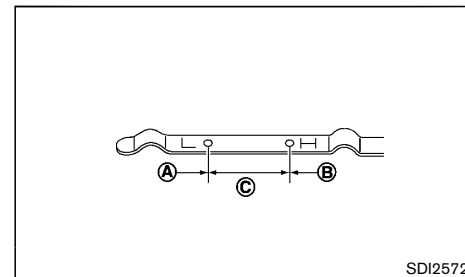

HR12DE and HR12DDR engine model

1. Park the vehicle on a level surface and apply the parking brake.
2. Start the engine and warm it up until the engine temperature reaches the normal operating temperature (approximately 5 minutes).
3. Stop the engine.
4. Wait at least 10 minutes for the engine oil to drain back to the oil pan.
5. Remove the dipstick and wipe it clean.
6. Reinsert the dipstick all the way.
7. Remove the dipstick and check the oil level. It should be within the range (C).
8. If the oil level is below (A), remove the oil filler cap and pour the recommended oil into the opening. Do not overfill (B).
9. Recheck the oil level with the dipstick.

It is normal to add some oil between oil maintenance intervals or during the break-in period, depending on the severity of operating conditions.

CAUTION:

The oil level should be checked regularly. Operating your vehicle with an insufficient amount of oil can damage the engine, and such damage is not covered by warranty.

CHANGING ENGINE OIL AND OIL FILTER

WARNING:

- Used oil must be disposed of properly. Never pour or dump oil into the ground, canals, rivers, etc. It should be disposed of at proper waste facilities. NISSAN recommends having your oil changed by a NISSAN dealer.
- Be careful not to burn yourself, as the engine oil may be hot.
- Prolonged and repeated contact with used engine oil may cause skin cancer.
- Avoid direct skin contact with used oil. If contacted, wash thoroughly with soap or hand cleaner and plenty of water as soon as possible.
- Store used engine oil in marked containers out of the reach of children.

CAUTION:

Waste oil must be disposed of properly. Check your local regulations.

Engine oil replacement

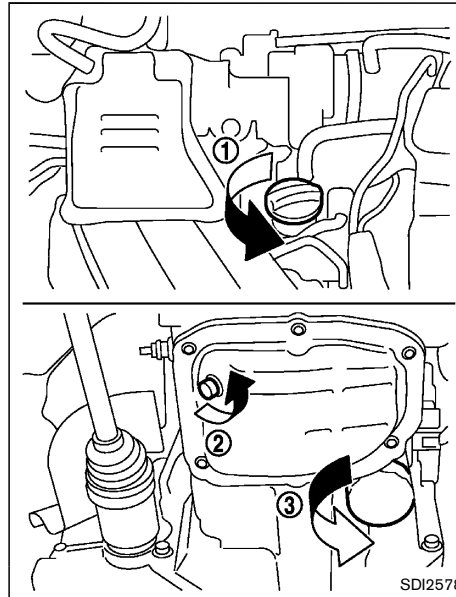

HR12DE engine model

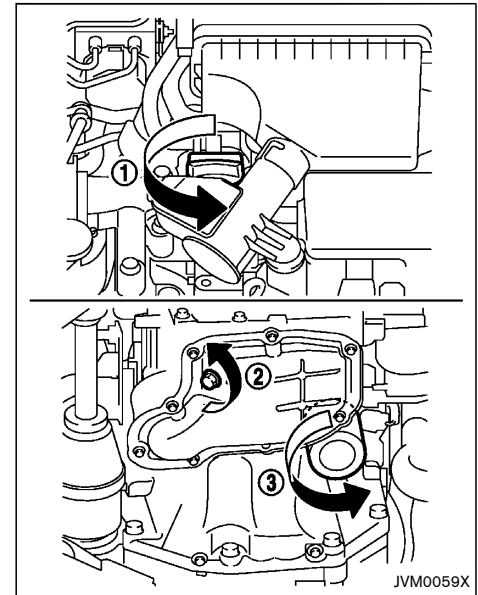

HR12DDR engine model

- ① Oil filler cap
- ② Oil drain plug
- ③ Oil filter

1. Park the vehicle on a level surface and apply the parking brake.
2. Start the engine and warm it up until the engine temperature reaches the normal operating temperature (approximately 5 minutes).
3. Stop the engine.

4. Wait at least 10 minutes for the engine oil to drain back to the oil pan.
5. Place a large drain pan under the drain plug.
6. Remove the drain plug with a wrench.
7. Remove the oil filler cap and completely drain the oil.

If the oil filter is to be changed, remove and replace it at this time. (See "Engine oil filter replacement" (P.8-9).)

8. Clean and reinstall the drain plug and new washer. Securely tighten the drain plug with a wrench. Do not use excessive force.

Drain plug tightening torque:
29 to 39 N·m
(3.0 to 4.0 kg·m, 21 to 29 ft·lb)

9. Refill the recommended engine oil and quantity. (See "Recommended fluids/lubricants and capacities" (P.9-2).)
10. Securely install the oil filler cap.
11. Start the engine.
12. Check the drain plug for any sign of leakage.
13. Check the engine oil level according to the proper procedure. (See "Checking engine oil level" (P.8-7).)

Engine oil filter replacement

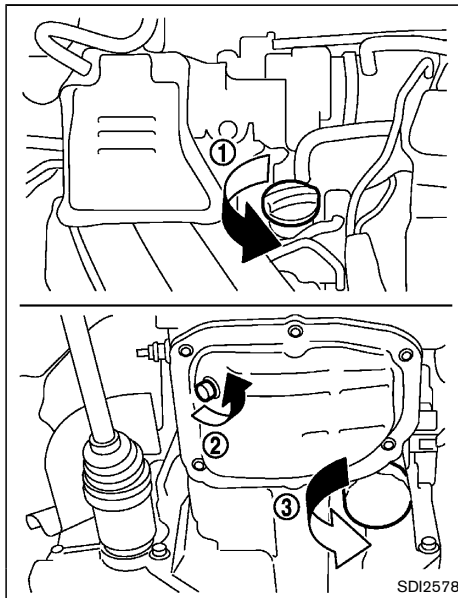

HR12DE engine model

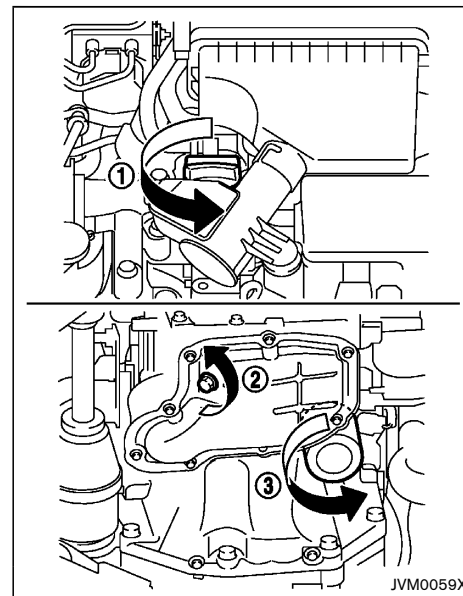

HR12DDR engine model

- ① Oil filler cap
- ② Oil drain plug
- ③ Oil filter

1. Park the vehicle on a level surface and apply the parking brake.
2. Turn the engine off.
3. Drain the engine oil according to the proper procedure. (See "Engine oil replacement" (P.8-8).)

DRIVE BELTS

4. Loosen the oil filter with an oil filter wrench.

Depending on the engine model, a special cap type wrench may be required. See a NISSAN dealer for more information.

5. Remove the oil filter by turning it by hand.
6. Wipe the engine oil filter mounting surface with a clean cloth.
Be sure to remove any old gasket remaining on the mounting surface.
7. Apply the new engine oil to the gasket of the new oil filter.

8. Screw in the oil filter until a slight resistance is felt, and then tighten an additional 2/3 of turn to secure the oil filter.

**Oil filter tightening torque:
15 to 20 N·m (11 to 15 ft·lb)**

9. Refill the engine oil. (See "Engine oil replacement" (P.8-8).)
10. Start the engine and check for leakage around the oil filter. Correct as required.
11. Turn the engine off and wait several minutes.
12. Check the engine oil level according to the proper procedure. (See "Checking engine oil level" (P.8-7).)

PROTECT ENVIRONMENT

It is illegal to pollute drains, watercourses and soil. Use authorized waste collection facilities, including civil amenity sites and garages providing facilities for disposal of used oil and used oil filters. If in doubt, contact your local authority for advice on disposal.

The regulations concerning the pollution of the environment will vary from country to country.

HR12DE ENGINE MODEL

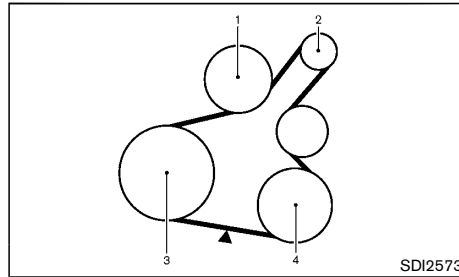

HR12DE engine

1. Water pump
 2. Alternator
 3. Crankshaft pulley
 4. Air conditioner compressor
- ▼: Tension checking point

Be sure the ignition switch is in the "OFF" position.

Visually inspect each belt for signs of unusual wear, cuts, fraying or looseness. Check regularly for condition and tension. If the belt is in poor condition or loose, have it replaced or adjusted by a NISSAN dealer.

HR12DDR ENGINE MODEL

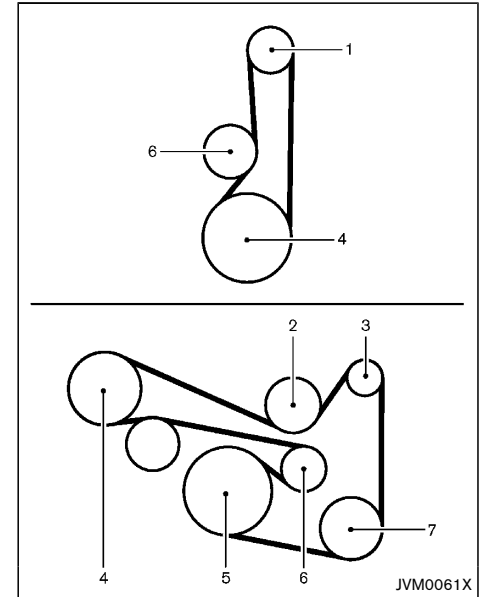

HR12DDR engine

1. Supercharger
2. Water pump
3. Alternator
4. Electromagnetic clutch
5. Crankshaft pulley
6. Drive belt auto-tensioner
7. Air conditioner compressor

Be sure the ignition switch is in the "OFF" position.

Visually inspect each belt for signs of unusual wear,

SPARK PLUGS

cuts, fraying or looseness. Check regularly for condition and tension. If the belt is in poor condition or loose, have it replaced or adjusted by a NISSAN dealer.



WARNING:

Be sure the engine and ignition switch are off and that the parking brake is applied.

Replace the spark plugs according to the maintenance log shown in a separate maintenance booklet.

If replacement is required, contact a NISSAN dealer.

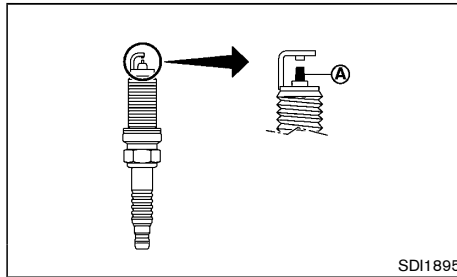

IRIDIUM-TIPPED SPARK PLUGS

It is not necessary to replace the iridium-tipped (A) spark plugs as frequently as the conventional type of spark plugs. These spark plugs are designed to last much longer than the conventional type of spark plug.



CAUTION:

- **Do not reuse the iridium-tipped spark plugs by cleaning or re-gapping.**
- **Always replace with the recommended iridium-tipped spark plugs.**

BRAKES

CHECKING PARKING BRAKE

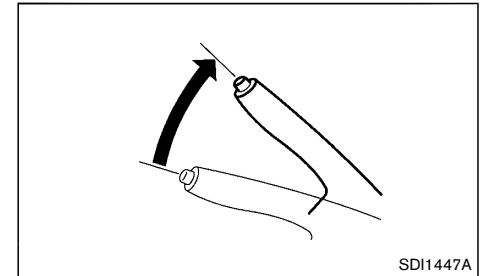

From the released position, pull the parking brake lever up slowly and firmly. If the number of clicks is out of the range listed, see a NISSAN dealer.

Except for Thailand:

11 to 12 clicks

Pulling force 196 N (20 kg, 44 lb)

For Thailand:

10 to 11 clicks

Pulling force 196 N (20 kg, 44 lb)

CHECKING FOOT BRAKE PEDAL

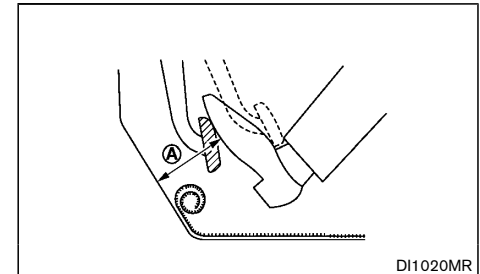



WARNING:

See a NISSAN dealer for a brake system check if the foot brake pedal height does not return to normal.

With the engine running, check the distance (A) between the upper surface of the pedal and the metal floor. If it is out the range listed, see a NISSAN dealer.

(A) : **Depressing force**
490 N (50 kg, 110 lb)
80 mm (3.15 in) or more

Self-adjusting brakes

Your vehicle is equipped with self-adjusting brakes. The brakes are adjusted by the foot brake pedal operation.

Brake pad wear indicator

The disc brake pads on your vehicle have audible wear indicators. When a brake pad requires replacement, it will make a high pitched scraping or screeching sound when the vehicle is in motion. The noise will be heard whether or not the foot brake pedal is depressed. Have the brakes checked as soon as possible if the wear indicator sound is heard.

Under some driving or climate conditions, occasional brake squeaks, squeals or other noises may be heard. Occasional brake noise during light to moderate stops is normal and does not affect the function or performance of the brake system.

Proper brake inspection intervals should be followed. For additional information, see a separate maintenance booklet.

BRAKE BOOSTER

Check the brake booster function as follows:

1. With the engine off, depress and release the foot brake pedal several times. When the foot brake pedal movement (distance of travel) remains the same from one pedal application to the next, continue on to the next step.
2. While depressing the foot brake pedal, start the engine. The pedal height should drop a little.
3. With the foot brake pedal depressed, stop the engine. Keep the pedal depressed for about 30 seconds. The pedal height should not change.
4. Run the engine for 1 minute without depressing the foot brake pedal, then turn it off. Depress the foot brake pedal several times. The pedal travel distance will decrease gradually with each depression as the vacuum is released from the booster.

If the brakes do not operate properly, have the brakes checked by a NISSAN dealer.

BRAKE FLUID



WARNING:

- Use only new fluid from a sealed container. Old, inferior, or contaminated fluid may damage the brake system. The use of improper fluids can damage the brake system and affect the vehicle's stopping ability.
- Clean the filler cap before removing.
- Brake fluid is poisonous and should be stored carefully in marked containers out of the reach of children.



CAUTION:

Do not spill the fluid on painted surfaces. This will damage the paint. If fluid is spilled, wash it off with plenty of water immediately.

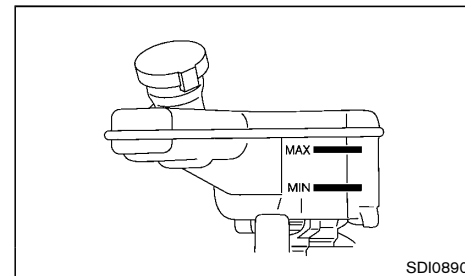

SDI0890

Check the fluid level in the reservoir. If the brake fluid is below the MIN line, the brake warning light will illuminate. Add brake fluid up to the MAX line. (See "Recommended fluids/lubricants and capacities" (P.9-2) for recommended types of brake fluid.)

If the brake fluid must be added frequently, the brake

CONTINUOUSLY VARIABLE TRANSMISSION (CVT) FLUID

system should be thoroughly checked by a NISSAN dealer.

Contact a NISSAN dealer if checking or replacement is required.



CAUTION:

- Use only Genuine NISSAN CVT Fluid NS-3. Do not mix with other fluids.
- Using transmission fluid other than Genuine NISSAN CVT Fluid NS-3 will damage the CVT, which is not covered by the warranty.

AIR CLEANER FILTER

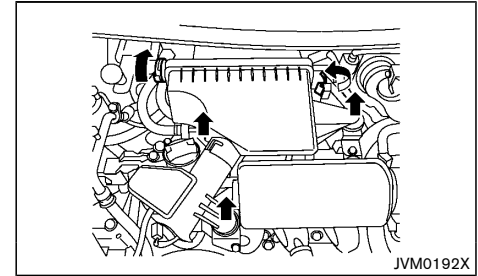

HR12DDR engine

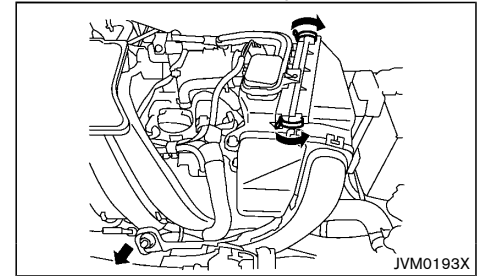

HR12DE engine



WARNING:

Operating the engine with the air cleaner filter off can cause you or others to be burned. The air cleaner filter not only cleans the intake air, it also stops flame if the engine backfires. If the air cleaner filter is not installed and the engine backfires, you could be burned. Never drive with the air cleaner filter off. Be cautious working on the engine when the air cleaner filter is off.

To remove the filter, release the lock pins and pull the unit upward.

WIPER BLADES

The viscous paper type filter element should not be cleaned and reused.

The dry paper type filter element may be cleaned and reused.

Replace the air cleaner filter according to the maintenance log shown in a separate maintenance booklet.

WINDSHIELD WIPER BLADES

Cleaning

If the windshield does not become clear after using the windshield washer or if the wiper blades chatter when operating the windshield wipers, wax or other materials may be on the windshield and/or wiper blades.

Clean the outside of the windshield surface with a washer solution or mild detergent. Your windshield is clean if beads do not form when rinsing with water.

Clean the blade by wiping it with a cloth soaked in a washer solution or a mild detergent. Rinse the blade with water. If your windshield is still not clear after cleaning the blades and using the wipers, replace the blades.

Be careful not to clog the washer nozzle. This may cause improper windshield washer operation. If the nozzle is clogged, contact a NISSAN dealer.

WINDOW WASHER FLUID

Replacing

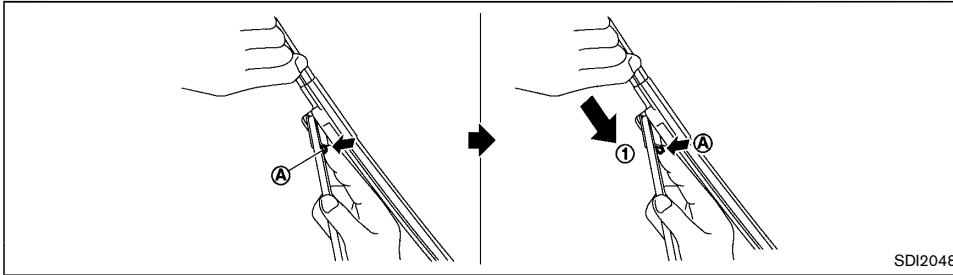

1. Lift the wiper arm away from the windshield.
2. Push and hold the release tab (A), and then move the wiper blade down the wiper arm to remove ①.
3. Remove the wiper blade.
4. Insert the new wiper blade onto the wiper arm until it clicks into place.

REAR WINDOW WIPER BLADE

Contact a NISSAN dealer if checking or replacement is required.

CAUTION:

- After wiper blade replacement, return the wiper arm to its original position. Otherwise the wiper arm or the engine hood may be scratched and may cause damage.
- Worn windshield wiper blades can damage the windshield and impair driver vision.

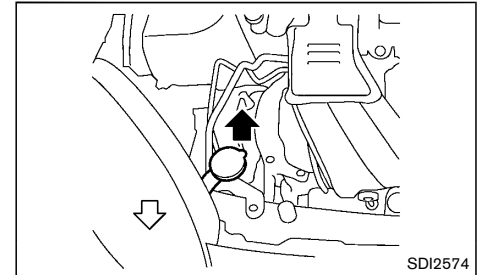

Type A

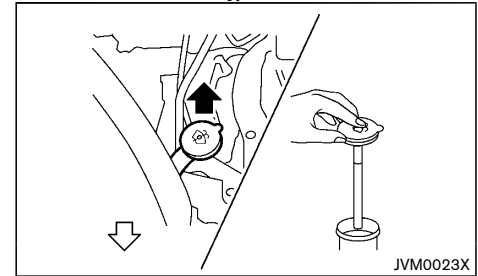

Type B

WARNING:

Anti-freeze is poisonous and should be stored carefully in marked containers out of the reach of children.







Type A: Check the fluid level in the window washer reservoir. If the fluid level is low, add window washer fluid.

Type B: To check the fluid level, use your finger to plug the center hole of the cap/tube assembly, then remove it from the reservoir. If there is no fluid in the tube, add fluid.

Add a washer solvent to the water for better cleaning. In the winter season, add a windshield washer anti-freeze. Follow the manufacturer's instructions for the mixture ratio.

BATTERY

VEHICLE BATTERY

Caution symbols for battery			⚠ WARNING
①		No smoking, No exposed flames, No sparks	Never smoke around battery. Never expose battery to open flames or electrical sparks.
②		Shield eyes	Handle the battery cautiously. Always wear eye protection glasses to protect against explosion or battery acid.
③		Keep away from children	Never allow children to handle battery. Keep the battery out of the reach of children.
④		Battery acid	Do not allow battery fluid to contact your skin, eyes, fabrics, or painted surfaces. After handling the battery or battery cap, immediately wash your hands thoroughly. If the battery fluid gets into your eyes, or onto your skin or clothing, flush with water immediately for at least 15 minutes and seek medical attention. Battery fluid is acid. If the battery fluid gets into your eyes or onto your skin, it could cause loss of your eyesight or burns.
⑤		Note operating instructions	Before handling the battery, read this instruction carefully to ensure correct and safe handling.
⑥		Explosive gas	Hydrogen gas, generated by battery fluid, is explosive.

SDI1573



WARNING:

Do not operate the vehicle if the fluid in the battery is low. Low battery fluid can cause a higher load on the battery which can generate heat, reduce battery life, and in some cases lead to an explosion.

Checking battery fluid level

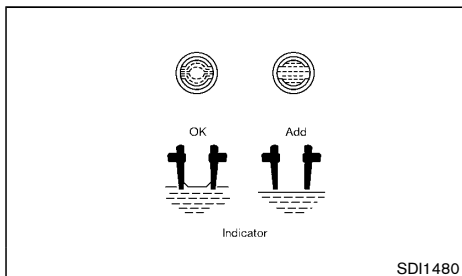
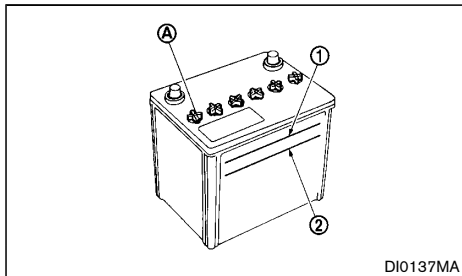

Check the fluid level in each cell. The battery fluid level should be between the UPPER LEVEL ① and LOWER LEVEL ② lines.

If it is necessary to add fluid, add only demineralized/distilled water to bring the level to the indicator in each filler opening. Do not overfill.

1. Remove the cell plugs (A), if equipped.
2. Add demineralized/distilled water up to the UPPER LEVEL ① line.
3. Replace and tighten the cell plugs.

- Vehicles operated in high temperatures or under severe conditions require frequent checks of the battery fluid level.
- Keep the battery surface clean and dry. Clean the battery with a solution of baking soda and water.
- Make certain the terminal connections are clean and securely tightened.
- If the vehicle is not to be used for more than 30 days, disconnect the negative (-) battery terminal cable to prevent battery discharge.

Jump starting

If jump starting is necessary, see “Jump starting” (P.6-8). If the engine does not start by jump starting or the battery does not charge, the battery may have to be replaced. Contact a NISSAN dealer for replacing the battery.

INTELLIGENT KEY BATTERY

Battery replacement



- **Be careful not to allow children to swallow the battery and removed parts.**
- **An improperly disposed battery can harm the environment. Always confirm local regulations for battery disposal.**
- **When changing batteries, do not let dust or oil get on the components.**
- **There is danger of explosion if lithium battery is incorrectly replaced. Replace only with the same or equivalent type.**

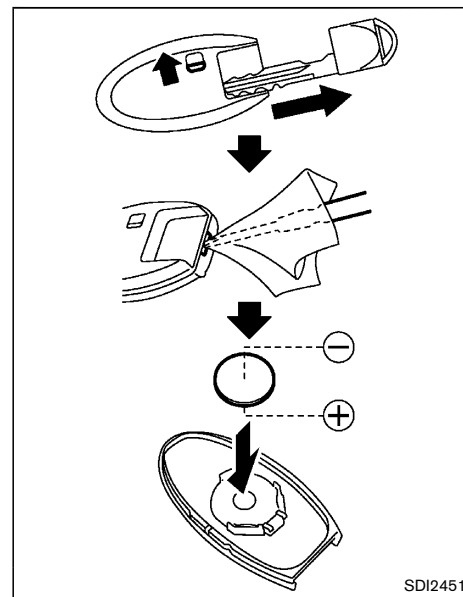

To replace the battery:

1. Release the lock knob at the back of the Intelligent Key and remove the mechanical key.
2. Insert a small screwdriver into the slit of the corner and twist it to separate the upper part from the lower part. Use a cloth to protect the casing.
3. Replace the battery with a new one.
 - Recommended battery: CR2025 or equivalent
 - Do not touch the internal circuit and electric terminals as doing so could cause a malfunction.

FUSES

- Make sure that the ⊕ side faces the bottom of the case.

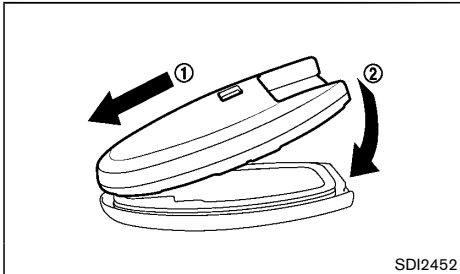

ENGINE COMPARTMENT

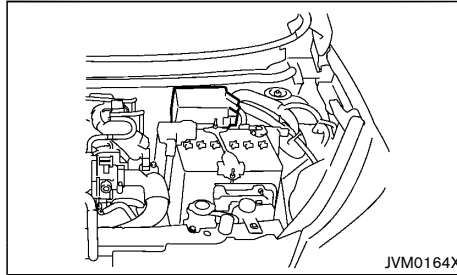

For checking and/or replacing, see a NISSAN dealer.

Fusible links

If any electrical equipment does not operate and the fuses are in good condition, check the fusible links. If any of these fusible links are melted, replace only with genuine NISSAN parts.

4. Align the tips of the upper and lower parts ①, and then push them together until it is securely closed ②.

5. Operate the buttons to check its operation.

See a NISSAN dealer if you need assistance for replacement.

PASSENGER COMPARTMENT

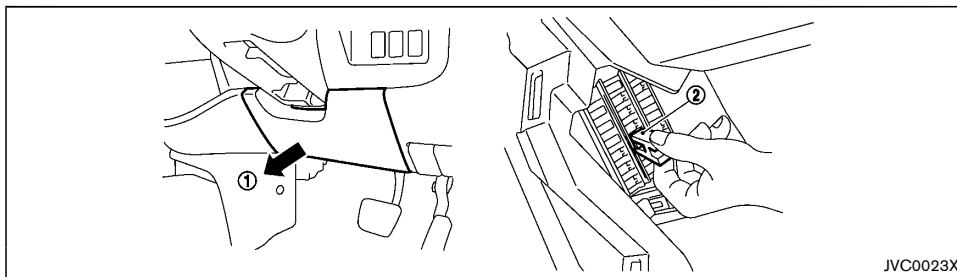
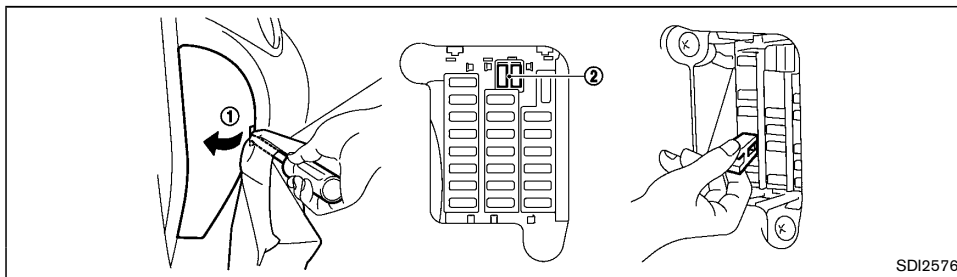

CAUTION:

Never use a fuse of a higher or lower amperage rating than that specified on the fuse box cover. This could damage the electrical system or cause a fire.

If any electrical equipment does not operate, check for an open fuse.

1. Be sure the ignition switch is in the "OFF" position.

2. Be sure the headlight switch is in the "OFF" position.
3. Remove the fuse box cover ① with a suitable tool.
4. Locate the fuse that needs to be replaced.
5. Remove the fuse using the fuse puller ②.

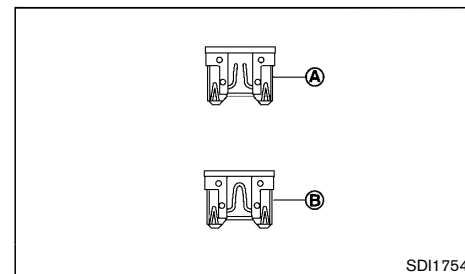

6. If the fuse is open ①, replace it with a new fuse ②.

If the new fuse also opens, after installing, have the electrical system checked, and if necessary repaired, by a NISSAN dealer.

Extended storage fuse switch (if equipped)

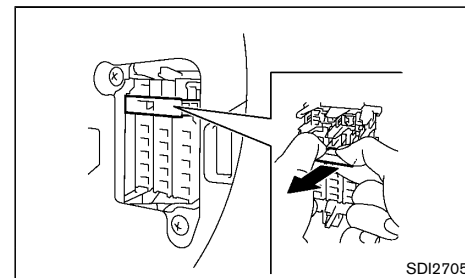

If any electrical equipment does not operate, remove the extended storage fuse switch and check for an open fuse.

LIGHTS

NOTE:

If the extended storage fuse switch malfunctions, or if the fuse is open, it is not necessary to replace the switch. In this case, remove the extended storage fuse switch and replace it with a new fuse of the same rating.

How to remove the extended storage fuse switch:

1. To remove the extended storage fuse switch, be sure the ignition switch is in the "OFF" or "LOCK" position.
2. Be sure the headlight switch is in the "OFF" position.
3. Remove the fuse box cover.
4. Pinch the storage fuse switch and pull it in the direction illustrated.

HEADLIGHTS

Fog may temporarily form inside the lens of the exterior lights in the rain or in a car wash. A temperature difference between the inside and the outside of the lens causes the fog. This is not a malfunction. If large drops of water collect inside the lens, contact a NISSAN dealer.

LED headlight bulb

If replacement is required, contact a NISSAN dealer.

Halogen headlight bulb

If replacement is required, contact a NISSAN dealer.

The halogen headlight is a semi-sealed beam type which uses replaceable headlight (halogen) bulbs. They can be replaced from inside the engine compartment without removing the headlight assembly.



CAUTION:

- **High-pressure halogen gas is sealed inside the bulb. The bulb may break if the glass envelope is scratched or the bulb is dropped.**
- **When handling the bulb, do not touch the glass envelope.**
- **Use the same number and wattage as originally installed:**

Halogen headlight model

High beam bulb: 60W (HB3)

Low beam bulb: 55W (H11)

LED headlight model

High beam bulb: 60W (HB3)

- **Do not leave the bulb out of the headlight reflector for a long period of time as dust, moisture and smoke may enter the headlight**

body and affect the performance of the headlight.

Aiming adjustment is not necessary if only the bulbs are replaced. When aiming adjustment is necessary, contact a NISSAN dealer.

EXTERIOR LIGHTS

Item	Wattage (W)	
Front turn signal light	21	
Front clearance light	Halogen headlight model	5
	LED headlight model*	LED
Front fog light (if equipped)	35	
Side turn signal light*	LED	
Rear combination lights		
Turn signal light	21	
Stop light*	LED	
Tail light	5	
Reverse light	16	
High-mounted stop light*	LED	
License plate light	5	

*: See a NISSAN dealer for replacement.

INTERIOR LIGHTS

Item	Wattage (W)
Map light	5
Room light	5

LIGHT LOCATIONS

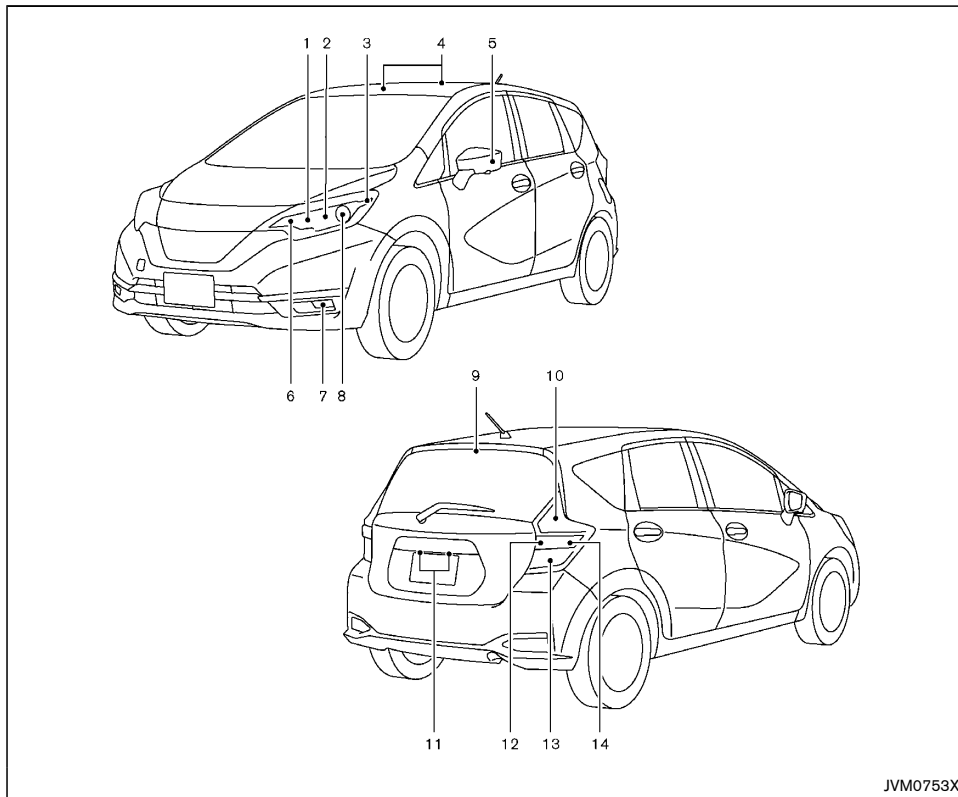

1. Front turn signal light
2. Headlight (high-beam)
3. Clearance light (LED headlight model)
4. Interior light
5. Side turn signal light
6. Clearance light (Halogen headlight model)
7. Front fog light (if equipped)
8. Headlight (low-beam)
9. High-mounted stop light
10. Tail light
11. License plate light
12. Reverse light
13. Stop light
14. Rear turn signal light

JVM0753X

Replacement procedures

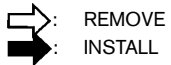
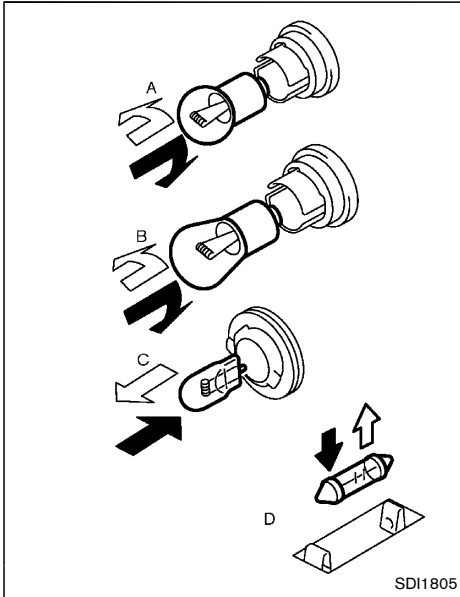

All other lights are either type A, B, C or D. When replacing a bulb, first remove the lens and/or cover.

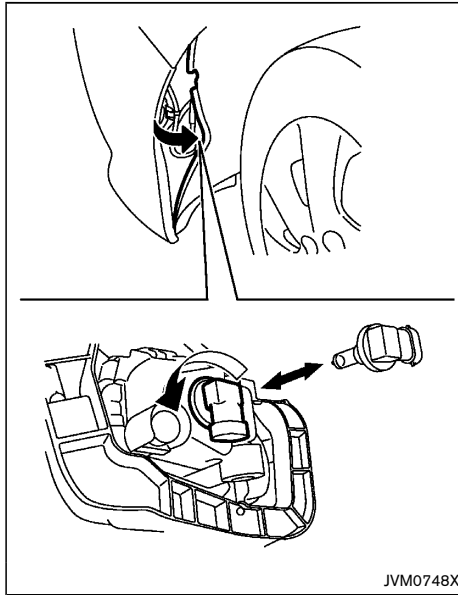

Front fog light (if equipped)

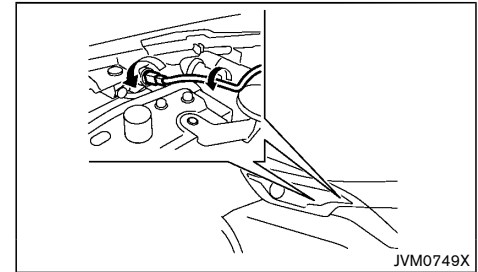

Clearance light (Halogen headlight model)/Front turn signal light

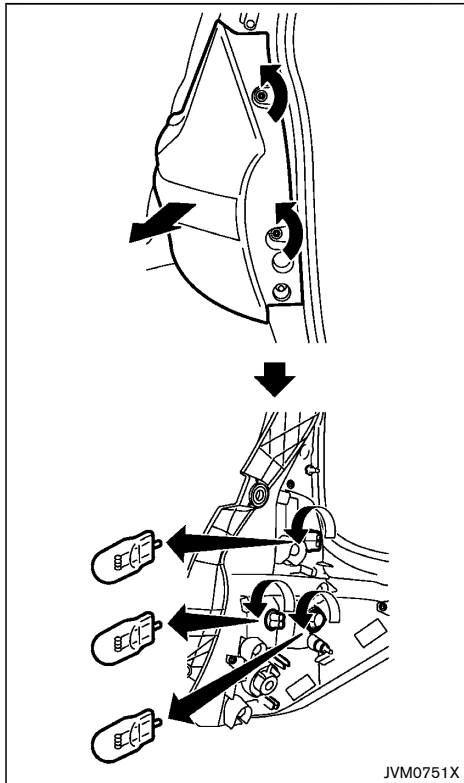

Rear combination light

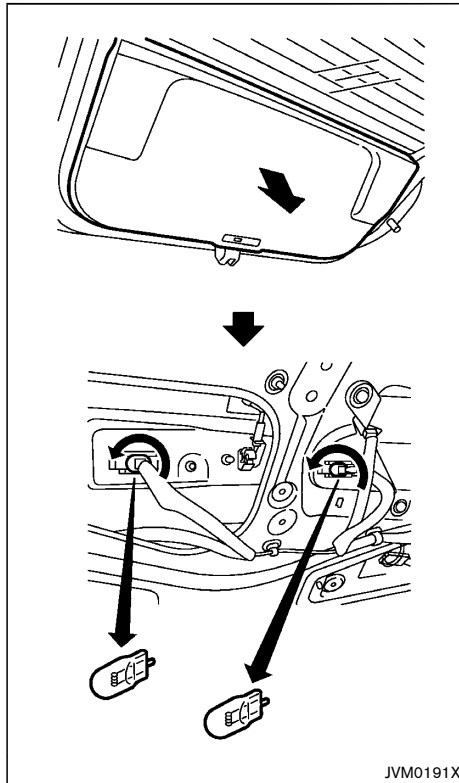

License plate light

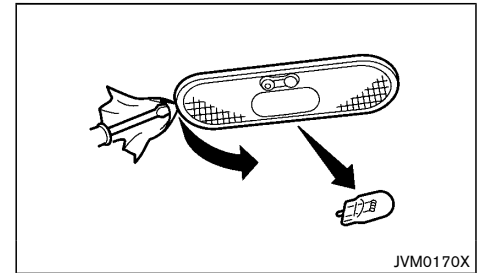

Interior light

TIRES AND WHEELS

If you have a flat tire, see “Flat tire” (P.6-2).

TIRE INFLATION PRESSURE

Periodically check the pressure of the tires. An incorrect tire pressure may adversely affect tire life and vehicle handling. The tire pressure should be checked when tires are COLD. Tires are considered COLD after the vehicle has been parked for 3 or more hours, or driven less than 1.6 km (1 mile). COLD tire pressures are shown on the tire placard. (See “Vehicle identification” (P.9-6) for the location of the tire placard.)

Insufficient pressure can lead to an overheating of the tire and subsequent internal damage. At high speeds, this could result in tread separation and even bursting of the tire.

TYPES OF TIRES



CAUTION:

When changing or replacing tires, be sure all four tires are of the same type (that is, summer, all season or snow) and construction. A NISSAN dealer may be able to help you with information about tire type, size, speed rating and availability.

Replacement tires may have a lower speed rating than the factory equipped tires, and they may not match the potential maximum vehicle speed. Never exceed the maximum speed rating of the tire.

All season tires

NISSAN specifies all season tires on some models to provide good performance all year, including snowy and icy road conditions. All season tires are identified by ALL SEASON and/or M&S on the tire sidewall. Snow tires have better snow traction than all season tires and may be more appropriate in some areas.

Summer tires

NISSAN specifies summer tires on some models to provide superior performance on dry roads. Summer tire performance is substantially reduced in snow and ice. Summer tires do not have the tire traction rating M&S on the tire sidewall.

If you plan to operate your vehicle in snowy or icy conditions, NISSAN recommends the use of snow or all season tires on all four wheels.

Snow tires

If snow tires are needed, it is necessary to select tires equivalent in size and load rating to the original equipment tires. If you do not, it can adversely affect the safety and handling of your vehicle.

Generally, snow tires have lower speed ratings than factory equipped tires and may not match the potential maximum vehicle speed. Never exceed the maximum speed rating of the tire. If you install snow tires, they must be the same size, brand, construction and tread pattern on all four wheels.

For additional traction on icy roads, studded tires may be used. However, some states and provinces prohibit their use. Check local, state and provincial laws before installing studded tires. Skid and traction capabilities of studded snow tires on wet or dry surfaces may be poorer than that of non-studded snow tires.

TIRE CHAINS

Use of tire chains may be prohibited according to location. Check the local laws before installing tire chains. When installing tire chains, make sure that they are of proper size for the tires on your vehicle and are installed according to the chain manufacturer’s instructions.

Use chain tensioners when recommended by the tire chain manufacturer to ensure a tight fit. Loose end links of the tire chains must be secured or removed to prevent the possibility of whipping action damage to the fenders or underbody. If possible, avoid fully loading your vehicle when using tire chains. In addition, drive at a reduced speed. Otherwise, your vehicle may be damaged and/or vehicle handling and performance may be adversely affected.

Tire chains must be installed only on the front wheels and not on the rear wheels. Never install tire chains on a temporary-use spare tire (TEMPORARY USE (if equipped)). Do not use the chains on dry roads.

TIRE ROTATION

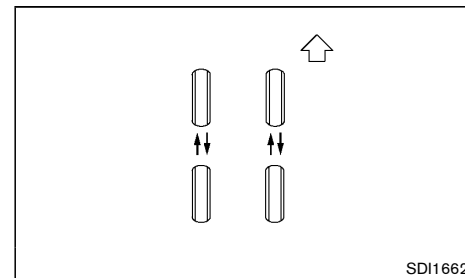

NISSAN recommends that tires be rotated every 10,000 km (6,000 miles). However, the timing for tire rotation may vary according to your driving habits and

the road surface conditions. (See “Flat tire” (P.6-2) for the tire replacement.)



WARNING:

- **After rotating the tires, adjust the tire pressure.**
- **Retighten the wheel nuts when the vehicle has been driven for 1,000 km (600 miles) (also in cases of a flat tire, etc.).**
- **Do not include the temporary-use spare tire (if equipped) in tire rotation.**
- **Incorrect tire selection, fitting, care or maintenance can affect vehicle safety with risk of accident and injury. If in doubt, consult a NISSAN dealer or the tire manufacturer.**

TIRE WEAR AND DAMAGE

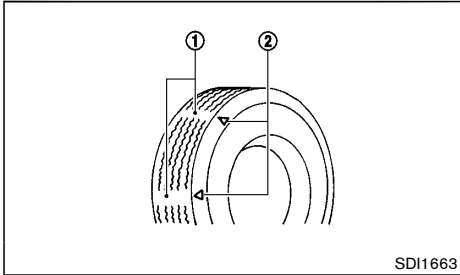

SDI1663

- ① Wear indicator
- ② Wear indicator location marks. The locations are shown by “ Δ ”, “TWI”, etc. depending on tire types.

Tires should be periodically inspected for wear, cracking, bulging or objects caught in the tread. If excessive wear, cracks, bulging or deep cuts are

found, the tire should be replaced immediately.

The original tires have a built-in tread wear indicator. When the wear indicator is visible, the tire should be replaced.

Improper service of a spare tire (if equipped) may result in serious personal injury. If it is necessary to repair the spare tire, contact a NISSAN dealer.

TIRE AGE

Never use a tire over six years old, regardless of whether it has been used or not.

Tires degrade with age as well as with the vehicle usage. Have your tires checked and balanced often by a repair shop or, if you prefer, a NISSAN dealer.

CHANGING TIRES AND WHEELS



WARNING:

Do not install a deformed wheel or tire even if it has been repaired. Such wheels or tires could have structural damage and could fail without warning.

When replacing a tire, use the same size, speed rating and load carrying capacity as originally equipped. (See “Tires and wheels” (P.9-5).) The use of tires other than those recommended or the mixed use of tires of different brands, construction (bias, bias-belted, or radial), or tread patterns can adversely affect the ride, braking, handling, ground clearance, body-to-tire clearance, snow chain clearance, speedometer calibration, headlight aim and bumper height. Some of these effects may lead to accidents and could result in serious personal injury.

If the wheels are changed for any reason, always replace with wheels which have the same offset dimension. Wheels of a different offset could cause

early tire wear, possibly degraded vehicle handling characteristics and/or interference with the brake discs/drums. Such interference can lead to decreased braking efficiency and/or early brake pad/shoe wear.

WHEEL BALANCE

Unbalanced wheels may affect vehicle handling and tire life. Even with regular use, wheels can get out of balance. Therefore, they should be balanced as required.

SPARE TIRE (if equipped)

Temporary-use (T-type) spare tire

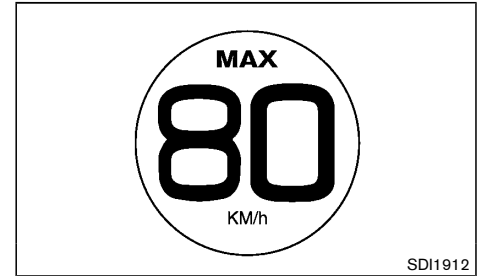

Spare tire label (if equipped)

Observe the following precautions if the T-type spare tire must be used, otherwise your vehicle could be damaged or involved in an accident.



CAUTION:

- **The T-type spare tire should be used only for emergency. It should be replaced by the standard tire at the first opportunity.**
- **Drive carefully while the T-type spare tire is installed.**

- **Avoid sharp turns and abrupt braking while driving.**
- **Periodically check the T-type spare tire inflation pressure, and always keep it at 420 kPa (4.2 bar, 60 psi).**
- **Do not drive your vehicle at speeds faster than 80 km/h (50 MPH).**
- **Do not use tire chains on a T-type spare tire. Tire chains will not fit properly on the T-type spare tire and may cause damage to the vehicle.**
- **When driving on roads covered with snow or ice, the T-type spare tire should be used on the rear wheel and the original tire used on the front wheels (drive wheels). Use tire chains only on the front two original tires.**
- **Tire tread of the T-type spare tire will wear at a faster rate than the original tire. Replace the T-type spare tire as soon as the tread wear indicators appear.**
- **Because the T-type spare tire is smaller than the original tire, ground clearance is reduced. To avoid damage to the vehicle do not drive over obstacles. Also do not drive the vehicle through an automatic car wash since it may get caught.**
- **Do not use the T-type spare tire on other vehicles.**
- **Do not use more than one T-type spare tire at the same time.**

EMERGENCY TIRE PUNCTURE REPAIR KIT (if equipped)

The emergency tire puncture repair kit is supplied to the vehicle instead of a spare tire. The kit must be used for temporarily fixing a minor tire puncture. After using the repair kit, see a NISSAN dealer as soon as possible for tire inspection and repair/replacement.

See "Flat tire" (P.6-2) for more details.

9 Technical information

Recommended fluids/lubricants and capacities	9-2	Vehicle identification	9-6
Fuel information	9-3	Vehicle identification plate	9-6
Recommended SAE viscosity number	9-3	Vehicle Identification Number (VIN)	9-6
Air conditioner system refrigerant and lubricant	9-3	Engine serial number	9-6
Engine	9-4	Tire placard	9-6
Tires and wheels	9-5	Air conditioner specification label	9-7
Dimensions	9-5	Installation of an RF transmitter	9-7
When travelling or registering in another country	9-6	Radio approval number and information	9-7
		For Singapore	9-7
		For Thailand	9-7



RECOMMENDED FLUIDS/ LUBRICANTS AND CAPACITIES

The following are approximate capacities. The actual refill quantities may be slightly different. When refilling, follow the procedures instructed in the "8. Maintenance and do-it-yourself" section to determine the proper refill capacity.

Fluid type			Capacity (approximate)			Recommended Fluids/Lubricants
			Metric Measure	US Measure	Imperial Measure	
Fuel			41 L	10-7/8 gal	9 gal	See "Fuel information" (P.9-3).
Engine oil Drain and refill * For additional information, see "Changing engine oil and oil filter" (P.8-8).	HR12DE	with oil filter change	3.0 L	3-1/8 qt	2-5/8 qt	<ul style="list-style-type: none"> · Genuine "NISSAN Motor Oil 0W-20 SN" is recommended. · If above motor oil is not available, use "NISSAN Motor Oil" or equivalent that matches the following grade and viscosity. <ul style="list-style-type: none"> – Oil grade: API SM or SN, ILSAC GF-4 or GF-5 – SAE Viscosity: See "Recommended SAE viscosity number" (P.9-3). · Genuine "NISSAN Motor Oil 0W-16 SN" is recommended. · If above motor oil is not available, use "NISSAN Motor Oil" or equivalent that matches the following grade and viscosity. <ul style="list-style-type: none"> – Oil grade: API SM or SN, ILSAC GF-4 or GF-5 – SAE Viscosity: 0W-20
		without oil filter change	2.8 L	3.0 qt	2-1/2 qt	
	HR12DDR	with oil filter change	3.5 L	3-3/4 qt	3-1/8 qt	
		without oil filter change	3.3 L	3-1/2 qt	2-7/8 qt	
Engine coolant (with reservoir tank capacity 0.7 L)	HR12DE		5.8 L	6-1/8 qt	5-1/8 qt	<ul style="list-style-type: none"> · Genuine NISSAN Engine Coolant (blue) or equivalent · Use Genuine NISSAN Engine Coolant or equivalent in its quality, in order to avoid possible aluminum corrosion within the engine cooling system caused by the use of non-genuine engine coolant. Note that any repairs for the incidents within the engine cooling system while using non-genuine engine coolant may not be covered by the warranty even if such incidents occurred during the warranty period.
	HR12DDR		5.2 L	5-1/2 qt	5-1/4 qt	
Continuously Variable Transmission (CVT) fluid			—	—	—	<ul style="list-style-type: none"> · Genuine NISSAN CVT Fluid NS-3 · Use only Genuine NISSAN CVT Fluid NS-3. Using transmission fluid other than Genuine NISSAN CVT Fluid NS-3 will damage the CVT, which is not covered by the warranty.
Brake fluid			Refill to the proper fluid level according to the instructions in the "8. Maintenance and do-it-yourself" section.			<ul style="list-style-type: none"> · Genuine NISSAN Brake Fluid or equivalent DOT 3
Multi-purpose grease			—	—	—	<ul style="list-style-type: none"> · NLGI No. 2 (Lithium soap base)
Air conditioner system refrigerant			—	—	—	<ul style="list-style-type: none"> · HFC-134a (R-134a)
Air conditioner system lubricants			—	—	—	<ul style="list-style-type: none"> · NISSAN A/C System Oil Type R or equivalent

FUEL INFORMATION

Gasoline engine (model with three-way catalyst)



CAUTION:

Do not use leaded gasoline. Using leaded gasoline will damage the three-way catalyst.

Except for Thailand:

Use UNLEADED REGULAR gasoline with an octane rating of at least 91 (RON).

For Thailand:

Use UNLEADED REGULAR gasoline or gasohol (up to E20*) with an octane rating of at least 91 (RON).

*: Gasohol is alcohol blended gasoline. For example, "E20" is a mixture of approximately 20% fuel ethanol and 80% unleaded gasoline.

RECOMMENDED SAE VISCOSITY NUMBER

Gasoline engine oil

HR12DE engine models:

0W-20 is preferable.

If 0W-20 is not available, select the viscosity, from the chart below, that is suitable for the outside temperature range.

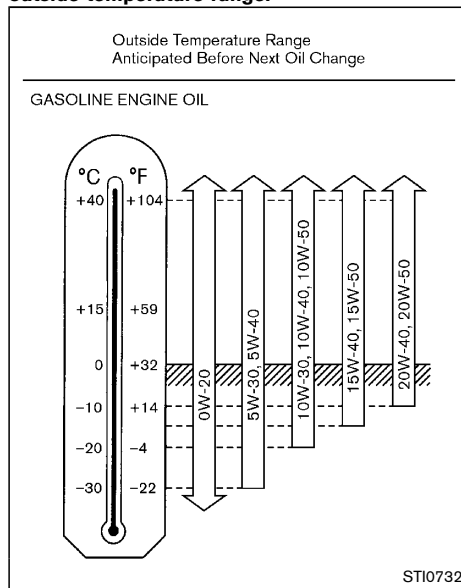

AIR CONDITIONER SYSTEM REFRIGERANT AND LUBRICANT

The air conditioner system of your vehicle must be charged with the refrigerant HFC-134a (R134a) and the lubricant NISSAN A/C System Oil Type R or equivalents. Use of any other refrigerants or lubricants will cause severe damage, and you may need to replace your vehicle's entire air conditioner system.

The release of refrigerants into the atmosphere is prohibited in many countries and regions. The refrigerant HFC-134a (R-134a) in your vehicle will not harm the Earth's ozone layer. However, it may contribute in a small part to the global warming effect. NISSAN recommends that the refrigerant be appropriately recovered and recycled. Contact a NISSAN dealer when servicing the air conditioner system.

ENGINE

Engine Model		HR12DE	HR12DDR
Type		Gasoline, 4-cycle, DOHC	Gasoline, 4-cycle, DOHC
Cylinder arrangement		3-cylinder, in-line	3-cylinder, in-line
Bore × Stroke	mm (in)	78.0 × 83.6 (3.071 × 3.291)	78.0 × 83.6 (3.071 × 3.291)
Displacement	cm ³ (cu in)	1,198 (73.10)	1,198 (73.10)
Idle speed at the "N" (Neutral) position	rpm	750±50	780±50
Ignition timing (B.T.D.C.)		9°±2	11°±2
Spark plugs			
	Type	DILKAR6A11*1 FXE20HR11*2	DILKAR7E11HS
	Standard		
	Spark plug gap	mm (in)	1.1 (0.043)
Camshaft operation		Timing chain	Timing chain

*1: Except for Thailand

*2: For Thailand

TIRES AND WHEELS

Standard		Spare*1	
Tire size	185/65R15 88H	T125/70 D15 95M*2	
Size		Offset mm (in)	
Road wheel	Steel	15 × 5-1/2J	40 (1.57)
	Aluminum	15 × 5-1/2J	40 (1.57)
Spare	Steel	15 × 4T*2	40 (1.57)

*1: For model without the spare tire, an emergency tire puncture repair kit is supplied.

*2: Temporary use only

DIMENSIONS

Unit: mm (in)	
Overall length	4,100 (161.4)*1
	4,105 (161.6)*2
Overall width	1,695 (66.7)
Overall height	1,525 (60.0)*1
	1,535 (60.4)*2
Front tread	1,480 (58.3)
Rear tread	1,485 (58.5)
Wheelbase	2,600 (102.4)

*1: Except for Thailand

*2: For Thailand

WHEN TRAVELLING OR REGISTERING IN ANOTHER COUNTRY

When planning to travel in another country or region, find out whether the fuel required for your vehicle is available in that country or region. Using a low octane rated fuel may cause engine damage. Therefore, be sure that the required fuel is available wherever you go. For additional information regarding recommended fuel, see "Fuel information" (P.9-3).

When transferring the registration of your vehicle to another country, state, province or district, contact the appropriate authorities to find out that the vehicle complies with the local legal requirements. In some cases, a vehicle cannot meet the legal requirements, and it may be necessary to modify the vehicle to meet local laws and regulations. In addition, there may be possibilities that a vehicle cannot be adapted in certain areas.

The laws and regulations for motor vehicle emission control and safety standards vary according to the country, state, province or district; therefore, the vehicle specification may differ.

When any vehicles are to be taken into another country, state, province or district, its modification, transportation, registration, and any other expenses which may result, are the responsibility of the user. NISSAN is not responsible for any inconveniences that may result.

VEHICLE IDENTIFICATION

It is prohibited to cover, paint, weld, cut, drill, alter or remove Vehicle Identification Number (VIN).

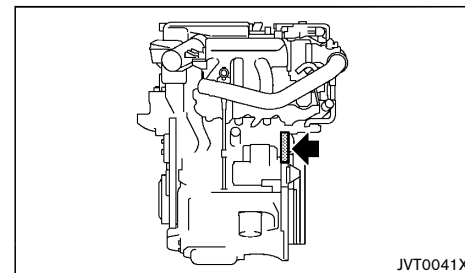
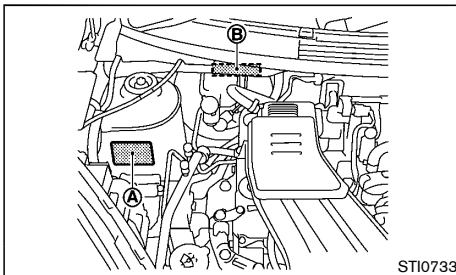

HR12DDR engine

TIRE PLACARD

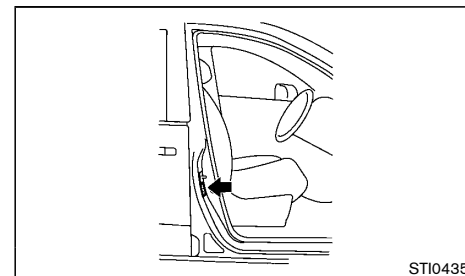

The cold tire pressures are shown on the tire placard affixed to the driver's side center pillar.

VEHICLE IDENTIFICATION PLATE

The vehicle identification plate is affixed as shown (A).

VEHICLE IDENTIFICATION NUMBER (VIN)

The vehicle identification number is stamped as shown (B).

ENGINE SERIAL NUMBER

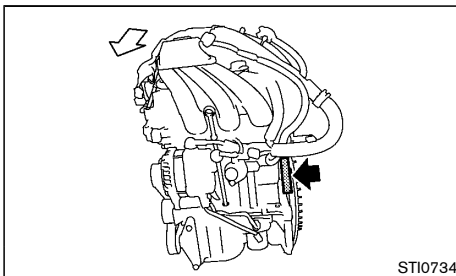

HR12DE engine

AIR CONDITIONER SPECIFICATION LABEL

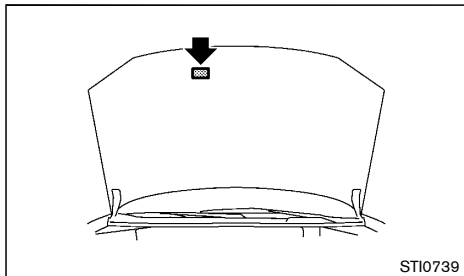

INSTALLATION OF AN RF TRANSMITTER

For countries conforming to UN regulation No.10 or equivalent:

The installation of an RF transmitter in your vehicle could affect electric equipment systems. Be sure to check with your NISSAN dealer for precautionary measures or special instructions regarding installation. Upon request, your NISSAN dealer will provide the detailed information (frequency band, power, antenna position, installation guide, etc.) regarding installation.

RADIO APPROVAL NUMBER AND INFORMATION

FOR SINGAPORE

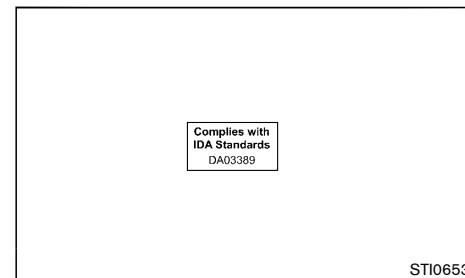

- NISSAN Anti-Theft System (NATS) immobilizer
- Intelligent Key system
- Body Control Module (BCM)

FOR THAILAND

This telecommunication equipment conforms to NTC technical requirement.

- Intelligent Key system
- NISSAN Anti-Theft System (NATS)

MEMO

10 Index

A

Adjusting time.....	2-25
Aiming control, Headlights.....	2-20
Air bag system	
Air bag warning labels.....	1-25
Supplemental front-impact air bag system.....	1-23, 1-27
Air cleaner filter.....	8-13
Air conditioner	
Air conditioner specification label.....	9-7
Air conditioner system refrigerant and lubricant.....	9-3
Automatic air conditioner.....	4-12
Manual air conditioner.....	4-10
Air conditioner filter.....	4-13
Aluminum alloy wheels.....	7-3
Antenna.....	4-19
Anti-lock Braking System (ABS).....	5-24
Anti-lock braking system (ABS) warning light....	2-13
Appearance care	
Exterior appearance care.....	7-2
Interior appearance care.....	7-3
Around View Monitor.....	4-2
Audible reminders.....	2-17
Audio operation precautions.....	4-14
Audio system.....	4-14

B

Battery.....	8-3, 8-17
Intelligent Key.....	8-18
Intelligent Key battery discharge.....	5-6
Keyfob battery replacement.....	8-18
Vehicle battery.....	8-17
Battery replacement	
Intelligent Key.....	8-18
Battery saver system.....	2-19, 2-28
Before starting engine.....	5-2
Belts (See drive belts).....	8-10

Blocking wheels.....	6-3
Brake	
Brake booster.....	8-12
Brake fluid.....	8-12
Brake precautions.....	5-24
Brake system.....	5-24
Brakes.....	8-11
Checking foot brake pedal.....	8-11
Checking parking brake.....	8-11
Parking brake.....	3-17, 5-26
Warning light.....	2-13
Brake assist.....	5-24
Brake precautions.....	5-24
Brakes.....	8-11
Break-in schedule.....	5-2
Bulb replacement.....	8-2, 8-21

C

Car phone or CB radio.....	4-26
Card holder.....	2-27
Care when driving.....	5-4
Catalytic converter, Three way catalyst.....	5-3
CD player/Radio.....	4-20
Center and Side ventilators.....	4-8
Changing	
Changing engine coolant.....	8-7
Changing engine oil and oil filter.....	8-8
Changing tires and wheels.....	8-27
Checking	
Checking engine coolant level.....	8-7
Checking engine oil level.....	8-7
Checking foot brake pedal.....	8-11
Checking lights.....	2-13
Checking parking brake.....	8-11
Child restraint anchorage.....	1-17
Child restraint installation using ISOFIX.....	1-18
Child restraints.....	1-12
Child safety.....	1-8
Child safety rear door lock.....	3-4

Chimes, Audible reminders.....	2-17
Chrome parts.....	7-3
Circuit breaker, Fusible link.....	8-19
Cleaning exterior and interior.....	7-2, 7-3
Clock.....	2-25
Closing hood.....	3-13
Cockpit.....	2-2
Cold weather driving.....	5-26
Continuously Variable Transmission (CVT) fluid.....	8-13
Continuously Variable Transmission position indicator.....	2-9
Coolant	
Changing engine coolant.....	8-7
Checking engine coolant level.....	8-7
High temperature warning light.....	2-14
Corrosion protection.....	7-5
Cup holders.....	2-27

D

Defogger switch.....	2-22
Dimensions.....	9-5
Door open warning light.....	2-14
Doors.....	3-3
Drive belts.....	8-10
Driving	
Care when driving.....	5-4
Cold weather driving.....	5-26
Driving in wet conditions.....	5-4
Driving in winter conditions.....	5-4
Driving with Continuously Variable Transmission (CVT).....	5-7
Precautions when starting and driving.....	5-2
Driving vehicle.....	5-7

E

ECO mode system.....	5-20
Economy, Fuel.....	5-21

Electric power steering	5-23
Electric power steering warning light.....	2-14
Emergency tire puncture repair kit.....	6-5, 8-28
Engine	
Before starting engine.....	5-2
Break-in schedule.....	5-2
Changing engine coolant	8-7
Changing engine oil and oil filter	8-8
Checking engine coolant level.....	8-7
Checking engine oil level	8-7
Engine compartment check locations	8-5
Engine cooling system	8-6
Engine oil	8-7
Engine serial number.....	9-6
Engine specifications.....	9-4
High temperature warning light	2-14
If your vehicle overheats	6-10
Spark plugs.....	8-11
Engine cold start period	5-4
Engine coolant temperature gauge	2-9
Engine start operation indicator light	2-16
Exhaust gas (carbon monoxide)	5-3
Explanation of general maintenance items.....	8-2
Extended storage fuse switch	8-20
Exterior lights	8-21

F

Flat tire	6-2
Floor mats.....	7-4
Fluid	
Brake fluid	8-12
Continuously Variable Transmission (CVT) fluid	8-13
Engine coolant	8-6
Engine oil	8-7
Window washer fluid.....	8-4, 8-15
Fog light switch	2-20
Forward emergency braking system	5-17
Forward emergency braking system off indicator light	2-16

Forward emergency braking system warning light	2-14
Front seats	1-2
Fuel	
Fuel economy	5-21
Fuel gauge	2-9
Fuel information.....	9-3
Fuel octane rating	9-3
Fuel-filler cap.....	3-15
Fuel-filler lid.....	3-15
Opening fuel-filler lid	3-15
Recommended fuel/lubricants and capacities	9-2
Fuel Efficiency and Carbon Dioxide Reduction driving tips	5-21
Fuel-filler cap	3-15
Fuel-filler lid.....	3-15
Fuses	8-19
Fusible links	8-19

G

Gauge	
Fuel gauge	2-9
Odometer	2-6
Speedometer	2-6
Tachometer.....	2-8
General maintenance	8-2
Glove box	2-26

H

Hazard indicator and outside chime.....	3-10
Hazard indicator flasher switch	6-2
Head restraints.....	1-4
Headlight	
Headlight and turn signal switch.....	2-18
Headlights	
Aiming control	2-20
Bulb replacement	8-21
Headlight switch	2-18

Heater and air conditioner	4-9
High temperature warning light	2-14
Hill start assist system	5-14
Hood release	3-12
Horn	2-23

I

Idling Stop OFF switch.....	5-12
Idling Stop System.....	5-10
Ignition switch positions	5-5
Indicator lights	2-16
Injured persons	1-9
Inside rearview mirror	3-16
Installing spare tire	6-4
Instrument brightness control.....	2-10
Instrument panel	2-3
Intelligent Key	3-2
Intelligent Key battery.....	8-18
Intelligent Key battery discharge	5-6
Intelligent Key system.....	3-4, 5-4
Intelligent Key system warning light	2-14
Interior lights	2-28, 8-22
ISOFIX child restraint system.....	1-17

J

Jump starting	6-8
---------------------	-----

K

Key	
Ignition switch positions	5-5
Intelligent Key battery	8-18
Intelligent Key battery discharge	5-6
Intelligent Key system.....	3-4, 5-4
Keys	3-2
Locking with key	3-3
Mechanical key.....	3-2
Push-button ignition switch	5-4
Using Intelligent Key system.....	3-6

Using remote keyless entry system 3-10

L

Labels

Air conditioner specification label 9-7

Engine serial number 9-6

Vehicle identification number 9-6

Lane Departure Warning (LDW) system 5-14

Lane Departure Warning (LDW) warning light 2-15

Light

Bulb replacement 8-2, 8-21

Exterior lights 8-21

Fog light switch 2-20

Headlight and turn signal switch 2-18

Headlight switch 2-18

Headlights 8-21

Indicator lights 2-16

Interior lights 2-28, 8-22

Light locations 8-23

Replacement 8-2, 8-21

Room light 2-28

Warning lights 2-13

Lock

Anti-lock Braking System (ABS) 5-24

Child safety rear door lock 3-4

Doors 3-3

Locking with inside lock knob 3-3

Locking with key 3-3

Locking with power door lock switch 3-4

Steering lock 5-5

M

Maintenance

Battery 8-3, 8-17

Explanation of general maintenance items 8-2

General maintenance 8-2

Maintenance precautions 8-4

Maintenance requirements 8-2

Scheduled maintenance 8-2

Seat belt maintenance 1-11

Malfunction indicator light (MIL) 2-16

Manual air conditioner 4-10

Map light 2-28

Mechanical key 3-2

Meters and gauges 2-4

Mirror

Inside rearview mirror 3-16

Mirrors 3-16

Outside rearview mirrors 3-16

Moving Object Detection (MOD) function 4-6

Multi-sensing front camera

unit maintenance 5-16, 5-20

N

New vehicle break-in 5-2

NISSAN Anti-Theft System (NATS) 3-12

O

Odometer 2-6

Oil

Changing engine oil and oil filter 8-8

Checking engine oil level 8-7

Engine oil 8-7

Opening fuel-filler lid 3-15

Opening hood 3-13

Outside rearview mirrors 3-16

Overheat, If your vehicle overheats 6-10

P

Parking

Parking brake 3-17

Parking, Parking brake 5-26

Passenger compartment 8-20

Phone

Car phone or CB radio 4-26

Power

Electric power steering 5-23

Locking with power door lock switch 3-4

Power outlet 2-26

Power windows 2-23

Precautions

Audio operation 4-14

Brake precautions 5-24

Maintenance 8-4

Precautions on child restraint usage 1-12

Precautions on push-button ignition

switch operation 5-4

Precautions on Supplemental Restraint

System (SRS) 1-23

Precautions when starting and driving 5-2

Safety precautions 4-2

Seat belt usage 1-6

Towing precautions 6-11

Precautions on push-button ignition

switch operation 5-4

Pregnant women 1-9

Preparing tools 6-2

Pre-tensioner seat belt system 1-24, 1-28

Push starting 6-10

Push-button ignition switch 5-4

R

Radio 4-14

Car phone or CB radio 4-26

Radio with Compact Disc (CD) player 4-20

Rear hatch 3-13

Rear seats 1-3

Rear window wiper and washer switch 2-21

Recommended fuel/lubricants and capacities 9-2

Recommended SAE viscosity number 9-3

Removing spots 7-2

Removing tire 6-3

Repair and replacement procedure 1-29

Room light 2-28

S

Safety	
Child safety	1-8
Child safety rear door lock	3-4
Safety precautions	4-2
Scheduled maintenance	8-2
Seat	
Front seats	1-2
Precautions on seat belt usage	1-6
Seat belts	1-6, 7-4
Seats	1-2
Three-point type seat belts	1-9
Seat belt warning light	2-15
Seat belt(s)	
Child safety	1-8
Cleaning	7-4
Injured persons	1-9
Precautions on seat belt usage	1-6
Pregnant women	1-9
Pre-tensioner seat belt system	1-24, 1-28
Seat belt maintenance	1-11
Shoulder belt height adjustment	1-9
Security system	3-12
Servicing air conditioner	4-13
Shift lever	
Shift lock release	5-9
Shift lock release	
Transmission	5-9
Shoulder belt height adjustment	1-9
Soft bottle holder	2-27
Spare tire	8-27
Spark plugs	8-11
Speedometer	2-6
SRS air bag warning light	1-25
Starting	
Before starting engine	5-2
Jump starting	6-8
Precautions when starting and driving	5-2
Push starting	6-10
Starting engine	5-7

Steering	
Electric power steering	5-23
Steering lock	5-5
Steering wheel	3-15
Steering wheel switch	4-25
Stopping vehicle	6-2
Storage	2-26
Stowing damaged tire and tools	6-5
Sun visors	2-28
Supplemental air bag systems	1-26
Supplemental front-impact air bag system	1-23, 1-27
Supplemental Restraint System (SRS)	1-23
Switch	
Defogger switch	2-22
Fog light switch	2-20
Hazard indicator flasher switch	6-2
Headlight aiming control	2-20
Headlight and turn signal switch	2-18
Headlight switch	2-18
Power door lock switch	3-4
Steering wheel switch	4-25
Turn signal switch	2-20
Wiper and washer switch	2-21

T

Tachometer	2-8
Three-point type seat belts	1-9
Three-way catalyst	5-3
Tire	
Changing tires and wheels	8-27
Installing tire	6-4
Preparing tools	6-2
Removing tire	6-3
Spare tire	8-27
Stowing damaged tire and tools	6-5
Tire age	8-27
Tire equipment	5-26
Tire inflation pressure	8-26
Tire placard	9-6
Tire wear and damage	8-27

Tires and wheels	8-26, 9-5
Tires	
Flat tire	6-2
Tire chains	8-26
Tire rotation	8-3, 8-26
Types of tires	8-26
Towing	
Towing precautions	6-11
Towing recommended by NISSAN	6-11
Towing your vehicle	6-11
Trailer towing	5-23
Transmission	
Continuously Variable Transmission (CVT) fluid	8-13
Driving with Continuously Variable Transmission (CVT)	5-7
Transmission shift lever lock release	5-9
Trip computer	2-7
Troubleshooting guide	3-9
Turn signal switch	2-20
Types of tires	8-26

U

Underbody cleaning	7-3
Upper instrument box	2-27
USB memory device operation	4-23
Using Intelligent Key system	3-6
Using remote keyless entry system	3-10

V

Vehicle	
Dimensions	9-5
Identification number	9-6
Vehicle battery	8-17
Vehicle Dynamic Control (VDC) OFF switch	5-13
Vehicle Dynamic Control (VDC) system	5-12
Vehicle dynamic control (VDC) warning light	2-15
Vehicle information display	2-6
Vehicle security	5-25

Ventilators 4-8

W

Warning

Lights 2-13

Warning and audible reminders 3-8

Warning lights 2-13

Warning lights, indicator lights and
audible reminders 2-12

Washer switch

Rear window wiper and washer switch 2-21

Windshield wiper and washer switch 2-21

Washing 7-2

Waxing 7-2

Wheels and tires, Care of wheels 7-3

When travelling or registering in

another country 9-6

Where to go for service 8-2

Window washer fluid 8-4, 8-15

Window(s)

Cleaning 7-2, 7-4

Power windows 2-23

Windows 2-23

Windshield wiper and washer switch 2-21

Wiper

Rear window wiper and washer switch 2-21

Windshield wiper and washer switch 2-21

Wiper and washer switch 2-21

Wiper blades 8-14

GAS STATION INFORMATION

FUEL INFORMATION

Gasoline engine (Model with three-way catalyst)



CAUTION:

Do not use leaded gasoline. Using leaded gasoline will damage the three-way catalyst.

Except for Thailand:

Use UNLEADED REGULAR gasoline with an octane rating of at least 91 (RON).

For Thailand:

Use UNLEADED REGULAR gasoline or gasohol (up to E20*) with an octane rating of at least 91 (RON).

*: Gasohol is alcohol blended gasoline. For example, "E20" is a mixture of approximately 20% fuel ethanol and 80% unleaded gasoline.

RECOMMENDED ENGINE OIL

See "Recommended fluids/lubricants and capacities" (P.9-2).

TIRE COLD PRESSURE

See the tire placard affixed to the driver's side center pillar.

QUICK REFERENCE

- In case of emergency ... (P.6-1)
(Flat tire, engine will not start, overheating, towing)
- How to start the engine ... (P.5-1)
- How to read the meters and gauges ... (P.2-1)
- Maintenance and do-it-yourself ... (P.8-1)
- Technical information ... (P.9-1)