

# Foreword

Welcome to the growing family of new NISSAN owners. This vehicle has been delivered to you with confidence. It has been produced using the latest techniques and strict quality control.

This manual was prepared to help you understand the operation and maintenance of your vehicle so that you may enjoy many kilometers (miles) of driving pleasure. Please read through this manual before operating your vehicle.

A separate Warranty Information & Maintenance Booklet explains details about the warranties covering your vehicle.

Your NISSAN dealer knows your vehicle best. When you require any service or have any questions, we will be glad to assist you with the extensive resources available for you.

## IMPORTANT SAFETY INFORMATION

### Reminders for safety!

Follow these important driving rules to help ensure a safe and complete trip for you and your passengers!

- **NEVER drive under the influence of alcohol or drugs.**
- **ALWAYS observe posted speed limits and never drive too fast for conditions.**
- **ALWAYS use your seat belts and appropriate child restraint systems. Preteen children should be seated in the rear seat.**
- **ALWAYS provide information about the proper use of vehicle safety features to all occupants of the vehicle.**
- **ALWAYS review this Owner's Manual for important safety information.**

## When reading the manual

This manual includes information for all options available on this model. Therefore, you may find some information that does not apply to your vehicle.

All information, specifications and illustrations in this manual are those in effect at the time of printing. NISSAN reserves the right to change specifications or designs without notice and without obligation.

## MODIFICATION OF YOUR VEHICLE

This vehicle should not be modified. Modification could affect its performance, safety or durability, and may even violate governmental regulations. In addition, damage or performance problems resulting from modifications may not be covered under NISSAN warranties.

## Read first — then drive safely

Before driving your vehicle, read this Owner's Manual carefully. This will ensure familiarity with controls and maintenance requirements, assisting you in the safe operation of your vehicle.

Throughout this manual we have used the symbol  followed by the word **WARNING**. This is used to indicate the presence of a hazard that could cause death or serious personal injury. To avoid or reduce the risk, the procedures must be followed precisely.

The symbol  followed by the word **CAUTION** is also used throughout this manual to indicate the presence of a hazard that could cause minor or moderate personal injury or damages to your vehicle. To avoid or reduce the risk, the procedures must be followed carefully.

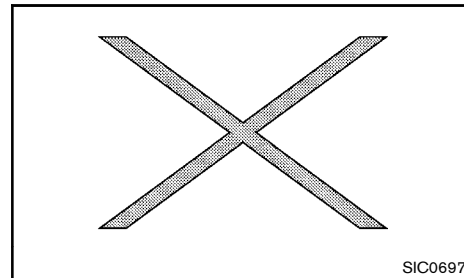

If you see this symbol, it means **“Do not do this”** or **“Do not let this happen”**.



If you see a symbol similar to these in an illustration, it means the arrow points to the front of the vehicle.



Arrows in an illustration that are similar to these indicate movement or action.



Arrows in an illustration that are similar to these call attention to an item in the illustration.



Bluetooth® is a trademark owned by Bluetooth SIG, Inc. and licensed to Clarion Co., Ltd. and Daewoo IS Corp.

© 2013 NISSAN MOTOR CO., LTD.



# Table of Contents

<b>Illustrated table of contents</b>	<b>0</b>
<b>Safety — seats, seat belts and supplemental restraint system</b>	<b>1</b>
<b>Instruments and controls</b>	<b>2</b>
<b>Pre-driving checks and adjustments</b>	<b>3</b>
<b>Monitor, Heater and air conditioner, and audio system</b>	<b>4</b>
<b>Starting and driving</b>	<b>5</b>
<b>In case of emergency</b>	<b>6</b>
<b>Appearance and care</b>	<b>7</b>
<b>Maintenance and do-it-yourself</b>	<b>8</b>
<b>Technical information</b>	<b>9</b>
<b>Index</b>	<b>10</b>



# 0 Illustrated table of contents

Seats, seat belts and supplemental restraint system (SRS) .....	0-2	Right-Hand Drive (RHD) model (Type C) .....	0-11
Exterior front .....	0-3	Meters and gauges .....	0-12
Exterior rear .....	0-5	Engine compartment .....	0-15
Passenger compartment .....	0-7	HR12DDR engine model .....	0-15
Instrument panel .....	0-8	HR12DE engine model .....	0-16
Left-Hand Drive (LHD) model .....	0-8	HR15DE engine model .....	0-17
Right-Hand Drive (RHD) model (Type A) .....	0-9	K9K engine model .....	0-18
Right-Hand Drive (RHD) model (Type B) .....	0-10		

# SEATS, SEAT BELTS AND SUPPLEMENTAL RESTRAINT SYSTEM (SRS)

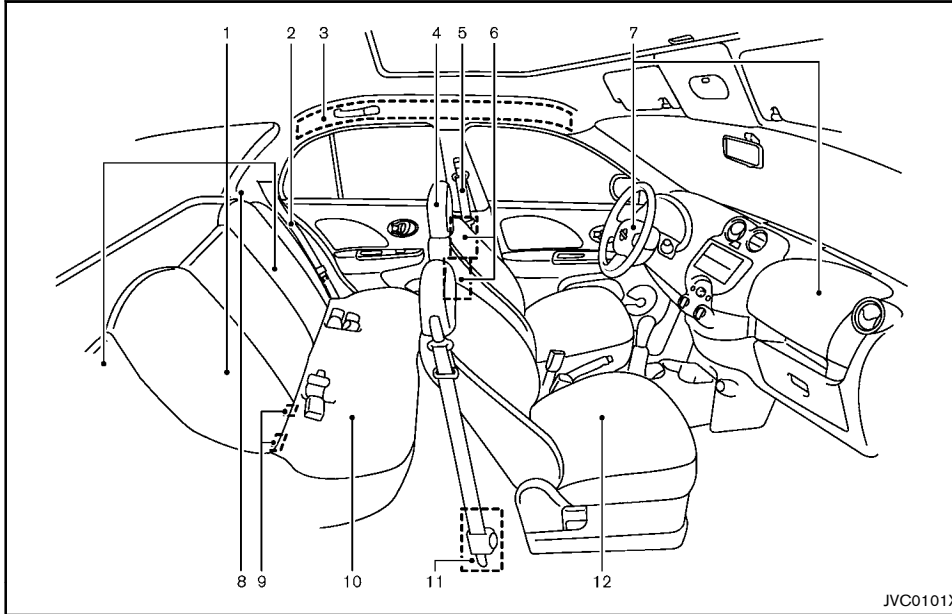

JVC0101X

- |   |   |
|---|---|
| <ol style="list-style-type: none"> <li>1. Child restraint anchor point (for top tether strap child restraint)* (Page 1-18)</li> <li>2. Rear seat belts (P.1-7)</li> <li>3. Supplemental curtain side-impact air bags* (P.1-25)</li> <li>4. Head restraints (P.1-5)</li> <li>5. Front seat belts (P.1-7)</li> <li>6. Supplemental side-impact air bags* (P.1-25)</li> <li>7. Supplemental front-impact air bags* (P.1-25)</li> <li>8. Rear center seat belts (for three-point type seat belts)* (P.1-7)</li> </ol> | <ol style="list-style-type: none"> <li>9. ISOFIX child restraint system* (P.1-17)</li> <li>10. Rear seats (P.1-4)<br/>— Child restraints (P.1-13)</li> <li>11. Pre-tensioner seat belt system* (P.1-31)</li> <li>12. Front seats (P.1-2)</li> </ol> <p>*: if equipped</p> |
|---|---|

## EXTERIOR FRONT

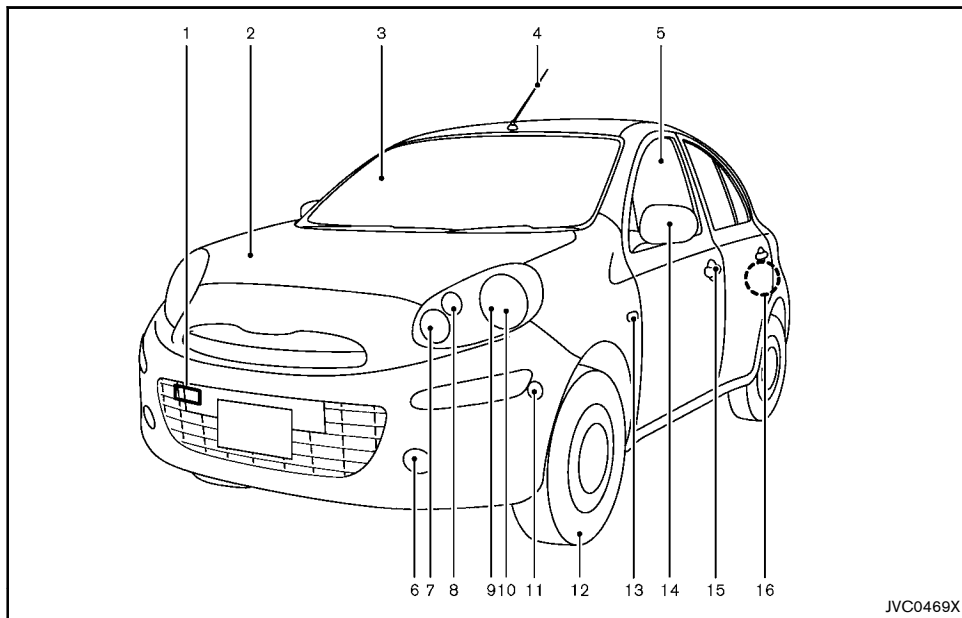

### Type A

- |  |   |   |
|--|---|---|
| <ol style="list-style-type: none"> <li>1. Recovery hook (P.6-13)</li> <li>2. Engine hood (P.3-19)</li> <li>3. Windshield               <ul style="list-style-type: none"> <li>— Wiper and washer switch (P.2-37)</li> <li>— Wiper replacement (P.8-21)</li> <li>— Washer fluid (P.8-23)</li> </ul> </li> <li>4. Antenna* (P.4-19)</li> <li>5. Windows (P.2-40)</li> <li>6. Fog lights*               <ul style="list-style-type: none"> <li>— Switch operation (P.2-36)</li> </ul> </li> </ol> | <ol style="list-style-type: none"> <li>7. Front turn signal lights               <ul style="list-style-type: none"> <li>— Bulb replacement (P.8-29)</li> <li>— Switch operation (P.2-35)</li> <li>— Bulb replacement (P.8-30)</li> </ul> </li> <li>8. Clearance lights (for Micra Active)               <ul style="list-style-type: none"> <li>— Switch operation (P.2-33)</li> <li>— Bulb replacement (P.8-29)</li> </ul> </li> <li>9. Clearance lights (except for Micra Active)               <ul style="list-style-type: none"> <li>— Switch operation (P.2-33)</li> <li>— Bulb replacement (P.8-29)</li> </ul> </li> </ol> | <ol style="list-style-type: none"> <li>10. Headlights               <ul style="list-style-type: none"> <li>— Switch operation (P.2-33)</li> <li>— Bulb replacement (P.8-29)</li> </ul> </li> <li>11. Parking space measurement sensors* (P.5-34)</li> <li>12. Tires               <ul style="list-style-type: none"> <li>— Tires and wheels (P.8-42, P.9-8)</li> <li>— Flat tire (P.6-2)</li> </ul> </li> <li>13. Side turn signal lights               <ul style="list-style-type: none"> <li>— Switch operation (P.2-35)</li> <li>— Bulb replacement (P.8-30)</li> </ul> </li> <li>14. Outside rearview mirrors (P.3-22)</li> <li>15. Doors               <ul style="list-style-type: none"> <li>— Keys (P.3-2)</li> <li>— Door locks (P.3-5)</li> <li>— Intelligent Key system* (P.3-9)</li> <li>— Remote keyless entry system* (P.3-7)</li> <li>— Security system* (P.3-17)</li> </ul> </li> <li>16. Child safety rear door lock (P.3-7)</li> </ol> |
|--|---|---|

\*: if equipped



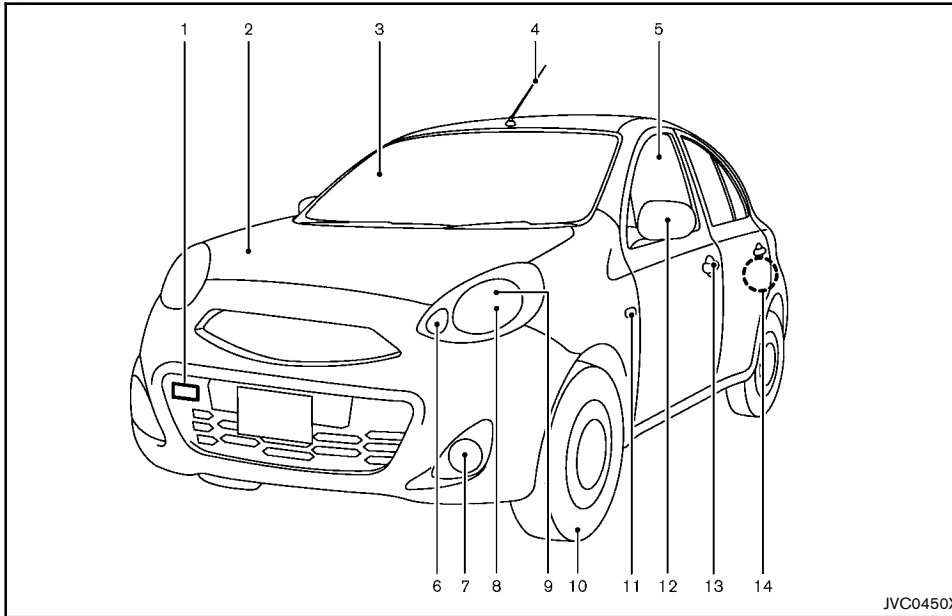

JVC0450X

**Type B**

- |  |   |
|--|---|
| <ol style="list-style-type: none"> <li>1. Recovery hook (P.6-13)</li> <li>2. Engine hood (P.3-19)</li> <li>3. Windshield <ul style="list-style-type: none"> <li>— Wiper and washer switch (P.2-37)</li> <li>— Wiper replacement (P.8-21)</li> <li>— Washer fluid (P.8-23)</li> </ul> </li> <li>4. Antenna (P.4-19)</li> <li>5. Windows (P.2-40)</li> <li>6. Front turn signal lights <ul style="list-style-type: none"> <li>— Switch operation (P.2-35)</li> </ul> </li> </ol> | <ol style="list-style-type: none"> <li>7. Fog lights* <ul style="list-style-type: none"> <li>— Bulb replacement (P.8-30)</li> </ul> </li> <li>8. Clearance lights <ul style="list-style-type: none"> <li>— Switch operation (P.2-33)</li> <li>— Bulb replacement (P.8-29)</li> </ul> </li> <li>9. Headlights <ul style="list-style-type: none"> <li>— Switch operation (P.2-33)</li> <li>— Bulb replacement (P.8-29)</li> </ul> </li> </ol> |
|--|---|

10. Tires
    - Tires and wheels (P.8-42, P.9-8)
    - Flat tire (P.6-2)
  11. Side turn signal lights
    - Switch operation (P.2-35)
    - Bulb replacement (P.8-30)
  12. Outside rearview mirrors (P.3-22)
  13. Doors
    - Keys (P.3-2)
    - Door locks (P.3-5)
    - Intelligent Key system\* (P.3-9)
    - Remote keyless entry system\* (P.3-7)
    - Security system\* (P.3-17)
  14. Child safety rear door lock (P.3-7)
- \*: if equipped

## EXTERIOR REAR

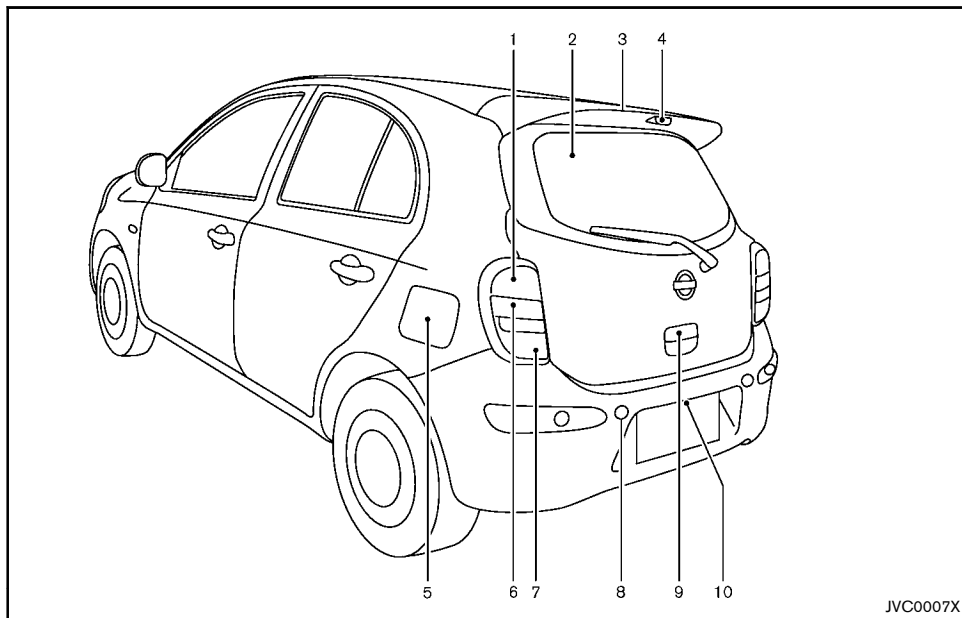

### Type A

- |  |  |
|--|--|
| 1. Stop/tail lights (P.8-30)                                     | — Fuel recommendation (P.9-4)              |
| 2. Rear window   | 6. Turn signal lights                      |
| — Wiper and washer switch* (P.2-38)                              | — Switch operation (P.2-35)                |
| — Rear window defogger* (P.2-39)                                 | — Bulb replacement (P.8-30)                |
| 3. High-mounted stop light (Model without rear spoiler) (P.8-30) | 7. Reverse lights/Rear fog light*          |
| 4. High-mounted stop light (Model with rear spoiler) (P.8-30)    | — Switch operation (P.2-36)                |
| 5. Fuel  | — Bulb replacement (P.8-30)                |
| — Fuel filler lid (P.3-20)                                       | 8. Sonar (parking sensor) system* (P.5-34) |
|  | 9. Back door (P.3-20)                      |
|  | — Back door operation (P.3-20)             |

— Intelligent Key system\* (P.3-9)

— Remote keyless entry system\* (P.3-7)

10. License plate light (P.8-30)

\*: if equipped

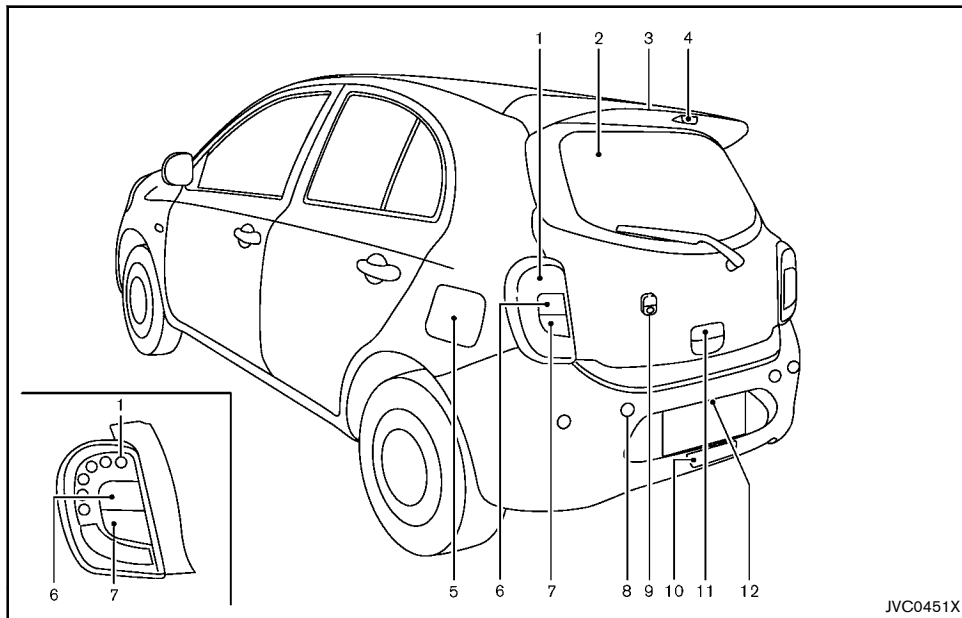

**Type B**

- |  |   |
|--|---|
| 1. Stop/tail lights (P.8-30)                                     | — Fuel recommendation (P.9-4)                     |
| 2. Rear window   | 6. Turn signal lights                             |
| — Wiper and washer switch* (P.2-38)                              | — Switch operation (P.2-35)                       |
| — Rear window defogger* (P.2-39)                                 | — Bulb replacement (P.8-30)                       |
| 3. High-mounted stop light (Model without rear spoiler) (P.8-30) | 7. Reverse lights                                 |
| 4. High-mounted stop light (Model with rear spoiler) (P.8-30)    | — Bulb replacement (P.8-30)                       |
| 5. Fuel  | 8. Sonar (parking sensor) system* (P.5-34)        |
| — Fuel filler lid (P.3-20)                                       | 9. Rearview camera for rearview monitor* (P. 4-2) |
|  | 10. Rear fog light*                               |
|  | — Switch operation (P.2-36)                       |

— Bulb replacement (P.8-30)

11. Back door (P.3-20)

— Back door operation (P.3-20)

— Intelligent Key system\* (P.3-9)

— Remote keyless entry system\* (P.3-7)

12. License plate light (P.8-30)

\*: if equipped

## PASSENGER COMPARTMENT

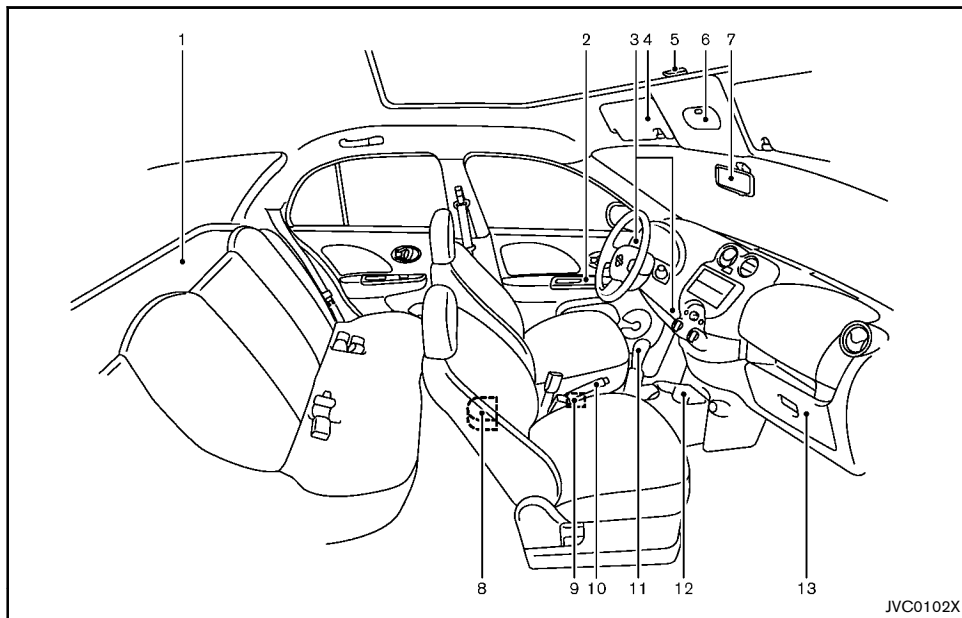

- |   |  |
|---|--|
| <ul style="list-style-type: none"> <li>1. Tonneau board* (P.2-45)</li> <li>2. Door armrest               <ul style="list-style-type: none"> <li>— Power window switch* (P.2-40)</li> <li>— Power door lock switch* (models with power windows) (P.3-6)</li> </ul> </li> <li>3. Fuse box (P.8-28)</li> <li>4. Sun visor (P.2-45)</li> <li>5. Sunshade* (P.2-42)</li> <li>6. Room light (P.2-46, P.8-31)</li> </ul> | <ul style="list-style-type: none"> <li>7. Inside rearview mirror (P.3-21)</li> <li>8. Rear cup holder (P.2-44)</li> <li>9. Center console               <ul style="list-style-type: none"> <li>— Heated seats switch* (P.1-3)</li> <li>— Power door lock switch* (models without power windows) (P.3-6)</li> </ul> </li> <li>10. Parking brake (P.3-24, P.8-18)</li> <li>11. Shift lever               <ul style="list-style-type: none"> <li>— Automatic Transmission (AT) (P.5-11)</li> <li>— Continuously Variable Transmission (CVT) (P.5-14)</li> </ul> </li> </ul> |
|---|--|

— Manual Transmission (MT) (P.5-17)

12. Front cup holder (P.2-44)

13. Glove box (P.2-44)

\*: if equipped

# INSTRUMENT PANEL

## LEFT-HAND DRIVE (LHD) MODEL

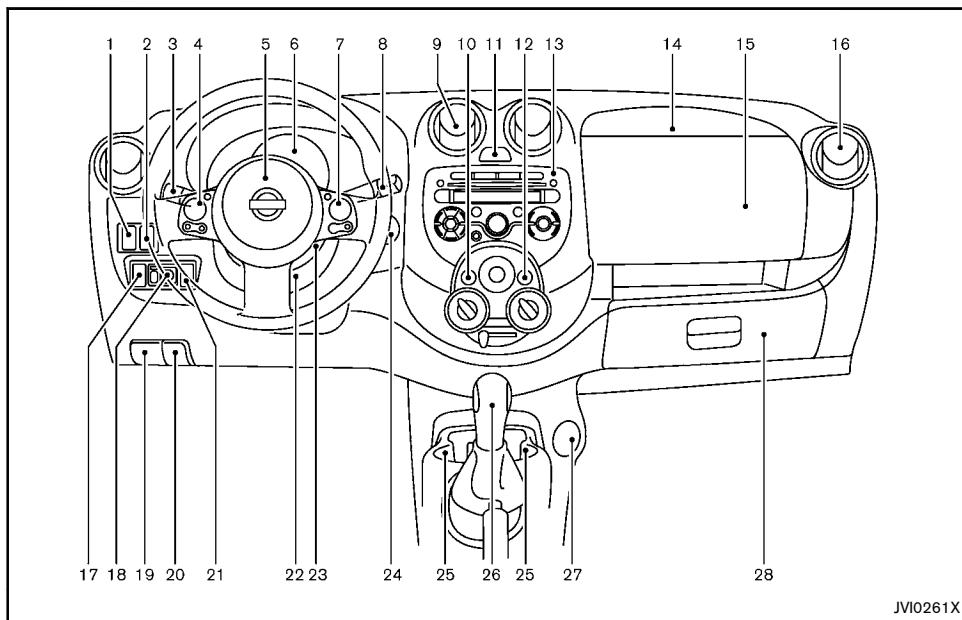

Example

1. Vehicle Dynamic Control (VDC) OFF switch\* (P.5-24) or Electronic Stability Program (ESP) OFF switch\* (P.5-27)
2. Parking space measurement switch\* (P.5-34)
3. Headlight, fog light\* and turn signal switch (P.2-33)
4. Steering-wheel-mounted controls (left side)\*
  - Audio control\* (P.4-63)
  - Bluetooth® Hands-Free Phone System con-

5. Driver's front-impact air bag/Horn (P.1-25, P.2-40)
6. Meters and gauges (P.2-6)
7. Steering-wheel-mounted controls (right side)\*
  - Cruise control switches\* (P.5-30)
  - Speed limiter switches\* (P.5-28)

8. Wiper and washer switch (P.2-37)
9. Center ventilator (P.4-5)
10. Rear window defogger switch\* (P.2-39)
11. Hazard indicator flasher switch (P.6-2)
12. Heater and air conditioner\* control (P.4-6)
13. Audio system\* (P.4-11 or Navigation system\*\*)
14. Passenger's front-impact air bag\* (P.1-25)
15. Upper instrument box\* (P.2-44)
16. Side ventilator (P.4-5)
17. Headlight aiming control switch\* (P.2-34)
18. Outside rearview mirror control switch\* (P.3-22)
19. Fuel filler lid release handle (P.3-20)
20. Hood lock release handle (P.3-19)
21. Stop/Start System OFF switch\* (P.5-23)
22. Tilting steering wheel lock lever (P.3-21)
23. Ignition switch (model without Intelligent Key system)/steering lock (P.5-5)
24. Push-button ignition switch (model with Intelligent Key system) (P.5-6)
25. Cup holder (P.2-44)
26. Shift lever
  - Automatic Transmission (AT) model (P.5-11)
  - Continuously Variable Transmission (CVT) model (P.5-14)
  - Manual Transmission (MT) model (P.5-17)
27. Power outlet\* (P.2-43) or USB/AUX connector (with navigation system)\*\*
28. Glove box (P.2-44)

\*: if equipped

\*\* : Refer to the separate NISSAN Connect Owner's Manual (if equipped).

## RIGHT-HAND DRIVE (RHD) MODEL (Type A)

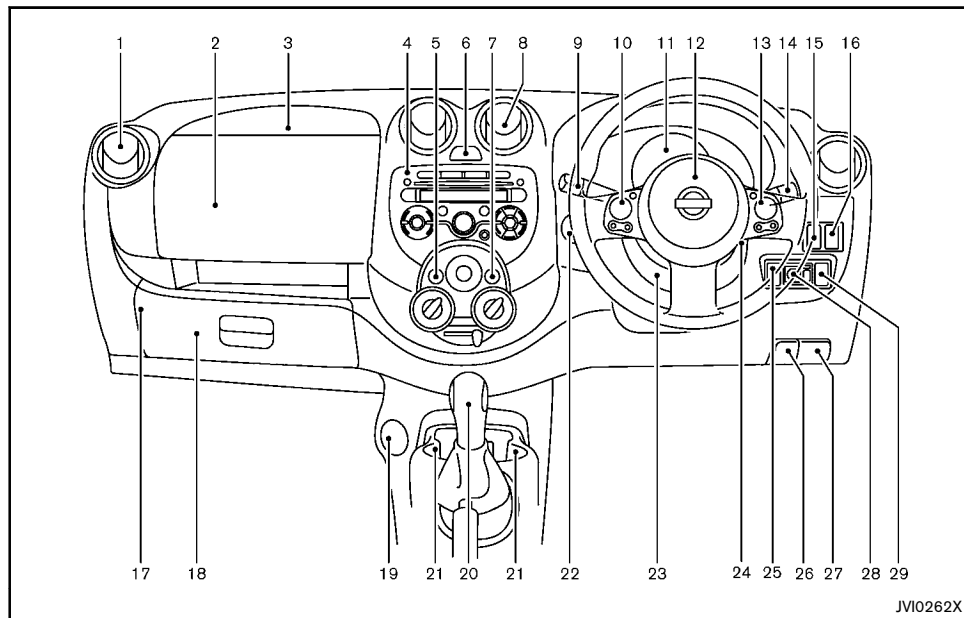

### Example

- |  |   |
|--|---|
| <ol style="list-style-type: none"> <li>1. Side ventilator (P.4-5)</li> <li>2. Upper instrument box* (P.2-44)</li> <li>3. Passenger's front-impact air bag* (P.1-25)</li> <li>4. Audio system* (P.4-11 or Navigation system**)</li> <li>5. Rear window defogger switch* (P.2-39)</li> <li>6. Hazard indicator flasher switch (P.6-2)</li> <li>7. Heater and air conditioner* control (P.4-6)</li> <li>8. Center ventilator (P.4-5)</li> </ol> | <ol style="list-style-type: none"> <li>9. Wiper and washer switch (P.2-37) or Headlight, fog light and turn signal switch (P.2-33)</li> <li>10. Steering-wheel-mounted controls (left side)*               <ul style="list-style-type: none"> <li>— Audio control* (P.4-63)</li> <li>— Bluetooth® Hands-Free Phone System control (without navigation system)* (P.4-64)</li> <li>— Bluetooth® Hands-Free Phone System control (with navigation system)**</li> </ul> </li> </ol> |
|--|---|

11. Meters and gauges (P.2-6)
12. Driver's front-impact air bag\*/Horn (P.1-25, P.2-40)
13. Steering-wheel-mounted controls (right side)\*
  - Cruise control switches\* (P.5-30)
  - Speed limiter switches\* (P.5-28)
14. Headlight, fog light\* and turn signal switch (P.2-33) or Wiper and washer switch (P.2-37)
15. Parking space measurement switch\* (P.5-34)
16. Vehicle Dynamic Control (VDC) OFF switch\* (P.5-24, P.5-25) or Electronic Stability Program (ESP) OFF switch\* (P.5-27)
17. Fuse box (P.8-28)
18. Glove box (P.2-44)
19. Power outlet\* (P.2-43) or USB/AUX connector (with navigation system)\*\*
20. Shift lever
  - Automatic Transmission (AT) model (P.5-11)
  - Continuously Variable Transmission (CVT) model (P.5-14)
  - Manual Transmission (MT) model (P.5-17)
21. Cup holder (P.2-44)
22. Push-button ignition switch (model with Intelligent Key system) (P.5-6)
23. Tilting steering wheel lock lever (P.3-21)
24. Ignition switch (model without Intelligent Key system)/steering lock (P.5-5)
25. Stop/Start System OFF switch\* (P.5-23)
26. Hood lock release handle (P.3-19)
27. Fuel filler lid release handle (P.3-20)
28. Outside rearview mirror control switch\* (P.3-22)
29. Headlight aiming control switch\* (P.2-34)

\*: if equipped

\*\* : Refer to the separate NISSAN Connect Owner's Manual (if equipped).

## RIGHT-HAND DRIVE (RHD) MODEL (Type B)

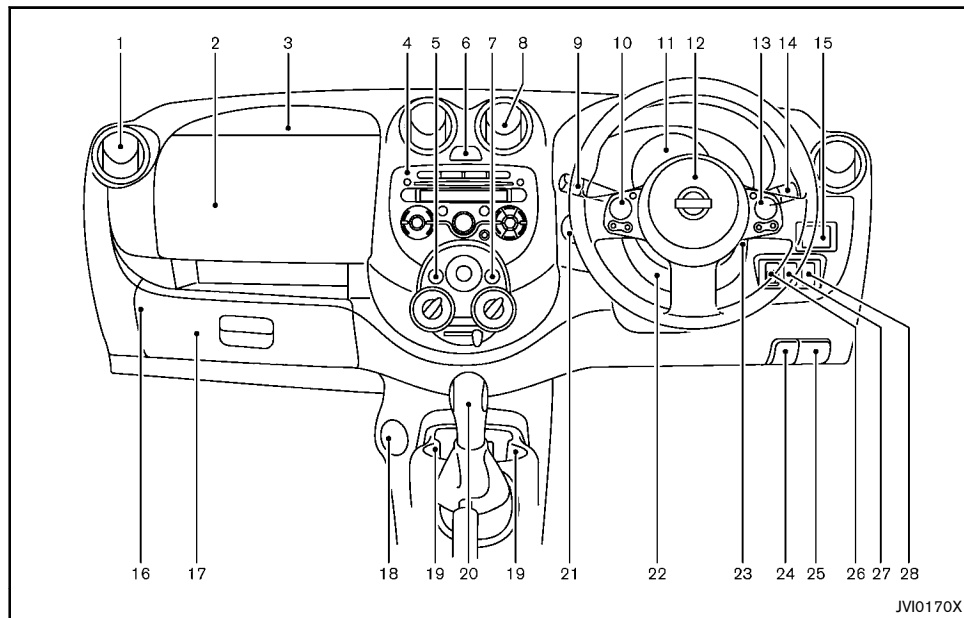

### Example

- |  |  |
|--|--|
| 1. Side ventilator (P.4-5)                       | 9. Wiper and washer switch (P.2-37)  |
| 2. Upper instrument box* (P.2-44)                | 10. Steering-wheel-mounted controls (left side)*                                   |
| 3. Passenger's front-impact air bag* (P.1-25)    | — Audio control* (P.4-63)  |
| 4. Audio system* (P.4-11 or Navigation system**) | — Bluetooth® Hands-Free Phone System control (without navigation system)* (P.4-64) |
| 5. Rear window defogger switch* (P.2-39)         | — Bluetooth® Hands-Free Phone System control (with navigation system)**            |
| 6. Hazard indicator flasher switch (P.6-2)       | 11. Meters and gauges (P.2-6)  |
| 7. Heater and air conditioner* control (P.4-6)   |  |
| 8. Center ventilator (P.4-5)                     |  |

12. Driver's front-impact air bag\*/Horn (P.1-25, P.2-40)
13. Steering-wheel-mounted controls (right side)\*
  - Cruise control switches\* (P.5-30)
  - Speed limiter switches\* (P.5-28)
14. Headlight, fog light\* and turn signal switch (P.2-33)
15. Outside rearview mirror control switch\* (P.3-22)
16. Fuse box (P.8-28)
17. Glove box (P.2-44)
18. Power outlet\* (P.2-43) or USB/AUX connector (with navigation system)\*\*
19. Cup holder (P.2-44)
20. Shift lever
  - Automatic Transmission (AT) model (P.5-11)
  - Continuously Variable Transmission (CVT) model (P.5-14)
  - Manual Transmission (MT) model (P.5-17)
21. Push-button ignition switch (model with Intelligent Key system) (P.5-6)
22. Tilting steering wheel lock lever (P.3-21)
23. Ignition switch (model without Intelligent Key system)/steering lock (P.5-5)
24. Hood lock release handle (P.3-19)
25. Fuel filler lid release handle (P.3-20)
26. Parking space measurement switch\* (P.5-34)
27. Vehicle Dynamic Control (VDC) OFF switch\* (P.5-24)
28. Headlight aiming control switch\* (P.2-34)

\*: if equipped

\*\*: Refer to the separate NISSAN Connect Owner's Manual (if equipped).

## RIGHT-HAND DRIVE (RHD) MODEL (Type C)

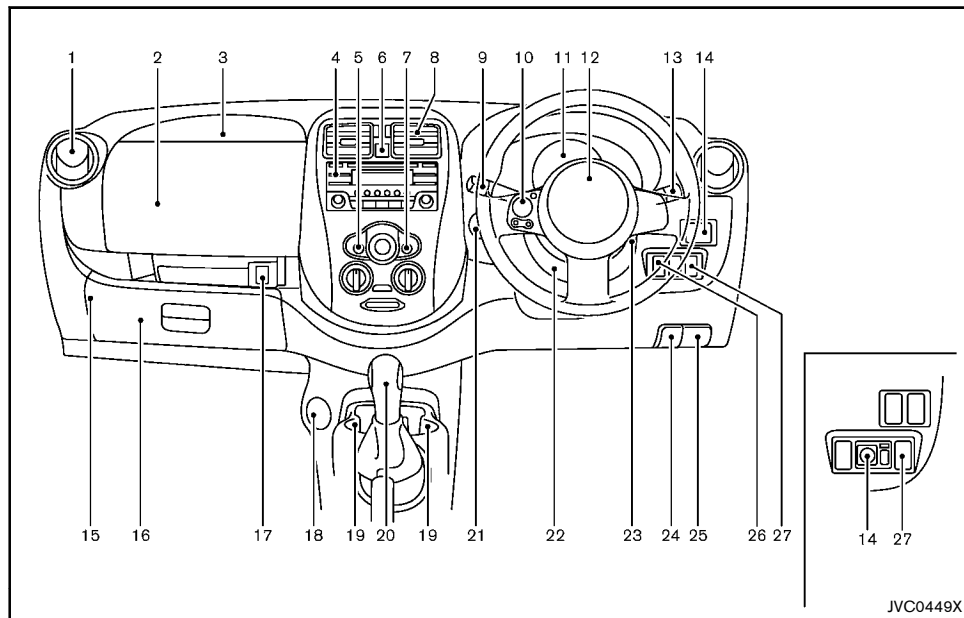

### Example

- |  |  |
|--|--|
| 1. Side ventilator (P.4-5)                     | 9. Wiper and washer switch (P.2-37)                      |
| 2. Upper instrument box* (P.2-44)              | 10. Steering-wheel-mounted controls (left side)*         |
| 3. Passenger's front-impact air bag* (P.1-25)  | — Audio control* (P.4-63)                                |
| 4. Audio system* (P.4-11)                      | — Bluetooth® Hands-Free Phone System control* (P.4-64)   |
| 5. Rear window defogger switch* (P.2-39)       | 11. Meters and gauges (P.2-6)                            |
| 6. Hazard indicator flasher switch (P.6-2)     | 12. Driver's front-impact air bag*/Horn (P.1-25, P.2-40) |
| 7. Heater and air conditioner* control (P.4-6) |  |
| 8. Center ventilator (P.4-5)                   |  |

13. Headlight, fog light\* and turn signal switch (P.2-33)
14. Outside rearview mirror control switch\* (P.3-22)
15. Fuse box (P.8-28)
16. Glove box (P.2-44)
17. USB/AUX connector\* (P. 4-41, P. 4-48)
18. Power outlet\* (P. 2-43)
19. Cup holder (P.2-44)
20. Shift lever
  - Continuously Variable Transmission (CVT) model (P.5-14)
  - Manual Transmission (MT) model (P.5-17)
21. Push-button ignition switch (model with Intelligent Key system) (P.5-6)
22. Tilting steering wheel lock lever (P.3-21)
23. Ignition switch (model without Intelligent Key system)/steering lock (P.5-5)
24. Hood lock release handle (P.3-19)
25. Fuel filler lid release handle (P.3-20)
26. Idling Stop OFF switch\* (P. 5-19)
27. Headlight aiming control switch\* (P.2-34)

\*: if equipped



## METERS AND GAUGES

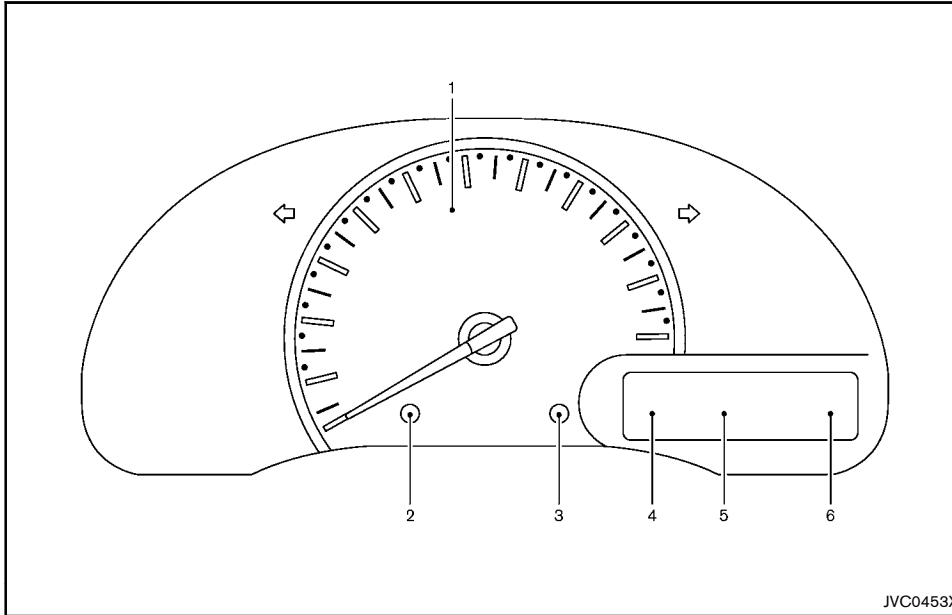

**Type A**

1. Speedometer (P.2-8)
2. Trip odometer reset switch/trip computer mode switch (P.2-8)
3. Clock adjusting knob (P.2-42)
4. Automatic Transmission (AT) position indicator\* (P.2-10, P.5-11)
5. Odometer/twin trip odometer/trip computer (P.2-8)/clock (P.2-42)
6. Fuel gauge (P.2-10)

\*: if equipped

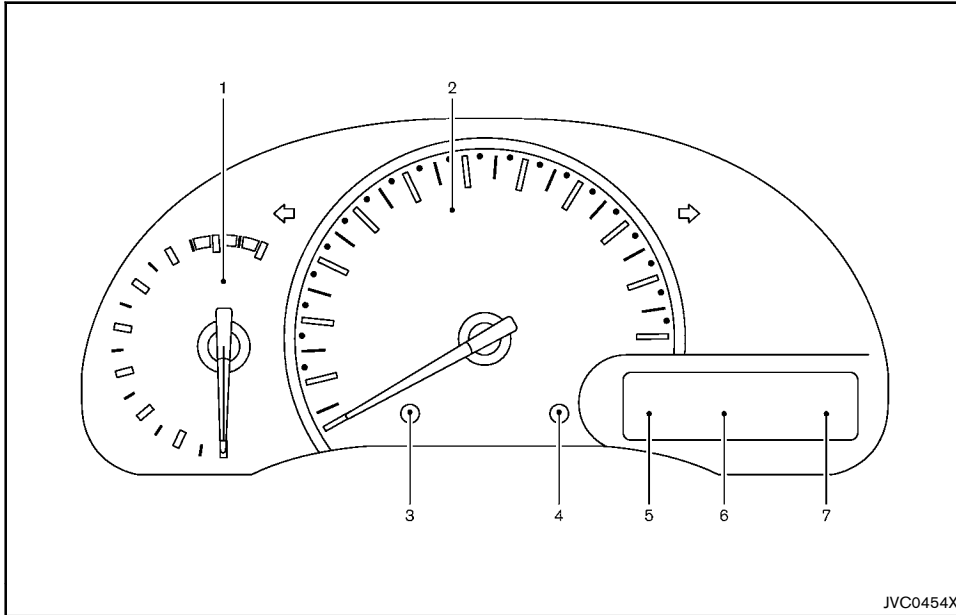

JVC0454X

**Type B**

- |   |                        |
|---|------------------------|
| 1. Tachometer (P.2-10)  | 7. Fuel gauge (P.2-10) |
| 2. Speedometer (P.2-8)  | *: if equipped         |
| 3. Trip odometer reset switch/trip computer mode switch (P.2-8)   |                        |
| 4. Clock adjusting knob (P.2-42)  |                        |
| 5. Automatic Transmission (AT)/Continuously Variable Transmission (CVT) position indicator* (P.2-10, P.5-11)/Cruise control and speed limiter display* (P.5-30, P.5-28) |                        |
| 6. Odometer/twin trip odometer/trip computer (P.2-8)/clock (P.2-42)   |                        |

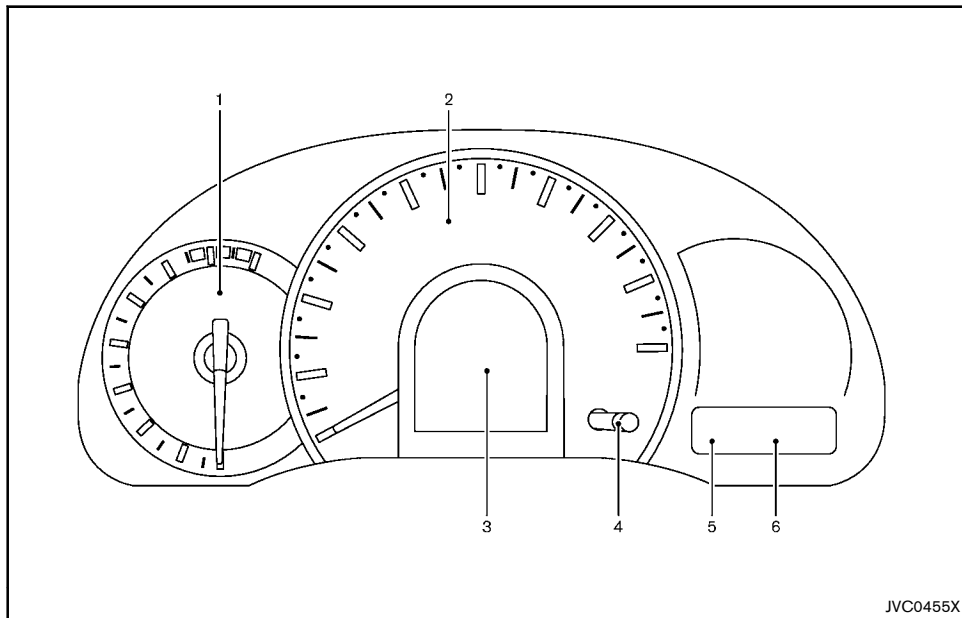

JVC0455X

**Type C**

1. Tachometer (P.2-10)
2. Speedometer (P.2-8)
3. Vehicle information display (P.2-10, P.2-20)
4. Trip odometer reset switch (P.2-8)
5. Automatic Transmission (AT)/Continuously Variable Transmission (CVT) position indicator\* (P.2-10, P.5-11)
6. Odometer/twin trip odometer/clock (P.2-8)

\*: if equipped

## ENGINE COMPARTMENT

### HR12DDR ENGINE MODEL

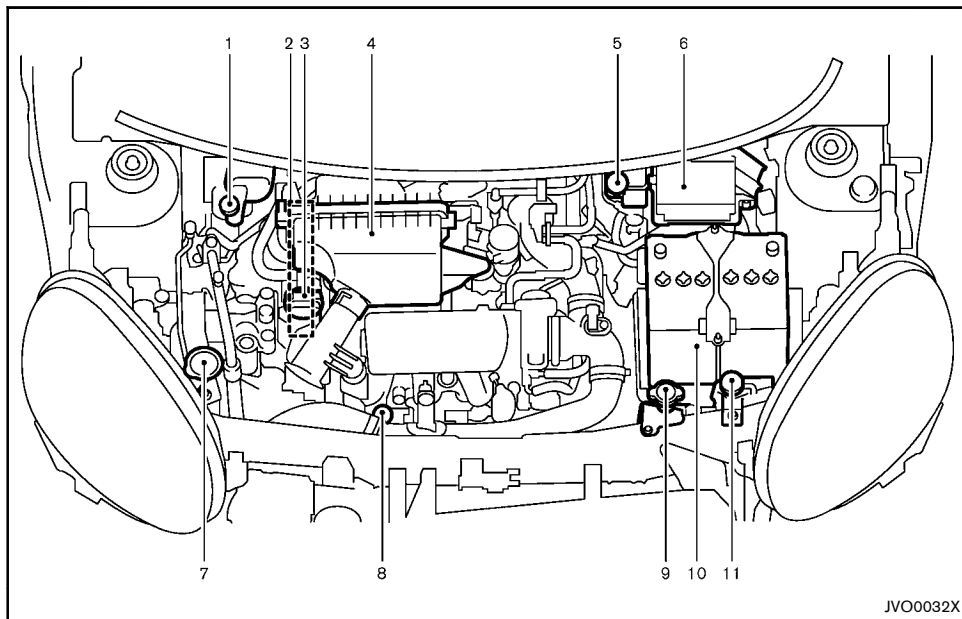

1. Brake and clutch\* fluid reservoir (P.8-19, P.8-20)

— Right-Hand Drive (RHD) model

2. Engine drive belts (P.8-16)

3. Engine oil filler cap (P.8-11)

4. Air cleaner (P.8-21)

5. Brake and clutch\* fluid reservoir (P.8-19, P.8-20)

— Left-Hand Drive (LHD) model

6. Fuse/fusible link box (P.8-27)

7. Window washer fluid reservoir (P.8-23)

8. Engine oil dipstick (P.8-11)

9. Radiator cap (P.8-9)

10. Battery (P.8-24)

11. Engine coolant reservoir (P.8-10)

\*: For Manual Transmission (MT) Model

## HR12DE ENGINE MODEL

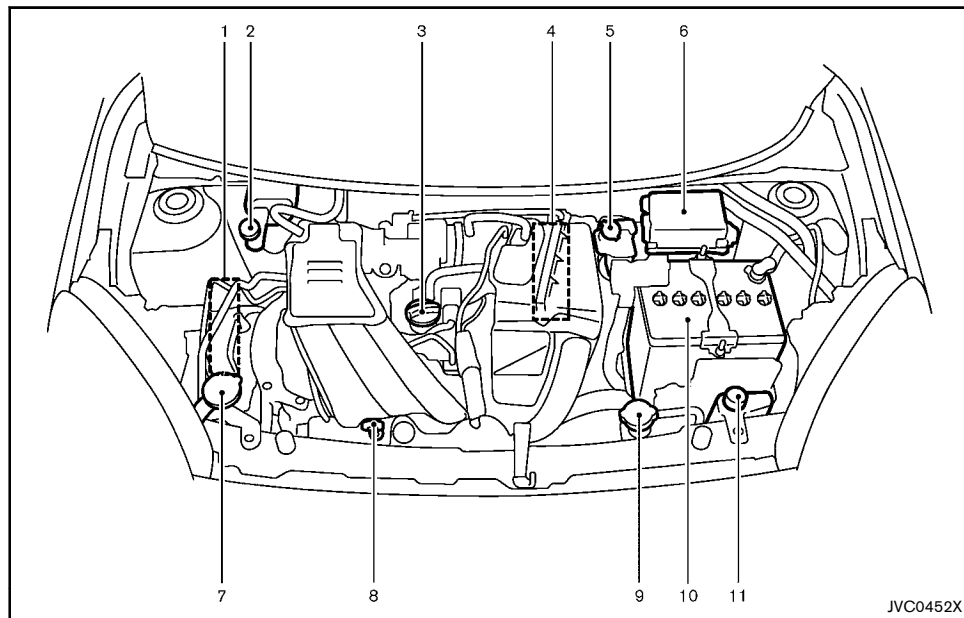

- |   |   |
|---|---|
| 1. Engine drive belts (P.8-16)  | 6. Fuse/fusible link box (P.8-27)         |
| 2. Brake and clutch* fluid reservoir (P.8-19, P.8-20)<br>— Right-Hand Drive (RHD) model | 7. Window washer fluid reservoir (P.8-23) |
| 3. Engine oil filler cap (P.8-11)   | 8. Engine oil dipstick (P.8-11)           |
| 4. Air cleaner (P.8-21)   | 9. Radiator cap (P.8-9)                   |
| 5. Brake and clutch* fluid reservoir (P.8-19, P.8-20)<br>— Left-Hand Drive (LHD) model  | 10. Battery (P.8-24)                      |
|   | 11. Engine coolant reservoir (P.8-10)     |
- \*: For Manual Transmission (MT) Model

## HR15DE ENGINE MODEL

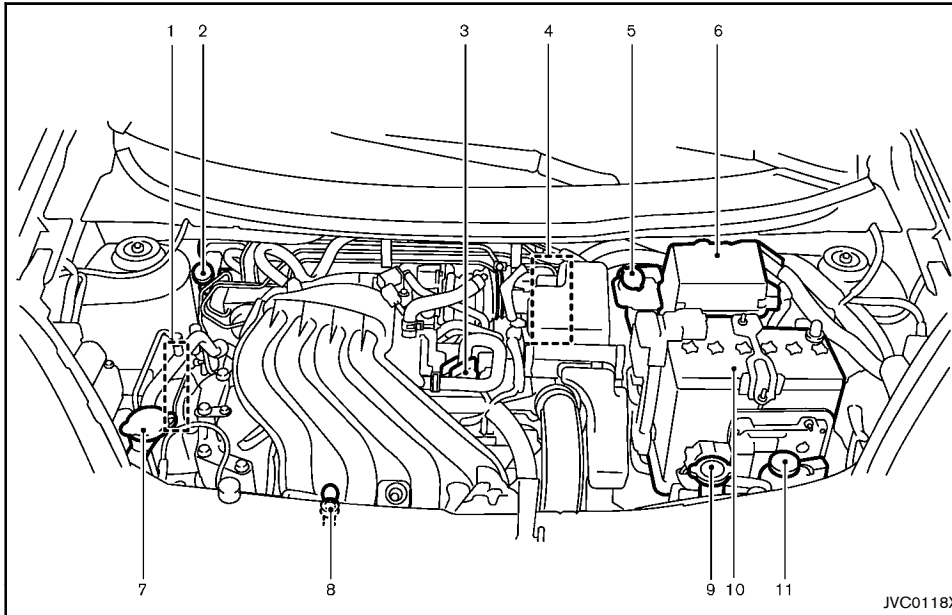

- |   |   |
|---|---|
| 1. Engine drive belts (P.8-16)  | 6. Fuse/fusible link box (P.8-27)         |
| 2. Brake and clutch* fluid reservoir (P.8-19, P.8-20)<br>— Right-Hand Drive (RHD) model | 7. Window washer fluid reservoir (P.8-23) |
| 3. Engine oil filler cap (P.8-11)   | 8. Engine oil dipstick (P.8-11)           |
| 4. Air cleaner (P.8-21)   | 9. Radiator cap (P.8-9)                   |
| 5. Brake and clutch* fluid reservoir (P.8-19, P.8-20)<br>— Left-Hand Drive (LHD) model  | 10. Battery (P.8-24)                      |
|   | 11. Engine coolant reservoir (P.8-10)     |
- \*: For Manual Transmission (MT) Model

## K9K ENGINE MODEL

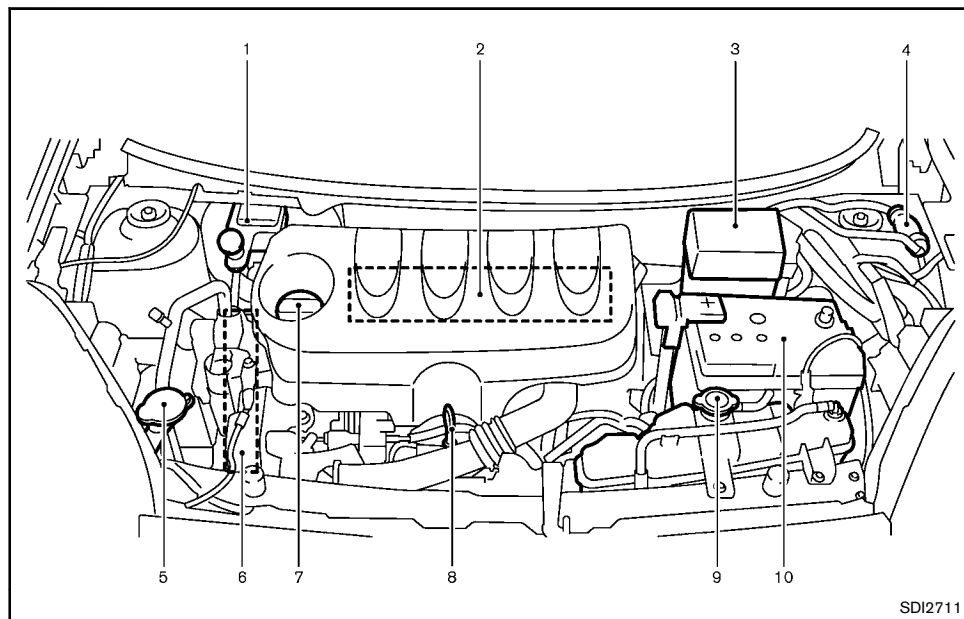

- |  |   |
|--|---|
| 1. Brake and clutch fluid reservoir (P.8-19, P.8-20) | 9. Engine coolant reservoir (P.8-10)<br>— Vehicle overheat (P.6-11) |
| 2. Air cleaner (P.8-21)                              |   |
| 3. Fuse/Fusible link holders (P.8-27)                | 10. Battery (P.8-24)  |
| 4. Priming pump (P.8-16)                             |   |
| 5. Window washer fluid reservoir (P.8-23)            |   |
| 6. Engine drive belts (P.8-16)                       |   |
| 7. Engine oil filler cap (P.8-11)                    |   |
| 8. Engine oil dipstick (P.8-11)                      |   |

# 1 Safety — seats, seat belts and supplemental restraint system

Seats .....	1-2	Child restraints .....	1-13
Front seats .....	1-2	Precautions on child restraint usage .....	1-13
Rear seats .....	1-4	Universal child restraints for front seat and rear seats (for Europe and Ukraine) .....	1-14
Head restraints (if equipped) .....	1-5	ISOFIX child restraint system (if equipped) .....	1-17
Armrest (if equipped) .....	1-6	Child restraint anchorage (if equipped) .....	1-18
Seat belts .....	1-7	Child restraint installation using ISOFIX .....	1-19
Precautions on seat belt usage .....	1-7	Child restraint installation using seat belt .....	1-21
Child safety .....	1-8	Supplemental Restraint System (SRS) (if equipped) .....	1-25
Pregnant women .....	1-9	Precautions on Supplemental Restraint System (SRS) ....	1-25
Injured persons .....	1-9	Supplemental air bag systems .....	1-29
Center mark on seat belts .....	1-9	Pre-tensioner seat belt system (if equipped) .....	1-31
Three-point type seat belts .....	1-9	Repair and replacement procedure .....	1-32
Two-point type seat belts (if equipped) .....	1-12		
Seat belt maintenance .....	1-13		



## SEATS

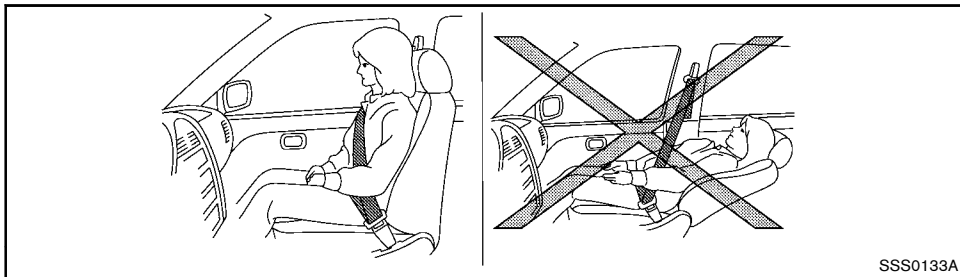

### **WARNING:**

- Do not drive and/or ride in the vehicle with the seatback reclined. This can be dangerous. The shoulder belt will not be properly against the body. In an accident, you and your passengers could be thrown into the shoulder belt and receive neck or other serious injuries. You and your passengers could also slide under the lap belt and receive serious injuries.
- For the most effective protection while the vehicle is in motion, the seatback should be upright. Always sit well back in the seat and adjust the seat belt properly. (See "Seat belts" (P.1-7).)

### **CAUTION:**

When adjusting the seat positions, be sure not to contact any moving parts to avoid possible injuries and/or damages.

## FRONT SEATS

### **WARNING:**

Do not adjust the driver's seat while driving so that full attention may be given to vehicle operation.

Manual seat adjustment

### **WARNING:**

After adjusting a seat, gently shake the seat to confirm that the seat is locked securely. If the seat is not locked securely, it may move suddenly and could cause the loss of control of the vehicle.

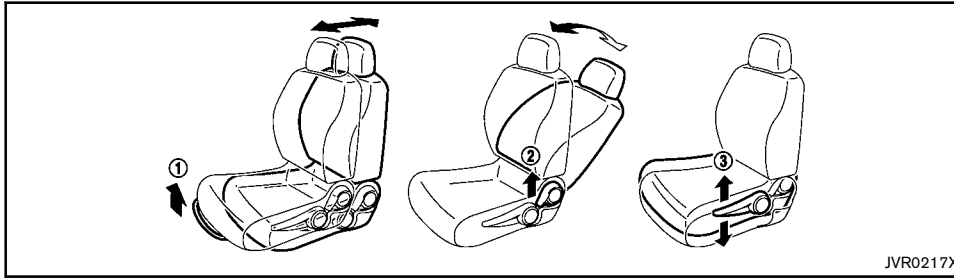

#### Forward and backward:

1. Pull up the adjusting lever ①.
2. Slide the seat to the desired position.
3. Release the adjusting lever to lock the seat in position.

#### Reclining:

1. Pull up the adjusting lever ②.
2. Tilt the seatback to the desired position.
3. Release the adjusting lever to lock the seatback in position.

The reclining feature allows the adjustment of the seatback for occupants of different sizes to help obtain the proper seat belt fit. (See "Seat belts" (P.1-7).)

The seatback may be reclined to allow occupants to rest when the vehicle is parked.

#### Seat lifter (if equipped):

Pull up or push down the adjusting lever ③ to adjust the seat height until the desired position is achieved.

#### Heated seats (if equipped)

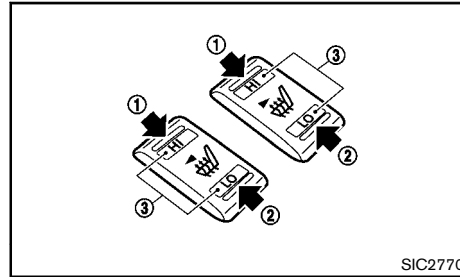

The seats can be warmed by built-in heaters. The switches located on the center console can be operated independently of each other.

1. Start the engine.
2. Select heat range.
  - For high heat, push the HI (High) side of the switch ①.
  - For low heat, push the LO (Low) side of the switch ②.

- The indicator light ③ will illuminate when low or high is selected.
3. To turn off the heater, return the switch to the level position. Make sure the indicator light turns off.

The heater is controlled by a thermostat, automatically turning the heater on and off. The indicator light will remain on as long as the switch is on.

When the vehicle's interior is warmed, or before you leave the vehicle, be sure to turn off the switch.



#### CAUTION:

- **The battery could run down if the seat heater is operated while the engine is not running.**
- **Do not use the seat heater for extended periods or when no one is using the seat.**
- **Do not put anything on the seat which insulates heat, such as a blanket, cushion, seat cover, etc. Otherwise, the seat may become overheated.**
- **Do not place anything hard or heavy on the seat or pierce it with a pin or similar object. This may result in damage to the seat heater.**
- **Any liquid spilled on the heated seat should be removed immediately with a dry cloth.**
- **When cleaning the seat, never use gasoline, thinner, or any similar materials.**
- **If any malfunctions are found or the heated seat does not operate, turn the switch off and have the system checked by a NISSAN dealer.**

## REAR SEATS

### Adjustment



#### WARNING:

- Never allow anyone to ride in the luggage area or on the rear seats when they are in the fold-down position. Use of these areas by passengers without proper restraints could result in serious injury in an accident or sudden stop.
- Do not fold down the rear seats when occupants are in the rear seat area or any luggage is on the rear seats.
- Properly secure all luggage to help prevent it from sliding or shifting. Do not place luggage higher than the seatbacks.
- When returning the seatbacks to the upright position, be certain they are completely secured in the latched position. If they are not completely secured, passengers may be injured in an accident or sudden stop.

### Folding (Type A):

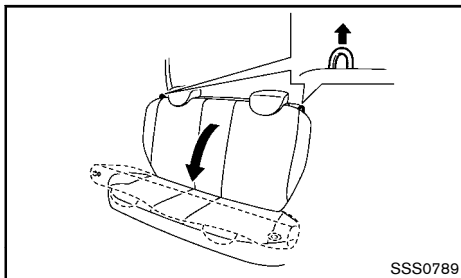

1. Store the seat belts in the proper position. (See "Three-point type seat belts" (P.1-9).)
2. Pull the knob to fold the seatback down.

Passing the seat belt through the path (if equipped):

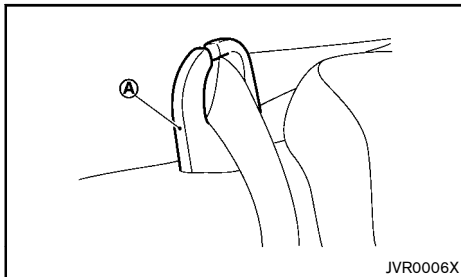

#### CAUTION:

- Fold down the rear seatback with the rear center seat belt passed through the path (A) on the seatback.

- When loading the luggage in the luggage room, be careful not to scratch or damage the seat belt.

If the rear seatback needs to be folded without passing the seat belt through the path (A), be sure to observe the following items.

- After returning the rear seatback to its original position, pass the seat belt through the path (A).
- When operating the seatback, be careful not to scratch or damage the seat belt.

### Folding (Type B):

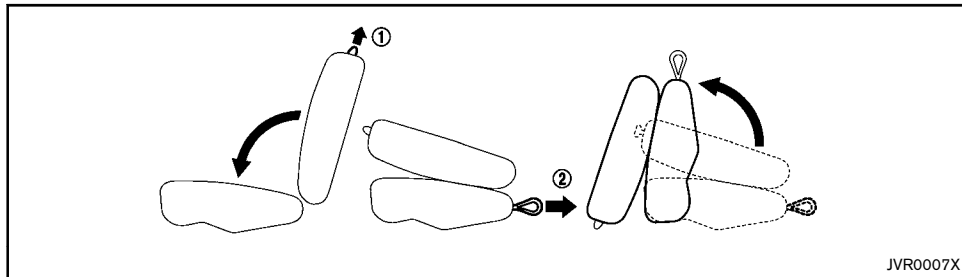

1. Secure the seat belt on the clip.
2. Pull up the knob ① and fold the seatback down.
3. Pull the strap ② and lift the rear of the seat cushion and the seatback.

### Securing of the folded rear seat (if equipped):

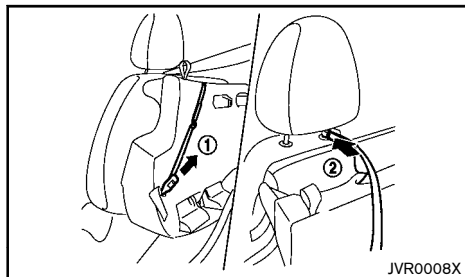

1. Remove the hook ① from the anchor on the underside of the cushion.
2. Secure the hook ② on the stalk as illustrated.



### WARNING:

- Never allow anyone to ride in the luggage area or on the rear seats when they are in the fold-down position. Use of these areas by passengers without proper restraints could result in serious injury in an accident or sudden stop.
- Do not fold down the rear seats when occupants are in the rear seat area or any luggage is on the rear seats.
- Properly secure all luggage to help prevent it from sliding or shifting. Do not place luggage higher than the seatbacks.
- When returning the seatbacks to the upright position, be certain they are completely secured in the latched position. If they are not completely secured, passengers may be injured in an accident or sudden stop.
- Head restraints should be adjusted properly as they may provide significant protection against whiplash injury. Always replace and adjust them properly if they have been

removed for any reason.

### HEAD RESTRAINTS (if equipped)

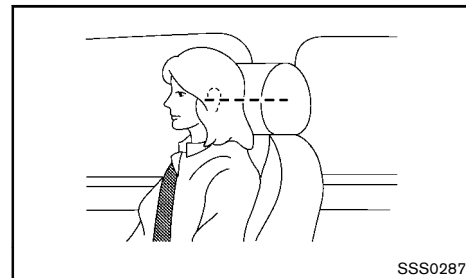

### WARNING:

Do not drive and/or ride in the vehicle with the head restraint removed. This can be dangerous. Head restraints should be adjusted properly as they may provide significant protection against injury in an accident. Check the height after someone else uses the seat.

The proper adjustment of the head restraint is as illustrated.

Adjust the head restraint so that the head restraint's center is level with the center of the ears.

## Adjustment

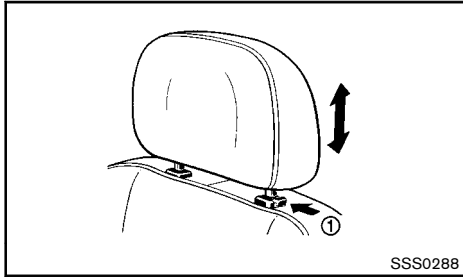

1. Pull up the head restraint to raise to the proper position.
2. Push in the lock knob ① and push down the head restraint to lower to the proper position.

The rear head restraint (if equipped) should only be used in the notched stem positions. The lowest head restraint position is the stowed position.

## ARMREST (if equipped)

### Front

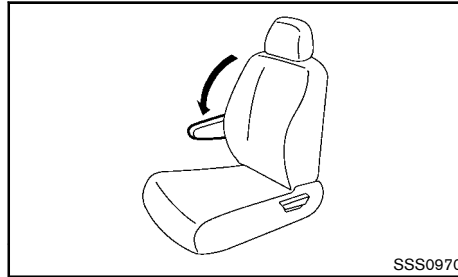

Pull the armrest down until it is horizontal.

## SEAT BELTS

### PRECAUTIONS ON SEAT BELT USAGE

If you are wearing the seat belt properly adjusted and sitting upright and well back in the seat, chances of being injured or killed in an accident and/or the severity of injury may be greatly reduced. NISSAN strongly encourages you and all of your passengers to buckle up every time you drive, even if your seating position includes the supplemental air bag systems.

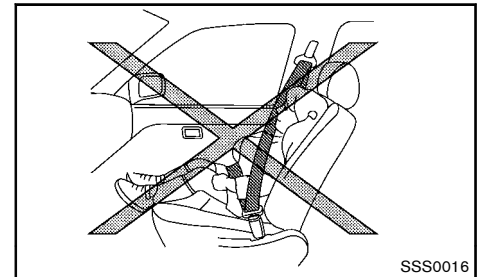
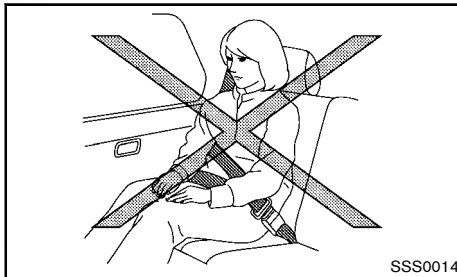
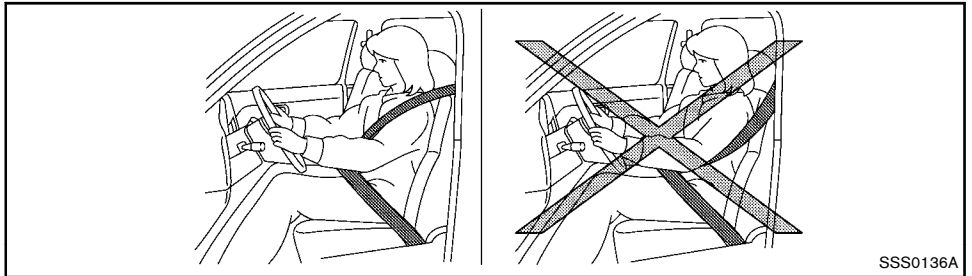
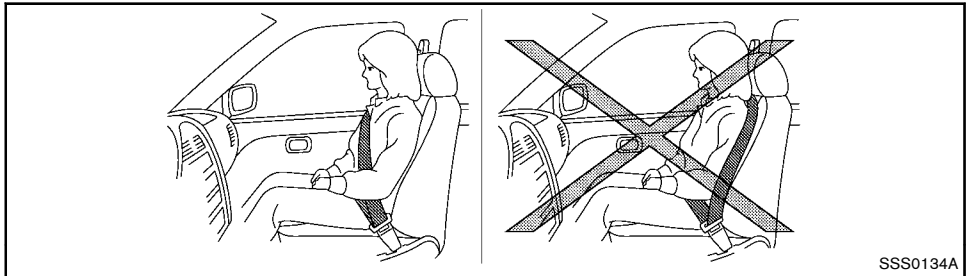



## WARNING:

- Seatbelts are designed to bear upon the bony structure of the body, and should be worn low across the front of the pelvis or the pelvis, chest and shoulders, as applicable; wearing the lap section of the belt across the abdominal area must be avoided. Serious injury may occur if a seat belt is not worn properly.
- Position the lap belt as low and snug as possible around the hips, not the waist. A lap belt worn too high could increase the risk of internal injuries in an accident.
- Do not allow more than one person to use the same seat belt. Each belt assembly must only be used by one occupant; it is dangerous to put a belt around a child being carried on the occupant's lap.
- Never carry more people in the vehicle than there are seat belts.
- Never wear seat belts inside out. Belts should not be worn with straps twisted. Doing so may reduce their effectiveness.
- Seatbelts should be adjusted as firmly as possible, consistent with comfort, to provide the protection for which they have been designed. A slack belt will greatly reduce the protection afforded to the wearer.
- Every person who drives or rides in this vehicle should use a seat belt at all times. Children should be properly restrained in the rear seat and, if appropriate, in a child restraint system.

- Do not run the belt behind your back or under your arm. Always route the shoulder belt over your shoulder and across your chest. The belt should be away from your face and neck, but not falling off your shoulder. Serious injury may occur if a seat belt is not worn properly.
- No modifications or additions should be made by the user which will either prevent the seat belt adjusting devices from operating to remove slack, or prevent the seat belt assembly from being adjusted to remove slack.
- Care should be taken to avoid contamination of the webbing with polishes, oils and chemicals, and particularly battery acid. Cleaning may safely be carried out using mild soap and water. The belt should be replaced if webbing becomes frayed, contaminated or damaged.
- It is essential to replace the entire assembly after it has been worn in a severe impact even if damage to the assembly is not obvious.
- All seat belt assemblies including retractors and attaching hardware should be inspected after any collision by a NISSAN dealer. It is essential to replace the entire assembly after it has been worn in a severe impact even if damage to the assembly is not obvious. NISSAN recommends that all seat belt assemblies in use during a collision be replaced unless the collision was minor and the belts show no damage and continue to operate properly.

- Seat belt assemblies not in use during a collision should also be inspected and, when necessary, replaced if either damage or improper operation is noted.

## CHILD SAFETY



## WARNING:

- Infants and children need special protection. The vehicle's seat belts may not fit them properly. The shoulder belt may come too close to the face or neck. The lap belt may not fit over their small hipbones. In an accident, an improperly fitted seat belt could cause serious or fatal injury.
- Always use an appropriate child restraint system.

Children need adults to help protect them. They need to be properly restrained. The proper restraint depends on the child's size.

## Infants and small children

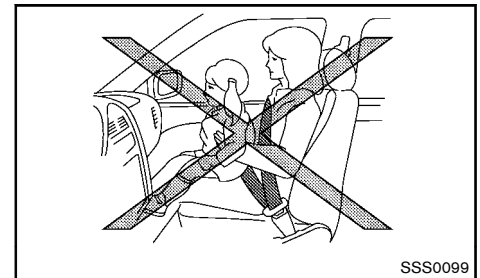

NISSAN recommends that infants and small children be seated in a child restraint system. You should choose a child restraint system that fits your vehicle

and the child, and always follow the manufacturer's instructions for installation and use.

## Large children

### **WARNING:**

- **Never allow children to stand or kneel on any seats.**
- **Never allow children in the luggage area while the vehicle is moving. A child could be seriously injured in an accident or sudden stop.**

Children who are too large for a child restraint system should be seated and restrained by the seat belts that are provided.

If the child's seating position has a shoulder belt that fits close to the face or neck, the use of a booster seat (commercially available) may help overcome this. The booster seat should raise the child so that the shoulder belt is properly positioned across the top, middle portion of the shoulder and the lap belt is low on the hips. The booster seat should also fit the vehicle seat. Once the child has grown so that the shoulder belt is no longer on or near the face or neck of the child, use the shoulder belt without the booster seat. In addition, there are many types of child restraint systems available for larger children that should be used for maximum protection.

## PREGNANT WOMEN

NISSAN recommends that pregnant women use seat belts. The seat belt should be worn snug, and always position the lap belt as low as possible around the hips, not the waist. Place the shoulder belt over your shoulder and across your chest. Never run the lap/shoulder belt over your abdominal area. Contact your doctor for specific recommendations.

## INJURED PERSONS

NISSAN recommends that injured persons use seat belts. Contact your doctor for specific recommendations.

## CENTER MARK ON SEAT BELTS

### Selecting correct set of seat belts

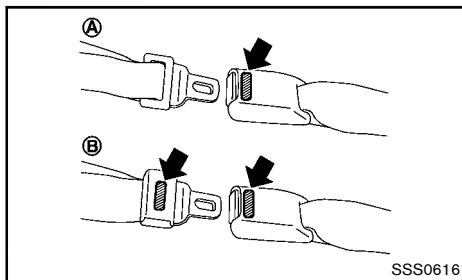

The center seat belt buckle (A) or both the buckle and the tongue (B) are identified by the CENTER mark. The center seat belt tongue can be fastened only into the center seat belt buckle.

## THREE-POINT TYPE SEAT BELTS

### Fastening seat belts

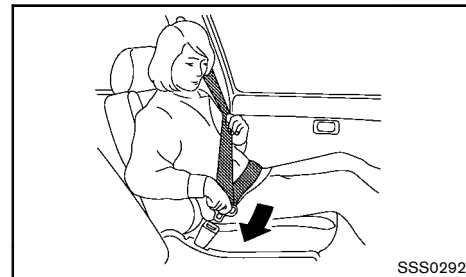

### **WARNING:**

**The seatback should not be in a reclined position any more than needed for comfort. Seat belts are most effective when the passenger sits well back and straight up in the seat.**

1. Adjust the seat. (See "Seats" (P.1-2).)
2. Slowly pull the seat belt out of the retractor and insert the tongue into the buckle until you hear and feel the latch engage.
  - **The retractor is designed to lock during a sudden stop or on impact. A slow pulling motion permits the seat belt to move, and allows you some freedom of movement in the seat.**
  - **If the seat belt cannot be pulled from its fully retracted position, firmly pull the belt and release it. Then smoothly pull the belt out of the retractor.**



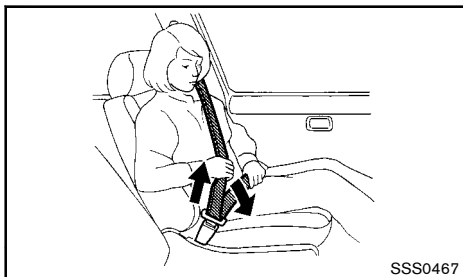

3. Position the lap belt portion low and snug on the hips as shown.
4. Pull the shoulder belt portion toward the retractor to take up extra slack. Be sure the shoulder belt is routed over your shoulder and is snug across your chest.

#### Shoulder belt height adjustment (if equipped)

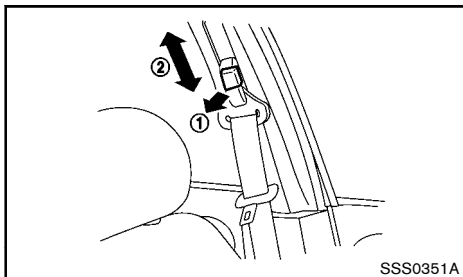

#### **WARNING:**

- **The shoulder belt anchor height should be adjusted to the position best for you. Failure to do so may reduce the effectiveness of the**

**entire restraint system and increase the chance or severity of injury in an accident.**

- **The shoulder belt should rest on the middle of the shoulder. It must not rest against the neck.**
- **Be sure that the seat belt is not twisted in any way.**
- **Be sure that the shoulder belt anchor is secured by trying to move the shoulder belt anchor up and down after adjustment.**

The shoulder belt anchor height should be adjusted to the position best for you.

The belt should be away from your face and neck, but not falling off your shoulder.

To adjust, pull the release button (1) and move the shoulder belt anchor to the proper position (2), so that the belt passes over the center of the shoulder.

Release the button to lock the shoulder belt anchor into position.

#### Unfastening seat belts

Push the button on the buckle. The seat belt automatically retracts.

#### Belt hook

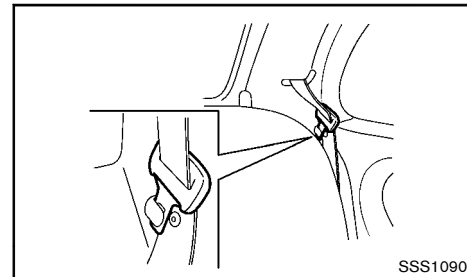

Hook the seat belt at the belt hook when folding down the rear seat.

#### **NOTE:**

**Before folding down the rear seatback, make sure that the seat belt tongue is securely fastened to the belt clip. Also, make sure that the seat belt does not get caught in the seatback when folding down the rear seat.**

#### Checking seat belt operation

Seat belt retractors are designed to lock seat belt movement:

- When the seat belt is pulled quickly from the retractor.
- When the vehicle slows down rapidly.

To increase your confidence in the seat belts, check the operation by grasping the shoulder belt and pulling forward quickly. The retractor should lock and restrict further belt movement. If the retractor does not lock during this check, contact a NISSAN dealer immediately.

## Rear center seat belt (if equipped)

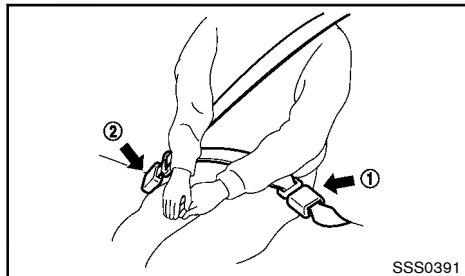

The rear center seat belt has a connector tongue ① and a seat belt tongue ②. Both the connector tongue and the seat belt tongue must be securely latched for proper seat belt operation.

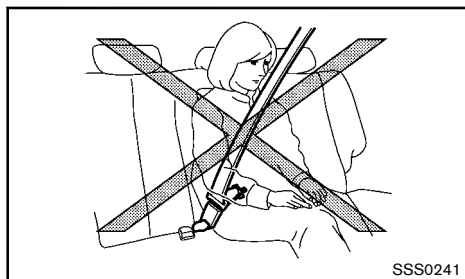

### WARNING:

- Always fasten the connector tongue and the seat belt in the order shown.
- Always make sure both the connector tongue and the seat belt tongue are secured when using the seat belt. Do not use it with

**only the seat belt tongue attached. This could result in serious personal injury in case of an accident or a sudden stop.**

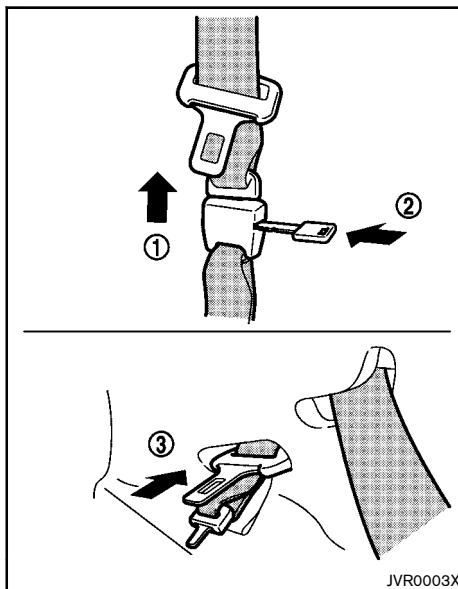

### Stowing rear center seat belt:

When folding down the rear seat, the rear center seat belt can be retracted into a stowed position.

1. Hold the connector tongue ① so that the seat belt does not retract suddenly when the tongue is released from the connector buckle. Release the connector tongue by inserting a suitable tool such as key ② into the connector buckle.

2. Retract the seat belt and store the seat belt tongue and connector tongue on the stowed position ③.

### WARNING:

- Do not unfasten the rear center seat belt connector except when folding down the rear seat.
- When returning the seatback, be sure to attach the rear center seat belt connector.

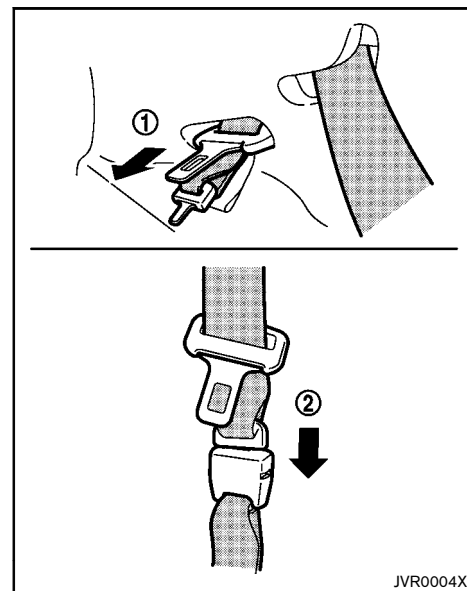

### Attaching rear center seat belt:

Always be sure the rear center seat belt connector tongue and connector buckle are attached. Disconnect only when folding down the rear seat.

To connect the buckle:

1. Pull the seat belt tongue and connector tongue from the stowed position ①.
2. Pull the seat belt and secure the connector buckle until it clicks ②.

The center seat belt connector tongue can be attached only into the rear center seat belt connector buckle.

To fasten the seat belt, see "Fastening seat belts" (P.1-9).



### WARNING:

- When attaching the rear center seat belt connector, be certain that the seatbacks are completely secured in the latched position and the rear center seat belt connector is completely secured.
- If the rear center seat belt connector and the seatbacks are not secured in the correct position, serious personal injury may result in an accident or sudden stop.

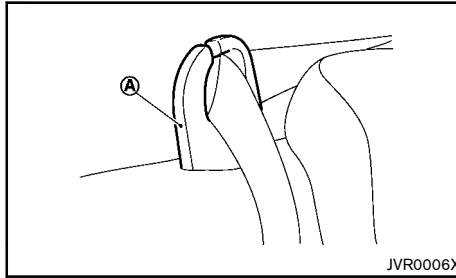

JVR0006X



### CAUTION:

Make sure to wear the rear center seat belt with the seat belt passing through the path ①.

### TWO-POINT TYPE SEAT BELTS (if equipped)

#### Fastening seat belts

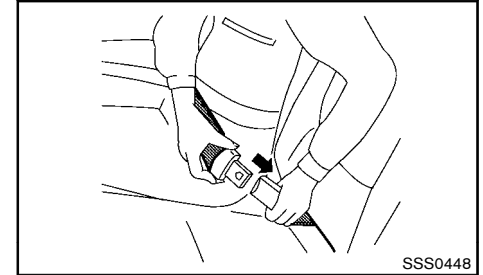

SSS0448



### WARNING:

The seatback should not be in a reclined position any more than needed for comfort. Seat belts are most effective when the passenger sits well back and straight up in the seat.

1. Insert the tongue into the buckle marked CENTER until you hear and feel the latch engage.

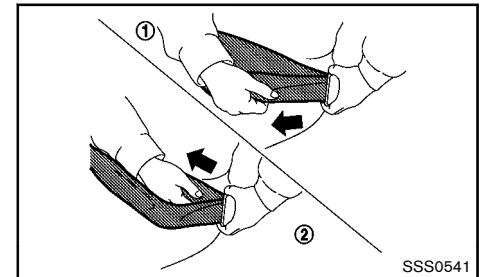

SSS0541

## CHILD RESTRAINTS

- Adjust the seat belt length. To shorten, hold the tongue and pull the upper belt as illustrated ①. To lengthen, hold the tongue and pull the under belt as illustrated ②.

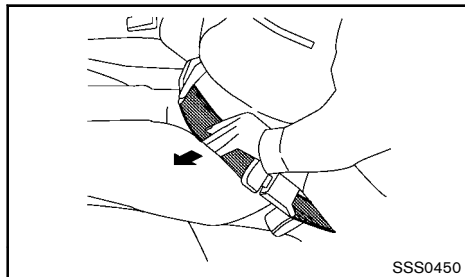

- Position the lap belt portion low and snug on the hips as shown.

### Unfastening seat belts

Push the button on the buckle.

### SEAT BELT MAINTENANCE

Periodically check that the seat belt and all the metal components, such as buckles, tongues, retractors, flexible wires and anchors, work properly. If loose parts, deterioration, cuts or other damage on the seat belt webbing is found, the entire seat belt assembly should be replaced.

If dirt builds up in the shoulder belt guide of the seat belt anchors, the seat belts may retract slowly. Wipe the shoulder belt guide with a clean, dry cloth.

To clean the seat belt webbing, apply a mild soap solution or any solution recommended for cleaning upholstery or carpet. Then wipe with a cloth and allow the seat belts to dry in the shade. Do not allow the seat belts to retract until they are completely dry.

### PRECAUTIONS ON CHILD RESTRAINT USAGE

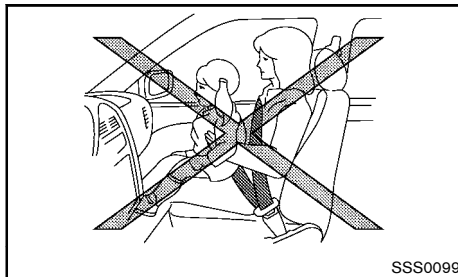

### WARNING:

- Infants and small children should never be carried on your lap. It is not possible for even the strongest adult to resist the forces of a severe accident. The child could be crushed between the adult and parts of the vehicle. Also, it is dangerous to put a seat belt around a child being carried on the occupant's lap.
  - Infants and children need special protection. The vehicle's seat belts may not fit them properly. The shoulder belt may come too close to the face or neck. The lap belt may not fit over their small hip bones. In an accident, an improperly fitting seat belt could cause serious or fatal injury.
  - Infants and small children should always be placed in an appropriate child restraint system while riding in the vehicle. Failure to use a child restraint system can result in serious injury or death.
- Child restraint systems specially designed for infants and small children are available from several manufacturers. When selecting any child restraint systems, place your child in the child restraint system and check the various adjustments to be sure that the child restraint system is compatible with your child. Always follow the manufacturer's instructions for installation and use.
  - NISSAN recommends that the child restraint system be installed in the rear seat. According to accident statistics, children are safer when properly restrained in the rear seat rather than in the front seat.
  - Follow all of the child restraint system manufacturer's instructions for installation and use. When purchasing a child restraint system, be sure to select one which will fit your child and vehicle. It may not be possible to properly install some types of child restraint systems in your vehicle.
  - For a front-facing child restraint system, check to make sure the shoulder belt does not fit close to child's face or neck. If it does, put the shoulder belt behind the child restraint system.
  - Never install a rear-facing child restraint system in the front seat. An inflating supplemental front-impact air bag could seriously injure or kill your child. A rear-facing child restraint system must only be used in the rear seat.
  - Adjustable seatbacks should be positioned to fit a child restraint system, but as upright as possible.

- **If the seat belt in the position where a child restraint system is installed requires a locking clip and if it is not used, injuries could result from a child restraint system tipping over during normal vehicle braking or cornering.**
- **After attaching a child restraint system, test it before you place the child in it. Tilt it from side to side. Try to tug it forward and check if it is held securely in place. The child restraint system should not move more than 25 mm (1 in). If the restraint is not secure, tighten the belt as necessary, or install the restraint in another seat and test it again.**
- **Check the child restraint system in your vehicle to be sure that it is compatible with the vehicle's seat belt system.**
- **If a child restraint system is not anchored properly, the risk of a child being injured in a collision or a sudden stop greatly increases.**
- **Improper use of a child restraint system can increase the risk or severity of injury for both the child and other occupants in the vehicle.**
- **Always use an appropriate child restraint system. An improperly installed child restraint system could lead to serious injury or death in an accident.**
- **When the child restraint system is not in use, keep it secured with the ISOFIX child restraint system (if equipped) or a seat belt to prevent it from being thrown around in case of a sudden stop or accident.**

installation and use. In addition, there are many types of child restraint systems available for larger children that should be used for maximum protection.



#### **CAUTION:**

**Remember that a child restraint system left in a closed vehicle can become very hot. Check the seating surface and buckles before placing your child in a child restraint system.**

#### UNIVERSAL CHILD RESTRAINTS FOR FRONT SEAT AND REAR SEATS (for Europe and Ukraine)

When selecting any child restraint, keep the following points in mind:

- Choose a child restraint that complies with the latest European safety standard, ECE Regulation 44.04.
- Place your child in the child restraint and check the various adjustments to be sure the child restraint is compatible with your child. Always follow all of the recommended procedures.
- Check the child restraint in your vehicle to be sure it is compatible with vehicle's seat belt system.
- Refer to the tables later in this section for a list of the recommended fitment positions and the approved child restraints for your vehicle.

NISSAN recommends that infants and small children be seated in a child restraint system. You should choose a child restraint system that fits your vehicle and always follow the manufacturer's instructions for

## Approved child restraint positions (models without ISOFIX)

Seating position							
Weight group	Front passenger	Rear (Single folding)			Rear (Tumble)		
		Right	Centre	Left	Right	Centre	Left
0 (<10 kg)	X	L	L	L	L	L	L
0 +(<13 kg)	X	L	L	L	L	L	L
I (9 to 18 kg)	UF	L	X	L	L	L	X
II (15 to 25 kg)	UF	L	L	L	L	L	L
III (22 to 36 kg)	UF	L	L	L	L	L	L

X: Not suitable for child restraint system.

UF: Suitable for forward-facing (FWF) universal category child restraint system approved for this group.

L: Suitable for the particular child restraints provided in the following table.

## List of approved child restraints

Weight group	Name of CRS	Facing position	Category
0 to 13 kg	Britax/RÖMER BABY-SAFE	Rear-facing	Universal
9 to 18 kg	Britax/RÖMER DUO plus	Front-facing	Universal
9 to 18 kg	Fair GO/1S	Front-facing	Universal
15 to 36 kg	Britax/RÖMER Kid	Front-facing	Universal

## Approved child restraint positions (models with ISOFIX)

The following restrictions are applied when using child restraints varying by infants weight and installation position (ISOFIX child restraint):

Weight group	Seating position		
			Rear outer
Carry-cot	F	ISO/L1	X
	G	ISO/L2	X
0 (<10 kg)	E	ISO/R1	X
0+ (<13 kg)	E	ISO/R1	X
	D	ISO/R2	X
	C	ISO/R3	IL
I (9 to 18 kg)	D	ISO/R2	X
	C	ISO/R3	IL
	B	ISO/F2	IUF
	B1	ISO/F2X	IUF, IL
	A	ISO/F3	IUF
II (15 to 25 kg)		-	X
III (22 to 36 kg)		-	X

X: Not suitable for child restraint system.

IUF: Suitable for forward-facing (FWF) universal category child restraint system approved for this group.

IL: Suitable for the particular ISOFIX category child restraint systems (CRS) provided in the following table. These ISOFIX CRS are those of the specific vehicle, restricted or semi-universal categories.

## 1-16 Safety — seats, seat belts and supplemental restraint system

List of approved child restraints

Weight group	Size class	Name of CRS	Fixture of CRS	Facing position	Category
0 to 18 kg	C	Fair GO/1S	ISO/R3 support frame (type A)	Rear-facing	Semi-Universal
9 to 18 kg	B1	Britax/RÖMER DUO plus	ISO/F2X top tether	Front-facing*	Universal

\*Front facing: from 2 years only with headrest.



**WARNING:**

**In vehicles equipped with a side air bag system, do not let any infants or small children sit in the front passenger's seat as the air bag may cause serious injury in case of deployment during a collision.**

**NOTE:**

**Child restraints approved to ECE Regulation NO. 44.04 are clearly marked with the categories such as Universal, Semi-universal or ISOFIX.**

ISOFIX CHILD RESTRAINT SYSTEM (if equipped)

Your vehicle is equipped with special anchor points that are used with ISOFIX child restraint systems.

ISOFIX lower anchor point locations

The ISOFIX anchor points are provided to install child restraints in the rear outboard seating positions only.

**Do not attempt to install a child restraint in the center position using the ISOFIX anchors.**

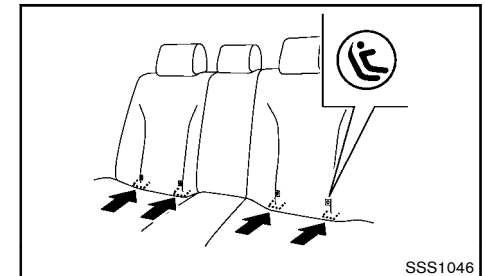

ISOFIX label location



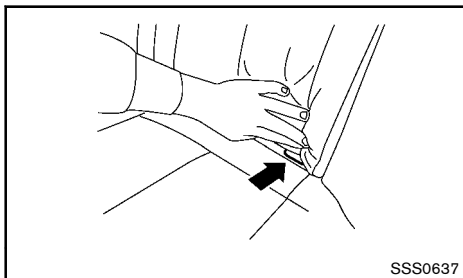

**ISOFIX lower anchor location**

The ISOFIX anchors are located at the rear of the seat cushion near the seatback. A label is attached to the seatback to help you locate the ISOFIX anchors.

#### ISOFIX child restraint anchor attachments

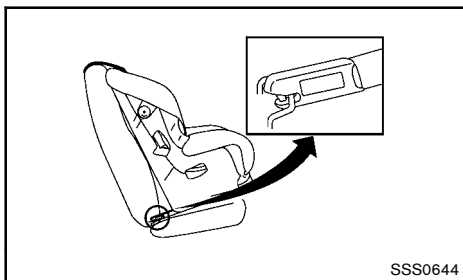

**Anchor attachment**

ISOFIX child restraints include two rigid attachments that can be connected to two anchors located in the seat. With this system, you do not have to use a vehicle seat belt to secure the child restraint. Check your child restraint for a label stating that it is compatible with the ISOFIX child restraints. This information may also be in the instructions provided by the child restraint manufacturer.

ISOFIX child restraints generally require the use of a top tether strap or other anti-rotation devices such as support legs. When installing ISOFIX child restraints, carefully read and follow the instructions in this manual and those supplied with the child restraints. (See “Child restraint installation using ISOFIX” (P.1-19).)

#### CHILD RESTRAINT ANCHORAGE (if equipped)

Your vehicle is designed to accommodate a child restraint system on the rear seat. When installing a child restraint system, carefully read and follow the instructions in this manual and those supplied with the child restraint system.



#### **WARNING:**

- **Child restraint anchorages are designed to withstand only those loads imposed by correctly fitted child restraints. Under no circumstances are they to be used for adult seat belts, harnesses or for attaching other items or equipment to the vehicle.**
- **The child restraint top tether strap may be damaged by contact with the cargo cover or items in the luggage area. Remove the cargo cover from the vehicle or secure it and any luggage. Your child could be seriously injured or killed in a collision if the top tether strap is damaged.**

#### Anchorage location

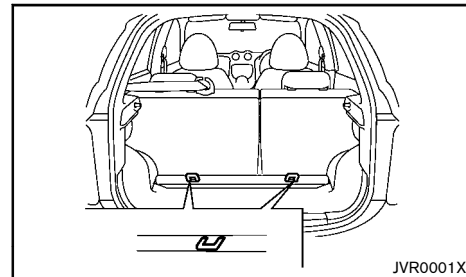

The anchor points are located on the seat behind the rear seats outboard seating positions.

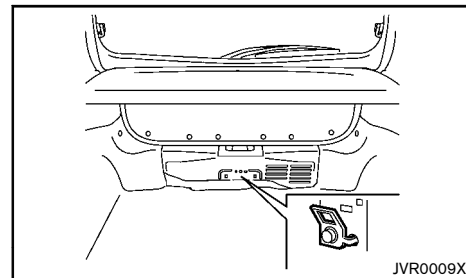

#### **For Australia and New Zealand**

The center anchorage (if equipped) is located on the back door opening.

## CHILD RESTRAINT INSTALLATION USING ISOFIX



### WARNING:

- **Attach ISOFIX child restraints only at the specified locations. For the ISOFIX lower anchor locations, see “ISOFIX child restraint system” (P.1-17). If a child restraint is not secured properly, your child could be seriously injured or killed in an accident.**
- **Do not install child restraints that require the use of a top tether strap to seating positions that do not have a top tether anchor.**
- **Do not secure a child restraint in the center rear seating position using the ISOFIX lower anchors. The child restraint will not be secured properly.**
- **Inspect the lower anchors by inserting your fingers into the lower anchor area and feeling to make sure there are no obstructions over the ISOFIX anchors, such as seat belt webbing or seat cushion material. The child restraint will not be secured properly if the ISOFIX anchors are obstructed.**
- **Child restraint anchorages are designed to withstand only those loads imposed by correctly fitted child restraints. Under no circumstance are they to be used for adult seat belts, harnesses or for attaching other items or equipment to the vehicle.**

## Installation on rear outboard seats

### Front-facing:

Be sure to follow the manufacturer's instructions for the proper use of your child restraint. Follow these steps to install a front-facing child restraint on the rear outboard seats using ISOFIX:

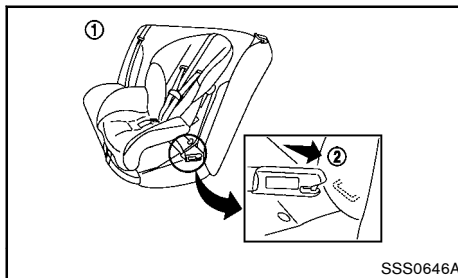

#### Steps 1 and 2

1. Position the child restraint on the seat ①.
2. Secure the child restraint anchor attachments to the ISOFIX lower anchors ②.
3. The back of the child restraint should be secured against the vehicle seat back. If necessary, adjust or remove the head restraint to obtain the correct child restraint fit. (See “Head restraints” (P.1-5).) If the head restraint is removed, store it in a secure place. Be sure to install the head restraint when the child restraint is removed. If the seating position does not have an adjustable head restraint and it is interfering with the proper child restraint fit, try another seating position or a different child restraint.

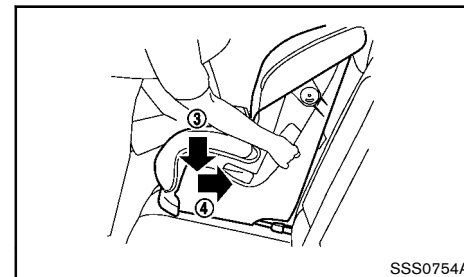

#### Step 4

4. Shorten the rigid attachment to have the child restraint firmly tightened; press downward ③ and rearward ④ firmly in the center of the child restraint with your knee to compress the vehicle seat cushion and seatback.
5. If the child restraint is equipped with a top tether strap, route the top tether strap and secure the tether strap to the tether anchor point. (See “Child restraint anchorage” (P.1-18).)
6. If the child restraint is equipped with other anti-rotation devices such as support legs, use them instead of the top tether strap following the child restraint manufacturer's instructions.

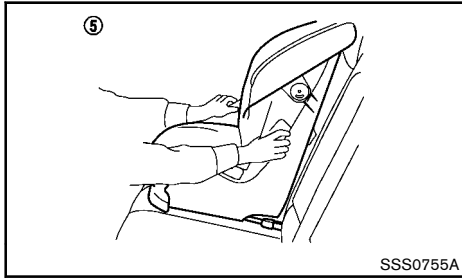

**Step 7**

7. Test the child restraint before you place the child in it ⑤. Push the child restraint from side to side and tug it forward to make sure that it is held securely in place.
8. Check to make sure that the child restraint is properly secured prior to each use. If the child restraint is loose, repeat steps 3 through 7.

**Rear-facing:**

Be sure to follow the manufacturer's instructions for the proper use of your child restraint. Follow these steps to install a rear-facing child restraint on the rear outboard seats using ISOFIX:

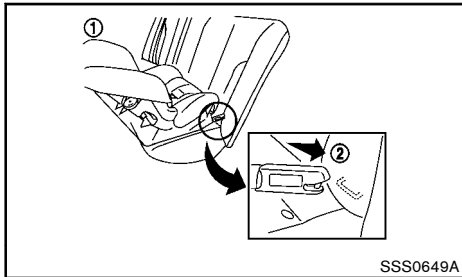

**Steps 1 and 2**

1. Position the child restraint on the seat ①.
2. Secure the child restraint anchor attachments to the ISOFIX lower anchors ②.

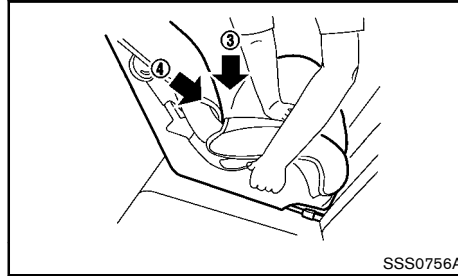

**Step 3**

3. Shorten the rigid attachment to have the child restraint firmly tightened; press downward ③ and rearward ④ firmly in the center of the child restraint with your hand to compress the vehicle seat cushion and seatback.
4. If the child restraint is equipped with a top tether strap, route the top tether strap and secure the tether strap to the tether anchor point. (See "Child restraint anchorage" (P.1-18) .)
5. If the child restraint is equipped with other anti-rotation devices such as support legs, use them instead of the top tether strap following the child restraint manufacturer's instructions.

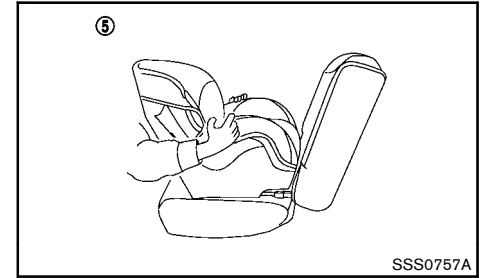

**Step 6**

6. Test the child restraint before you place the child in it ⑥. Push the child restraint from side to side and tug it forward to make sure that it is held securely in place.
7. Check to make sure that the child restraint is properly secured prior to each use. If the child restraint is loose, repeat steps 3 through 6.

## CHILD RESTRAINT INSTALLATION USING SEAT BELT

Installation on rear outboard seats - seat belts without automatic locking mode retractor



### WARNING:

- The three-point type seat belt on your vehicle is not equipped with an automatic locking mode retractor.
- The direction of the child restraint system depends on the type of the child restraint system and the size of the child.

If your vehicle is equipped with rear seat adjustment, note the following:

- Attach the child restraints after adjusting the rear seats to the upright position.
- Do not recline the rear seats with the child restraints attached to them.

### Front-facing:

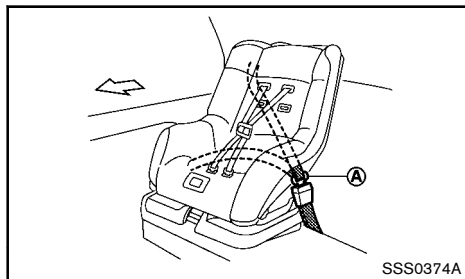

If you must install a front-facing child restraint system on the rear seat, follow these steps:

1. Position the front-facing child restraint system on the rear seat.  
Always follow the child restraint system manufacturer's instructions for installation and use.
2. Route the seat belt tongue through the child restraint system and insert it into the buckle until you hear and feel the latch engage.

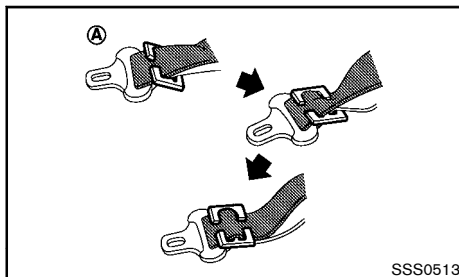

To prevent slack in the lap belt, it is necessary to secure the shoulder belt in place with a locking clip (A). Use the locking clip attached to the child restraint system or one which is equivalent in dimension and strength.

Be sure to follow the child restraint system manufacturer's instructions for belt routing.

3. Test the child restraint system before you place the child in it. Tilt it from side to side. Try to tug it forward and check if it is held securely in place.
4. Make sure that the child restraint system is properly secured prior to each use.

### Rear-facing:

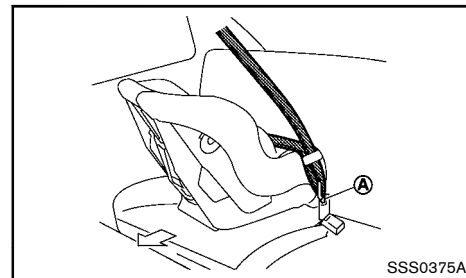

If you must install a rear-facing child restraint system on the rear seat, follow these steps:

1. Position the rear-facing child restraint system on the rear seat.

Always follow the child restraint system manufacturer's instructions for installation and use.

2. Route the seat belt tongue through the child restraint system and insert it into the buckle until you hear and feel the latch engage.

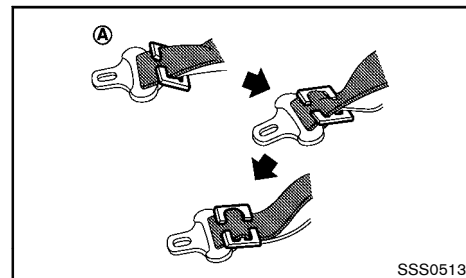

To prevent slack in the lap belt, it is necessary to secure the shoulder belt in place with a locking

clip (A) . Use the locking clip attached to the child restraint system or one which is equivalent in dimension and strength.

Be sure to follow the child restraint system manufacturer's instructions for belt routing.

3. Test the child restraint system before you place the child in it. Tilt it from side to side. Try to tug it forward and check if it is held securely in place.
4. Make sure that the child restraint system is properly secured prior to each use.

Installation on rear center seat (2-point type seat belt)- seat belts without automatic locking mode



**WARNING:**

- **The rear center two-point type seat belt on your vehicle is not equipped with an automatic locking mode retractor.**
- **The direction of the child restraint system depends on the type of the child restraint system and the size of the child.**

**Front-facing:**

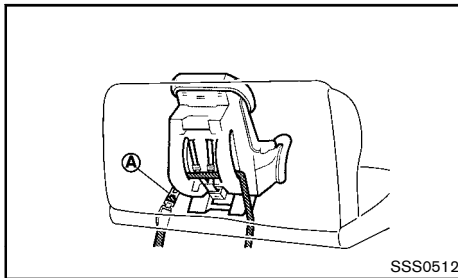

If you must install a front-facing child restraint system on the rear center seat, follow these steps:

1. Position the front-facing child restraint system on the rear center seat.

Always follow the child restraint system manufacturer's instructions for installation and use.

2. Route the seat belt tongue through the child restraint system and insert it into the buckle until you hear and feel the latch engage.

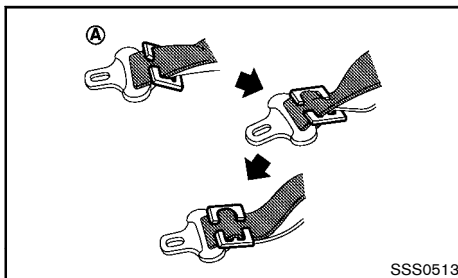

Locking clip

3. To prevent slack in the lap belt, it is necessary to secure the lap belt in place with a locking clip (A) . Use the locking clip attached to the child restraint system, or one which is equivalent in dimensions and strength.

Be sure to follow the child restraint system manufacturer's instructions for belt routing.

4. Test the child restraint system before you place the child in it. Tilt it from side to side. Try to tug it forward and check if it is held securely in place.
5. Make sure that the child restraint system is properly secured prior to each use.

**Rear-facing:**

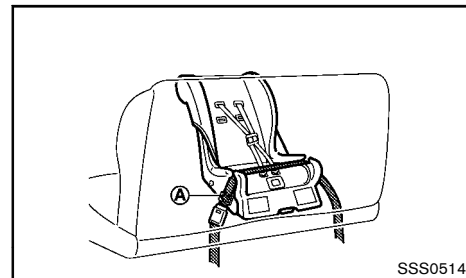

If you must install a rear-facing child restraint system on the rear center seat, follow these steps:

1. Position the rear-facing child restraint system on the rear center seat.

Always follow the child restraint system manufacturer's instructions for installation and use.

2. Route the seat belt tongue through the child restraint system and insert it into the buckle until you hear and feel the latch engage.

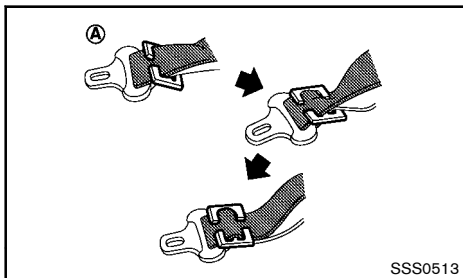

Locking clip

### Installation on front seat - seat belts without automatic locking mode

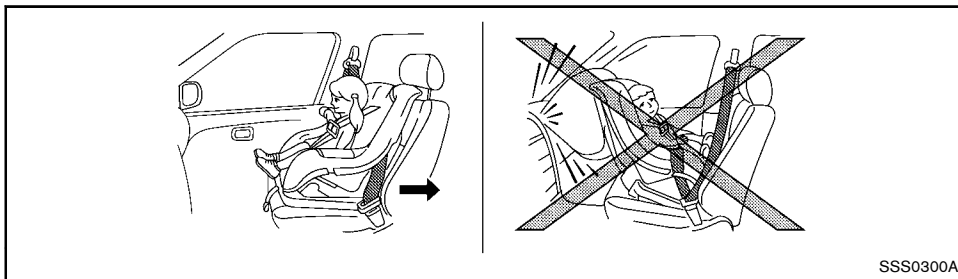

3. To prevent slack in the lap belt, it is necessary to secure the lap belt in place with a locking clip (A). Use the locking clip attached to the child restraint system, or one which is equivalent in dimensions and strength.

Be sure to follow the child restraint system manufacturer's instructions for belt routing.

4. Test the child restraint system before you place the child in it. Tilt it from side to side. Try to tug it forward and check if it is held securely in place.
5. Make sure that the child restraint system is properly secured prior to each use.



### WARNING:

- **Never install a rear-facing child restraint on the front passenger's seat when the front passenger's air bag is equipped. Supplemental front-impact air bags inflate with great force. A rear-facing child restraint could be struck by the supplemental front-impact air bags in an accident and could seriously injure or kill your child.**
- **Never install a child restraint system with a top tether strap on the front seat.**
- **NISSAN recommends that a child restraint system be installed on the rear seat. However, if you must install a front-facing child restraint system on the front passenger's seat, move the passenger's seat to the rearmost position.**
- **Child restraints for infants must be used in the rear-facing direction and therefore must not be used on the front passenger's seat when the front passenger's air bag is**

equipped.

### Front-facing:

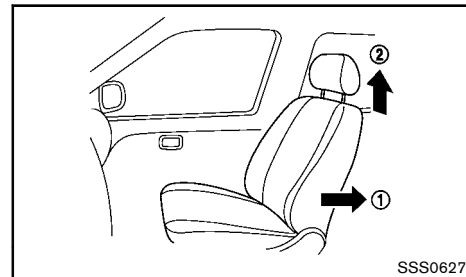

If you must install a front-facing child restraint system on the front seat, follow these steps:

1. Turn off the front passenger's air bag using the front passenger air bag switch. (See "Supplemental air bag systems" (P.1-29)) Place the ignition switch in the "ON" position and make sure that the front air bag status light  on the meter illuminates (if equipped).

2. Move the seat to the rearmost position ① .
3. Adjust the head restraint to its highest position ② .
4. Position the front-facing child restraint system on the front passenger's seat. It should be placed in the front-facing direction only.

Always follow the child restraint system manufacturer's instructions for installation and use.

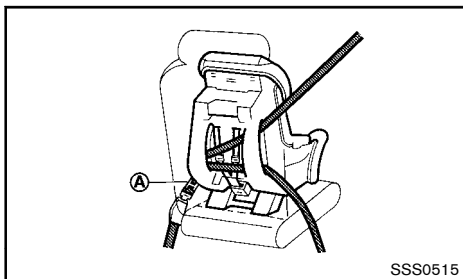

5. Route the seat belt tongue through the child restraint system and insert it into the buckle until you hear and feel the latch engage.

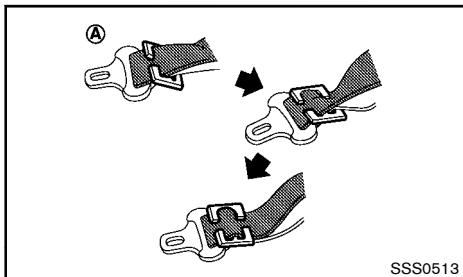

Locking clip

6. To prevent slack in the lap belt, it is necessary to secure the shoulder belt in place with a locking clip ① . Use the locking clip attached to the child restraint system, or one which is equivalent in dimensions and strength.

Be sure to follow the child restraint system manufacturer's instructions for belt routing.

7. Slide the seat forward so that the seat belt fully tightens the child restraint system.
8. Test the child restraint system before you place the child in it. Tilt it from side to side. Try to tug it forward and check if it is held securely in place.
9. Make sure that the child restraint system is properly secured prior to each use.

## SUPPLEMENTAL RESTRAINT SYSTEM (SRS) (if equipped)

### PRECAUTIONS ON SUPPLEMENTAL RESTRAINT SYSTEM (SRS)

This Supplemental Restraint System (SRS) section contains important information concerning the driver's and passenger's supplemental front-impact air bags.

#### Supplemental front-impact air bag system (if equipped)

This system can help cushion the impact force to the head and chest area of the driver and/or front passenger in certain frontal collisions. The supplemental front-impact air bag is designed to inflate on the front where the vehicle is impacted.

#### Supplemental side-impact air bag system (if equipped)

This system can help cushion the impact force to the chest and pelvis areas of the driver and front passenger in certain side-impact collisions. The supplemental side-impact air bag is designed to inflate on the side where the vehicle is impacted.

#### Supplemental curtain side-impact air bag system (if equipped)

This system can help cushion the impact force to the head of the driver and passengers in front and rear outboard seating positions in certain side-impact collisions. The supplemental curtain side-impact air bag is designed to inflate on the side where the vehicle is impacted.

The SRS is designed to **supplement** the accident protection provided by the driver's seat belt and **is not** designed to **substitute** for it. The SRS can help save lives and reduce serious injuries. However, inflating air bags may cause abrasions or other injuries. Air bags do not provide protection to the lower body. Seat belts should always be correctly worn and the occupants

should always be seated a suitable distance away from the steering wheel. (See "Seat belts" (P.1-7).) The air bags inflate quickly in order to help protect the occupants. The force of the air bags inflating can increase the risk of injury if the occupants are too close to, or are against, the air bag modules during inflation.

The air bags will deflate quickly after deployment.

**The SRS operates only when the ignition switch is in the "ON" or "START" position.**

**When the ignition switch is in the "ON" position, the SRS air bag warning light illuminates for about 7 seconds and then turns off. This indicates that the SRS is operational. (See "SRS air bag warning light" (P.1-28).)**



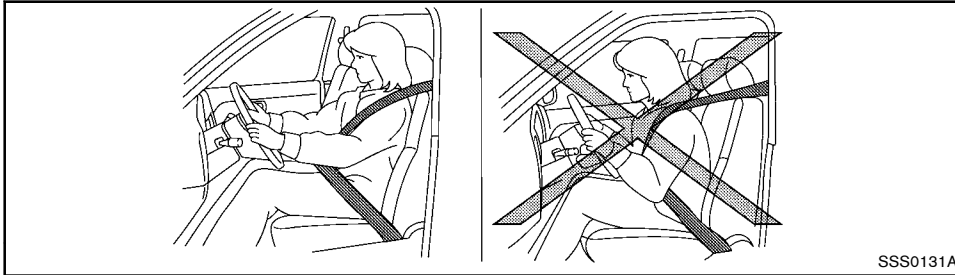

SSS0131A

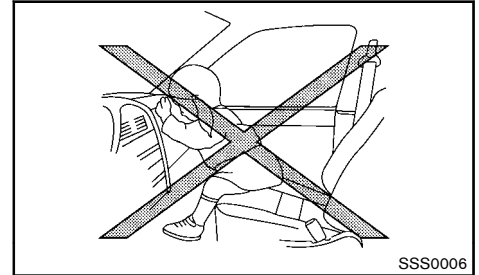

SSS0006

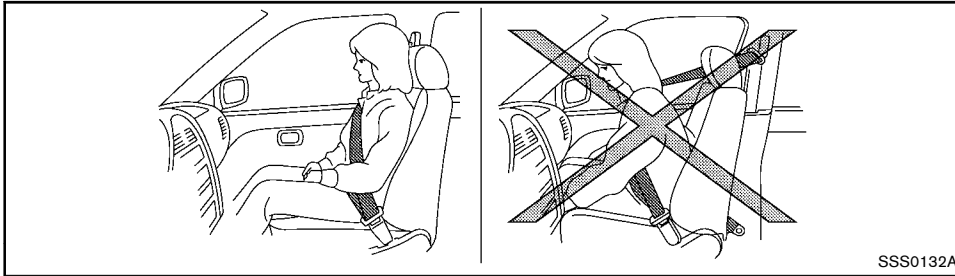

SSS0132A

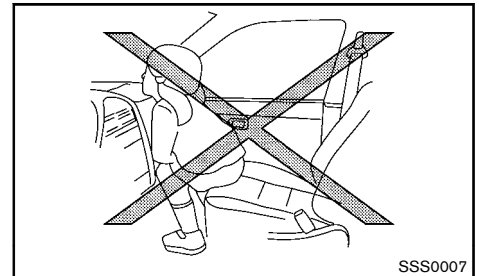

SSS0007

**WARNING:**

- The supplemental front-impact air bags ordinarily will not inflate in the event of a side impact, rear impact, rollover, or lower severity frontal collision. Always wear the seat belts to help reduce the risk or severity of injury in accidents.
- The seat belts and the supplemental front-impact air bags are most effective when you are sitting well back and upright in the seat. The front-impact air bags inflate with great force. If you are unrestrained, leaning for-

ward, sitting sideways, or out of position in any way, you are at greater risk of injury or death in an accident. You may also receive serious or fatal injuries from the supplemental front-impact air bag if you are up against it when it inflates. Always sit back against the seatback and as far away as practical from the steering wheel. Always use the seat belts.

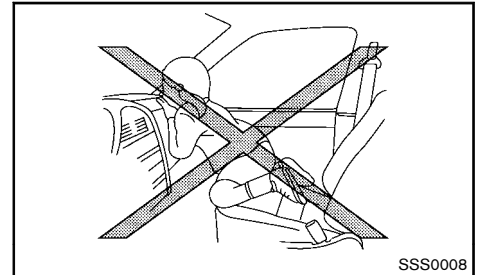

SSS0008

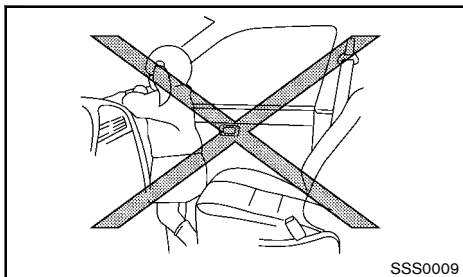

**⚠ WARNING:**

- Never let children ride unrestrained or extend their hands or face out of the window. Do not attempt to hold them in your lap or arms. Some examples of dangerous riding positions are shown in the illustrations.
- Children may be severely injured or killed when the air bags inflate if they are not properly restrained.
- Never install a rear-facing child restraint system in the front seat. An inflating supplemental front-impact air bag could seriously injure or kill your child. (See "Child restraints" (P.1-13).)

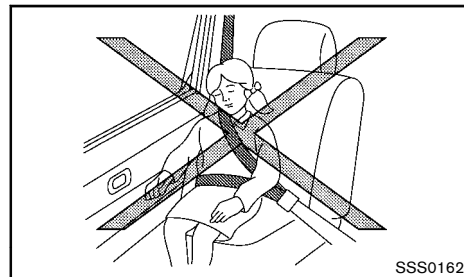
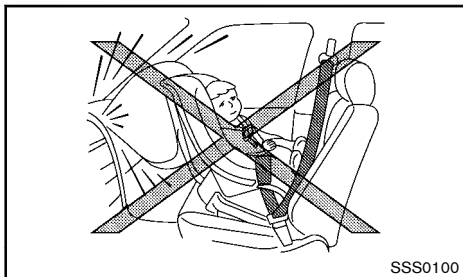
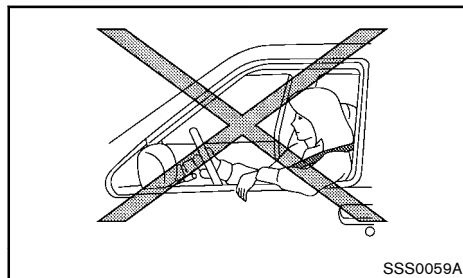
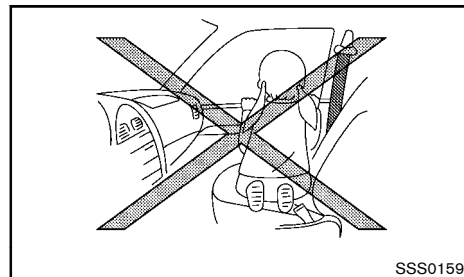
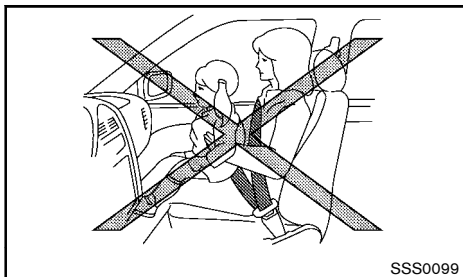
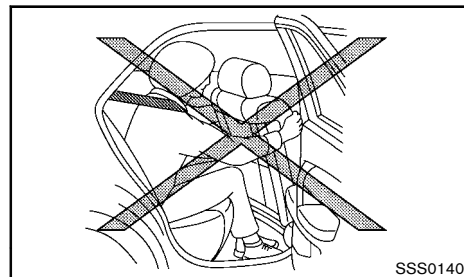



## WARNING:

- The supplemental side-impact air bags and supplemental curtain side-impact air bags ordinarily will not inflate in the event of a front impact, rear impact, rollover, or lower severity side collision. Always wear the seat belts to help reduce the risk or severity of injury in accidents.
- The seat belts and the supplemental side-impact air bags and supplemental curtain side-impact air bags are most effective when you are sitting well back and upright in the seat. The supplemental side-impact air bags and supplemental curtain side-impact air bags inflate with great force. If you and your passengers are unrestrained, leaning forward, sitting sideways, or out of position in any way, you and your passengers are at greater risk of injury or death in an accident.
- Do not allow anyone to place their hands, legs, or face near the supplemental side-impact air bags and supplemental curtain side-impact air bags on the sides of the seatback of the front seats or near the side roof rails. Do not allow anyone sitting in the front seats or rear outboard seats to extend their hands out of the windows or lean against the doors. Some examples of dangerous riding positions are shown in the illustrations.
- When sitting in the rear seats, do not hold onto the seatback of the front seats. If the supplemental side-impact air bags and supplemental curtain side-impact air bags inflate, you may be seriously injured. Be especially careful with children, who should

always be properly restrained.

- Do not use seat covers on the front seatbacks. They may interfere with the supplemental side-impact air bag inflations.

### Pre-tensioner seat belt system (if equipped)

The pre-tensioner seat belt system may activate with the supplemental air bag system in certain types of collisions.

Working with the seat belt retractor and anchor, it helps tighten the seat belt the instant the vehicle becomes involved in certain types of collisions, helping to restrain front seat occupants. (See “Pre-tensioner seat belt system” (P.1-31) .)

### Air bag warning label (if equipped)

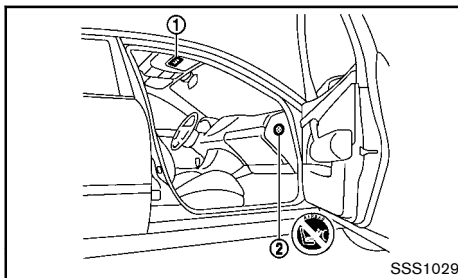

### SRS air bag:

The warning label ① is located on the surface of the passenger’s sun visor.

### SRS front-impact passenger air bag:

The warning label ② (if equipped) is located on the side of the passenger’s side instrument panel.

This label warns you not to fit a rear-facing child restraint system on the front passenger seat as such a restraint system used in this position could cause serious injury to the infant in case of air bag deployment during a collision.

In vehicles equipped with a front-impact passenger air bag system, use a rear-facing child restraint system only on the rear seats. “Extreme Hazard! Do not use a rearward facing child restraint on a seat protected by an airbag in front of it!”

When installing a child restraint system in your vehicle, always follow the child restraint system manufacturer’s instructions for installation.

For additional information, see “Child restraints” (P.1-13).

### SRS air bag warning light



The SRS air bag warning light, displaying  in the instrument panel, monitors the circuits for the air bag systems, pre-tensioners and all related wiring.

When the ignition switch is in the “ON” or “START”

position, the SRS air bag warning light illuminates for about 7 seconds and then turns off. This indicates that the SRS air bag systems are operational.

If any of the following conditions occur, the air bag and/or pre-tensioner seat belt systems need servicing:

- The SRS air bag warning light remains on after approximately 7 seconds.
- The SRS air bag warning light flashes intermittently.
- The SRS air bag warning light does not illuminate at all.

Under these conditions, the air bag and/or pre-tensioner seat belt systems may not operate properly. They must be checked and repaired. Contact a NISSAN dealer immediately.

## SUPPLEMENTAL AIR BAG SYSTEMS

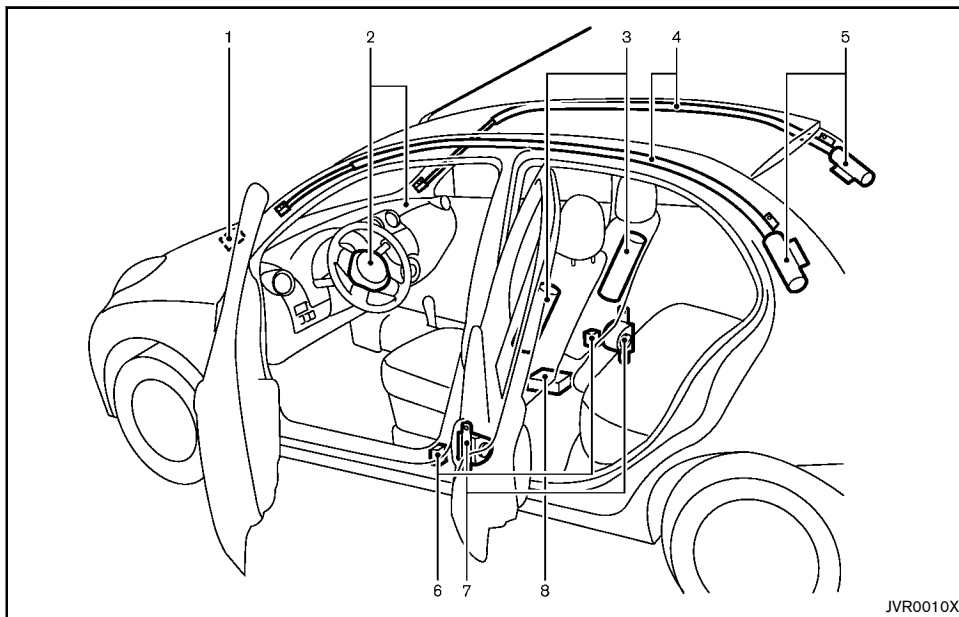

1. Crash zone sensor
2. Supplemental front-impact air bag modules\*
3. Supplemental side-impact air bag modules\*
4. Supplemental curtain side-impact air bag modules\*
5. Supplemental curtain side-impact air bag inflators\*
6. Satellite sensors\*

7. Pre-tensioner seat belt retractors\*
8. Supplemental air bag diagnosis sensor unit

\*: if equipped



### WARNING:

- **Do not place any objects on the steering wheel pad. Do not place any objects between the driver and steering wheel pad. Such objects may become dangerous pro-**

jectiles and cause injury if a supplemental air bag inflates.

- **Immediately after inflation, several supplemental air bag system components will be hot. Do not touch them: you may severely burn yourself.**
- **No unauthorized changes should be made to any components or wiring of the supplemental air bag systems. This is to prevent accidental inflation of the supplemental air bags or damage to the supplemental air bag systems.**
- **Do not make unauthorized changes to your vehicle's electrical system, suspension system or front end structure. This could affect proper operation of the supplemental air bag systems.**
- **Tampering with the supplemental air bag systems may result in serious personal injury. Tampering includes changes to the steering wheel by placing materials over the steering wheel pad and above, and by installing additional trim materials around the supplemental air bag systems.**
- **Work around and on the supplemental air bag systems should be done by a NISSAN dealer. The SRS wiring should not be modified or disconnected. Unauthorized electrical test equipment and probing devices should not be used on the supplemental air bag systems.**
- **The SRS wiring harness connectors are yellow and/or orange for easy identification.**

When the air bags inflate, a fairly loud noise may be heard, followed by the release of smoke. This smoke is not harmful and does not indicate a fire. Care should

be taken not to inhale it, as it may cause irritation and choking. Those with a history of a breathing condition should get fresh air promptly.

### Supplemental front-impact air bag system

The driver's supplemental front-impact air bag is located at the center of the steering wheel. The passenger's supplemental front-impact air bag (if equipped) is located at the instrument panel above the glove box.

The supplemental front-impact air bag system is designed to inflate in higher severity frontal collisions, although it may inflate if the forces in another type of collision are similar to those of a higher severity frontal impact. It may not inflate in certain frontal collisions. Vehicle damage (or lack of it) is not always an indication of proper supplemental front-impact air bag system operation.

### Front passenger air bag status light (if equipped):

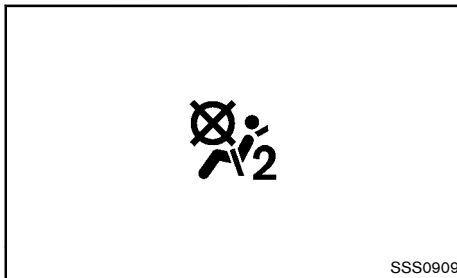

The front passenger air bag status light is located on the meter.

When the ignition switch is placed in the "ON" position, the front passenger air bag status light illuminates for about 7 seconds and then turns off or

remains on depending on the front passenger air bag status.

- When the ignition switch is placed in the "ON" position and the front passenger air bag is active, the front passenger air bag status light will turn off after approximately 7 seconds.
- When the front passenger air bag is turned off with the front passenger air bag switch, the front passenger air bag status light will illuminate and remain on as long as the front passenger air bag switch is in the "OFF" position.

If the front passenger air bag status light operates in a way other than described above, the front passenger air bag may not function properly. Have the system checked, and if necessary repaired by a NISSAN dealer promptly.

### Front passenger air bag switch (if equipped):

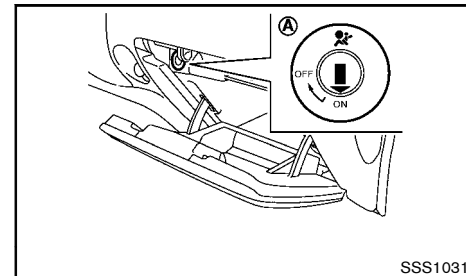

The front passenger air bag can be turned off with the front passenger air bag switch (A) located inside of the glove box.

To turn off the front passenger air bag:

1. Place the ignition switch in the "OFF" position.

2. Open the glove box and insert the key into the front passenger air bag switch. For Intelligent Key equipped models, see “Keys” (P.3-2).
3. Push and turn the key to the “OFF” position.
4. Place the ignition switch in the “ON” position. The front passenger air bag status light will illuminate and remain on.

To turn on the front passenger air bag:

1. Place the ignition switch in the “OFF” position.
2. Open the glove box and insert the key into the front passenger air bag switch.
3. Push and turn the key to the “ON” position.
4. Place the ignition switch in the “ON” position. The front passenger air bag status light will illuminate then turn off.

#### Supplemental side-impact air bag system (if equipped)

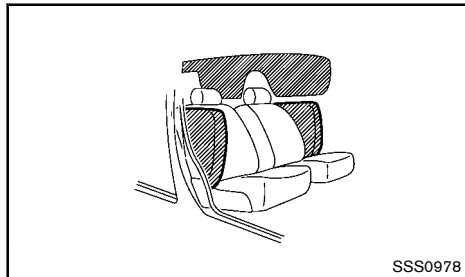

The supplemental side-impact air bag is located at the outside of the front seats' seatbacks.

The supplemental side-impact air bag system is designed to inflate in higher severity side collisions, although it may inflate if the forces in another type of

collision are similar to those of a higher severity side impact. It may not inflate in certain side collisions. Vehicle damage (or lack of it) is not always an indication of proper supplemental side-impact air bag system operation.

#### Supplemental curtain side-impact air bag system (if equipped)

The supplemental curtain side-impact air bag is located at the roof rails.

The supplemental curtain side-impact air bag system is designed to inflate in higher severity side collisions, although it may inflate if the forces in another type of collision are similar to those of a higher severity side impact. It may not inflate in certain side collisions. Vehicle damage (or lack of it) is not always an indication of proper supplemental curtain side-impact air bag system operation.

#### PRE-TENSIONER SEAT BELT SYSTEM (if equipped)



#### WARNING:

- **The pre-tensioner seat belt cannot be re-used after activation. It must be replaced together with the retractor and buckle as a unit.**
- **If the vehicle becomes involved in a collision but the pre-tensioner is not activated, be sure to have the pre-tensioner system checked and, if necessary, replaced by a NISSAN dealer.**
- **No unauthorized changes should be made to any components or wiring of the pre-tensioner seat belt system. This is to prevent accidental activation of the pre-tensioner seat belt or damage to the pre-tensioner**

#### seat belt system.

- **Work around or on the pre-tensioner seat belt system should be done by a NISSAN dealer. The SRS wiring should not be modified or disconnected. Unauthorized electrical test equipment and probing devices should not be used on the pre-tensioner seat belt system.**
- **If you need to dispose of the pre-tensioner seat belt system, or scrap the vehicle, contact a NISSAN dealer. Correct pre-tensioner disposal procedures are set forth in the appropriate NISSAN Service Manual. Incorrect disposal procedures could cause personal injury.**

The pre-tensioner seat belt system may activate with the supplemental air bag system in certain types of collisions.

Working with the seat belt retractor, it helps tighten the seat belt when the vehicle becomes involved in certain types of collisions, helping to restrain front seat occupants.

The pre-tensioner is encased with the front seat belt's retractor and anchor. These seat belts are used the same as conventional seat belts.

When the pre-tensioner seat belt activates, a fairly loud noise may be heard, followed by the release of smoke. This smoke is not harmful and does not indicate a fire. Care should be taken not to inhale it, as it may cause irritation and choking. Those with a history of a breathing condition should get fresh air promptly.

## REPAIR AND REPLACEMENT PROCEDURE



### **WARNING:**

- **Once the air bags have been inflated, the air bag modules will not function and must be replaced. The air bag modules must be replaced by a NISSAN dealer. The inflated air bag modules cannot be repaired.**
- **The air bag systems should be inspected by a NISSAN dealer if there is any damage to the front end or side portion of the vehicle.**
- **If you need to dispose of the SRS or scrap the vehicle, contact a NISSAN dealer. Correct disposal procedures are set forth in the appropriate NISSAN Service Manual. Incorrect disposal procedures could cause personal injury.**

The air bags are designed to activate on a one-time-only basis. As a reminder, unless the SRS air bag warning light is damaged, the SRS air bag warning light remains illuminated after inflation has occurred. The repair and replacement of the SRS should be done only by a NISSAN dealer.

When maintenance work is required on the vehicle, information about the air bags and related parts should be pointed out to the person performing the maintenance. The ignition switch should always be in the "LOCK" position when working under the hood or inside the vehicle.

# 2 Instruments and controls

Instrument panel .....	2-2	Battery saver system .....	2-34
Left-Hand Drive (LHD) model .....	2-2	Headlight aiming control (if equipped) .....	2-34
Right-Hand Drive (RHD) model (Type A) .....	2-3	Turn signal switch .....	2-35
Right-Hand Drive (RHD) model (Type B) .....	2-4	Fog light switch (if equipped) .....	2-36
Right-Hand Drive (RHD) model (Type C) .....	2-5	Front fog lights .....	2-36
Meters and gauges .....	2-6	Rear fog light .....	2-36
Speedometer and odometer .....	2-8	Wiper and washer switch .....	2-37
Trip computer (for Type A and B) .....	2-9	Windshield wiper and washer switch .....	2-37
Tachometer (if equipped) .....	2-10	Rain-sensing auto wiper system (if equipped) .....	2-38
Fuel gauge .....	2-10	Rear window wiper and washer switch (if equipped) .....	2-38
Automatic Transmission (AT)/Continuously Variable Transmission (CVT) position indicator (if equipped) .....	2-10	Defogger switch (if equipped) .....	2-39
Engine start operation indicator (if equipped) .....	2-11	Horn .....	2-40
Warning/indicator lights and audible reminders .....	2-12	Windows .....	2-40
Checking bulbs .....	2-13	Manual windows (if equipped) .....	2-40
Warning lights .....	2-13	Power windows (if equipped) .....	2-40
Indicator lights .....	2-16	Sunshade (if equipped) .....	2-42
Audible reminders .....	2-18	Clock .....	2-42
Vehicle information display (if equipped) .....	2-20	Adjusting time .....	2-42
Indicators for operation .....	2-20	Power outlets (if equipped) .....	2-43
Warnings and alerts .....	2-22	Storages .....	2-44
Indicators for birthday and anniversary .....	2-24	Glove box .....	2-44
Indicators for maintenance .....	2-25	Upper instrument box (if equipped) .....	2-44
Indicators for Stop/Start System (if equipped for Europe) .....	2-26	Card holder (if equipped) .....	2-44
Trip computer (for Type C) .....	2-26	Cup holders .....	2-44
Stop/Start System (CO2 savings ) (if equipped for Europe) .....	2-31	Tonneau board (if equipped) .....	2-45
Tire angle indicator (if equipped) .....	2-31	Sun visors .....	2-45
Headlight and turn signal switch .....	2-33	Interior lights .....	2-46
Headlight switch .....	2-33	Room light .....	2-46
		Front map lights (if equipped) .....	2-46



# INSTRUMENT PANEL

## LEFT-HAND DRIVE (LHD) MODEL

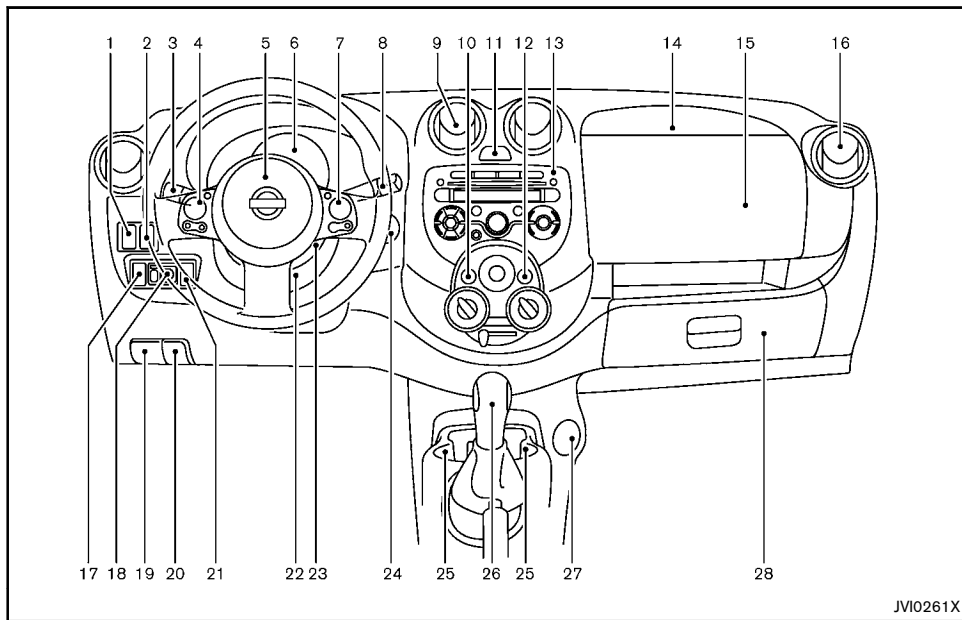

Example

- |   |  |
|---|--|
| <ol style="list-style-type: none"> <li>1. Vehicle Dynamic Control (VDC) OFF switch* or Electronic Stability Program (ESP) OFF switch*</li> <li>2. Parking space measurement switch*</li> <li>3. Headlight, fog light* and turn signal switch</li> <li>4. Steering-wheel-mounted controls (left side)*             <ul style="list-style-type: none"> <li>— Audio control*</li> <li>— Bluetooth® Hands-Free Phone System control (without navigation system)*</li> </ul> </li> </ol> | <ol style="list-style-type: none"> <li>5. Driver's front-impact air bag/Horn</li> <li>6. Meters and gauges</li> <li>7. Steering-wheel-mounted controls (right side)*             <ul style="list-style-type: none"> <li>— Cruise control switches*</li> <li>— Speed limiter switches*</li> </ul> </li> </ol> |
|---|--|

8. Wiper and washer switch
9. Center ventilator
10. Rear window defogger switch\*
11. Hazard indicator flasher switch
12. Heater and air conditioner\* control
13. Audio system\* or Navigation system\*\*
14. Passenger's front-impact air bag\*
15. Upper instrument box\*
16. Side ventilator
17. Headlight aiming control switch\*
18. Outside rearview mirror control switch\*
19. Fuel filler lid release handle
20. Hood lock release handle
21. Stop/Start System OFF switch\*
22. Tilting steering wheel lock lever
23. Ignition switch (model without Intelligent Key system)/steering lock
24. Push-button ignition switch (model with Intelligent Key system)
25. Cup holder
26. Shift lever
  - Automatic Transmission (AT) model
  - Continuously Variable Transmission (CVT) model
  - Manual Transmission (MT) model
27. Power outlet\* or USB/AUX connector (with navigation system)\*\*
28. Glove box

\*: if equipped

\*\* : Refer to the separate NISSAN Connect Owner's Manual (if equipped).

## RIGHT-HAND DRIVE (RHD) MODEL (Type A)

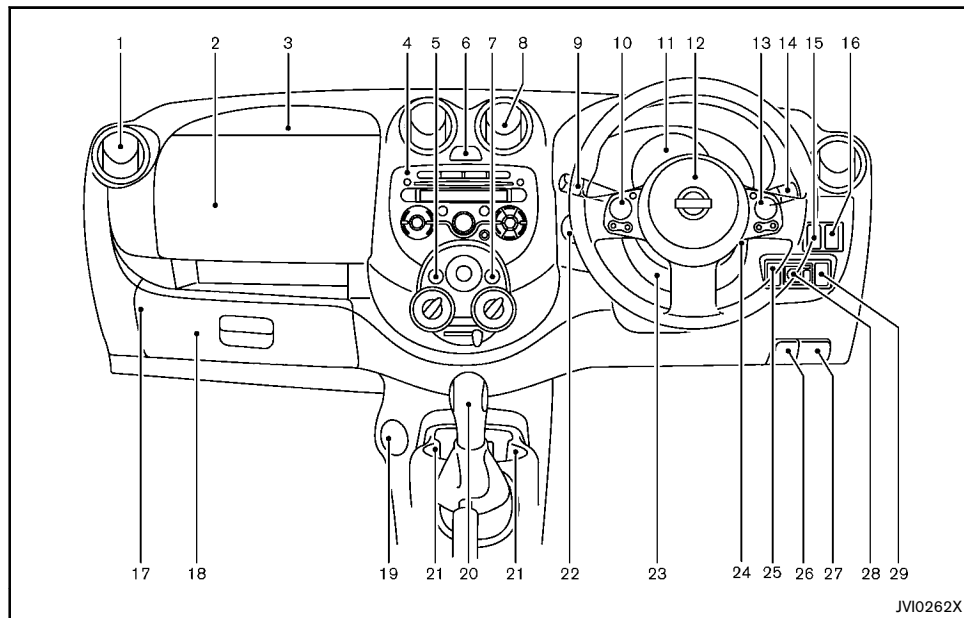

### Example

- |  |   |
|--|---|
| <ol style="list-style-type: none"> <li>1. Side ventilator</li> <li>2. Upper instrument box*</li> <li>3. Passenger's front-impact air bag*</li> <li>4. Audio system* or Navigation system**</li> <li>5. Rear window defogger switch*</li> <li>6. Hazard indicator flasher switch</li> <li>7. Heater and air conditioner* control</li> <li>8. Center ventilator</li> </ol> | <ol style="list-style-type: none"> <li>9. Wiper and washer switch or Headlight, fog light and turn signal switch</li> <li>10. Steering-wheel-mounted controls (left side)*                     <ul style="list-style-type: none"> <li>— Audio control*</li> <li>— Bluetooth® Hands-Free Phone System control (without navigation system)*</li> <li>— Bluetooth® Hands-Free Phone System control (with navigation system)**</li> </ul> </li> </ol> |
|--|---|

11. Meters and gauges
12. Driver's front-impact air bag\*/Horn
13. Steering-wheel-mounted controls (right side)\*
  - Cruise control switches\*
  - Speed limiter switches\*
14. Headlight, fog light\* and turn signal switch or Wiper and washer switch
15. Parking space measurement switch\*
16. Vehicle Dynamic Control (VDC) OFF switch\* or Electronic Stability Program (ESP) OFF switch\*
17. Fuse box
18. Glove box
19. Power outlet\* or USB/AUX connector (with navigation system)\*\*
20. Shift lever
  - Automatic Transmission (AT) model
  - Continuously Variable Transmission (CVT) model
  - Manual Transmission (MT) model
21. Cup holder
22. Push-button ignition switch (model with Intelligent Key system)
23. Tilting steering wheel lock lever
24. Ignition switch (model without Intelligent Key system)/steering lock
25. Stop/Start System OFF switch\*
26. Hood lock release handle
27. Fuel filler lid release handle
28. Outside rearview mirror control switch\*
29. Headlight aiming control switch\*

\*: if equipped

\*\* : Refer to the separate NISSAN Connect Owner's Manual (if equipped).

## RIGHT-HAND DRIVE (RHD) MODEL (Type B)

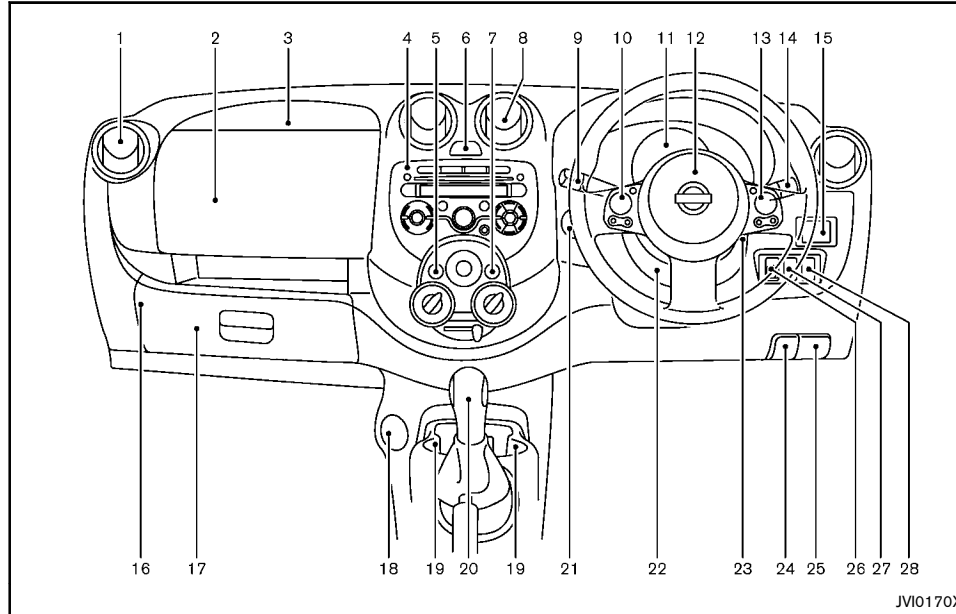

### Example

- |   |   |
|---|---|
| 1. Side ventilator                      | 9. Wiper and washer switch  |
| 2. Upper instrument box*                | 10. Steering-wheel-mounted controls (left side)*                          |
| 3. Passenger's front-impact air bag*    | — Audio control*  |
| 4. Audio system* or Navigation system** | — Bluetooth® Hands-Free Phone System control (without navigation system)* |
| 5. Rear window defogger switch*         | — Bluetooth® Hands-Free Phone System control (with navigation system)**   |
| 6. Hazard indicator flasher switch      | 11. Meters and gauges   |
| 7. Heater and air conditioner* control  |   |
| 8. Center ventilator                    |   |

12. Driver's front-impact air bag\*/Horn
13. Steering-wheel-mounted controls (right side)\*
  - Cruise control switches\*
  - Speed limiter switches\*
14. Headlight, fog light\* and turn signal switch
15. Outside rearview mirror control switch\*
16. Fuse box
17. Glove box
18. Power outlet\* or USB/AUX connector (with navigation system)\*\*
19. Cup holder
20. Shift lever
  - Automatic Transmission (AT) model
  - Continuously Variable Transmission (CVT) model
  - Manual Transmission (MT) model
21. Push-button ignition switch (model with Intelligent Key system)
22. Tilting steering wheel lock lever
23. Ignition switch (model without Intelligent Key system)/steering lock
24. Hood lock release handle
25. Fuel filler lid release handle
26. Parking space measurement switch\*
27. Vehicle Dynamic Control (VDC) OFF switch\*
28. Headlight aiming control switch\*

\*: if equipped

\*\* : Refer to the separate NISSAN Connect Owner's Manual (if equipped).

## RIGHT-HAND DRIVE (RHD) MODEL (Type C)

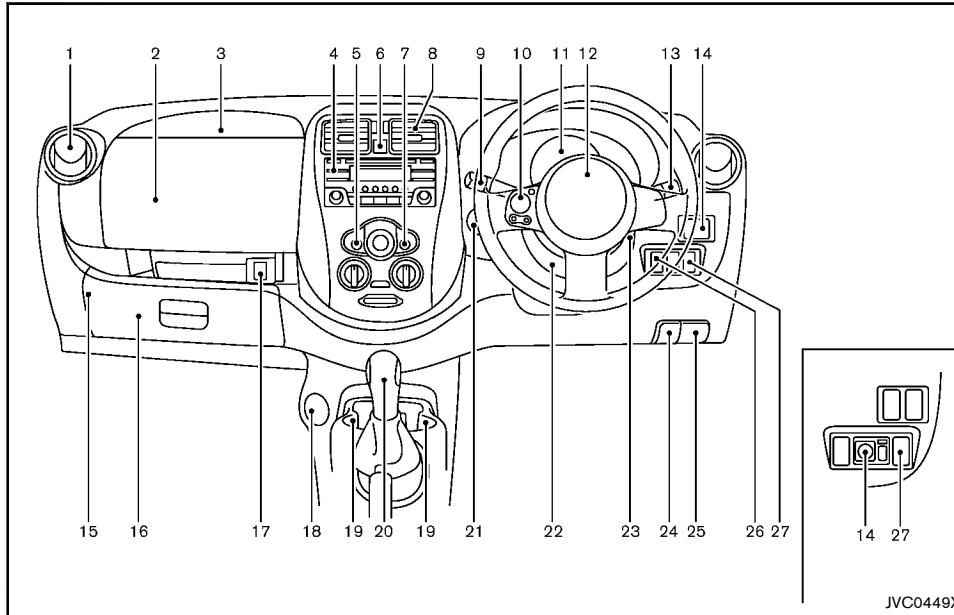

### Example

- |  |  |
|--|--|
| 1. Side ventilator                     | 9. Wiper and washer switch                       |
| 2. Upper instrument box*               | 10. Steering-wheel-mounted controls (left side)* |
| 3. Passenger's front-impact air bag*   | — Audio control*                                 |
| 4. Audio system*                       | — Bluetooth® Hands-Free Phone System control*    |
| 5. Rear window defogger switch*        | 11. Meters and gauges                            |
| 6. Hazard indicator flasher switch     | 12. Driver's front-impact air bag*/Horn          |
| 7. Heater and air conditioner* control | 13. Headlight, fog light* and turn signal switch |
| 8. Center ventilator                   |  |

14. Outside rearview mirror control switch\*
  15. Fuse box
  16. Glove box
  17. USB/AUX connector\*
  18. Power outlet\*
  19. Cup holder
  20. Shift lever
    - Continuously Variable Transmission (CVT) model
    - Manual Transmission (MT) model
  21. Push-button ignition switch (model with Intelligent Key system)
  22. Tilting steering wheel lock lever
  23. Ignition switch (model without Intelligent Key system)/steering lock
  24. Hood lock release handle
  25. Fuel filler lid release handle
  26. Idling Stop OFF switch\*
  27. Headlight aiming control switch\*
- \*: if equipped

## METERS AND GAUGES

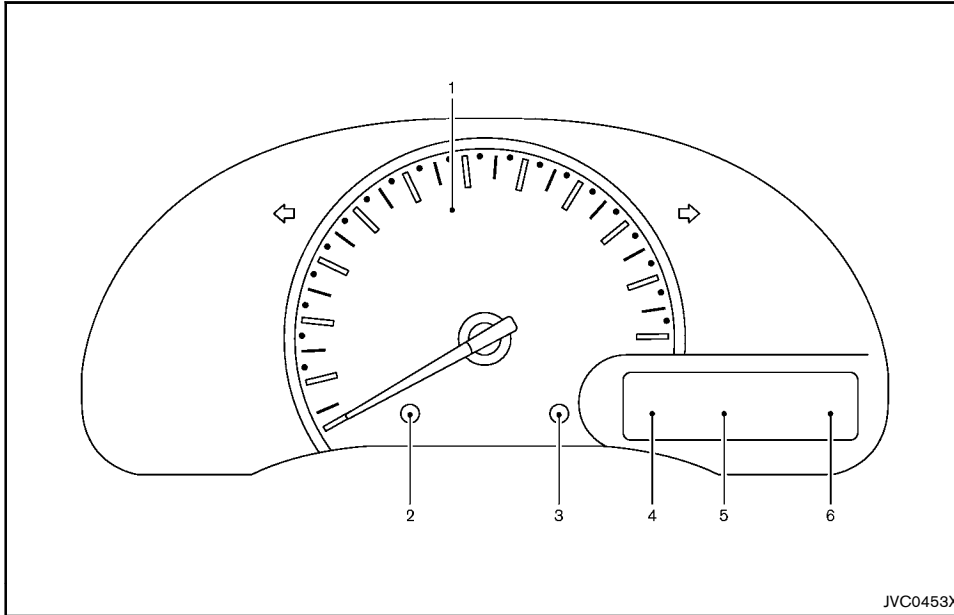

**Type A**

1. Speedometer
2. Trip odometer reset switch/trip computer mode switch
3. Clock adjusting knob
4. Automatic Transmission (AT) position indicator\*
5. Odometer/twin trip odometer/trip computer/clock
6. Fuel gauge

\*: if equipped

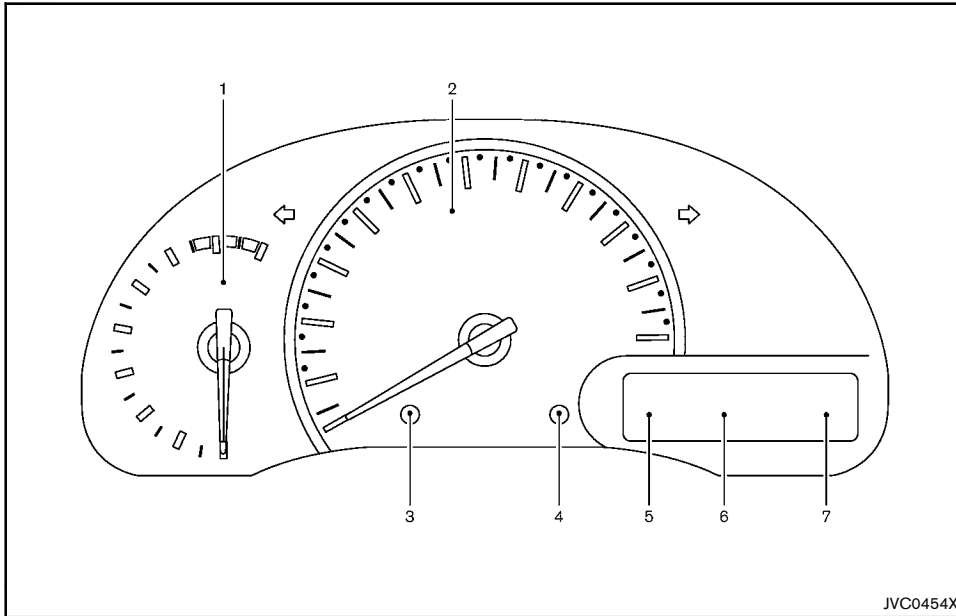

JVC0454X

**Type B**

- |   |                |
|---|----------------|
| 1. Tachometer   | 7. Fuel gauge  |
| 2. Speedometer  | *: if equipped |
| 3. Trip odometer reset switch/trip computer mode switch   |                |
| 4. Clock adjusting knob   |                |
| 5. Automatic Transmission (AT)/Continuously Variable Transmission (CVT) position indicator*/Cruise control and speed limiter display* |                |
| 6. Odometer/twin trip odometer/trip computer/clock  |                |

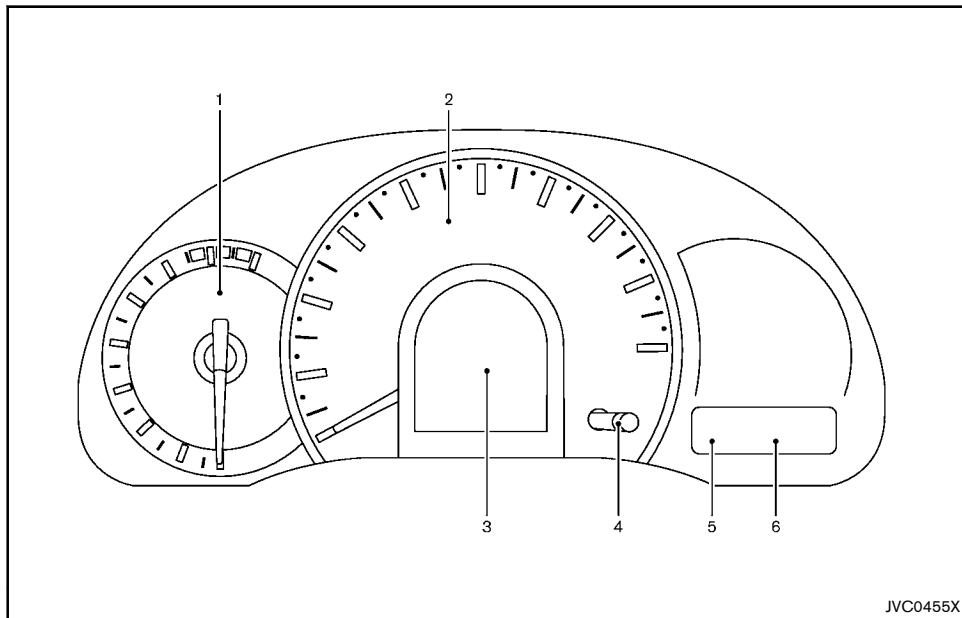

**Type C**

JVC0455X

1. Tachometer
2. Speedometer
3. Vehicle information display
4. Trip odometer reset switch
5. Automatic Transmission (AT)/Continuously Variable Transmission (CVT) position indicator\*
6. Odometer/twin trip odometer/clock

\*: if equipped

## SPEEDOMETER AND ODOMETER

### Speedometer

The speedometer indicates the vehicle speed.

### Odometer/Twin trip odometer (for Type A and B)

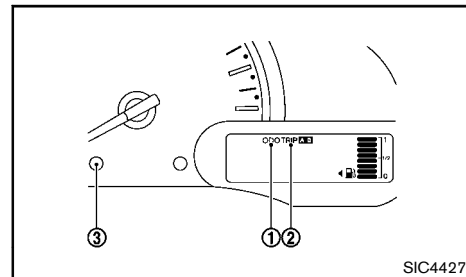

SIC4427

#### Example

The odometer/twin trip odometer is displayed when the ignition switch is in the "ON" position.

The odometer ① displays the total distance the vehicle has been driven.

The twin trip odometer ② displays the distance of individual trips.

#### Changing twin trip odometer display:

Push the reset switch ③ to change the display as follows:

TRIP A → TRIP B → Trip computer mode → TRIP A

#### Resetting twin trip odometer:

Push the reset switch ③ for more than 1 second to reset the trip odometer to zero.

For trip computer information, see "Trip computer (for Type A and B)" (P.2-9).

## Odometer/Twin trip odometer (for Type C)

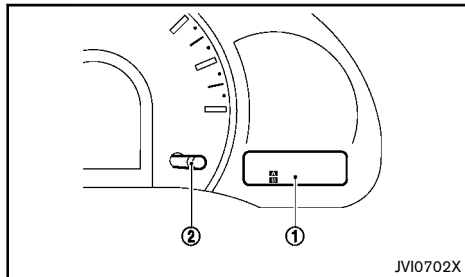

### Example

The odometer/twin trip odometer is displayed when the ignition switch is in the "ON" position.

The odometer ① displays the total distance the vehicle has been driven. When the odometer displays, the display of TRIP A and B disappears.

The twin trip odometer ① displays the distance of individual trips.

### Changing twin trip odometer display:

Push the reset switch ② to change the display as follows:

ODO → TRIP A → TRIP B → ODO

### Resetting twin trip odometer:

Push the reset switch ② for more than 1 second to reset the trip odometer to zero.

For trip computer information, see "Trip computer (for Type C)" (P.2-26).

## TRIP COMPUTER (for Type A and B)

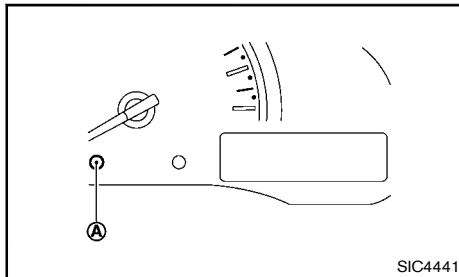

The switch for the trip computer is located on the meter panel.

When the ignition switch is placed in the "ON" position, modes of the trip computer can be selected by pushing the trip computer mode switch ①.

Each time the trip computer mode switch ① is pushed, the display will change as follows:

ODO → (TRIP A → TRIP B) → Current fuel consumption → Average fuel consumption → Distance to empty (dte)

Current fuel consumption (l/100 km, km/l or mpg)

The current fuel consumption mode shows the current fuel consumption.

Average fuel consumption (l/100 km, km/l or mpg)

The average fuel consumption mode shows the average fuel consumption since the last reset. Resetting is done by pushing the trip computer mode switch ① for longer than 1 second.

The display is updated every 30 seconds. At about the first 500 m after a reset, the display shows "----".

Distance to empty (dte — km or mls)

The distance to empty (dte) mode provides you with an estimation of the distance that can be driven before refueling. The dte is constantly being calculated, based on the amount of fuel in the fuel tank and the actual fuel consumption.

The display is updated every 30 seconds.

The dte mode includes a low range warning feature: when the fuel level is low, the dte mode is automatically selected and the digits blink in order to draw the driver's attention. Push the trip computer mode switch ① to return to the mode that was selected before the warning occurred.

When the fuel level drops even lower, the dte display will change to "----".

- If the amount of fuel added is small, the display just before the ignition switch is turned off may continue to be displayed.
- When driving uphill or rounding curves, the fuel in the tank shifts, which may momentarily change the display.



## Resetting displays

When the average fuel consumption or TRIP B is displayed, push the trip computer mode switch **(A)** for longer than 3 seconds. The display of average fuel consumption and trip odometer (TRIP B only) will be reset at the same time.

## TACHOMETER (if equipped)

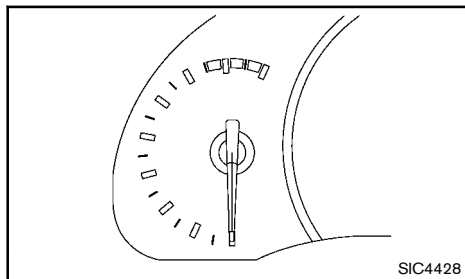

The tachometer indicates the engine speed in revolutions per minute (rpm).

**Do not rev the engine into the red zone.**

## FUEL GAUGE

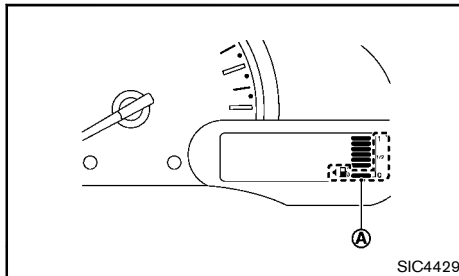

**Example of Type A and B**

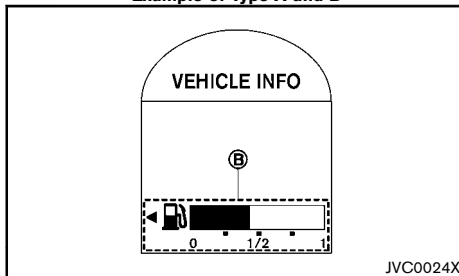

**Type C**

For Type A and B: The fuel gauge **(A)** indicates the approximate fuel level in the tank when the ignition switch is in the "ON" position.

The gauge may move slightly during braking, turning, accelerating, or going up and down hills due to movement of fuel in the tank.

The fuel gauge **(A)** and the low fuel warning light in the meter (if equipped) blink when the fuel level in the tank is getting low. Refuel as soon as it is convenient, before the gauge reads 0.

For Type C: The fuel gauge **(B)** indicates the

approximate fuel level in the tank when the ignition switch is in the "ON" position.

The gauge may move slightly during braking, turning, accelerating, or going up and down hills due to movement of fuel in the tank.

The low fuel warning light in the meter illuminates when the fuel level in the tank is getting low. Refuel as soon as it is convenient, before the gauge reads 0.

The arrow, , indicates the fuel filler lid is located on the left side of the vehicle.



## **CAUTION:**

**Refuel before the gauge reads the empty (0) position.**

## AUTOMATIC TRANSMISSION (AT)/CONTINUOUSLY VARIABLE TRANSMISSION (CVT) POSITION INDICATOR (if equipped)

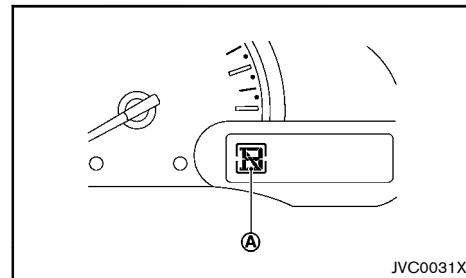

**Example**

The Automatic Transmission (AT)/Continuously Variable Transmission (CVT) position indicator **(A)** indicates the shift lever position when the ignition switch is in the "ON" position.



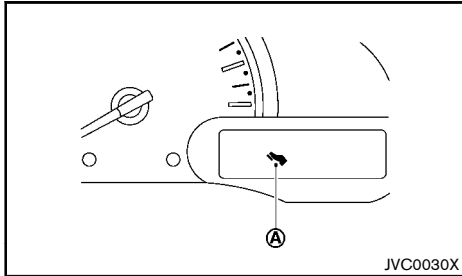

































## ENGINE START OPERATION INDICATOR (if equipped)



### Example





The engine start operation indicator (A) appears when the shift lever is in the "P" (Park) position. This indicator means that the engine will start by pushing the ignition switch with the brake pedal depressed. You can start the engine directly in any position.









## WARNING/INDICATOR LIGHTS AND AUDIBLE REMINDERS

	Anti-lock Braking System (ABS) warning light*		Speed [120 km/h (75 MPH)] warning light (for the Middle East)		Overdrive off indicator light*
			Supplemental Restraint System (SRS) air bag warning light*		Rear fog light indicator light*
	Brake warning light		Water-in-fuel-filter warning light (diesel engine model)		Security indicator light*
	Charge warning light		Vehicle Dynamic Control (VDC) warning light (for Australia and New Zealand)		Slip indicator light (if equipped except for Australia and New Zealand)
	Door open warning light*		Cruise control on indicator light*		Speed limiter indicator light*
	Electric power steering warning light		Cruise control/speed limiter set indicator light*		SPORT mode indicator light*
	Engine oil pressure warning light		Electronic Stability Program (ESP) off indicator light*		Stop/Start System indicator light (if equipped for Europe)/Idling Stop System indicator light (for Hong Kong)
	High temperature warning light (red)		Front fog lights indicator light*		Turn signals/hazard indicator lights
	Intelligent Key system warning light*		Front passenger air bag status light*		Vehicle Dynamic Control (VDC) off indicator light*
	Low fuel warning light*		Glow plug indicator light (diesel engine model)		Vehicle Dynamic Control (VDC) off indicator light*
	Malfunction warning light (red) (diesel engine model)		High beam indicator light		
	Master warning light*		Low temperature indicator light (green)*		
	P position selecting warning light*		Malfunction Indicator Light (MIL)		
	Seat belt warning light*				

\*: if equipped

## CHECKING BULBS

With all doors closed, apply the parking brake, fasten the seat belts and turn the ignition switch to the "ON" position without starting the engine. The following lights will illuminate: , , , , **PS**.

If equipped, the following lights will illuminate briefly and then turn off:  or **ABS**, **SPORT**, , , ,  (red),  (green), , , .

If any lights fail to illuminate, it may indicate a burned-out bulb or an open circuit in the electrical system. Have the system checked, and if necessary repaired, by a NISSAN dealer promptly.

Some indicators and warnings are also displayed on the vehicle information display (if equipped) below the speedometer. (See "Vehicle information display" (P.2-20).)

## WARNING LIGHTS

 **ABS** Anti-lock Braking System (ABS) warning light (if equipped)

When the ignition switch is in the "ON" position, the Anti-lock Braking System (ABS) warning light illuminates and then turns off. This indicates the ABS is operational.

If the ABS warning light illuminates while the engine is running, or while driving, it may indicate the ABS is not functioning properly. Have the system checked by a NISSAN dealer promptly.

If an ABS malfunction occurs, the anti-lock function is turned off. The brake system then operates normally, but without anti-lock assistance. (See "Brake system" (P.5-38).)

 Brake warning light



### WARNING:

- **If the brake fluid level is below the minimum mark on the brake fluid reservoir, do not drive the vehicle until the brake system has been checked by a NISSAN dealer.**
- **Even if you judge it to be safe, have your vehicle towed because driving it could be dangerous.**
- **Depressing the foot brake pedal without the engine running and/or with a low brake fluid level could increase the stopping distance and require greater pedal travel distance and effort.**

The brake warning light indicates the parking brake system operation, a low brake fluid level of the brake system and an Anti-lock Braking System (ABS) malfunction.

### Parking brake warning indicator:

When the ignition switch is in the "ON" position, and the parking brake is applied, the brake warning light illuminates. When the parking brake is released, the brake warning light turns off.

If the parking brake is not fully released, the brake warning light remains on. Be sure that the brake warning light has turned off before driving. (See "Parking brake" (P.3-24).)

### Low brake fluid warning indicator:

If the brake warning light illuminates while the engine is running, or while driving, and the parking brake is released, it may indicate the brake fluid level is low.

When the brake warning light illuminates while driving, stop the vehicle safely as soon as possible. Stop the

engine and check the brake fluid level. If the brake fluid level is below the minimum mark on the reservoir, add brake fluid as necessary. (See "Brake fluid" (P.8-19).)

If the brake fluid level is sufficient, have the brake system checked by a NISSAN dealer promptly.

### Anti-lock Braking System (ABS) warning indicator (if equipped):

When the parking brake is released and the brake fluid level is sufficient, if both the brake warning light and the Anti-lock Braking System (ABS) warning light illuminate, it may indicate the ABS is not functioning properly. Have the brake system checked, and if necessary repaired, by a NISSAN dealer promptly. (See "Anti-lock Braking System (ABS) warning light" (P.2-13).)

 Charge warning light

When the ignition switch is in the "ON" position, the charge warning light illuminates. After starting the engine, the charge warning light turns off. This indicates the charging system is operational.

If the charge warning light illuminates while the engine is running, or while driving, it may indicate the charging system is not functioning properly and may need servicing.

When the charge warning light illuminates while driving, stop the vehicle safely as soon as possible. Stop the engine and check the alternator belt. If the alternator belt is loose, broken or missing, the charging system needs repair. (See "Drive belts" (P.8-16).)

If the alternator belt appears to be functioning correctly but the charge warning light remains illuminated, have the charging system checked by a NISSAN dealer promptly.

**CAUTION:**

**Do not continue driving if the alternator belt is loose, broken or missing.**



Door open warning light (if equipped)

When the ignition switch is in the “ON” position, the door open warning light illuminates if any of the doors are open or not closed securely.



Electric power steering warning light

When the ignition switch is in the “ON” position, the electric power steering warning light illuminates. After starting the engine, the electric power steering warning light turns off. This indicates the electric power steering system is operational.

If the electric power steering warning light illuminates while the engine is running, it may indicate the electric power steering system is not functioning properly and may need servicing. Have the electric power steering system checked by a NISSAN dealer.

When the electric power steering warning light illuminates with the engine running, the power assist to the steering will cease operation but you will still have control of the vehicle. At this time, greater steering efforts are required to operate the steering wheel, especially in sharp turns and at low speeds.

(See “Electric power steering system” (P.5-37).)



Engine oil pressure warning light

When the ignition switch is in the “ON” position, the engine oil pressure warning light illuminates. After starting the engine, the engine oil pressure warning light turns off. This indicates that the oil pressure sensors in the engine are operational.

If the engine oil pressure warning light illuminates or blinks while the engine is running, it may indicate that the engine oil pressure is low.

Stop the vehicle safely as soon as possible. Stop the engine immediately and call a NISSAN dealer.

**CAUTION:**

- **Running the engine with the engine oil pressure warning light illuminated could cause serious damage to the engine.**
- **The engine oil pressure warning light is not designed to indicate a low oil level. The oil level should be checked using the dipstick. (See “Engine oil” (P.8-11).)**



High temperature warning light (red)

When the ignition switch is in the “ON” position, the high temperature warning light illuminates and then turns off. This indicates that the high temperature sensor in the engine coolant system is operational.

**CAUTION:**

**If the high temperature warning light illuminates while the engine is running, it may indicate the engine temperature is extremely high.**

**Stop the vehicle safely as soon as possible.**

**If the vehicle is overheated, continuing vehicle operation may seriously damage the engine.**

**(For the immediate action required, see “If your vehicle overheats” (P.6-11).)**



Intelligent Key system warning light (if equipped)

After the ignition switch is placed in the “ON” position, this light comes on for about 2 seconds and then turns off.

This light illuminates or blinks as follows:

- The light blinks in yellow when the door is closed with the Intelligent Key left outside the vehicle and the ignition switch in the “ACC” or “ON” position. Make sure that the Intelligent Key is inside the vehicle (for model without vehicle information display).
- The light blinks in green when the Intelligent Key battery is running out of power. Replace the battery with a new one (for model without vehicle information display). See “Battery” (P.8-24).
- The light illuminates in yellow when it warns of a malfunction with the electrical steering lock system or the Intelligent Key system.

If the warning light illuminates in yellow while the engine is stopped, it may be impossible to free the steering lock or to start the engine. If the light comes on while the engine is running, you can drive the vehicle. However in these cases, contact a NISSAN dealer for repair as soon as possible.



### Low fuel warning light (if equipped)

The low fuel warning light illuminates when the fuel level in the tank is getting low. Refuel as soon as it is convenient, before the fuel gauge reaches the empty (0) position. There will be a small reserve of fuel remaining in the tank when the fuel gauge reaches the empty (0) position.



### Malfunction warning light (red) (diesel engine model)

When the ignition switch is placed in the "ON" position, the malfunction warning light illuminates in red. This means that the system is operational. After starting the engine, the warning light turns off.

For the orange Malfunction Indicator Light (MIL), see "Malfunction Indicator Light (MIL)" (P.2-17) for details.

If the malfunction warning light (red) illuminates continuously while the engine is running, it may indicate an engine control system malfunction. Have your vehicle inspected by a NISSAN dealer. You do not need to have your vehicle towed to the dealer.



### CAUTION:

**Continuing vehicle operation without proper servicing of the engine control system could lead to poor driveability, reduced fuel economy, and damage to the engine control system, which may affect the vehicle's warranty coverage.**



### Master warning light (if equipped)

When the ignition switch is in the "ON" position, the master warning light illuminates if any of the following are displayed on the vehicle information display.

- Seat belt warning
- NO KEY warning
- Low fuel warning
- Parking brake release warning
- Door/back door open warning

(See "Vehicle information display" (P.2-20).)



### P position selecting warning light (if equipped)

The warning light blinks in red when the ignition switch is pushed to stop the engine with the shift lever in any position except the "P" (Park) position.

If this warning appears, move the shift lever to the "P" (Park) position or push the ignition switch to the "ON" position.

An inside warning chime will also sound.

See "Intelligent Key system" (P.3-9).



### Seat belt warning light (if equipped)

When the ignition switch is in the "ON" position, the seat belt warning light illuminates. The light will continue to illuminate until the driver's seat belt is fastened. (See "Seat belts" (P.1-7).)

When the vehicle speed exceeds 15 km/h (10 MPH), the light will blink and the chime (if equipped) will sound unless the driver's seat belt is securely fastened. The chime (if equipped) will continue to sound for about 90 seconds until the seat belt is fastened.



### Speed [120 km/h (75 MPH)] warning light (for the Middle East)

This light blinks when the vehicle speed goes over approximately 120 km/h (75 MPH). Be sure to observe the speed limit in the area where you are driving.



### Supplemental Restraint System (SRS) air bag warning light (if equipped)

When the ignition switch is in the "ON" or "START" position, the Supplemental Restraint System (SRS) air bag warning light illuminates for about 7 seconds and then turns off. This indicates that the SRS air bag system is operational.

If any of the following conditions occur, the SRS air bag system and/or pre-tensioner seat belt need servicing. Have the system checked, and if necessary repaired, by a NISSAN dealer promptly.

- The SRS air bag warning light remains illuminated after about 7 seconds.
- The SRS air bag warning light flashes intermittently.
- The SRS air bag warning light does not illuminate at all.

Unless checked and repaired, the SRS air bag system and/or pre-tensioner seat belt may not function properly. (See "Supplemental Restraint System (SRS)" (P.1-25))



### Water-in-fuel-filter warning light (diesel engine model)

If the water-in-fuel-filter warning light illuminates while the engine is running, drain the water from the fuel filter promptly. (See "Fuel filter (diesel engine model)" (P.8-16).)



## CAUTION:

**Continuing vehicle operation without properly draining could cause serious damage to the engine.**



Vehicle Dynamic Control (VDC) warning light (for Australia and New Zealand)

When the ignition switch is in the “ON” position, the VDC warning light illuminates and then turns off. This indicates the Vehicle Dynamic Control (VDC) system is operational.

The VDC warning light blinks when the VDC system is operating.

When the warning light blinks while driving, the driving condition is slippery and the vehicle’s traction limit is about to be exceeded.

If the VDC warning light illuminates while the engine is running or while driving, it may indicate the VDC system is not functioning properly and may need servicing. Have the system checked, and if necessary repaired, by a NISSAN dealer promptly.

If a malfunction occurs in the system, the VDC system function will be canceled but the vehicle is still driveable.

See “Vehicle Dynamic Control (VDC) system (for Australia and New Zealand)” (P.5-25).

## INDICATOR LIGHTS



Cruise control on indicator light (if equipped)

The cruise control on indicator light indicates the activation of the cruise control system.

When the cruise control main switch is turned on, the indicator light will illuminate, indicating the cruise control system is in the standby mode. (See “Cruise control” (P.5-30).)



Cruise control/speed limiter set indicator light (if equipped)

The cruise control/speed limiter set indicator light indicates the status of the cruise control system.

When the vehicle speed is controlled by the cruise control/speed limiter system, the indicator light illuminates.

If the cruise control/speed limiter set indicator light blinks while the engine is running, or while driving, it may indicate the cruise control/speed limiter system is not functioning properly and may need servicing. Have the system checked, and if necessary repaired, by a NISSAN dealer promptly. (See “Cruise control” (P.5-30) and “Speed limiter (if equipped for Europe)” (P.5-28).)



Electronic Stability Program (ESP) off indicator light (if equipped)

The Electronic Stability Program (ESP) off indicator light illuminates when the ESP off switch is pushed to the “OFF” position.

When the ESP off switch is pushed to the “OFF” position, the ESP system is turned off.

If the ESP off indicator light and slip indicator light

illuminate while the engine is running or while driving, it may indicate the ESP system is not functioning properly and may need servicing. Have the system checked, and if necessary repaired, by a NISSAN dealer promptly. (See “Electronic Stability Program (ESP) System (if equipped for Europe)” (P.5-27).)



Front fog lights indicator light (if equipped)

The front fog lights indicator light illuminates when the front fog lights are on. (See “Fog light switch” (P.2-36).)



Front passenger air bag status light (if equipped)

The front passenger air bag status light located on the meter will illuminate when the front passenger air bag is turned off with the front passenger air bag switch. When the front passenger air bag is turned on, the front passenger air bag status light will turn off.

For more details, see “Supplemental Restraint System (SRS)” (P.1-25).



Glow plug indicator light (diesel engine model)

When the ignition switch is in the “ON” position, the glow plug indicator light illuminates and turns off after the glow plugs have warmed up.

If the glow plugs have already warmed up, the glow plug indicator flashes briefly and then turns off.

### High beam indicator light

The high beam indicator light illuminates when the headlight high beam is "ON". The indicator turns off when the low beam is selected. (See "Headlight and turn signal switch" (P.2-33).)

### Low temperature indicator light (green) (if equipped)

The low temperature indicator light illuminates when the engine coolant temperature is low.

When the ignition switch is in the "ON" position, the low temperature indicator light illuminates and then turns off after the engine coolant has warmed up.

If the low temperature indicator light stays illuminated after the engine has sufficiently warmed up, it may indicate the low temperature sensor in the engine coolant system is not functioning properly and may need servicing. Have the system checked, and if necessary repaired, by a NISSAN dealer promptly.

### Malfunction Indicator Light (MIL)

When the ignition switch is in the "ON" position, the Malfunction Indicator Light (MIL) illuminates. After starting the engine, the MIL turns off. This indicates that the engine control system is operational.

If the MIL illuminates or blinks (if equipped) while the engine is running, it may indicate that the engine control system is not functioning properly and may need servicing. Have the system checked, and if necessary repaired, by a NISSAN dealer promptly.

#### **Malfunction Indicator Light (MIL) on steady:**

An engine control system malfunction has been detected. Have the vehicle checked, and if necessary repaired, by a NISSAN dealer promptly. You do not need to have your vehicle towed to the dealer.

#### **Malfunction Indicator Light (MIL) blinking (if equipped):**

An engine misfire has been detected which may damage the engine control system. Have the vehicle checked, and if necessary repaired, by a NISSAN dealer promptly.

To reduce or avoid possible damage to the engine control system when the MIL illuminates or blinks:

- Avoid driving at speeds above 70 km/h (43 MPH).
- Avoid sudden acceleration or deceleration.
- Avoid going up steep uphill grades.
- Avoid carrying or towing unnecessary loads.



#### **CAUTION:**

- **Continuing vehicle operation without proper servicing of the engine control system could lead to poor driveability, reduced fuel economy, and damage to the engine control system, which may affect the vehicle's warranty coverage.**
- **Incorrect setting of the engine control system may lead to non-compliance of local and national emission laws and regulations.**

### Overdrive off indicator light (if equipped)

The overdrive off indicator light illuminates when the overdrive is turned OFF. (For the use of the overdrive off switch, see "Driving with Automatic Transmission (AT)" (P.5-11).)

### Rear fog light indicator light (if equipped)

The rear fog light indicator light illuminates when the rear fog light is on. (See "Fog light switch" (P.2-36).)

### Security indicator light (if equipped)

The security indicator light blinks when the ignition switch is in the "LOCK", "OFF" or "ACC" position. This function indicates the security system equipped on the vehicle is operational.

If the security system is malfunctioning, this light will remain on while the ignition switch is in the "ON" position. (For additional information, see "Security system" (P.3-17).)

### Slip indicator light (if equipped except for Australia and New Zealand)

When the ignition switch is in the "ON" position, the slip indicator light illuminates and then turns off. This indicates that the Vehicle Dynamic Control (VDC) system or Electronic Stability Program (ESP) system is operational.

The slip indicator light blinks when the VDC or ESP system is operating.

When the indicator light blinks while driving, the driving condition is slippery and the vehicle's traction limit is about to be exceeded.

If the VDC or ESP off indicator light and slip indicator



light illuminate while the engine is running or while driving, it may indicate that the VDC or ESP system is not functioning properly and may need servicing. Have the system checked, and if necessary repaired, by a NISSAN dealer promptly. (See “Vehicle Dynamic Control (VDC) system (if equipped except for Europe, Australia and New Zealand)” (P.5-24) or “Electronic Stability Program (ESP) System (if equipped for Europe)” (P.5-27).)

 Speed limiter indicator light (if equipped)

This light illuminates when the speed limiter main switch is pushed. The light turns off when the main switch is pushed again. When the speed limiter main switch indicator light illuminates, the speed limiter system is operational. (See “Speed limiter (if equipped for Europe)” (P.5-28).)

 SPORT mode indicator light (if equipped)

The SPORT mode indicator light illuminates when the SPORT mode is turned “ON”. (For the use of the SPORT mode switch, see “Driving with Continuously Variable Transmission (CVT)” (P.5-14).)

 Stop/Start System indicator light (if equipped for Europe)/Idling Stop System indicator light (for Hong Kong)

#### For Europe:

The Stop/Start System indicator light illuminates in the meter when the Stop/Start System is activated.

The Stop/Start System indicator light blinks at a high speed, when the engine hood is open (for CVT model).

The Stop/Start System indicator light blinks at a low speed, when the Stop/Start System is malfunctioning.

## 2-18 Instruments and controls

#### NOTE:

- **When the Stop/Start System indicator light blinks at a high speed (twice approximately every 1 second), be sure to close the engine hood. When the engine hood is open the engine will be in the normal stopped state. In this case, restart the engine with the ignition switch (for CVT model).**
- **When the Stop/Start System indicator light blinks at a low speed (once approximately every 1 second), have the system checked, and if necessary repaired, by a NISSAN dealer promptly.**

#### For Hong Kong:

The Idling Stop System indicator light illuminates in the meter when the Idling Stop System is activated or is in the ready state.

The Idling Stop System indicator light blinks at a high speed when the engine hood is open.

The Idling Stop System indicator light blinks at a low speed, when the Idling Stop System is malfunctioning.



#### NOTE:

- **When the Idling Stop System indicator light blinks at a high speed (twice approximately every 1 second), be sure to check if the engine hood is open. When the engine hood is opened the engine will be in the normal stopped state. In this case, restart the engine with the ignition switch.**
- **When the Idling Stop System indicator light blinks at a low speed (once approximately every 2 seconds), have the system checked, and if necessary repaired, by a NISSAN dealer promptly.**

- **Even if the Idling Stop System indicator light illuminates before stopping your vehicle, the Idling Stop System may not activate when you are driving on an uphill or downhill grade, or when the steering wheel is operated, etc.**

 Turn signals/hazard indicator lights

The turn signals/hazard indicator lights blink when the turn signal switch lever or hazard indicator flasher switch is “ON”. (See “Headlight and turn signal switch” (P.2-33) or “Hazard indicator flasher switch” (P.6-2).)

  Vehicle Dynamic Control (VDC) off indicator light (if equipped)

The Vehicle Dynamic Control (VDC) off indicator light illuminates when the VDC off switch is pushed to the “OFF” position.

When the VDC off switch is pushed to the “OFF” position, the VDC system is turned off.

See “Vehicle Dynamic Control (VDC) system (if equipped except for Europe, Australia and New Zealand)” (P.5-24) or “Vehicle Dynamic Control (VDC) system (for Australia and New Zealand)” (P.5-25).

#### AUDIBLE REMINDERS

##### Brake pad wear warning

The disc brake pads have audible wear warnings. When a brake pad requires replacement, it will make a high pitched scraping sound when the vehicle is in motion. This scraping sound will first occur only when the brake pedal is depressed. After more wear of the brake pad, the sound will always be heard even if the brake pedal is not depressed. Have the brakes checked as soon as possible if the wear warning

sound is heard.

Have the system checked, and if necessary repaired, by a NISSAN dealer promptly. (See “Brakes” (P.8-18).)

### Intelligent Key buzzer (if equipped)

The Intelligent Key buzzer sounds if any one of the following improper operations is found.

- The ignition switch is not returned to the “LOCK” position when locking the doors.
- The Intelligent Key is left inside the vehicle when locking the doors.
- Any doors are not closed securely when locking the doors.

When the buzzer sounds, be sure to check both the vehicle and the Intelligent Key. (See “Intelligent Key system” (P.3-9).)

### Key reminder chime

The key reminder chime will sound if any of the following operations are detected:



Model with Intelligent Key system:

- The driver’s door is opened while the ignition switch is in the “ACC” position.

Model without Intelligent Key system:

- The driver’s door is opened while the key is left in the ignition switch and the ignition switch is in the “OFF” position.

### Light reminder chime

The light reminder chime will sound if the driver’s door is opened while the headlight switch is in the  or  position and the ignition switch is in the “ACC”, “OFF” or “LOCK” position.

Be sure to turn the light switch to the “OFF” position when you leave the vehicle.

### Parking brake reminder chime

The parking brake reminder chime will sound if the vehicle is driven at more than 7 km/h (4 MPH) with the parking brake applied. Stop the vehicle and release the parking brake.

### Seat belt warning chime (if equipped)

When the vehicle speed exceeds 15 km/h (9 MPH), the chime will sound unless the driver’s seat belt is securely fastened. The chime will continue to sound for about 90 seconds until the seat belt is fastened.

### Stop/Start System reminder buzzer (if equipped for Europe)

The Stop/Start System reminder buzzer will sound if the engine hood is opened (for CVT and MT models) or the driver’s door is opened or the driver’s seat belt is unfastened (for MT models) while the Stop/Start System is activated.

#### NOTE:

- **Be sure to close the engine hood. When the engine hood is open, the engine will be in the normal stopped state. In this case, restart the engine with the ignition switch (for CVT and MT models).**
- **Be sure to check that the driver’s seat belt is fastened and the driver’s door is closed. When the driver’s seat belt is unfastened or the driver’s door is open, the engine will be**

**in the normal stopped state. In this case, restart the engine with the ignition switch (for MT model).**

### Idling Stop System reminder buzzer (for Hong Kong)

The Idling Stop System reminder buzzer will sound if the engine hood is opened while the Idling Stop System is activated.

#### NOTE:

**Be sure to check if the engine hood is open. When the engine hood is opened the engine will be in the normal stopped state. In this case, restart the engine with the ignition switch.**

### Reverse reminder chime (if equipped)

The chime will sound inside the vehicle to remind the driver if the selector lever is in the “R” (Reverse) position while the ignition switch is in the “ON” position. This is not a chime to remind people outside the vehicle.

## VEHICLE INFORMATION DISPLAY (if equipped)

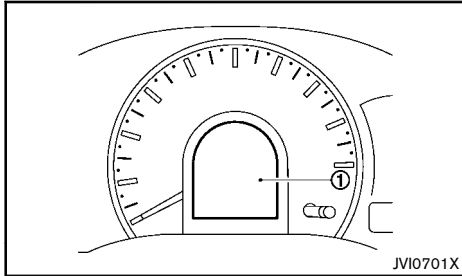

The vehicle information display ① displays the warnings and information.

## INDICATORS FOR OPERATION

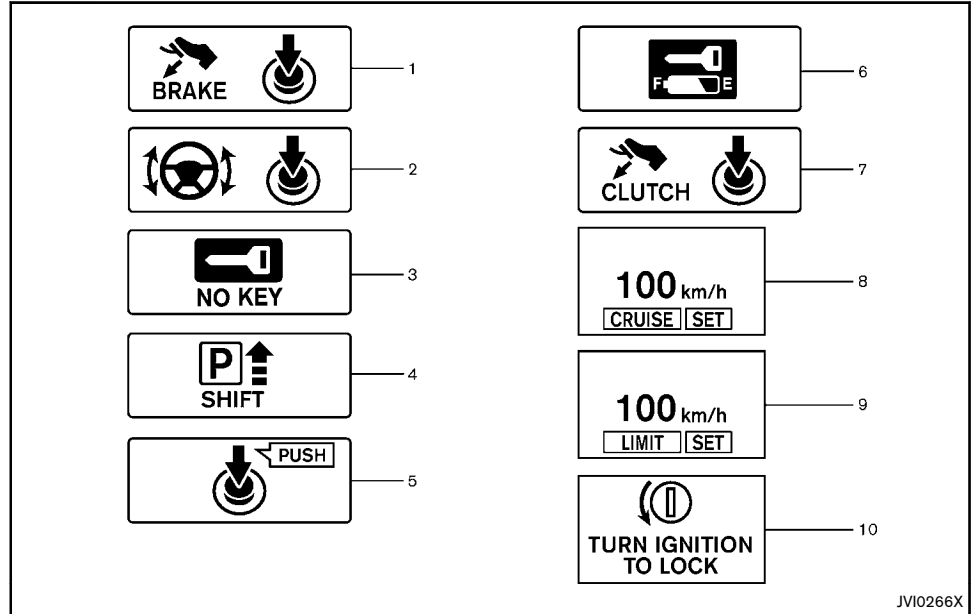

### 1. Engine start operation indicator (AT/CVT model)

This indicator appears when the shift lever is in the “P” (Park) position.

This indicator means that the engine will start by pushing the ignition switch with the brake pedal depressed. You can start the engine directly in any position.

### 2. Steering lock release malfunction indicator

This indicator appears when the steering wheel cannot be released from the “LOCK” position.

If this indicator appears, push the ignition switch while lightly turning the steering wheel right and left.

### 3. NO KEY warning

This warning appears in either of the following conditions.

#### No key inside the vehicle:

The warning appears when the door is closed with the Intelligent Key left outside the vehicle and the ignition switch in the "ACC" or "ON" position. Make sure that the Intelligent Key is inside the vehicle.

#### Unregistered Intelligent Key:

The warning appears when the ignition switch is pushed from the "LOCK" position and the Intelligent Key cannot be recognized by the system. You cannot start the engine with an unregistered key. Use the registered Intelligent Key.

For more details, see "Intelligent Key system" (P.3-9).

### 4. SHIFT "P" warning (AT/CVT model)

This warning appears when the ignition switch is pushed to stop the engine with the shift lever in any position except the "P" (Park) position.

If this warning appears, move the shift lever to the "P" (Park) position or push the ignition switch to the "ON" position.

An inside warning chime will also sound. (See "Intelligent Key system" (P.3-9).)

### 5. "PUSH" warning (AT/CVT model)

This warning appears when the shift lever is moved to the "P" (Park) position with the ignition switch in the "ACC" position after the SHIFT "P" warning appears.

To push the ignition switch to the "OFF" position, perform the following procedure:

**SHIFT "P" warning** → (Move the shift lever to "P") →

**PUSH warning** → (Push the ignition switch → ignition switch position is turned to "ON") → **PUSH**

**warning** → (Push the ignition switch → ignition switch position is turned to "OFF")

### 6. Intelligent Key battery discharge indicator

This indicator appears when the Intelligent Key battery is running out of power.

If this indicator appears, replace the battery with a new one. (See "Battery" (P.8-24).)

### 7. Engine start operation indicator (Manual Transmission models)

This indicator means that the engine will start by pushing the ignition switch with the clutch pedal depressed.

### 8. Cruise control indicator (for Europe)

The cruise main switch indicator (CRUISE) is displayed when the cruise control main switch is pushed. When the main switch is pushed again, the CRUISE indicator disappears. When the CRUISE indicator is displayed, the cruise control system is operational.

The cruise control set indicator (SET) is displayed while the vehicle speed is controlled by the cruise control system. If the SET indicator blinks while the engine is running, it may indicate that the cruise control system is not functioning properly. Have the system checked by a NISSAN dealer.

For more details, see "Cruise control" (P.5-30).

### 9. Speed limiter indicator (for Europe)

The speed limiter main switch indicator (LIMIT) is displayed when the speed limiter main switch is pushed. When the main switch is pushed again, the LIMIT indicator disappears.

The speed limiter set indicator (SET) is displayed while the speed limiter is activated.

For more details, see "Speed limiter (if equipped for

Europe)" (P.5-28).

### 10. Mechanical Key LOCK warning (if equipped for Europe)

The warning appears when the ignition switch is left in the "ACC" or "OFF" position instead of completely being turned to the "LOCK" position.

If this warning appears, turn the ignition switch to the "LOCK" position.

When the ignition switch is in the "ON" position, a buzzer will sound twice and the Mechanical Key LOCK warning shows when the ignition switch is turned to the "ACC" or "OFF" position. This is to warn the driver that the ignition switch is not in the "LOCK" position. Make sure the shift lever is in the "P" (Park) position (for CVT model) or the shift lever is in the "N" (Neutral) position (for MT model) and then turn the ignition switch to the "LOCK" position.



#### CAUTION:

- **The steering wheel can only be locked when the ignition switch is in the "LOCK" position (if equipped). Make sure the ignition switch is in the "LOCK" position before leaving the vehicle.**
- **The mechanical key can only be removed at the "LOCK" position. Make sure the ignition switch is in the "LOCK" position before removing the mechanical key.**

For further details, see "Ignition switch (model without intelligent Key system)" (P.5-5).

## WARNINGS AND ALERTS

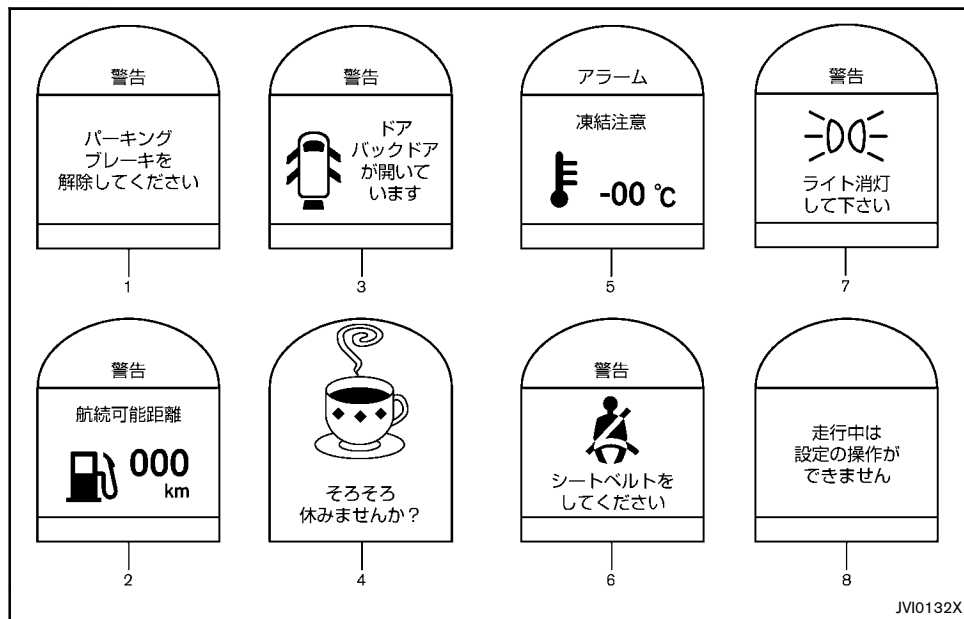

Type A

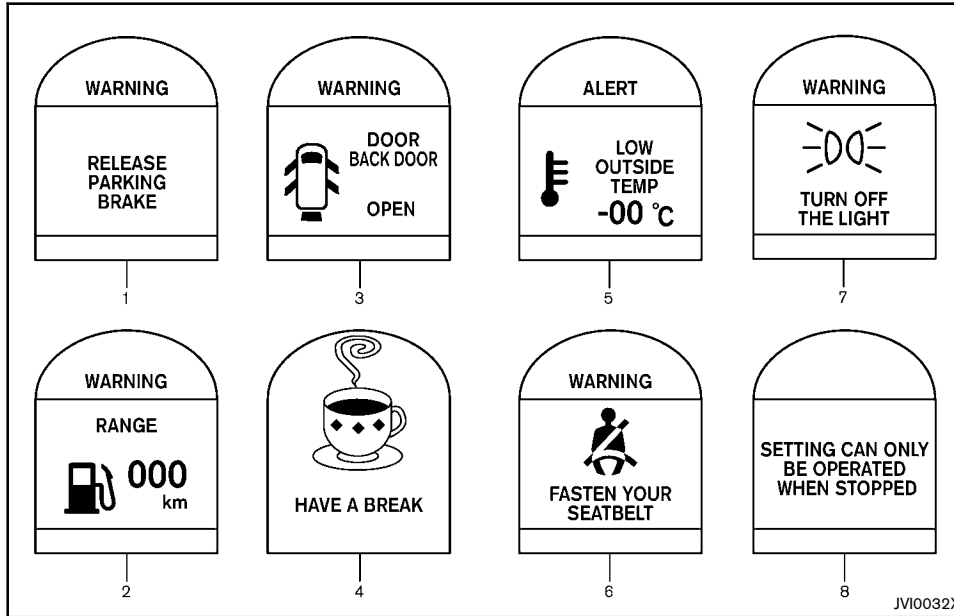

### 1. Parking brake release warning

This warning appears when the vehicle speed is above 7 km/h (4 MPH) and the parking brake is applied.

### 2. Low fuel warning

This warning appears when the fuel level in the tank is getting low. Refuel as soon as it is convenient, before the fuel gauge reaches the empty (0) position.

**There is a small reserve of fuel remaining in the tank when the fuel gauge reaches the empty (0) position.**

### 3. Door/back door open warning (ignition switch is in the ON position)

This warning appears if any of the doors or the back door is open or not closed securely. The vehicle icon indicates which door is open on the display. Make sure that all of the doors and the back door are closed.

### 4. "Time to rest" indicator

This indicator appears when the set "time to rest" indicator activates. You can set the time for up to 6 hours. (See "Trip computer (for Type C)" (P.2-26).)

### 5. Low outside temperature warning

This warning appears if the outside temperature is 3°C or below. The warning can be set not to be displayed. (See "Trip computer (for Type C)" (P.2-26).)

### 6. Seat belt warning light

When the ignition switch is in the "ON" position, the seat belt warning light illuminates. The light will continue to illuminate until the front seat belt is fastened. (See "Seat belts" (P.1-7).)

When the vehicle speed exceeds 15 km/h (10 MPH), the light will blink and the chime will sound unless the front seat belt is securely fastened. The chime will continue to sound for about 90 seconds until the seat belt is fastened.

### 7. Small light indicator warning

The small light indicator warning illuminates when the front clearance lights, instrument panel lights, rear combination lights and license plate lights are on. The indicator warning turns off when the  $\Xi\text{O}\Xi$  is turned off.

## 8. Setting menu operation warning

The warning appears when you try to operate the setting menu while driving. The setting menu can only be entered if the vehicle is stationary.

## INDICATORS FOR BIRTHDAY AND ANNIVERSARY

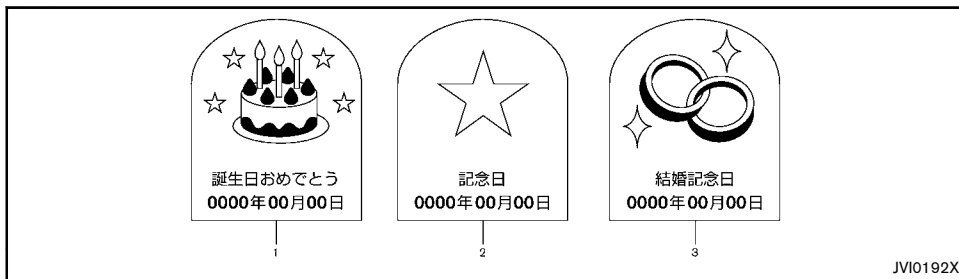

**Type A**

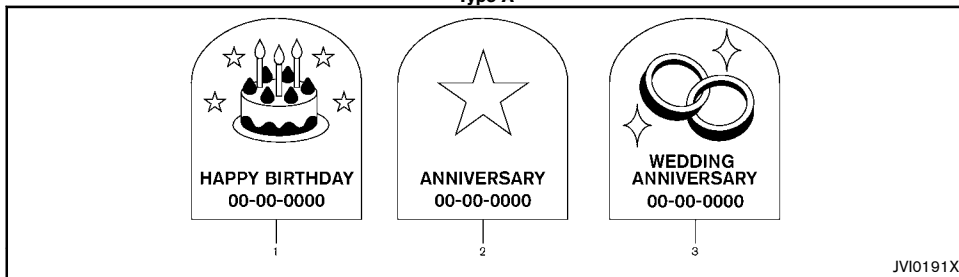

**Type B**

### 1. Birthday message

This indicator appears when the set time comes. You can adjust the date of the message. (See "Trip computer (for Type C)" (P.2-26).)

### 2. Anniversary message

This indicator appears when the set time comes. You can adjust the date of the message. (See "Trip computer (for Type C)" (P.2-26).)

### 3. Wedding anniversary message

This indicator appears when the set time comes. You can adjust the date of the message. (See "Trip computer (for Type C)" (P.2-26).)

## INDICATORS FOR MAINTENANCE

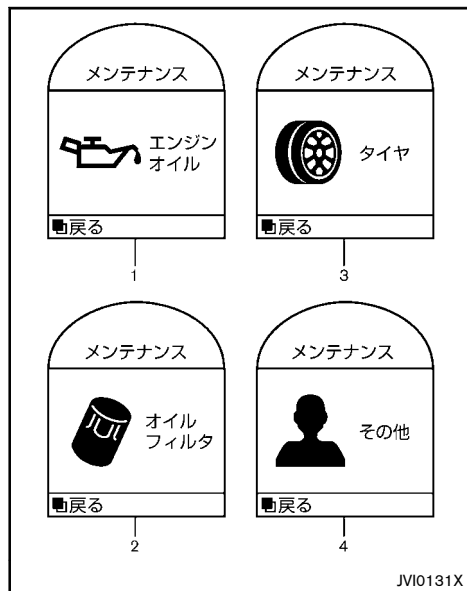

Type A

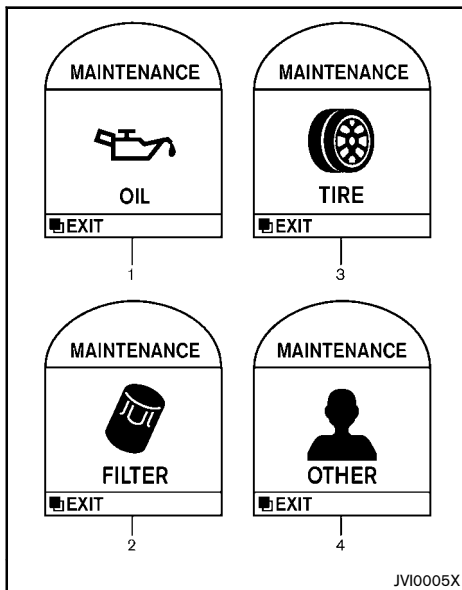

Type B

### 1. Engine oil replacement indicator

This indicator appears when the set time comes for changing the engine oil. You can set or reset the distance for changing the engine oil. (See "Trip computer (for Type C)" (P.2-26).)

### 2. Oil filter replacement indicator

This indicator appears when the set time comes for replacing the oil filter. You can set or reset the distance for replacing the oil filter. (See "Trip computer (for Type C)" (P.2-26).)

### 3. Tire replacement indicator

This indicator appears when the set time comes for replacing tires. You can set or reset the distance for replacing tires. (See "Trip computer (for Type C)" (P.2-26).)

### 4. "OTHER (その他)" indicator

This indicator appears when the set time comes for replacing items other than the engine oil, oil filter and tires. You can set or reset the distance for replacing the items. (See "Trip computer (for Type C)" (P.2-26).)



## INDICATORS FOR STOP/START SYSTEM (if equipped for Europe)

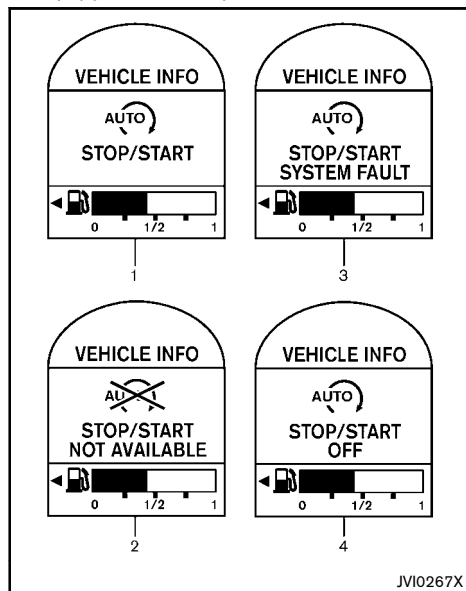

### 1. Engine stop

If the engine stops when the Stop/Start System is activated, the message is shown.

### 2. Auto start deactivation

If the engine stops when the Stop/Start System is activated, and will not start automatically, the message is shown.

### 3. System fault

If the Stop/Start System is activated, but does not operate correctly, the message is shown. Visit a NISSAN dealer or qualified workshop.

### 4. Stop/Start System



If the Stop/Start System is deactivated using the Stop/Start System OFF switch, the message is shown.

If the Stop/Start System is activated using the Stop/Start System ON switch, the "STOP/START ON" message is shown.

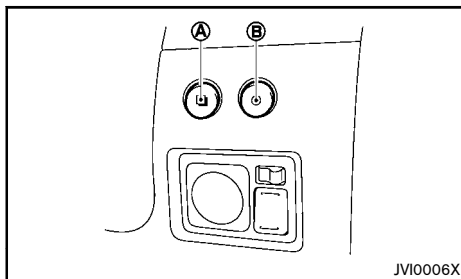
## TRIP COMPUTER (for Type C)



Switches for the trip computer are located on the left or right side of the combination meter panel. To operate the trip computer, push the switches as shown above.

- (A)  ENTER switch
- (B)  NEXT switch

When the ignition switch is pushed to the ON position, modes of the trip computer can be selected by pushing the  switch (A).

Each time the  switch (A) is pushed, the display will change as follows:

CO2 saved (if equipped) → Current fuel consumption → Average fuel consumption and speed → Elapsed time and trip odometer (if equipped) → Distance to empty → Outside air temperature → Idling stop (if equipped) → Setting → Warning check

### CO2 saved (if equipped)

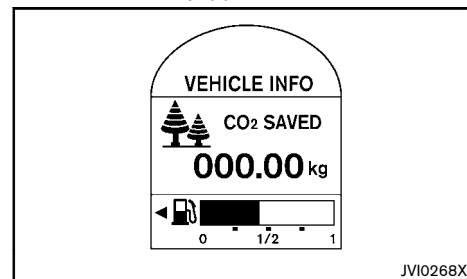

The CO2 saved mode shows the estimated quantity of CO2 exhaust emissions prevented by the Stop/Start System every time the engine is automatically stopped. For more information, see "Stop/Start System (CO2 savings) (if equipped for Europe)" (P.2-31).

Current fuel consumption (km/l or l/100 km or MPG)

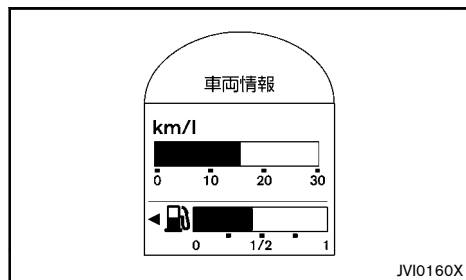

Type A

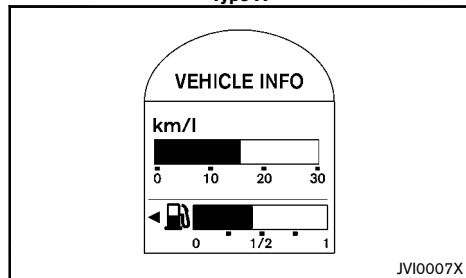

Type B

The current fuel consumption mode shows the current fuel consumption.

Average fuel consumption (km/l or l/100 km or MPG) and speed (km/h or MPH)

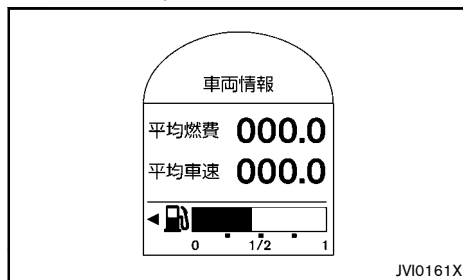

Type A

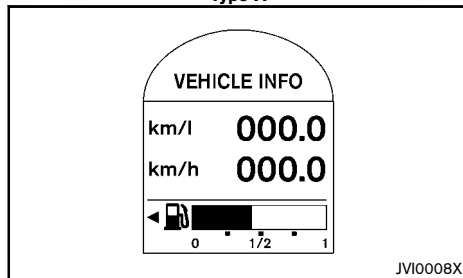

Type B

**Fuel consumption:**

The average fuel consumption mode shows the average fuel consumption since the last reset. Resetting is done by pushing the ● switch (B) for longer than 1 second. (The average speed is also reset at the same time.)

The display is updated every 30 seconds. At about the first 500 m after a reset, the display shows “—”.

**Speed:**

The average speed mode shows the average vehicle speed since the last reset. Resetting is done by pushing the ● switch (B) for longer than 1 second. (The average fuel consumption is also reset at the same time.)

The display is updated every 30 seconds. The first 30 seconds after a reset, the display shows “—”.

Elapsed time and trip odometer (km or MILES)

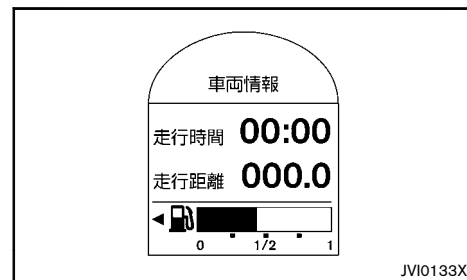

Type A

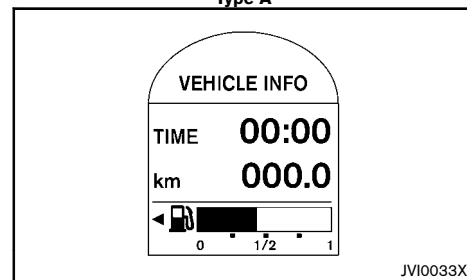

Type B

### Elapsed time (走行時間):

The elapsed time mode shows the time since the last reset. The displayed time can be reset by pushing the ● switch (B) for longer than 1 second. (The trip odometer is also reset at the same time.)

### Trip odometer (走行距離)(if equipped):

The trip odometer mode shows the distance that the vehicle has been driven since the last reset. Resetting is done by pushing the ● switch (B) for longer than 1 second. (The elapsed time is also reset at the same time.)

### Distance to empty (航続可能距離) (km or MILES)



Type A

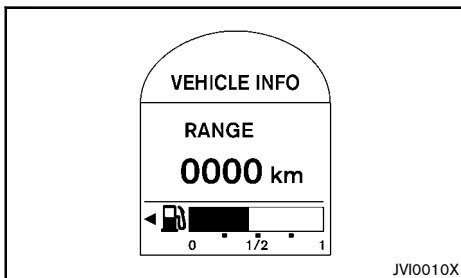

Type B

The distance to empty (dte) mode provides you with an estimation of the distance that can be driven before refueling. The dte is constantly being calculated, based on the amount of fuel in the fuel tank and the actual fuel consumption.

The display is updated every 30 seconds.

The dte mode includes a low range warning feature. If the fuel level is low, the warning is displayed on the screen.

When the fuel level drops even lower, the dte display will change to "—".

- If the amount of fuel added is small, the display just before the ignition switch is pushed to the "OFF" position may continue to be displayed.
- When driving uphill or rounding curves, the fuel in the tank shifts, which may momentarily change the display.

### Outside air temperature (外気温) (°C) (if equipped)

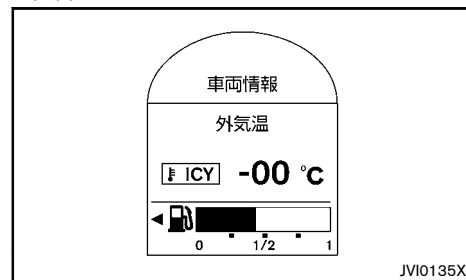

Type A

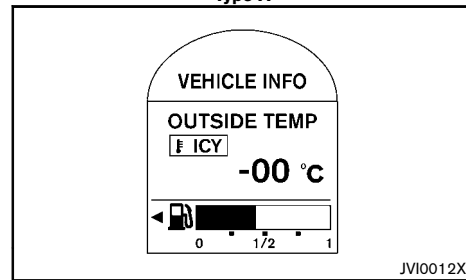

Type B

The outside air temperature is displayed in °C in the range of -30 to 60°C.

The outside air temperature mode includes a low temperature warning feature. If the outside air temperature is 3°C or below, the warning "ICY" is displayed on the screen.

The outside temperature sensor is located in front of the radiator. The sensor may be affected by road or engine heat, wind directions and other driving conditions. The display may differ from the actual outside

temperature or the temperature displayed on various signs or billboards.

Accumulated time and current saved fuel consumption (ml (milliliter)) by Idling Stop System (for Hong Kong)

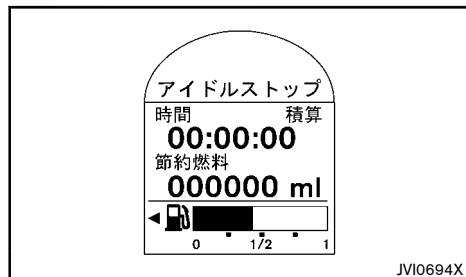

Type A

JVI0694X

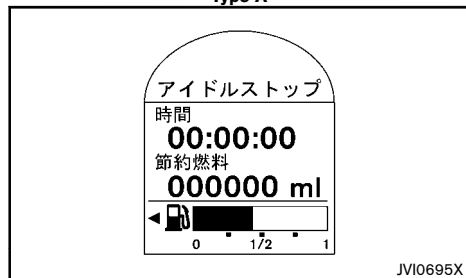

Type B

JVI0695X

The ● switch (B) is used in the setting mode to select and decide a menu of Type A and B.

### Accumulated time (Type A):

The Accumulated time mode shows the accumulated time Idling Stop System has been operated since the last reset.

Resetting is done by pushing the ● switch (B) for longer than 1 second. (The saved fuel is also reset at the same time.)

### Current saved fuel consumption (Type A):

The Current saved fuel consumption mode shows the current saved fuel consumption by Idling Stop System has been operated since the last reset.

### Accumulated time (Type B):

The Accumulated time mode shows the accumulated time Idling Stop System has been operated since the time the ignition switch was turned ON.

Resetting is done by pushing the ● switch (B) for longer than 1 second. (The saved fuel is also reset at the same time.)

### Current saved fuel consumption (Type B):

The Current saved fuel consumption mode shows the current saved fuel consumption by Idling Stop System has been operated since the time the ignition switch was turned ON. See "Idling Stop System (for Hong Kong)" (P.5-19).

## Setting (設定)

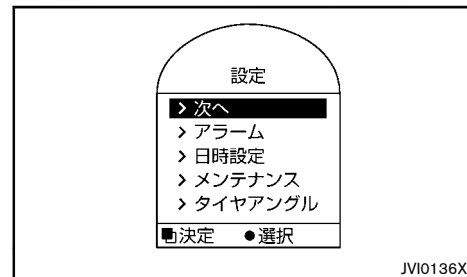

Type A

JVI0136X

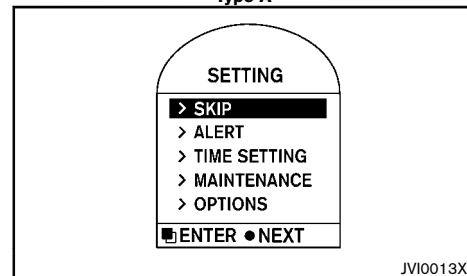

Type B (example)

JVI0013X

**Setting cannot be made while driving. A message "Setting can only be operated when stopped" is also displayed on the vehicle information display.**

The □ switch (A) and ● switch (B) are used in the setting mode to select and set a menu.

**SKIP (次へ):**

Push the  switch (A) to move to the warning check mode.

Push the  switch (B) to select other menus.

**ALERT (アラーム):**

The alert menu can be set to notify the following items.

- **TIMER (走行時間)**  
Select this submenu to specify when the "time to rest" indicator activates.
- **ICY (凍結注意)**  
Select this submenu to display the low outside temperature warning.

To return to the top page of the setting mode, select "BACK (戻る)".

**TIME SETTING (CURRENT TIME) (日時設定):**

- **CURRENT TIME (現在日時)**  
Adjust the date and time (hour and minute) of the clock on the meter.

**TIME SETTING (Birthday and Anniversary) (日時設定):**

The birthday and anniversary message reminds you of the anniversary or a birthday the driver should remember.

- **BIRTHDAY (誕生日)**  
Select this submenu to adjust the date of the Birthday message.
- **ANNIVERSARY (記念日)**  
Select this submenu to adjust the date of the Anniversary message.  
Select the display image to set the desired display image of the Anniversary message.

- **WEDDING DAY (結婚記念日)**  
Select this submenu to adjust the date of the wedding day message.

**MAINTENANCE (メンテナンス):**

The maintenance intervals of the following items can be set or reset for the reminders.

- **OIL (エンジンオイル)**  
Select this submenu to set or reset the distance for changing the engine oil.
- **FILTER (オイルフィルタ)**  
Select this submenu to set or reset the distance for replacing the oil filter.
- **TIRE (タイヤ)**  
Select this submenu to set or reset the distance for replacing tires.
- **OTHER (その他)**  
Select this submenu and set or reset the distance for replacing items other than the engine oil, oil filter and tires.

To return to the top page of the setting mode, select "BACK (戻る)".

**OPTIONS (UNIT) (except for Hong Kong):**

The option menu below can be set to your preference.

- **UNIT**  
Select this submenu to choose the unit.
- **LANGUAGE**  
Select this submenu to choose the display language.
- **STOP/START (if equipped for Europe)**  
Select this submenu to choose the CO2 savings or the engine stop time using the Stop/Start System.  
(See "Stop/Start System (CO2 savings ) (if equipped for Europe)" (P.2-31).)

To return to the top page of the setting mode, select "BACK (戻る)".

**Tire angle indicator (タイヤアングル) (for Hong Kong):**

Select this submenu to set the tire angle indicator system.

(See "Tire angle indicator" (P.2-31).)

To return to the top page of the setting mode, select "BACK (戻る)".

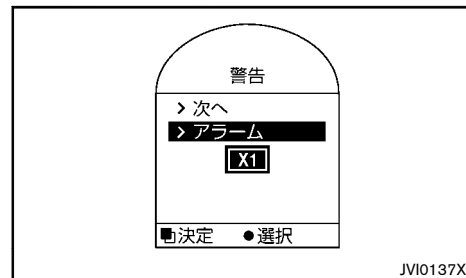
**Warning check**

Type A

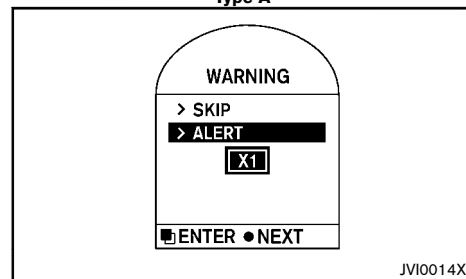

Type B

To see if there are any of the following warnings and corresponding details, select this menu.

- Seat belt warning
- No key warning
- Low fuel warning
- Parking brake release warning
- Door/back door open warning

#### SKIP (次へ):

Push the  switch (A) to move to the warning check mode.

Push the  switch (B) to select other menus.

#### ALERT (アラーム):

This item is available only when a warning is displayed.

Select this menu to see the details of warnings.

#### Resetting displays

When the average fuel consumption, average speed, elapsed time is displayed, push the trip computer mode switch (A) for longer than 3 seconds. The display of average fuel consumption, average speed, elapsed time, trip odometer, accumulated time (for Stop/Start System or Idling Stop System) and current saved fuel consumption (for Stop/Start System or Idling Stop System) will be reset at the same time.

#### STOP/START SYSTEM (CO<sub>2</sub> savings ) (if equipped for Europe)

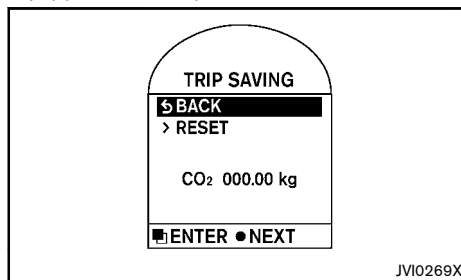

Type A

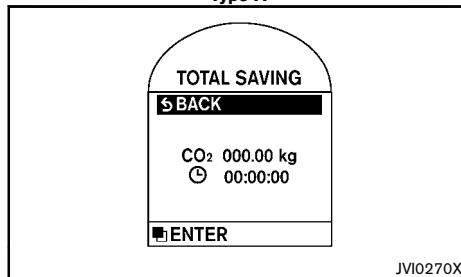

Type B

The CO<sub>2</sub> savings and the engine stop time (for Type B) using the Stop/Start System are kept in a submenu.

#### Trip Saving (Type A)

The Trip Saving mode shows the estimated CO<sub>2</sub> exhaust emissions prevented since last reset.

It is possible to reset using the [RESET] submenu then push the  switch (A) to set to zero.

#### NOTE:

**The [Trip Saving] value is the same information that is displayed when the engine is automatically stopped by the Stop/Start System.**

#### Total Saving (Type B)

The Total Saving mode shows:

- The estimated CO<sub>2</sub> exhaust emissions prevented.
- The time that the engine has been stopped by the Stop/Start System.

#### NOTE:

**The [Total Saving] values cannot be reset and show accumulated Stop/Start System information since the vehicle was built.**

#### TIRE ANGLE INDICATOR (if equipped)

This system is designed so that the driver can check the direction and angle of the tire on the display when driving the vehicle forward or backward. The display of the tire angle indicator can be set in the settings mode.

The tire angle indicator is displayed:

- when the indicator is set. It shows for about 20 seconds.
- when the shift lever is shifted to the "R" position for at least one second.

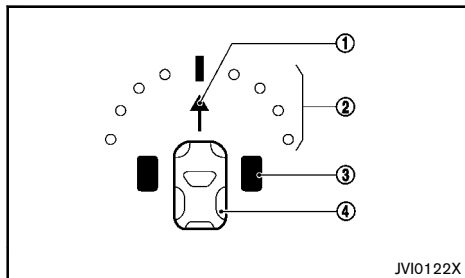

1. The direction of the vehicle is indicated by the position of the shift lever and the direction of the front tire.
2. The angle of the steering wheel and its measurement are indicated.
3. The direction of the front tire is indicated.
4. The vehicle is indicated.

### Examples of display

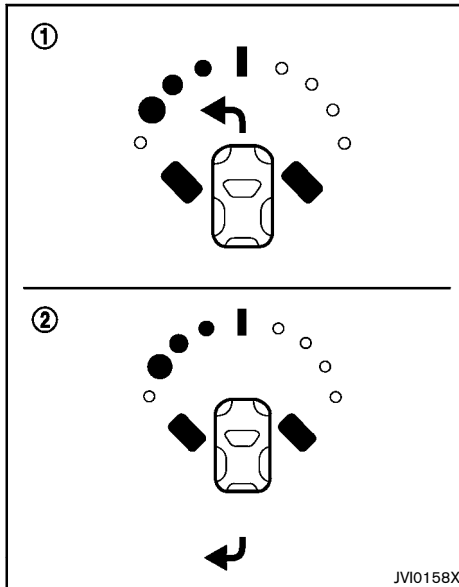

1. When steering to the left with the shift lever in the "D" or "L" position, ① indicates that the vehicle is being driven forward and to the left.
2. When steering to the left with the shift lever in the "R" position, ② indicates that the vehicle is being driven backward and to the left.

### Tire angle indicator setting

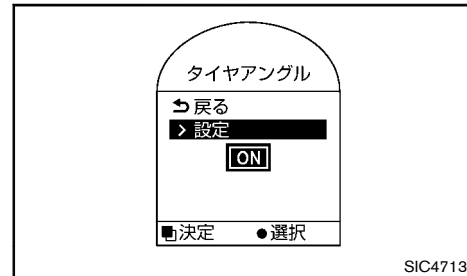

To set the tire angle indicator, push the switch (A) to select a menu in the settings mode. Then push the switch (B) to set a menu.

Push the switch (A) to select the "ON" or "OFF" setting in the tire angle settings mode.

ON: Set the tire angle indicator

OFF: Cancel the tire angle indicator

# HEADLIGHT AND TURN SIGNAL SWITCH

## HEADLIGHT SWITCH

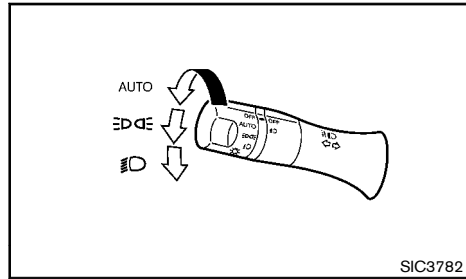

Type A

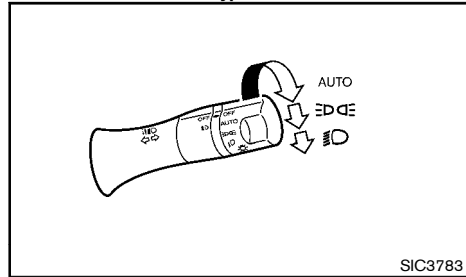

Type B

rainy weather (when the windshield wiper is operated continuously) (for Hong Kong).

When the ignition switch is turned to the "OFF" position, the lights will turn off automatically.

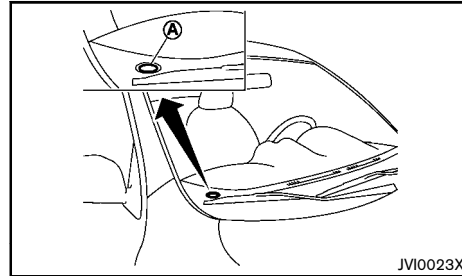

### CAUTION:

Do not place any objects on top of the sensor **(A)**. The sensor senses the brightness level and controls the autolight function. If the sensor is covered, it reacts as if it is dark, and the headlights will illuminate.

### ☰ position

The ☰ position turns on the front clearance lights, instrument panel lights, rear combination lights and other lights.

### ☰ position

The ☰ position turns on the headlights in addition to the other lights.

### Headlight beam

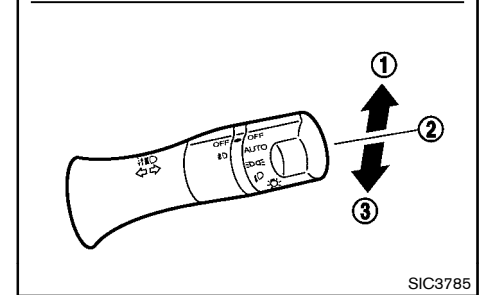
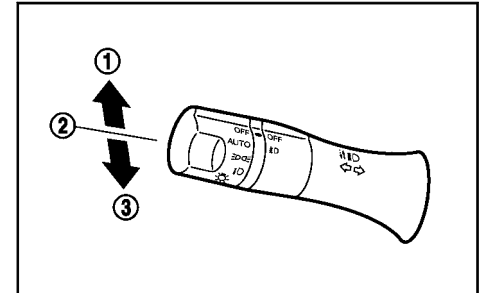

To turn on the high beam, push the lever towards the front position **(1)**.

To turn off the high beam, return the lever to the neutral position **(2)**.

To flash the headlights, pull the lever towards the rearmost position **(3)**. The headlights can be flashed even when the headlights are not on.

NISSAN recommends that you consult the local regulations concerning the use of lights.

### AUTO position (if equipped)

When the ignition switch is in the "ON" position and the headlight switch is in the "AUTO" position, the headlights, front clearance lights, instrument panel lights, rear combination light, and other lights turn on automatically depending on the brightness of the surroundings.

The headlights will turn on automatically at twilight or in



If equipped, when the lever is pulled towards the rearmost position ③ after the ignition switch is placed in the “OFF” or “LOCK” position, the headlight will turn on and stay on for 30 seconds. The lever can be pulled 4 times for up to 2 minutes.



### Daytime light system (if equipped)

Even if the headlight switch is off, the daytime lights will come on after starting the engine. However, you cannot change low beam to high beam when the light switch is off.

When the light switch is turned to the  position, the headlight low beam will turn off.



### BATTERY SAVER SYSTEM



The light reminder chime will sound if the driver’s door is opened while the following improper operations occur:

- The headlight switch is in either the  or  position, and the ignition switch in the “ACC”, “OFF” or “LOCK” position.
- The headlight switch is in the “AUTO” position and the front or rear fog light (if equipped) is turned on while the ignition switch is in the “ACC”, “OFF” or “LOCK” position.



Be sure to turn the headlight switch to the “OFF” position when you leave the vehicle.

#### Type A

When the headlight switch is in the  or  position while the engine is running, the lights will automatically turn off after pushing the ignition switch to the “ACC”, “OFF” or “LOCK” position and opening the driver’s side door.

When the headlight switch remains in either the  or  position after the lights automatically turn off, the lights will turn on when the engine is started.

#### Type B

If the doors are closed and locked with the remote controller, the Intelligent Key or the door request switch (if equipped) while the headlight switch is in either the  or  position, the battery saver function will turn off the lights to prevent the battery from being discharged. The lights will turn on when the doors are being opened.



#### CAUTION:

**Do not leave the lights on when the engine is not running for extended periods of time to prevent the battery from being discharged.**

### HEADLIGHT AIMING CONTROL (if equipped)

#### Manual type

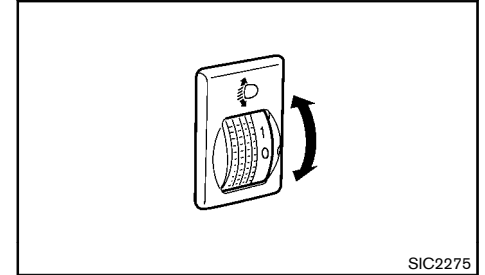

The headlight aiming control operates when the ignition switch is in the “ON” position and the headlight is on to allow the headlight axis to be adjusted according to the driving condition.

When driving with no heavy load/luggage or driving on a flat road, select the normal position “0”.

If the number of occupants and load/luggage in the vehicle changes, the headlight axis may become higher than normal.

If the vehicle is traveling on a hilly road, the headlights may directly shine on the rearview and outside mirrors of a vehicle ahead or the windshield of an oncoming vehicle, which may obscure other drivers’ vision.

To adjust to the proper aiming height, turn the switch accordingly. The higher the number, designated on the switch, the lower the headlight axis.

Select the switch position by referring to the following samples.

Switch position	Number of front seat occupants	Number of rear seat occupants	Weight of load in luggage compartment
0	1 or 2	No occupants	No load
1	2	3	No load
2	2	3	Approximately 48 kg (106 lb) Approximately 70 kg (154 lb)*2 Approximately 42 kg (93 lb)*1 Approximately 73 kg (161 lb)*2
3	1	No occupants	Approximately 279 kg (615 lb) Approximately 292 kg (644 lb)*1 Approximately 306 kg (675 lb)*2

\*1: For the Middle East

\*2: For Hong Kong

## TURN SIGNAL SWITCH

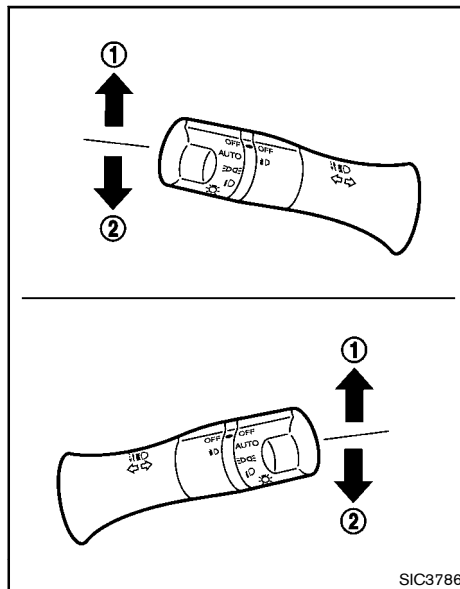

### CAUTION:

The turn signal switch will not be cancelled automatically if the steering wheel turning angle does not exceed the preset amount. After the turn or lane change, make sure that the turn signal switch is returned to its original position.

## Turn signal

To turn on the turn signals, move the lever up ① or down ② towards the desired direction. When the turn is completed, the turn signal cancels automatically.

## Lane change signal

To turn on the lane change signals, move the lever up ① or down ② towards the desired direction.

If the lever is moved back right after moving up ① or down ②, the light will flash 3 times (if equipped).

To cancel the flashing, move the lever to the opposite direction.

## FOG LIGHT SWITCH (if equipped)

### FRONT FOG LIGHTS

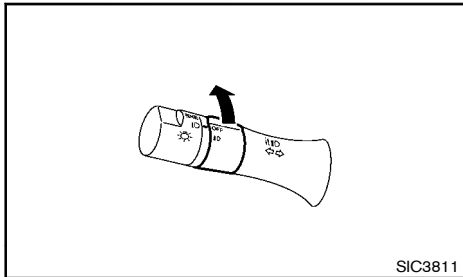

Type A

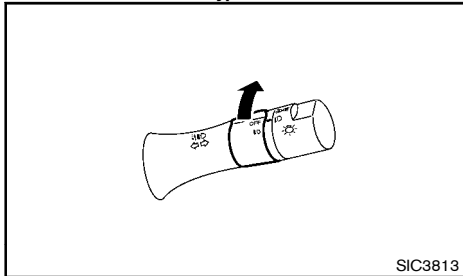

Type B

To turn on the front fog lights, turn the fog light switch to the **F** position with the headlight switch in the **ON** or **AUTO** position.

To turn off the fog lights, turn the fog light switch to the "OFF" position.

When the headlight switch is in the "AUTO" position (if equipped):

- Turning the fog light switch to the **F** position will turn on the headlights, fog lights and the other lights while the ignition switch is in the "ON"

position or the engine is running (if equipped).

### REAR FOG LIGHT

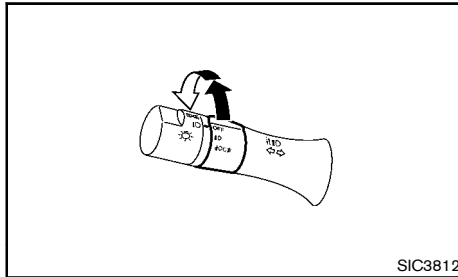

Type A

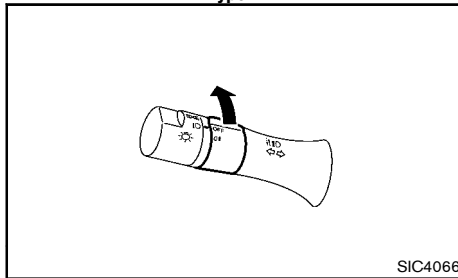

Type B

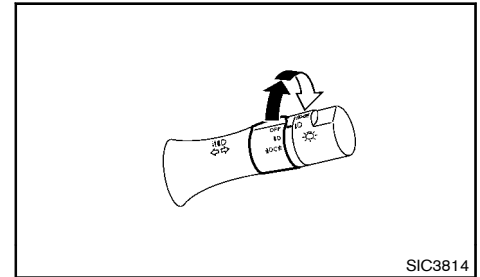

Type C

For type A and C: To turn on the rear fog light, turn the fog light switch to the **R** position. The switch returns to the **OFF** position automatically, and the rear fog light will illuminate with the front fog lights. Make sure the **R** indicator light on the instrument panel illuminates.

To turn off the rear fog light, turn the fog light switch to the **OFF** position again. Make sure the **R** indicator light on the instrument panel turns off.

To turn off both the front and rear fog lights, turn the fog light switch to the "OFF" position.

When the headlight switch is in the "AUTO" position (if equipped):

- Turning the fog light switch to the **R** position will turn on the headlights, fog lights and the other lights while the ignition switch is in the "ON" position or the engine is running.

The rear fog light should be used only when visibility is seriously reduced. [Generally, to less than 100 m (328 ft)]

For type B: To turn on the rear fog light, turn the fog light switch to the **R** position with the headlight switch in the **ON** or **AUTO** position.

To turn off the fog light, turn the fog light switch to the "OFF" position.

## WIPER AND WASHER SWITCH

The rear fog light should be used only when visibility is seriously reduced. [Generally, to less than 100 m (328 ft)]



### WARNING:

In freezing temperatures, the washer fluid may freeze on the windshield and obscure your vision. Warm the windshield with the defogger before you wash the windshield.



### CAUTION:

- Do not operate the washer continuously for longer than 30 seconds.
- Do not operate the washer if the window washer fluid reservoir is empty.

## WINDSHIELD WIPER AND WASHER SWITCH

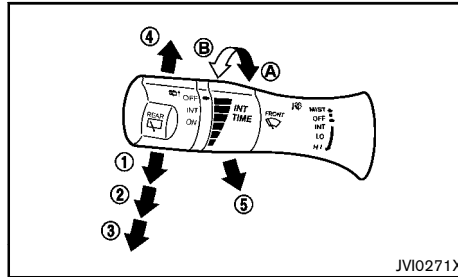

Type A (example)

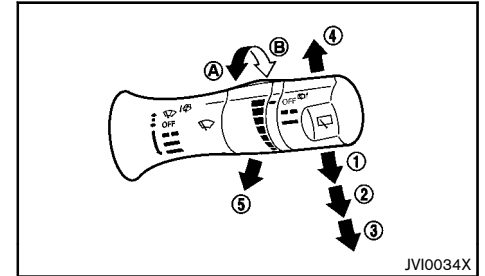

Type B (example)

The windshield wiper and washer operate when the ignition switch is in the "ON" position.

### Wiper operation

The lever position "INT" or "■" ① operates the wiper intermittently.

- If equipped, the intermittent operation can be adjusted by turning the adjustment control knob, (longer) A or (shorter) B .
- If equipped, the speed of the intermittent operation varies depending on the vehicle speed.

The lever position "AUTO" ① operates the rain sensing auto wiper system (if equipped). (See "Rain-sensing auto wiper system" (P.2-38).)

The lever position "LO" or "■" ② operates the wiper at low speed.

The lever position "HI" or "■" ③ operates the wiper at high speed.

To stop the wiper operation, move the lever up to the "OFF" position.

The lever position "MIST" or "☔" ④ operates the wiper one sweep. The lever automatically returns to its original position.

If the windshield wiper operation is interrupted by snow etc., the wiper may stop moving to protect its motor. If this occurs, turn the wiper switch to OFF and remove the snow etc. on and around the wiper arms. In approximately 20 seconds, turn the switch ON again to operate the wiper.

### Washer operation

To operate the washer, pull the lever toward the back of the vehicle ⑤ until the desired amount of washer fluid is spread on the windshield. The wiper will automatically operate several times.

### RAIN-SENSING AUTO WIPER SYSTEM (if equipped)

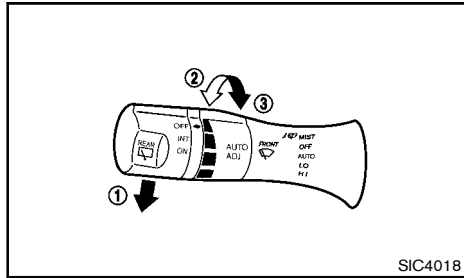

Type A

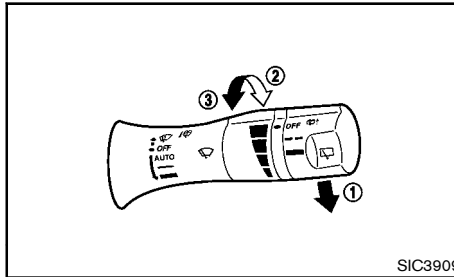

Type B

The rain-sensing auto wiper system can automatically turn on the wipers and adjust the wiper speed depending on the rainfall and the vehicle speed by using the rain sensor located on the upper part of the windshield.

To set the rain-sensing auto wiper system, push the lever down to the "AUTO" position ①. The wiper will sweep once while the ignition switch is in the "ON" position.

The rain sensor sensitivity level can be adjusted by turning the knob toward the front ② (High) or toward the rear ③ (Low).

- High — High sensitive operation
- Low — Low sensitive operation

To turn the rain-sensing auto wiper system off, push up the lever to the "OFF" position, or pull down the lever to the "—" (LO) or "—" (HI) position.



### CAUTION:

Do not touch the rain sensor and around it when the wiper switch is in the "AUTO" position and the ignition switch is in the "ON" position. The wipers may operate unexpectedly and cause to an injury or a wiper damage.

- The rain-sensing auto wipers are intended for use during rain. If the switch is left in the "AUTO" position, the wipers may operate unexpectedly when dirt, fingerprints, oil film or insects are stuck on or around the sensor. The wipers may also operate when exhaust gas or moisture affect the rain sensor.
- When the windshield glass is coated with water repellent, the speed of the rain-sensing auto wipers may be higher even though the amount of the rainfall is small.
- Be sure to turn off the rain-sensing auto wiper system when you use a car wash.
- The rain-sensing auto wipers may not operate if rain does not hit the rain sensor even if it is raining.

### REAR WINDOW WIPER AND WASHER SWITCH (if equipped)

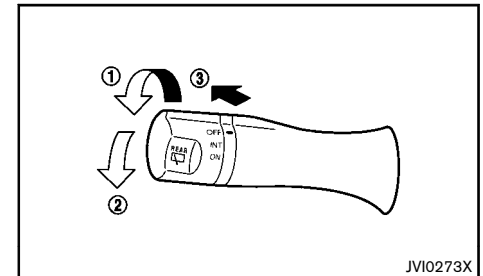

Type A

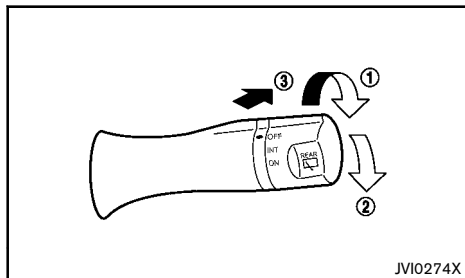

Type B

If the rear window wiper operation is interrupted by snow etc., the wiper may stop moving to protect its motor. If this occurs, turn the wiper switch to OFF and remove the snow etc. on and around the wiper arms. In approximately 1 minute, turn the switch ON again to operate the wiper.

The rear window wiper and washer operates when the ignition switch is in the "ON" position.

### Wiper operation

The switch position "INT" ① operates the wiper intermittently.

The switch position "ON" ② operates the wiper continuously.

To stop the wiper operation, turn the switch to the "OFF" position.

### Reverse synchronization function (if equipped):

When the windshield wiper switch is on, moving the shift lever to the "R" (Reverse) position will operate the rear window wiper.

### Washer operation

To operate the washer, push the lever toward the front of the vehicle ③ until the desired amount of washer fluid is spread on the rear window. The wiper will automatically operate several times.

## DEFOGGER SWITCH (if equipped)

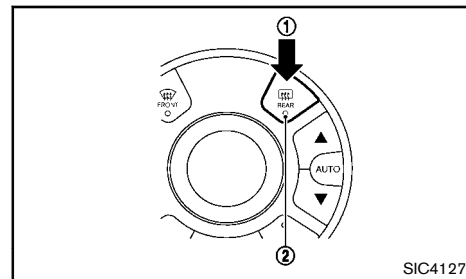

Type A

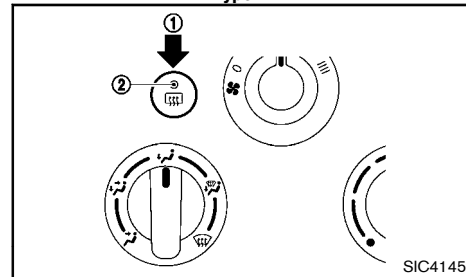

Type B

The rear window defogger switch operates when the ignition switch is in the "ON" position.

The defogger is used to reduce the moisture, fog or frost on the rear window surface and outside door mirror surface (if equipped) to improve the rear view.

When the defogger switch ① is pushed, the indicator light ② illuminates and the defogger operates for approximately 15 minutes. After the preset time has passed, the defogger will turn off automatically.

To turn off the defogger manually, push the defogger switch again.

## HORN



### CAUTION:

- When operating the defogger continuously, be sure to start the engine. Otherwise, it may cause the battery to discharge.
- When cleaning the inner side of the window, be careful not to scratch or damage the electrical conductors on the surface of the window.

### NOTE:

When the rear defogger is turned on, the Stop/Start (Idling Stop) System (if equipped) will not be activated.

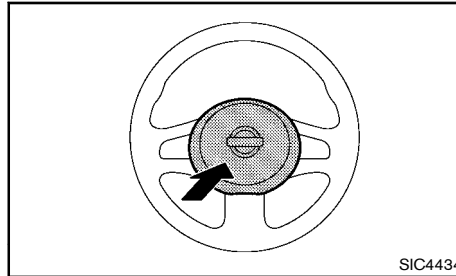

The horn switch operates with the ignition switch in any position except when the battery is discharged.

When the horn switch is pushed and held, the horn will sound. Releasing the horn switch will cease the horn sound.

## WINDOWS

### MANUAL WINDOWS (if equipped)

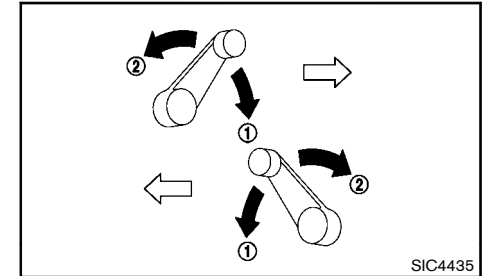

The side windows can be opened ① or closed ② by turning the hand crank on each door.

### POWER WINDOWS (if equipped)



### WARNING:

- Make sure that all passengers have their hands, etc. inside the vehicle before operating the power windows.
- Never leave children or adults who would normally require the support of others alone in the vehicle. They could unknowingly activate switches or controls and inadvertently become involved in an accident.

The power windows operate when the ignition switch is in the "ON" position.

To open a window, push down the power window switch.

To close a window, pull up the power window switch.

## Driver's window switch

The driver's switch, which is the main switch, can control all windows.

### Locking passengers' windows:

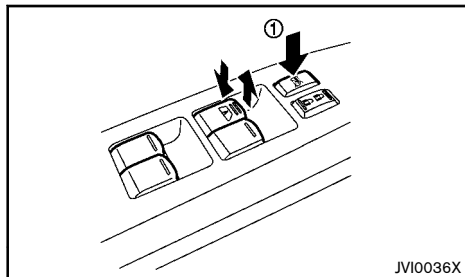

#### Front and rear type

When the lock button ① is pushed in, the passengers' windows cannot be operated.

To cancel the passengers' windows lock, push the lock button ① again.

## Passenger's window switch

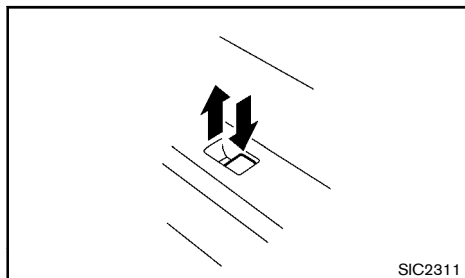

The passenger's switch can control its corresponding window.

When the passengers' windows lock button on the driver's switch is pushed in, the passenger's switch cannot be operated.

## Automatic function

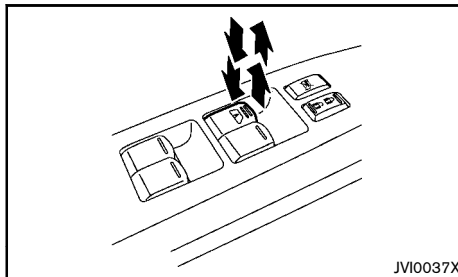

#### Front and rear type

Automatic function is available for the switch that has an **A** mark on its surface.

The automatic function enables a window to fully open or close (if equipped) without holding the switch down or up.

To fully open the window, push the power window switch down to the second detent and release the switch. To fully close the window (if equipped), pull the power window switch up to the second detent and release the switch. The switch does not have to be held during window operation.

To stop the window open/close operation during the automatic function, push down or pull up the switch in opposite directions.

## Window timer (if equipped):

The window timer allows the window switch to be operated for 15 minutes even if the ignition switch is turned off and the key is removed. The window timer will be cancelled when the corresponding door is opened or the preset time has expired.

### Auto-reverse function (if equipped):



#### WARNING:

**There is a small distance just before the closed position which cannot be detected. Make sure that all passengers have their hands, etc. inside the vehicle before closing the windows.**

The auto-reverse function enables a window to automatically reverse when something is caught in the window as it is closing by the automatic function. When the control unit detects an obstacle, the window will be lowered immediately.

Depending on the environment or driving conditions, the auto-reverse function may activate if an impact or load similar to something being caught in the window occurs.

## When power window switch does not operate

Some power window functions (automatic close function, auto-reverse function) will not operate as described after the battery cable is disconnected and the electrical supply is interrupted. Perform the following procedure to initialize the power window functions.

1. Turn the ignition switch to the "ON" position.
2. If the driver's window is closed, open it completely by operating the driver's window switch.



## SUNSHADE (if equipped)

3. Pull up and hold the driver's window switch to close the driver's window. Hold the switch for approximately 3 seconds after the window has been fully closed, and then release it.
4. Check if the power window functions operate properly.

If you open or close the power window continuously, it may cause the power window not to operate properly. Perform the above procedure.

If the power window functions do not operate properly after performing the above procedure, repeat the steps. See a NISSAN dealer, if necessary, for checking the power window system.



### WARNING:

**Never allow hands, fingers, or any part of your body within operating range of the sunshade. You could be injured.**



### CAUTION:

- Do not place any heavy objects on the roof glass or surrounding area.
- Do not hang from the sunshade and/or the sunshade opening or hang any objects from it. It may cause damage or deformation to the sunshade.
- Close the sunshade when you leave the vehicle for extended periods of time to prevent the inside of the vehicle from reaching high temperatures.

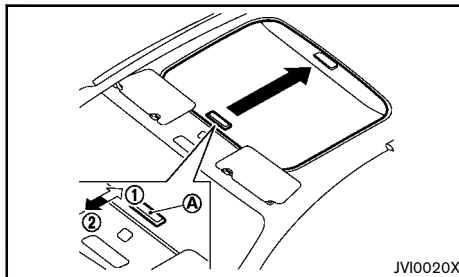

To open or close the sunshade, operate the knob (A) .  
To open the sunshade, slide it toward the rear of the vehicle (1) . To close, slide the sunshade toward the front of the vehicle (2) .

## CLOCK

If the battery cable is disconnected, the clock will reset its time and the correct time will not be indicated. Readjust the time.

For model with the vehicle information display, see "Vehicle information display" (P.2-20)

For the clock adjustment in the audio unit (if equipped). See "Audio system" (P.4-11).

## ADJUSTING TIME

Meter display model (if equipped)

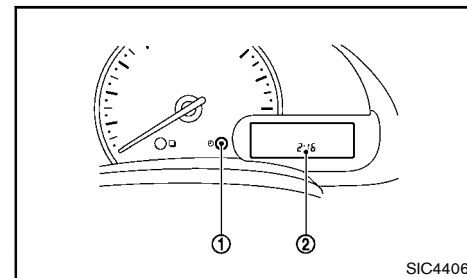

### Example

The digital clock (2) in the meter displays the time when the ignition switch is in the "ON" position.

To display the clock, push the adjusting knob (1) . To adjust the time, perform the following procedure.

1. Push the clock adjusting knob (1) for 1.5 or 3 seconds or more to enter time adjust mode.  
The hours display will start to flash.
2. Push the clock adjusting knob (1) to adjust the hour.  
To advance the time, hold down the knob (1) .
3. Wait at least 3 or 5 seconds for the minute display to flash.

## POWER OUTLETS (if equipped)

4. Push the clock adjusting knob ① to adjust the minutes.

To advance the time, hold down the knob ①.

Wait at least 3 or 5 seconds for the second display “:” to flash.

5. Push the clock adjusting knob ① to reset the second counter.

The selected values will be stored if no user input is detected for 60 seconds, or can be reset by using the adjusting knob.

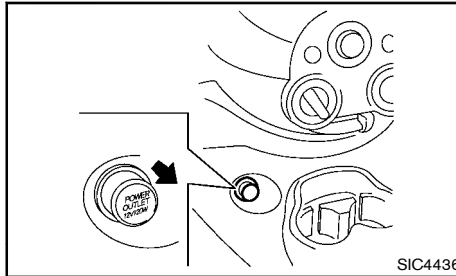

The power outlet is for powering electrical accessories such as cellular telephone.



### CAUTION:

- The outlet and plug may be hot during or immediately after use.
- This power outlet is not designed for use with a cigarette lighter unit.
- Do not use with accessories that exceed a 12 volt, 120W (10A) power draw. Do not use double adapters or more than one electrical accessory.
- Use power outlets with the engine running to avoid discharging the vehicle battery.
- Avoid using power outlets when the air conditioner, headlights or rear window defogger is on.
- Before inserting or disconnecting a plug, be sure to turn off the power switch of electrical accessory being used and the ignition switch.
- Push the plug in as far as it will go. If good contact is not made, the plug may overheat or the internal temperature fuse may open.

- Do not allow water to contact the outlet.
- When not in use, be sure to close the cap.

## STORAGES

### WARNING:

- The storages should not be used while driving so full attention may be given to vehicle operation.
- Keep the storage lids closed while driving to help prevent injury in an accident or a sudden stop.

### GLOVE BOX

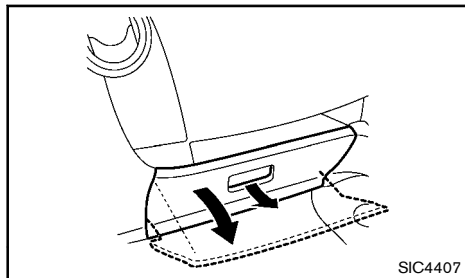

Type A

To open the glove box, pull the handle.

To close, push the lid in until the lock latches.

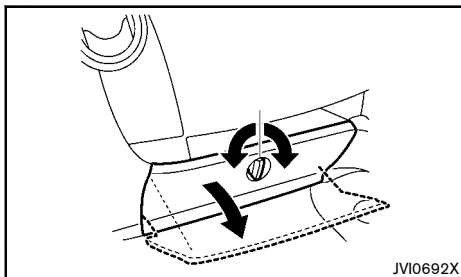

Type B

To open the glove box, turn the knob counterclockwise.

To close, push the lid in and turn the knob clockwise.

### UPPER INSTRUMENT BOX (if equipped)

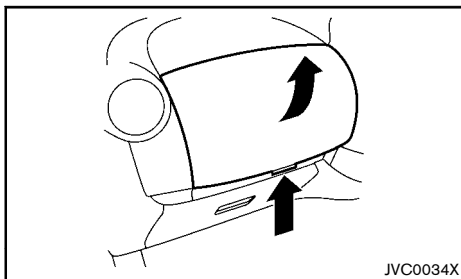

To open the upper instrument box, push the button.

To close, push the lid down.

### CARD HOLDER (if equipped)

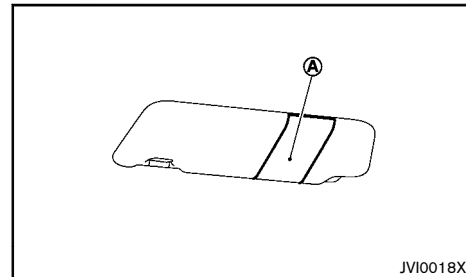

Slide a card in the card holder (A).

### CUP HOLDERS

#### CAUTION:

Avoid abrupt starting and braking especially when the cup holder is being used to prevent spilling the contents. If the contents are hot, they could scald you or your passengers.

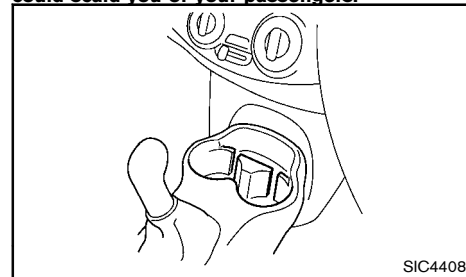

Front

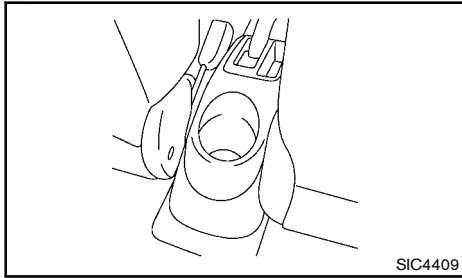

Rear

### TONNEAU BOARD (if equipped)

#### **⚠ WARNING:**

- Never put anything on the tonneau board, no matter how small. Any object on it could cause an injury in an accident or sudden stop.
- Do not leave the tonneau board in the vehicle with it disengaged from the holder.

The tonneau board keeps the luggage compartment contents hidden from the outside.

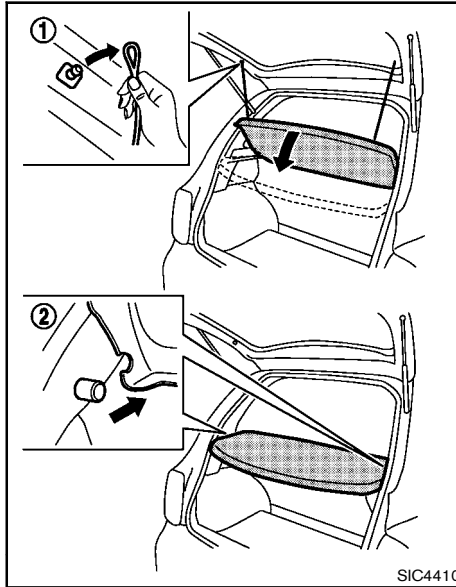

To remove the tonneau board:

1. Remove the straps ① (if equipped) from the back door.
2. Remove the tonneau board from the tonneau board holders ②.

## SUN VISORS

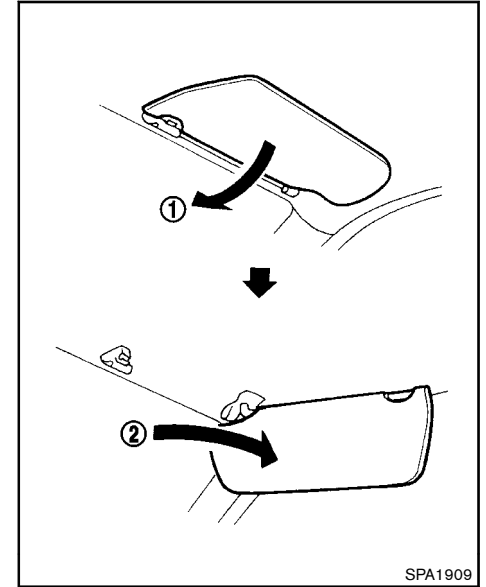

1. To block out glare from the front, swing down the sun visor ①.
2. To block glare from the side, remove the sun visor from the center mount and swing it to the side ②.

## INTERIOR LIGHTS



### CAUTION:

- Do not leave the light switch on when the engine is not running for extended periods of time to prevent the battery from being discharged.
- Turn off the lights when you leave the vehicle.

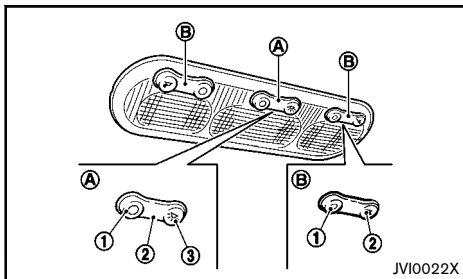

### ROOM LIGHT

The room light (A) has a three-position switch.

When the switch is in the on position (3), the light illuminates.

When the switch is in the center position (2), the room light illuminates when a door is opened.

The interior light timer will keep the room light on for a period of time when:

- The key is removed from the ignition switch with all doors closed (model without Intelligent Key system).
- The ignition switch is placed in the "OFF" or "LOCK" position (model with Intelligent Key system).

- The driver's door is unlocked without the key in the ignition switch (model without Intelligent Key system).
- The doors are unlocked with the UNLOCK button (on the keyfob or Intelligent Key) or the request switch (model with Intelligent Key system) with the ignition switch in the "LOCK" position.
- The driver's door is opened and then closed with the ignition switch in the "LOCK" position and without the key in the ignition switch.

The interior light timer will be cancelled when:

- The driver's door is locked.
- The ignition switch is turned to the "ON" position.

When the switch is in the off position (1), the room light does not illuminate, regardless of any condition.

### FRONT MAP LIGHTS (if equipped)

To turn on the front map light (B) (if equipped), push the on switch (2), and the light illuminates. To turn off, push the off switch (1).

### Battery saver system

If any door is left open for a period of time with the room light switch placed horizontally or the room control switch in the center position (2), the room light will automatically turn off.

**MEMO**

**MEMO**

# 3 Pre-driving checks and adjustments

Keys .....	3-2	Security system (if equipped) .....	3-17
Key .....	3-2	Theft warning system .....	3-17
NISSAN Anti-Theft System (NATS) key (if equipped) .....	3-3	NISSAN anti-theft system (NATS) .....	3-18
Intelligent Key (if equipped) .....	3-3	Hood .....	3-19
Door locks .....	3-5	Opening hood .....	3-19
Super lock system (if equipped) .....	3-5	Closing hood .....	3-19
Locking with key .....	3-5	Back door .....	3-20
Locking with inside lock knob .....	3-6	Opening back door .....	3-20
Locking with power door lock switch (if equipped) .....	3-6	Fuel filler lid .....	3-20
Vehicle speed sensing door lock mechanism (if equipped) ....	3-6	Opening fuel filler lid .....	3-20
Auto door lock releasing mechanism (if equipped) .....	3-7	Fuel filler cap .....	3-21
Child safety rear door lock .....	3-7	Steering wheel .....	3-21
Remote keyless entry system (if equipped) .....	3-7	Mirrors .....	3-21
Using remote keyless entry system (if equipped) .....	3-8	Inside rearview mirror .....	3-21
Intelligent Key system (if equipped) .....	3-9	Outside rearview mirrors .....	3-22
Operating range .....	3-11	Vanity mirrors (if equipped) .....	3-24
Using intelligent Key system .....	3-11	Parking brake .....	3-24
Battery saver system .....	3-13	Lever type .....	3-24
Warning and audible reminders .....	3-13		
Trouble shooting guide .....	3-14		
Using remote keyless entry function .....	3-16		



## KEYS

Your vehicle can only be driven with the keys specific to your vehicle. A key number plate is supplied with your key. Record the key number and keep the key number plate in a safe place, except in the vehicle, in case of the need to duplicate the keys.

The key can only be duplicated using an original key or the original key number. The key number is required when you have lost all of the keys and do not have the original key to duplicate from. If the key is lost, or you need extra keys, provide an original key or the key number to a NISSAN dealer.



### CAUTION:

**Do not leave the keys inside the vehicle when leaving the vehicle.**

## KEY

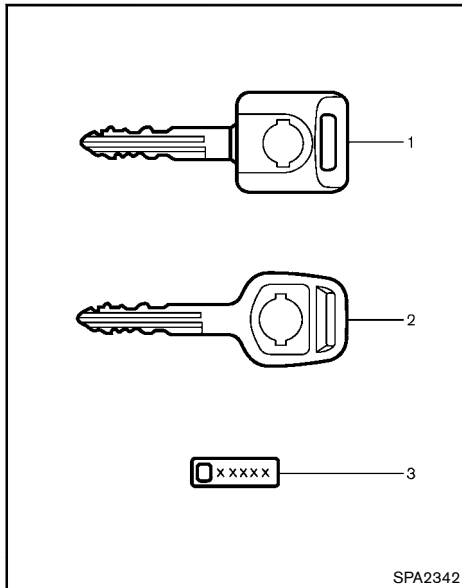

**Type A**

Your vehicle is equipped with the following set of keys:

- 1 Master key (Molded)
- 2 Master key (Plate)
- 3 Key number plate

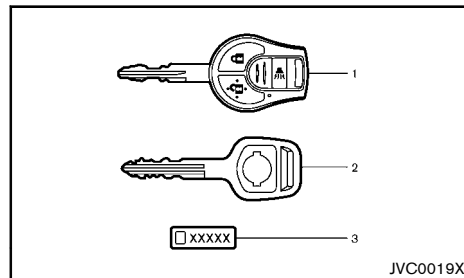

**Type B**

- 1 Master key
- 2 Master key (Plate)
- 3 Key number plate

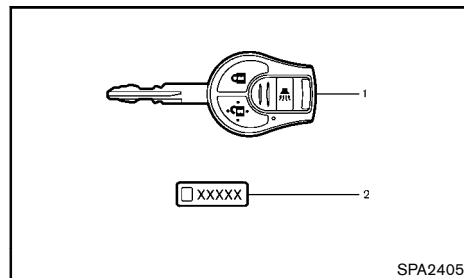

**Type C**

1. Master key
2. Key number plate

As many as 5 master keys with remote controller can be registered and used with one vehicle.

## NISSAN ANTI-THEFT SYSTEM (NATS\*) KEY (if equipped)

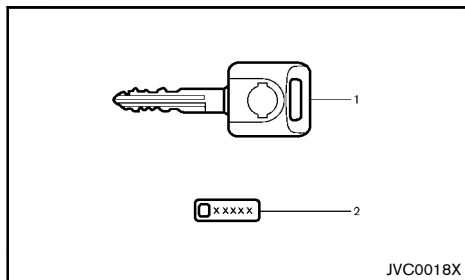

**Type A**

Your vehicle is equipped with the following set of keys:

- 1 NATS key (Molded)
- 2 Key number plate

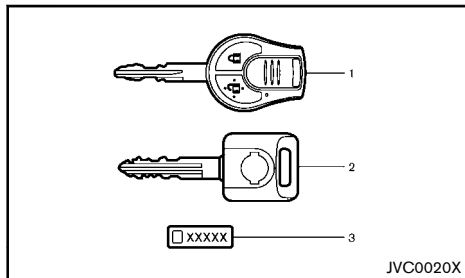

**Type B**

- 1 NATS key
- 2 NATS key (Molded)
- 3 Key number plate

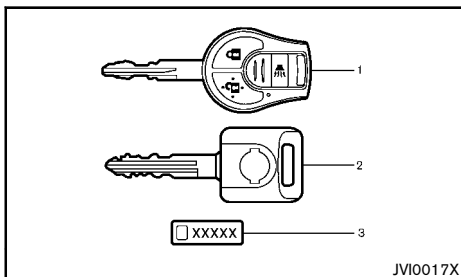

**Type C**

- 1 NATS key
- 2 NATS key (Molded)
- 3 Key number plate

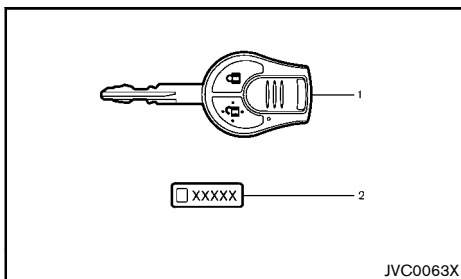

**Type D**

- 1 NATS key
- 2 Key number plate

Your vehicle can only be driven with the NATS keys, which are registered to your vehicle's NATS components. As many as 5 NATS keys can be registered and used with one vehicle. The new keys must be registered by a NISSAN dealer prior to use with the NATS of your vehicle. Since the registration process requires erasing all memory in the NATS components

when registering new keys, be sure to take all NATS keys that you have to the NISSAN dealer.



### **CAUTION:**

**Do not allow the NATS key, which contains an electrical transponder, to come into contact with water or salt water. This could affect the system function.**

\*: Immobilizer

## INTELLIGENT KEY (if equipped)

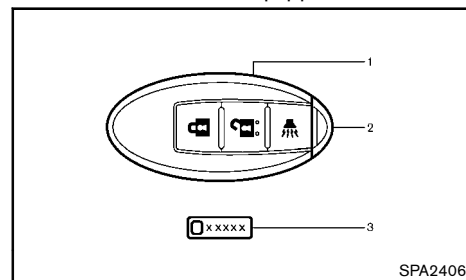

**Type A (with panic alarm)**

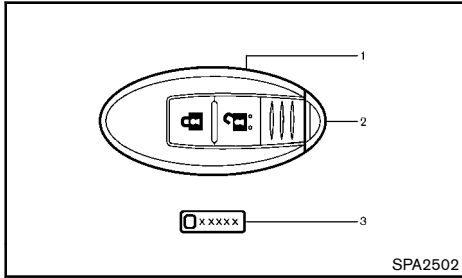

**Type B (without panic alarm)**

1. Intelligent Key (2)
2. Mechanical key (inside the Intelligent Key) (2)
3. Key number plate

Your vehicle can only be driven with the Intelligent Keys, which are registered to your vehicle's Intelligent Key system components and NISSAN Anti-Theft System (NATS\*) components. As many as 4 Intelligent Keys can be registered and used with one vehicle. The new keys must be registered by a NISSAN dealer prior to use with the Intelligent Key system and NATS of your vehicle. Since the registration process requires erasing all memory in the Intelligent Key components when registering new keys, be sure to take all Intelligent Keys that you have to the NISSAN dealer.

\*: Immobilizer



**CAUTION:**

- **Be sure to carry the Intelligent Key with you. Do not leave the vehicle with the Intelligent Key inside.**
- **Be sure to carry the Intelligent Key with you when driving. The Intelligent Key is a precision device with a built-in transmitter. To avoid damaging it, please note the follow-**

ing.

- **The Intelligent Key is water resistant; however, wetting may damage the Intelligent Key. If the Intelligent Key gets wet, immediately wipe until it is completely dry.**
- **Do not bend, drop or strike it against another object.**
- **If the outside temperature is below -10°C (14 °F), the battery of the Intelligent Key may not function properly.**
- **Do not place the Intelligent Key for an extended period in a place where temperatures exceed 60°C (140°F).**
- **Do not change or modify the Intelligent Key.**
- **Do not use a magnet key holder.**
- **Do not place the Intelligent Key near equipment that produces a magnetic field such as a TV, audio equipment and personal computers or cellular phones.**
- **Do not allow the Intelligent Key to come into contact with water or salt water, and do not wash it in a washing machine. This could affect the system function.**

- **If an Intelligent Key is lost or stolen, NISSAN recommends erasing the ID code of that Intelligent Key. This will prevent the Intelligent Key from unauthorized use to unlock the vehicle. For information regarding the erasing procedure, please contact a NISSAN**

dealer.

**Mechanical key**

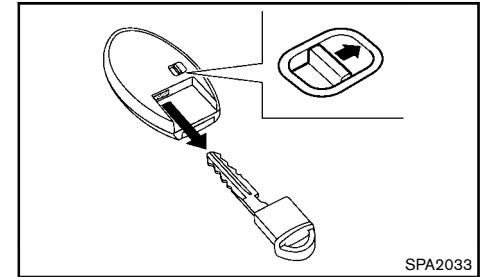

To remove the mechanical key, release the lock knob at the back of the Intelligent Key.

To install the mechanical key, firmly insert it into the Intelligent Key until the lock knob returns to the lock position.

Use the mechanical key to lock or unlock the doors. (See "Door locks" (P.3-5).)

## DOOR LOCKS

### **WARNING:**

- **Always look before opening any doors, to avoid an accident with oncoming traffic.**
- **Never leave children or adults who would normally require the support of others alone in the vehicle. They could unknowingly activate switches or controls and inadvertently become involved in a serious accident.**

### SUPER LOCK SYSTEM (if equipped)

### **WARNING:**

**For Super Lock System equipped models, failure to follow the precautions below may lead to hazardous situations. Make sure the Super Lock System activation is always safely conducted.**

- **When the vehicle is occupied, never lock the doors with the remote keyless entry system or the Intelligent Key system. Doing so will trap the occupants, since the Super Lock System prevents the doors from being opened from the inside of the vehicle.**
- **Only operate the remote controller or the Intelligent Key lock button when there is a clear view of the vehicle. This is to prevent anybody from being trapped inside the vehicle through the Super Lock System activation.**

Locking the doors with the remote controller or the Intelligent Key “LOCK” button  or the request switch will lock all doors and activate the Super Lock System.

This means that none of the doors can be opened from the inside in order to prevent theft.

The system will be released when the door is unlocked with the remote controller or the Intelligent Key “UNLOCK” button  or the request switch.

The Super Lock System will not activate when the doors are locked with the power door lock switch or mechanical key.

### Emergency situations

If the Super Lock System is activated due to a traffic accident or other unexpected circumstances while you are in the vehicle:

- Place the ignition switch to the “ON” position, the Super Lock System will be released and all the doors can be unlocked with the power door lock switch. You can then open the doors.
- Unlock the door using the remote controller or the Intelligent Key. The Super Lock System will be released and you can open the door.

### LOCKING WITH KEY

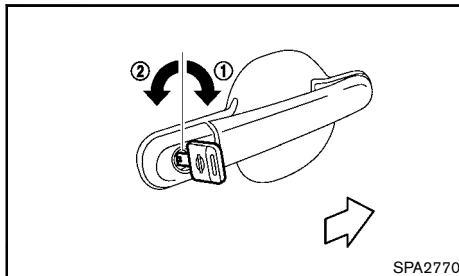

### Type A

To lock the driver's door or passenger's door, insert the key to the door cylinder located on the driver's or passenger's side door and turn the key to the front of the vehicle ①.

For locking ① the back door, see “Opening back door” (P.3-20).

To unlock the driver's door or passenger's door, turn the key to the rear of the vehicle ②.

For unlocking the back door, see “Opening back door” (P.3-20).

### Type B

To lock the door, insert the key to the door key cylinder located on the driver's side door, and turn the key to the front of the vehicle ①. All doors including the back door will lock.

To unlock the door, turn the key to the rear of the vehicle ②. All doors including the back door will unlock.

### Type C

To lock the driver's door, insert the key to the door cylinder located on the driver's side door and turn the key to the front of the vehicle ①.

For locking other doors, use the power door lock switch. (See “Locking with power door lock switch” (P.3-6).)

To unlock the driver's door, turn the key to the rear of the vehicle ②.

For unlocking other doors, use the power door lock switch. (See “Locking with power door lock switch” (P.3-6).)

## LOCKING WITH INSIDE LOCK KNOB

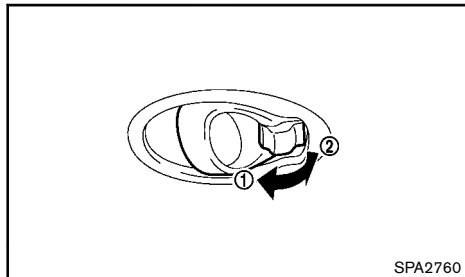

To lock the front doors, push the inside lock knob to the lock position ①, and then close the door while pulling the door handle.

To lock the rear doors, push the inside lock knob to the lock position ① and then close the door.

### CAUTION:

- When locking the doors using the inside lock knob, be sure not to leave the key in the vehicle.
- When the key is in the ignition switch and the driver's door is open, the inside lock knob will not lock the door(s).

To unlock, pull the inside lock knob to the unlock position ②.

When the doors are locked, pulling the driver's side door handle will unlock the door (if equipped).

## Right-Hand Drive (RHD) model (if equipped)

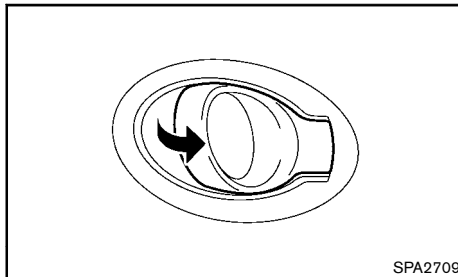

To unlock and open the door, pull the inside door handle as illustrated.

The doors cannot be opened by using the inside door handle when the Super Lock System is activated.

## LOCKING WITH POWER DOOR LOCK SWITCH (if equipped)

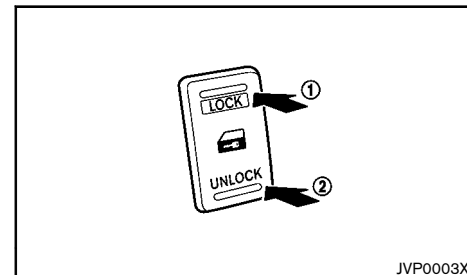
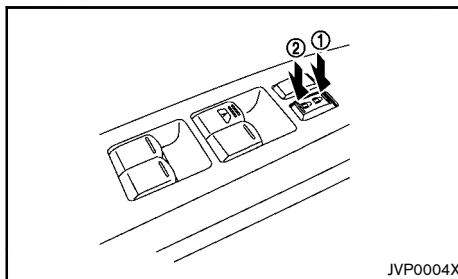

**Power door lock switch (located on the center console)**  
To lock the doors, push the power door lock switch to the lock position ①.

### CAUTION:

- When locking the doors using the power door lock switch, be sure not to leave the key in the vehicle.
- When the key is in the ignition switch and the driver's door is open, the power door lock switch will not lock the doors.

To unlock, push the power door lock switch to the unlock position ②.

## VEHICLE SPEED SENSING DOOR LOCK MECHANISM (if equipped)

All doors will be locked automatically when the vehicle speed reaches 10 km/h (6 MPH). Once the lock has been unlocked, while driving, the vehicle speed sensing door lock mechanism will not lock the door again unless one of the following is performed.

- Opening any doors.
- Placing the ignition switch in the "OFF" position.

### To activate or deactivate vehicle speed sensing door lock mechanism

To activate or deactivate the door lock mechanism, perform the following procedures.

1. Place the ignition switch in the "ON" position.
2. Within 20 seconds, push and hold the power door lock switch to the "LOCK" position for 5 seconds.
3. The hazard indicator light will flash as follows if the switching operation is successful:
  - Twice — activated
  - Once — deactivated

### AUTO DOOR LOCK RELEASING MECHANISM (if equipped)

All doors will be unlocked automatically when the ignition switch moved "ON" to "OFF" position (models with Intelligent Key system).

All doors will be unlocked automatically when the key is removed from the ignition switch (models without Intelligent Key system).

### To activate or deactivate auto door lock releasing mechanism

To activate or deactivate the auto door lock releasing mechanism, perform the following procedures.

1. Place the ignition switch in the "ON" position.
2. Within 20 seconds, push and hold the power door lock switch to the "UNLOCK" position for 5 seconds.
3. The hazard indicator light will flash as follows if the switching operation is successful:
  - Twice - activated
  - Once - deactivated

### CHILD SAFETY REAR DOOR LOCK

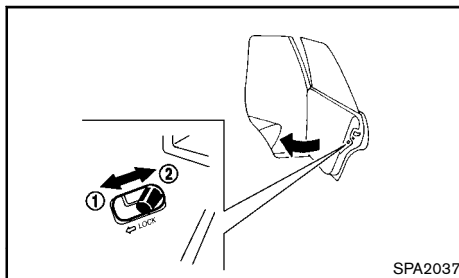

The child safety rear door locks help prevent rear doors from being opened accidentally, especially when small children are in the vehicle.

When the levers are in the lock position ①, the child safety rear door locks engage and the rear doors can only be opened by the outside door handles.

To disengage, move the levers to the unlock position ②.

## REMOTE KEYLESS ENTRY SYSTEM (if equipped)

The remote keyless entry system can operate all door locks (including the back door) using the remote controller. The remote controller can operate at a distance of approximately 1 m (3.3 ft) away from the vehicle. The operating distance depends upon the conditions around the vehicle.

As many as 5 remote controllers can be used with one vehicle. For information about the purchase and use of additional remote controllers, contact a NISSAN dealer.

The remote controller will not function under the following conditions:

- When the distance between the remote controller and vehicle is more than approximately 1 m (3.3 ft).
- When the remote controller battery is discharged.
- When the key is in the ignition switch.



### CAUTION:

- **When locking the doors using the remote controller, be sure not to leave the key in the vehicle.**
- **Do not allow the remote controller, which contains electrical components, to come into contact with water or salt water. This could affect the system function.**
- **Do not drop the remote controller.**
- **Do not strike the remote controller sharply against another object.**
- **Do not place the remote controller for an extended period in an area where temperatures exceed 60°C (140°F).**
- **When the outside temperature is extremely low, the remote keyless entry system may**

### not function properly.



If a remote controller is lost or stolen, NISSAN recommends erasing the ID code of that remote controller from the vehicle. This may prevent the unauthorized use of the remote controller to unlock the vehicle. For information regarding the erasing procedure, contact a NISSAN dealer.

For information regarding the replacement of a battery, see "Remote controller battery" (P.8-25).

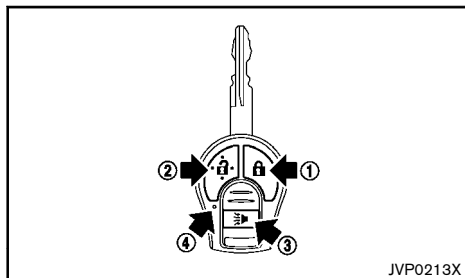
### USING REMOTE KEYLESS ENTRY SYSTEM (if equipped)



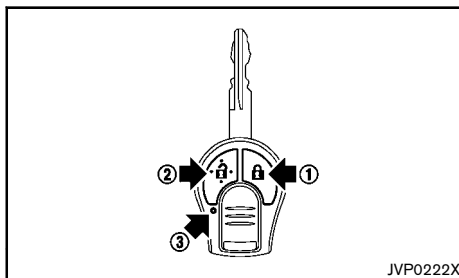

#### Type A (with panic alarm)

- ① LOCK button 
- ② UNLOCK button 
- ③ PANIC button 
- ④ Battery indicator light



#### Type B (without panic alarm)

- ① LOCK button 
- ② UNLOCK button 
- ③ Battery indicator light

### Locking doors



1. Remove the key from the ignition switch.
2. Close all doors including the back door.
3. Push the "LOCK"  button ① on the remote controller.
4. All doors will be locked.
5. Operate door handles to confirm that the doors have been securely locked.



#### CAUTION:

**After locking the doors using the remote controller, be sure that the doors have been securely locked by operating the door handles.**



### Unlocking doors

1. Push the "UNLOCK"  button ② on the remote controller.
  2. All doors including the back door will be unlocked.
- All doors will be locked automatically unless one of the following operations is performed within 30 seconds after pushing the "UNLOCK"  button ② on the remote controller while the doors are locked.



If during this 30-second time period, the "UNLOCK" button on the remote controller is pushed, all doors will be locked automatically after another 30 seconds.

- Opening any doors.
- Inserting the key into the ignition switch.



### Selecting door unlock mode (if equipped):

When you first receive the vehicle, the door unlock mode is set to unlock all the doors with one push of the "UNLOCK"  button ②. The door unlock mode can be switched to the selective door unlock mode, which unlocks the passenger's doors at the second push of the "UNLOCK"  button ②.

Selective door unlock mode:

1. Push the "UNLOCK"  button ② on the remote controller.
2. The driver's door unlocks.
3. Push the "UNLOCK"  button ② on the remote controller again.
4. All doors will be unlocked.

To switch to the selective door unlock mode, perform the following procedure.

Push the "LOCK"  and "UNLOCK"  buttons simultaneously for more than 5 seconds.

Perform the same procedure to deactivate the selective door unlock mode.

## INTELLIGENT KEY SYSTEM (if equipped)

- When the selective door unlock mode is set, the hazard indicator flashes 3 times.
- When the all door unlock mode is set, the hazard indicator flashes once.

### Using panic alarm (if equipped)

If you are near your vehicle and feel threatened, you may activate the alarm to call attention as follows:

1. Push the "PANIC"  button (3) on the remote controller for **more than 0.5 second**.
2. The theft warning alarm will stay on for 25 seconds.
3. The panic alarm stops when:
  - It has run for 25 seconds, or
  - Any of the buttons on the remote controller are pushed. (Note: Panic button should be pushed for more than 0.5 second.)

### Battery indicator light

The battery indicator light (4) (Type A) or (3) (Type B) illuminates when you push any button. If the light does not illuminate, the battery is weak or needs replacement. For information regarding replacement of a battery, see "Remote controller battery" (P.8-25).

### Hazard indicator operation (if equipped)

When you lock or unlock the doors, the hazard indicator will flash as a confirmation.

- "LOCK": The hazard indicator flashes once.
- "UNLOCK": The hazard indicator flashes twice.

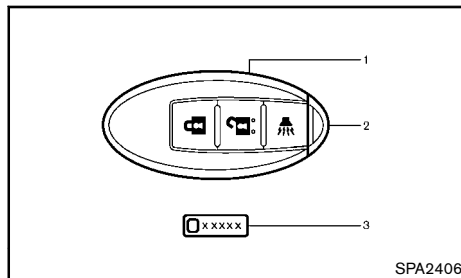

Type A (with panic alarm)

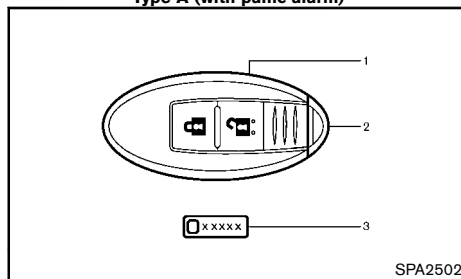

Type B (without panic alarm)

1. Intelligent Key (2)
2. Mechanical key (inside the Intelligent Key) (2)
3. Key number plate



### WARNING:

- **Radio waves could adversely affect electric medical equipment. Those who use a pacemaker should contact the electric medical equipment manufacturer for the possible influences before use.**
- **The Intelligent Key transmits radio waves when the buttons are pushed. The radio**

**waves may affect aircraft navigation and communication systems. Do not operate the Intelligent Key while on an airplane. Make sure the buttons are not operated unintentionally when the unit is stored during a flight.**

The Intelligent Key system can operate all the door (including the back door) locks using the remote controller function or pushing the request switch on the vehicle without taking the key out from a pocket or purse. The operating environment and/or conditions may affect the Intelligent Key system operation.

Be sure to read the following before using the Intelligent Key system.



### CAUTION:

- **Be sure to carry the Intelligent Key with you when operating the vehicle.**
- **Never leave the Intelligent Key in the vehicle when you leave the vehicle.**
- **When the outside temperature is extremely low, the Intelligent Key system may not function properly.**

The Intelligent Key is always communicating with the vehicle as it receives radio waves. The Intelligent Key system transmits weak radio waves. Environmental conditions may interfere with the operation of the Intelligent Key system under the following operating conditions.

- When operating near a location where strong radio waves are transmitted, such as a TV tower, power station and broadcasting station.
- When in possession of wireless equipment, such as a cellular telephone, transceiver, and CB radio.



- When the Intelligent Key is in contact with or covered by metallic materials.
- When any type of radio wave remote control is used nearby.
- When the Intelligent Key is placed near an electric appliance such as a personal computer.
- When the vehicle is parked near a parking meter.

In such cases, correct the operating conditions before using the Intelligent Key function or use the mechanical key.

Although the life of the battery varies depending on the operating conditions, the battery's life is approximately 2 years. If the battery is discharged, replace it with a new one.

For information regarding replacement of a battery, see "Intelligent Key battery" (P.8-26).

Since the Intelligent Key is continuously receiving radio waves, if the key is left near equipment which transmits strong radio waves, such as signals from a TV and personal computer, the battery life may become shorter.

To start the engine when the Intelligent Key battery is discharged, see "Push-button ignition switch (model with Intelligent Key system)" (P.5-6). Replace the discharged battery with a new one as soon as possible.

Because the steering wheel is locked electrically, unlocking the steering wheel with the ignition switch in the "LOCK" position is impossible when the vehicle battery is completely discharged. In this case, unlocking the steering wheel would be also impossible. Pay special attention that the vehicle battery is not completely discharged.

As many as 4 Intelligent Keys can be used with one vehicle. For information about the purchase and use of additional Intelligent Keys, contact a NISSAN dealer.

### 3-10 Pre-driving checks and adjustments



#### CAUTION:

- **Do not allow the Intelligent Key, which contains electrical components, to come into contact with water or salt water. This could affect the system function.**
- **Do not drop the Intelligent Key.**
- **Do not strike the Intelligent Key sharply against another object.**
- **Do not change or modify the Intelligent Key.**
- **Wetting may damage the Intelligent Key. If the Intelligent Key gets wet, immediately wipe until it is completely dry.**
- **If the outside temperature is below -10°C (14°F), the battery of the Intelligent Key may not function properly.**
- **Do not place the Intelligent Key for an extended period in an area where temperatures exceed 60°C (140°F).**
- **Do not attach the Intelligent Key with a key holder that contains a magnet.**
- **Do not place the Intelligent Key near equipment that produces a magnetic field, such as a TV, audio equipment and personal computers or cellular phones.**

If an Intelligent Key is lost or stolen, NISSAN recommends erasing the ID code of that Intelligent Key from the vehicle. This may prevent the unauthorized use of the Intelligent Key to operate the vehicle. For information regarding the erasing procedure, contact a NISSAN dealer.

The Intelligent Key function can be disabled. For information about disabling the Intelligent Key function, contact a NISSAN dealer.

## OPERATING RANGE

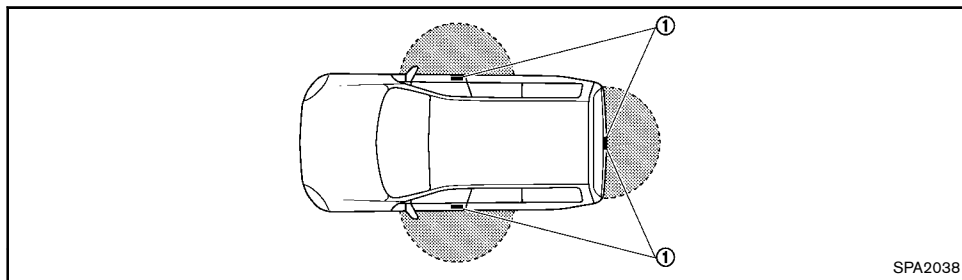

The Intelligent Key functions can only be used when the Intelligent Key is within the specified operating range from the request switch ①.

When the Intelligent Key battery is discharged or strong radio waves are present near the operating location, the Intelligent Key system's operating range becomes narrower, and the Intelligent Key may not function properly.

The operating range is within 80 cm (31.50 in) from each request switch ①.

If the Intelligent Key is too close to the door glass, handle or rear bumper the request switches may not function.

When the Intelligent Key is within the operating range, it is possible for anyone, even someone who does not carry the Intelligent Key, to push the request switch and lock/unlock the doors.

## USING INTELLIGENT KEY SYSTEM

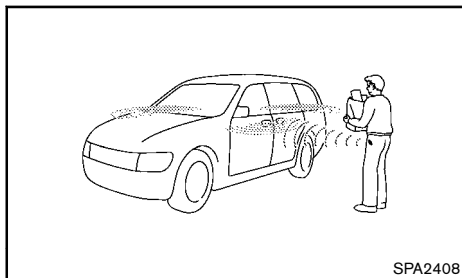

The request switch will not function under the following conditions:

- When the Intelligent Key is left inside the vehicle
- When the Intelligent Key is not within the operational range
- When any door is open or not closed securely
- When the Intelligent Key battery is discharged
- When the ignition switch is in the "ACC" or "ON" position

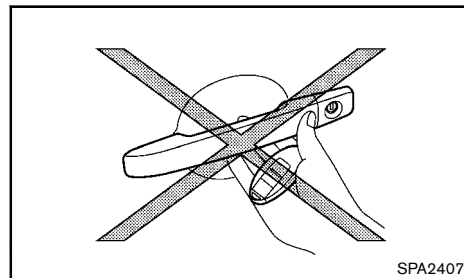

- Do not push the door handle request switch with the Intelligent Key held in your hand as illustrated. The close distance to the door handle will cause the Intelligent Key system to have difficulty recognizing that the Intelligent Key is outside the vehicle.
- After locking the doors using the door handle request switch, make sure that the doors have been securely locked by operating the door handles.
- When locking the doors using the door handle request switch, make sure to have the Intelligent Key in your possession before operating the door handle request switch to prevent the Intelligent Key from being left in the vehicle.
- The door handle request switch is operational only when the Intelligent Key has been detected by the Intelligent Key system.
- Do not pull the door handle before pushing the door handle request switch. The door will be unlocked but will not open. Release the door handle once and pull it again to open the door.

## Request switch locations

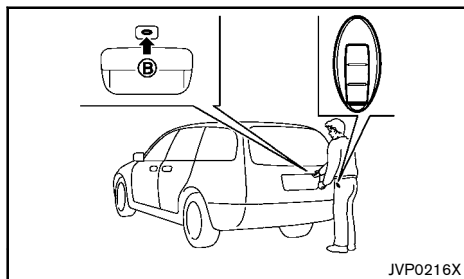
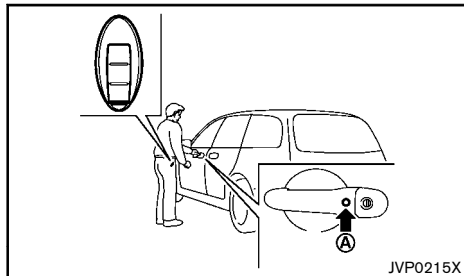

When you carry the Intelligent Key with you, you can lock or unlock all doors by pushing the door handle request switch (driver's or front passenger's) (A) or back door request switch (B) within the range of operation.

When you lock or unlock the doors, the hazard indicator will flash as a confirmation.

## Locking doors

1. Push the ignition switch to the "OFF" position.
2. Carry the Intelligent Key with you.
3. Close all doors.
4. Push the door handle request switch (A) (driver's or front passenger's) or the back door request switch (B).
5. All doors and the back door will be locked.
6. The hazard indicator flashes once.
7. Operate door handles to confirm that the doors have been securely locked.

### Lockout protection:

To prevent the Intelligent Key from being accidentally locked in the vehicle, lockout protection is equipped with the Intelligent Key system.

- When the Intelligent Key is left in the vehicle and you try to lock the door using the driver's inside lock knob after getting out of the vehicle, all the doors will unlock automatically and a chime will sound after the door is closed.
- When the Intelligent Key is left in the vehicle while the driver's door is opened and you try to lock the door using the power door lock switch after getting out of the vehicle, an inside warning chime will sound after the power door lock switch or the driver's inside lock knob is operated.



### CAUTION:

**The lockout protection may not function under the following conditions:**

- **When the Intelligent Key is placed on top of the instrument panel.**

- **When the Intelligent Key is placed inside of the glove box.**
- **When the Intelligent Key is placed inside of the door pockets.**
- **When the Intelligent Key is placed on or under the spare tire area.**
- **When the Intelligent Key is placed inside or near metallic materials.**

**The lockout protection may function when the Intelligent Key is outside the vehicle but is too close to the vehicle.**

## Unlocking doors

### All door unlock:

1. Carry the Intelligent Key with you.
2. Push the door handle request switch (A) or back door request switch (B).
3. All doors and the back door will be unlocked.
4. The hazard indicator flashes twice.

If a door handle is pulled while unlocking the doors, that door may not be unlocked. Returning the door handle to its original position will unlock the door. If the door does not unlock, after returning the door handle, push the door handle request switch to unlock the door.

### Selective door unlock mode:

1. Carry the Intelligent Key with you.
2. Push the door handle request switch (driver's or front passenger's) (A) or back door request switch (B).
3. The corresponding door will be unlocked.

4. Push the door handle request switch (driver's or front passenger's) **(A)** or back door request switch **(B)** again within 5 seconds.
5. All doors will be unlocked.

#### **Switching door unlock mode (if equipped):**

To switch the door unlock mode from one to another, see "Using remote keyless entry system" (P.3-8).

#### **Automatic relock:**

All doors will be locked automatically unless one of the following operations is performed within 30 seconds after pushing the request switch while the doors are locked.

- Opening any doors.
- Pushing the ignition switch.

If during the preset time period the "UNLOCK"  button on the Intelligent Key is pushed, all doors will be locked automatically after the next preset time.

#### **BATTERY SAVER SYSTEM**

When all the following conditions are met for a period of time, the battery saver system will cut off the power supply to prevent battery discharge.

- The ignition switch is in the "ACC" position, and
- All doors are closed, and
- The shift lever is in the "P" (Park) position (Automatic transmission/Continuously Variable Transmission model).

#### **WARNING AND AUDIBLE REMINDERS**

The Intelligent Key system is equipped with a function that is designed to minimize improper operations of the Intelligent Key and to help prevent the vehicle from being stolen.

##### **Type A (model with vehicle information display)**

The warning buzzer sounds and the warning display appears on the dot matrix display (in the vehicle information display) when improper operations are detected. See the troubleshooting guide on the next page. For warning and indicators on the vehicle information display, see "Vehicle information display" (P.2-20).



#### **CAUTION:**

**When the buzzer sounds and the warning display appears, be sure to check both the vehicle and the Intelligent Key.**

##### **Type B (model without dot matrix display)**

A chime or beep sounds inside and outside the vehicle and a warning light illuminates or blinks.

See the troubleshooting guide on the next page and "Warning/indicator lights and audible reminders" (P.2-12).

Intelligent Key system warning light: 

P position selecting warning light: 



#### **CAUTION:**

**When the chime or beep sounds or the warning light illuminates or blinks, be sure to check both the vehicle and the Intelligent Key.**

## TROUBLE SHOOTING GUIDE

Symptom		Possible cause	Action to take
When pushing the ignition switch to stop the engine	Type A: The SHIFT P warning appears on the display and the inside warning chime sounds continuously or for a few seconds. Type B: The P position selecting warning light in the meter and the inside warning chime sounds continuously (Automatic Transmission and Continuously Variable Transmission models).	The shift lever is not in the "P" (Park) position.	Shift the shift lever to the "P" (Park) position.
When shifting the shift lever to the P (Park) position. (Automatic Transmission and Continuously Variable Transmission models)	The inside warning chime sounds continuously.	The ignition switch is in the "ACC" or "ON" position.	Push the ignition switch to the "OFF" position.
When opening the driver's door to get out of the vehicle	The inside warning chime sounds continuously.	The ignition switch is in the "ACC" position.	Push the ignition switch to the "OFF" position.
When closing the door after getting out of the vehicle	Type A: The NO KEY warning appears on the display, the outside chime sounds 3 times and the inside warning chime sounds for a few seconds. Type B: The Intelligent Key system warning light in the meter blinks in yellow, the outside chime sounds 3 times and the inside warning chime sounds for a few seconds.	The ignition switch is in the "ACC" or "ON" position.	Push the ignition switch to the "OFF" position.
	Type A: The SHIFT P warning appears on the display and the outside chime sounds continuously. Type B: The P position selecting warning light in the meter illuminates and the outside chime sounds continuously (Automatic Transmission and Continuously Variable Transmission models).	The ignition switch is in the "ACC" or "OFF" position and the shift lever is not in the "P" (Park) position.	Move the shift lever to the "P" (Park) position and push the ignition switch to the "OFF" position.
When pushing the request switch or the "LOCK"  button on the Intelligent Key to lock the door	The outside chime sounds for a few seconds and all the doors unlock.	The Intelligent Key is inside the vehicle.	Carry the Intelligent Key with you.
		The ignition switch is in the "ACC" or "ON" position.	Push the ignition switch to the "OFF" position.
		A door is not closed securely.	Close the door securely.

Symptom		Possible cause	Action to take
When pushing the door handle request switch to lock the door	The outside chime sounds for a few seconds.	The Intelligent Key is inside the vehicle.	Carry the Intelligent Key with you.
		A door is not closed securely.	Close the door securely.
When pushing the ignition switch to start the engine	Type A: The Intelligent Key battery indicator appears on the display. Type B: The Intelligent Key system warning light in the meter blinks in green.	The battery charge is low.	Replace the battery with a new one. (See "Battery" (P.8-24).)
	Type A: The NO KEY warning appears on the display and the inside warning chime sounds for a few seconds. Type B: The Intelligent Key system warning light in the meter blinks in yellow and the inside warning chime sounds for a few seconds.	The Intelligent Key is not in the vehicle.	Carry the Intelligent Key with you.

## USING REMOTE KEYLESS ENTRY FUNCTION

### Operating range

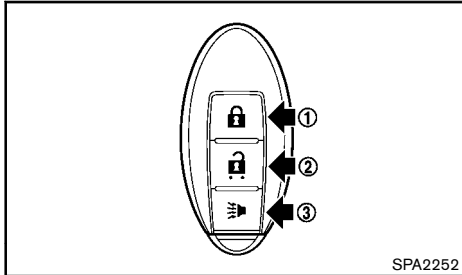

**Type A (with panic alarm)**

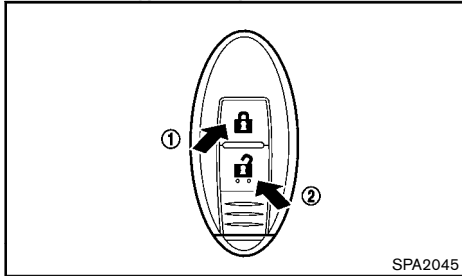

**Type B (without panic alarm)**

It is possible to lock/unlock all doors including the back door using the remote keyless entry system. The operating distance depends upon the conditions around the vehicle. To securely operate the lock and unlock buttons, approach the vehicle to about 1 m (3.3 ft) from the door.

The remote keyless entry system will not function under the following conditions:

- When the Intelligent Key is not within the operational range.
- When the Intelligent Key battery is discharged.

For information regarding the replacement of a battery, see “Battery” (P.8-24).

### Locking doors

When you lock or unlock the doors including the back door, the hazard indicator will flash as a confirmation.

1. Place the ignition switch in the “OFF” position and carry the Intelligent Key.
2. Close all doors (including the back door).
3. Push the “LOCK”  button ① on the Intelligent Key.
4. All doors will be locked.
5. Operate the door handles to confirm that the doors have been securely locked.





### CAUTION:

**After locking the doors using the Intelligent Key, be sure that the doors have been securely locked by operating the door handles.**

### Unlocking doors



1. Push the “UNLOCK”  button ② on the Intelligent Key.
2. All doors (including the back door) will be unlocked.

All doors will be locked automatically unless one of the following operations is performed within 30 seconds after pushing the “UNLOCK”  button on the Intelligent Key while the doors are locked. If during this



30-second time period, the “UNLOCK”  button on the Intelligent Key is pushed, all doors will be locked automatically after another 30 seconds.

- Opening any door or back door.
- Pushing the ignition switch.



### Selecting door unlock mode (if equipped):

When you first receive the vehicle, the door unlock mode is set to unlock all the doors with one push of the “UNLOCK”  button ②. The door unlock mode can be switched to the selective door unlock mode, which unlocks the passenger’s doors at the second push of the “UNLOCK”  button ②.

Selective door unlock mode:

1. Push the “UNLOCK”  button ② on the Intelligent Key.
2. The driver’s door unlocks.
3. Push the “UNLOCK”  button ② on the Intelligent Key again.
4. All doors will be unlocked.

To switch to the selective door unlock mode, perform the following procedure.

Push the “LOCK”  and “UNLOCK”  buttons simultaneously for more than 5 seconds. Perform the same procedure to deactivate the selective door unlock mode.

- When the selective door unlock mode is set, the hazard indicator flashes 3 times.
- When the all door unlock mode is set, the hazard indicator flashes once.

## SECURITY SYSTEM (if equipped)

### Using panic alarm (if equipped)

If you are near your vehicle and feel threatened, you may activate the alarm to call attention as follows:

1. Push the "PANIC"  button ③ on the Intelligent Key for **more than 0.5 second**.
2. The theft warning alarm will stay on for 25 seconds.
3. The panic alarm stops when:
  - It has run for 25 seconds, or
  - Any of the buttons on the Intelligent Key are pushed. (Note: Panic button should be pushed for more than 0.5 second.)

### Hazard indicator operation (if equipped)

When you lock or unlock the doors, the hazard indicator will flash as a confirmation.

- "LOCK": The hazard indicator flashes once.
- "UNLOCK": The hazard indicator flashes twice.

Your vehicle is equipped with either or both of the following security systems:

- Theft warning system
- NISSAN Anti-Theft System (NATS)\* (\* immobilizer)

The security condition will be shown by the security indicator light.

### THEFT WARNING SYSTEM

The theft warning system provides visual and audio alarm signals if parts of the vehicle are disturbed.

### Security indicator light

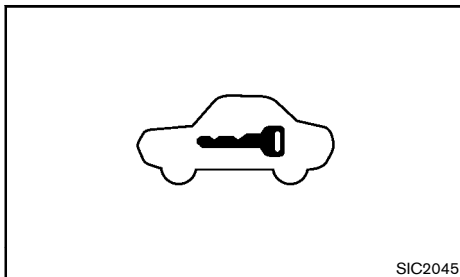

The security indicator light is located in the meter panel.

This light operates whenever the ignition switch is in the "ACC", "OFF" or "LOCK" position. This is normal.

### How to activate the system:

1. Close all windows and push the ignition switch to the "OFF" position.

**The system can be activated even if the windows are open.**

2. Carry the Intelligent Key with you and get out of the vehicle.
3. Make sure the hood is closed. Close and lock all doors with the door handle request switch, LOCK  button ① on the Intelligent Key (If the door is locked using the inside lock knob, the system will not be activated) or power door lock switch (If the door is locked using the power door lock switch with all the doors closed, the system will not be activated. To activate the system, lock the door using the power door lock switch with any of the doors open, then close all the doors).
4. Confirm that the security indicator light comes on. The security indicator light stays on for approximately 30 seconds. The vehicle security system is now pre-armed. After approximately 30 seconds the vehicle security system automatically shifts into the armed phase. The security light begins to flash once every approximately 3 seconds.

If, during this 30-second pre-arm time period, the door is unlocked with the door handle request switch, the "UNLOCK"  button ② on the Intelligent Key, the power door lock switch, or the ignition switch is pushed to the "ACC" or "ON" position, the system will not arm.

**Even when the driver and/or passengers are in the vehicle, the system will activate with all doors locked and ignition switch in the "LOCK" position. Push the ignition switch to the "ACC" or "ON" position to turn the system off.**

### Theft warning system operation:

The warning system will give the following alarm:

- The hazard indicator blinks and the horn sounds intermittently for approximately 30 seconds.



- The alarm automatically turns off after approximately 30 seconds. However, the alarm reactivates if the vehicle is tampered with again.

The alarm is activated by:

- Operating the door without using the Intelligent Key system.
- Opening the hood.

#### How to stop alarm:

- The alarm will stop by unlocking a door with the door handle request switch or “UNLOCK”  button ② on the Intelligent Key.
- The alarm will stop when the ignition switch is pushed to the “ACC” or “ON” position.

**If the system does not operate as described above, have it checked by a NISSAN dealer.**

#### NISSAN ANTI-THEFT SYSTEM (NATS)

The NISSAN Anti-Theft System (NATS) will not allow the engine to start without the use of the registered NATS key.

If the engine does not start using the registered NATS key, it may be due to interference caused by:

- Another NATS key.
- Automated toll road device.
- Automated payment device.
- Other devices that transmit similar signals.

Start the engine using the following procedure:

1. Remove any items that may be causing the interference away from the NATS key.
2. Leave the ignition switch in the “ON” position for approximately 5 seconds.
3. Turn the ignition switch to the “OFF” or “LOCK” position, and wait approximately 10 seconds.

4. Repeat steps 2 and 3 again.
5. Start the engine.
6. Repeat the steps above until all possible interferences are eliminated.

If this procedure allows the engine to start, NISSAN recommends placing the registered NATS key separate from other devices to avoid interference.

#### FCC WARNING:

**Changes or modifications not expressly approved by the party responsible for compliance could void the user's authority to operate the equipment.**

**This device complies with Part 15 of the FCC Rules. Operation is subject to the following two conditions; (1) This device may not cause harmful interference, and (2) this device must accept any interference received, including interference that may cause undesired operation of the device.**

#### Security indicator light

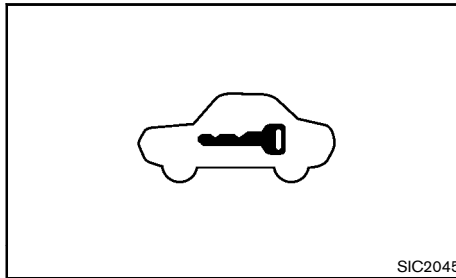

The security indicator light is located on the meter panel. It indicates the status of NATS.

The light operates whenever the ignition switch is in

the “LOCK”, “OFF” or “ACC” position. The security indicator light indicates that the security systems on the vehicle are operational.

If NATS is malfunctioning, this light will remain on while the ignition switch is in the “ON” position.

**If the light remains on and/or the engine does not start, contact a NISSAN dealer for NATS service as soon as possible. Be sure to bring all NATS keys that you have when visiting a NISSAN dealer for service.**

#### For Right-Hand Drive (RHD) model (for Europe):

If NATS is malfunctioning, the security indicator light will illuminate when the ignition switch is in the “ON” position. However, if the security indicator light turns off after 15 minutes, you can start the engine once. See a NISSAN dealer for NATS service as soon as possible.

## HOOD



### WARNING:

- The hood must be closed and latched securely before driving. Failure to do so could cause the hood to fly open and result in an accident.
- Never open the hood if steam or smoke is coming from the engine compartment to avoid injury.

## OPENING HOOD

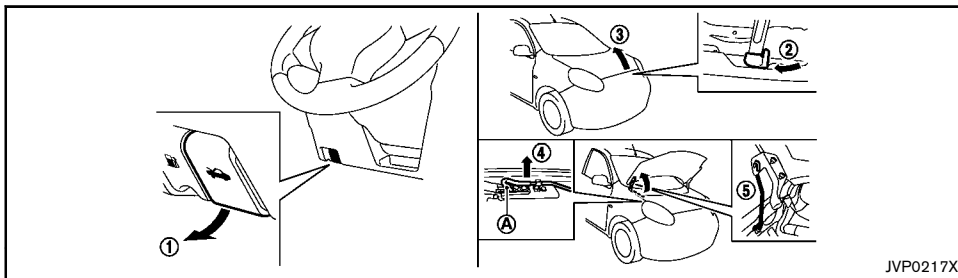

1. Pull the hood lock release handle (1) located below the instrument panel until the hood springs up.
2. Locate the lever (2) in between the hood and grille and push the lever sideways with your fingertips.
3. Raise the hood (3).
4. Remove the support rod (4) and insert it into the slot (5).

**Hold the coated parts (A) when removing or resetting the support rod. Avoid direct contact with the metal parts, as they may be hot immediately after the engine has been stopped.**

## CLOSING HOOD

1. While supporting the hood, return the support rod to its original position.
2. Slowly lower the hood to about 20 to 30 cm (8 to 12 in) above the hood lock, then let it drop.
3. Make sure it is securely latched.



### CAUTION:

**Before closing the hood, be sure to release the support rod and store it in position. Otherwise, the support rod will be damaged.**

## BACK DOOR



### WARNING:

**Make sure the back door has been closed securely to prevent it from opening while driving. Do not drive with the back door open. This could allow dangerous exhaust gases to be drawn into the vehicle.**

### OPENING BACK DOOR

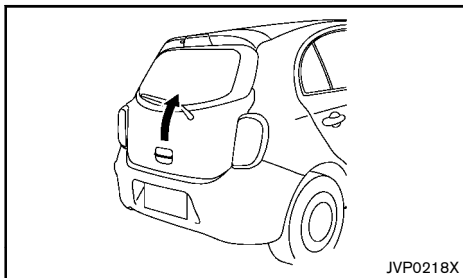

#### For model with the door key cylinder

The back door can be opened by pulling the opener handle and pulling up the back door.

To close the back door, pull down until it securely locks.

#### For model without the door key cylinder

To open the back door, unlock it with one of the following operations, then pull the handle.

- Push the back door request switch (if equipped). (See "Intelligent Key system" (P.3-9).)
- Push the "UNLOCK" button on the Intelligent Key (if equipped). (See "Intelligent Key system" (P.3-9).)

- Push the "UNLOCK" button on the remote controller (if equipped). (See "Remote keyless entry system" (P.3-7).)
- Push the power door lock switch to the "UNLOCK" position.

Locking with key (for model with the door key cylinder)

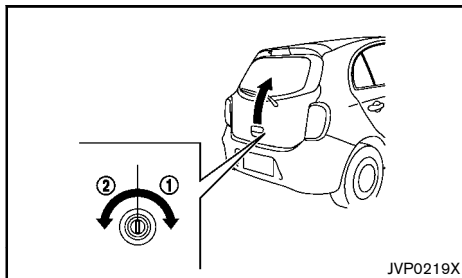

To lock the back door, push it down firmly, insert the key to the door key cylinder and turn the key clockwise ①. To unlock the back door, turn the key counter-clockwise ②.

## FUEL FILLER LID



### WARNING:

- Fuel is extremely flammable and highly explosive under certain conditions. You could be burned or seriously injured if it is misused or mishandled. Always stop the engine and do not smoke or allow open flames or sparks near the vehicle when refueling.
- Fuel may be under pressure. Turn the cap a half of a turn, and wait for any "hissing" sound to stop to prevent fuel from spraying out and possibly causing personal injury. Then remove the cap.
- Use only an original equipment type fuel filler cap as a replacement. It has a built-in safety valve needed for proper operation of the fuel system and emission control system. An incorrect cap can result in a serious malfunction and possible injury.

### OPENING FUEL FILLER LID

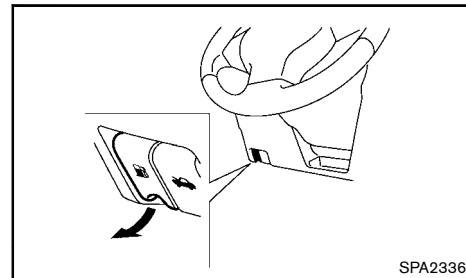

To open the fuel filler lid, pull the fuel filler lid release handle.

## FUEL FILLER CAP

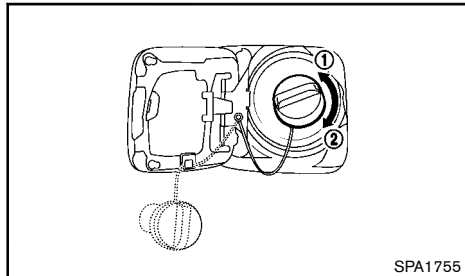

The fuel filler cap is a ratcheting type. Turn the cap counterclockwise ① to remove. Tighten the cap clockwise ② until ratchet clicks, more than twice, after refueling.



### CAUTION:

**If fuel is spilled on the vehicle body, flush it away with water to avoid paint damage.**

## STEERING WHEEL



### WARNING:

**Never adjust the steering wheel while driving so that full attention may be given to vehicle operation.**

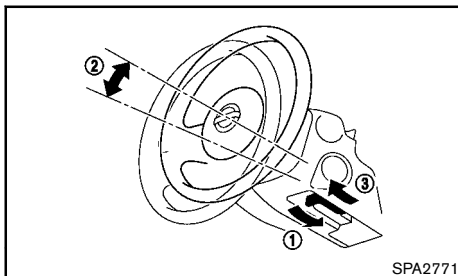

While pushing the lock lever down ①, adjust the steering wheel up or down ② until the desired position is achieved.

Pull the lock lever up ③ firmly to lock the steering wheel in place.

## MIRRORS



### WARNING:

**Adjust the position of all mirrors before driving. Do not adjust the mirror positions while driving so that full attention may be given to vehicle operation.**

### INSIDE REARVIEW MIRROR

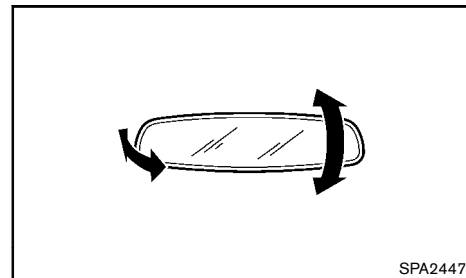

While holding the inside rearview mirror, adjust the mirror angles until the desired position is achieved.

### Manual anti-glare type

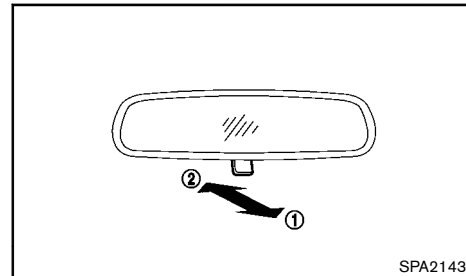

Pull the adjusting lever ① (if equipped) when the

glare from the headlights of the vehicle behind you obstructs your vision at night.

Push the adjusting lever ② (if equipped) during the day for the best rearward visibility.

### Automatic anti-glare type

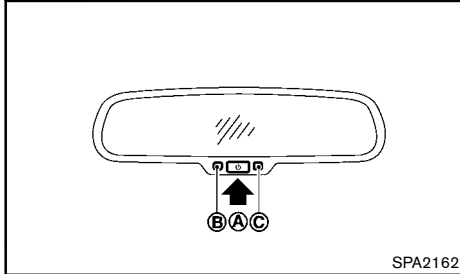

The inside rearview mirror is designed so that it automatically changes reflection according to the intensity of the headlights of the vehicle following you.

The anti-glare system will be automatically turned on when you turn the ignition switch to the "ON" position.

When the system is turned on, the indicator light ① will illuminate and excessive glare from the headlights of the vehicle behind you will be reduced.

Push the POWER ON/OFF button ② for 3 seconds to make the inside rearview mirror operate normally and the indicator light will turn off. Push the POWER ON/OFF button again for 3 seconds to turn the system on.

When the shift lever is moved into the "R" (Reverse) position, the monitor display shows the view to the rear of the vehicle. (See "Rearview monitor" (P.4-2))

**Do not hang any objects on the mirror or apply glass cleaner. Doing so will reduce the sensitivity of the sensor ③, resulting in improper**

### operation.

### OUTSIDE REARVIEW MIRRORS



### WARNING:

- **Never touch the outside rearview mirrors while they are in motion. Doing so may pinch your fingers or damage the mirror.**
- **Never drive the vehicle with the outside rearview mirrors folded. This reduces rear view visibility and may lead to an accident.**
- **Objects viewed in the outside mirror are closer than they appear. (if equipped)**
- **The picture dimensions and distance in the outside mirrors are not real.**

### Adjusting

### Remote control type (if equipped):

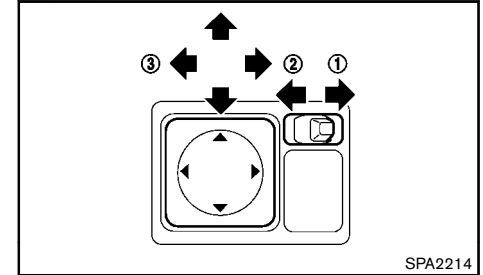

The outside rearview mirror remote control operates when the ignition switch is in the "ACC" or "ON" position.

1. Move the switch to select the right ① or left ② mirror.
2. Adjust each mirror until the desired position is achieved ③.

### Lever control type (if equipped):

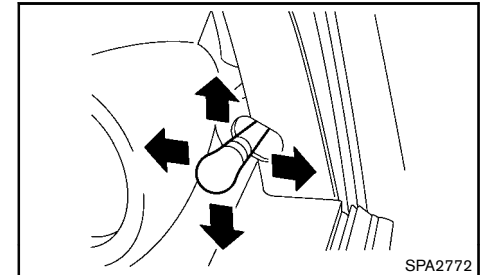

Adjust the mirror angles with the inside lever until the desired position is achieved.

### Manual control type (if equipped):

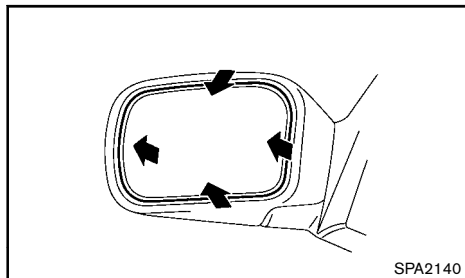

Push on the mirror surface directly to adjust it to the desired position.

### Defogging (if equipped)

The outside rearview mirrors will be heated when the rear window defogger switch is operated.

### Folding

#### Remote control type (if equipped):

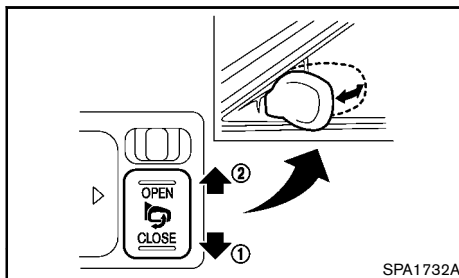

The outside rearview mirror remote control operates when the ignition switch is in the "ACC" or "ON" position.

The outside rearview mirror automatically fold when the outside rearview mirror folding switch is pushed to the "CLOSE" position ① . To unfold, push to the "OPEN" position ② .

#### CAUTION:

- Continuously performing the fold/unfold operation of the outside rearview mirror may cause the switch to stop the operation.
- Do not touch the mirrors while they are moving. Your hand may be pinched, and the mirror may malfunction.
- Do not drive with the mirrors stored. You will be unable to see behind the vehicle.
- If the mirrors were folded or unfolded by hand, there is a chance that the mirror will move forward or backward during driving. If the mirrors were folded or unfolded by hand,

be sure to adjust them again electrically before driving.

#### Automatic folding function with interlocking door lock (if equipped):

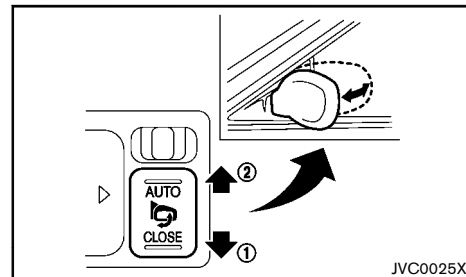

The outside rearview mirrors fold automatically by interlocking door lock. The function can be used while the switch is in the "AUTO" position ② .

- The outside rearview mirrors fold automatically when the door is locked by the door handle request switch or the remote keyless entry system.
- The outside rearview mirrors unfold when the ignition switch is placed in the "ACC" or "ON" position.

#### CAUTION:

When the outside rearview mirror is folded/unfolded manually, the mirror may fold/unfold accidentally while driving. Be sure to fold/unfold the outside rearview mirror by an electrical operation after folding/unfolding manually.

**WARNING:**

- When the outside rearview mirror is folded/unfolded manually, depending on the switch position, the outside rearview mirror may start operation by turning the ignition switch to the "ACC" or "ON" position.
- When unfolding the outside rearview mirror with the switch being in the "AUTO" position, the mirror will be unfolded further by turning the ignition switch to the "ACC" or "ON" position.

To return its original position, fold the outside rearview mirror once.

The outside rearview mirror remote control operates when the ignition switch is in the "ACC" or "ON" position.

The outside rearview mirrors automatically fold when the outside rearview mirror folding switch is pushed to the "CLOSE" position ①. To unfold, push to the "AUTO" position ②.

**CAUTION:**

Continuously performing the fold/unfold operation of the outside rearview mirror may cause the switch to stop the operation.

**Manual control type (if equipped):**

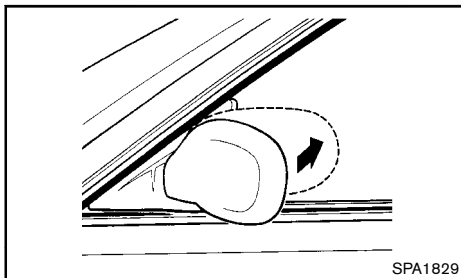

Fold the outside rearview mirror by pushing it toward the rear of the vehicle.

**VANITY MIRRORS (if equipped)**

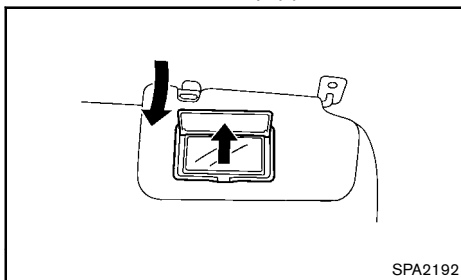

To access the vanity mirror, pull the sun visor down and pull up the mirror cover.

## PARKING BRAKE

**WARNING:**

- Never drive the vehicle with the parking brake applied. The brake will overheat and fail to operate and will lead to an accident.
- Never release the parking brake from outside the vehicle. If the vehicle moves, it will be impossible to push the foot brake pedal and will lead to an accident.
- Never use the shift lever in place of the parking brake. When parking, be sure the parking brake is fully applied.
- Never leave children or adults who would normally require the support of others alone in your vehicle. They could unknowingly release the parking brake and inadvertently become involved in a serious accident.

**LEVER TYPE**

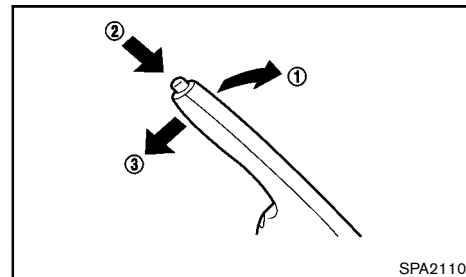

To apply the parking brake, pull the parking brake lever up ①.

To release the parking brake, firmly depress and hold the foot brake pedal. Pull up the parking brake lever slightly, push the button ② and lower the lever ③.

completely ③.

Before driving, be sure that the brake warning light has turned off.



**MEMO**

# 4 Monitor, Heater and air conditioner, and audio system

Safety precautions .....	4-2	FM-AM radio with Compact Disc (CD) player (Type A) ....	4-20
Rearview monitor (if equipped) .....	4-2	FM-AM radio with Compact Disc (CD) player (Type B) ....	4-24
How to read displayed lines .....	4-2	FM-AM radio with Compact Disc (CD) player (Type C) ....	4-29
Difference between predictive and actual distances .....	4-3	FM-AM radio with Compact Disc (CD) player (Type D) ....	4-33
Mirror display operation .....	4-4	FM-AM radio with Compact Disc (CD) player (Type E) ....	4-38
Operating tips .....	4-4	FM-AM radio with Compact Disc (CD) player (Type F) ....	4-44
Ventilators .....	4-5	LW-MW-FM radio with compact disc (CD) player .....	4-52
Side ventilators .....	4-5	LW-MW-FM radio with compact disc (CD) changer .....	4-57
Center ventilators .....	4-5	FM-AM radio with Compact Disc (CD) player and	
Heater and air conditioner (if equipped) .....	4-6	navigation (if equipped) .....	4-62
Operating tips (for automatic air conditioner) .....	4-6	Steering wheel switch for audio control (if equipped) ....	4-63
Manual air conditioner .....	4-7	CD/USB memory care and cleaning .....	4-63
Automatic air conditioner .....	4-9	Car phone or CB radio .....	4-64
Servicing air conditioner .....	4-10	Bluetooth® Hands-Free Phone System (if equipped for model	
Audio system (if equipped) .....	4-11	without navigation system) .....	4-64
Audio operation precautions .....	4-11	Regulatory information .....	4-65
Antenna (if equipped) .....	4-19	CE statement .....	4-65
		Hands-Free Phone System (Type A) .....	4-65
		Hands-Free Phone System (Type B) .....	4-71

## SAFETY PRECAUTIONS



### WARNING:

- Do not adjust the heater and air conditioner controls or audio controls while driving so that full attention may be given to vehicle operation.
- If you noticed any foreign objects entering the system hardware, spilled liquid on the system, or noticed smoke or fumes coming out from the system, or any other unusual operation is observed, stop using the system immediately and contact the nearest NISSAN dealer. Ignoring such conditions may lead to an accident, fire or electric shock.
- Do not disassemble or modify this system. If you do, it may lead to an accident, fire, or electric shock.



### CAUTION:

Do not use the system when the engine is not running for extended periods of time to prevent battery discharge.

## REARVIEW MONITOR (if equipped)

When the shift lever is shifted into the "R" (Reverse) position, the monitor display shows a rearward view from the vehicle.

The system is designed as an aid to the driver in situations such as slot parking or parallel parking.

Designs and items displayed on the screen may vary depending on the models.



### WARNING:

- The rearview monitor is a convenience but it is not a substitute to check behind the vehicle when backing up. The driver is always responsible for safety during parking and other manoeuvres.
- Objects viewed in the rearview monitor differ from actual distance because a wide-angle lens is used. Objects in the rearview monitor will appear visually opposite than when viewed in the inside and outside rearview mirrors.
- Make sure that the back door is securely closed when backing up.
- Underneath the bumper and the corner areas of the bumper cannot be viewed on the rearview monitor because of its monitoring range limitation.
- Do not put anything on the rearview camera. The rearview camera is installed above the license plate.
- When washing the vehicle with high-pressure water, be sure not to spray it around the camera. Otherwise, water may enter the camera unit causing water condensation on the lens, a malfunction, fire or an electric shock.

- Do not strike the camera. It is a precision instrument. Otherwise, it may malfunction or cause damage resulting in a fire or an electric shock.



### CAUTION:

Do not scratch the camera lens when cleaning dirt or snow from the lens.

## HOW TO READ DISPLAYED LINES

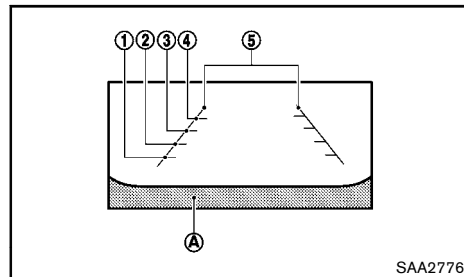

Guide lines which indicate the vehicle width and distances to objects with reference to the bumper line (A) are displayed on the monitor.

### Distance guide lines:

Indicate distances from the vehicle body.

- Red line ① : approx. 0.5 m (1.5 ft)
- Yellow line ② : approx. 1 m (3 ft)
- Green line ③ : approx. 2 m (7 ft)
- Green line ④ : approx. 3 m (10 ft)

### Vehicle width guide lines ⑤ :

Indicate the vehicle width when backing up.

## DIFFERENCE BETWEEN PREDICTIVE AND ACTUAL DISTANCES

### Backing up on a steep uphill

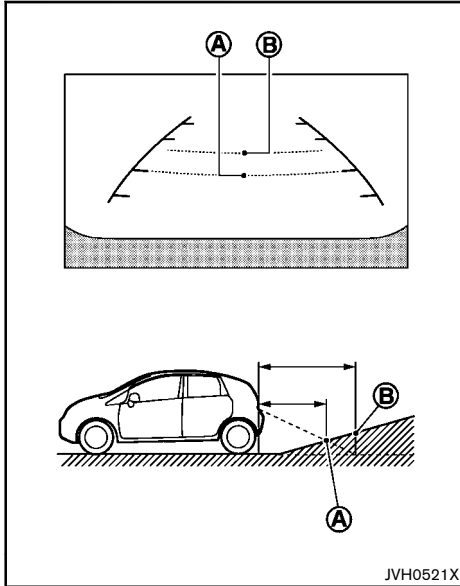

When backing up the vehicle up a hill, the distance guide lines and the vehicle width guide lines are shown closer than the actual distance. For example, the display shows 1 m (3 ft) to the place **(A)**, but the actual 1 m (3 ft) distance on the hill is the place **(B)**. Note that any object on the hill is viewed in the monitor further than it appears.

### Backing up on a steep downhill

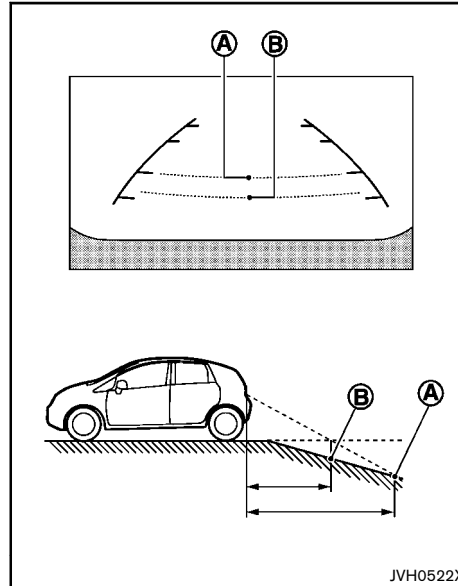

When backing up the vehicle down a hill, the distance guide lines and the vehicle width guide lines are shown further than the actual distance. For example, the display shows 1 m (3 ft) to the place **(A)**, but the actual 1 m (3 ft) distance on the hill is the place **(B)**. Note that any object on the hill is viewed in the monitor closer than it appears.

### Backing up near a projecting object

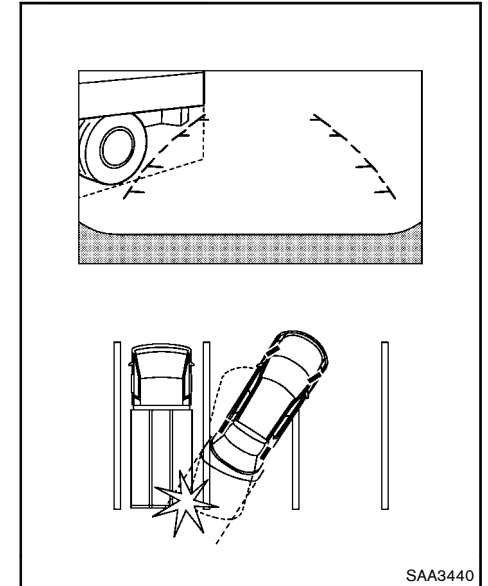

The vehicle may seem to nearly clear the object in the display. However, the vehicle may hit the object if it projects over the actual backing up course.

## Backing up behind a projecting object

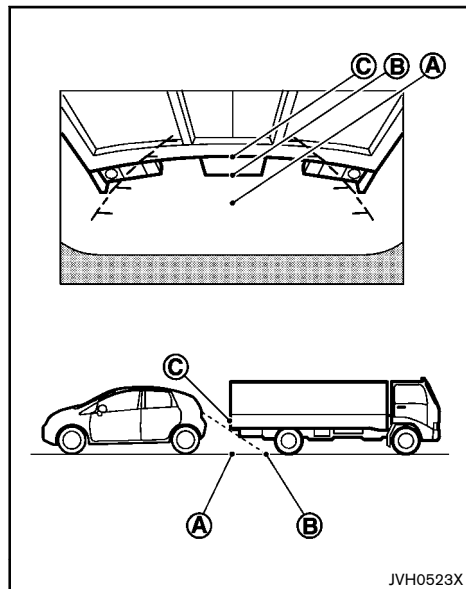

The position **C** is shown further than the position **B** in the display. However, the position **C** is actually at the same distance as the position **A**. The vehicle may hit the object when backing up to the position **A** if the object projects over the actual backing up course.

## MIRROR DISPLAY OPERATION

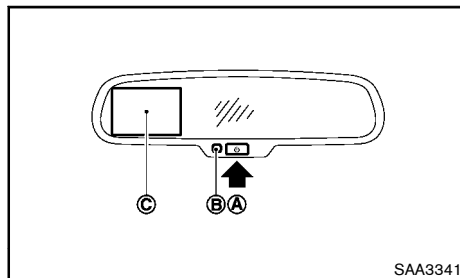

### Rearview monitor on/off

The rearview monitor **C** is displayed automatically when the shift lever is moved to the "R" (Reverse) position.

To turn off the rearview monitor **C**, push the POWER ON/OFF button **A**. The indicator light **B** will illuminate in orange.

To return to the display the rearview monitor **C**, push the POWER ON/OFF button **A** again or turn the ignition switch to the "OFF" position. The indicator light **B** will illuminate in green.

To set the rearview monitor to be always not displayed, push and hold the POWER ON/OFF button **A** for 12 seconds or more when the shift lever is in the "R" (Reverse) position. The indicator light **B** turns off and then turns back on in approximately 2 seconds.

Whenever the rearview monitor is off, by switching the ignition switch to the "ON" position and then pressing the POWER ON/OFF button **A** while the shift lever is in the "R" (Reverse) position, the rearview monitor will be displayed again on the mirror display.

## Language select mode

To change the language of the warning text displayed on the mirror display, push and hold the POWER ON/OFF button **A** for 6 to 11 seconds when the shift lever is in the "R" (Reverse) position. When the language select screen is displayed push the POWER ON/OFF button **A** repeatedly until the preferred language is displayed.

**If the button is not pushed for approximately 5 seconds, the language select mode will automatically return to the normal mode.**

## OPERATING TIPS

- When the view is switched, the display images on the screen may be displayed with some delay.
- When the temperature is extremely high or low, the screen may not clearly display objects. This is not a malfunction.
- When strong light is directly coming on the camera, objects may not be displayed clearly. This is not a malfunction.
- Vertical lines may be seen in objects on the screen. This is due to strong reflected light from the bumper. This is not a malfunction.
- The screen may flicker under fluorescent light. This is not a malfunction.
- The colors of objects on the rearview monitor may differ somewhat from the actual color of objects. This is not a malfunction.
- Objects on the monitor may not be clear in a dark environment. This is not a malfunction.
- If dirt, rain or snow accumulates on the camera, the rearview monitor may not display objects clearly. Clean the camera.

## VENTILATORS

- Do not use alcohol, benzene or thinner to clean the camera. This will cause discoloration. To clean the camera, wipe with a cloth dampened with diluted mild cleaning agent and then wipe with a dry cloth.
- Do not damage the camera as the monitor screen may be adversely affected.
- Do not use wax on the camera window. Wipe off any wax with a clean cloth dampened with mild detergent diluted with water.
- While the shift lever is in the "R" (Reverse) position, the automatic anti-glare function is not operated.

### SIDE VENTILATORS

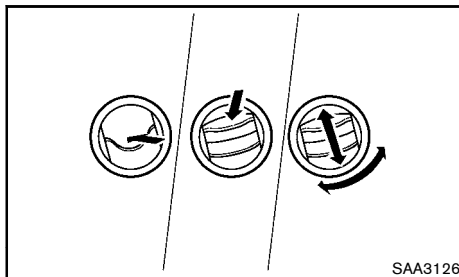

Adjust the air flow direction of the ventilators by opening, closing or rotating.

The side ventilators can be used for the side defogger.

### CENTER VENTILATORS

#### Square type

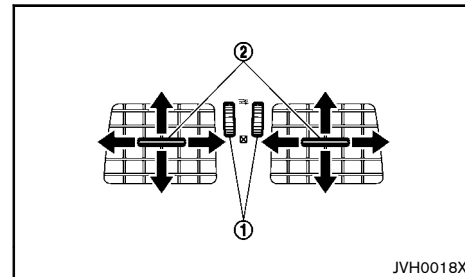

Open/close the ventilators by moving the control ① in either direction.

☒ : This symbol indicates that the ventilators are closed. Moving the side control in this direction will close the ventilators.

≡ : This symbol indicates that the ventilators are open. Moving the side control in this direction will open the ventilators.

Adjust the air flow direction of the ventilators by moving the center knob ② (up/down/left/right) until the preferred position is achieved.

## HEATER AND AIR CONDITIONER (if equipped)

Circle type

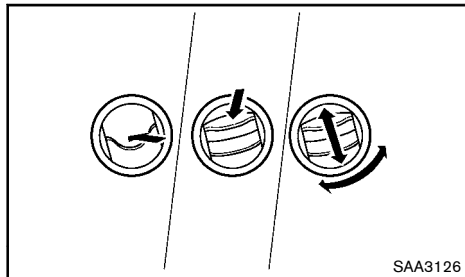

Adjust the air flow direction of the ventilators by opening, closing or rotating.

### **WARNING:**

- **The heater and air conditioner operate only when the engine is running.**
- **Never leave children or adults who would normally require the support of others alone in the vehicle. Pets should not be left alone either. They could unknowingly activate switches or controls and inadvertently become involved in a serious accident and injure themselves. On hot, sunny days, temperatures in a closed vehicle could quickly become high enough to cause severe or possibly fatal injuries to people or animals.**
- **Do not use the recirculation mode for long periods as it may cause the interior air to become stale and the windows to fog up.**
- **Do not adjust the heating and air conditioning controls while driving so that full attention may be given to vehicle operation.**

The heater and air conditioner operate when the engine is running. The air blower will operate when the ignition switch is in the "ON" position even if the engine is turned off.

### **For model with Stop/Start System (if equipped for Europe) or Idling Stop System (for Hong Kong):**

The Stop/Start System or Idling Stop System will not stop the engine under the following conditions:

- The front defogger mode is on. (automatic air conditioner)
- The air flow control dial is in the front defogger position. (manual air conditioner)

- The rear window defogger mode is on. While the engine is stopped by the Stop/Start System or Idling Stop System, taking one of the following actions will automatically start the engine:
- Turn the front defogger mode on. (automatic air conditioner)
- Turn the air flow control dial to the front defogger position. (manual air conditioner for Europe)
- The air flow control dial is in the front defogger position and the fan speed control dial is on. (manual air conditioner for Hong Kong)
- Turn the rear window defogger mode on.

When the engine is stopped by the Stop/Start System or Idling Stop System, performance of the heater and air conditioner may be reduced to minimize the fuel consumption. For the best heating and air conditioning performance, restart the engine by pushing the Stop/Start System or Idling Stop System OFF switch. (See "Stop/Start System OFF switch" (P.5-23) or "Idling Stop OFF switch" (P.5-21).)

### OPERATING TIPS (for automatic air conditioner)

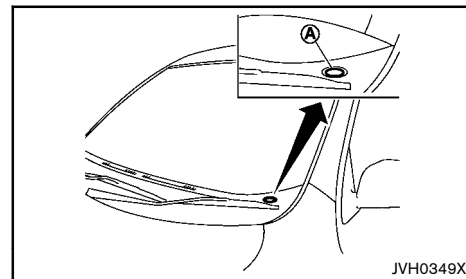

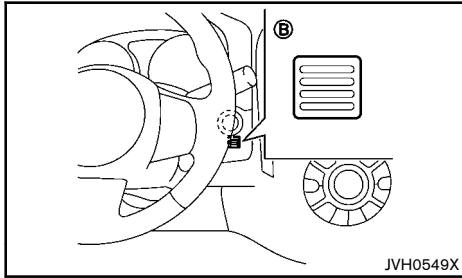

#### Left-Hand Drive (LHD) model\*

When the engine coolant temperature and outside air temperature are low, the air flow from the foot outlets may not operate. However, this is not a malfunction. After the coolant temperature warms up, the air flow from the foot outlets will operate normally.

The sensors (A) and (B), located on the instrument panel, help maintain a constant temperature. Do not put anything on or around the sensors.

\*: The illustration is for the Left-Hand Drive (LHD) model. For the Right-Hand Drive (RHD) model, the layout will be the opposite.

## MANUAL AIR CONDITIONER

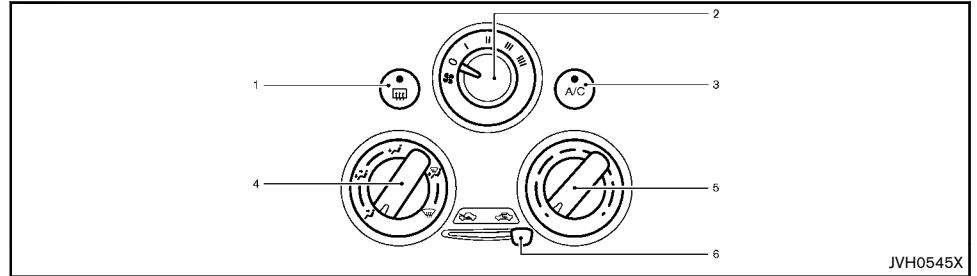

1. Rear window defogger switch (if equipped) (See "Defogger switch" (P.2-39).)
2. Fan speed control "☼" dial
3. "A/C" (Air Conditioner) button (if equipped)
4. Air flow control dial
5. Temperature control dial
6. Air intake lever (Outside air circulation "☞" /Air recirculation "☛")

To turn off the heater and air conditioner, turn the fan speed control "☼" dial to the "OFF" (0) position.

### Controls

#### Outside air circulation:

Move the air intake lever to the "☞" position. The air flow is drawn from outside the vehicle.

#### Air recirculation:

Move the air intake lever to the "☛" position. The air flow is circulated inside the vehicle.

#### Air flow control:

Turn the air flow control dial to change the air flow mode.

- Air flows from the center and side ventilators.
- Air flows from the center and side ventilators and foot outlets.
- Air flows mainly from the foot outlets.
- Air flows from the defogger and foot outlets.
- Air flows mainly from the defogger outlets.

#### Fan speed control:

Turn the fan speed control "☼" dial clockwise to increase the fan speed.

Turn the fan speed control "☼" dial counterclockwise to decrease the fan speed.





### Temperature control:

Turn the temperature control dial to set the desired temperature. Turn the dial between the middle and the right position to select the hot temperature. Turn the dial between the middle and the left position to select the cool temperature.

### Heater operation



#### Heating:

This mode is used to direct heated air to the foot outlets.

1. Move the air intake lever to the “” position for normal heating.
2. Turn the air flow control dial to the “” position.
3. Turn the fan speed control “” dial to the desired position.
4. Turn the temperature control dial to the desired position between the middle and the hot (right) position.





#### Ventilation:

This mode directs outside air to the side and center ventilators.

1. Move the air intake lever to the “” position.
2. Turn the air flow control dial to the “” position.
3. Turn the fan speed control “” dial to the desired position.
4. Turn the temperature control dial to the desired position.



### Defrosting or defogging:

This mode directs the air to the defogger outlets to defrost/defog the windows.

1. Move the air intake lever to the “” position.
  2. Turn the air flow control dial to the “” position.
  3. Turn the fan speed control “” dial to the desired position.
  4. Turn the temperature control dial to the desired position between the middle and the hot (right) position.
  5. Turn the side ventilators to the side windows to defrost or defog for a clear view to the side mirrors.
- To remove frost from the outside surface of the windshield quickly, turn the temperature control dial to the maximum hot position and the fan speed control “” dial to the maximum position.
  - If it is difficult to defog the windshield, turn the “A/C” button (if equipped) on.



### Bi-level heating:

This mode directs cool air from the side and center vents and warm air from the foot outlets. When the temperature control dial is turned to the maximum hot or cool position, the air between the ventilators and the foot outlets is the same temperature.

1. Move the air intake lever to the “” position.
2. Turn the air flow control dial to the “” position.
3. Turn the fan speed control “” dial to the desired position.
4. Turn the temperature control dial to the desired position.

### Heating and defogging:

This mode heats the interior and defogs the windows.





1. Move the air intake lever to the “” position.
2. Turn the air flow control dial to the “” position.
3. Turn the fan speed control “” dial to the desired position.
4. Turn the temperature control dial to the maximum hot (right) position.
5. Turn the side ventilators to the side windows to defrost or defog for a clear view to the side mirrors.

### Air conditioner operation (if equipped)

The air conditioner system should be operated for approximately 10 minutes at least once a month. This helps prevent damage to the air conditioner system due to the lack of lubrication.

#### Cooling:



This mode is used to cool and dehumidify the air.

1. Move the air intake lever to the “” position.
  2. Turn the air flow control dial to the “” position.
  3. Turn the fan speed control “” dial to the desired position.
  4. Push the “A/C” button on. (The “A/C” indicator light will illuminate.)
  5. Turn the temperature control dial to the desired position between the middle and the cool (left) position.
- For quick cooling when the outside temperature is high, move the air intake lever to the “” position. Be sure to move the air intake lever to the “” position for normal cooling.

- A visible mist may be seen coming from the ventilators in hot, humid conditions as the air is cooled rapidly. This does not indicate a malfunction.



### Dehumidified heating:

This mode is used to heat and dehumidify the air.

1. Move the air intake lever to the “” position.
2. Turn the air flow control dial to the “” position.
3. Turn the fan speed control “” dial to the desired position.
4. Push the “A/C” button on. (The “A/C” indicator light will illuminate.)
5. Turn the temperature control dial to the desired position between the middle and the hot (right) position.







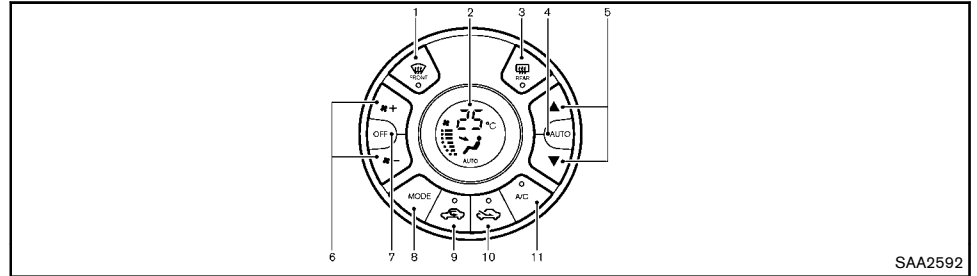

### Dehumidified defogging:

This mode is used to defog the windows and dehumidify the air.

1. Move the air intake lever to the “” position.
2. Turn the air flow control dial to the “” position.
3. Turn the fan speed control “” dial to the desired position.
4. Push the “A/C” button on. (The “A/C” indicator light will illuminate.)
5. Turn the temperature control dial to the desired position.
6. Turn the side ventilators to the side windows to defrost or defog the side mirrors.

## AUTOMATIC AIR CONDITIONER







1. Front fogger “” button
2. Display
3. Rear window defogger “” button (See “Defogger switch” (P.2-39).)
4. “AUTO” button
5. Temperature control “”/“” buttons
6. Fan speed control “ +” and “ -” buttons
7. “OFF” button
8. “MODE” (air flow control) button
9. Air recirculation “” button
10. Outside air circulation “” button
11. “A/C” (Air Conditioner) button

### Automatic operation (AUTO)

The AUTO mode may be used year-round as the system automatically controls constant temperature, air flow distribution and fan speed after the desired temperature is set manually.

To turn off the heater and air conditioner, push the “OFF” button.

### Cooling and dehumidified heating:

1. Push the “AUTO” button. (“AUTO” will appear on the display.)
2. If the “A/C” indicator light does not illuminate, push the “A/C” button. (The “A/C” indicator light will illuminate.)
3. Push the temperature control “”/“” button to set the desired temperature.
4. If the indicator light on either the outside air circulation “” button or the air recirculation “” button is illuminated, push and hold the button with the light illuminated to switch to the automatic air intake control mode.





A visible mist may be seen coming from the ventilators in hot, humid conditions as the air is cooled rapidly. This does not indicate a malfunction.

### Heating (A/C off):

1. Push the “AUTO” button. (“AUTO” will appear on the display.)
2. If the “A/C” indicator light illuminates, push the “A/C” button. (The “A/C” indicator light will turn off.)

3. Push the temperature control “▲”/“▼” button to set the desired temperature.
- Do not set the temperature lower than the outside air temperature. Doing so may cause the temperature to not be controlled properly.
  - If the windows fog up, use dehumidified heating instead of the A/C off heating.

### Dehumidified defrosting/defogging:





1. Push the front defogger “ ” button. (The “ ” indicator light will illuminate.)
  2. Push the temperature control “▲”/“▼” button to set the desired temperature.
- To remove frost from the outside surface of the windshield quickly, set the temperature to a high temperature and the fan speed to the maximum level.
  - After the windshield is cleared, push the front defogger “ ” button again. (The indicator light will turn off.)
  - When the front defogger “ ” button is pushed, the air conditioner will automatically turn on when the outside air temperature is above -2°C (28°F) to defog the windshield. The air recirculation mode will automatically turn off. The outside air circulation mode “ ” will be selected to improve the defogging performance.

### Manual operation

The manual mode can be used to control the heater and air conditioner to your desired settings. (“MANUAL” will appear on the display.)

To turn off the heater and air conditioner, push the “OFF” button.





### Fan speed control:

Push the fan speed control “ +”/“ -” button. Push the “ +” button to increase the fan speed. Push the “ -” button to decrease the fan speed.

Push the “AUTO” button to change the fan speed to the automatic mode.

### Air flow control:



Push the “MODE” button to change the air flow mode.

-  — Air flows from the center and side ventilators.
-  — Air flows from the center and side ventilators and foot outlets.
-  — Air flows mainly from the foot outlets
-  — Air flows from the defogger outlets and foot outlets.



### Temperature control:

Push the temperature control “▲”/“▼” button to set the desired temperature. Push the “▲” button to increase the temperature. Push the “▼” button to decrease the temperature.



### Outside air circulation:

Push the outside air circulation “ ” button to draw the air flow from outside the vehicle. (The “ ” indicator light will illuminate.)

### Air recirculation:

Push the air recirculation “ ” button to circulate the air flow inside the vehicle. (The “ ” indicator light will illuminate.)

### Automatic air intake control:

If the indicator light on either the outside air circulation “ ” button or the air recirculation “ ” button is illuminated, push and hold the button with the light illuminated. (The indicator light will blink twice.) The automatic air intake control mode is set.

### SERVICING AIR CONDITIONER



### WARNING:

**The air conditioner system contains refrigerant under high pressure. To avoid personal injury, any air conditioner service should be done only by an experienced technician with the proper equipment.**

The air conditioner system in your vehicle is charged with a refrigerant designed with the environment in mind.

**This refrigerant will not harm the earth's ozone layer.** However, it may contribute in a small part to global warming.

Special charging equipment and lubricant are required when servicing your vehicle's air conditioner. Using improper refrigerants or lubricants will cause severe damage to the air conditioner system. (See “Air conditioner system refrigerant and lubricant” (P.9-5).)

A NISSAN dealer will be able to service your environmentally friendly air conditioner system.

## AUDIO SYSTEM (if equipped)

### Air conditioner filter (if equipped)

The air conditioner system is equipped with an air conditioner filter which collects pollen. To make sure the air conditioner heats defogs, and ventilates efficiently, replace the filter according to the specified maintenance intervals listed in a separate maintenance booklet. To replace the filter, contact a NISSAN dealer.

The filter should be replaced if the air flow decreases significantly or if windows fog up easily when operating the heater or air conditioner.

### AUDIO OPERATION PRECAUTIONS



#### WARNING:

**Do not adjust the audio system while driving so that full attention may be given to vehicle operation.**

#### Radio

- Radio reception is affected by station signal strength, distance from radio transmitter, buildings, bridges, mountains and other external influences. Intermittent changes in reception quality normally are caused by these external influences.
- Using a cellular phone in or near the vehicle may influence radio reception quality.

#### Compact Disc (CD) player

- During cold weather or rainy days, the player may malfunction due to the humidity. If this occurs, remove the CD from CD player and dehumidify or ventilate the player completely.
- The player may skip while driving on rough roads.
- The CD player sometimes may not function when the passenger compartment temperature is extremely high. Lower the temperature before use.
- Do not expose the CD to direct sunlight.
- CDs that are of poor quality, or are dirty, scratched, covered with fingerprints, or that have pin holes may not work properly.
- The following CDs may not work properly.
  - Copy control compact discs (CCCD)
  - Recordable compact discs (CD-R)
  - Rewritable compact discs (CD-RW)

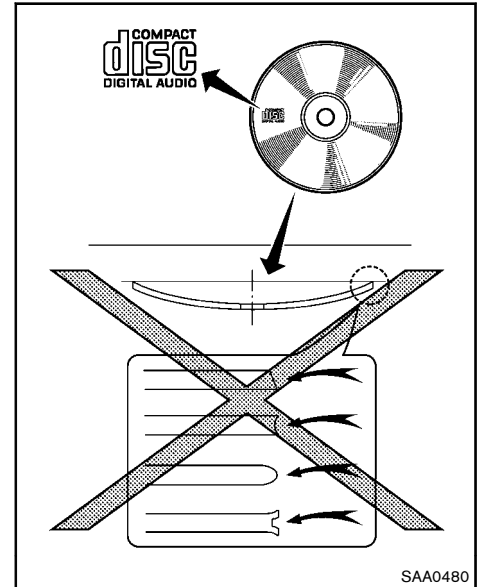

- Do not use the following CDs as they may cause the CD player to malfunction.
  - 8 cm (3.1 in) discs (except for FM-AM Radio with Compact Disc Player (Type B))
  - CDs that are not round
  - CDs with a paper label
  - CDs that are warped, scratched or have unusual edges.
  - CD lens cleaner discs
- This audio system can only play prerecorded CDs. It has no capabilities to record or burn CDs.

- If the CD cannot be played, one of the following messages will be displayed.

#### **Check disc/CHK CD/CD ERROR Check Disk:**

- Confirm that the CD is inserted correctly (the label side is facing up, etc.).
- Confirm that the CD is not bent or warped and it is free of scratches.
- Confirm that the disc is a CD and not a DVD.
- Confirm that the disc contains audio files.

#### **Push eject/Eject CD/CD Ejecting...:**

This is a malfunction due to the temperature inside the player is too high. Remove the CD by pushing the EJECT button, and after a short time reinsert the CD. The CD can be played when the temperature of the player returns to normal.

#### **Unplayable (model with type A, B, C audio unit):**

The file is unplayable in this audio system (only MP3 or WMA CD).

USB (Universal Serial Bus) (if equipped)



#### **WARNING:**

**Do not connect or disconnect the USB device while driving. Doing so can be a distraction. If distracted you could lose control of your vehicle and cause an accident or serious injury.**



#### **CAUTION:**

- **Do not force the USB device into the USB port. Inserting the USB device tilted or upside-down into the port may damage the USB device and the port. Make sure that the USB device is connected correctly into the USB port.**

- **Do not grab the USB port cover (if equipped) when pulling the USB device out of the port. This could damage the port and the cover.**
- **Do not leave the USB cable in a place where it can be pulled unintentionally. Pulling the cable may break the wire, USB device or the port.**
- **To avoid damage and loss of function when using a USB device, note the following precautions.**
  - **Do not bend the cable excessively (40 mm (1.6 in) radius minimum).**
  - **Do not twist the cable excessively (more than 180 degrees).**
  - **Do not pull or drop the cable.**
  - **Do not hit or press the USB port or USB device with hands, feet, or objects.**
  - **Do not store objects with sharp edges in the storage area where the cable is stored.**
  - **Do not leave the USB device and attached devices in the vehicle compartment. When not in use for extended periods of time, store the cable and USB device in a clean, dust free environment at room temperature and without direct sun exposure.**
  - **Do not use the cable for any other purposes than its intended use in the vehicle.**

The vehicle is not equipped with a USB device. USB devices should be purchased separately as necessary.

This system cannot be used to format USB devices. To

format a USB device, use a personal computer.

In some states/area, the USB device for the front seats plays only sound without images for regulatory reasons, even when the vehicle is parked.

This system supports various USB memory devices, USB hard drives and iPod players (if equipped). Some USB devices may not be supported by this system.

- Partitioned USB devices may not be played correctly.
- Some characters used in other languages (Chinese, Japanese, etc.) are not displayed properly on display. Using English language characters with a USB device is recommended.

#### **General notes for USB use:**

- The USB device may not function when the passenger compartment temperature is extremely high. Lower the temperature before use.
- During cold weather or rainy days, the player may malfunction due to humidity. If this occurs, remove the USB device and dehumidify or ventilate the USB player completely.
- Do not connect a USB device if a connector, cable or USB port is wet. Allow the connector, cable, and USB port to dry completely before connecting the USB device. (Wait for 24 hours or more until it is dry.) If the connector and USB port are exposed to fluids other than water, evaporative residue may cause a short circuit between the connector pins and USB port. In this case, replace the cable and USB port. Otherwise damage to the USB device and a loss of function may occur.
- If the cable is damaged (insulation cut, connectors cracked, contamination such as liquids, dust, dirt, etc. in the connectors), do not use the cable. Replace the cable with a new one.

- Do not put a USB device in a location where static electricity occurs, electrical noise is generated or hot air from the air conditioner blows directly on it. Doing so may cause the data stored on the USB device to be corrupted.

#### Notes for iPod use (if equipped):

iPod is a trademark of Apple Inc., registered in the U.S. and other countries.

- Improperly plugging in the iPod may cause a checkmark to be displayed on and off (flickering). Always make sure that the iPod is connected properly.
- An iPod nano (1st Generation) may remain in fast forward or rewind mode if it is connected during a seek operation. In this case, please manually reset the iPod.
- An iPod nano (2nd Generation) will continue to fast-forward or rewind if it is disconnected during a seek operation.
- An incorrect song title may appear when the Play Mode is changed while using an iPod nano (2nd Generation)
- Audiobooks may not play in the same order as they appear on an iPod.
- Large video files cause slow responses in an iPod. The vehicle center display may momentarily black out, but will soon recover.
- If an iPod automatically selects large video files while in the shuffle mode, the vehicle center display may momentarily black out, but will soon recover.

#### Bluetooth® Audio player (if equipped)

- Some Bluetooth® audio devices may not be used with this system. For detailed information about Bluetooth® audio devices that are available for use with this system, contact a NISSAN dealer.
- Before using a Bluetooth® audio system, the initial registration process for the audio device is necessary.
- Operation of the Bluetooth® audio system may vary depending on the audio device that is connected. Confirm the operation procedure before use.
- The playback of Bluetooth® audio will be paused under the following conditions. The playback will be resumed after the following conditions are completed.
  - while using a Hands-free phone
  - while checking a connection with a cellular phone
- The in-vehicle antenna for Bluetooth® communication is built in the system. Do not place the Bluetooth® audio device in an area surrounded by metal, far away from the system or in a narrow space where the device closely contacts the body or the seat. Otherwise, sound degradation or connection interference may occur.
- While a Bluetooth® audio device is connected through the Bluetooth® wireless connection, the battery power of the device may discharge quicker than usual.
- This system is compatible with the Bluetooth® AV profile (A2DP and AVRCP).



Bluetooth® is a trademark owned by Bluetooth SIG, Inc., and licensed to Daewoo IS Corp.

#### Compact Disc / USB memory device with MP3 or WMA (if equipped)

##### Explanation of terms:

- MP3 — MP3 is short for Moving Pictures Experts Group Audio Layer 3. MP3 is the most well known compressed digital audio file format. This format allows for near “CD quality” sound, but at a fraction of the size of normal audio files. MP3 conversion of an audio track from CD can reduce the file size by approximately 10:1 ratio (Sampling: 44.1 kHz, Bit rate: 128 kbps) with virtually no perceptible loss in quality. MP3 compression removes the redundant and irrelevant parts of a sound signal that the human ear doesn't hear.
- WMA — Windows Media Audio (WMA) is a compressed audio format created by Microsoft as an alternative to MP3. The WMA codec offers greater file compression than the MP3 codec, enabling storage of more digital audio tracks in the same amount of space when compared to MP3s at the same level of quality.
- Bit rate — Bit rate denotes the number of bits per second used by a digital music files. The size and quality of a compressed digital audio file is determined by the bit rate used when encoding the file.
- Sampling frequency — The rate at which the samples of a signal are converted from analog to digital (A/D conversion) per second.
- Multisession — Multisession is one of the methods for writing data to media. Writing data once to the media is called a single session, and writing more than once is called a multisession.

- ID3/WMA Tag — The ID3/WMA tag is the part of the encoded MP3 or WMA file that contains information about the digital music file such as song title, artist, album title, encoding bit rate, track time duration, etc. ID3 tag information is displayed on the Album/Artist/Song title line on the display.

\* Windows® and Windows Media® are registered trademarks and trademarks in the United States of America and other countries of Microsoft Corporation of the USA.

#### Playback order:

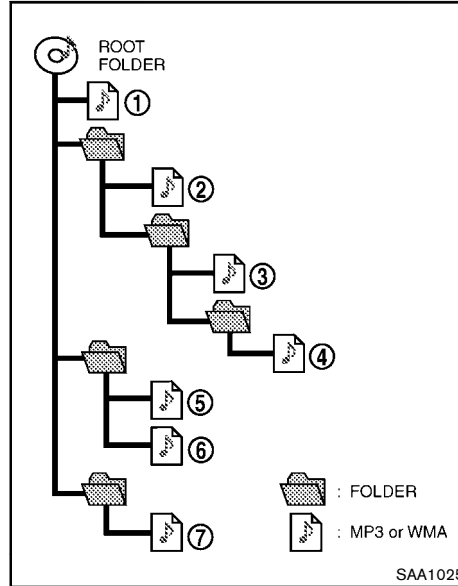

#### Playback order chart

The music playback order of the CD with MP3 or WMA is as illustrated.

- The names of folders not containing MP3 or WMA files are not shown in the display.
- If there is a file in the top level of the disc, "Root Folder" is displayed.
- The playback order is the order in which the files were written by the writing software. Therefore, the files might not play in the desired order.

**Specification chart (model with type A, B, C audio unit):**

Supported media		CD, CD-R, CD-RW	
Supported file systems		ISO9660 LEVEL1, ISO9660 LEVEL2, Romeo, Joliet ISO9660 Level 3 (packet writing) is not supported. Files saved using the Live File System component (on a Windows Vista-based computer) are not supported.	
Supported versions*1	MP3	Version	MPEG1, MPEG2, MPEG2.5
		Sampling frequency	8 kHz - 48 kHz
		Bit rate	8 kbps - 320 kbps, VBR*4
	WMA*3	Version	WMA7, WMA8, WMA9
		Sampling frequency	32 kHz - 48 kHz
		Bit rate	32 kbps - 192 kbps, VBR*4
Tag information (Song title and Artist name)		ID3 tag VER1.0, VER1.1, VER2.2, VER2.3, VER2.4 (MP3 only)	
		WMA tag (WMA only)	
Folder levels		Folder levels: 8, Folders: 255 (including route folder), Files: 512 (Max. 255 files for one folder)	
Displayable character codes*2		01: ASCII, 02: ISO-8859-1, 03: UNICODE (UTF-16 BOM Big Endian), 04: UNICODE (UTF-16 Non-BOM Big Endian), 05: UNICODE (UTF-8), 06: UNICODE (Non-UTF-16 BOM Little Endian)	

\*1 Files created with a combination of 48 kHz sampling frequency and 64 kbps bit rate cannot be played.

\*2 Available codes depend on what kind of media, versions and information are going to be displayed.

\*3 Protected WMA files (DRM) cannot be played.

\*4 When VBR files are played, the playback time may not be displayed correctly. WMA7 and WMA8 are not applied to VBR.



**Specification chart (model with type D, E, F audio unit):**

Supported media		CD, CD-R, CD-RW, USB2.0	
Supported file systems		CD, CD-R, CD-RW: ISO9660 LEVEL1, ISO9660 LEVEL2, Romeo, Joliet * ISO9660 Level 3 (packet writing) is not supported. * Files saved using the Live File System component (on a Windows Vista-based computer) are not supported. USB memory device: FAT16, FAT32	
Supported versions*1	MP3	Version	MPEG1 Audio Layer 3
		Sampling frequency	8 kHz - 48 kHz
		Bit rate	8 kbps - 320 kbps, VBR*4
	WMA*2	Version	WMA7, WMA8, WMA9
		Sampling frequency	32 kHz - 48 kHz
		Bit rate	32 kbps - 192 kbps, VBR*4
Tag information (Song title and Artist name)		ID3 tag VER1.0, VER1.1, VER2.2, VER2.3, VER2.4 (MP3 only) WMA tag (WMA only)	
Folder levels	CD, CD-R, CD-RW	Folder levels: 8, Folders and files: 999 (Max. 255 files for one folder)	
	USB (model with type D audio unit)	Folder levels: 8, Folders 255, Files: 65535 (Max. 999 files for one folder) Memory size: 4GB	
	USB (model with type E, F audio unit)	Folder levels: 8, Folders 255, Files: 2500 (Max. 255 files for one folder) Memory size: 4GB	
Displayable character codes*3		01 : ASCII, 02: ISO-8859-1, 03: UNICODE (UTF-16 BOM Big Endian), 04: UNICODE (UTF-16 Non-BOM Big Endian), 05: UNICODE (UTF-8), 06: UNICODE (Non-UTF-16 BOM Little Endian), 07: SHIFT-JIS	

\*1 Files created with a combination of 48 kHz sampling frequency and 64 kbps bit rate cannot be played.

\*2 Protected WMA files (DRM) cannot be played.

\*3 Available codes depend on what kind of media, versions and information are going to be displayed.

\*4 When VBR files are played, the playback time may not be displayed correctly.

**Troubleshooting guide (model with type A, B, C audio unit):**

Symptom	Cause and Countermeasure
Cannot play	Check if the disc was inserted correctly.
	Check if the disc is scratched or dirty.
	Check if there is condensation inside the player, and if there is, wait until the condensation is gone (about 1 hour) before using the player.
	If there is a temperature increase error, the CD player will play correctly after it returns to the normal temperature.
	If there is a mixture of music CD files (CD-DA data), MP3/WMA files on a CD, only the music CD files (CD-DA data) will be played.
	Files with extensions other than “.MP3”, “.WMA”, “.mp3” or “.wma” cannot be played. In addition, the character codes and number of characters for folder names and file names should be in compliance with the specifications.
	Check if the disc or the file is generated in an irregular format. This may occur depending on the variation or the setting of MP3/WMA writing applications or other text editing applications.
	Check if the finalization process, such as session close and disc close, is done for the disc.
Poor sound quality	Check if the disc is scratched or dirty.
It takes a relatively long time before the music starts playing.	If there are many folder or file levels on the MP3/WMA disc, or if it is a multisession disc, some time may be required before the music starts playing.
Music cuts off or skips	The writing software and hardware combination might not match, or the writing speed, writing depth, writing width, etc., might not match the specifications. Try using the slowest writing speed.
Skipping with high bit rate files	Skipping may occur with large quantities of data, such as for high bit rate data.
Move immediately to the next song when playing.	When a non-MP3/WMA file has been given an extension of “.MP3”, “.WMA”, “.mp3”, “.wma”, or when play is prohibited by copyright protection, there will be approximately 5 seconds of no sound and then the player will skip to the next song.
The songs do not play back in the desired order.	The playback order is the order in which the files were written by the writing software, so the files might not play in the desired order.

**Troubleshooting guide (model with type D, E, F audio unit):**

Symptom	Cause and Countermeasure
Cannot play	Check if the disc or USB memory device was inserted correctly.
	Check if the disc is scratched or dirty.
	Check if there is condensation inside the player, and if there is, wait until the condensation is gone (about 1 hour) before using the player.
	If there is a temperature increase error, the player will play correctly after it returns to the normal temperature.
	If there is a mixture of music CD files (CD-DA data) and compressed audio files on a CD, only the music CD files (CD-DA data) will be played.
	Files with extensions other than ".MP3 (.mp3)" or ".WMA (.wma)" cannot be played. In addition, the character codes and number of characters for folder names and file names should be in compliance with the specifications.
	Check if the disc or the file is generated in an irregular format. This may occur depending on the variation or the setting of compressed audio writing applications or other text editing applications.
	Check if the finalization process, such as session close and disc close, is done for the disc.
Poor sound quality	Check if the disc or USB memory device is protected by copyright.
It takes a relatively long time before the music starts playing.	Check if the disc is scratched or dirty.
Music cuts off or skips	If there are many folder or file levels on the disc or USB memory device, some time may be required before the music starts playing.
Skipping with high bit rate files	The writing software and hardware combination might not match, or the writing speed, writing depth, writing width, etc., might not match the specifications. Try using the slowest writing speed.
Move immediately to the next song when playing.	Skipping may occur with large quantities of data, such as for high bit rate data.
The songs do not play back in the desired order.	If an unsupported compressed audio file has been given a supported extension like .MP3, or when play is prohibited by copyright protection, the player will skip to the next song.
	The playback order is the order in which the files were written by the writing software, so the files might not play in the desired order. Random/Shuffle may be active on the audio system or on a USB memory device.

## ANTENNA (if equipped)

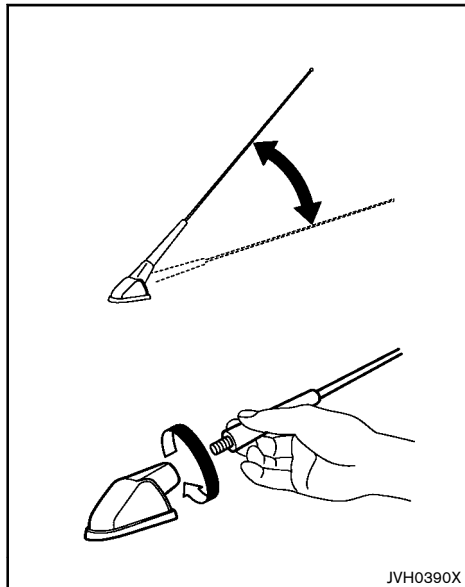

Adjust the antenna angle for the best reception.

### Removing antenna

You can remove the antenna if necessary.

Hold the bottom of the antenna and remove by turning counterclockwise.

To install the antenna, turn the antenna clockwise and tighten.



### CAUTION:

- Be sure to fold down the antenna before the vehicle enters a garage with a low ceiling.
- Be sure that antenna is removed before the vehicle enters an automatic car wash.

## FM-AM RADIO WITH COMPACT DISC (CD) PLAYER (Type A)

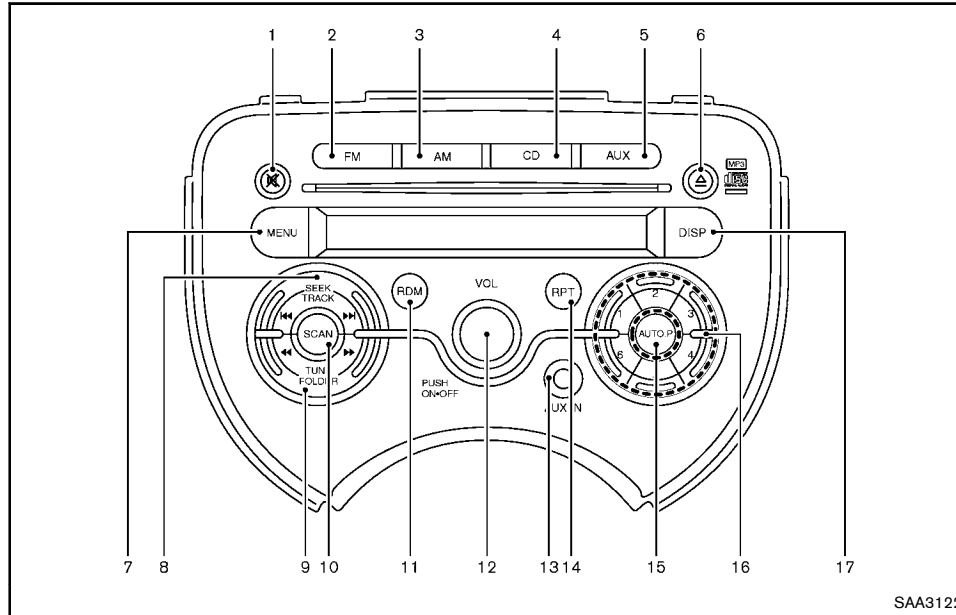

16. Radio memory buttons (1 - 6)

17. DISP (Display) button

- |                                |   |
|--------------------------------|---|
| 1. MUTE button                 | 9. TUNE/FF(Forward)-REW(Rewind)/FOLDER button |
| 2. FM radio band select button | 10. SCAN button                               |
| 3. AM radio band select button | 11. RDM (Random) button                       |
| 4. CD button                   | 12. Power button/VOL (Volume) control knob    |
| 5. AUX button                  | 13. AUX IN (auxiliary input) jack             |
| 6. CD EJECT button             | 14. RPT (Repeat) button                       |
| 7. MENU button                 | 15. AUTO.P (Automatic Preset) button          |
| 8. SEEK/TRACK button           |   |

## Audio main operation

The audio system operates when the ignition switch is in the "ACC" or "ON" position.

### POWER button:

To turn on the audio system, push the Power button.

- The system will turn on in the mode, (radio or CD) which was used immediately before the system was turned off.
- If there is no CD loaded, the radio will be turned on.

To turn off the audio system, push the Power button.

### Volume control:

To control the volume, turn the VOL control knob.

Turn the knob clockwise to make the sound louder.

Turn the knob counterclockwise to make the sound quieter.

### MENU MENU button:

To change the audio settings (BASS, TREBLE, FADER, BALANCE, BEEP and CLOCK), push the MENU button to select the mode while the CD or radio is on.

Push the MENU button until the desired mode appears on the display.

BASS → TREBLE → FADE → BALANCE → BEEP ON → CLOCK

### Audio setting

Push the SEEK/TRACK button (▶▶) or (◀◀) or TUNE/FF-REW/FOLDER button (▶▶) or (◀◀) to adjust while the following audio setting is displayed.

BASS : (-) to decrease / (+) to increase

TREBLE : (-) to decrease / (+) to increase

FADE : (F) to front fade / (R) to rear fade

BALANCE : (R) to right balance / (L) to left balance

Once the audio settings are set to the desired level, push the MENU button until the radio or CD display appears.

If no action is performed for approximately 5 seconds, the audio settings mode will automatically return to the normal mode.

### Beep setting

To turn the beep sound off or on, push the SEEK/TRACK button (▶▶) or (◀◀) or TUNE/FF-REW/FOLDER button (▶▶) or (◀◀) until the desired mode is displayed. This turns on or off the beep sound when audio buttons are pushed.

### Clock setting

To display the clock on the screen, push the SEEK/TRACK button (▶▶) or (◀◀) or TUNE/FF-REW/FOLDER button (▶▶) or (◀◀) to select CLOCK ON.

1. Turn the clock display on.
2. Push the MENU button while CLOCK ON is on the display. The hour and minute digits blink.
3. To adjust the hours, push the SEEK/TRACK button (▶▶) or (◀◀).
4. To adjust the minutes, push the TUNE/FF-REW/FOLDER button (▶▶) or (◀◀).

If no user input is detected for 10 seconds, or when the "MENU" button is pushed, the clock setting mode will automatically return to the normal mode.

### MUTE button:

Press the MUTE button to mute the sound. Press again to restore the sound.

### AUX AUX button:

The AUX IN jack is located on the audio unit. The AUX IN audio input jack accepts any standard analog audio input such as from a portable cassette tape/CD player, MP3 player or laptop computer.

Push the AUX button to play a compatible device when it is plugged into the AUX IN jack.

NISSAN strongly recommends using a stereo mini plug cable when connecting your music device to the audio system. Music may not play properly when a monaural cable is used.

### CD player operation

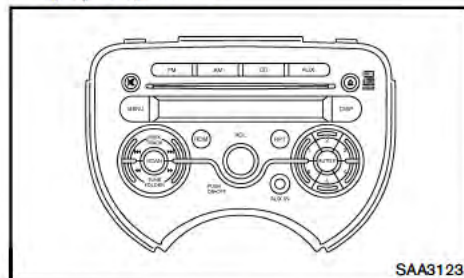

The audio system operates when the ignition switch is in the "ACC" or "ON" position.

### Loading:

Insert a CD into the slot with the label side facing up. The CD will be guided automatically into the slot and will start playing. To stop playing, push the Power button.



### CAUTION:

**Do not force the compact disc into the slot. This could damage the player.**

### CD button:

When the **CD** button is pushed while a CD is loaded, the CD will start playing automatically.

### DISP button:

When the **DISP** button is pushed while a CD with a title is being played, the display will change as follows:

CD:



CD with MP3 or WMA:



### SEEK/TRACK button:

When the **SEEK/TRACK** button is pushed while a CD is being played, the present track will be advanced and move to the next track. Push the **SEEK/TRACK** button several times to skip forward tracks. The CD will advance the number of times the button is pushed. When the last track of

the CD is forwarded, the first track will be played.

When the **SEEK/TRACK** button is pushed while a CD is being played, the present track will start over from the beginning of the current track. Push the **SEEK/TRACK** button several times to skip back tracks. The CD will rewind the number of times the button is pushed. When the first track of the CD is rewound, the last track will be played.

### TUNE/FF-REW/FOLDER button:

When the **TUNE/FF-REW/FOLDER** button is pushed and held while a CD is being played, the CD will be played while forwarding or rewinding. When the button is released, the CD will return to the normal play speed.

When the **TUNE/FF-REW/FOLDER** button is pushed while a CD with MP3 or WMA is being played, the first track in the next or the previous folder will be played.

### SCAN button:

When the **SCAN** button is pushed while a CD is being played, the first 10 seconds of all the tracks will be played.

When the **SCAN** button is pushed again, the CD will return to normal play from the track which is playing.

### RPT (Repeat) button:

To change the play settings, push the **RPT** button to select the mode.

CD:

RPT DISC → RPT TRACK

CD with MP3 or WMA:

RPT DISC → RPT FOLDER → RPT TRACK

RPT DISC:

All the tracks of the CD will be played continuously in sequential order. The display indicates no symbol mark. While the **RPT** button is pushed, the display indicates "RPT DISC".

RPT TRACK:

The selected track of the CD will be played continuously. While the **RPT** button is pushed, the display indicates "RPT TRACK".

RPT FOLDER:

All the tracks of selected folder will be played continuously in sequential order (CD with MP3 or WMA only). While the **RPT** button is pushed, the display indicates "RPT FOLDER".

### RDM (Random) button:

To change the play sequence, push the **RDM** button to select the mode.

CD:

RDM DISC → RPT DISC

CD with MP3 or WMA:

RDM DISC → RDM FOLDER → RPT DISC

RPT DISC:

All the tracks of the CD will be played continuously in sequential order. The display indicates no symbol mark. While the **RDM** button is pushed, the display indicates "RPT DISC".

RDM DISC:

All the tracks or folders (CD with MP3 or WMA only) of the CD will be played continuously in random order. While the **RDM** button is pushed, the display indicates "RDM DISC".

#### RDM FOLDER:

All the tracks of the selected folder will be played continuously in random order (CD with MP3 or WMA only). While the **[RDM]** button is pushed, the display indicates "RDM FOLDER".



#### CD EJECT button:

To eject a CD, push the CD EJECT  button.

When the  button is pushed twice, the CD will be ejected further, and the CD can be removed with ease.

If a CD is ejected by pushing the  button, and it is not taken out from the loading slot, the CD will automatically be reloaded to the slot to protect the CD (12 cm discs only).

#### FM-AM radio operation

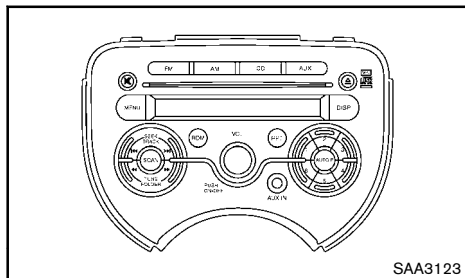

The audio system operates when the ignition switch is in the "ACC" or "ON" position.

#### **[FM/AM]** button:

When the **[FM/AM]** button is pushed while the audio system is off, the audio system will turn on and the radio will turn on.



When the **[FM/AM]** button is pushed while another audio source is playing, the another audio source will turn off and the radio will turn on.



To change the radio bands, push the **[FM/AM]** button until the desired band (FM1, FM2, AM) is displayed.

The FM stereo indicator, "ST" will display during FM stereo reception. When the stereo broadcast signal is weak, the radio will automatically change from stereo to monaural reception.





#### TUNE/FF-REW/FOLDER button:

When adjusting the broadcasting station frequency manually, push the  or  button until the desired frequency is achieved.

When adjusting the broadcasting station frequency automatically, push the  or  button. When the system detects a broadcasting station, it will stop at the station.



#### SEEK UP/DOWN button:

When adjusting the broadcasting station frequency automatically, push the   button. When the system detects a broadcasting station, it will stop at the station.

#### **[SCAN]** button:



When the **[SCAN]** button is pushed, the system will seek and stop at the detected broadcasting station for 5 seconds, and then it will start to seek for the next broadcasting station.

Push the **[SCAN]** button in this 5-second period to stop seeking.

#### Radio memory button:

The audio system can store up to 12 FM station frequencies (for FM1 and FM2) and 6 AM station frequencies.

To store the station frequency:

1. Tune to the desired broadcasting station frequency by using the  or  button.
2. Push and hold a memory button (1 - 6) until a beep sounds.
3. The switch number and frequency will appear on the display when the memory is stored properly.
4. Perform steps 1 - 3 for all other memory buttons.

Push a memory button (1 - 6) to select a desired memory.

If the battery cable is disconnected, or if the audio fuse blows, the radio memory will be erased. In such a case, reset the desired stations.

#### **[AUTO.P]** (Automatic Preset) button:

The audio system can store up to 6 FM station frequencies and 6 AM station frequencies.

To store the station frequency automatically, push and hold the **[AUTO.P]** button until a beep sounds. The station will be automatically stored in the "AUTO.P" memory. The display indicates "AP-\*\*\*".



Push the **AUTO** button to select a desired memory.

### FM-AM RADIO WITH COMPACT DISC (CD) PLAYER (Type B)

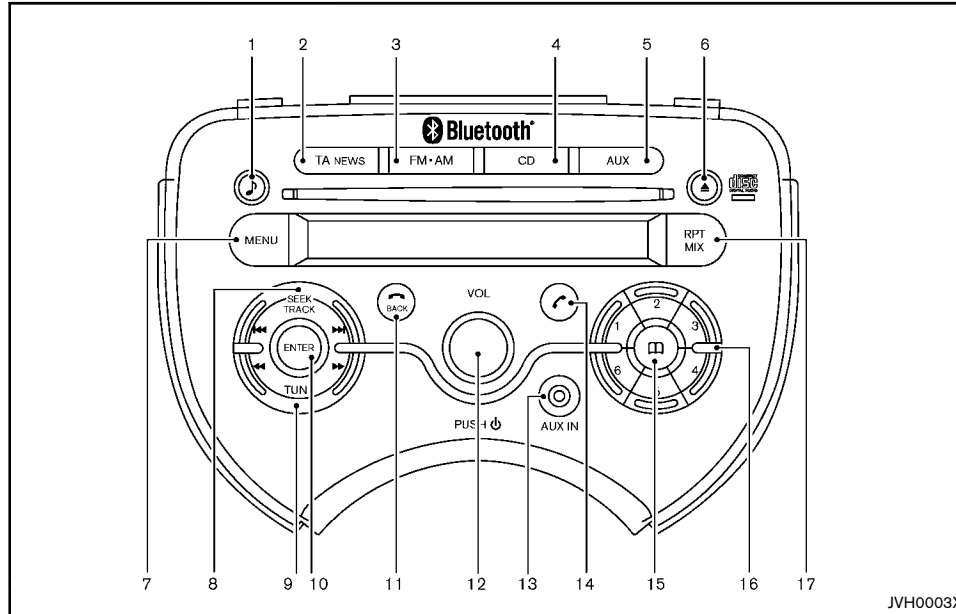

13. AUX IN (auxiliary input) jack

14. PHONE SEND button

15. PHONE BOOK button

16. Radio memory buttons

17. RPT (Repeat)/MIX (Mix play) button

1. Sound preference button
2. TA (Traffic Announcement)/NEWS button
3. FM-AM band select button
4. CD button
5. AUX button
6. CD EJECT button

7. MENU button
8. SEEK/TRACK button
9. TUNE button
10. ENTER button
11. PHONE END/BACK button
12. POWER ON/OFF button/VOLUME control knob
13. AUX IN
14. PHONE SEND button
15. PHONE BOOK button
16. Radio memory buttons
17. RPT (Repeat)/MIX (Mix play) button

## Anti-theft system (if equipped)

This unit can only be activated when the ignition switch for NATS is in the "ACC" or "ON" position. Each radio is uniquely matched to the vehicle's immobilizer and therefore cannot be transferred to any other vehicle.

## Audio main operation

The audio system operates when the ignition switch is in the "ACC" or "ON" position.

### POWER ON/OFF button:

To turn on the audio system, push the POWER ON/OFF button.

- The system will turn on in the mode, (radio or CD) which was used immediately before the system was turned off.
- If there is no CD loaded, the radio will be turned on.

To turn off the audio system, push the POWER ON/OFF button.

### Volume control:

To control the volume, turn the VOLUME control dial.

Turn the VOLUME control dial clockwise to make the sound louder.

Turn the VOLUME control dial counterclockwise to make the sound quieter.



### Sound preference button:

To enter the audio mode (radio or CD), push the  button. When no CD is loaded, the audio system will automatically switch to the radio mode.

To change the audio settings (BASS, TREBLE, FADER, BALANCE, EQ), push the  button or ENTER button to select the mode.

BASS → TREBLE → BALANCE → FADER → EQ →

## BASS

To adjust each audio setting, turn the VOL control dial clockwise or counterclockwise.

BASS: (-) to decrease / (+) to increase

TREBLE: (-) to decrease / (+) to increase

BALANCE: (R) to right balance / (L) to left balance

FADE: (F) to front fade / (R) to rear fade

EQ (Equalizer): Use this control to change the preset sound mode for CD play.

Turn the MENU/VOL dial clockwise or counterclockwise. The mode will change as follows:

OFF ENHANCE

If the audio settings mode is unchanged for approximately 8 seconds, the audio settings mode will automatically return to the normal mode.

### MENU button:

To configure the SPEED volume and BEEP settings, perform the following procedure:

1. Push the MENU button.
2. Turn the VOLUME dial clockwise or counterclockwise. The display message will change as follows:

PHONE SETUP SPEED VOL CLOCK  
BEEP PHONE SETUP

- When SPEED VOL appears on the display, briefly push on the ENTER button then turn the VOLUME dial clockwise or counterclockwise to adjust the level of the volume.

Adjusting the setting to 0 (zero) turns off the speed volume feature. Increasing the speed volume setting results in the audio volume increasing more rapidly with vehicle speed. Push

the ENTER button again to save the setting.

- When BEEP appears on the display, briefly push the ENTER button and then turn the VOLUME dial clockwise or counterclockwise to switch the beep sound on or off. Push the ENTER button again to save the setting.

To configure Alternative Frequency, Regional and Language settings, perform the following procedure:

1. Push and hold the MENU button for at least 1.5 seconds.
2. Turn the VOLUME dial clockwise or counterclockwise. The display message will change as follows:

AF REG LANGUAGE AF

- To activate or deactivate the AF and REG mode, briefly push on the ENTER button when AF or REG appears on the display and turn the VOLUME dial clockwise or counterclockwise to switch between the off or on position. After selection, push the ENTER button to confirm the settings.

- When the AF mode is enabled, the audio unit will automatically re-tune to a stronger frequency if the radio signal becomes weak.
- When the REG mode is enabled, the audio unit will maintain and hold the station which is broadcasting local (regional) programmes.

- To change the display language, briefly push the ENTER button when LANGUAGE appears on the display then turn the VOLUME dial clockwise or counterclockwise to select the appropriate language setting.

ENGLISH DUTCH FRENCH SPANISH  
GERMAN ITALIAN PORTUGUESE  
ENGLISH

After selecting the desired language, push the

ENTER button to exit the menu.

After the desired levels have been set, push the MENU button to exit the menu or wait at least for 10 seconds without pressing any buttons.

#### Clock :

Clock display can be turned on and off, and clock can be adjusted.

- When clock is not displayed
1. Turn the audio unit on by pushing the POWER ON/OFF button.
  2. Push the MENU button and turn the VOLUME control knob until "CLOCK" is displayed.
  3. Push the ENTER button. ("CLOCK OFF" is displayed)
  4. Turn the VOLUME control knob to turn the clock display mode on. ("CLOCK ON" is displayed)
  5. Push the ENTER button. The hour display will start flashing.
  6. Turn the VOLUME control knob to adjust the time.
  7. Push the ENTER button. The minute display will start flashing.
  8. Turn the VOLUME control knob to adjust the time.
  9. Push the ENTER button to finish the clock adjustment.
- When clock is displayed
1. Turn the audio unit on by pushing the POWER ON/OFF button.
  2. Push the MENU button and turn the VOLUME control knob until "CLOCK" is displayed.
  3. Push the ENTER button. ("CLOCK ON" is displayed.)

4. Perform steps 5 to 9 above to adjust the time.

#### AUX AUX button:

The AUX IN jack is located on the audio unit. The AUX IN audio input jack accepts any standard analog audio input such as from a portable cassette tape/CD player, MP3 player, laptop computers, etc.

Push the AUX button to play a compatible device when it is plugged into the AUX IN jack.

Nissan strongly recommends using a stereo mini plug cable when connecting your music device to the audio system. Music may not play properly when a monaural cable is used.

#### CD player operation

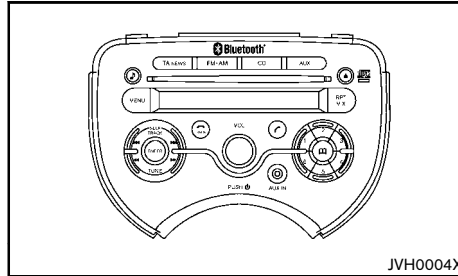

The audio system operates when the ignition switch is in the "ACC" or "ON" position.

#### Loading:

Insert a CD into the slot with the label side facing up. The CD will be guided automatically into the slot and will start playing. If the radio is already playing, it will automatically turn off, and the CD will start playing.



#### CAUTION:

**Do not force the CD into the slot. This could damage the player.**

After loading the CD, the number of tracks and the playtime will appear on the display.

8 cm (3.1 in) diameter CDs can be played without using an adapter.

#### CD CD button:

When the **CD** button is pushed while the audio system is off and a CD is loaded, the audio system will turn on and a CD will start playing automatically. If the radio is already playing, it will automatically turn off and the CD will start playing.

#### ▶▶ FF (Fast Forward), ◀◀ REW (Rewind) button :

Push the ▶▶ or ◀◀ button while a CD is being played to fast-forward or rewind through the track. When the button is released, the CD will return to normal play speed.

#### ▶▶ TRACK UP/◀◀ DOWN button:

When the ▶▶ button is pushed while a CD is being played, the present track will be advanced and move to the next track. Push the ▶▶ button several times to skip forward tracks. The CD will advance the number of times the button is pushed. When the last track of the CD is forwarded, the first track will be played.

When the ◀◀ button is pushed while a CD is being played, the present track will start over from the beginning. Push the ◀◀ button several times to skip back tracks. The CD will rewind the number of times

the button is pushed. When the first track of the CD is rewound, the last track will be played.

#### **Repeat/MIX button:**

Push the  button repeatedly to change the play mode as follows:

RPT (REPEAT) TRACK → MIX DISC → RPT (REPEAT) ALL

RPT TRACK: The CD player plays the current track continuously.

RPT ALL: All the tracks on the CD will be played in sequential order.

MIX DISC: All the tracks on the CD will be played in a random order.

#### **CD EJECT button:**

When the  button is pushed while a CD is loaded, the CD will be ejected.

When the  button is pushed twice, the CD will be ejected further, and the CD can be removed with ease.

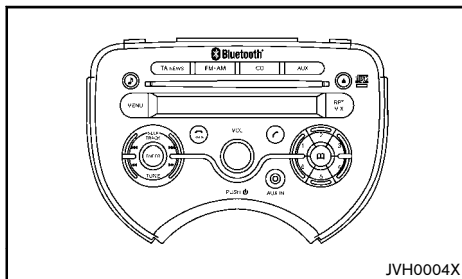

If a CD is ejected by pushing the  button, and it is not taken out from the loading slot, the CD will automatically be reloaded to the slot to protect the CD.

## FM-AM radio operation



The audio system operates when the ignition switch is in the "ACC" or "ON" position.

#### **FM-AM button:**



When the  button is pushed while the audio system is off, the audio system will turn on and the radio will turn on. When the  button is pushed while CD is already operating, it will automatically turn off, and the radio will turn on.

To change the radio bands, push the  button until the desired band appears.

FM 1 → FM 2 → FM T → MW → LW



During FM reception, when the  button is pushed for longer than 1.5 seconds, stations are searched for and the 6 stations of the FM T band. The sound is muted until the auto store operation is completed, upon which preset channel 1 is automatically tuned in.

#### **TUNE button:**

When adjusting the broadcasting station frequency manually, push the   button until the desired frequency is achieved.

The frequency changes in steps of 100 kHz on the FM band, 9 kHz on the MW band, and 3 kHz on the LW band.







#### **SEEK button:**

When adjusting the broadcasting station frequency automatically, push the   button. When the system detects a broadcasting station, it will stop at the station.

#### **Radio memory buttons:**

The audio system can store up to 18 FM station frequencies (six in each of FM 1, FM 2 and FM T), 6 MW and 6 LW station frequencies.

To store the station frequency manually:

1. Tune to the desired broadcasting station frequency by using the   or   button.
2. Push and hold a radio memory button  -  until a beep sounds. (The radio mutes when the memory button is pushed.)
3. The channel indicator will display and the radio mute disengages, indicating that the memory is stored properly.
4. Perform steps 1 - 3 for all other memory buttons.

If the battery cable is disconnected, or if the audio fuse blows, the radio memory will be erased. In such a case, reset the desired stations.

## Radio data system (RDS)

### Alternative Frequency (AF):

- The AF function operates in the FM (radio) and CD modes.
- When the AF mode is set to “ON” in the user setup menu mode, the AF indicator illuminates.

For activation or deactivation details, see “Audio main operation” (P.4-25).

- **Automatic switching function**

This function compares the strengths of the signals of all the stations on the AF list and selects the station with the optimum reception conditions.

- **Program Information (PI) search**

Program Information (PI) search begins automatically if no suitable station is found with the above automatic switching function. The PI search function checks each RDS station with the same PI code. During this time the sound is muted and “PI SEARCH” is displayed. The PI search operation stops when a suitable station is found. If no station is found once all the frequencies have been searched, the radio returns to the previous frequency.

- **Enhanced Other Network (EON) data update (This function also operates when the AF mode is off.)**

When EON data is being received, this enables automatic retuning of other preset stations on the same network. Also, network linked services can be used. The EON indicator turns on during the reception of RDS EON stations in the FM mode.

### RDS functions:

- **Programme Service (PS) function (station name display function)**

When an RDS station is tuned in with seek or manual tuning, the RDS data is received and the Programme Service (PS) name is displayed.

- **Emergency broadcast interrupt function (ALARM INTERRUPTION — EBU SPEC FOR INFO)**

When the radio receives PTY code 31 (an emergency broadcast code), the sound is interrupted, the emergency broadcast is heard, and “PTY31 ALARM” is displayed. The volume level at this time is the same as that for traffic announcements. Once the emergency broadcast is finished, the unit immediately returns to the previous source.

- **REG (Regional) mode**

Some local radio stations are linked together according to their region because they only offer limited coverage due to their limited number of transmitters. If the signal from one station becomes weak while you are driving around, RDS mode will switch to another local station in the region with a stronger signal.

When the REG mode is activated in the FM band and the radio receiver is tuned to a local radio station, it will keep receiving this radio station without switching to another local station. For activation or deactivation details, see “Audio main operation” (P.4-25).

### Traffic Announcement (TA):

- The TA function operates in the FM and CD modes.
- The TA mode is turned on or off when the TA/NEWS button is pushed for less than 2 seconds.
- The TA mode operates regardless of whether the AF mode is on or off.
- “TA ON” is displayed when the TA mode is turned on, and the TA indicator turns on. “TA OFF” is displayed when the TA mode is turned off, and the TA indicator turns off.

The following function operates when the TA mode is on:

- **Traffic announcement interrupt function**

When a traffic announcement is received, the announcement is tuned in and the volume increases to the set level.

Once the traffic announcement is finished, the unit returns to the source which was set before the traffic announcement started, and the volume returns to the previous level. For EON stations, the radio is interrupted by another EON station with traffic announcements.

The traffic announcement interrupt mode is cancelled if the TA/NEWS button is pushed during a traffic announcement. The TA mode returns to the standby mode and the audio unit returns to the previous source.

### News mode:

When the NEWS button or the TA/NEWS button is pushed for longer than 2 seconds in the FM mode, the news function is activated. “NEWS” is displayed for 3 seconds and the NEWS indicator appears on the display.

When the news function is activated, the radio

receives a news code from the FM broadcasting news station and the play mode will be interrupted. Once the news broadcast is finished, the unit returns to the previous mode.

In some countries or regions, this service is not available or the signal is too weak to be received.

### 1. News standby mode

- The news standby mode can be activated in the FM or CD mode.
- A news interruption will be announced and "NEWS" will be displayed when the radio detects the news code from the tuned station or EON stations. The display will then change to the PS name of the interrupting station.
- When pushing the NEWS button or pushing the TA/NEWS button for longer than 2 seconds, the news standby mode is turned off and the indicator disappears from the display.

### 2. News interruption mode

- When the NEWS button or the TA/NEWS button is pushed during the news interruption mode, the radio returns to the previous source. However, the news standby mode is kept.
- When the **CD** button is pushed during the news interruption mode, the radio changes to the CD mode. However, the news standby mode is kept.

If the radio band is changed to the MW or LW, the news standby mode will be turned off.

## FM-AM RADIO WITH COMPACT DISC (CD) PLAYER (Type C)

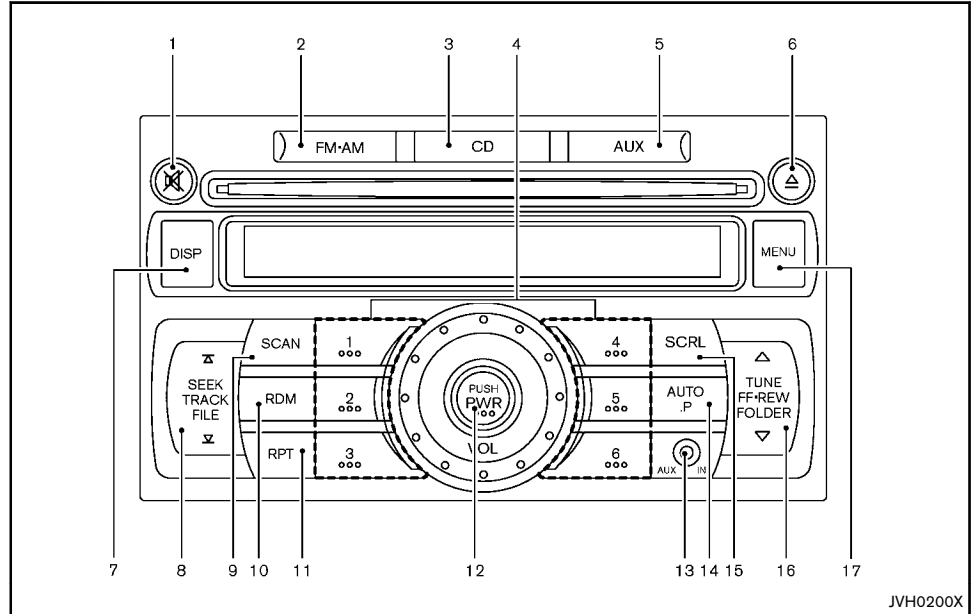

- |                                   |  |
|-----------------------------------|--|
| 1. MUTE button                    | 9. SCAN button                                   |
| 2. FM-AM radio band select button | 10. RDM (Random) button                          |
| 3. CD button                      | 11. RPT (Repeat) button                          |
| 4. Radio memory buttons           | 12. Power button/Volume control knob             |
| 5. AUX button                     | 13. AUX IN (auxiliary input) jack                |
| 6. CD EJECT button                | 14. AUTO.P (Automatic Preset) button             |
| 7. DISP button                    | 15. SCRL (Scroll) button                         |
| 8. SEEK/TRACK/FILE button         | 16. TUNE/FF (Forward)-REW (Rewind)/FOLDER button |

## 17. MENU button

### Audio main operation

The audio system operates when the ignition switch is in the "ACC" or "ON" position.

#### POWER button:

To turn on the audio system, push the Power button.

- The system will turn on in the mode, (radio or CD) which was used immediately before the system was turned off.
- If there is no CD loaded, the radio will be turned on.

To turn off the audio system, push the PWR button.

#### Volume control:

To control the volume, turn the VOLUME control knob. Turn the knob clockwise to make the sound louder.

Turn the knob counterclockwise to make the sound quieter.

#### **MENU** MENU button:

To change the audio settings, push the **MENU** button to select the mode while the CD or radio is on.

Push the **MENU** button until the desired mode appears on the display.

BASS → TREBLE → FADE → BALANCE → BEEP → CLOCK → BASS

Push the SEEK/TRACK button (▲ or ▼) or TUNE/FF-REW/FOLDER button (▲ or ▼) to adjust the audio settings.

BASS : (-) to decrease / (+) to increase

TREBLE : (-) to decrease / (+) to increase

FADE : (F) to front fade / (R) to rear fade

BALANCE : (R) to right balance / (L) to left balance

Once the audio settings are set to the desired level, push the **MENU** button until the radio or CD display appears.

If no action is performed for approximately 5 seconds, the audio settings mode will automatically return to the normal mode.

To turn the beep sound off or on, push the SEEK/TRACK button ▲ or ▼ or TUNE/FF-REW/FOLDER button ▲ or ▼ until the desired mode is displayed. This turns on or off the beep sound when audio buttons are pushed.

#### Clock display:

To display the clock on the screen, perform the following operations.

1. Push the **MENU** button repeatedly until CLOCK ON or OFF appears on the display while the audio system is on.
2. Push the SEEK/TRACK button ▲ or ▼ or TUNE/FF-REW/FOLDER button ▲ or ▼ to select CLOCK ON.

#### Clock adjustment:

To adjust the clock, turn the clock display on and perform the following operations.

1. Push the **MENU** button while CLOCK ON is on the display. The hour and minute digits blink.
2. To adjust the hours, push the SEEK/TRACK button ▲ or ▼.
3. To adjust the minutes, push the TUNE/FF-REW/FOLDER button ▲ or ▼.

If no user input is detected for 10 seconds, or when the "MENU" button is pushed, the clock setting mode will automatically return to the normal mode.

#### **MUTE** MUTE button:

Press the **MUTE** button to mute the sound. Press again to restore the sound.

#### **AUX** AUX button:

The AUX IN jack is located on the audio unit. The AUX IN audio input jack accepts any standard analog audio input such as from a portable cassette tape, CD player, MP3 player or laptop computers.

Push the AUX button to play a compatible device when it is plugged into the AUX IN jack.

NISSAN strongly recommends using a stereo mini plug cable when connecting your music device to the audio system. Music may not play properly when a monaural cable is used.

### CD player operation

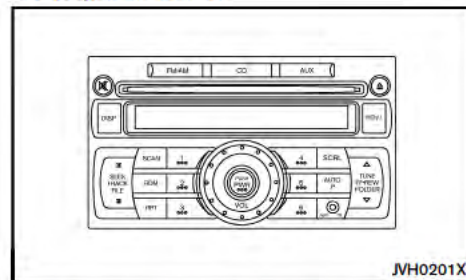

JH0201X

The audio system operates when the ignition switch is in the "ACC" or "ON" position.

### Loading:

Insert a CD into the slot with the label side facing up. The CD will be guided automatically into the slot and will start playing. To stop playing, push the Power button.



### CAUTION:

**Do not force the compact disc into the slot. This could damage the player.**

### CD button:

When the **CD** button is pushed while a CD is loaded, the CD will start playing automatically.

### DISP button:

When the **DISP** button is pushed while a CD with a title is being played, the display will change as follows:

CD:



CD with MP3 or WMA:



### SEEK/TRACK/FILE button:

When the **▲** button (located on the left side) is pushed while a CD is being played, the present track will be advanced and move to the next track. Push the **▼** button several times to skip forward tracks. The CD will advance the number of times the button is

pushed. When the last track of the CD is forwarded, the first track will be played.

When the **▼** button is pushed while a CD is being played, the present track will start over from the beginning of the current track. Push the **▼** button several times to skip back tracks. The CD will rewind the number of times the button is pushed. When the first track of the CD is rewound, the last track will be played.



### TUNE/FF-REW/FOLDER button:

When the **▲** or **▼** button (located on the right side) is pushed and held while a CD is being played, the CD will be played while forwarding or rewinding. When the button is released, the CD will return to the normal play speed.

When the **▲** button or **▼** is pushed while a CD with MP3 or WMA is being played, the first track in the next or the previous folder will be played.

### SCAN button:

When the **SCAN** button is pushed while a CD is being played, the first 10 seconds of all the tracks will be played.

When the **SCAN** button is pushed again, the CD will return to normal play from the track which is playing.

### RPT (Repeat) button:

To change the play settings, push the **RPT** button to select the mode.

CD:

RPT DISC → RPT TRACK

CD with MP3 or WMA:

RPT DISC → RPT FOLDER → RPT TRACK

RPT DISC:

All the tracks of the CD will be played continuously in sequential order. The display indicates no symbol mark. While the **RPT** button is pushed, the display indicates "RPT DISC".

RPT TRACK:

The selected track of the CD will be played continuously. While the **RPT** button is pushed, the display indicates "RPT TRACK".

RPT FOLDER:

All the tracks of selected folder will be played continuously in sequential order (CD with MP3 or WMA only). While the **RPT** button is pushed, the display indicates "RPT FOLDER".

### RDM (Random) button:

To change the play sequence, push the **RDM** button to select the mode.

CD:

RDM DISC → RPT DISC

CD with MP3 or WMA:

RDM DISC → RDM FOLDER → RPT DISC

RPT DISC:

All the tracks of the CD will be played continuously in sequential order. The display indicates no symbol mark. While the **RDM** button is pushed, the display indicates "RPT DISC".

RDM DISC:

All the tracks or folders (CD with MP3 or WMA only) of the CD will be played continuously in random order. While the **RDM** button is pushed, the display indicates



“RDM DISC”.

RDM FOLDER:

All the tracks of the selected folder will be played continuously in random order (CD with MP3 or WMA only). While the **RDM** button is pushed, the display indicates “RDM FOLDER”.

### **SCRL** (Scroll) button:

When the title is displayed but it is a long one, the whole title is not shown in the display. In this case, push the button to scroll the title. When the title is scrolled to the end of it, the display will stop moving and return to the first condition.

### **CD EJECT** button:

To eject a CD, push the CD EJECT  button.

When the  button is pushed twice, the CD will be ejected further, and the CD can be removed with ease.

If a CD is ejected by pushing the  button, and it is not taken out from the loading slot, the CD will automatically be reloaded to the slot to protect the CD (12 cm discs only).

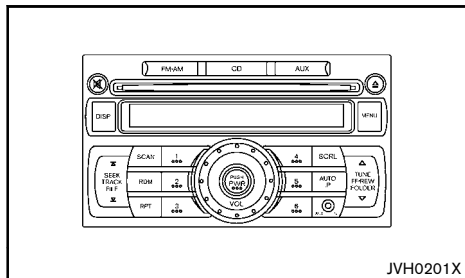

### FM-AM radio operation



The audio system operates when the ignition switch is in the “ACC” or “ON” position.

### Frequency range and step change (for Central/South America):

To change the frequency range and step specification of the radio, perform the following operations.

1. Turn the audio unit off by pushing the POWER button.
2. Turn the audio unit on by pushing the POWER button while pushing the radio memory buttons   and the  button.

For Central/South America specification, the display indicates “AM 530 kHz”.

For the other specification, the display indicates “AM 531 kHz”.

If you experience difficulties in changing radio specification, contact a NISSAN dealer.

### **FM + AM** button:

When the  button is pushed while the audio system is off, the audio system will turn on and the radio will turn on.



When the  button is pushed while another audio source is playing, the another audio source will turn off and the radio will turn on.



To change the radio bands, push the  button until the desired band is displayed.

- AM → FM1 → FM2



The FM stereo indicator, “ST” will display during FM stereo reception. When the stereo broadcast signal is weak, the radio will automatically change from stereo to monaural reception.

### **TUNE/FF-REW/FOLDER** button:

When adjusting the broadcasting station frequency manually, push the  or  button until the desired frequency is achieved.

When adjusting the broadcasting station frequency automatically, push the  or  button. When the system detects a broadcasting station, it will stop at the station.

### **SEEK** button:

When adjusting the broadcasting station frequency automatically, push the   button. When the system detects a broadcasting station, it will stop at the station.

### **SCAN** button:



When the  button is pushed, the system will seek and stop at the detected broadcasting station for 5 seconds, and then it will start to seek for the next broadcasting station.

Push the  button in this 5-second period to stop seeking.

### Radio memory button:

The audio system can store up to 12 FM station frequencies (for FM1 and FM2) and 6 AM station frequencies.

To store the station frequency:

1. Tune to the desired broadcasting station frequency by using the  or  button.
2. Push and hold a memory button (1 - 6) until a beep sounds.

3. The switch number and frequency will appear on the display when the memory is stored properly.

4. Perform steps 1 - 3 for all other memory buttons.

Push a memory button (1 - 6) to select a desired memory.

If the battery cable is disconnected, or if the audio fuse blows, the radio memory will be erased. In such a case, reset the desired stations.

**AUTO.P (Automatic Preset) button:**

The audio system can store up to 6 FM station frequencies and 6 AM station frequencies.

To store the station frequency automatically, push and hold the **AUTO.P** button until a beep sounds. The station will be automatically stored in the "AUTO.P" memory. The display indicates "AP-\*\*\*".

Push the **AUTO.P** button to select a desired memory.

### FM-AM RADIO WITH COMPACT DISC (CD) PLAYER (Type D)

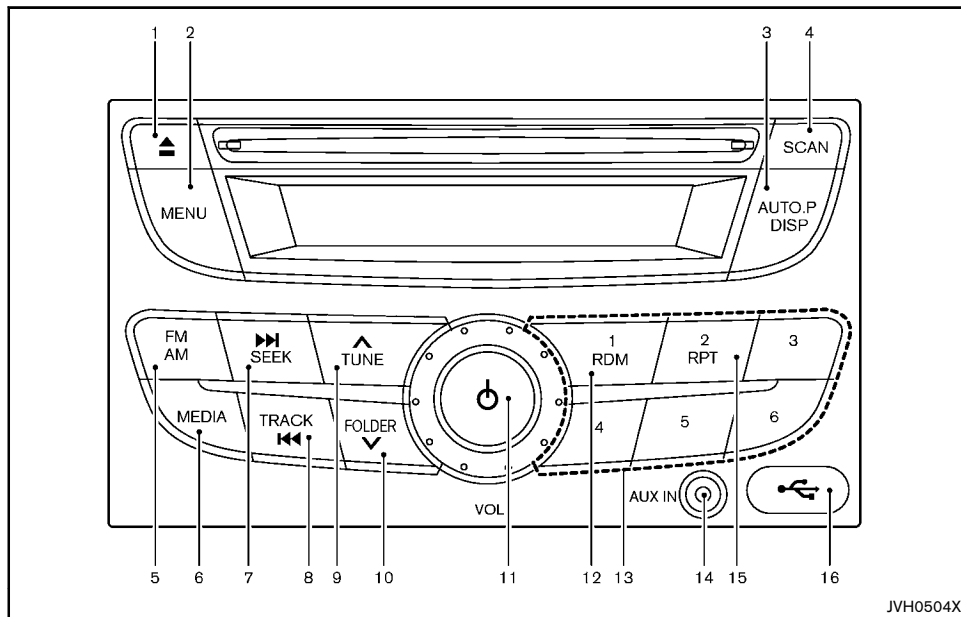

- |                             |                          |
|-----------------------------|--------------------------|
| 1. CD eject button          | 9. TUNE button           |
| 2. MENU button              | 10. FOLDER button        |
| 3. AUTO.P/DISP button       | 11. Power/VOL dial       |
| 4. SCAN button              | 12. RDM button           |
| 5. FM/AM band select button | 13. Radio memory buttons |
| 6. MEDIA button             | 14. AUX IN jack          |
| 7. SEEK button              | 15. RPT button           |
| 8. TRACK button             | 16. USB connector        |

## Audio main operation

The audio system operates when the ignition switch is in the "ACC" or "ON" position.



### Power/VOL dial:

#### Power ON/OFF:

To turn on the audio system, push the dial.

- The system will turn on in the mode, which was used immediately before the system was turned off.
- If a CD, a USB and/or an AUX device was connected when the system was turned off, and if the system was turned on again with the devices disconnected, the radio will turn on.

To turn off the audio system, push the dial.

#### Volume control:

To control the volume, turn the dial.

Turn the dial clockwise to make the sound louder.

Turn the dial counterclockwise to make the sound quieter.

#### MENU button:

To change the audio settings, push the button to select the mode.

Push the button repeatedly until the desired mode appears on the display.

(Normal) → BAS (Bass) → TRE (Treble) → BAL (Balance) → FAD (Fader) → CLK (Clock) → (Normal)

Push the / button or / button to adjust the audio settings.

BAS: (-) to decrease / (+) to increase

TRE: (-) to decrease / (+) to increase

BAL: (R) to right balance / (L) to left balance

FAD: (F) to front fade / (R) to rear fade

Once the audio settings are set to the desired level, push the button until the normal audio display appears.

If no action is performed for approximately 5 seconds, the audio settings mode will automatically return to the normal mode.

#### Clock display:

To display the clock on the screen, perform the following operations.

1. Push the button repeatedly until "CLK ON" or "CLK OFF" appears on the display while the audio system is on.
2. Push the / button or / button to select "CLK ON".

The clock display can be turned on or off temporarily by pushing the button.

#### Clock adjustment:

To adjust the clock, turn the clock display on and perform the following operations.

1. Push the button while "CLK ON" is on the display. The hour digits blink.
2. To adjust the hours, push the / button or / button.
3. Push the button again. The minute digits blink.
4. To adjust the minutes, push the / button or / button.

If no user input is detected for 5 seconds, or when the button is pushed, the clock setting mode will

automatically return to the normal mode.

#### MEDIA button:

Push this button to switch the mode to CD, USB or another AUX device.

When the button is pushed with no device connected, the audio system does not change modes.

#### AUX IN jack:

The AUX IN jack is located on the audio unit. The AUX IN audio input jack accepts any standard analog audio input such as from a portable cassette tape player, CD player, digital audio player or laptop computer.

Push the button to play a compatible device when it is plugged into the AUX IN jack.

NISSAN strongly recommends using a stereo mini plug cable when connecting your music device to the audio system. Music may not play properly when a monaural cable is used.



#### WARNING:

**Do not allow the cable or an external device connected to the AUX terminal to affect your driving.**

#### NOTE:

- Depending on the external device, please note that the volume may be louder or quieter than that of the external device.
- When the AUX contacts the plug of the connector cable, noise may be heard.
- The connected external device cannot be operated with the main audio system. The volume and sound quality can be adjusted.

- The song title in the external device cannot be displayed on the audio display.
- For the power source of the external device, use the special battery. The external device cannot be charged with the AUX terminal. Noise may be heard if the CD, radio etc. is operated while charging the battery with the power socket of the vehicle.

## CD player operation

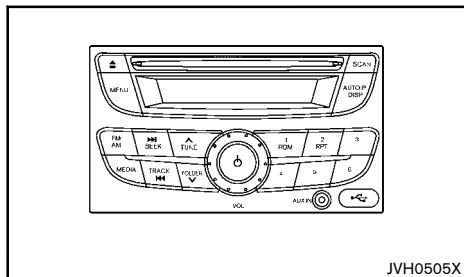

The audio system operates when the ignition switch is in the "ACC" or "ON" position.

### Loading:

Insert a CD into the slot with the label side facing up. The CD will be guided automatically into the slot and will start playing. To stop playback, push the dial.



### CAUTION:

**Do not force the compact disc into the slot. This could damage the player.**

### MEDIA button:

To play a CD, push the button repeatedly while the CD is loaded until the display changes to the CD mode.

### SEEK/TRACK buttons:

#### Fast forward/Rewind:

When the or button is pushed and held while a CD is being played, the CD will play while fast forwarding or rewinding.

When the button is released, the CD will return to normal play speed.

#### Track up/down:

To play the next track, push the button while a CD is playing.

To play the previous track, push the button within 2 seconds after the current track starts playing. To return to the beginning of the current track, push the button after the current track has played for at least 2 seconds.

### TUNE/FOLDER buttons (for CD with MP3/WMA):

To skip to the next or previous folder, push the or button.

### SCAN button:

When the button is pushed while a CD is being played, the first 10 seconds of all the tracks will be played.

When the button is pushed again, the CD will return to normal play from the track which is playing.

### RPT button:

Push the button to select the mode.

#### CD:

(Normal) → RPT

#### CD with MP3 or WMA:

(Normal) → Track RPT → Folder RPT

Track RPT:

The selected track will play repeatedly.

Folder RPT (CD with MP3 or WMA only):

All the tracks in the selected folder will play repeatedly in sequential order.

### RDM button:

Push the button to select the mode.

#### CD:

(Normal) → RDM

#### CD with MP3 or WMA:

(Normal) → Folder RDM → All RDM

Folder RDM:

All the tracks in the selected folder will play repeatedly in random order.

All RDM:

All the tracks on the selected CD will play in random order.

### CD Eject button:

To eject a CD, push the button.

When the button is pushed twice, the CD will be ejected further and the CD can be removed with ease.

If a CD is ejected by pushing the button, and it is

not taken out from the loading slot, the CD will automatically be reloaded to the slot to protect the CD.

## FM-AM radio operation

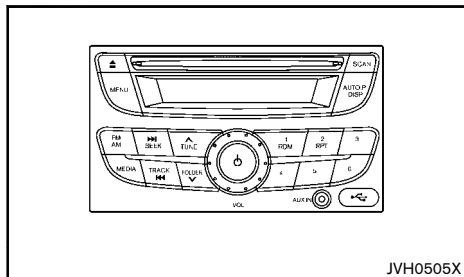

The audio system operates when the ignition switch is in the “ACC” or “ON” position.

### **FM/AM** FM/AM band select button:

When the **FM/AM** button is pushed while the audio system is off, the audio system and the radio will turn on.

When the **FM/AM** button is pushed while another audio source is playing, the other audio source will turn off and the radio will turn on.

To change the radio bands, push the **FM/AM** button until the desired band is displayed.

AM → FM1 → FM2

### **TUNE/FOLDER** buttons:

When adjusting the broadcasting station frequency manually, push the **TUNE/FOLDER** button until the preferred frequency is achieved.

### **SEEK/TRACK** buttons:

To adjust the broadcasting station frequency automatically, push the **SEEK/TRACK** button. When the system detects a broadcasting station, it will stop at that station.

### **SCAN** SCAN button:

When the **SCAN** button is pushed, the system will seek and stop at the detected broadcasting station for 5 seconds, and then it will start to seek for the next broadcasting station.

Push the **SCAN** button in this 5-second period to stop seeking.

### **1 2 3 4 5 6** (Radio memory) buttons:

The audio system can store up to 12 FM station frequencies (for FM1 and FM2) and 6 AM station frequencies.

To store the station frequency:

1. Tune to the desired broadcasting station frequency.
2. Push and hold a memory button ( **1** - **6** ) until a beep sounds.
3. The switch number and frequency will appear on the display when the memory is stored properly.
4. Perform steps 1 - 3 for all other memory buttons.

Push a memory button ( **1** - **6** ) to select the desired memory.

If the battery cable is disconnected, or if the audio fuse blows, the radio memory will be erased. In this case, reset the desired stations.

### **AUTO.P/DISP** AUTO.P/DISP button:

The audio system can store up to 6 FM station frequencies and 6 AM station frequencies.

To store the station frequency automatically, push and hold the **AUTO.P/DISP** button until a beep sounds. The station will be automatically stored in the “AUTO.P” memory. The display indicates “AUTO.P”.

Push the **AUTO.P/DISP** button to select a memory.

## USB memory device operation

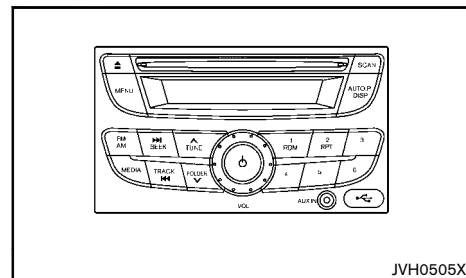

### **Audio main operation:**

The USB outlet connector is located on the audio unit. Open the lid and connect a USB memory device into the connector. The system switches to the USB mode automatically.

If the system has been turned off while the USB memory device was playing, pushing the **POWER** dial will start playback of the USB memory device.

If the USB memory device cannot be played, the message “CHK USB” will be displayed.



## CAUTION:



- **Do not force the USB memory device into the USB port. Inserting the USB memory device tilted or upside down into the port may damage the USB memory device and/or the port. Make sure that the USB memory device is connected to the USB port correctly. (Some USB devices come with a  mark as a guide. Make sure that the mark is facing the correct direction before inserting the device.)**
- **Do not place objects near the USB memory device to prevent the objects from leaning on the USB memory device and the port. Pressure from the objects may damage the USB memory device and/or the port.**



### MEDIA button:

When the  button is pushed with the system off and the USB memory device is inserted, the system will turn on.

If another audio source is playing and a USB memory device is inserted, push the  button repeatedly until the display changes to the USB mode.

### SEEK/TRACK buttons:

When the  or  button is pushed and held while a USB memory device is being played, the USB memory device will play while fast forwarding or rewinding. When the button is released, the USB memory device will return to normal play speed.

When the  or  button is pushed while the USB memory device is being played, the next track or the beginning of the current track on the USB memory

device will be played.

### TUNE/FOLDER buttons:

To change to another folder in the USB memory device, push the  or  button.

### RPT button:

When the  button is pushed while a USB memory device is being played, the play pattern can be changed as follows.

(Normal) → Track RPT → Folder RPT → (Normal)

### RDM button:

When the  button is pushed while a USB memory device is being played, the play pattern can be changed as follows.

(Normal) → Folder RDM → All RDM → (Normal)

### SCAN button:

When the  button is pushed while a USB memory device is being played, the first 10 seconds of all the tracks will be played.

When the  button is pushed again, the USB memory device will return to normal play from the track which is playing.

## FM-AM RADIO WITH COMPACT DISC (CD) PLAYER (Type E)

17. AUX button

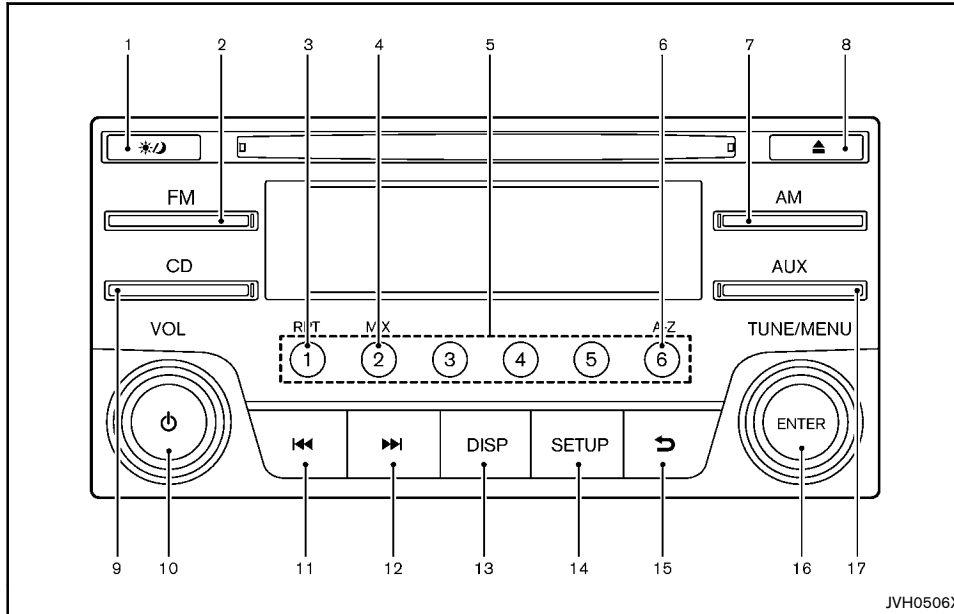

- |                         |                          |
|-------------------------|--------------------------|
| 1. Day/Night button     | 9. CD button             |
| 2. FM button            | 10. Power/VOL dial       |
| 3. RPT button           | 11. Rewind button        |
| 4. MIX button           | 12. Fast Forward button  |
| 5. Radio memory buttons | 13. DISP button          |
| 6. A-Z button           | 14. SETUP button         |
| 7. AM button            | 15. Back button          |
| 8. CD eject button      | 16. TUNE/MENU/ENTER dial |

## Audio main operation

The audio system operates when the ignition switch is in the "ACC" or "ON" position.



### Power/VOL dial:

#### Power ON/OFF:

To turn on the audio system, push the dial.

- The system will turn on in the mode that was used immediately before the system was turned off.
- If a CD is inserted, or a USB and/or an AUX device is connected when the system is turned off, and if the system was turned on again with the devices removed or disconnected, the radio will turn on.

To turn off the audio system, push the dial.

#### Volume control:

To control the volume, turn the dial.

Turn the dial clockwise to make the sound louder.

Turn the dial counterclockwise to make the sound quieter.

#### SETUP button:

To configure Audio, Clock, Language or Scroll direction settings, perform the following procedure:

1. Push the button.
2. Push the dial.
3. Turn the dial clockwise or counterclockwise. The setting menu will be displayed in the following order:

Audio    Clock    Language    Scroll Direction

After the desired levels have been set, either push the button repeatedly, push the button, or wait for several seconds without pushing any buttons to exit

the menu screen.

#### Audio adjustments:

Push the button to enter the setup menu screen and then select "Audio".

Each time the dial is pushed, the mode will change as follows:

BASS → TREBLE → BALANCE → FADE → AUX VOL → Audio (setup menu screen) → BASS

Turn the dial clockwise or counterclockwise to adjust the following items and push the dial to confirm.

Bass control:

Use this control to enhance or attenuate the bass response sound.

Treble control:

Use this control to enhance or attenuate the treble.

Balance control:

Use this control to adjust the balance of the volume between the left and right speakers.

Fader control:

Use this control to adjust the balance of the volume between the front and rear speakers (if equipped).

AUX VOL (Auxiliary volume) control:

Use this control to adjust the volume output from the auxiliary source.

#### Clock setting:

Push the button to enter the setup menu screen and then select "Clock".

Turn the dial. The mode will change as follows:

Set Time    ON/OFF    Clock Format    Set Time

Set Time:

Select "Set Time" and then adjust the clock as follows:

The hour display will start flashing. Turn the dial to adjust the hour and push the dial. The minute display will start flashing. Turn the dial to adjust the minute and push the dial to finish the clock adjustment.

ON/OFF:

Set the clock display to on or off when the audio unit is turned off. If set in the "ON" position, the clock will be displayed when the audio unit is turned off either by pushing the dial or when the ignition switch is placed in the "OFF" position.

Clock Format:

Switch the clock display between 24-hour and 12-hour clock mode.

#### Language setting:

Push the button to enter the setup menu screen then select "Language".

Select the appropriate language and push the dial. Upon completion, the screen will automatically adopt the language setting.

#### Scroll direction:

Set the scrolling behavior of the dial to scroll UP or DOWN.



#### Day/Night button:

Push the button to switch the display brightness between the daytime and nighttime modes.



## **AUX** AUX button:

Push the **AUX** button to play a compatible device when it is connected.

## CD player operation

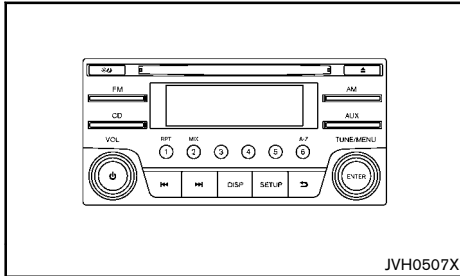

The audio system operates when the ignition switch is in the "ACC" or "ON" position.

## Loading:

Insert a CD into the slot with the label side facing up. The CD will be guided automatically into the slot and will start playing. After loading the CD, the number of tracks and the playtime will appear on the display.



## **CAUTION:**

**Do not force the CD into the slot. This could damage the player.**

## NOTE:

- The CD player accepts normal audio CDs or CDs containing MP3/WMA files.
- The audio unit will automatically detect if a CD containing MP3/WMA files is inserted, and "MP3CD" will be displayed.

- An error notification message will be displayed when an incompatible disc is inserted (e.g. DVD), or if the player cannot read the CD. Eject the disc and insert another disc.

## List view:

While the track is being played, push either the **ENTER** dial or the **[ ]** button to display the available tracks in a listed view mode. Turn the **ENTER** dial to select a track from the list, or a track to start listening to, and then push the **ENTER** dial.

## Quick search:

In the list view mode, a quick search can be performed to find a track from the list. Push the **[A-Z]** button, turn the **ENTER** dial to the first alphabetic letter of the song title and then push the **ENTER** dial. When found, a list of the available songs will be displayed. Select a song and then push the **ENTER** dial to start playback.

## **CD** CD button:

When the **CD** button is pushed while the audio system is turned off and a CD is loaded, the audio system will turn on and a CD will start playing automatically. If the radio or AUX source mode is already playing, it will automatically turn off and the CD will start playing.

However, if a CD is not loaded, then a notification message will be displayed and the audio unit will remain in the radio or AUX source mode.

## **[ ] [ ]** Fast Forward/Rewind buttons:

Push and hold the **[ ]** / **[ ]** buttons to fast forward or rewind through the track. When the button is released, the track will play at normal playing speed.

Track up/down:

By pushing the **[ ]** / **[ ]** buttons once, the track will skip forward to the next track or backward to the beginning of the current track. Push the **[ ]** / **[ ]** buttons more than once to skip through the tracks.

## Folder browsing:

If the recorded media contains folders with music files, pushing the **[ ]** / **[ ]** button will play the tracks of each folder in sequence.

To select a preferred folder:

1. Push the **ENTER** dial or **[ ]** button and a list of tracks in the current folder will be displayed.
2. Push the **[ ]** button.
3. Turn the **ENTER** dial to highlight the preferred folder.
4. Push the **ENTER** dial to access the folder. Push the **ENTER** dial again to start playing the first track or turn the **ENTER** dial, and push the **ENTER** dial to select another track.

If the current selected folder contains sub folders, push the **ENTER** dial, a new screen with a list of sub folders will be displayed. Turn the **ENTER** dial to highlight the sub folder and then push the **ENTER** dial to select. Select the root folder item when songs are recorded additionally in the root folder.

To return to the previous folder screen, push the **[ ]** button.

## **RPT** RPT button:

Push the **RPT** button and the current track will be played continuously.

### **MIX** MIX button:

Push the **MIX** button and all the tracks will be played in random order.

### **DISP** DISP button:

While a CD with recorded music information tags (CD-text/ID3-text tags) is being played, the title of the played track is displayed. If the title information is not provided then "Track" is displayed.

When the **DISP** button is pushed repeatedly, further information about the track can be displayed along with the track title as follows:

CD:

Track time → Artist → Song → Album → Track time

CD with MP3/WMA:

Track time → Artist → Album → Folder name → Track time

Track details:

By pushing and holding the **DISP** button, the display will show a detailed overview and after a few seconds it will return to the main display. Push the **DISP** button briefly to return to the main display immediately.

### **EJECT** CD Eject button:

When the **EJECT** button is pushed while a CD is loaded, the CD will be ejected.

When the **EJECT** button is pushed twice, the CD will be ejected further, so that the CD can be removed with ease.

When the ignition switch is in the "OFF" or "LOCK" position it is possible to eject the CD currently being played. However the audio unit will not be activated.

If a CD is ejected by pushing the **EJECT** button, and it is not removed from the loading slot for some time, the CD will automatically be reloaded to the slot to protect the CD.

### FM-AM radio operation

The audio system operates when the ignition switch is in the "ACC" or "ON" position.

### **FM** **AM** FM/AM buttons:

When the **FM** / **AM** button is pushed while the audio system is off, the audio system will turn on and the radio will turn on.

When the **FM** / **AM** button is pushed while another audio source is playing, the other audio source will turn off and the radio will turn on.

To change the radio band (FM1, FM2, or AM), push the **FM** / **AM** button.

### **ENTER** ENTER dial:

When adjusting the broadcasting station frequency manually, turn the **ENTER** dial until the preferred frequency is achieved.

### **FF** **RR** Fast Forward/Rewind buttons:

When adjusting the broadcasting station frequency automatically, push the **FF** / **RR** button. When the system detects a broadcasting station, it will stop at the station.

### ① ② ③ ④ ⑤ ⑥ (Radio memory) buttons:

During radio reception, pushing the radio memory button for less than 2 seconds will select the stored radio station.

The audio system can store up to 18 FM station frequencies (six in each of FM 1, FM 2 and FM T) and 6 AM station frequencies.

To store the station frequency manually:

1. Tune to the desired broadcasting station frequency by using the **FF** / **RR** button.
2. Push and hold a radio memory button ① - ⑥ until a beep sounds. (The radio mutes when the memory button is pushed.)
3. The channel indicator will display and the radio mute disengages, indicating that the memory is stored properly.
4. Perform steps 1 - 3 for all other memory buttons.

If the battery cable is disconnected, or if the audio fuse blows, the radio memory will be erased. If this occurs, reset the desired stations.

### USB memory device operation

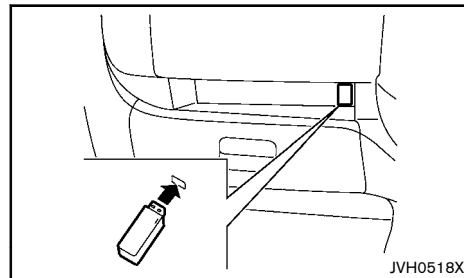

JVH0518X

### Audio main operation:

The USB outlet connector is located on the instrument panel. Open the lid and connect a USB memory device to the connector. The system will switch to the USB memory device mode automatically.

If the system is turned off while the USB memory device is playing, pushing the  dial will start the USB memory device.

If the USB memory device cannot be played, one of the following messages will be displayed.

- “USB memory device not supported”
- “No audio file detected”







### CAUTION:

- **Do not force the USB memory device into the USB port. Inserting the USB memory device tilted or upside down into the port may damage the USB memory device and/or the port. Make sure that the USB memory device is connected correctly into the USB port. (Some USB devices come with a  mark as a guide. Make sure that the mark is facing the correct direction before inserting the device.)**
- **Do not place objects near the USB memory device to prevent the objects from leaning on the USB memory device and the port. Pressure from the objects may damage the USB memory device and/or the port.**



### AUX button:

To operate the USB memory device use one of the following methods:

- Push the  button and then turn the  dial to select the USB item. Once highlighted, push the  dial.
- Push the  button repeatedly until “USB” is highlighted, and then push the  dial.

### Audio main operation:

The following operations are identical to the audio main operation of the Compact Disc (CD) operation. For details, see “CD player operation” (P.4-40).

- List view
- Quick search
-  
- MIX (Random play)
- RPT (Repeat track)
- Folder browsing



### DISP button:

While a track with recorded music information tags (ID3-tags) is being played, the title of the played track will be displayed. If the tags are not provided, a notification message will be displayed.

When the  button is pushed repeatedly, further information about the track can be displayed along with the track title as follows:

Track time → Artist → Album → Folder name → Track time

Track details:

By pushing and holding the  button the display will show a detailed overview and after a few seconds it will return to the main display. Push the  button briefly to return to the main display immediately.

### iPod player operation

#### Connecting iPod:

The USB outlet connector is located in the center console. Open the USB outlet connector lid and connect the iPod cable to the USB connector. The battery of the iPod is charged while the device is connected to the vehicle.

Depending on the version of the iPod, the display on the iPod shows a NISSAN or Accessory Attached screen when the connection is completed. When the iPod is connected to the vehicle, the iPod music library can only be operated by the vehicle audio controls.

\* iPod and iPhone are trademarks of Apple Inc., registered in the U.S. and other countries.



### CAUTION:

- **Do not force the iPod cable into the USB port. Inserting the iPod cable tilted or upside down into the port may damage the iPod cable and the port. Make sure that the iPod cable is connected correctly into the USB port. (Some iPod cables come with a  mark as a guide. Make sure that the mark is facing the correct direction before inserting the iPod cable.)**
- **Do not locate objects near the iPod cable to prevent the objects from leaning on the iPod cable and the port. Pressure from the objects may damage the iPod cable and the port.**

## Compatibility:

The following models are supported:

- Third generation iPhone (Firmware version IOS4/4.0)
- Fourth generation iPhone (Firmware version IOS4/4.0)
- Fifth generation iPod (Firmware version 1.3)
- First generation iPod Classic (Firmware version 1.1.1 or 1.1.2PC)
- Second generation iPod Classic (Firmware version 2.0.1)
- First generation iPod touch (Firmware version 1.1.5 or 2.2.1)
- Second and third generation iPod touch (Firmware version 2.2.1 or IOS4/4.0.0)
- First generation iPod nano (Firmware version 1.3.1)
- Second generation iPod nano (Firmware version 1.1.3)
- Third generation iPod nano (Firmware version 1.1.2PC or 1.1.3PC)
- Fourth generation iPod nano (Firmware version 1.0.2 or 1.0.4)
- Fifth generation iPod nano (Firmware version 1.0.1 or 1.0.2)

The iPod touch may not respond quickly to the system in some cases.

Make sure that the iPod firmware is updated.

## Operating tips:

- iPod Shuffle and iPod mini are not supported.
- Some iPod operations may not be available with this system.

## AUX AUX button:

To operate the iPod use one of the following methods:

- Push the **AUX** button and then turn the **ENTER** dial to select for the USB item. Once highlighted, push the **ENTER** dial.
- Push the **AUX** button repeatedly until "USB" is highlighted and then push the **ENTER** dial.

## Audio main operation:

Interface:

The interface for iPod operation shown on the audio system display is similar to the iPod interface. Use the **ENTER** dial to play a track on the iPod.

The following items can be chosen from the menu list screen.

- Playlists
- Artists
- Albums
- Tracks
- Genres

For further information about each item, see the iPod owner's manual.

The following operations are identical to the audio main operation of Compact Disc (CD) operation. For details, see "CD player operation" (P.4-40).

- List view
- Quick search
- 
- MIX (Random play)
- RPT (Repeat track)
- Folder browsing

## DISP DISP button:

While a track with recorded music information tags (ID3-tags) is being played, the title of the played track is displayed. If the tags are not provided then a notification message is displayed.

When the **DISP** button is pushed repeatedly, further information about the track can be displayed along with the track title as follows:

Track time → Artist → Album → Folder name → Track time

Track details:

By pushing and holding the **DISP** button, the display will show a detailed overview and after a few seconds it will return to the main display. Push the **DISP** button briefly to return to the main display immediately.

## Radio Broadcast data system (RBDS)

The RBDS is a system through which encoded digital information is transmitted by FM radio stations in addition to the normal FM radio broadcasting. The RBDS provides information services such as station name, traffic information, and news.

## NOTE:

**In some countries or regions, some of these services may not be available.**

## RBDS functions

### Programme Service (PS) function (station name display function):

When an RBDS station is tuned in with seek or manual tuning, the RBDS data is received and the PS name is displayed.

## FM-AM RADIO WITH COMPACT DISC (CD) PLAYER (Type F)

17. Phone button

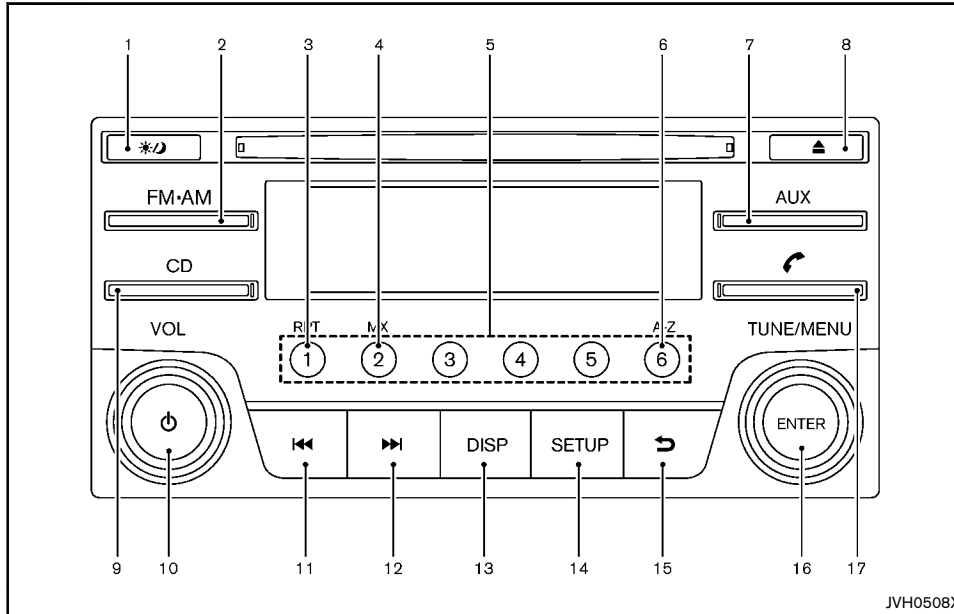

- |                             |                          |
|-----------------------------|--------------------------|
| 1. Day/Night button         | 9. CD button             |
| 2. FM-AM band select button | 10. Power/VOL dial       |
| 3. RPT button               | 11. Rewind button        |
| 4. MIX button               | 12. Fast Forward button  |
| 5. Radio memory buttons     | 13. DISP button          |
| 6. A-Z button               | 14. SETUP button         |
| 7. AUX button               | 15. Back button          |
| 8. CD eject button          | 16. TUNE/MENU/ENTER dial |

## Audio main operation

The audio system operates when the ignition switch is in the "ACC" or "ON" position.



### Power/VOL dial:

#### Power ON/OFF:

To turn on the audio system, push the dial.

- The system will turn on in the mode, which was used immediately before the system was turned off.
- If a CD is inserted or a USB and/or an AUX device is connected when the system is turned off, and if the system is turned on again with the devices removed or disconnected, the radio will turn on.

To turn off the audio system, push the dial.

#### Volume control:

To control the volume, turn the dial.

Turn the dial clockwise to make the sound louder.

Turn the dial counterclockwise to make the sound quieter.

#### SETUP button:

To configure Audio, Clock, Bluetooth, Language or Scroll direction settings, perform the following procedure:

1. Push the button.
2. Push the dial.
3. Turn the dial clockwise or counterclockwise. The setting menu will be displayed in the following order:  
Audio    Clock    Bluetooth    Language  
Scroll Direction

After the desired levels have been set, either push the



button repeatedly, push the button, or wait for several seconds without pushing any buttons to exit the menu screen.

#### Audio adjustments:

Push the button to enter the setup menu screen and then select "Audio".

Each time the dial is pushed, the mode will change as follows:

BASS → TREBLE → BALANCE → FADE → AUX VOL → SPD VOL → Audio (setup menu screen) → BASS

Turn the dial clockwise or counterclockwise to adjust the following items and push the dial to confirm.

##### Bass control:

Use this control to enhance or attenuate the bass response sound.

##### Treble control:

Use this control to enhance or attenuate the treble.

##### Balance control:

Use this control to adjust the balance of the volume between the left and right speakers.

##### Fader control:

Use this control to adjust the balance of the volume between the front and rear speakers (if equipped).

##### AUX VOL (Auxiliary volume) control:

Use this control to adjust the volume output from the auxiliary source.

##### SPD VOL (Speed volume) control:

This mode controls the volume output from the speakers automatically in relation to vehicle speed.

Adjusting the setting to "0" (zero) turns off the speed

volume feature.

#### Clock setting:

Push the dial n to enter the setup menu screen and then select "Clock".

Turn the dial, the mode will change as follows:

Set Time    ON/OFF    Clock Format    Set Time

Set Time:

Select "Set Time" then adjust the clock as follows:

The hour display will start flashing. Turn the dial to adjust the hour and push the dial. The minute display will start flashing. Turn the dial to adjust the minute and push the dial to finish the clock adjustment.

#### ON/OFF:

Select the clock display to on or off when the audio unit is turned off. If set in the "ON" position, the clock will be displayed when the audio unit is turned off either by pushing the dial or when the ignition switch is placed in the "OFF" position.

#### Clock Format:

Select the clock display between 24-hour and 12-hour clock mode.

#### Language setting:

Push the button to enter the setup menu screen and then select "Language".

Select the appropriate language and push the dial. Upon completion, the screen will automatically adopt the language setting.

### Scroll direction:

Set the scrolling behavior of the **ENTER** dial to scroll UP or DOWN.



### Day/Night button:

Push the **Day/Night** button to switch the display brightness between the daytime and nighttime modes.



### AUX button:

Push the **AUX** button to play a compatible device when it is connected.

### CD player operation

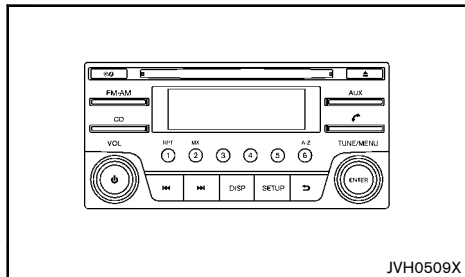

The audio system operates when the ignition switch is in the "ACC" or "ON" position.

### Loading:

Insert a CD into the slot with the label side facing up. The CD will be guided automatically into the slot and will start playing. After loading the CD, the number of tracks and the playtime will appear on the display.



### CAUTION:

**Do not force the CD into the slot. This could damage the player.**

### NOTE:

- **The CD player accepts normal audio CDs or CDs containing MP3/WMA files.**
- **The audio unit will automatically detect if a CD containing MP3/WMA files is inserted, and [MP3CD] will be indicated.**
- **An error notification message will be displayed when an incompatible disc (e.g. DVD) is inserted, or if the player cannot read the CD. Eject the disc and insert another disc.**

### List view:

While the track is being played, push either the **ENTER** dial or the **Track** button to display the available tracks in a listed view mode. Turn the **ENTER** dial to select a track from the list, or a track to start listening to, and then push the **ENTER** dial.

### Quick search:

In the list view mode, a quick search can be performed to find a track from the list. Push the **A-Z** button, turn the **ENTER** dial to the first alphabetic letter of the song title and then push the **ENTER** dial. When found, a list of the available songs will be displayed. Select, and push the **ENTER** dial to play the preferred track.



### CD button:

When the **CD** button is pushed while the audio system is turned off and a CD is loaded, the audio system will turn on and a CD will start playing automatically. If the radio or AUX source mode is already playing, it will automatically turn off and the CD

will start playing.

However, if the CD is not loaded, then a notification message will be displayed and the audio unit will remain in the radio or AUX source mode.



### Fast Forward/Rewind buttons:

Push and hold the **Fast Forward** / **Rewind** buttons to fast forward or rewind through the track. When the button is released, the track will play at normal playing speed.

Track up/down:

By pushing the **Fast Forward** / **Rewind** buttons once, the track will skip forward to the next track or backward to the beginning of the current track. Push the **Fast Forward** / **Rewind** buttons more than once to skip through the tracks.

### Folder browsing:

If the recorded media contains folders with music files, pushing the **Fast Forward** / **Rewind** button will play the tracks of each folder in sequence.

To select a preferred folder:

1. Push the **ENTER** dial or the **Track** button and a list of tracks in the current folder is displayed.
2. Push the **Track** button.
3. Turn the **ENTER** dial to highlight the preferred folder.
4. Push the **ENTER** dial to access the folder. Push the **ENTER** dial again to start playing the first track or turn the **ENTER** dial, and push the **ENTER** dial to select another track.

If the current selected folder contains sub folders, push the **ENTER** dial, and a new screen with a list of sub folders will be displayed. Turn the **ENTER** dial to highlight the sub folder then push the **ENTER** dial to access the sub-folder. Select the root folder item when songs are recorded additionally in the root folder.

To return to the previous folder screen, push the  button.

#### **RPT button:**

Push the  button and the current track will be played continuously.

#### **MIX button:**

Push the  button and all the tracks will be played in random order.

#### **DISP button:**

While a CD with recorded music information tags (CD-text/ID3-text tags) is being played, the title of the played track is displayed. If the title information is not provided then "Track" is displayed.

When the  button is pushed repeatedly, further information about the track can be displayed along with the track title as follows:



CD:

Track time → Artist → Song → Album → Track time

CD with MP3/WMA:

Track time → Artist → Album → Folder name → Track time

Track details:

By pushing and holding the  button will turn the display will show a detailed overview and after a few seconds will return to the main display. Push the  button to return to the main display immediately.

#### **CD Eject button:**

When the  button is pushed while a CD is loaded, the CD will be ejected.

When the  button is pushed twice, the CD will be ejected further, so that the CD can be removed with ease.

When the ignition switch is in the "OFF" or "LOCK" position it is possible to eject the CD currently being played. However the audio unit will not be activated.

If a CD is ejected by pushing the  button, and it is not removed from the loading slot for some time, the CD will automatically be reloaded to the slot to protect the CD.

#### **FM-AM radio operation**

The audio system operates when the ignition switch is in the "ACC" or "ON" position.

#### **FM-AM button:**

When the  button is pushed while the audio system is turned off, the audio system will turn on and the radio will turn on.

When the  button is pushed while another audio source is playing, the other audio source will turn off and the radio will turn on.

To change the radio band, push the  button until the desired band appears.

FM 1 → FM 2 → FM T → AM → FM 1

During FM reception, when the  button is pushed for longer than 1.5 seconds, stations are searched for and the 6 stations of the FM T band are tuned in. During the search, the notification message "AUTO-STORE" appears in the display and the sound is muted until the autostore operation is completed, upon which

preset channel 1 is automatically tuned in.

#### **ENTER dial:**

When adjusting the broadcasting station frequency manually, turn the  dial until the preferred frequency is achieved.

The frequency changes in steps of 100 kHz on the FM band and 9 kHz on the AM band.

#### **Fast Forward/Rewind buttons:**

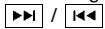

When adjusting the broadcasting station frequency automatically, push the  button. When the system detects a broadcasting station, it will stop at the station.

#### **(Radio memory) buttons:**

During radio reception, pushing the radio memory button for less than 2 seconds will select the stored radio station.

The audio system can store up to 18 FM station frequencies (six in each of FM 1, FM 2 and FM T) and 6 AM station frequencies.

To store the station frequency manually:

1. Tune to the desired broadcasting station frequency by using the  button.
2. Push and hold a radio memory button  -  until a beep sounds. (The radio mutes when the memory button is pushed.)
3. The channel indicator will display and the radio mute disengages, indicating that the memory is stored properly.
4. Perform steps 1 - 3 for all other memory buttons.

If the battery cable is disconnected, or if the audio fuse blows, the radio memory will be erased. If this occurs,



reset the desired stations.

## USB memory device operation

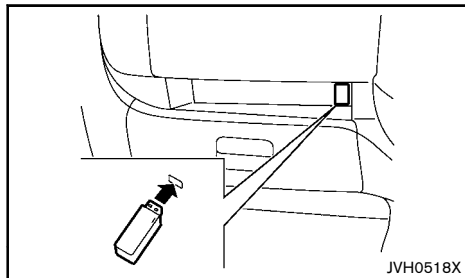

### Audio main operation:

The USB outlet connector is located on the instrument panel. Open the lid and connect a USB memory device into the connector. The system will switch to the USB memory device mode automatically.

If the system is turned off while the USB memory device is playing, pushing the  dial will start the USB memory device.

If the USB memory device cannot be played, one of the following messages will be displayed.

- “USB memory device not supported”
- “No audio file detected”



### CAUTION:





- **Do not force the USB memory device into the USB port. Inserting the USB memory device tilted or upside down into the port may damage the USB memory device and/or the port. Make sure that the USB memory device is connected correctly into the USB port. (Some USB devices come with a **

**mark as a guide. Make sure that the mark is facing the correct direction before inserting the device.)**

- **Do not place objects near the USB memory device to prevent the objects from leaning on the USB memory device and the port. Pressure from the objects may damage the USB memory device and/or the port.**



### AUX button:

To operate the USB memory device use one of the following methods:

- Push the  button then turn the  dial to select the USB item. Once highlighted, push the  dial.
- Push the  button repeatedly until USB is highlighted, and then push the  dial.

### Audio main operation:

The following operations are identical to the audio main operation of the Compact Disc (CD) operation. For details, see “CD player operation” (P.4-46).

- List view
- Quick search
-  
- MIX (Random play)
- RPT (Repeat track)
- Folder browsing



### DISP button:

While a track with recorded music information tags (ID3-tags) is being played, the title of the played track is displayed. If the tags are not provided, a notification message is displayed.

When the  button is pushed repeatedly, further information about the track can be displayed along with the track title as follows:

Track time → Artist → Album → Folder name → Track time

Track details:

By pushing and holding the  button the display will show a detailed overview and after a few seconds it will return to the main display. Push the  button briefly to return to the main display immediately.

## iPod player operation

### Connecting iPod:

The USB outlet connector is located in the center console. Open the USB outlet connector lid and connect the iPod cable to the USB connector. The battery of the iPod is charged while the device is connected to the vehicle.

Depending on the version of the iPod, the display on the iPod shows a NISSAN or Accessory Attached screen when the connection is completed. When the iPod is connected to the vehicle, the iPod music library can only be operated by the vehicle audio controls.

\* iPod and iPhone are trademarks of Apple Inc., registered in the U.S. and other countries.



### CAUTION:

- **Do not force the iPod cable into the USB port. Inserting the iPod cable tilted or upside-down into the port may damage the iPod cable and the port. Make sure that the iPod cable is connected correctly into the USB port. (Some iPod cables come with a  mark as a guide. Make sure that the mark is facing the correct direction before inserting the iPod cable.)**

- **Do not locate objects near the iPod cable to prevent the objects from leaning on the iPod cable and the port. Pressure from the objects may damage the iPod cable and the port.**

#### Compatibility:

The following models are supported:

- Third generation iPhone (Firmware version IOS4/4.0)
- Fourth generation iPhone (Firmware version IOS4/4.0)
- Fifth generation iPod (Firmware version 1.3)
- First generation iPod Classic (Firmware version 1.1.1 or 1.1.2PC)
- Second generation iPod Classic (Firmware version 2.0.1)
- First generation iPod touch (Firmware version 1.1.5 or 2.2.1)
- Second and third generation iPod touch (Firmware version 2.2.1 or IOS4/4.0.0)
- First generation iPod nano (Firmware version 1.3.1)
- Second generation iPod nano (Firmware version 1.1.3)
- Third generation iPod nano (Firmware version 1.1.2PC or 1.1.3PC)
- Fourth generation iPod nano (Firmware version 1.0.2 or 1.0.4)
- Fifth generation iPod nano (Firmware version 1.0.1 or 1.0.2)

The iPod touch may not respond quickly to the system in some cases.

Make sure that the iPod firmware is updated.

#### Operating tips:

- iPod Shuffle and iPod mini are not supported.
- Some iPod operations may not be available with this system.

#### **AUX** AUX button:

To operate the iPod use one of the following methods:

- Push the **AUX** button and then turn the **ENTER** dial for the USB item. Once highlighted, push the **ENTER** dial.
- Push the **AUX** button repeatedly until USB is highlighted and then push the **ENTER** dial.

#### Audio main operation:

Interface:

The interface for iPod operation shown on the audio system display is similar to the iPod interface. Use the **ENTER** dial to play a track on the iPod.



The following items can be chosen from the menu list screen.

- Playlists
- Artists
- Albums
- Tracks
- Genres

For further information about each item, see the iPod owner's manual.

The following operations are identical to the audio main operation of the Compact Disc (CD) operation. For details, see "CD player operation" (P.4-46).

- List view
- Quick search

-  
- MIX (Random play)
- RPT (Repeat track)
- Folder browsing

#### **DISP** DISP button:

While a track with recorded music information tags (ID3-tags) is being played, the title of the played track is displayed. If the tags are not provided then a notification message is displayed.

When the **DISP** button is pushed repeatedly, further information about the track can be displayed along with the track title as follows:

Track time → Artist → Album → Folder name → Track time

Track details:

By pushing and holding the **DISP** button the display will show a detailed overview and after a few seconds it will return to the main display. Push the **DISP** button briefly to return to the main display immediately.

#### Bluetooth® audio player operation

#### Regulatory information:



Bluetooth® is a trademark owned by Bluetooth SIG, Inc., and licensed to Daewoo IS Corp.

#### CE statement:

Hereby Daewoo IS Corp. declares that this system is in compliance with the essential requirements and other relevant provisions of Directive 1999/5/EC.



## NOTE:

The audio system only supports Bluetooth® devices with AVRCP (Audio Video Remote Control Profile) version 1.3, 1.0, or earlier.

### Bluetooth® audio player setting:

To set up the Bluetooth® system with your preferred device, push the **SETUP** button and select Bluetooth®, and then push the **ENTER** dial or alternatively, push the **↶** button. The following items are available:

- Pair Device  
Bluetooth® devices can be paired with the system. A maximum of 5 devices can be registered.
- Select Device  
Paired Bluetooth® devices are listed and can be selected for connection.
- Delete Device  
A registered Bluetooth® device can be deleted.
- On/Off

If this setting is turned off, the connection between the Bluetooth® devices and the in-vehicle Bluetooth® module will be cancelled.

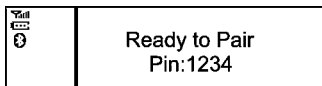

Pair Device:

1. Push the **SETUP** button. Select the Bluetooth® key by turning the **ENTER** dial, and then push the **ENTER** dial.

You can register up to 5 different Bluetooth®

audio/cellular phone devices. However, you can only use one device at a time. If you have 5 different Bluetooth® devices, a newly registered device can only replace one of the already registered 5 existing paired devices. Use the "Delete Device" key to delete one of the existing paired devices.

2. Select the "Pair Device" key.

The pairing procedure depends on the connected device:

- Cellular phone:  
The message Ready to Pair Pin:1234 will be displayed.

- Audio device without PIN code:  
The Bluetooth® connection will be automatically connected without any further input.

- Audio device with PIN code:  
A new screen will appear. Assign the 4 digit PIN code by turning the **ENTER** dial to each digit of the code and pushing the **ENTER** dial to confirm each digit. After the PIN code is input, select "Validate" and push the **ENTER** dial. The Bluetooth® connection will be made.

The 4-digit PIN code is provided with the audio device, see the owner's manual of the audio device.

3. On Bluetooth® audio/cellular phone devices:
  - a. Check that Bluetooth® is turned on, on your device.
  - b. Switch to the search mode for Bluetooth® devices. If the search mode finds a device it will be shown on the device display. Select My Car.

- c. Enter the number code shown on the relevant device with the device's own keypad, and push the confirmation key on the device itself. Refer to the relevant Bluetooth® device owner's manual for further details.

When the device is successfully paired a notification message will be displayed, and then the audio system display will return to the current audio source display. During connection the following status icons will be displayed (top left of the display): Signal strength (📶), Battery status\* (🔋) and Bluetooth® "ON" (📶).

\*: If the low battery message comes on, the Bluetooth® device must be recharged soon.

The pairing procedure and operation may vary according to device type and compatibility. See the owner's manual of the Bluetooth® device for further details.

Select Device:

The paired device list shows which Bluetooth® audio or cellular phone devices have been paired or registered with the Bluetooth® audio system. If the list contains devices, select the appropriate device to connect to the Bluetooth® audio system.



The following symbols indicate the capability of the registered device:

- 📶 : cellular phone integration
- 🎵 : Audio streaming (A2DP- Advanced Audio Distribution Profile)

Delete Device:

A registered device can be removed from the Bluetooth® audio system. Select a registered device then push the **ENTER** button to confirm deletion.

On/Off:

If Bluetooth® has been switched off, a notification message On/Off appears when you select Bluetooth® from the setup menu screen, or push the  button. To turn the Bluetooth® signal on, push the  dial and a follow up screen will appear. Select “On” and push the  dial to display the Bluetooth® settings menu screen.



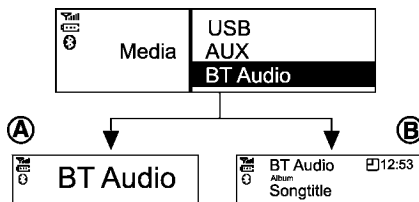

### Bluetooth® audio streaming main operation:



Turn the ignition switch to the “ACC” or “ON” position. If the audio system is turned off while the Bluetooth® audio is playing, pushing the  dial will start Bluetooth® audio streaming.

### **AUX button:**



To operate Bluetooth® audio streaming use one of the following methods:

- Push the  button, then turn the  dial to highlight BT Audio, and push the  dial.
- Push  repeatedly until BT Audio is highlighted, then push the  dial.





The type of display, (A) or (B), shown on the audio system can vary depending on the Bluetooth® version of the device.

### **Fast Forward/Rewind buttons:**

Fast Forward, Fast Reverse:

When the  /  button is pushed continuously, the track will be played at high speed. When the button is released, the track will be played at normal playing speed.



Track up/down:

By pushing the  /  button once, the track will be skipped forward to the next track or backward to the beginning of the current played track. Push the  /  button more than once to skip through the tracks.

### **DISP button:**

If the song contains music information tags (ID3-tags), the title of the played song will be displayed. If tags are not provided, the display will not show any messages.

When the  button is pushed repeatedly, further information about the song can be displayed along with the song title.

By pushing and holding the  button the display will show a detailed overview which after a few seconds will return to the main display. Push the  button briefly to return to the main display immediately.

### Radio Broadcast data system (RBDS)

The RBDS is a system through which encoded digital information is transmitted by FM radio stations in addition to the normal FM radio broadcasting. The RBDS provides information services such as station name, traffic information, and news.

### **NOTE:**

**In some countries or regions, some of these services may not be available.**

### **Alternative Frequency (AF) mode:**

The AF mode operates in the FM (radio) mode.

- The AF mode operates both in the FM (radio) and CD mode (if FM was previously selected in the radio mode).
- The AF function compares signal strengths and selects the station with the optimum reception conditions for the currently tuned-in station.

### RBDS functions

#### **Programme Service (PS) function (station name display function):**

When an RBDS station is tuned in with seek or manual tuning, the RBDS data is received and the PS name is displayed.

## LW-MW-FM RADIO WITH COMPACT DISC (CD) PLAYER

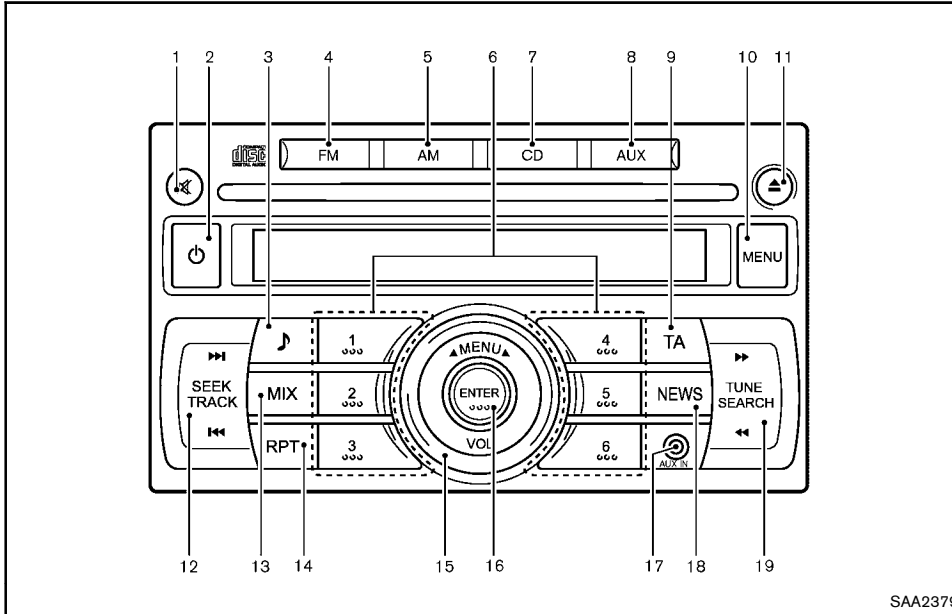

- 17. AUX IN (auxiliary input) jack
- 18. NEWS button
- 19. TUNE/SEARCH button

- |                            |                                     |
|----------------------------|-------------------------------------|
| 1. MUTE button             | 9. TA (Traffic Announcement) button |
| 2. POWER ON/OFF button     | 10. MENU button                     |
| 3. Sound preference button | 11. CD EJECT button                 |
| 4. FM band select button   | 12. SEEK/TRACK button               |
| 5. AM band select button   | 13. MIX (Mix play) button           |
| 6. Radio memory buttons    | 14. RPT (Repeat) button             |
| 7. CD button               | 15. VOLUME control/MENU select dial |
| 8. AUX button              | 16. ENTER button                    |

## Anti-theft system (if equipped)

This unit can only be activated when the ignition switch for NATS is in the "ACC" or "ON" position.

Each radio is uniquely matched to the vehicle's immobilizer and therefore cannot be transferred to any other vehicle.

## Audio main operation

The audio system operates when the ignition switch is in the "ACC" or "ON" position.

### POWER ON/OFF button:

To turn on the audio system, push the POWER ON/OFF button.

- The system will turn on in the mode, (radio or CD) which was used immediately before the system was last turned off.
- If there is no CD loaded, the radio will be turned on.

To turn off the audio system, push the POWER ON/OFF button.

### Volume control:

To control the volume, turn the VOLUME control dial.

Turn the VOLUME control dial clockwise to increase the audio volume.

Turn the VOLUME control dial counterclockwise to decrease the audio volume.



### Sound preference button:

To enter the audio mode (radio or CD), push the  button.

To change the audio settings (BASS, TREBLE, FADE, BALANCE, EQ), push the  button or ENTER button to select the mode.

BASS → TREBLE → BALANCE → FADE → EQ → BASS

To adjust each audio setting, turn the MENU/VOL control dial clockwise or counterclockwise.

BASS: (-) to decrease / (+) to increase

TREBLE: (-) to decrease / (+) to increase

BALANCE: (R) to adjust to the right / (L) to adjust to the left

FADE: (F) to adjust to the front / (R) to adjust to the rear

EQ (Equalizer): Use this control to change the preset sound mode for CD play.

Turn the MENU/VOL dial clockwise or counterclockwise. The mode will change as follows:

OFF ENHANCE OFF

If the audio settings mode is unchanged for approximately 5 seconds, the audio settings mode will automatically return to the normal mode.

### Clock display:

#### Turning on/off the clock display

To turn on or off the clock display, perform the following operations.

1. Push the MENU button while the audio system is on.
2. Turn the VOLUME control dial until "CLOCK" appears on the display.
3. Push the ENTER button. ("CLOCK OFF" or "CLOCK ON" is displayed.)
4. To turn on the clock display, turn the VOLUME control dial till "CLOCK ON" is displayed. To turn off the clock display, turn the VOLUME control dial till "CLOCK OFF" is displayed, and push ENTER.

## Clock adjustment

To adjust the time of the clock, perform the following operations.

1. Push the ENTER button while "CLOCK ON" is displayed.
2. The hour display will flash.
3. Turn the VOLUME control dial to adjust the hour.
4. Push the ENTER button. The minute display will flash.
5. Turn the VOLUME control dial to adjust the minute.
6. Push the ENTER button to complete the clock adjustment.



### Mute button:

Push the MUTE button to mute the audio system. MUTE appears on the display. To unmute, use any one of the following options:

- Push the MUTE button again.
- Turn the VOLUME control dial.
- Push the CD, FM or AM button.
- Push the AUX button.



### AUX button:

The AUX IN jack is located on the audio unit. The AUX IN audio input jack accepts any standard analog audio input such as from a portable cassette tape player, CD player, MP3 player or laptop computer.

Push the AUX button to play a compatible device when it is plugged into the AUX IN jack.

NISSAN strongly recommends using a stereo mini plug cable when connecting your music device to the audio system. Music may not play properly when a

monaural cable is used.

## CD player operation

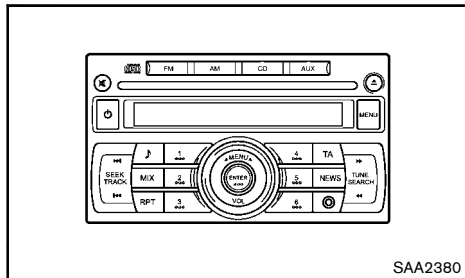

The audio system operates when the ignition switch is in the "ACC" or "ON" position.

### Loading:

Insert a CD into the slot with the label side facing up. The CD will be guided automatically into the slot and will start playing. If the radio is already playing, it will automatically turn off, and the CD will start playing.



### CAUTION:

**Do not force the CD into the slot. This could damage the player.**

After loading the CD, the number of tracks and the playtime will appear on the display.

### CD CD button:

When the **CD** button is pushed while the audio system is off and a CD is loaded, the audio system will turn on and a CD will start playing automatically. If the radio is already playing, it will automatically turn off and the CD will start playing.

### **FF (Fast Forward), REW (Rewind) button:**

Push and hold the FF or REW button while a CD is being played to fast-forward or rewind through the track. When the button is released, the CD will return to the normal play speed.

### **TRACK UP/ DOWN button:**

Push the track up button while a CD is being played to skip forward to the next track. The CD will advance the number of times the button is pushed. When the last track of the CD is skipped, the first track will be played.

Push the track down button while a CD is being played to start the present track again from the beginning. Push the track down button several times to skip back to the previous track. The CD will skip tracks backward the number of times the button is pushed. When the first track of the CD is skipped, the last track will be played.

### **RPT** Repeat button:

Push the **RPT** button repeatedly to change the play mode as follows:

RPT (REPEAT) TRACK → RPT (REPEAT) ALL → RPT (REPEAT) TRACK

RPT TRACK:

The selected track will be played repeatedly.

RPT ALL:

All the tracks on the CD will be played in sequential order.

### **MIX** MIX button:

Push the **MIX** button repeatedly to change the play mode as follows:

MIX DISC → RPT (REPEAT) ALL → MIX DISC

MIX DISC:

All the tracks on the CD will be played in a random order.

RPT ALL:

All the tracks on the CD will be played in sequential order.

### **CD EJECT button:**

When the  button is pushed while a CD is loaded, the CD will be ejected.

When the  button is pushed twice, the CD will be ejected further, and the CD can be removed easily.

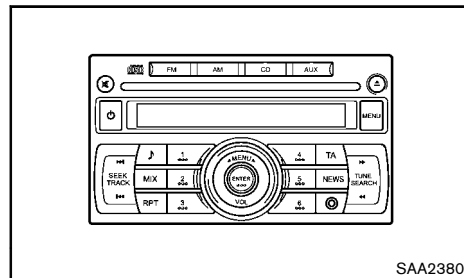

If a CD is ejected by pushing the  button, and it is not taken out from the loading slot, the CD will automatically be reloaded to the slot to protect the CD.

## LW-MW-FM radio operation



The audio system operates when the ignition switch is in the "ACC" or "ON" position.

### **FM-AM button:**



When the  button is pushed while the audio system is off, the audio system and the radio will turn on. When the  button is pushed while the CD player is already operating, it will automatically turn off and the radio will turn on.

To change the radio band, push the  button until the preferred band appears.

- For FM  
FM 1 → FM 2 → FM T
- For AM  
MW → LW → MW



During FM reception, when the  button is pushed for longer than 1.5 seconds, stations are searched for and the 6 stations of the FM T band. The sound is muted until the auto store operation is completed, upon which preset channel 1 is automatically tuned in.

### **TUNE button:**

When adjusting the broadcasting station frequency manually, push the  or  button until the preferred frequency is obtained.

The frequency changes in steps of 100 kHz on the FM band, 9 kHz on the MW band, and 3 kHz on the LW band.







### **SEEK button:**

When adjusting the broadcasting station frequency automatically, push the  or  button. When the system detects a broadcasting station, it will stop at that station.

### **Radio memory buttons:**

The audio system can store up to 18 FM station frequencies (six in each of FM 1, FM 2 and FM T), 6 MW and 6 LW station frequencies.

To store the station frequency manually:

1. Tune to the preferred broadcasting station frequency by using the   or   button.
2. Push and hold a radio memory button  -  until a beep sounds. (The radio mutes when the memory button is pushed.)
3. The channel indicator will be displayed and the radio mute will be cancelled, indicating that the memory is stored properly.
4. Perform steps 1 - 3 for all other memory buttons.

If the battery cable is disconnected, or if the audio fuse blows, the radio memory will be erased. If this occurs, reset the desired stations.

### Radio data system (RDS)

#### Alternative Frequency (AF):

- The AF function operates in the FM (radio) and CD modes.
- When the AF mode is set to "ON" in the user setup menu mode, the AF indicator illuminates.

For activation or deactivation, use the MENU button. (Details are explained later in this section.)

- **Automatic switching function**

This function compares the strengths of the signals of all the stations on the AF list and selects the station with the optimum reception conditions.

- **Program Information (PI) search**

Program Information (PI) search begins automati-

cally if no suitable station is found with the above automatic switching function. The PI search function checks each RDS station with the same PI code. During this time the sound is muted and "PI SEARCH" is displayed. The PI search operation stops when a suitable station is found. If no station is found once all the frequencies have been searched, the radio returns to the previous frequency.

- **Enhanced Other Network (EON) data update (This function also operates when the AF mode is off.)**

When EON data is being received, this enables automatic retuning of other preset stations on the same network. Also, network linked services can be used. The EON indicator turns on during reception of RDS EON stations in the FM mode.

#### RDS functions:

- **Programme Service (PS) function (station name display function)**

When an RDS station is tuned in with seek or manual tuning, RDS data is received and the Program Service (PS) name is displayed.

- **Emergency broadcast interrupt function (ALARM INTERRUPTION — EBU SPEC FOR INFO)**

When the radio receives PTY code 31 (an emergency broadcast code), the sound is interrupted, the emergency broadcast is heard, and "PTY31 ALARM" is displayed. The volume level at this time is the same as that for traffic announcements. Once the emergency broadcast is finished, the unit immediately returns to the previous source.

- **REG (Regional) mode**

Some local radio stations are linked together



according to their region because they only offer limited coverage due to their limited number of transmitters. If the signal from one station becomes weak while you are driving around, RDS mode will switch to another local station in the region with a stronger signal.

When the REG mode is activated in the FM band and the radio receiver is tuned to a local radio station, it will keep receiving this radio station without switching to another local station. For activation or deactivation, use the MENU button. (Details are explained later in this section.)

### Traffic Announcement (TA):

- The TA function operates in the FM and CD modes.
- The TA mode is turned on or off when the TA button is pushed for less than 2 seconds.
- The TA mode operates regardless of whether the AF mode is on or off.
- "TA ON" is displayed when the TA mode is turned on, and the TA indicator turns on. "TA OFF" is displayed when the TA mode is turned off, and the TA indicator turns off.

The following function operates when the TA mode is on:

#### • Traffic announcement interrupt function

When a traffic announcement is received, the announcement is tuned in and the volume increases to the set level.

Once the traffic announcement is finished, the unit returns to the source which was set before the traffic announcement started, and the volume returns to the previous level. For EON stations, the radio is interrupted by another EON station with traffic announcements.

The traffic announcement interrupt mode is

cancelled if the TA button is pushed during a traffic announcement. The TA mode returns to the standby mode and the audio unit returns to the previous source.

### News mode:

When the NEWS button is pushed for longer than 2 seconds in the FM mode, the news function is activated. "NEWS" is displayed for 3 seconds and the NEWS indicator appears on the display.

When the news function is activated, the radio receives a news code from the FM broadcasting news station and the play mode will be interrupted. Once the news broadcast is finished, the unit returns to the previous mode.

In some countries or regions, this service is not available or the signal is too weak to be received.

#### 1. News standby mode

- The news standby mode can be activated in the FM or CD mode.
- A news interruption will be announced and "NEWS" will be displayed when the radio detects the news code from the tuned station or EON stations. The display will then change to the PS name of the interrupting station.
- When pushing the NEWS button for longer than 2 seconds, the news standby mode is turned off and the indicator disappears from the display.

#### 2. News interruption mode

- When the NEWS button is pushed during the news interruption mode, the radio returns to the previous source. However, the news standby mode is maintained.

- When the **CD** button is pushed during the news interruption mode, the radio changes to the CD mode. However, the news standby mode is maintained.

If the radio band is changed to the MW or LW, the news standby mode will be turned off.

### **MENU** MENU button:

To configure Alternative Frequency, Regional and Language settings, perform the following procedure:

1. Push and hold the MENU button for at least 1.5 seconds.
2. Turn the VOLUME control dial clockwise or counterclockwise. The display message will change as follows:

AF REG LANGUAGE AF

- To activate or deactivate the AF and REG mode, briefly push the ENTER button when AF or REG appears on the display and turn the VOLUME control dial clockwise or counterclockwise to switch between the off or on position. After selection, push the ENTER button to confirm the settings.
  - When the AF mode is enabled, the audio unit will automatically re-tune to a stronger frequency if the radio signal becomes weak.
  - When the REG mode is enabled, the audio unit will maintain and maintain the station which is broadcasting local (regional) programmes.
- To change the display language, briefly push the ENTER button when LANGUAGE appears on the display then turn the MENU/VOL dial clockwise or counterclockwise to select the appropriate language setting.

ENGLISH DUTCH FRENCH SPANISH

GERMAN ITALIAN PORTUGUESE  
ENGLISH

After selecting the preferred language, push the ENTER button to exit the menu.

To configure the SPEED volume and BEEP settings, perform the following procedure:

1. Push the MENU button.
2. Turn the Volume control dial clockwise or counterclockwise. The display message will change as follows:

SPEED VOL CLOCK BEEP

- When SPEED VOL appears on the display, briefly push the ENTER button then turn the VOLUME control dial clockwise or counterclockwise to adjust the level of the volume.

Adjusting the setting to 0 (zero) turns off the speed volume feature. Increasing the speed volume setting results in the audio volume increasing more rapidly with vehicle speed. Push the ENTER button again to save the setting.

- When BEEP appears on the display, briefly push the ENTER button and then turn the VOLUME control dial clockwise or counterclockwise to switch the beep sound on or off. Push the ENTER button again to save the setting.

After the preferred levels have been set, push the MENU button to exit the menu or wait at least for 10 seconds without pressing any buttons.

For clock adjustments, see "Audio main operation" (P.4-53).

## LW-MW-FM RADIO WITH COMPACT DISC (CD) CHANGER

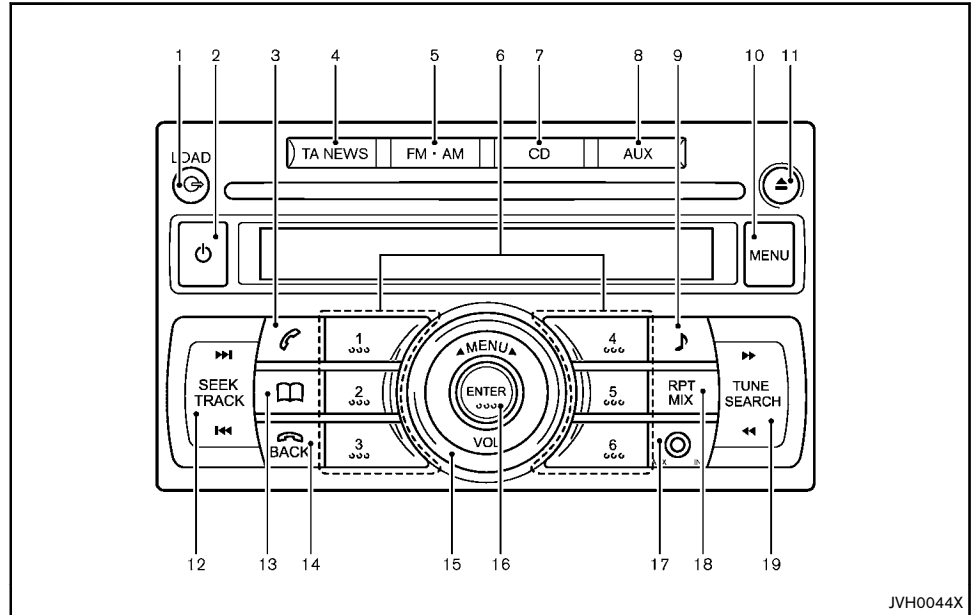

- |  |                                     |
|--|-------------------------------------|
| 1. CD LOAD button                        | 9. Sound preference button          |
| 2. POWER ON/OFF button                   | 10. MENU button                     |
| 3. PHONE SEND button                     | 11. CD EJECT button                 |
| 4. TA (Traffic Announcement)/NEWS button | 12. SEEK/TRACK button               |
| 5. Radio band select button              | 13. PHONE BOOK button               |
| 6. Radio memory/CD select buttons        | 14. PHONE END/BACK button           |
| 7. CD button                             | 15. VOLUME control/MENU select knob |
| 8. AUX button                            | 16. ENTER button                    |

17. AUX IN (auxiliary input) jack
18. RPT (Repeat)/MIX (Mix play) button
19. TUNE/SEARCH button

### Anti-theft system (if equipped)

This unit can only be activated when the ignition switch for NATS is in the "ACC" or "ON" position.

Each radio is uniquely matched to the vehicle's immobilizer and therefore cannot be transferred to any other vehicle.

### Audio main operation

The audio system operates when the ignition switch is in the "ACC" or "ON" position.

#### POWER ON/OFF button:

To turn on the audio system, push the POWER ON/OFF button.

- The system will turn on in the mode, (radio or CD) which was used immediately before the system was last turned off.
- If there is no CD loaded, the radio will be turned on.

To turn off the audio system, push the POWER ON/OFF button.

#### Volume control:

To control the volume, turn the VOLUME control dial.

Turn the VOLUME control dial clockwise to increase the audio volume.

Turn the VOLUME control dial counterclockwise to decrease the audio volume.



#### Sound preference button:

To enter the audio mode (radio or CD), push the  button. When no CD is loaded, the audio system will automatically switch to the radio mode.

To change the audio settings (BASS, TREBLE, FADER, BALANCE, EQ), push the  button or ENTER button to select the mode.

BASS → TREBLE → BALANCE → FADER → EQ → BASS

To adjust each audio setting, turn the MENU/VOL control dial clockwise or counterclockwise.

BASS: (-) to decrease / (+) to increase

TREBLE: (-) to decrease / (+) to increase

BALANCE: (R) to adjust to the right / (L) to adjust to the left

FADE(R): (F) to adjust to the front / (R) to adjust to the rear

EQ (Equalizer): Use this control to change the preset sound mode for CD play.

Turn the MENU/VOL dial clockwise or counterclockwise. The mode will change as follows:

OFF    ENHANCE    OFF

If the audio settings mode is unchanged for approximately 8 seconds, the audio settings mode will automatically return to the normal mode.

#### Clock display:

##### Turning on/off the clock display

To turn on or off the clock display, perform the following operations.

1. Push the MENU button while the audio system is on. ("PHONE SETUP" is displayed.)

2. Turn the VOLUME control knob until "CLOCK" appears on the display.
3. Push the ENTER button. ("CLOCK OFF" or "CLOCK ON" is displayed.)
4. To turn on the clock display, turn the VOLUME control knob till "CLOCK ON" is displayed. To turn off the clock display, turn the VOLUME control knob till "CLOCK OFF" is displayed, and push ENTER.

#### Clock adjustment

To adjust the time of the clock, perform the following operations.

1. Push the ENTER button while "CLOCK ON" is displayed.
2. The hour display will flash.
3. Turn the VOLUME control knob to adjust the hour.
4. Push the ENTER button. The minute display will flash.
5. Turn the VOLUME control knob to adjust the minute.
6. Push the ENTER button to complete the clock adjustment.

#### AUX AUX button:

The AUX IN jack is located on the audio unit. The AUX IN audio input jack accepts any standard analog audio input such as from a portable cassette tape player, CD player, MP3 player or laptop computer.

Push the AUX button to play a compatible device when it is plugged into the AUX IN jack.

NISSAN strongly recommends using a stereo mini plug cable when connecting your music device to the audio system. Music may not play properly when a

monaural cable is used.

## CD changer operation

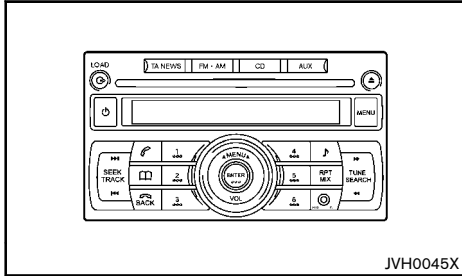

The audio system operates when the ignition switch is in the "ACC" or "ON" position.

### **CD LOAD button:**

When the  button is pushed, the CD loading slot will open and the loading position will be displayed.

Insert the CD into the slot with the label side facing up. The CD will be guided automatically into the slot and will start playing. If the radio is already playing, it will automatically turn off and the CD will start playing.

### **CAUTION:**

- **Do not force the compact disc into the slot. This could damage the player.**
- **Do not use 8 cm (3.1 in) discs.**

After loading the CD, the slot number and CD track will appear on the display.

To load a CD in the CD changer:

1. Push the  button for less than 1.5 seconds.
2. Select the loading slot by pushing the CD select button. If no slot is selected, the CD changer will automatically select an available slot.
3. Insert the CD into the slot.

To load 6 CDs in the CD changer:

1. Push the  button for more than 1.5 seconds.
2. Insert a CD into the slot.
3. When the next loading slot number illuminates on the display, insert the next CD into the slot.

To load 6 CDs in the CD changer:



1. Push the  button for more than 1.5 seconds.
2. Insert the CD into the slot.
3. When the next loading slot number illuminates on the display, insert the next CD into the slot.

The slot number indicator appears on the display when the CDs are loaded in the CD changer and the audio system is turned on.

### **CD CD PLAY button:**



When the  button is pushed while the audio system is off and CDs are loaded, the audio system will turn on and the CD will start to play automatically. If the radio is already operating, it will automatically turn off and the CD will start playing.

### **FF (Fast Forward), REW (Rewind) button:**

Push the  (fast forward) or  (rewind) button while a CD is being played to fast-forward or rewind through the track. When the button is released, the CD will return to normal play speed.

### **TRACK UP/** **DOWN button:**

Push the  button while a CD is being played to skip forward to the next track. The CD will skip tracks forward the number of times the button is pushed. When the last track of the CD is skipped, the first track will be played.

Push the  button while a CD is being played to start the present track again from the beginning. Push the  button several times to skip back to the previous track. The CD will skip tracks backward the number of times the button is pushed. When the first track of the CD is skipped, the last track will be played.

### **CD select buttons:**

To change to another CD loaded in the CD changer, push the corresponding CD select button. When a CD is selected, the selected CD will be automatically played from the first track.

### **RPT (Repeat)-MIX button:**

Push the  button repeatedly to change the play mode as follows:

RPT (REPEAT) TRACK → RPT (REPEAT) DISC → MIX DISC → MIX ALL → RPT (REPEAT) ALL → RPT (REPEAT) TRACK

RPT TRACK:

The CD changer plays the current track continuously.

RPT DISC:

The CD changer repeats the disc currently being playing.

MIX ALL:

All the tracks on all of the CDs will be played in a random order.

#### MIX DISC:

The CD changer plays all the tracks from one disc once in a random order.

#### RPT ALL:

All the tracks of all the CDs will be played continuously in sequential order.

#### **CD EJECT button:**

When the  button is pushed for less than 1.5 seconds while CDs are loaded, the previously played CD will be ejected.

When the  button is pushed for less than 1.5 seconds while a CD is being played, the CD being played will be ejected, and the next CD will be played.

When the  button is pushed for more than 1.5 seconds while CDs are loaded, all of the CDs in the CD changer will be ejected.

If a CD is ejected by pushing the  button, and it is not taken out from the loading slot within 15 seconds, the CD will automatically be reloaded into the slot to protect the CD.

If an error message appears on the display, push the  button.

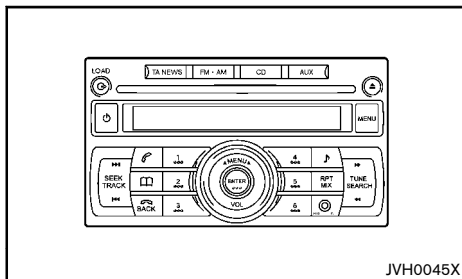

When the ignition switch is in the "OFF" or "LOCK" position, it is possible to eject all the CDs. However, the audio unit will not be activated.

## LW-MW-FM radio operation



The audio system operates when the ignition switch is in the "ACC" or "ON" position.

#### **FM-AM button:**



When the  button is pushed while the audio system is off, the audio system and the radio will turn on. When the  button is pushed while the CD player is already operating, it will automatically turn off and the radio will turn on.

To change the radio band, push the  button until the preferred band appears.

FM 1 → FM 2 → FM T → MW → LW



During FM reception, when the  button is pushed for longer than 1.5 seconds, stations are searched for and the 6 stations of the FM T band. The sound is muted until the auto store operation is completed, upon which preset channel 1 is automatically tuned in.

#### **TUNE button:**

When adjusting the broadcasting station frequency manually, push the   button until the preferred frequency is obtained.

The frequency changes in steps of 100 kHz on the FM band, 9 kHz on the MW band, and 3 kHz on the LW band.







#### **SEEK button:**

When adjusting the broadcasting station frequency automatically, push the   button. When the system detects a broadcasting station, it will stop at that station.

#### **Radio memory buttons:**

The audio system can store up to 18 FM station frequencies (six in each of FM 1, FM 2 and FM T), 6 MW and 6 LW station frequencies.

To store the station frequency manually:

1. Tune to the preferred broadcasting station frequency by using the   or   button.
2. Push and hold a radio memory button  -  until a beep sounds. (The radio mutes when the memory button is pushed.)
3. The channel indicator will be displayed and the radio mute will be cancelled, indicating that the memory is stored properly.
4. Perform steps 1 - 3 for all other memory buttons.

If the battery cable is disconnected, or if the audio fuse blows, the radio memory will be erased. If this occurs, reset the desired stations.

## Radio data system (RDS)

### Alternative Frequency (AF):

- The AF function operates in the FM (radio) and CD modes.
- When the AF mode is set to “ON” in the user setup menu mode, the AF indicator illuminates.

For activation or deactivation, use the MENU button. (Details are explained later in this section.)

- **Automatic switching function**

This function compares the strengths of the signals of all the stations on the AF list and selects the station with the optimum reception conditions.

- **Program Information (PI) search**

Program Information (PI) search begins automatically if no suitable station is found with the above automatic switching function. The PI search function checks each RDS station with the same PI code. During this time the sound is muted and “PI SEARCH” is displayed. The PI search operation stops when a suitable station is found. If no station is found once all the frequencies have been searched, the radio returns to the previous frequency.

- **Enhanced Other Network (EON) data update (This function also operates when the AF mode is off.)**

When EON data is being received, this enables automatic retuning of other preset stations on the same network. Also, network linked services can be used. The EON indicator turns on during the reception of RDS EON stations in the FM mode.

### RDS functions:

- **Programme Service (PS) function (station name display function)**

When an RDS station is tuned in with seek or manual tuning, the RDS data is received and the Programme Service (PS) name is displayed.

- **Emergency broadcast interrupt function (ALARM INTERRUPTION — EBU SPEC FOR INFO)**

When the radio receives PTY code 31 (an emergency broadcast code), the sound is interrupted, the emergency broadcast is heard, and “PTY31 ALARM” is displayed. The volume level at this time is the same as that for traffic announcements. Once the emergency broadcast is finished, the unit immediately returns to the previous source.

- **REG (Regional) mode**

Some local radio stations are linked together according to their region because they only offer limited coverage due to their limited number of transmitters. If the signal from one station becomes weak while you are driving around, RDS mode will switch to another local station in the region with a stronger signal.

When the REG mode is activated in the FM band and the radio receiver is tuned to a local radio station, it will keep receiving this radio station without switching to another local station. For activation or deactivation, use the MENU button. (Details are explained later in this section.)

### Traffic Announcement (TA):

- The TA function operates in the FM and CD modes.
- The TA mode is turned on or off when the TA/NEWS button is pushed for less than 2 seconds.
- The TA mode operates regardless of whether the AF mode is on or off.
- “TA ON” is displayed when the TA mode is turned on, and the TA indicator turns on. “TA OFF” is displayed when the TA mode is turned off, and the TA indicator turns off.

The following function operates when the TA mode is on:

- **Traffic announcement interrupt function**

When a traffic announcement is received, the announcement is tuned in and the volume increases to the set level.

Once the traffic announcement is finished, the unit returns to the source which was set before the traffic announcement started, and the volume returns to the previous level. For EON stations, the radio is interrupted by another EON station with traffic announcements.

The traffic announcement interrupt mode is cancelled if the TA/NEWS button is pushed during a traffic announcement. The TA mode returns to the standby mode and the audio unit returns to the previous source.

### News mode:

When the NEWS button or the TA/NEWS button is pushed for longer than 2 seconds in the FM mode, the news function is activated. “NEWS” is displayed for 3 seconds and the NEWS indicator appears on the display.

When the news function is activated, the radio

receives a news code from the FM broadcasting news station and the play mode will be interrupted. Once the news broadcast is finished, the unit returns to the previous mode.

In some countries or regions, this service is not available or the signal is too weak to be received.

#### 1. News standby mode

- The news standby mode can be activated in the FM or CD mode.
- A news interruption will be announced and "NEWS" will be displayed when the radio detects the news code from the tuned station or EON stations. The display will then change to the PS name of the interrupting station.
- When pushing the TA/NEWS button for longer than 2 seconds, the news standby mode is turned off and the indicator disappears from the display.

#### 2. News interruption mode

- When the TA/NEWS button is pushed during the news interruption mode, the radio returns to the previous source. However, the news standby mode is maintained.
- When the **CD** button is pushed during the news interruption mode, the radio changes to the CD mode. However, the news standby mode is maintained.

If the radio band is changed to the MW or LW, the news standby mode will be turned off.

#### **MENU** MENU button:

To configure Alternative Frequency, Regional and Language settings, perform the following procedure:

1. Push and hold the MENU button for at least 1.5 seconds.
2. Turn the MENU/VOL dial clockwise or counterclockwise. The display message will change as follows:

AF REG LANGUAGE AF

- To activate or deactivate the AF and REG mode, briefly push the ENTER button when AF or REG appears on the display and turn the MENU/VOL dial clockwise or counterclockwise to switch between the off or on position. After selection, push the ENTER button to confirm the settings.
  - When the AF mode is enabled, the audio unit will automatically re-tune to a stronger frequency if the radio signal becomes weak.
  - When the REG mode is enabled, the audio unit will maintain and maintain the station which is broadcasting local (regional) programmes.
- To change the display language, briefly push the ENTER button when LANGUAGE appears on the display then turn the MENU/VOL dial clockwise or counterclockwise to select the appropriate language setting.

ENGLISH DUTCH FRENCH SPANISH  
GERMAN ITALIAN PORTUGUESE  
ENGLISH

After selecting the preferred language, push the ENTER button to exit the menu.

To configure the SPEED volume and BEEP settings, perform the following procedure:

1. Push the MENU button.
2. Turn the MENU/VOL dial clockwise or counterclockwise. The display message will change as follows:

PHONE SETUP SPEED VOL CLOCK

#### BEEP PHONE SETUP

For phone operation, see "Bluetooth® Hands-Free Phone System (if equipped for model without navigation system)" (P.4-64).

- When SPEED VOL appears on the display, briefly push on the ENTER button then turn the MENU/VOL dial clockwise or counterclockwise to adjust the level of the volume.

Adjusting the setting to 0 (zero) turns off the speed volume feature. Increasing the speed volume setting results in the audio volume increasing more rapidly with vehicle speed. Push the ENTER button again to save the setting.
- When BEEP appears on the display, briefly push the ENTER button and then turn the MENU/VOL dial clockwise or counterclockwise to switch the beep sound on or off. Push the ENTER button again to save the setting.

After the preferred levels have been set, push the MENU button to exit the menu or wait at least for 10 seconds without pressing any buttons.

#### FM-AM RADIO WITH COMPACT DISC (CD) PLAYER AND NAVIGATION (if equipped)

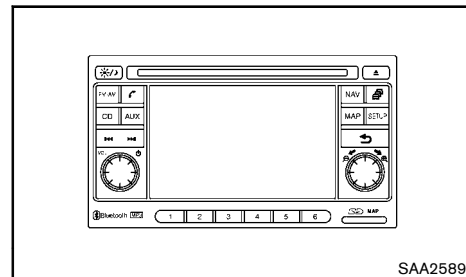

For details, see the separately provided NISSAN

Connect Owner's Manual.

## STEERING WHEEL SWITCH FOR AUDIO CONTROL (if equipped)

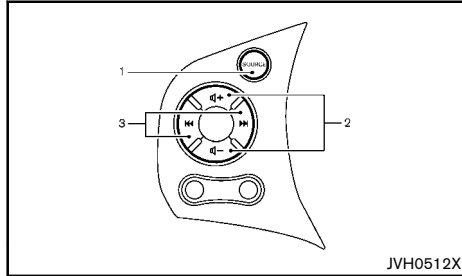

**Type A**

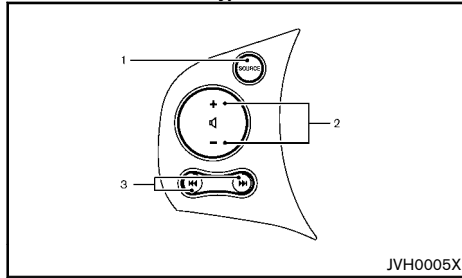

**Type B**

1. SOURCE select switch
2. VOLUME control switch
3. Tuning switch

The audio system can be operated using the controls on the steering wheel.

### SOURCE select switch

Push the source select switch to change the mode to available audio source.

### VOLUME control switch

Push up or down the VOLUME control switch to increase or decrease the volume.

### Tuning switch

#### Memory change (radio):

Push the tuning switch for less than 1.5 seconds to change the next or previous radio preset.

#### SEEK tuning (radio):

Push the tuning switch for more than 1.5 seconds to seek the next or previous radio station.

#### APS (Automatic Program Search) FF, APS REW (CD, USB, iPod®):

Push the tuning switch for less than 1.5 seconds to return to the beginning of the present program or skip to the next program. Push several times to skip back or skip through programs.

This system searches for the blank intervals between selections. If there is a blank interval within one program or there is no interval between programs, the system may not stop in the desired or expected location.

Push the tuning switch for more than 1.5 seconds to fast forward or rewind through the track.

## CD/USB MEMORY CARE AND CLEANING

### CD

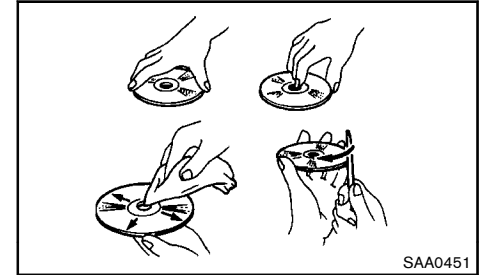

- Handle a disc by its edges. Never touch the surface of the disc. Do not bend the disc.
- Always place the discs in the storage case when they are not being used.
- To clean a disc, wipe the surface from the center to the outer edge using a clean, soft cloth. Do not wipe the disc using a circular motion. Do not use a conventional record cleaner or alcohol intended for industrial use.
- A new disc may be rough on the inner and outer edges. Remove the rough edges by rubbing the inner and outer edges with the side of a pen or pencil as illustrated.

### USB memory device (if equipped)

- Do not touch the terminal portion of the USB memory device.
- Do not place heavy objects on the USB memory device.
- Do not store the USB memory device in highly humid locations.



## CAR PHONE OR CB RADIO

- Do not expose the USB memory device to direct sunlight.
- Do not spill any liquids on the USB memory device.

Refer to the USB memory device Owner's Manual for the details.

When installing a CB, ham radio or a car phone in your vehicle, be sure to observe the following cautions, otherwise the new equipment may adversely affect the Engine Control System and other electronic parts.



### CAUTION:

- **Keep the antenna as far away as possible from the Electronic Control Module.**
- **Keep the antenna wire at least 20 cm (8 in) away from the Engine Control harnesses. Do not route the antenna wire next to any harnesses.**
- **Adjust the antenna standing wave ratio as recommended by the manufacturer.**
- **Connect the ground wire from the radio chassis to the body.**
- **For details, consult a NISSAN dealer.**

### NOTE:

For Europe:

For further information, visit the NISSAN web site: [www.nissan-europe.com](http://www.nissan-europe.com). Select your country from the list and go to the "SERVICES" menu. If not available on the web site, contact a NISSAN dealer.

## Bluetooth® HANDS-FREE PHONE SYSTEM (if equipped for model without navigation system)



### WARNING:

- **Use a phone after stopping your vehicle in a safe location. If you have to use a phone while driving, exercise extreme caution at all times so full attention may be given to vehicle operation.**
- **If a conversation in a moving vehicle requires you to take notes, pull off the road to a safe location and stop your vehicle before doing so.**



### CAUTION:

To avoid draining the vehicle battery, use a phone after starting the engine.

### NOTE:

Wireless LAN (Wi-Fi) and the Bluetooth® functions share the same frequency band (2.4 GHz). Using the Bluetooth® and the wireless LAN functions at the same time may slow down or disconnect the communication and cause undesired noise. It is recommended that you turn off the wireless LAN (Wi-Fi) when using the Bluetooth® functions.

For model with navigation system, see the separately provided NISSAN Connect Owner's Manual.

Your NISSAN is equipped with the Bluetooth® Hands-Free Phone System. If you are an owner of a Bluetooth® enabled cellular phone, you can set up the wireless connection between your cellular phone and the in-vehicle phone module. With Bluetooth® wireless technology, you can make or receive a hands-free telephone call with your cellular phone in the vehicle.

Once your cellular phone is paired to the in-vehicle phone module, no other phone connecting procedure is required. Your phone is automatically connected with the in-vehicle phone module when the ignition switch is placed in the "ON" position with the paired cellular phone turned on and carried in the vehicle.

You can register up to 5 different Bluetooth® cellular phones to the in-vehicle phone module. However, you can talk on only one cellular phone at a time.

Before using the Bluetooth® Hands-Free Phone System, refer to the following notes.

- Set up the wireless connection between a cellular phone and the in-vehicle phone module before using the system.
- Some Bluetooth® enabled cellular phones may not be recognized by the in-vehicle phone module.
- You will not be able to use a Hands-free phone under the following conditions.
  - Your vehicle is outside of the telephone service area.
  - Your vehicle is in an area where it is difficult to receive radio waves; such as in a tunnel, in an underground parking garage, near a tall building or in a mountainous area.
  - Your cellular phone is locked to prevent it from being dialed.

When the radio wave condition is not ideal or ambient sound is too loud, it may be difficult for the other party to hear your voice during a call. Please close the windows if possible.

Do not place the cellular phone in an area surrounded by metal or far away from the in-vehicle phone module to prevent tone quality degradation and wireless connection disruption.

While a cellular phone is connected through the Bluetooth® wireless connection, the battery power of

the cellular phone may discharge quicker than usual. The Bluetooth® Hands-Free Phone System cannot charge cellular phones.

Refer to the cellular phone Owner's Manual regarding the telephone charges, cellular phone antenna and body, etc.

This wireless hands-free system is based on Bluetooth® technology.

- Frequency: 2402 MHz - 2480 MHz
- Output Power: 4.14 dBm EIRP
- Modulation: FHSS GFSK 8DPSK, p/4DQPSK
- Number of Channel: 79
- This wireless equipment cannot be used for any services related to safety due to the possibility of radio interference

## REGULATORY INFORMATION



Bluetooth® is a trademark owned by Bluetooth SIG, Inc. and licensed to Clarion Co., Ltd. and Daewoo IS Corp.

## CE STATEMENT

Hereby "Clarion Co., Ltd." and Daewoo IS Corp. declares that this Bluetooth car kit AV System is in compliance with the essential requirements and other relevant provisions of Directive 1999/5/EC.



## HANDS-FREE PHONE SYSTEM (Type A)

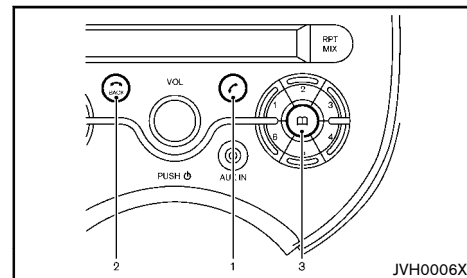

For Europe

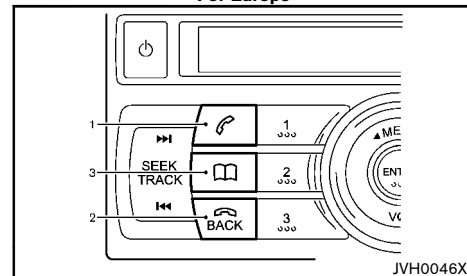

For South Africa

1. PHONE SEND button
2. PHONE END/BACK button
3. PHONE BOOK button

The following options can be selected:

- Paired list
- Pair phone
- Delete phone
- Bluetooth® connection
- Delete phone book

- My number

### Pairing procedure

If you wish to make a Bluetooth® connection for the first time between your cellular phone and the Bluetooth® system of the audio unit, perform the following pairing procedure.

1. Place the ignition switch in the “ACC” position.
2. Switch on the audio system and your cellular phone.

For the vehicle:

1. Briefly push the MENU button.
2. Push the ENTER button.
3. Turn the MENU/VOL dial and select PAIR PHONE then push the ENTER button.
4. The display shows READY TO PAIR then PASS-CODE=1234.

On the cellular phone:

1. Activate the Bluetooth® connection.
2. Activate the search mode for Bluetooth® equipment. Refer to the owner’s manual of your cellular phone for further details. If the search mode finds the device, it will be shown on your cellular phone display.
3. Select the device name MY CAR.
4. Enter the passcode number 1234 as shown on the display of the audio unit with the keypad on your cellular phone and then push the confirmation button on your cellular phone.

Action	Screen display
Push briefly MENU button	
↓	PHONE SETUP
Push ENTER	
↓	
Turn VOLUME dial	PAIR PHONE
↓	
Push ENTER	READY TO PAIR PASSCODE=1234
↓	
Your cellular phone setup: select MY CAR then enter 1234	
↓	
If successful	PAIRING OK
	CONNECT OK
	Mobile 1 *1
	PAIR PHONE
Push  for the main screen.	

\*1: Mobile name

Once the connection is finalized, the audio unit will automatically register the cellular phone and the audio unit display shows PAIRING OK and CONNECT OK. If it fails to register, the display shows PAIRING FAIL then start the procedure, previously described, again or consult the owner’s manual of your cellular phone.

You can register up to 5 different Bluetooth® cellular phones. However, you can only use one cellular phone at a time. If you have 5 different Bluetooth® cellular phones registered, a new cellular phone can only replace one of the 5 existing paired phones. Use DEL PHONE to delete one of the existing paired phones.

### Paired phone list

The paired phone list shows which phones have been paired or registered with the Bluetooth® system. If the list contains multiple phones then you can select the appropriate phone to connect with the Bluetooth® system.

Action	Screen display	
Briefly push MENU		
↓	PHONE SETUP	
Push ENTER		
↓	PAIRED LIST	
Push ENTER		
↓	Mobile 1	
Turn MENU/ VOL dial	Mobile 2	
↓		
Push ENTER	PLEASE WAIT	
	CONNECT OK	CONNECT FAIL
↓	PAIRED LIST	
Push  for the main screen.		

In the above example procedure, “Mobile 2” will be connected.

## Removing a paired phone

Deletes the connection between the Bluetooth® system and the registered cellular phone.

Action	Screen display
Briefly push MENU	
↓	PHONE SETUP
Push ENTER	
↓	
Turn MENU/VOL dial	
↓	DEL PHONE
Push ENTER	
↓	Mobile 1
Turn MENU/VOL dial	Mobile 2
↓	
Push ENTER	DELETE? <YES>
↓	
Push ENTER *	DELETED
↓	DEL PHONE
Push  for the main screen.	

\*: For the “Mobile 2” connection the screen displays “DISCONNECTED”, followed by “Mobile 2”, then “DELETED”.

In the above example, “Mobile 2” will be deleted while “Mobile 1” remains connected to the system.

## Bluetooth® activation

Activates or deactivates the Bluetooth® function. You will need to activate the Bluetooth® function in order to enable your hands-free phone system (except in the pairing mode when it will be activated automatically).

Action	Screen display
Push MENU	
↓	PHONE SETUP
Push ENTER	
↓	
Turn MENU/VOL dial	BLUETOOTH
↓	
Push ENTER	B'TOOTH <OFF>
↓	
Turn MENU/VOL dial	B'TOOTH <ON>
↓	
Push ENTER	BLUETOOTH
Push  for the main screen.	

## Displaying MY NUMBER

If your cellular phone is equipped with the function, the phone number of the active cellular phone will be displayed on the hands-free phone system.



## Delete phone book list

To delete all the contacts from the phone book, proceed as follows:

Action	Screen display
Briefly push MENU	
↓	PHONE SETUP
Push ENTER	
↓	
Turn MENU/VOL dial	DEL P.BOOK
↓	
Push ENTER	DEL ALL? <NO>
↓	
Turn MENU/VOL dial	DEL ALL? <YES>
↓	
Push ENTER	DELETING
	DELETED
	DEL P.BOOK
Push  for the main screen.	

## Phone book

When the phone book  button is pushed, the following options can be selected by turning the MENU/VOL dial in either direction.



- SEARCH
- Names (contact names)
- Speed dial mode [1Name (contact name)]
- DELETE NAME
- EDIT NAME
- ADD NAME
- Send name using Bluetooth® technology [  ADD NAME]
- Send all the phone book entries in the cellular phone using Bluetooth® technology [  DOWNLOAD]

The phone book can store up to 250 names with numbers and can be selected for calling. To add a contact to the phone book proceed as follows:

Action	Screen display
Push with a long push  button	
↓	ADD NAME
Push ENTER	
↓	ENTER NAME
Turn MENU/VOL dial	ABC
↓	IJK
Focus on "J"	
Push ENTER	
↓	
Turn MENU/VOL dial Focus on "O"	NOP
↓	
Push ENTER	
↓ *1 *3	JO
Turn MENU/VOL dial	OK
↓	
Push ENTER	
↓	ENTER NUMBER
Push ENTER then turn MENU/ VOL dial	1
↓ *2 *3	
Push ENTER	123456789
↓	
Turn MENU/VOL dial	
↓	OK
Push ENTER	SAVED

**NOTE:**

**In the above example the contact name JO and phone number 123456789 will be added.**

- \*1: To insert special characters select the following character options A: Alphabetic characters, 1/2: Numerical characters, Å: Latin characters and @: Symbol characters.
- \*2: Select the number then confirm your selection by pushing the ENTER button, and then proceed likewise for every number.
- \*3: To correct an entry, briefly push the  button then enter the correct details. To delete all characters push the  button for more than 1 second.

**NOTE:**

**You can also store the name and the phone number in one of the six preset buttons on the audio unit for frequently used phone numbers.**

**Transferring an entry to the phone book:**

You can also send a name (contact) from a connected cellular phone to the phone book using Bluetooth® technology.



Action	Screen display
Briefly push  button	
↓	
Turn MENU/VOL dial	⌘ ADD NAME
↓	
Push ENTER	SEND NAME
↓ *1 *2	JOE
Push ENTER	
↓ *3	0123456789
Push ENTER	SAVED YES
↓	

Push ENTER	SAVED
↓	⌘ ADD NAME
Push  for the main screen.	

- \*1: The Bluetooth® icon will blink for 2 minutes.
- \*2: Send the name via the registered cellular phone within the 2 minutes.
- \*3: Phone number is displayed.

**Transferring all phone book entries at the same time:**

If your cellular phone is equipped with the function, you can download all the phone book entries in the cellular phone to the hands-free system at the same time.

Action	Screen display
Briefly push  button	
↓	
Turn MENU/VOL dial	⌘ DOWNLOAD
↓	
Push ENTER	
↓	APPEND?
Turn MENU/VOL dial	OVERWRITE?
↓	
Push ENTER	DOWNLOAD- ING...
	DOWNLOAD OK
	⌘ DOWNLOAD
Push  for the menu screen.	

**NOTE:**

- If you select **APPEND**, downloaded entries will be saved in the available space without deleting previously saved information in the hands-free system. If there is not enough space, the downloaded entries that exceed the space available will not be saved and **MEMORY FULL** appears on the display.
- If you select **OVERWRITE**, the downloaded entries will be saved on top of the previously saved information. (The previously saved information will not be saved.) You can save up to 250 entries. If you attempt to download more than 250 entries, the remaining entries will not be saved and **MEMORY FULL** appears on the display.

**Edit**



You can edit a name or phone number stored in the phone book.

Action	Screen display
Push  button	
↓	
Turn MENU/VOL dial	
↓	EDIT NAME
Push ENTER	
↓*1	
Turn MENU/VOL dial	JOE
↓	
Push ENTER	
↓	JOE OK <@OKA>
Turn MENU/VOL dial	
↓ Focus on "Y"	JOE <XYZ>
Push ENTER	

↓*2*3	JOEY
Push  for more than 1.5 seconds to go to main screen.	

\*1: Alternatively use the SEARCH mode to select the appropriate entry to edit.

- SEARCH appears on the display then push the ENTER button.
- Select the first character of the name then push the ENTER button.
- The name should be displayed. If necessary, turn the MENU/VOL dial to select the correct name.

\*2: When the  button is pushed briefly, the cursor will move one step backwards and the last character will be deleted. To delete all characters push the  button for more than 1 second.

\*3: If necessary, you can edit the telephone number. After editing the name, select OK then push the ENTER button to confirm and edit the number as described for name editing.

**Delete a name:**

To delete a name (contact) from the phone book, proceed as follows:

1. Briefly push the  button.
2. Turn the MENU/VOL dial then select the DELETE NAME.
3. Push the ENTER button.
4. Turn the MENU/VOL dial to the name that needs to be deleted then push the ENTER button.
5. The display will show DELETE? YES. If applicable, turn the MENU/VOL dial to select DELETE? NO.
6. The display will show the message DELETED.

The search mode can also be performed as follows:

1. Briefly push the  button.
2. SEARCH appears on the display then push the ENTER button.
3. Select the first character of the name then push the ENTER button.
4. The display will now show the name(s) beginning with the corresponding character. If necessary, turn the MENU/VOL dial to select the correct name.
5. Push the ENTER button and the display will show DELETE? YES. If applicable, turn the MENU/VOL dial to select DELETE? NO.
6. To confirm the selection, push the ENTER button.

**Speed dial buttons:**

After entering the names and phone numbers, you can assign the six preset buttons to the most frequently dialed phone numbers.

1. Push the  button.
2. Select the name by turning the MENU/VOL dial or using the search name mode.
3. Once found, push the assigned preset button until a confirmation beep is heard. The name and phone number are now stored under that button.

**Hands-free phone control**

The hands-free mode can be operated using the telephone button controls on the audio unit or on the steering wheel.

### Initiating a call:

A call can be initiated using one of the following methods:



- redial
- phone book
- voice tag
- speed dial (preset buttons)

#### NOTE:

**During the active call you can adjust the microphone volume by briefly pushing the MENU button then adjusting the volume by turning the MENU/VOL dial within the value range of -2 to +2. To confirm the entry, briefly push the ENTER or  button or wait for 10 seconds to return to the active call main screen.**



#### Redial:

Use the redial mode to call the last number that was dialed.

1. Briefly push the  button.
2. Select REDIAL.
3. Push the ENTER or the  button to redial the last number.

#### Make a call from the phone book:

In order to dial a contact from the phone book, proceed as follows:

1. Push the  button.
2. Turn the MENU/VOL dial and select the corresponding name.
3. Push the ENTER or the  button in order to dial the number.

Alternatively, you can use the search mode as follows:

1. Briefly push the  button.
2. SEARCH appears on the display then push the ENTER button.
3. Select the first character of the name then the ENTER button.
4. The name should be displayed.

If necessary, turn the MENU/VOL dial to select the correct name.

5. Push the ENTER or  button in order to dial the number.

#### Calling via voice tag:

If your cellular phone supports voice recognition, it is possible to make a call via the voice tag instead of manual selection, provided the name and number of your contact has been previously marked and stored in the phone book of your cellular phone. For details, see the cellular phone manufacturer's owner's manual.

In order to dial via a voice tag, proceed as follows:

1. Push the  button for more than 2 seconds.
2. The display shows SPEAK NOW.
3. Give your voice tag.

Say the voice tag clearly and normally in the direction of the microphone (located in the ceiling in front of the rearview mirror).

4. If the voice tag is correct, the phone system will dial the corresponding number.

#### Make a call via speed dial:

To make a speed dial call using one of the assigned preset buttons, proceed as follows:

1. Briefly push the  button.



2. Push the corresponding preset button (1-6).

Alternatively, you can select the corresponding preset number by turning the MENU/VOL dial instead of pushing the preset button.

3. To confirm the selection, push the  button to make the call.

#### Receiving a call

When receiving an incoming call, the display will show the caller identification (or NO NUMBER) and you can:

- answer the call by briefly pushing the  button.
- end the call after the conversation by pushing the  button.
- reject the call by pushing the  button.

#### Steering wheel switch for Bluetooth®

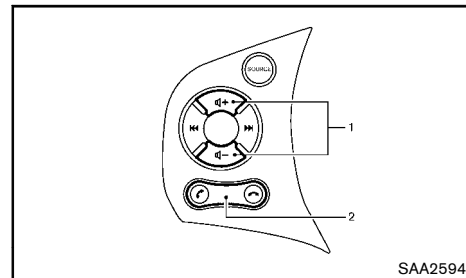



The hands-free mode can be operated using the controls on the steering wheel.







#### Volume control switch:

The volume control switch allows you to adjust the volume of the speakers by pushing the + or - buttons

- ①.

### Telephone button:

The  and  buttons ② allows you to:

- accept an incoming call by pushing the  button.
- reject an incoming call by pushing the  button during the incoming call.
- end an active call by pushing the  button once.
- redial the last outgoing call by pushing the  button twice.
- make a speed dial call by pushing the  button then push the scrolling (up/down) switch to scroll through the preset buttons for the stored phone numbers. To confirm the selection push the  button to make the call.
- make a call via voice dialling by pushing the  button for more than 2 seconds then say the voice tag clearly.

### HANDS-FREE PHONE SYSTEM (Type B)

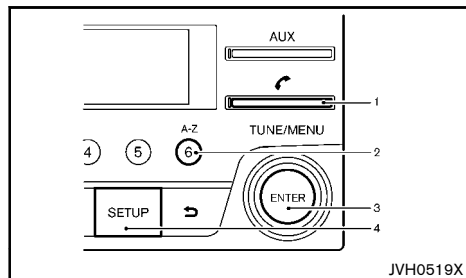

### Buttons:

1. Phone button
2. A-Z button
3. ENTER dial

### 4. SETUP button

#### Microphone:

The microphone is located near the map light.



#### WARNING:

**While driving, using the cellular phone is extremely dangerous because it significantly impairs your concentration and diminishes your reaction capabilities to sudden changes on the road, and it may lead to a fatal accident. This applies to all phone call situations such as when receiving an incoming call, during a phone conversation, when calling through the phone book search, etc.**



#### CAUTION:

**Certain country or region jurisdictions prohibit the use of the cellular phone in the car without hands-free support.**

This chapter provides information about the NISSAN hands-free phone system using a Bluetooth® connection.

Bluetooth® is a wireless radio communication standard. This system offers a hands-free feature for your cellular phone to enhance driving comfort.

In order to use your cellular phone with the Bluetooth® of the audio system, the cellular phone must first be set up. Once it has been set up, the hands-free mode is automatically activated on the registered cellular phone (via Bluetooth®) when it comes into range.

A notification message appears on the audio display when the phone is connected, when an incoming call is being received, as well as when a call is initiated.

When a call is active, the audio system, microphone

(located in the ceiling in front of the rearview mirror), and steering wheel switches enable hands-free communication.

If the audio system is in use at the time, the radio, CD, or AUX source mode will be muted and will stay muted until the active call has ended.



The Bluetooth® system may not be able to connect with your cellular phone for the following reasons:

- The cellular phone is too far away from the vehicle.
- The Bluetooth® mode on the cellular phone has not been activated.
- The cellular phone has not been paired with the Bluetooth® system of the audio unit.
- The cellular phone does not support Bluetooth® technology (BT Core v1.2, Hands Free Profile v1.0 and Object Push Profile v1.0).

#### NOTE:

**For details, see the cellular phone's owner's manual.**

### Hands-free phone setup

To set up the Bluetooth® system to pair with (connect or register) a preferred cellular phone, push the  button, select the Bluetooth® key, and then push the  dial. It is also possible to display the set up menu directly by pushing the  button.

- Pair Device  
Bluetooth® cellular phones can be paired with the system. A maximum of 5 cellular phones can be registered.
- Select Device  
Paired Bluetooth® cellular phones are listed on the display and can be selected for connection.



- Delete Device

A registered Bluetooth® cellular phone can be deleted.

- On/Off

If this setting is turned off, the connection between the Bluetooth® devices and the in-vehicle Bluetooth® module will be cancelled.

When successfully paired, a notification message will be displayed. During the connection the following status icons will be displayed (top left of display): Signal strength (📶), Battery status (🔋) and Bluetooth® (📶).

\*: If the low battery message comes on, the Bluetooth® device must be recharged soon.

### Making a call

The hands-free mode can be operated using the  button on the audio system, or on the steering wheel.

#### Initiating a call:

A call can be initiated using one of the following methods:

- Redial
- Phone book
- Manual dialling
- Missed calls
- Dialed calls
- Received calls

#### Redial:

To redial or call the last number dialled, push the Phone button for more than 2 seconds.



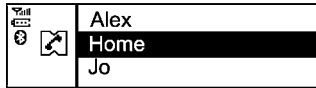
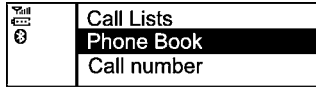

#### Making a call from the phone book:





Once the Bluetooth® connection is made between the registered cellular phone and the audio system, phone book data will be transferred automatically to the audio system. The transfer may take a while before completion.





The phone book data is available only when the phone is connected to the system. The system downloads the latest phone book data each time the phone is connected.

To dial a contact from the phone book proceed as follows:

1. Push the "Phone" button.
2. Turn the  dial to scroll down to Phone Book and then push the  dial.
3. Scroll down through the list, select the appropriate contact name (highlighted), and push the  dial.
4. A screen will show the number to be dialled. If correct, push the  dial again to dial the number.

If there are numbers assigned for the contact's  (home),  (cellular phone) or  (office), scroll to select the appropriate number to dial.

Alternatively, the quick search mode can be used as follows:

1. Push the  button.
2. Turn the  dial for the first alphabetic or numerical letter of the contact name. Once highlighted, push the  dial to select the letter.
3. The display will show the corresponding contact name(s). Where necessary, use the  dial again to scroll further for the appropriate contact name to call.
4. A screen will show the number to be dialled. If correct, push the  dial again to dial the number.

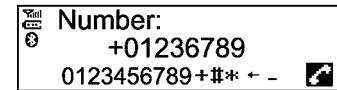

#### Manually dialling a phone number:



#### WARNING:

**Park the vehicle in a safe location, and apply the parking brake before making a call.**

To dial a phone number manually use the audio system display (virtual keyboard pad) as follows:

1. Push the  button, and turn the  dial to highlight "Call Number".
2. Push the  dial to select "Call Number".

- Turn the **ENTER** dial to scroll along, and select each number of the phone number. Once highlighted, push the **ENTER** dial after each number selection.



To delete the last number entered scroll to the “←” (Backspace) symbol, and once highlighted push the **ENTER** dial. The last number will be deleted. Pushing the **ENTER** dial repeatedly will delete each subsequent number.

- After entering the last number, scroll to the “☎” symbol, and push the **ENTER** dial, or push the  button to dial the number.

### Call lists:

A number from the dialled, received, or missed call lists can also be used to make a call.



- Dialled call**  
Use the dialled call mode to make a call which is based on the list of outgoing (dialled) calls.
- Received call**  
Use the received call mode to make a call which is based on the list of received calls.
- Missed call**  
Use the missed call mode to make a call which is based on the list of missed calls.

- Push the  button, and select “Call Lists”.
- Turn the **ENTER** dial to scroll to an item, and push the **ENTER** dial to select it.
- Scroll to the preferred phone number and then push the **ENTER** dial, or push the  button to dial the number.

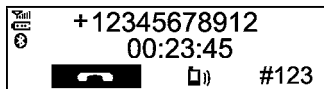
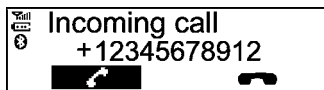
### Receiving a call



When receiving an incoming call, the display will show the caller's phone number (or a notification message that the caller's phone number cannot be shown):

- Answer the call by pushing the  button briefly, or push the **ENTER** dial.
- End the call, after the conversation, by:
  - Pushing the  button briefly again.
  - Pushing the **ENTER** dial when the “☎” symbol is highlighted.

If “☎” is not highlighted, turn the **ENTER** dial to “☎”, and push the **ENTER** dial.
- Reject the call by selecting the “☎” symbol on the screen using the **ENTER** dial and pushing the **ENTER** dial to select it.

### During a call:

During a call, by scrolling and pushing the **ENTER** dial, you can select the following options:

- “#123” — Use this item to enter numbers during a call. For example, if directed by an automated phone system to dial an extension number the system will send the tone associated with the selected number.
- “☎” — Use this item (the transfer handset command) to transfer the call from the audio system to your cellular phone.

To transfer the call back to hands-free via the audio system select “☎”.

### Steering wheel switch for Bluetooth®

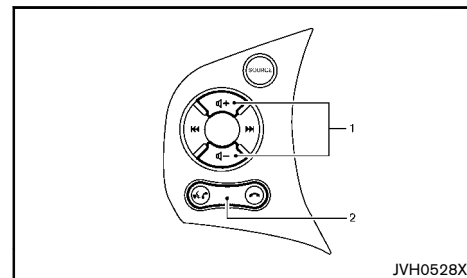



- Volume control switch
- Phone send/end button





The hands-free mode can be operated using the controls on the steering wheel.

### Volume control switch:

The volume control switch allows you to adjust the volume of the speakers by pushing the + or – buttons.

### Phone send/end button:

The  and  buttons can be used as follows.

- Push the  button to accept an incoming call.
- Push the  button to reject an incoming call.
- Push the  button to end an active call.
- Push and hold the  button to redial the last outgoing call.

## **MEMO**

# 5 Starting and driving

Break-in schedule .....	5-3	Driving with Manual Transmission (MT) .....	5-17
Before starting engine .....	5-3	Idling Stop System (for Hong Kong) .....	5-19
Precautions when starting and driving .....	5-3	Operating Idling Stop System .....	5-20
Exhaust gas (carbon monoxide) .....	5-3	Idling Stop OFF switch .....	5-21
Three-way catalyst (gasoline engine model) .....	5-4	Stop/Start System (if equipped for Europe) .....	5-21
Care when driving .....	5-5	Normal operation .....	5-21
Engine cold start period .....	5-5	Stop/Start System display and indicators .....	5-22
Loading luggage .....	5-5	Precautions on Stop/Start .....	5-23
Driving in wet conditions .....	5-5	Stop/Start System OFF switch .....	5-23
Driving in winter conditions .....	5-5	Vehicle Dynamic Control (VDC) system (if equipped except for Europe, Australia and New Zealand) .....	5-24
Ignition switch (model without intelligent Key system) .....	5-5	Vehicle Dynamic Control (VDC) OFF switch .....	5-25
Automatic Transmission (AT)/Continuously Variable Transmission (CVT) .....	5-5	Vehicle Dynamic Control (VDC) system (for Australia and New Zealand) .....	5-25
Manual transmission (MT) .....	5-5	Vehicle Dynamic Control (VDC) OFF switch .....	5-26
Steering lock .....	5-6	Electronic Stability Program (ESP) System (if equipped for Europe) .....	5-27
Key positions .....	5-6	Electronic Stability Program (ESP) OFF Switch .....	5-27
Push-button ignition switch (model with Intelligent Key system) .....	5-6	Speed limiter (if equipped for Europe) .....	5-28
Precautions on push-button ignition switch operation .....	5-6	Speed limiter operations .....	5-28
Intelligent Key system .....	5-6	Cruise control (if equipped) .....	5-30
Steering lock .....	5-7	Precautions on cruise control .....	5-30
Ignition switch positions .....	5-8	Cruise control operations .....	5-30
Intelligent Key battery discharge .....	5-8	Parking .....	5-32
Starting engine (model without Intelligent Key system) .....	5-9	Sonar (parking sensor) system (if equipped) .....	5-34
Gasoline engine .....	5-9	Parking Sensor Indicator .....	5-34
Diesel engine .....	5-9	Parking space measurement operation (if equipped) .....	5-35
Starting engine (model with Intelligent Key system) .....	5-10	Trailer towing .....	5-37
Gasoline engine .....	5-10	Electric power steering system .....	5-37
Diesel engine .....	5-11	Brake system .....	5-38
Driving vehicle .....	5-11	Brake precautions .....	5-38
Driving with Automatic Transmission (AT) .....	5-11	Brake assist (if equipped) .....	5-39
Driving with Continuously Variable Transmission (CVT) .....	5-14		

Anti-lock Braking System (ABS) (if equipped) .....	5-39
Using system .....	5-39
Self-test feature .....	5-39
Normal operation .....	5-40
Vehicle security .....	5-40

Cold weather driving .....	5-40
Battery .....	5-41
Engine coolant .....	5-41
Tire equipment .....	5-41
Special winter equipment .....	5-41
Parking brake .....	5-41
Corrosion protection .....	5-41

## BREAK-IN SCHEDULE

During the first 1,600 km (1,000 miles), follow these recommendations to obtain maximum engine performance and ensure the future reliability and economy of your new vehicle. Failure to follow these recommendations may result in shortened engine life and reduced engine performance.

- Do not drive at a constant speed, either fast or slow, for long periods of time.
- Do not run the engine over 4,000 rpm (HR12 or HR15 engine) or 2,500 rpm (K9K engine).
- Do not accelerate at full throttle in any gear.
- Do not start quickly.
- Do not brake hard as much as possible.

## BEFORE STARTING ENGINE



### WARNING:

**The driving characteristics of your vehicle will change remarkably by any additional load and its distribution, as well as by adding optional equipment (trailer coupling, roof racks, etc.). Your driving style and speed must be adjusted according to the circumstances. Especially when carrying heavy loads, your speed must be reduced adequately.**

- Make sure the area around the vehicle is clear.
- Visually inspect tires for their appearance and condition. Measure and check the tire pressure for proper inflation.
- Check that all windows and lights are clean.
- Adjust the seat and head restraint positions.
- Adjust the inside and outside rearview mirror positions.
- Fasten your seat belt and ask all passengers to do the same.
- Check that all doors are closed.
- Check the operation of the warning lights when the ignition switch is turned to the "ON" position.
- Maintenance items in the "8. Maintenance and do-it-yourself" section should be checked periodically.

## PRECAUTIONS WHEN STARTING AND DRIVING



### WARNING:

- **Never leave children or adults who would normally require the support of others alone in your vehicle. Pets should not be left alone either. They could unknowingly activate switches or controls and inadvertently become involved in a serious accident and injure themselves. On hot, sunny days, temperatures in a closed vehicle could quickly become high enough to cause severe or possibly fatal illness to people or animals.**
- **Properly secure all luggage to help prevent it from sliding or shifting. Do not place luggage higher than the seatbacks. In a sudden stop or collision, unsecured luggage could cause personal injury.**

### EXHAUST GAS (carbon monoxide)



### WARNING:

- **Do not breathe exhaust gas; it contains colorless and odorless carbon monoxide. Carbon monoxide is dangerous. It can cause unconsciousness or death.**
- **If you suspect that exhaust fumes are entering the vehicle, drive with all windows fully open, and have the vehicle inspected immediately.**
- **Do not run the engine in closed spaces such as a garage.**
- **Do not park the vehicle with the engine running for an extended period of time.**

- Keep the back door closed while driving, otherwise exhaust gas could be drawn into the passenger compartment. If you must drive with the back door open, follow these precautions:

- Open all the windows.

- Turn the air recirculation mode off and set the fan speed control to the highest level to circulate the air.

- If electrical wiring or other cable connections must pass to a trailer through the seal of the back door or the body, follow the manufacturer's recommendation to prevent carbon monoxide entry into the vehicle.
- If a special body or other equipment is added for recreational or other usage, follow the manufacturer's recommendation to prevent carbon monoxide entry into the vehicle. (Some recreational vehicle appliances such as stoves, refrigerators, heaters, etc. may also generate carbon monoxide.)
- The exhaust system and body should be inspected by a qualified mechanic whenever:
  - Your vehicle is raised while being serviced.
  - You suspect that exhaust fumes are entering into the passenger compartment.
  - You notice a change in the sound of the exhaust system.
  - You have had an accident involving damage to the exhaust system, underbody, or rear of the vehicle.

### THREE-WAY CATALYST (gasoline engine model)



#### WARNING:

- The exhaust gas and the exhaust system are very hot. Keep people, animals and flammable materials away from the exhaust system components.
- Do not stop or park the vehicle over flammable materials such as dry grass, wastepaper or rags. They may ignite and cause a fire.

The three-way catalyst is an emission control device installed in the exhaust system. Exhaust gas in the three-way catalyst is burned at high temperatures to help reduce pollutants.



#### CAUTION:

- Do not use leaded gasoline. (See "Recommended fuel/lubricants and capacities" (P.9-2).) Deposits from leaded gasoline seriously reduce the ability of the three-way catalyst to help reduce exhaust pollutants and/or damage the three-way catalyst.
- Keep your engine tuned up. Malfunctions in the ignition, fuel injection, or electrical systems may cause overrich fuel to flow into the three-way catalyst, causing it to overheat. Do not keep driving if the engine misfires, or if noticeable loss of performance or other unusual operating conditions are detected. Have the vehicle inspected promptly by a NISSAN dealer.
- Avoid driving with an extremely low fuel level. Running out of fuel could cause the

engine to misfire, damaging the three-way catalyst.

- Do not race the engine while warming it up.
- Do not push or tow your vehicle to start the engine.

## CARE WHEN DRIVING

Driving your vehicle to fit the circumstances is essential for your safety and comfort. As a driver, you should be the one who knows best how to drive in the given circumstances.

### ENGINE COLD START PERIOD

Due to the higher engine speeds, when the engine is cold, extra caution must be exercised when selecting a gear during the engine warm-up period after starting the engine.

### LOADING LUGGAGE

Loads and their distribution and the attachment of equipment (coupling devices, roof baggage carriers, etc.) will considerably change the driving characteristics of the vehicle. Your driving style and speed must be adjusted according to the circumstances.

### DRIVING IN WET CONDITIONS

- Avoid accelerating or stopping suddenly.
- Avoid sharp turning or lane changing suddenly.
- Avoid following too close to the vehicle in front.

When water covers the road surface with water puddles, small water streams, etc., reduce speed to prevent hydroplaning which can cause skidding and loss of control. Worn tires will increase this risk.

### DRIVING IN WINTER CONDITIONS

- Drive cautiously.
- Avoid accelerating or stopping suddenly.
- Avoid sharp turning or lane changing suddenly.
- Avoid sudden steering.
- Avoid following too close to the vehicle in front.

## IGNITION SWITCH (model without intelligent Key system)



### WARNING:

**Never remove the key or turn the ignition switch to the “LOCK” position while driving. The steering wheel will lock. This may cause the driver to lose control of the vehicle and could result in serious vehicle damage or personal injury.**

### AUTOMATIC TRANSMISSION (AT)/CONTINUOUSLY VARIABLE TRANSMISSION (CVT)

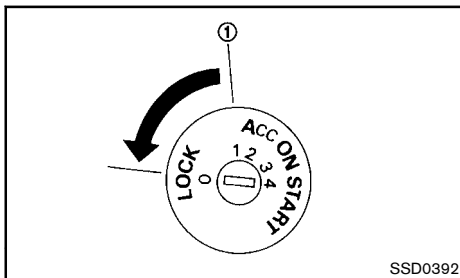

The ignition lock is designed so that the ignition switch cannot be turned to the “LOCK” position until the shift lever is moved to the “P” (Park) position. When moving the ignition switch to the “LOCK” position, to remove the key from the ignition switch, make sure the shift lever is in the “P” (Park) position.

When the ignition switch cannot be turned to the “LOCK” position:

1. Move the shift lever to the “P” (Park) position.
2. Turn the ignition switch slightly in the “ON” direction.

3. Turn the ignition switch to the “LOCK” position.
4. Remove the key, if it is inserted in the ignition switch.

If the ignition switch is turned to the “LOCK” position, the shift lever cannot be moved from the “P” (Park) position. The shift lever can be moved if the ignition switch is in the “ON” position with the foot brake pedal depressed.

The “OFF” position ① is between the “LOCK” and “ACC” positions, although it is not marked on the ignition switch.

### MANUAL TRANSMISSION (MT)

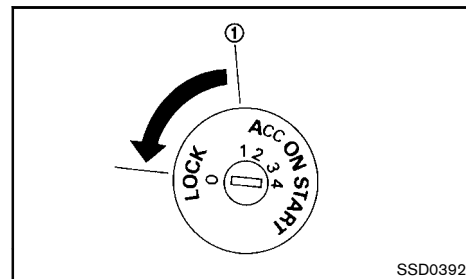

Type A



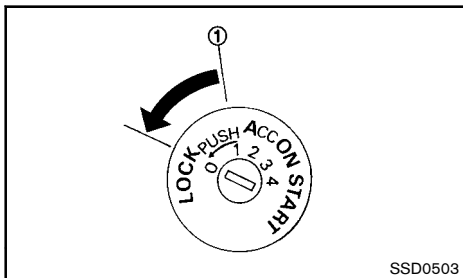

**Type B**

The ignition switch includes a device that helps prevent accidental removal of the key while driving.

The key can only be removed when the ignition switch is in the "LOCK" position.

Type B: To turn the ignition switch to the "LOCK" position from the "ACC" or "ON" position, turn the key to the "OFF" position, push the key in, then turn the key to the "LOCK" position.

The "OFF" position ① is between the "LOCK" and "ACC" positions, although it is not labeled on the ignition switch.

## STEERING LOCK

To lock steering wheel

1. Turn the ignition switch to the "LOCK" position.
2. Remove the key.
3. Turn the steering wheel 1/6 of a turn clockwise from the straight up position.

To unlock steering wheel

1. Insert the key into the ignition switch.
2. Gently turn the ignition switch while rotating the steering wheel slightly right and left.

## KEY POSITIONS

### LOCK (0)

The ignition key can only be removed at this position.

The steering lock can only be locked at this position.

### OFF (1)

The engine is turned off with the steering wheel unlocked.

### ACC (2)

The electrical accessory power activates without the engine turned on.

### ON (3)

The ignition system and the electrical accessory power activate without the engine turned on.

### START (4)

The engine starter activates and the engine will start. The ignition switch, when released, will automatically turn to the "ON" position.



### CAUTION:

**As soon as the engine has started, release the ignition switch immediately.**

## PUSH-BUTTON IGNITION SWITCH (model with Intelligent Key system)

### PRECAUTIONS ON PUSH-BUTTON IGNITION SWITCH OPERATION



### WARNING:

**Do not operate the push-button ignition switch while driving the vehicle except in an emergency. (The engine will stop when the ignition switch is pushed 3 consecutive times or the ignition switch is pushed and held for more than 2 seconds.) The steering wheel will lock and could cause the driver to lose control of the vehicle. This could result in serious vehicle damage or personal injury.**

Before operating the push-button ignition switch, be sure to move the shift lever to the "P" (Park) position (for Automatic Transmission/Continuously Variable Transmission model) or the shift lever to the "N" (Neutral) position (for Manual Transmission model).

### INTELLIGENT KEY SYSTEM

The Intelligent Key system can operate the ignition switch without taking the key out from your pocket or bag. The operating environment and/or conditions may affect the Intelligent Key system operation. Some indicators and warnings for operation are displayed on the vehicle information display (if equipped) and/or in the meter. (See "Vehicle information display" (P.2-20) and "Warning/indicator lights and audible reminders" (P.2-12).)



### CAUTION:

- **Be sure to carry the Intelligent Key with you when operating the vehicle.**
- **Never leave the Intelligent Key inside the vehicle when you leave the vehicle.**

- If the vehicle battery is discharged, the ignition switch cannot be switched from the “LOCK” position, and if the steering lock is engaged, the steering wheel cannot be moved. Charge the battery as soon as possible. (See “Jump starting” (P.6-9).)

### Operating range

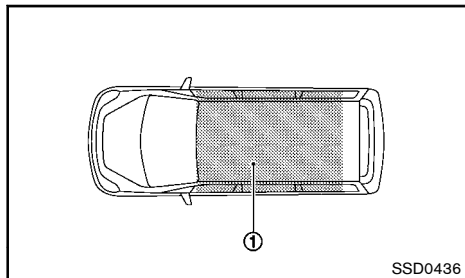

The Intelligent Key can only be used for starting the engine when the Intelligent Key is within the specified operating range ①.

When the Intelligent Key battery is almost discharged or strong radio waves are present near the operating location, the Intelligent Key system's operating range becomes narrower and may not function properly.

If the Intelligent Key is within the operating range, it is possible for anyone, even someone who does not carry the Intelligent Key, to push the ignition switch to start the engine.

- The luggage room area is not included in the operating range, but the Intelligent Key may function.
- If the Intelligent Key is placed on the instrument panel, inside the glove box, door pocket or the corner of the interior compartment, the Intelligent

Key may not function.

- If the Intelligent Key is placed near the door or window outside the vehicle, the Intelligent Key may function.

### Automatic transmission (AT)/Continuously Variable Transmission (CVT) model

The ignition lock is designed so that the ignition switch cannot be switched to the “LOCK” position until the shift lever is moved to the “P” (Park) position. When pushing the ignition switch to the “OFF” position, make sure the shift lever is in the “P” (Park) position.

#### Type A (model with dot matrix display):

When the ignition switch cannot be switched to the “LOCK” position:

1. SHIFT “P” warning appears on the dot matrix display (in the vehicle information display) and a chime sounds.
2. Move the shift lever to the “P” (Park) position.
3. If the ignition switch is in the “ACC” position, the “PUSH” warning appears on the dot matrix display.
4. Push the ignition switch. The ignition switch is switched to the “ON” position.
5. The “PUSH” warning appears again on the dot matrix display.
6. Push the ignition switch. The ignition switch is switched to the “OFF” position.
7. Open the door. The ignition switch will change to the “LOCK” position.

For warnings and indicators on the Vehicle information display, see “Vehicle information display” (P.2-20).

#### Type B (model without dot matrix display):

1. Move the shift lever to the “P” (Park) position.
2. Push the ignition switch to the “OFF” position.
3. Open the door. The ignition switch will change to the “LOCK” position.

If the ignition switch is switched to the “LOCK” position, the shift lever cannot be moved from the “P” (Park) position. The shift lever can be moved if the ignition switch is in the “ON” position with the foot brake depressed.

### STEERING LOCK

The ignition switch is equipped with an anti-theft steering lock device.

#### To lock steering wheel

1. Push the ignition switch to the “OFF” position where the ignition switch position indicator will not illuminate.
2. Open or close the door. The ignition switch turns to the “LOCK” position.
3. Turn the steering wheel 1/6 of a turn to the right or left from the straight up position.

#### To unlock steering wheel

Push the ignition switch, and the steering wheel will be automatically unlocked.



#### CAUTION:

- If the battery of the vehicle is discharged, the push-button ignition switch cannot be switched from the “LOCK” position.
- If the ignition switch position does not change from the “LOCK” position, push the ignition switch again while rotating the

steering wheel slightly to the right and left.  
(See "Vehicle information display" (P.2-20).)

## IGNITION SWITCH POSITIONS

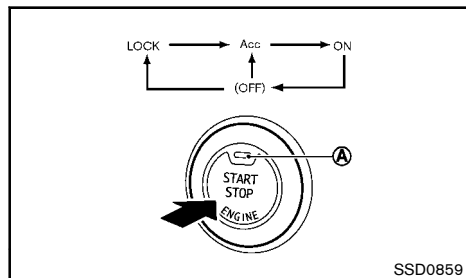

When the ignition switch is pushed without depressing the brake pedal (Automatic Transmission/Continuously Variable Transmission model) or the clutch pedal (Manual Transmission model), the ignition switch position will change as follows:

- Push once to change to "ACC".
- Push two times to change to "ON".
- Push three times to change to "OFF".
- Push four times to return to "ACC".
- Open or close any door to return to "LOCK" when in the "OFF" position.

The indicator light (A) on the ignition switch illuminates when the ignition switch is in the "ACC" or "ON" position.

## LOCK position

The ignition switch and steering lock can only be locked at this position.

The ignition switch will be unlocked when it is pushed to the "ACC" position while carrying the Intelligent Key.

## ACC position

The electrical accessory power activates at this position without the engine turned on.

## ON position

The ignition system and the electrical accessory power activate at this position without the engine turned on.

## OFF position

The engine is turned off with the steering wheel unlocked.



### WARNING:

**Never push the ignition switch to the "OFF" position while driving. The steering wheel may lock and cause the driver to lose control of the vehicle, resulting in serious vehicle damage or personal injury.**



### CAUTION:

**Do not leave the vehicle for extended periods of time when the ignition switch is in the "ACC" or "ON" position and the engine is not running. This can discharge the battery.**

### NOTE:

**When the ignition switch is pushed while the Stop/Start (Idling Stop) System (if equipped) is activated, the ignition switch will be placed in**

## the "OFF" position.

## INTELLIGENT KEY BATTERY DISCHARGE

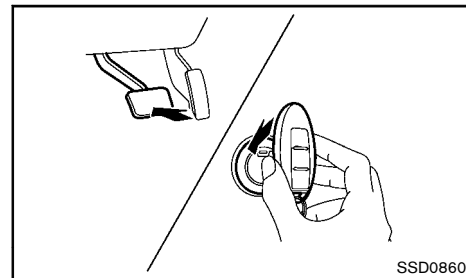

If the battery of the Intelligent Key is discharged, or environmental conditions interfere with the Intelligent Key operation, start the engine according to the following procedure:

### 1. Automatic Transmission (AT)/Continuously Variable Transmission (CVT) model:

Move the shift lever to the "P" (Park) or "N" (Neutral) position.

### Manual Transmission (MT) model:

Move the shift lever to the "N" (Neutral) position.

2. Firmly depress the brake pedal (Automatic Transmission/Continuously Variable Transmission model) or the clutch pedal (Manual Transmission model).
3. Touch the ignition switch with the Intelligent Key as illustrated. (A chime will sound.)
4. Push the ignition switch while depressing the brake pedal within 10 seconds after the chime sounds. The engine will start.

After step 3 is performed, when the ignition switch is pushed without depressing the brake pedal, the

## STARTING ENGINE (model without Intelligent Key system)

ignition switch position will change to "ACC".

### NOTE:

- When the ignition switch is pushed to the "ACC" or "ON" position or the engine is started by the above procedures, the Intelligent Key battery discharge indicator appears (on the Vehicle information display) or the Intelligent Key system warning light may blink in yellow (on the meter) even if the Intelligent Key is inside the vehicle. This is not a malfunction. To stop the warning light from blinking, touch the ignition switch with the Intelligent Key again.
- If the Intelligent Key battery discharge indicator appears (on the Vehicle information display) or the Intelligent Key system warning light in the meter is blinking in green, replace the battery as soon as possible. (See "Battery" (P.8-24).)

## GASOLINE ENGINE

1. Apply the parking brake.
2. Depress the foot brake pedal.
3. **Automatic Transmission (AT)/Continuously Variable Transmission (CVT) model:**

Move the shift lever to the "P" (Park) or "N" (Neutral) position.

**The starter is designed to operate only when the shift lever is in the proper position.**

**Manual Transmission (MT) model:**

Move the shift lever to the "N" (Neutral) position, and depress the clutch pedal to the floor while starting the engine.

**The starter is designed to not operate unless the clutch pedal is depressed.**

4. Crank the engine with your foot off the accelerator pedal by turning the ignition switch to the "START" position.
5. Immediately release the ignition switch when the engine starts. If the engine starts, but fails to run, repeat the above procedures.

If the engine is very hard to start in extremely cold or hot weather, depress the accelerator pedal and hold it to help start the engine.



### CAUTION:

- Do not operate the starter for more than 15 seconds at a time. If the engine does not start, turn the ignition switch off and wait 10 seconds before cranking the engine again. Otherwise, the starter could be damaged.
- If it becomes necessary to start the engine with a booster battery and jumper cables,

**the instructions and cautions contained in the "6. In case of emergency" section should be carefully followed.**

6. Allow the engine to idle for at least 30 seconds after starting the engine to warm-up. Drive at moderate speeds for a short distance first, especially in cold weather.



### CAUTION:

**Do not leave the vehicle unattended while the engine is warming up.**

## DIESEL ENGINE

1. Apply the parking brake.
2. Depress the foot brake pedal.
3. Move the shift lever to the "N" (Neutral) position, and depress the clutch pedal to the floor while starting the engine.
4. Turn the ignition switch to the "ON" position and wait until the glow plug indicator light  turns off.
5. Crank the engine with your foot off the accelerator pedal by turning the ignition switch to the "START" position.
6. Immediately release the ignition switch when the engine starts. If the engine starts, but fails to run, repeat the above procedures.



### CAUTION:

- Do not operate the starter for more than 20 seconds at a time. If the engine does not start, turn the ignition switch off and wait 20 seconds before cranking the engine again. Otherwise, the starter could be damaged.

## STARTING ENGINE (model with Intelligent Key system)

- If it becomes necessary to start the engine with a booster battery and jumper cables, the instructions and cautions contained in the “6. In case of emergency” section should be carefully followed.
7. Allow the engine to idle for at least 30 seconds after starting the engine to warm-up. Drive at moderate speeds for a short distance first, especially in cold weather.



### CAUTION:

Do not leave the vehicle unattended while the engine is warming up.

### GASOLINE ENGINE

1. Apply the parking brake.
2. **Automatic Transmission (AT)/Continuously Variable Transmission (CVT) model:**

Move the shift lever to the “P” (Park) or the “N” (Neutral) position.

**The starter is designed to operate only when the shift lever is in the proper position.**

#### Manual Transmission (MT) model:

Move the shift lever to the “N” (Neutral) position.

**The starter is designed to not operate unless the clutch pedal is fully depressed.**

**The Intelligent Key must be carried when operating the ignition switch.**

3. Push the ignition switch to the “ON” position. Depress the brake pedal (AT/CVT model) or the clutch pedal (MT model) and push the ignition switch to start the engine.

To start the engine immediately, push and release the ignition switch while depressing the brake pedal or clutch pedal with the ignition switch in any position.

4. Immediately release the ignition switch when the engine starts. If the engine starts, but fails to run, repeat the above procedures.

If the engine is very hard to start in extremely cold or hot weather, depress the accelerator pedal and hold it. Push the ignition switch for up to 15 seconds while holding. Release the accelerator pedal when the engine starts.



### CAUTION:

- As soon as the engine has started, release the ignition switch immediately.
  - Do not operate the starter for more than 15 seconds at a time. If the engine does not start, push the ignition switch to the “OFF” position and wait 10 seconds before cranking the engine again. Otherwise, the starter could be damaged.
  - If it becomes necessary to start the engine with a booster battery and jumper cables, the instructions and cautions contained in the “6. In case of emergency” section should be carefully followed.
5. Allow the engine to idle for at least 30 seconds after starting the engine to warm-up. Drive at moderate speeds for a short distance first, especially in cold weather.



### CAUTION:

Do not leave the vehicle unattended while the engine is warming up.

6. To stop the engine, move the shift lever to the “P” (Park) position (AT/CVT model) or move the shift lever to the “N” (Neutral) position (MT model), apply the parking brake and push the ignition switch to the “OFF” position.

## DIESEL ENGINE

1. Apply the parking brake.
2. Move the shift lever to the “N” (Neutral) position.

**The starter is designed to not operate unless the clutch pedal is fully depressed.**

**The Intelligent Key must be carried when operating the ignition switch.**

3. Push the ignition switch to the “ON” position and wait until the glow plug indicator light turns off. Depress the clutch pedal and push the ignition switch to start the engine.

To start the engine immediately, push and release the ignition switch while depressing the clutch pedal with the ignition switch in any position.

4. Immediately release the ignition switch when the engine starts. If the engine starts, but fails to run, repeat the above procedures.

If the engine is very hard to start in extremely cold or hot weather, depress the accelerator pedal and hold it. Push the ignition switch for up to 15 seconds while holding. Release the accelerator pedal when the engine starts.



### CAUTION:

- **As soon as the engine has started, release the ignition switch immediately.**
- **Do not operate the starter for more than 20 seconds at a time. If the engine does not start, push the ignition switch to the “OFF” position and wait 20 seconds before cranking the engine again. Otherwise, the starter could be damaged.**

- **If it becomes necessary to start the engine with a booster battery and jumper cables, the instructions and cautions contained in the “6. In case of emergency” section should be carefully followed.**
5. Allow the engine to idle for at least 30 seconds after starting the engine to warm-up. Drive at moderate speeds for a short distance first, especially in cold weather.



### CAUTION:

**Do not leave the vehicle unattended while the engine is warming up.**

6. To stop the engine, move the shift lever to the “N” (Neutral) position, apply the parking brake and push the ignition switch to the “OFF” position.

## DRIVING VEHICLE

### DRIVING WITH AUTOMATIC TRANSMISSION (AT)

The Automatic Transmission (AT) in your vehicle is electronically controlled to produce maximum power and smooth operation.

The recommended operating procedures for this transmission are shown on the following pages. Follow these procedures for maximum vehicle performance and driving enjoyment.



### WARNING:

**Do not downshift abruptly on slippery roads. This may cause a loss of control.**



### CAUTION:

- **The cold engine idle speed is high, so use caution when shifting the transmission into a forward or reverse position before the engine has warmed up.**
- **Avoid revving up the engine while the vehicle is stopped. This could cause unexpected vehicle movement.**
- **Never shift to either the “P” (Park) or “R” (Reverse) position while the vehicle is moving. This could cause serious damage to the transmission.**
- **Except in an emergency, do not shift to the “N” (Neutral) position while driving. Coasting with the transmission in the “N” (Neutral) position may cause serious damage to the transmission.**
- **Start the engine in either the “P” (Park) or “N” (Neutral) position. The engine will not start in any other position. If it does, have**

your vehicle checked by a NISSAN dealer.

- Shift into the “P” (Park) position and apply the parking brake when at a standstill for longer than a short waiting period.
- Keep the engine at idling speed while shifting from the “N” (Neutral) position to any driving position.
- When stopping the vehicle on an uphill grade, do not hold the vehicle by depressing the accelerator pedal. The foot brake pedal should be depressed in this situation.

### Starting vehicle

1. After starting the engine, fully depress the foot brake pedal before shifting the shift lever out of the “P” (Park) position.
2. Keep the foot brake pedal depressed and move the shift lever to a driving position.
3. Release the parking brake, the foot brake pedal, and then gradually start the vehicle in motion.

The AT is designed so the foot brake pedal **MUST** be depressed before shifting from the “P” (Park) position to any driving position while the ignition switch is in the “ON” position.

The shift lever cannot be moved out of the “P” (Park) position and into any of the other gear positions if the ignition switch is turned to the “LOCK”, “OFF” or “ACC” position or if the key is removed.



### CAUTION:

- **DEPRESS THE FOOT BRAKE PEDAL** - Shifting the shift lever to “D”, “R”, “2” or “1” without depressing the foot brake pedal causes the vehicle to move slowly when

the engine is running. Make sure the foot brake pedal is depressed fully and the vehicle is stopped before shifting the shift lever.

- **MAKE SURE OF THE SHIFT LEVER POSITION** - Make sure the shift lever is in the desired position. “D”, “2” and “1” are used to move forward and “R” to back up.
- **WARM UP THE ENGINE** - Due to the higher idle speeds when the engine is cold, extra caution must be exercised when shifting the shift lever into the driving position immediately after starting the engine.

### Shifting gear

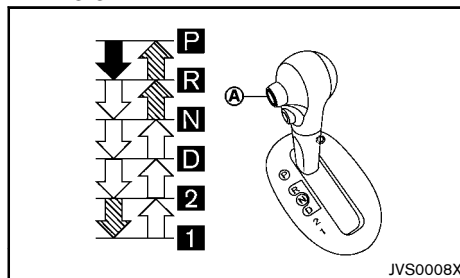

Left-Hand Drive (LHD) model

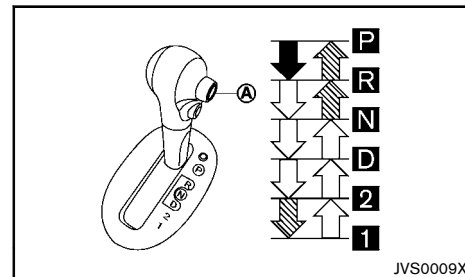

Right-Hand Drive (RHD) model

- ➡: Push the button (A) while depressing the foot brake pedal.
- ↗: Push the button (A).
- ⇨: Just move the shift lever.



### WARNING:

- **Apply the parking brake if the shift lever is in any position while the engine is not running. Failure to do so could cause the vehicle to move unexpectedly or roll away and result in serious personal injury or property damage.**
- **If the shift lever cannot be moved from the P (Park) position while the engine is running and the foot brake pedal is depressed, the stop lights may not work. Malfunctioning stop lights could cause an accident injuring yourself and others.**

After starting the engine, fully depress the foot brake pedal, push the shift lever button and move the shift lever out of the P (Park) position.

If the ignition switch is the OFF or ACC position for any reason while the shift lever is in any positions other than the P (Park) position, the ignition switch cannot

be turned to the LOCK position.

If the ignition switch cannot be the LOCK position, perform the following steps:

1. Apply the parking brake.
2. Place the ignition switch in the ON position while depressing the foot brake pedal.
3. Move the shift lever to the P (Park) position.
4. Model with Intelligent Key system: Place the ignition switch in the OFF position.

Model without Intelligent Key system: Place the ignition switch in the LOCK position.

#### **P (Park):**

Use this position when the vehicle is parked or when starting the engine. **Make sure that the vehicle is completely stopped and move the shift lever into the P (Park) position.** Apply the parking brake. When parking on a hill, apply the parking brake first, and then move the shift lever into the P (Park) position.

#### **R (Reverse):**

Use this position to back up. Make sure that the vehicle is completely stopped before selecting the R (Reverse) position.

#### **N (Neutral):**

Neither the forward nor reverse gear is engaged. The engine can be started in this position. You may shift to the N (Neutral) position and restart a stalled engine while the vehicle is moving.

#### **D (Drive):**

Use this position for all normal forward driving.

#### **2 (Second gear):**

Use this position for climbing hills or engine braking on downhill grades.

#### **1 (Low gear):**

Use this position when climbing steep hills slowly or driving slowly through deep snow, or for maximum engine braking on steep downhill grades.

Do not shift into the gears when the vehicle speed exceeds the following limits, otherwise the engine may over-rev and cause engine damage.

Engine model	Shift lever position	
	1	2
HR12DE km/h (MPH)	45 (28)	90 (56)
HR15DE km/h (MPH)	50 (30)	95 (60)

#### Overdrive switch

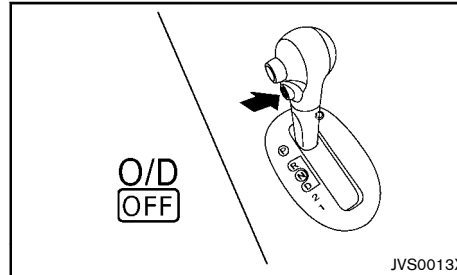

#### **Left-Hand Drive (LHD) model**

Each time the engine is started, the overdrive function is automatically reset to "ON".

#### **"ON" position:**

With the engine running and the shift lever in the "D" (Drive) position, the transmission upshifts into the overdrive as vehicle speed increases.

**Overdrive does not engage until the engine has reached operating temperature.**

#### **"OFF" position:**

For driving up and down long slopes where engine braking is necessary, push the overdrive switch. The overdrive off indicator light  in the meter panel illuminates.

When cruising at a low speed or climbing a gentle slope, you may feel uncomfortable shift shocks as the transmission shifts into and out of the overdrive repeatedly. In this case, push the overdrive switch to turn the overdrive "OFF".

When driving conditions change, push the overdrive switch to turn the overdrive "ON". The overdrive off indicator light will turn off.

Remember not to drive at high speeds for extended periods of time with the overdrive "OFF". This reduces fuel economy.

#### Accelerator downshift - in D (Drive) position

For passing or climbing hills, depress the accelerator pedal to the floor. This shifts the transmission down into a lower gear, depending on the vehicle speed.

#### Shift lock release

If the battery is discharged, the shift lever may not be moved from the "P" (Park) position even with the foot brake pedal depressed.

To move the shift lever, release the shift lock. The shift lever can be moved to the "N" (Neutral) position. However, the steering wheel will be locked unless the ignition switch is placed in the "ON" position. This



allows the vehicle to be moved if the battery is discharged.

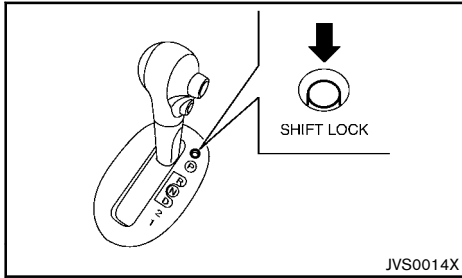

#### Right-Hand Drive (RHD) model

To release the shift lock, perform the following procedure

1. Models with Intelligent KEY system: Place the ignition switch in the "OFF" or "LOCK" position.  
Models without Intelligent KEY system: Place the ignition switch in the "LOCK" position and remove the key.
2. Apply the parking brake.
3. Depress the shift lock release button.
4. Push and hold the shift lever button and move the shift lever to the "N" (Neutral) position while holding down the shift lock release button.
5. Place the ignition switch to the "ON" position to release the steering wheel lock.

The vehicle may be moved, by pushing, to the desired location.

If the shift lever cannot be moved out of the "P" (Park) position, have a NISSAN dealer check the AT system as soon as possible.

#### Fail-safe

When the fail-safe operation occurs, the AT will be locked in third gear.

**If the vehicle is driven under extreme conditions, such as excessive wheel spinning and subsequent hard braking, the fail-safe system may be activated. This will occur even if all electrical circuits are functioning properly. In this case, turn the ignition switch off and wait for 3 seconds. Then turn the ignition switch back to the "ON" position. The vehicle should return to its normal operating condition. If it does not return to its normal operating condition, have a NISSAN dealer check the transmission and repair it if necessary.**

#### DRIVING WITH CONTINUOUSLY VARIABLE TRANSMISSION (CVT)

The Continuously Variable Transmission (CVT) in your vehicle is electronically controlled to produce maximum power and smooth operation.

The recommended operating procedures for this transmission are shown on the following pages. Follow these procedures for maximum vehicle performance and driving enjoyment.



#### WARNING:

**Do not downshift abruptly on slippery roads. This may cause a loss of control.**



#### CAUTION:

- **The cold engine idle speed is high, so use caution when shifting the transmission into a forward or reverse position before the engine has warmed up.**

- **Avoid revving up the engine while the vehicle is stopped. This could cause unexpected vehicle movement.**
- **Never shift to either the "P" (Park) or "R" (Reverse) position while the vehicle is moving. This could cause serious damage to the transmission.**
- **Except in an emergency, do not shift to the "N" (Neutral) position while driving. Coasting with the transmission in the "N" (Neutral) position may cause serious damage to the transmission.**
- **Start the engine in either the "P" (Park) or "N" (Neutral) position. The engine will not start in any other position. If it does, have your vehicle checked by a NISSAN dealer.**
- **Shift into the "P" (Park) position and apply the parking brake when at a standstill for longer than a short waiting period.**
- **Keep the engine at idling speed while shifting from the "N" (Neutral) position to any driving position.**
- **When stopping the vehicle on an uphill grade, do not hold the vehicle by depressing the accelerator pedal. The foot brake pedal should be depressed in this situation.**

#### Starting vehicle

1. After starting the engine, fully depress the foot brake pedal before moving the shift lever out of the "P" (Park) position.
2. Keep the foot brake pedal depressed and move the shift lever to a driving position.
3. Release the parking brake, the foot brake pedal, and then gradually start the vehicle in motion.



### **P (Park):**

Use this position when the vehicle is parked or when starting the engine. **Make sure that the vehicle is completely stopped and move the shift lever into the “P” (Park) position.** Apply the parking brake. When parking on a hill, first depress the foot brake pedal, apply the parking brake, and then move the shift lever into the “P” (Park) position.

### **R (Reverse):**

Use this position to back up. Make sure that the vehicle is completely stopped before selecting the “R” (Reverse) position.

### **N (Neutral):**

Neither the forward nor reverse gear is engaged. The engine can be started in this position. You may shift to the “N” (Neutral) position and restart a stalled engine while the vehicle is moving.

### **D (Drive):**

Use this position for all normal forward driving.

### **L (Low):**

Use this position when climbing steep hills slowly or driving slowly through deep snow, sand or mud, or for maximum engine braking on steep downhill grades.

### **SPORT mode switch**

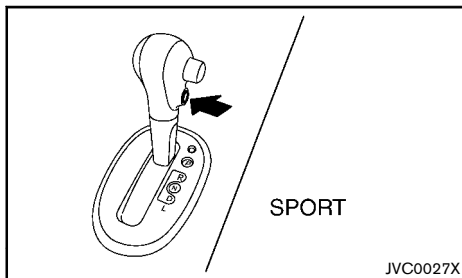

#### **Right-Hand Drive (RHD) model**

To select the SPORT mode, push the SPORT mode switch with the shift lever in the “D” (Drive) position. The SPORT mode indicator light **SPORT** in the meter panel illuminates. To turn off the SPORT mode, push the SPORT mode switch again. The SPORT mode indicator light will turn off. When the shift lever is shifted to any position other than “D”, the SPORT mode will be automatically turned off.

#### **“OFF” position:**

For normal driving and fuel economy, use the “OFF” position.

#### **“ON” position:**

For driving up or down long slopes where engine braking is necessary, or for powerful acceleration, use the “ON” position. The transmission will automatically select a different gear ratio, allowing the engine to provide high output.

When driving conditions change, push the switch to turn the SPORT mode off.

Remember not to drive at high speeds for extended periods of time with the SPORT mode in the “ON” position. This reduces fuel economy.

### **Accelerator downshift - in the “D” position -**

For passing or climbing hills, depress the accelerator pedal to the floor. This shifts the transmission down into a lower gear, depending on the vehicle speed.

### **Shift lock release**

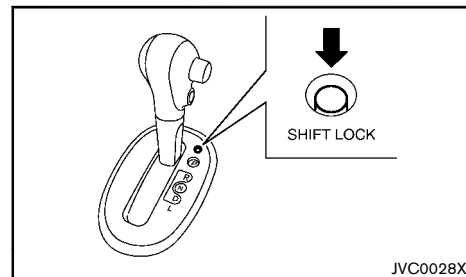

#### **Right-Hand Drive (RHD) model**

If the battery charge is low or discharged, the shift lever may not be moved from the “P” (Park) position even with the brake pedal depressed and the shift lever button pushed.

To move the shift lever, perform the following procedure:

1. Model with Intelligent Key system:  
Place the ignition switch in the “OFF” or “LOCK” position.
- Model without Intelligent Key system:  
Place the ignition switch in the “LOCK” position, and remove the key if it is inserted.
2. Apply the parking brake.
3. Depress the shift lock release button.
4. Push the shift lever button and move the shift lever to the “N” (Neutral) position while holding down the shift lock release.

5. Place the ignition switch in the "ON" position to unlock the steering wheel.

The vehicle may be moved to the desired location.

Replace the removed shift lock release cover after the operation.

For model with Intelligent Key system: If the battery is discharged completely, the steering wheel cannot be unlocked. Do not move the vehicle with the steering wheel locked.

If the shift lever cannot be moved out of the "P" (Park) position, have a NISSAN dealer check the CVT system as soon as possible.



#### **WARNING:**

**If the shift lever cannot be moved from the "P" (Park) position while the engine is running and the brake pedal is depressed, the stop lights may not work. Malfunctioning stop lights could cause an accident injuring yourself and others.**

#### High fluid temperature protection mode

This transmission has a high fluid temperature protection mode. If the fluid temperature becomes too high (for example, when climbing steep grades in high temperature with heavy loads, such as when towing a trailer), engine power and, under some conditions, vehicle speed will be decreased automatically to reduce the chance of transmission damage. Vehicle speed can be controlled with the accelerator pedal, but engine and vehicle speed may be limited.

#### Fail-safe

When the fail-safe operation occurs, the CVT will not be shifted to the selected driving position.

**If the vehicle is driven under extreme conditions, such as excessive wheel spinning and subsequent hard braking, the fail-safe system may be activated. This will occur even if all electrical circuits are functioning properly. In this case, place the ignition switch in the "OFF" position and wait for 10 seconds. Then turn the ignition switch back to the "ON" position. The vehicle should return to its normal operating condition. If it does not return to its normal operating condition, have a NISSAN dealer check the transmission and repair it if necessary.**



#### **WARNING:**

**When the fail-safe operation occurs, vehicle speed may be gradually reduced. The reduced speed may be lower than other traffic, which could increase the chance of a collision. Be especially careful when driving. If necessary, pull to the side of the road at a safe place and allow the transmission to return to normal operation, or have it repaired if necessary.**

#### DRIVING WITH MANUAL TRANSMISSION (MT)



#### **WARNING:**

- Do not downshift abruptly on slippery roads. This may cause a loss of vehicle control.
- Do not over-rev the engine when shifting to a lower gear. This may cause a loss of vehicle control or engine damage.



#### **CAUTION:**

- Do not rest your foot on the clutch pedal while driving. This may damage the clutch system.
- Fully depress the clutch pedal before shifting to help prevent transmission damage.
- Stop the vehicle completely before shifting into the "R" (Reverse) position.
- When the vehicle is stopped for a period of time, for example waiting at stoplights, shift to the "N" (Neutral) position and release the clutch pedal with the foot brake pedal depressed.
- Do not shift to the "N" (Neutral) position while driving. Doing so may result in an accident due to loss of engine braking.

## Starting vehicle

1. After starting the engine, depress the clutch pedal to the floor and move the shift lever to the "1" (1st) or "R" (Reverse) position.
2. Slowly depress the accelerator pedal, releasing the clutch pedal and parking brake at the same time.

## Shifting gear

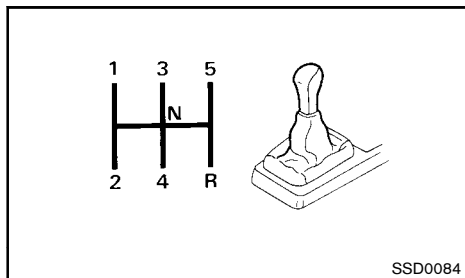

To change gears, or when upshifting or downshifting, fully depress the clutch pedal, shift into the appropriate gear, then slowly and smoothly release the clutch pedal.

To ensure smooth gear changes, fully depress the clutch pedal before operating the shift lever. If the clutch pedal is not fully depressed before the transmission is shifted, a gear noise may be heard. Transmission damage could occur.

Start the vehicle in the "1" (1st) position and shift to the "2" (2nd), "3" (3rd), "4" (4th) and "5" (5th) gear in sequence according to the vehicle speed.

You cannot shift directly from the "5" (5th) position into the "R" (Reverse) position. First shift into the "N" (Neutral) position, then shift into the "R" (Reverse)

position.

If it is difficult to move the shift lever into the "R" (Reverse) or "1" (1st) position, shift to the "N" (Neutral) position, and then release the clutch pedal once. Fully depress the clutch pedal again and shift into "R" or "1".

## Suggested maximum speed in each gear

Downshift to a lower gear if the engine is not running smoothly, or if you need to accelerate.

Do not exceed the maximum suggested speed (shown below) in any gear. For level road driving, use the highest gear suggested for that speed. Always observe posted speed limits, and drive according to the road conditions which will ensure safe operation. Do not over-rev the engine when shifting to a lower gear as it may cause engine damage or loss of vehicle control.

### HR12DE engine model (for Micra Active):

	km/h (MPH)
1st	38 (24)
2nd	69 (43)
3rd	101 (63)
4th	128 (80)
5th	— (—)

### HR12DE engine model (for Thailand, Pakistan, Brunei, Australia and New Zealand):

	km/h (MPH)
1st	43 (27)
2nd	79 (49)
3rd	116 (72)
4th	157 (97)
5th	— (—)

### HR12DE engine model (for Europe):

	km/h (MPH)
1st	51 (32)
2nd	93 (58)
3rd	137 (85)
4th	174 (108)
5th	— (—)

### HR12DE engine model (for Indonesia, Singapore):

	km/h (MPH)
1st	39 (24)
2nd	72 (45)
3rd	105 (66)
4th	143 (89)
5th	— (—)

**HR12DE engine model (for Central and South America, and Caribbean countries):**

	km/h (MPH)
1st	39 (24)
2nd	71 (44)
3rd	105 (65)
4th	142 (88)
5th	— (—)

**HR12DE engine model (except for Thailand, Pakistan, Australia, New Zealand, Europe, Indonesia, Brunei, Singapore, Central and South America, Caribbean countries and Micra Active):**

	km/h (MPH)
1st	47 (29)
2nd	86 (53)
3rd	126 (78)
4th	160 (99)
5th	— (—)

**HR15DE engine model (for South Africa):**

	km/h (MPH)
1st	44 (27)
2nd	79 (49)
3rd	117 (73)
4th	158 (98)
5th	— (—)

**HR15DE engine model (for the Middle East, Lebanon and Jordan):**

	km/h (MPH)
1st	43 (27)
2nd	79 (49)
3rd	116 (72)
4th	157 (97)
5th	— (—)

**HR12DDR engine model (for Europe):**

	km/h (MPH)
1st	47 (29)
2nd	86 (53)
3rd	127 (79)
4th	171 (106)
5th	— (—)

**K9K engine model:**

	km/h (MPH)
1st	36 (22)
2nd	65 (41)
3rd	92 (57)
4th	126 (78)
5th	— (—)

## IDLING STOP SYSTEM (for Hong Kong)

The Idling Stop System activates to prevent unnecessary fuel consumption, exhaust emissions and noise.

- When you stop the vehicle, the engine is turned off automatically.
- When you start the vehicle again, the engine is turned on automatically.



**CAUTION:**

**When the vehicle is moved (at approximately 2 km/h or more) while the engine is stopped by the system, such as on a downhill grade, the engine restarts automatically. To avoid an accident, be sure to depress the brake pedal.**

**NOTE:**

**The Idling Stop System will not activate under the following conditions:**

- when the engine is kept idling without any driving after the engine is turned on.
- when the engine coolant temperature is low.
- when the battery capacity is low.
- when the battery temperature is low or extremely high.
- when the vehicle is moved.
- when a negative pressure booster decreases.
- when the engine hood is opened with the engine running.
- when the engine is turned on with the engine hood open.
- when the driver's seat belt is not fastened.
- when the driver's door is open.
- when the steering wheel is operated.
- when the Idling Stop System indicator blinks at a low speed.

- when the accelerator pedal is depressed.
- when the shift lever is in the “R” (Reverse) position.
- when the fan speed control dial is in any position other than “OFF” (0) while the air flow control dial is in the front defogger position (manual air conditioner).
- when the front defogger switch is on (automatic air conditioner).
- when the rear defogger switch is on.
- when the Idling Stop OFF switch is turned on.
- when the electric power steering warning light, the Anti-lock Braking System (ABS) warning light, or the Vehicle Dynamic Control (VDC) warning light (if equipped) illuminates.
- when the brake pedal is not fully depressed.
- when stopping the vehicle on steep sloping roads.
- when the power consumption is large.
- when the vehicle is traveling at altitudes higher than 2000 m (6562 ft).

**NOTE:**

**It may take some time until the Idling Stop System activates under the following conditions:**

- when the battery is discharged.
- when the outside temperature is low.
- when the battery is replaced or the battery terminal is disconnected for extended periods and then reconnected.

**NOTE:**

**The engine will not restart even if the brake pedal is released while the Idling Stop System is activated under the following condition:**

- when the shift lever is in the “P” (Park) position.

**NOTE:**

**The engine will restart without releasing the brake pedal while the Idling Stop System is activated under the following conditions:**

- when the Idling Stop OFF switch is pushed.
- when the fan speed control dial is in any position other than “OFF” (0) while the air flow control dial is in the front defogger position (manual air conditioner).
- when the front defogger switch is set to “ON” (automatic air conditioner).
- when the rear defogger switch is set to “ON”.
- when the accelerator pedal is depressed.
- when the steering wheel is operated.
- when the battery capacity is low.
- when the power consumption is large.
- when the brake pedal is released on sloping roads and the vehicle is moved.
- when the force to the brake pedal is reduced while the shift lever is in the “D” (Drive) or “N” (Neutral) position.
- when the shift lever is placed in the “L” (Low), “D” (Drive) or “R” (Reverse) position from the “N” or “P” position.
- when the negative pressure of the brake system is not sufficiently applied by depressing the brake pedal several times.
- when the driver’s seat belt is released or the driver’s door is open.

Use this system while waiting at stoplight, etc. When the vehicle is stopped for long periods of time, turn off the engine.

When the engine hood is opened with the Idling Stop

System on, the engine will be in the normal stopped state with the buzzer sounding. In this case, restart the engine with the ignition switch.

When the engine is stopped by the Idling Stop System, heating, cooling and dehumidifying functions will be deactivated. To avoid the air conditioning functions from being deactivated, turn off the Idling Stop mode by pressing the Idling Stop OFF switch.

## OPERATING IDLING STOP SYSTEM

**NOTE:**

**The Idling Stop System indicator light illuminates in the meter while driving if any of the Idling Stop System conditions are met.**

- **When the brake pedal is depressed to stop the vehicle with the shift lever in the “D” (Drive) position, the engine will stop automatically.**
- **When you release your foot from the brake pedal, the engine will start automatically.**
- **The Idling Stop System indicator light and a buzzer will inform you of the Idling Stop System status. For more details, see “Stop/Start System indicator light (if equipped for Europe)/Idling Stop System indicator light (for Hong Kong)” (P.2-18) or “Idling Stop System reminder buzzer (for Hong Kong)” (P.2-19).**

## STOP/START SYSTEM (if equipped for Europe)

The Stop/Start System is designed to prevent unnecessary fuel consumption, exhaust emissions, and noise during a journey:

- When the vehicle comes to rest the engine is automatically stopped.
- The engine is then automatically restarted before you are ready to drive away.



### CAUTION:

**At the end of the journey the engine must be stopped and ignition switch be turned off. Lock the vehicle as normal. Turning the ignition OFF will shut down all electrical systems. Failure to do this may result in a flat battery.**

### NORMAL OPERATION

The Stop/Start System stops the engine and will automatically restart the engine. The Stop/Start indicator light is shown in the meter.

The Stop/Start System will automatically stop the engine when all the following conditions are valid.

For MT model

- The shift lever is in Neutral position.
- The clutch pedal is fully released.
- The vehicle speed is below about 2 km/h (1 MPH).
- The driver's seat belt is fastened.
- The Intelligent Key is in the vehicle.
- The driver's door is closed.

For CVT model

- The shift lever is in the "D" (Drive) or "N" (Neutral) position.

## IDLING STOP OFF SWITCH

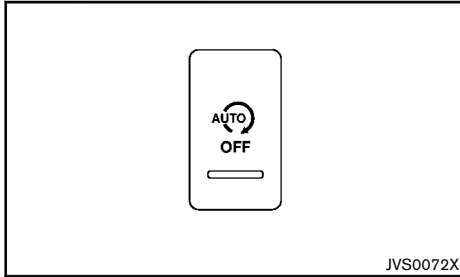

The system can be temporarily deactivated by pressing the Idling Stop OFF switch. Pressing the switch a second time or restarting the engine by using the ignition switch will reactivate the Idling Stop System.

- When the Idling Stop System is deactivated while the engine is running, the engine is prevented from automatically stopping.
- When the Idling Stop System is deactivated after the engine has been automatically stopped by the Idling Stop System, the engine will immediately restart if suitable conditions are present. The engine will then be prevented from automatically stopping during the same journey.
- Whenever the Idling Stop System is deactivated the indicator light on the Idling Stop OFF switch illuminates. In this condition the Idling Stop System cannot prevent unnecessary fuel consumption, exhaust emissions, or noise during your journey.

- The brake pedal is depressed.
- The vehicle is stopped.
- The driver's seat belt is fastened.
- The driver's door is closed.

### NOTE:

**The following conditions must also be satisfied before the engine is automatically stopped. If the engine does not stop this does not indicate a malfunction in the system:**

- The engine coolant temperature is at normal operating levels.
- The vehicle has driven some distance since engine start.
- The battery voltage and temperature are within normal levels.
- The hood is closed.
- The steering wheel is not being turned.
- The system is not in front defogger mode. (automatic air conditioner)
- The mode dial is not in front defogger mode. (manual air conditioner)
- The rear window defogger is not operated.

### NOTE:

**The engine will not restart if the brake pedal is released while the Stop/Start System is activated under the following condition:**

- The shift lever is in the "P" (Park) position (for CVT model).



When the Stop/Start System indicator light is displayed the engine starts running automatically under at least one of the following conditions.

- The clutch pedal is depressed (for MT model).
- The brake pedal is released with the shift lever in the "D"(Drive) or "N"(Neutral) position (for CVT model).
- The shift lever is placed in the "L"(Low), "D"(Drive) or "R"(Reverse) position from the "N" or "P" position (for CVT model).
- The driver's seat belt is unfastened, or the driver's door is open (for CVT model).
- The brake pedal is repeatedly pressed (to maintain vehicle braking performance).
- The brake pedal is strongly depressed and then released with the shift lever in the "P" (Park) position, resulting in decreased vacuum pressure of the brake booster (for CVT model).
- The battery voltage becomes low (due to electrical load from other vehicle systems like headlights, heaters, etc., or auxiliary devices connected to the 12 volt socket inside the vehicle).
- The vehicle speed is above about 2 km/h (1 MPH).
- The system is in front defogger mode. (automatic air conditioner)
- The mode dial is in front defogger mode. (manual air conditioner)
- The rear window defogger is operated.

**NOTE:**

**The following conditions will prevent the Stop/Start System from automatically restarting the engine. Starting the engine by the ignition switch is then necessary:**

**5-22 Starting and driving**

- **The driver's seat belt is unfastened, or driver's door is open (for MT model).**
- **The hood is open.**

The Stop/Start System is always engaged at the start of a journey (once the engine has been started). The engine is automatically stopped and restarted during the journey if conditions are suitable.

**STOP/START SYSTEM DISPLAY AND INDICATORS**

**Engine stop**

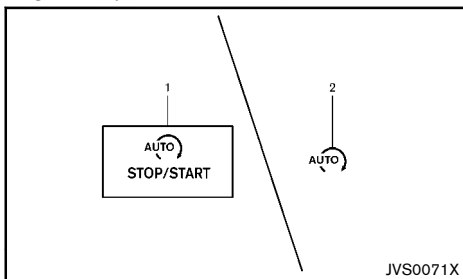

When the engine is stopped the information is displayed for a few seconds.

**Vehicle information display:**

1. Engine stop guidance

**Instrument panel:**

2. Stop/Start System indicator light

About the display, see "Vehicle information display" (P.2-20).

**NOTE:**

**Automatic engine restart is possible whenever the Stop/Start System indicator light is illuminated in the meter.**

**CO2 saved**

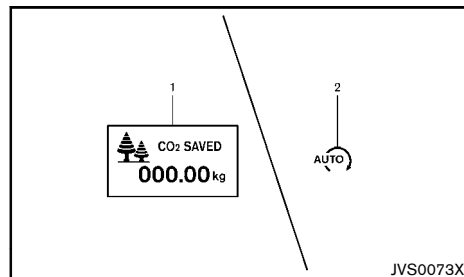

Whilst the engine remains stopped the vehicle information display shows the accumulated quantity (estimate) of carbon dioxide exhaust emissions prevented by the Stop/Start System.

**Vehicle information display:**

1. CO2 saved information

**Instrument panel:**

2. Stop/Start System indicator light

- Push and hold the ● button to reset the [CO2 Saved] value.
- The display can be switched between Stop/Start System information and drive computer information by a short press of the □ button.

## System fault

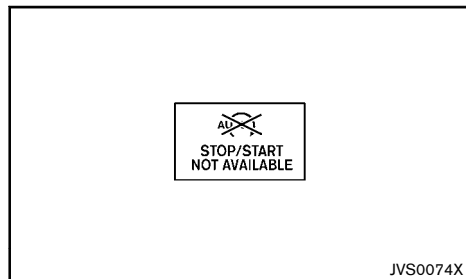

When automatic restart is not possible the information is displayed. The engine must be started by turning or pushing the ignition switch.

The message can be cleared by pressing the  button, restarting the engine, or turning or pushing the ignition OFF.

## Key LOCK warning

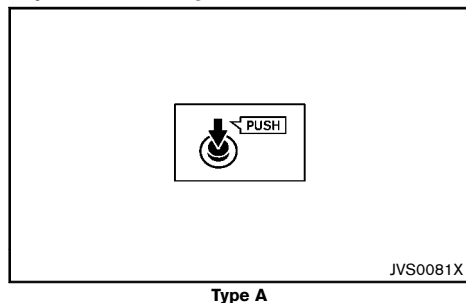

**Type A**

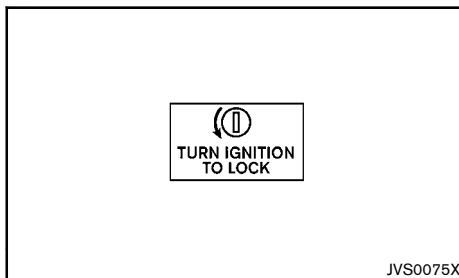

**Type B**

The information is displayed and a buzzer sounded to remind the driver to turn the ignition OFF to avoid a flat battery

The message can only be cleared by turning or pushing the ignition OFF (or restarting the engine).

## PRECAUTIONS ON STOP/START

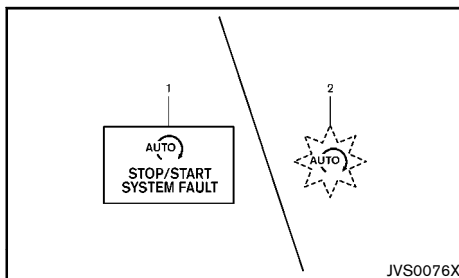

The message is displayed when there may be something wrong with the Stop/Start System. You are advised to have the system checked by a NISSAN dealer or qualified workshop.

## Vehicle information display:

1. System fault warning

## Instrument panel:

2. Stop/Start System indicator light

The message can be cleared by pressing the  button.

## NOTE:

**The Stop/Start System indicator in the meter flashes whilst the fault condition remains.**

## STOP/START SYSTEM OFF SWITCH

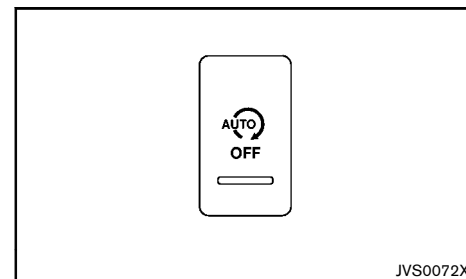

The system can be temporarily disengaged by pressing the Stop/Start System OFF switch. Pressing the button a second time will re-engage the Stop/Start System.

- When the Stop/Start System is disengaged whilst the engine is running, the engine is prevented from automatically stopping.
- When the Stop/Start System is disengaged after the engine has been automatically stopped by the Stop/Start System, the engine will immediately restart if suitable conditions are present as described under NORMAL OPERATION. The engine will then be prevented from automatically

## VEHICLE DYNAMIC CONTROL (VDC) SYSTEM (if equipped except for Europe, Australia and New Zealand)



### WARNING:

- The VDC system is designed to help improve driving stability but does not prevent accidents due to abrupt steering operation at high speeds or due to careless or dangerous driving techniques. Reduce vehicle speed and be especially careful when driving and cornering on slippery surfaces and always drive carefully.
- Do not modify the vehicle's suspension. If suspension parts such as shock absorbers, struts, springs, stabilizer bars, bushings and wheels are not NISSAN-approved or are extremely deteriorated, the VDC system may not operate properly. This could adversely affect vehicle handling performance, and the "VDC OFF" indicator or "SLIP" indicator or both indicator lights may illuminate.
- If brake related parts such as brake pads, rotors and calipers are not standard equipment or are extremely deteriorated, the "VDC OFF" indicator or "SLIP" indicator or both indicator lights may illuminate.
- If engine related parts such as a muffler are not standard equipment or are extremely deteriorated, the "VDC OFF" indicator or "SLIP" indicator or both indicator lights may illuminate.
- When driving on extremely inclined surfaces such as higher banked corners, the VDC system may not operate properly and the "VDC OFF" indicator or "SLIP" indicator or both indicator lights may illuminate. Do not drive on these types of roads.

- When driving on unstable surfaces such as a turntable, ferry, elevator or ramp, the "VDC OFF" indicator or "SLIP" indicator or both indicator lights may illuminate. This is not a malfunction. Restart the engine after driving onto a stable surface.
- If wheels or tires other than those recommended are used, the VDC system may not operate properly and "VDC OFF" indicator or "SLIP" indicator or both indicator lights may illuminate.
- The VDC system is not a substitute for winter tires or tire chains on a snowcovered road.

When accelerating or driving on slippery surfaces, the tires may spin or slide. With the Vehicle Dynamic Control (VDC) system, sensors detect these movements and control the braking and engine output to help improve vehicle stability.

- When the VDC system is operating, the "SLIP" indicator in the instrument panel blinks.
- If the "SLIP" indicator blinks, the road conditions are slippery. Be sure to adjust your speed and driving to these conditions. Be sure to drive carefully. (See "Slip indicator light (if equipped except for Australia and New Zealand)" (P.2-17) and "Vehicle Dynamic Control (VDC) off indicator light" (P.2-18).)
- Indicator light  
If a malfunction occurs in the system, the "SLIP" and "VDC OFF" indicator lights illuminate in the instrument panel. As long as these indicators are illuminated, the VDC system function is canceled.

The VDC system uses a Brake Limited Slip Differential (BLSD) function to improve vehicle traction. The BLSD system works when one of the driving wheels is spinning on a slippery surface. The BLSD system

stopping during the same journey.

- Whenever the Stop/Start System is disengaged the indicator light on the Stop/Start System OFF switch illuminates. In this condition the Stop/Start System cannot prevent unnecessary fuel consumption, exhaust emissions, or noise during your journey.

### NOTE:

The following messages may be displayed for a few seconds in the vehicle information display when the Stop/Start System OFF switch is pressed.

More information about the Stop/Start System can be checked using the [Settings] menu. (About the display, see "Vehicle information display" (P.2-20).)

## VEHICLE DYNAMIC CONTROL (VDC) SYSTEM (for Australia and New Zealand)

brakes the spinning wheel, which distributes the driving power to the other drive wheel. If the vehicle is operated with the VDC OFF switch pushed and the VDC system turned off, all VDC systems will be turned off. The BLSD system will still operate with the VDC system off. If the BLSD system is activated, the "SLIP" indicator light will blink and you may hear a clunk noise and/or feel a pulsation in the foot brake pedal. This is normal and is not an indication of a malfunction. While the VDC system is operating, you may feel a pulsation in the foot brake pedal and hear a noise or feel a vibration from under the hood. This is normal and indicates that the VDC system is working properly.

The VDC system computer has a built-in diagnostic feature that tests the system each time you start the engine and move the vehicle at a low speed forward or backward. When the self-test occurs, you may hear a "clunk" noise and/or feel a pulsation in the foot brake pedal. This is normal and is not an indication of a malfunction.

### VEHICLE DYNAMIC CONTROL (VDC) OFF SWITCH

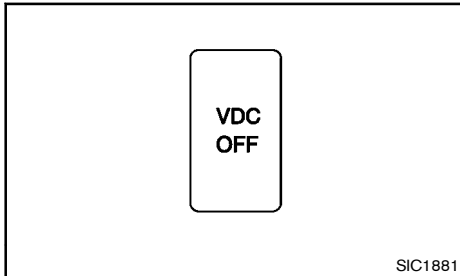

The vehicle should be driven with the Vehicle Dynamic Control (VDC) system ON for most driving conditions.





When the vehicle is stuck in mud or snow, the VDC system reduces the engine output to reduce wheel spin. The engine speed will be reduced even if the accelerator is depressed to the floor. If maximum engine power is needed to free a stuck vehicle, turn the VDC system off.

To turn off the Vehicle Dynamic Control (VDC) system, push the VDC OFF switch. The  indicator light will illuminate.

Push the VDC OFF switch again or restart the engine to turn ON the system.



### WARNING:

- **The VDC system is designed to help the driver maintain stability but does not prevent accidents due to abrupt steering operation at high speeds or by careless or dangerous driving techniques. Reduce vehicle speed and be especially careful when driving and cornering on slippery surfaces and always drive carefully.**
- **Do not modify the vehicle's suspension. If suspension parts such as shock absorbers, struts, springs, stabilizer bars, bushings and wheels are not NISSAN recommended for your vehicle or are extremely deteriorated, the VDC system may not operate properly. This could adversely affect vehicle handling performance, and the VDC warning light  may illuminate.**
- **If brake related parts such as brake pads, rotors and calipers are not NISSAN recommended or are extremely deteriorated, the VDC system may not operate properly and the VDC warning light  may illuminate.**
- **If engine control related parts are not NISSAN recommended or are extremely deteriorated, the VDC warning light  may illuminate.**
- **When driving on extremely inclined surfaces such as higher banked corners, the VDC system may not operate properly and the VDC warning light  may illuminate. Do not drive on these types of roads.**
- **When driving on an unstable surface such as a turntable, ferry, elevator or ramp, the VDC warning light  may illuminate. This is not**

- **a malfunction. Restart the engine after driving onto a stable surface.**
- **If wheels or tires other than the NISSAN recommended ones are used, the VDC system may not operate properly and the VDC warning light  may illuminate.**
- **The VDC system is not a substitute for winter tires or tire chains on a snow covered road.**

The Vehicle Dynamic Control (VDC) system uses various sensors to monitor driver inputs and vehicle motion. Under certain driving conditions, the VDC system helps to perform the following functions.

- Controls brake pressure to reduce wheel slip on one slipping drive wheel so power is transferred to a non slipping drive wheel on the same axle.
- Controls brake pressure and engine output to reduce drive wheel slip based on vehicle speed (traction control function).
- Controls brake pressure at individual wheels and engine output to help the driver maintain control of the vehicle in the following conditions:
  - understeer (vehicle tends to not follow the steered path despite increased steering input)
  - oversteer (vehicle tends to spin due to certain road or driving conditions).



The VDC system can help the driver to maintain control of the vehicle, but it cannot prevent loss of vehicle control in all driving situations.

When the VDC system operates, the VDC warning light  in the instrument panel flashes so note the following:

- The road may be slippery or the system may determine some action is required to help the vehicle on the steered path.

- You may feel a pulsation in the brake pedal and hear a noise or vibration from under the hood. This is normal and indicates that the VDC system is working properly.
- Adjust your speed and driving to the road conditions.

If a malfunction occurs in the system, the VDC warning light  illuminates in the instrument panel. The VDC system automatically turns off.

The VDC OFF switch is used to turn off the VDC system. The VDC off indicator light  illuminates to indicate the VDC system is off. When the VDC OFF switch is used to turn off the system, the VDC system still operates to prevent one drive wheel from slipping by transferring power to a non slipping drive wheel. The VDC warning light  flashes if this occurs. All other VDC functions are off and the VDC warning light  will not flash. The VDC system is automatically reset to on when the ignition switch is placed in the “OFF” position then back to the “ON” position.

See “Vehicle Dynamic Control (VDC) warning light (for Australia and New Zealand)” (P.2-16) and “Vehicle Dynamic Control (VDC) off indicator light” (P.2-18).

The computer has a built-in diagnostic feature that tests the system each time you start the engine and move the vehicle forward or in reverse at a slow speed. When the self-test occurs, you may hear a “clunk” noise and/or feel a pulsation in the brake pedal. This is normal and is not an indication of a malfunction.

## VEHICLE DYNAMIC CONTROL (VDC) OFF SWITCH

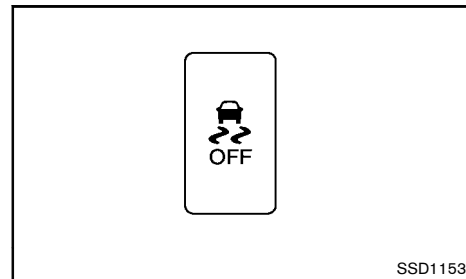

The vehicle should be driven with the Vehicle Dynamic Control (VDC) system ON for most driving conditions.

When the vehicle is stuck in mud or snow, the VDC system reduces the engine output to reduce wheel spin. The engine speed will be reduced even if the accelerator is depressed to the floor. If maximum engine power is needed to free a stuck vehicle, turn the VDC system off.

To turn off the Vehicle Dynamic Control (VDC) system, push the VDC OFF switch. The  indicator light will illuminate.

Push the VDC OFF switch again or restart the engine to turn ON the system.

## ELECTRONIC STABILITY PROGRAM (ESP) SYSTEM (if equipped for Europe)



### WARNING:

- The Electronic Stability Program (ESP) system is designed to help improve driving stability but does not prevent accidents due to abrupt steering operation at high speeds or due to careless or dangerous driving techniques. Reduce vehicle speed and be especially careful when driving and cornering on slippery surfaces and always drive carefully.
- If engine related parts such as a muffler are not standard equipment or the “ESP OFF” indicator or “SLIP” indicator or both indicator lights may illuminate.
- Do not modify the vehicle’s suspension. If suspension parts such as shock absorbers, struts, springs, stabilizer bars and bushings are not NISSAN approved or are extremely deteriorated the ESP system may not operate properly. This could adversely affect vehicle handling performance, and the “ESP OFF” indicator or “SLIP” indicator or both indicator lights may illuminate.
- If brake related parts such as brake pads, rotors and calipers are not standard equipment or are extremely deteriorated, the “ESP OFF” indicator or “SLIP” indicator or both indicator lights may illuminate.
- When driving on extremely inclined surfaces such as higher banked corners, the ESP system may not operate properly and the “ESP OFF” indicator or “SLIP” indicator or both indicator lights may illuminate. Do not drive on these types of roads.

- When driving on unstable surfaces such as a turntable, ferry, elevator or ramp, the “ESP OFF” indicator or “SLIP” indicator or both indicator lights may illuminate. This is not a malfunction. Restart the engine after driving onto a stable surface.
- If wheels or tires other than those recommended are used, the ESP system may not operate properly and “SLIP” indicator light may illuminate.
- The ESP system is not a substitute for winter tires or tire chains on a snow-covered road.
- When the ESP system is operating, the “SLIP” indicator  in the instrument panel blinks.
- If the “SLIP” indicator blinks, the road conditions are slippery. Be sure to adjust your speed and driving to these conditions. Be sure to drive carefully. (See “Slip indicator light (if equipped except for Australia and New Zealand)” (P.2-17) and “Electronic Stability Program (ESP) off indicator light” (P.2-16).)
- Indicator light  
If a malfunction occurs in the system, the “SLIP” and “ESP OFF” indicator lights illuminate in the instrument panel. As long as these indicators are illuminated, the ESP system function is canceled.

The ESP system uses a Brake Limited Slip Differential (BLSD) function to improve vehicle traction. The BLSD system works when one of the driving wheels is spinning on a slippery surface. The BLSD system brakes the spinning wheel, which distributes the driving power to the other drive wheel. If the vehicle is operated with the ESP system turned off, all ESP system functions will be turned off.

The BLSD system and ABS will still operate with the ESP system off. If the BLSD system is activated, the

“SLIP” indicator light will blink and you may hear a clunk noise and/or feel a pulsation in the brake pedal. This is normal and is not an indication of a malfunction.

While the ESP system is operating, you may feel a pulsation in the brake pedal and hear a noise or feel a vibration from under the hood. This is normal and indicates that the ESP system is working properly.

The ESP system computer has a built-in diagnostic feature that tests the system each time you start the engine and move the vehicle at a low speed forward or backward. When the self-test occurs, you may hear a “clunk” noise and/or feel a pulsation in the foot brake pedal. This is normal and is not an indication of a malfunction.

## ELECTRONIC STABILITY PROGRAM (ESP) OFF SWITCH

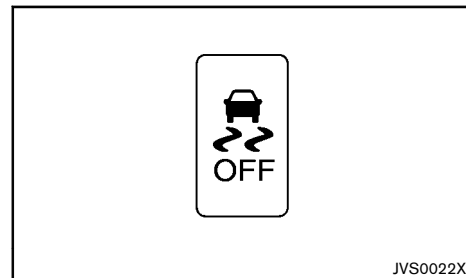

The vehicle should be driven with the Electronic Stability Program (ESP) system on for most driving conditions.

When the vehicle is stuck in mud or snow, the ESP system reduces the engine output to reduce wheel spin. The engine speed will be reduced even if the accelerator is depressed to the floor. If maximum engine power is needed to free a stuck vehicle, turn

the ESP system off.

To turn off the ESP system, push the ESP OFF switch located on the lower side of the instrument panel. The  indicator light will illuminate.

Push the ESP OFF switch again or restart the engine to turn on the system.

## SPEED LIMITER (if equipped for Europe)

The speed limiter allows you to set the desired vehicle speed limit. While the speed limiter is activated, the driver can perform normal braking and acceleration, but the vehicle will not exceed the set speed.



### WARNING:

- **Always observe posted speed limits. Do not set the speed over them.**
- **Always confirm the setting status of the speed limiter on the vehicle information display and instrument panel.**

When the speed limiter is on, the cruise control cannot be operated.

### SPEED LIMITER OPERATIONS

Except for HR12DDR engine model: The speed limiter can be set between 30 km/h and 170 km/h or 20 MPH and 105 MPH.

For HR12DDR engine model (for MT model): The speed limiter can be set between 30 km/h and 180 km/h or 20 MPH and 112 MPH.

For HR12DDR engine model (for CVT model): The speed limiter can be set between 30 km/h and 170 km/h or 20 MPH and 105 MPH.

The speed limiter set switches are located on the steering wheel.

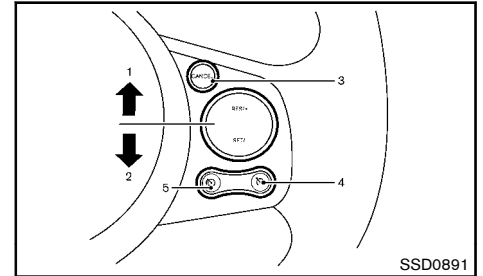

1. RES/+ switch
2. SET/- switch
3. CANCEL switch
4. Cruise control MAIN switch (For details, see "Cruise control" (P.5-30).)
5. Speed limiter MAIN switch

(When this switch is pushed, the speed limiter enters the standby mode. If the cruise control system is on, the system will turn off and the speed limiter enters the standby mode.)

### Speed limiter display and indicators (Type B model)

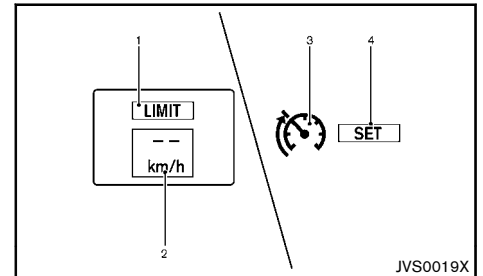

The speed limiter operating condition is shown on the vehicle information display and instrument panel.

#### Vehicle information display:

1. LIMIT indicator
2. Set speed indicator

When the vehicle speed exceeds the set speed limit, the set speed indicator blinks and the accelerator pedal operation will not work until the vehicle speed slows down to the set speed limit.

#### Instrument panel:

3. Speed limiter indicator light
4. SET indicator light

#### The speed limiter will not automatically brake the vehicle to the set speed limit.

Speed limiter display and indicators (Type C model)

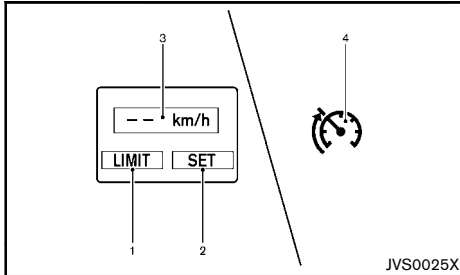

The speed limiter operating condition is shown on the vehicle information display and instrument panel.

#### Vehicle information display:

1. LIMIT indicator
2. SET indicator light
3. Set speed indicator

When the vehicle speed exceeds the set speed limit, the set speed indicator blinks and the accelerator pedal operation will not work until the vehicle speed slows down to the set speed limit.

#### Instrument panel:

4. Speed limiter indicator light

#### The speed limiter will not automatically brake the vehicle to the set speed limit.

#### Turning on speed limiter

Push the speed limiter MAIN switch. The speed limiter indicator (light) and the LIMIT indicators illuminate. The set speed indicator shows "-- --".

#### Setting speed limit

1. Push the SET/- switch.
  - When the vehicle is stopped, the speed will be set at 30 km/h or 20 MPH.
  - While driving, the speed limit will be set at the current speed.
2. When the speed limit is set, the SET (indicator light) and the set speed indicators illuminate on the vehicle information display and instrument panel (for Type B model).

#### Changing set speed limit:

Use either of the following operations to change the speed limit.

- Push and hold the RES/+ or SET/- switch. The set speed will increase or decrease by approximately 10 km/h or 10 MPH.

- Push, then quickly release the RES/+ or SET/- switch. Each time you do this, the set speed will increase or decrease by approximately 1 km/h or 1 MPH.

#### Resuming preset speed limit:

Push the RES/+ switch. The SET indicator (light) illuminates, and the speed limiter will resume the last set speed limit. If the vehicle is driven at a speed over the last set speed limit, the set speed indicator will blink.

#### Canceling speed limit

To cancel the speed limiter, push the CANCEL switch. The SET indicator (light) will turn off. (The set speed indicator will remain on the display.)

If the accelerator pedal is fully depressed (beyond the resistance point), the speed limiter is temporarily suspended and the vehicle speed may be controlled above the set speed. (For Continuously Variable Transmission model: The transmission may downshift into a lower gear). The SET indicator (light) will remain on the instrument panel (for Type B model) or vehicle information display (for Type C model).

If the accelerator pedal returns to the resistance point and the vehicle speed returns to the set speed, the speed limiter will activate and limit vehicle speed.

When one of the following operations is performed, the speed limiter will be canceled. The speed limiter indicator light, and the SET indicator (light) and the LIMIT indicator will turn off. These canceling methods will erase the set speed limit memory.

- Push the speed limiter MAIN switch.
- Push the cruise control MAIN switch.



## CRUISE CONTROL (if equipped)

### Speed limiter malfunction

#### Type B model:

If the speed limiter malfunctions, the SET indicator light on the instrument panel will blink. Turn the speed limiter MAIN switch off and have the system checked by a NISSAN dealer.

#### Type C model:

If the speed limiter malfunctions, the SET indicator on the vehicle information display will blink. Turn the speed limiter MAIN switch off and have the system checked by a NISSAN dealer.



#### WARNING:

- **Always observe the posted speed limits and do not set the speed over them.**
- **Do not use the cruise control when driving under the following conditions. Doing so could cause a loss of vehicle control and result in an accident.**
  - **When it is not possible to keep the vehicle at a constant speed**
  - **When driving in heavy traffic**
  - **When driving in traffic that varies speed**
  - **When driving in windy areas**
  - **When driving on winding or hilly roads**
  - **When driving on slippery (rain, snow, ice, etc.) roads**



#### CAUTION:

**On manual Transmission (MT) model, do not shift to the “N” (Neutral) position without depressing the clutch pedal when the cruise control is operated. Should this occur, depress the clutch pedal and turn the cruise control MAIN switch off immediately. Failure to do so may cause engine damage.**

### PRECAUTIONS ON CRUISE CONTROL

- If the cruise control system malfunctions, it cancels automatically. The SET indicator and the cruise control indicator light will blink to warn the driver.
- If the engine coolant temperature becomes excessively high, the cruise control system will be canceled automatically.
- If the SET indicator and cruise control indicator light blink, turn off the cruise control MAIN switch and have the system checked by a NISSAN dealer.
- The SET indicator and cruise control indicator light may blink when the cruise control MAIN switch is turned on while pushing the RES+, SET -, CANCEL switch. To properly set the cruise control system, use the following procedures.

### CRUISE CONTROL OPERATIONS

The cruise control allows driving at speeds above 40 km/h (25 MPH) without keeping your foot on the accelerator pedal.

The cruise control will automatically be canceled if the vehicle slows down more than approximately 13 km/h (8 MPH) below the set speed.

Moving the shift lever to the “N” (Neutral) position (Continuously Variable Transmission model) or depressing the clutch pedal (Manual Transmission model) will cancel the cruise control and the SET indicator will turn off.

The cruise control switches are located on the steering wheel.

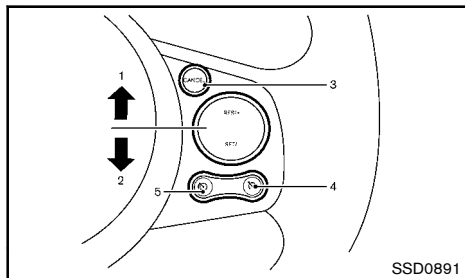

1. RES/+ switch
2. SET/- switch
3. CANCEL switch
4. Cruise control MAIN switch
5. Speed limiter MAIN switch (For details, see "Speed limiter (if equipped for Europe)" (P.5-28).)

#### Cruise control display and indicators (Type B model)

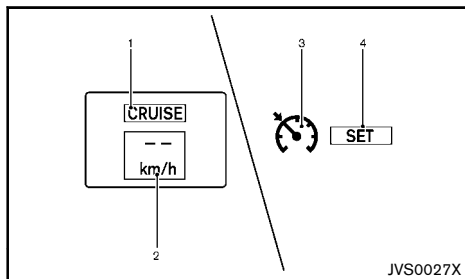

The cruise control operating condition is shown on the vehicle information display and instrument panel.

#### Vehicle information display:

1. CRUISE indicator
2. Set speed indicator

#### Instrument panel:

3. Cruise control indicator light
4. SET indicator light

#### Cruise control display and indicators (Type C model)

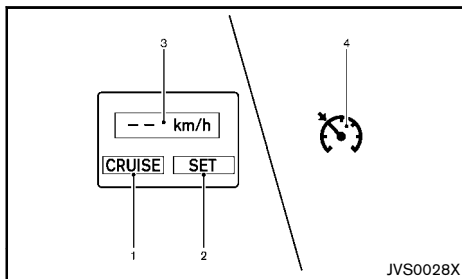

#### Vehicle information display:

1. CRUISE indicator
2. SET indicator light
3. Set speed indicator light

#### Instrument panel:

4. Cruise control indicator light

#### Turning on cruise control

Push the cruise control MAIN switch. The cruise control indicator light illuminates. The set speed indicator shows "--".

#### Setting cruising speed

1. Accelerate to the desired speed.
2. Push the SET- switch and release it.
3. The SET indicator light and set speed indicator illuminate on the meter panel and the vehicle information display.
4. Take your foot off the accelerator pedal. The vehicle will maintain the set speed.

#### Passing another vehicle:

Depress the accelerator pedal to accelerate. After releasing the accelerator pedal, the vehicle will return to the previously set speed.

The vehicle may not maintain the set speed when going up or down steep hills. In such cases, drive without the cruise control.

#### Resetting to slower speed:

Use any one of the following methods to reset to a slower speed.

- Lightly tap the foot brake pedal. When the vehicle reaches the desired speed, push and release the SET- switch.
- Push and hold the SET- switch. When the vehicle reaches the desired speed, release the SET- switch.
- Quickly push and release the SET- switch. This will reduce the vehicle speed by about 1 km/h or 1 MPH.

#### Resetting to faster speed:

Use any one of the following methods to reset to a faster speed.

- Depress the accelerator pedal. When the vehicle reaches the desired speed, push and release the SET- switch.

## PARKING



### WARNING:

- **Do not stop or park the vehicle over flammable materials such as dry grass, waste paper or rags. They may ignite and cause a fire.**
- **Safe parking procedures require that both the parking brake be applied and the shift lever placed in the “P” (Park) position (Automatic Transmission model/Continuously Variable Transmission model) or the shift lever placed in an appropriate gear (Manual Transmission model). Failure to do so could cause the vehicle to move unexpectedly or roll away and result in an accident.**
- **When parking the vehicle, make sure the shift lever is moved to the “P” (Park) position. The shift lever cannot be moved out of the “P” (Park) position without depressing the foot brake pedal (Automatic Transmission model/Continuously Variable Transmission model).**
- **Never leave the engine running while the vehicle is unattended.**
- **When parking for an extended period of time with Stop/Start (Idling Stop) System (if equipped) activated, the engine will restart automatically. Never leave the vehicle with the ignition switch in the “ON” position.**
- **Never leave children or adults who would normally require the support of others alone in the vehicle. Pets should not be left alone either. They could unknowingly activate switches or controls and inadvertently become involved in a serious accident and**

**injure themselves. On hot, sunny days, temperatures in a closed vehicle could quickly become high enough to cause severe or possibly fatal illness to people and animals.**

- Push and hold the RES+ switch. When the vehicle reaches the desired speed, release the RES+ switch.
- Quickly push and release the RES+ switch. This will increase the vehicle speed by about 1 km/h or 1 MPH.

### Resuming at preset speed:

Push and release the RES+ switch.

The vehicle will resume the last set cruising speed when the vehicle speed is over 40 km/h (25 MPH).

### Canceling cruising speed

Use any one of the following methods to cancel the set speed.

- Push the CANCEL switch. The SET indicator light will turn off.
- Tap the foot brake pedal. The SET indicator light will turn off.
- Push the cruise control MAIN switch. Both the SET and cruise indicator lights turn off.

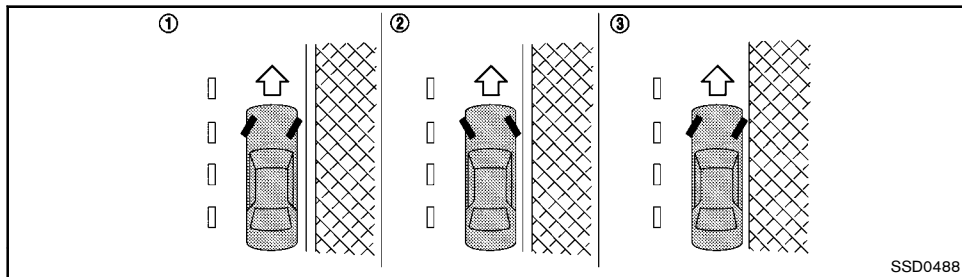

**Left-Hand Drive (LHD) model**

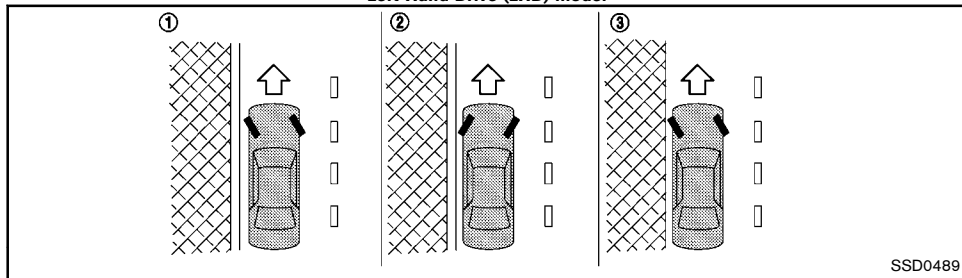

**Right-Hand Drive (RHD) model**

1. Firmly apply the parking brake.
2. Automatic Transmission (AT)/Continuously Variable Transmission (CVT) model: Move the shift lever to the "P" (Park) position.  
Manual Transmission (MT) model: Move the shift lever to the "R" (Reverse) position. When parking on an uphill grade, move the shift lever to the "1" (1st) position.
3. To help prevent the vehicle from moving into traffic when parked on an incline, it is a good practice to turn the wheels as illustrated.

**HEADED DOWNHILL WITH CURB ①**

Turn the wheels into the curb and move the vehicle forward until the curb side wheel gently touches the curb. Then apply the parking brake.

**HEADED UPHILL WITH CURB ②**

Turn the wheels away from the curb and allow the vehicle to move back until the curb side wheel gently touches the curb. Then apply the parking brake.

**HEADED UPHILL OR DOWNHILL, WITHOUT CURB ③**

Turn the wheels toward the side of the road so the vehicle will move away from the center of the road if the vehicle moves. Then apply the parking brake.

**4. Model with Intelligent Key system:**

Place the ignition switch in the "OFF" position.

**Model without Intelligent Key system:**

Place the ignition switch in the "LOCK" position and remove the key.

**NOTE:**

**For Model with Stop/Start (Idling Stop) System:**  
**Use this system when the vehicle is stopped for a period of time, for example waiting at stoplights.**

**Stop the engine with the ignition switch when parking, etc. for an extended period of time.**

## SONAR (parking sensor) SYSTEM (if equipped)

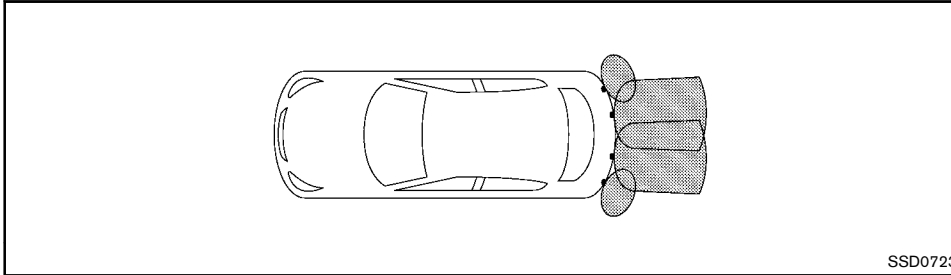

### WARNING:

- The sonar (parking sensor) system is a convenience but it is not a substitute for proper parking. Always look around and check that it is safe to do so before parking. Always move slowly.
- Read and understand the limitations of the sonar (parking sensor) system as contained in this section. Inclement weather may affect the function of the sonar (parking sensor) system; this may include reduced performance or a false activation.
- This system is not designed to prevent contact with small or moving objects.
- The system is designed as an aid to the driver in detecting large stationary objects to help avoid damaging the vehicle. The system will not detect small objects below the bumper, and may not detect objects close to the bumper or on the ground.
- If your vehicle sustains damage to the bumper fascia, leaving it misaligned or bent, the sensing zone may be altered causing

inaccurate measurement of obstacles or false alarms.

### CAUTION:

Keep the interior of the vehicle as quiet as possible to hear the tone clearly.

When the ignition switch is in the "ON" position, the sonar (parking sensor) system is operational.

The sonar (parking sensor) system sounds a tone to warn the driver of obstacles near the bumper. The parking sensor indicator will also appear in the vehicle information display. (See "Parking Sensor Indicator" (P.5-34)). The system detects rear obstacles when the shift lever is in the "R" (Reverse) position. The system may not detect objects at speeds above 10 km/h (6 MPH) and may not detect certain angular or moving objects.

The sonar (parking sensor) system detects obstacles up to 1 m (3.3 ft) from the bumper with a decreased coverage area at the outer corners of the bumper, (refer to the illustration for approximate zone coverage areas). As you move closer to the obstacle, the rate of the tone increases. When the obstacle is less than 30

cm (11.8 in) away, the tone will sound continuously.

Keep the sonar sensors (located on the bumper fascia) free from snow, ice and large accumulations of dirt (do not clean the sensors with sharp objects). If the sensors are covered, it will affect the accuracy of the sonar (parking sensor) system.

**If the sonar (parking sensor) system malfunctions, the beep sounds for 3 seconds when the shift lever is moved to the "R" (Reverse) position. Have the system checked by a NISSAN dealer.**

## PARKING SENSOR INDICATOR

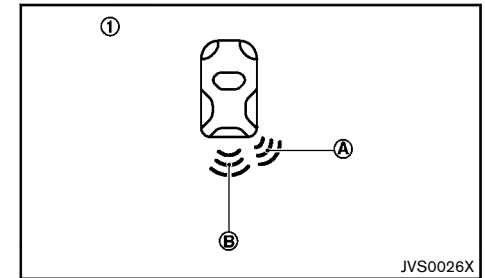

① Parking sensor display

Ⓐ Corner sensor indicator

Ⓑ Center sensor indicator

With the sonar (parking sensor) system ON in the "R" (Reverse) position, when the corner/center sensors (sonar) detect obstacles near the bumper, a tone will sound and the parking sensor indicator will appear in the vehicle information display ① .

The parking sensor indicators Ⓐ and Ⓑ indicate the position of the object and the distance to the object with the rate of blinking.

When an object is detected, the indicator appears and

blinks (the tone sounds intermittently). When the vehicle moves closer to the object, the number of bars decreases and the rate of blinking increases (the rate of the tone increases). When the corner of the vehicle is very close to the object, less than 30 cm (11.8 in) away, the number of bars decreases and the indicator stops blinking (the tone sounds continuously).

## PARKING SPACE MEASUREMENT OPERATION (if equipped)

### System operation

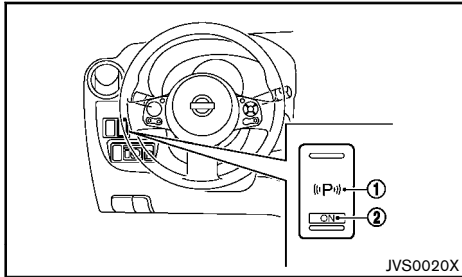

#### Parking space measurement switch

- ① Parking space measurement switch
- ② ON indicator light

The system is intended to help the driver parallel park easily. When the system is activated by pressing the switch, it informs the driver of parallel parking availability.

Press the switch ① to turn on the parking space measurement system.

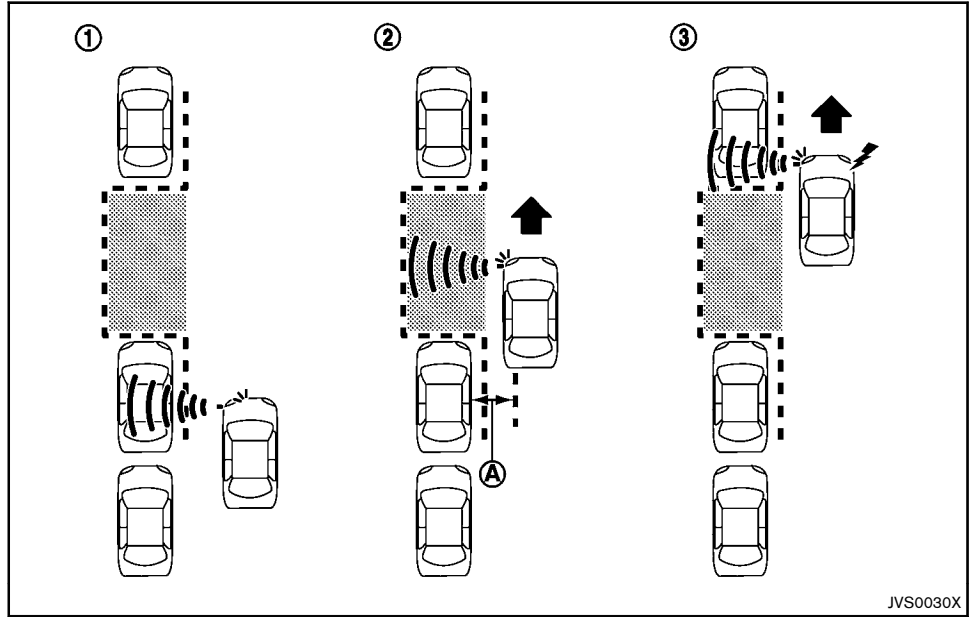

JVS0030X

1. Select left or right to parallel park by operating the turn signal switch.
2. Drive the vehicle alongside the cars you will parallel park between at approximately 15 km/h (9 MPH). Maintain approximately a one meter distance between your vehicle and the one next to your vehicle as illustrated ① .
3. When the parking space is measured, a beep sounds.

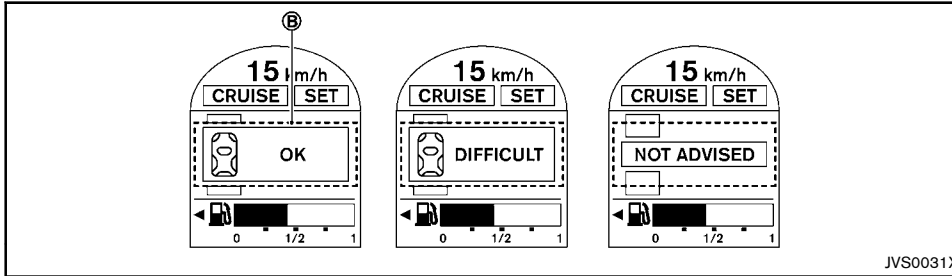

#### Measurement result:

The display indicating the measurement result (B) ("OK", "DIFFICULT" or "NOT ADVISED") will appear in the meter as illustrated.

#### CAUTION:

- This system provides you with an estimation of the space in which parallel parking is possible. Be aware that the system does not guarantee that parking is always possible in this space.
- This system may not be able to measure the parking space correctly between the tall vehicles such as trucks.
- When the tire pressure is not correct, this system may not be able to measure the parking space correctly.
- When replacing a tire with one other than a genuine NISSAN tire (the same size as the original tire), have your vehicle adjusted by NISSAN dealer. If genuine NISSAN tires are not used, the system cannot guarantee accurate measurement of the parking space.

- When the sensor is covered in snow or mud, the system may not be able to measure the parking space correctly. Always keep your sensor clean.

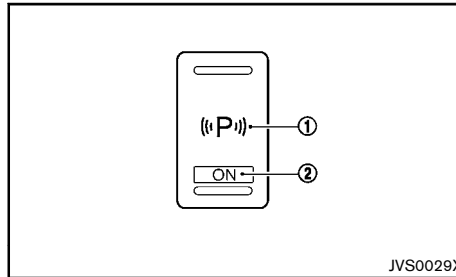

- ① Parking space measurement switch
- ② ON indicator light

#### Setting the level mode:

Depending on your driving level, the modes can be selected from the following.

- Amateur

- Normal
- Expert

To set the mode, perform the following procedure:

1. Push and hold the parking space measurement switch (1) for at least 5 seconds. The buzzer then sounds for 5 seconds.
2. Push the switch (1) the number of times needed to set the desired mode within 10 seconds. After 10 seconds, the buzzer sounds the number of times previously pushed.

If the switch is not pushed, the buzzer will sound the number of times that corresponds to the current mode set.

The mode can be selected to "Amateur", "Normal" and "Expert" by pushing the switch once to three times while the buzzer sounds as follows:

- Push the switch once to select Amateur mode.
- Push the switch two times to select Normal mode.
- Push the switch three times to select Expert mode.

Each mode indicates the size of space in which parking is possible as follows:

- The Amateur mode indicates the largest parking space.
- The Normal mode indicates the medium parking space.
- The Expert mode indicates the smallest parking space.

## TRAILER TOWING

Your vehicle was designed to be used to carry passengers and luggage. NISSAN does not recommend trailer towing, because it places additional loads on your vehicle's engine, drivetrain, steering, braking, and other systems.



### CAUTION:

**Vehicle damage resulting from towing a trailer is not covered by the warranty.**

## System malfunction

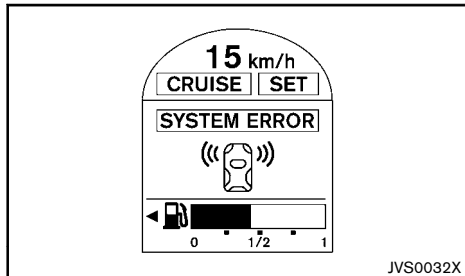

If the "SYSTEM ERROR" display appears and/or the ON indicator light on the parking space measurement switch blinks, have the system checked by a NISSAN dealer.

## ELECTRIC POWER STEERING SYSTEM



### WARNING:

- **If the engine is not running or is turned off while driving, the power assist for the steering will not work. The steering will be harder to operate.**
- **When the electric power steering warning light illuminates with the engine running, the power assist for the steering will cease operation. You will still have control of the vehicle but the steering will be harder to operate.**

The electric power steering system is designed to provide power assist while driving to operate the steering wheel with light force.

When the steering wheel is operated repeatedly or continuously while parking or driving at a very low speed, the power assist for the steering wheel will be reduced. This is to prevent overheating of the electric power steering system and protect it from getting damaged. While the power assist is reduced, steering wheel operation will become heavy. When the temperature of the electric power steering system goes down, the power assist level will return to normal. Avoid repeating such steering wheel operations that could cause the electric power steering system to overheat.

You may hear a fricative sound when the steering wheel is operated quickly. However, this is not a malfunction.

If the electric power steering warning light **PS** illuminates while the engine is running, it may indicate the electric power steering system is not functioning properly and may need servicing. Have the electric power steering system checked by a NISSAN dealer. (See "Electric power steering warning light" (P.2-14).)



## BRAKE SYSTEM

When the electric power steering warning light illuminates with the engine running, the power assist for the steering will cease operation. You will still have control of the vehicle. However, greater steering effort is needed, especially in sharp turns and at low speeds.

The brake system has two separate hydraulic circuits. If one circuit malfunctions, you will still have braking ability at two wheels.

### BRAKE PRECAUTIONS

#### Vacuum assisted brakes

The brake booster aids braking by using engine vacuum. If the engine stops, you can stop the vehicle by depressing the foot brake pedal. However, greater foot pressure on the foot brake pedal will be required to stop the vehicle. The stopping distance will be longer.

If the engine is not running or is turned off while driving, the power assisted brakes will not function. Braking will be harder.



#### **WARNING:**

#### **Do not coast with the engine stopped.**

When the brake pedal is depressed slowly and firmly, you may hear a clicking noise and feel a slight pulsation. This is normal and indicates that the Brake Assist System is operating.

#### Using brakes

Avoid resting your foot on the foot brake pedal while driving. This will overheat the brakes, wear out the brake linings/pads faster, and increase fuel consumption.

To help reduce brake wear and to prevent the brakes from overheating, reduce speed and downshift to a lower gear before going down a slope or long grade. Overheated brakes may reduce braking performance and could result in loss of vehicle control.

While driving on a slippery surface, be careful when braking, accelerating or downshifting. Abrupt braking

or acceleration could cause the wheels to skid and result in an accident.

#### Wet brakes

When the vehicle is washed or driven through water, the brakes may get wet. As a result, your braking distance will be longer and the vehicle may pull to one side during braking.

To dry the brakes, drive the vehicle at a safe speed while lightly depressing the foot brake pedal to heat up the brakes. Do this until the brakes return to normal. Avoid driving the vehicle at high speeds until the brakes function correctly.

#### Driving uphill

When starting on a steep grade, it is sometimes difficult to operate both the brake and clutch (for Manual Transmission model). Apply the parking brake to hold the vehicle. Do not slip the clutch. When ready to start, slowly release the parking brake while depressing the accelerator pedal and releasing the clutch pedal.

#### Driving downhill

The engine braking action is effective for controlling the vehicle while descending hills. For Manual Transmission (MT) model, the shift lever should be placed in the lower speed position prior to descending. For Automatic Transmission (AT) model, the "1" or "2" position should be selected. For Continuously Variable Transmission (CVT) model, the "L" position should be selected.

## ANTI-LOCK BRAKING SYSTEM (ABS) (if equipped)

### BRAKE ASSIST (if equipped)

When the force applied to the brake pedal exceeds a certain level, the Brake Assist is activated, generating greater braking force than a conventional brake booster even with light pedal force.



#### WARNING:

The Brake Assist is only an aid to assist braking operation and is not a collision warning or avoidance device. It is the driver's responsibility to stay alert, drive safely and be in control of the vehicle at all times.



#### WARNING:

- **The Anti-lock Braking System (ABS) is a sophisticated device, but it cannot prevent accidents resulting from careless or dangerous driving techniques. It can help maintain vehicle control during braking on slippery surfaces. Remember that stopping distances on slippery surfaces will be longer than on normal surfaces even with ABS. Stopping distances may also be longer on rough, gravel or snow covered roads, or if you are using tire chains. Always maintain a safe distance from the vehicle in front of you. Ultimately, the driver is responsible for safety.**
- **Tire type and condition may also affect braking effectiveness.**
  - **When replacing tires, install the specified size of tires on all four wheels.**
  - **When installing a spare tire, make sure that it is the proper size and type as specified on the tire placard. (See "Tire placard" (P.9-10).)**
  - **For detailed information, see "Tires and wheels" (P.8-42).**

The Anti-lock Braking System (ABS) controls the brakes so the wheels do not lock during hard braking or when braking on slippery surfaces. The system detects the rotation speed at each wheel and varies the brake fluid pressure to prevent each wheel from locking and sliding. By preventing each wheel from locking, the system helps the driver maintain steering control and helps to minimize swerving and spinning on slippery surfaces.

### USING SYSTEM

Depress the brake pedal and hold it down. Depress the brake pedal with firm steady pressure, but do not pump the brakes. The ABS will operate to prevent the wheels from locking up. Steer the vehicle to avoid obstacles.



#### WARNING:

**Do not pump the brake pedal. Doing so may result in increased stopping distances.**

### SELF-TEST FEATURE

The ABS includes electronic sensors, electric pumps, hydraulic solenoids and a computer. The computer has a built-in diagnostic feature that tests the system each time you start the engine and move the vehicle at a low speed in forward or reverse. When the self-test occurs, you may hear a "clunk" noise and/or feel a pulsation in the brake pedal. This is normal and does not indicate a malfunction. If the computer senses a malfunction, it switches the ABS off and illuminates the ABS warning light on the instrument panel. The brake system then operates normally, but without anti-lock assistance.

If the ABS warning light illuminates during the self-test or while driving, have the vehicle checked by a NISSAN dealer.

## VEHICLE SECURITY

### NORMAL OPERATION

The ABS operates at speeds above 5 to 10 km/h (3 to 6 MPH). The speed varies according to road conditions.

When the ABS senses that one or more wheels are close to locking up, the actuator rapidly applies and releases hydraulic pressure. This action is similar to pumping the brakes very quickly. You may feel a pulsation in the brake pedal and hear a noise from under the hood or feel a vibration from the actuator when it is operating. This is normal and indicates that the ABS is operating properly. However, the pulsation may indicate that road conditions are hazardous and extra care is required while driving.

When leaving your vehicle unoccupied:

- Always take the key with you - even when leaving the vehicle in your own garage.
- Close all windows completely and lock all doors.
- Always park your vehicle where it can be seen. Park in a well lit area during the night.
- If the security system is equipped, use it - even for a short period.
- Never leave children or pets in the vehicle unattended.
- Never leave valuables inside the vehicle. Always take valuables with you.
- Never leave the vehicle documents in the vehicle.
- Never leave articles on a roof rack. Remove them from the rack and keep and lock them in a safe place such as inside the back door.
- Never leave the spare key in the vehicle.

## COLD WEATHER DRIVING



### WARNING:

- **Whatever the condition, drive with caution. Accelerate and decelerate with great care. If accelerating or decelerating too fast, the drive wheels will lose even more traction.**
- **Allow more stopping distance in cold weather driving. Braking should be started sooner than on dry pavement.**
- **Keep at a greater distance from the vehicle in front of you on slippery roads.**
- **Wet ice (0°C, 32°F and freezing rain), very cold snow and ice can be slick and very difficult to drive on. The vehicle will have a lot less traction or grip under these conditions. Try to avoid driving on wet ice until the road is salted or sanded.**
- **Watch for slippery spots (glaring ice). These may appear on an otherwise clear road in shaded areas. If a patch of ice is seen ahead, brake before reaching it. Try not to brake while actually on the ice, and avoid any sudden steering maneuvers.**
- **Do not use cruise control on slippery roads.**
- **Snow can trap dangerous exhaust gas under your vehicle. Keep snow clear of the exhaust pipe and from around your vehicle.**

## BATTERY

If the battery is not fully charged during extremely cold weather conditions, the battery fluid may freeze and damage the battery. To maintain maximum efficiency, the battery should be checked regularly. For details, see "Battery" (P.8-24).

## ENGINE COOLANT

If the vehicle is to be left outside without anti-freeze, drain the cooling system, including the engine block. Refill before operating the vehicle. For details, see "Changing engine coolant" (P.8-10).

## TIRE EQUIPMENT

1. If you have snow tires installed on the front/rear wheels of your vehicle, they should be of the same size, loading range, construction and type (bias, bias-belted or radial) as the rear/front tires.
2. If the vehicle is to be operated in severe winter conditions, snow tires should be installed on all four wheels.
3. For additional traction on icy roads, studded tires may be used. However, some countries, provinces and states prohibit their use. Check local, state and provincial laws before installing studded tires.  
**Skid and traction capabilities of studded snow tires, on wet or dry surfaces, may be poorer than that of non-studded snow tires.**
4. Snow chains may be used if desired. Make sure they are the proper size for the tires on your vehicle and are installed according to the chain manufacturer's instructions. (See "Tire chains" (P.8-42).)

## SPECIAL WINTER EQUIPMENT

It is recommended that the following items be carried in the vehicle during the winter:

- A scraper and stiff-bristled brush to remove ice and snow from the windows.
- A sturdy, flat board to be placed under the jack to give it firm support.
- A shovel to dig the vehicle out of snowdrifts.

## PARKING BRAKE

When parking in the area where the outside temperature is below 0°C (32°F), do not apply the parking brake to prevent it from freezing. For safe parking:

- Place the shift lever in the "P" (Park) position (Automatic Transmission (AT)/Continuously Variable Transmission (CVT) model).
- Place the shift lever in the "1" (1st) or "R" (Reverse) position (Manual Transmission (MT) model).
- Securely block the wheels.

## CORROSION PROTECTION

Chemicals used for road surface deicing are extremely corrosive and will accelerate corrosion and the deterioration of underbody components such as the exhaust system, fuel and brake lines, brake cables, floor pan and fenders.

**In the winter, the underbody must be cleaned periodically. For additional information, see "Corrosion protection" (P.7-5).**

For additional protection against rust and corrosion, which may be required in some areas, consult a NISSAN dealer.

**MEMO**

# 6 In case of emergency

Hazard indicator flasher switch .....	6-2	Jump starting .....	6-9
Flat tire .....	6-2	Push starting .....	6-10
Stopping vehicle .....	6-2	If your vehicle overheats .....	6-11
Preparing tools .....	6-2	Towing your vehicle .....	6-11
Changing flat tire (for model with spare tire) .....	6-3	Towing precautions .....	6-11
Repairing flat tire (for model with emergency tire puncture repair kit) .....	6-6	Towing recommended by NISSAN .....	6-12

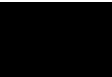

## HAZARD INDICATOR FLASHER SWITCH

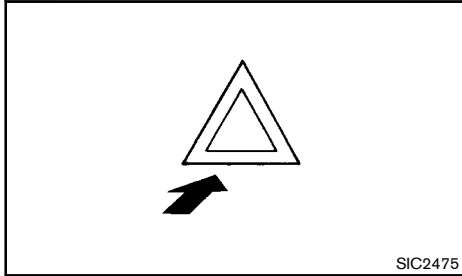

The hazard indicator flasher switch operates with the ignition switch in any position except when the battery is discharged.

The hazard indicator flasher is used to warn other drivers when you have to stop or park under emergency conditions.

When the hazard indicator flasher switch is pushed, all turn signal lights will flash. To turn off the hazard indicator flasher, push the hazard indicator flasher switch again.

## FLAT TIRE

If you have a flat tire, follow the instructions as follows.

### STOPPING VEHICLE



#### WARNING:

- **Be sure to apply the parking brake firmly.**
- **Be sure to move the shift lever to the "R" (Reverse) position (Manual Transmission (MT) model).**
- **Be sure to move the shift lever to the "P" (Park) position. (Automatic Transmission (AT)/Continuously Variable Transmission (CVT) model)**
- **Never change tires when the vehicle is on a slope, ice or slippery area. This is hazardous.**
- **Never change tires when the oncoming traffic is close to your vehicle. Call for professional road assistance.**

1. Safely move the vehicle off the road away from traffic.
2. Turn on the hazard indicator flasher lights.
3. Park on a level surface.
4. Apply the parking brake.
5. Automatic Transmission (AT)/Continuously Variable Transmission (CVT) model: Move the shift lever to the "P" (Park) position.

Manual Transmission (MT) model: Move the shift lever to the "R" (Reverse) position.

6. Turn off the engine.
7. Open the hood and set up the warning triangle (if equipped):
  - To warn other traffic.

- To signal professional road assistance personnel that you need assistance.
8. Have all passengers get out from the vehicle and stand in a safe place, away from other traffic and clear of the vehicle.

### PREPARING TOOLS

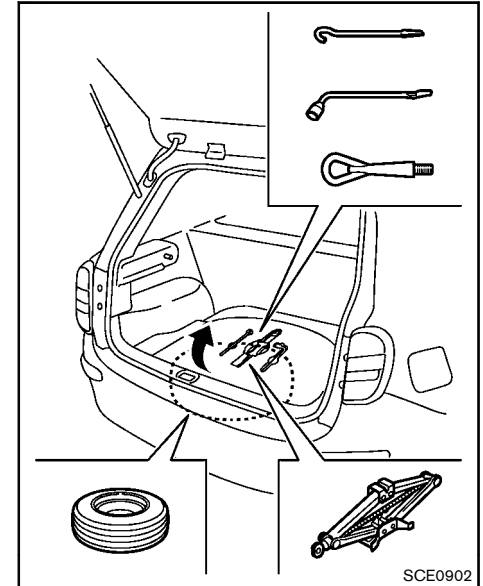

Raise the back door floor cover.

Your vehicle is equipped with either a spare tire or an emergency tire puncture repair kit. Carefully read the instructions provided in the appropriate section.

- For model with spare tire: See “Changing flat tire (for model with spare tire)” (P.6-3).
- For model with emergency tire puncture repair kit: See “Repairing flat tire (for model with emergency tire puncture repair kit)” (P.6-6).

### CHANGING FLAT TIRE (for model with spare tire)

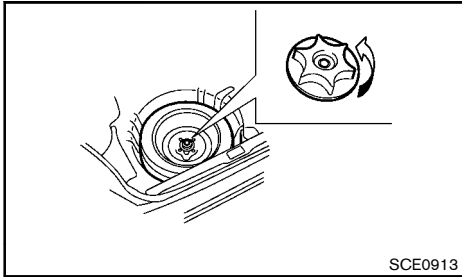

Remove the jack, necessary tools and the spare tire from the storage area.

If spacers are equipped, remove them before removing the spare tire.

### Blocking wheels

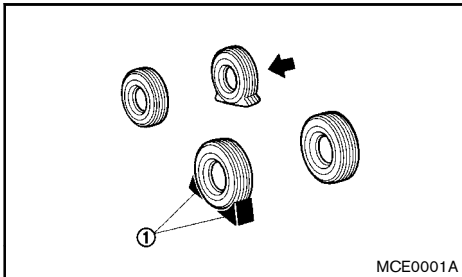

### **WARNING:**

**Be sure to block the appropriate wheel to prevent the vehicle from moving, which may cause personal injury.**

Place suitable blocks ① at both the front and back of the wheel diagonally opposite the flat tire ← to prevent the vehicle from moving when it is jacked up.

### Removing wheel cover

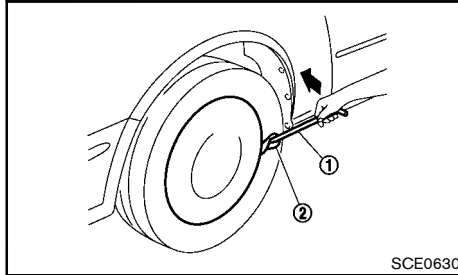

**Type A**

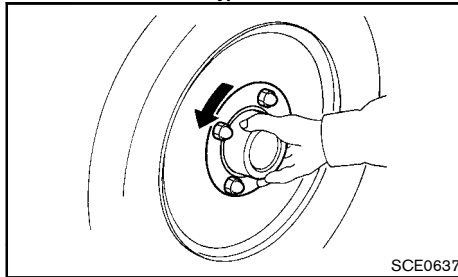

**Type B**

### **Type A:**

### **WARNING:**

**Never use your hands to remove the wheel cover. This may cause personal injury.**

To remove the wheel cover, use the jack rod ① as illustrated.

Apply cloth ② between the wheel and jack rod to prevent damaging the wheel and wheel cover.

### **Type B:**

Remove the center wheel cap as illustrated.

### Removing tire

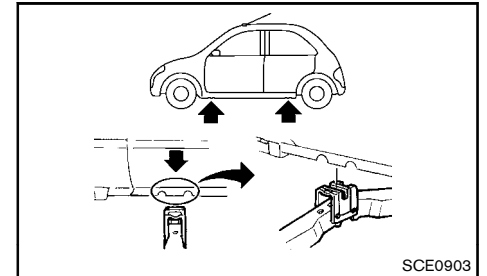

**Jack-up points**



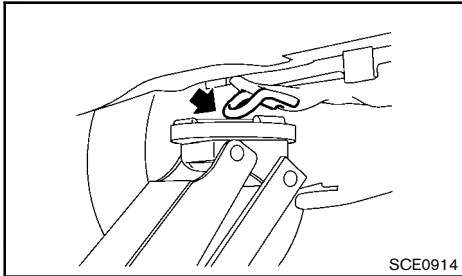

**Floor jack-up point (rear)**

For the rear, never jack up the vehicle at a location other than the floor jack-up point that is specified.



**WARNING:**

- **Be sure to read and follow the instructions in this section.**
- **DO NOT GET UNDER A VEHICLE THAT IS SUPPORTED BY A JACK.**
- **Never use a jack which was not provided with your vehicle.**
- **The jack, which is provided with your vehicle, is designed only to lift your vehicle during a tire change. Do not use the jack provided with your vehicle on other vehicles.**
- **Never jack up the vehicle at a location other than the jack-up point that is specified.**
- **Never lift the vehicle more than necessary.**
- **Never use blocks on or under the jack.**
- **Never start or run the engine while the vehicle is on the jack. The vehicle may move suddenly, and this may cause an accident.**

- **Never allow passengers to remain in the vehicle while the tire is off the ground.**
- **Be sure to read the caution label attached to the jack body before using.**

## Jacking up vehicle

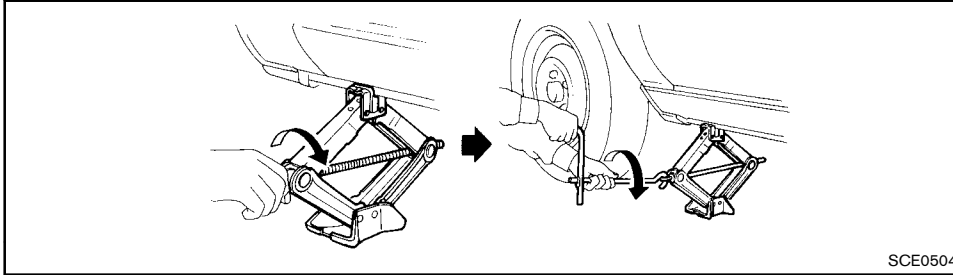

1. Place the jack directly under the jack-up point as illustrated so that the top of the jack contacts the vehicle at the jack-up point.

**The jack should be placed on firm level ground.**

2. Align the jack head between the two notches located at the jack-up point of either the front or the rear section.
3. Fit the groove of the jack head between the notches as shown.
4. Loosen each wheel nut, counterclockwise, one or two turns with the wheel nut wrench.

**Do not remove the wheel nuts until the tire is off the ground.**

5. Carefully raise the vehicle until the clearance between the tire and ground is achieved.
6. To lift the vehicle, securely hold the jack lever and rod with both hands and turn the jack lever.

## Removing tire

1. Remove the wheel nuts.
2. Remove the damaged tire.



### CAUTION:

**The tire is heavy. Be sure that your feet are clear from the tire and use gloves as necessary to avoid injury.**

## Installing spare tire

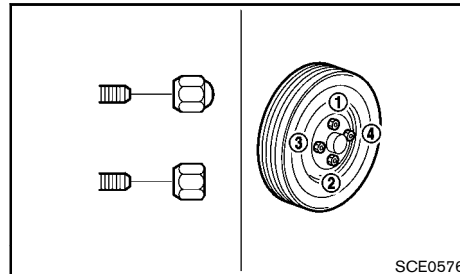

### WARNING:

- **Never use wheel nuts which are not provided with your vehicle. Incorrect wheel nuts or improperly tightened wheel nuts may cause the wheel to become loose or come off. This could cause an accident.**
- **Never use oil or grease on the wheel studs or nuts. This may cause the wheel nuts to become loose.**
- **The temporary-use spare tire is designed for emergency use only.**

1. Clean any mud or dirt from the surface between the wheel and hub.
2. Carefully put the spare tire on and tighten the wheel nuts with your fingers. Check that all the wheel nuts contact the wheel surface horizontally.
3. Tighten the wheel nuts alternately and evenly, more than 2 times in the sequence illustrated (① - ④), with the wheel nut wrench, until they are tight.
4. Lower the vehicle slowly until the tire touches the ground.
5. Tighten the wheel nuts securely, with the wheel nut wrench, in the sequence illustrated.
6. Lower the vehicle completely.

**Tighten the wheel nuts to the specified torque with a torque wrench as soon as possible.**

**Wheel nut tightening torque:  
108 N-m (11 kg-m, 80 ft-lb)**

**The wheel nuts must be kept tightened to specification at all times. It is recommended that the wheel nuts be tightened to specification at each lubrication interval.**

**WARNING:**

Retighten the wheel nuts when the vehicle has been driven for 1,000 km (600 miles). (also in cases of a flat tire, etc.)

Stowing damaged tire and tools

**WARNING:**

- Be sure that the tire, jack and tools used are properly stored after use. Such items can become dangerous projectiles in an accident or sudden stop.
  - The temporary-use spare tire is designed for emergency use only.
1. Securely store the damaged tire, jack and tools used in the storage area.
  2. Replace the spare tire cover and the floor cover.
  3. Close the back door.

**REPAIRING FLAT TIRE** (for model with emergency tire puncture repair kit)

The emergency tire puncture repair kit is supplied with the vehicle instead of a spare tire. This repair kit must be used for temporarily fixing a minor tire puncture. After using the repair kit, see a NISSAN dealer as soon as possible for tire inspection and repair/replacement.

**CAUTION:**

- NISSAN recommends using only Genuine NISSAN Emergency Tire Sealant provided with your vehicle. Other tire sealants may damage the valve stem seal which can cause the tire to lose air pressure.

- Do not use the emergency tire puncture repair kit provided with your vehicle on other vehicles.
- Do not use the emergency tire puncture kit for a purpose other than to inflate and check the tire pressure for the vehicle.
- Use the emergency tire puncture kit only on DC12V.
- Keep water and dust off the emergency tire puncture kit.
- Do not disassemble or modify the emergency tire puncture kit.
- Do not galvanize the emergency tire puncture kit.
- Do not use the emergency tire puncture repair kit under the following conditions. Contact a NISSAN dealer or professional road assistance.
  - when the sealant has passed its expiration date (shown on the label attached to the bottle)
  - when the cut or the puncture is approximately 6 mm (0.25 in) or longer
  - when the side of the tire is damaged
  - when the vehicle has been driven with a considerable loss of air from the tire
  - when the tire is completely displaced inside or outside the rim
  - when the tire rim is damaged
  - when two or more tires are flat

Getting emergency tire puncture repair kit

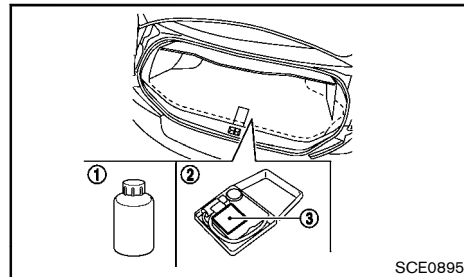

Take out the emergency tire puncture repair kit from the back door. The repair kit consists of the following items:

- ① Tire sealant bottle
- ② Air compressor
- ③ Speed restriction sticker

Before using emergency tire puncture repair kit

- If any foreign object (for example, a screw or nail) is embedded in the tire, do not remove it.
- Check the expiration date of the sealant (shown on the label attached to the bottle). Never use a sealant whose expiration date has passed.

Repairing tire

**WARNING:**

Observe the following precautions when using the emergency tire puncture kit.

- Swallowing the compound is dangerous. Immediately drink as much water as possible and seek prompt medical assistance.

- Rinse well with lots of water if the compound comes into contact with skin or eyes. If irritation persists, seek prompt medical attention.
- Keep the repair compound out of the reach of children.
- The emergency repair compound may cause a malfunction of the air valve. Have the air valve replaced as soon as possible.

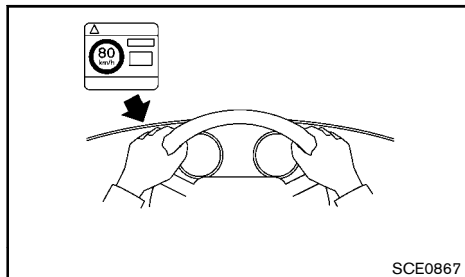

1. Open the lid of the air compressor and take out the speed restriction sticker, then put it in a location where the driver can see it while driving.



**CAUTION:**

Do not put the speed restriction label on the steering wheel pad, the speedometer or the warning light locations.

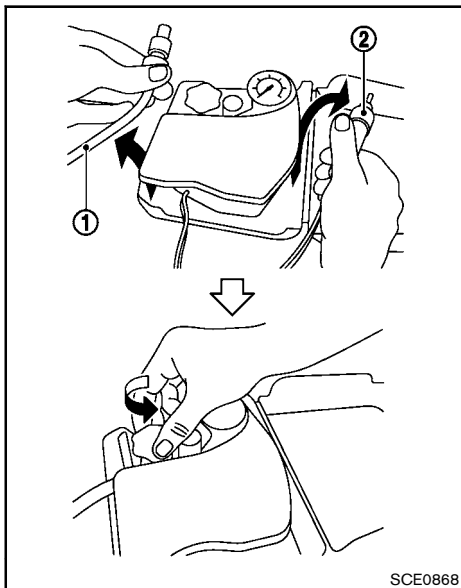

2. Take the hose ① and the power plug ② out of the air compressor. Remove the cap of the bottle holder from the air compressor.

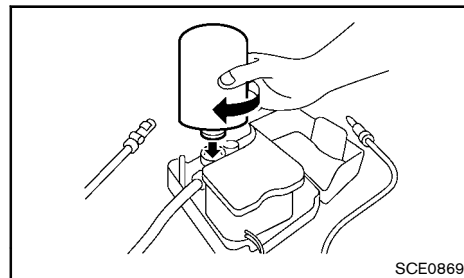

3. Remove the cap of the tire sealant bottle, and screw the bottle clockwise onto the bottle holder. (Leave the bottle seal intact. Screwing the bottle onto the bottle holder will pierce the seal of the bottle.)

4. Remove the cap of the tire valve on the flat tire.

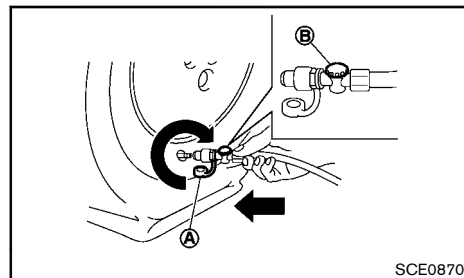

5. Remove the protective cap (A) of the hose and screw the hose securely onto the tire valve. Make sure that the pressure release valve (B) is securely tightened. Make sure that the air compressor switch is in the OFF (○) position, and then insert its power plug into the power outlet in the vehicle.

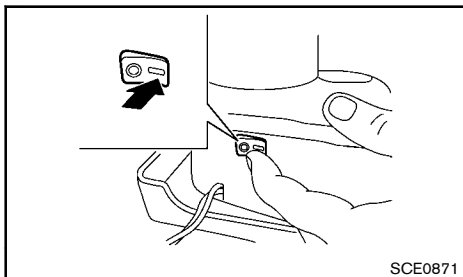

6. Push the ignition switch to the "ACC" position. Then turn the compressor switch to the ON (-) position and inflate the tire up to the pressure that is specified on the tire placard affixed to the driver's side center pillar if possible, or to the minimum of 180 kPa (26 psi). Turn the air compressor off briefly in order to check the tire pressure with the pressure gauge.

If the tire is inflated to higher than the specified pressure, adjust the tire pressure by releasing air with the pressure release valve. The cold tire pressures are shown on the tire placard affixed to the driver's side center pillar.

**CAUTION:**

- **An incomplete connection between the hose and tire valve causes air leakage or sealant scatter.**
- **Do not stand directly beside the damaged tire while it is being inflated because of the risk of the rupture. If there are any cracks or bumps, turn the compressor off immediately.**

- **There is a possibility that the pressure reaches 600 kPa while the tire is being inflated, but it is normal condition. Usually the pressure will drop in about 30 seconds.**
- **Do not operate the compressor for more than 10 minutes.**

**If the tire pressure does not increase to 180 kPa (26 psi) within 10 minutes, the tire may be seriously damaged and the tire cannot be repaired with this tire repair kit. Contact a NISSAN dealer.**

7. When the tire pressure is reaching the specified pressure or is at the minimum of 180 kPa (26 psi), turn the air compressor off. Remove the power plug from the power outlet and quickly remove the hose from the tire valve. Attach the protective cap and valve cap.

**CAUTION:**

**Leave the tire sealant bottle on the bottle holder in order to prevent sealant from spilling out.**

8. Immediately drive the vehicle for 10 minutes or 3 km (2 miles) at a speed of 80 km/h (50 MPH) or less.
9. After driving, make sure that the air compressor switch is in the OFF position, then screw the hose securely onto the tire valve. Check the tire pressure with the pressure gauge. The temporary repair is completed if the tire pressure does not drop.

Make sure the pressure is adjusted to the pressure that is specified on the tire placard before driving.

10. If the tire pressure drops, repeat the steps from 5. If the pressure drops again or under 130 kPa (19 psi), the tire cannot be repaired with this tire repair kit. Contact a NISSAN dealer.

**CAUTION:**

**Do not reuse the tire sealant bottle or the hose.**

**For a new tire sealant bottle and hose, see a NISSAN dealer.**

After repairing tire

See a NISSAN dealer for tire repair/replacement as soon as possible.

## JUMP STARTING

### WARNING:

- Incorrect jump starting can lead to a battery explosion. The battery explosion may result in severe injury or death. It may also result in damage to the vehicle. Be sure to follow the instructions in this section.
- Explosive hydrogen gas is always present in the vicinity of the battery. Keep all sparks and flames away from the battery.
- Always wear suitable eye protection and remove rings, bracelets, and any other jewelry whenever working on or near a battery.
- Never lean over the battery while jump starting.
- Never allow battery fluid to come into contact with eyes, skin, clothes or the vehicle's painted surfaces. Battery fluid is a corrosive sulfuric acid which can cause severe burns. If the fluid comes into contact with anything, immediately flush the contacted area with plenty of water.
- Keep the battery out of the reach of children.
- The booster battery must be rated at 12 volts. Use of an incorrectly rated battery will damage your vehicle.
- Never attempt to jump start a frozen battery. It could explode and cause serious injury.

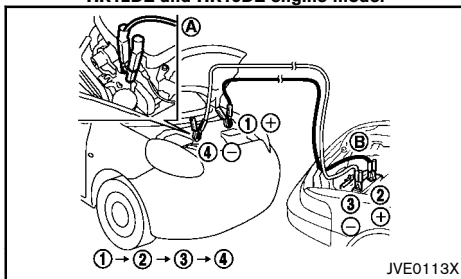
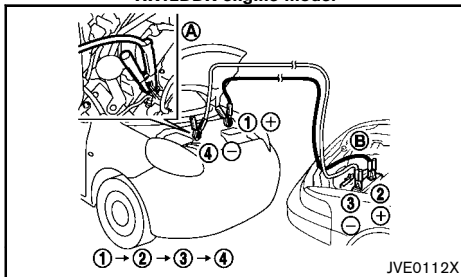
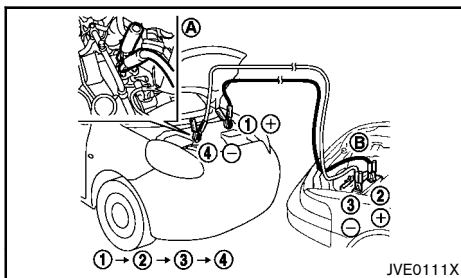

1. If the booster battery is in another vehicle (B), position the two vehicles (A) and (B) to bring the batteries into close proximity to each other.

### CAUTION:

If the battery of vehicle (A) equipped with the Intelligent Key system is discharged, the ignition switch cannot be moved from the "LOCK" position and, if the steering lock is engaged, the steering wheel cannot be moved. Connect the jumper cables to the booster vehicle (B) before turning the ignition switch and disengaging the steering lock.

2. Apply the parking brake.
3. Automatic Transmission (AT)/Continuously Variable Transmission (CVT) model: Move the shift lever to the "P" (Park) position.  
Manual Transmission (MT) model: Move the shift lever to the "N" (Neutral) position.
4. Switch off all unnecessary electrical systems (headlights, heater, air conditioner, etc.).
5. Turn the ignition switch to the "LOCK" position.
6. Remove the vent caps, if equipped, on the battery.
7. Cover the battery with a firmly wrung out moist cloth to reduce the hazard of an explosion.
8. Connect the jumper cables in the sequence as illustrated (1, 2, 3, 4).

### CAUTION:

- Always connect positive ⊕ to positive ⊕ and negative ⊖ to body ground, NOT to the battery's negative ⊖.

- **Be sure that the jumper cables do not touch moving parts in the engine compartment.**
  - **Be sure that the jumper cable's clamps do not contact any other metal.**
9. Start the engine of the booster vehicle (B) and let it run for a few minutes.
  10. Depress the accelerator pedal of the booster vehicle (B) at about 2,000 rpm.
  11. Start the engine of the jumped vehicle (A) in the normal manner.



#### CAUTION:

- **Never keep the starter motor engaged for more than 10 seconds. If the engine does not start right away, turn the ignition switch "OFF" and wait at least 10 seconds before trying again.**
  - **If the starter motor does not start by pushing the ignition switch, push the ignition switch to the OFF position before trying again.**
12. After the engine is started, carefully disconnect the jumper cables in the opposite sequence from that illustrated ((4), (3), (2), (1)).
  13. Remove and dispose of the cloth as it may be contaminated with corrosive acid.
  14. Replace the vent caps, if removed.

#### NOTE:

- **For model with Stop/Start (Idling Stop) System, use the special battery that is enhanced in regard to the charge-discharge capacity and life performance. Avoid using a non-special battery for the Stop/Start (Idling Stop) system, as this may cause early**

**deterioration of the battery or a malfunction of the Stop/Start (Idling Stop) system. For the battery, it is recommended to use Genuine NISSAN parts. For more information, contact a NISSAN dealer.**

- **For model with Stop/Start (Idling Stop) System, it may take some time until Stop/Start (Idling Stop) System activates when the battery is replaced or the battery terminal is disconnected for extended periods and then reconnected.**

## PUSH STARTING

Do not attempt to start the engine by pushing the vehicle.



#### CAUTION:

- **Automatic Transmission (AT)/Continuously Variable Transmission (CVT)/Manual Transmission (MT) model cannot be started by pushing. Attempting to do so may cause damage to the transmission.**
- **Three-way catalyst equipped model should not be started by pushing. Attempting to do so may cause damage to the catalyst.**
- **Never try to start the engine by towing. When the engine starts, the forward surge could cause the vehicle to collide with the towing vehicle.**
- **Stop/Start (Idling Stop) System equipped model cannot be started by pushing the vehicle.**

## IF YOUR VEHICLE OVERHEATS



### WARNING:

- **Never continue driving if your vehicle overheats. Doing so could cause a vehicle fire.**
- **Never open the hood if steam is coming out.**
- **Never remove the radiator cap while the engine is hot. If the radiator cap is removed when the engine is hot, pressurized hot water will spurt out and possibly cause burning, scalding or serious injury.**
- **If steam or coolant is coming from the engine, stand clear of the vehicle to prevent getting burned.**
- **Be careful not to allow your hands, hair, jewelry or clothing to come into contact with, or to get caught in the cooling fan or drive belts. The engine cooling fan will start at any time.**

If your vehicle is overheating (indicated by the high temperature indicator), or if you feel a lack of engine power, detect unusual noise, etc., take the following steps:

1. Safely move the vehicle off the road away from traffic.
2. Turn on the hazard indicator flasher lights.
3. Apply the parking brake.
4. Automatic Transmission (AT)/Continuously Variable Transmission (CVT) model: Move the shift lever to the "P" (Park) position.  
Manual Transmission (MT) model: Move the shift lever to the "N" (Neutral) position.

**DO NOT STOP THE ENGINE.**

5. Open all windows.
6. Turn off the air conditioner. Set the temperature control to maximum hot and fan control to maximum speed.
7. Get out from the vehicle.
8. Visually inspect and listen for steam or coolant escaping from the radiator before opening the hood. Wait until no steam or coolant can be seen before proceeding.
9. Open the engine hood.
10. Visually inspect if the cooling fan is running.
11. Visually inspect the radiator and radiator hoses for leakage.  
If the cooling fan is not running or the coolant is leaking, stop the engine.
12. After the engine cools down, check the coolant level in the reservoir with the engine running. **Do not open the radiator cap.**
13. Add coolant to the reservoir if necessary.

Have your vehicle inspected/repared at a NISSAN dealer.

## TOWING YOUR VEHICLE

When towing your vehicle, local regulations for towing must be followed. Incorrect towing equipment could damage your vehicle. To assure proper towing and to prevent accidental damage to your vehicle, NISSAN recommends that you have professional road assistance personnel tow your vehicle. It is advisable to have the professional road assistant carefully read the following precautions.

### TOWING PRECAUTIONS

- Be sure that the transmission, steering system and powertrain are in working condition before towing. If any units are damaged, the vehicle must be towed using a dolly or flatbed tow truck.
- NISSAN recommends that your vehicle be towed with the driving (front) wheels off the ground.



## TOWING RECOMMENDED BY NISSAN

### Towing Two-Wheel Drive (2WD) model

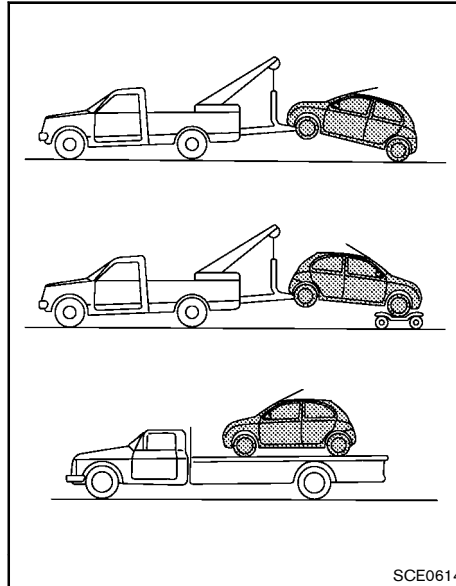
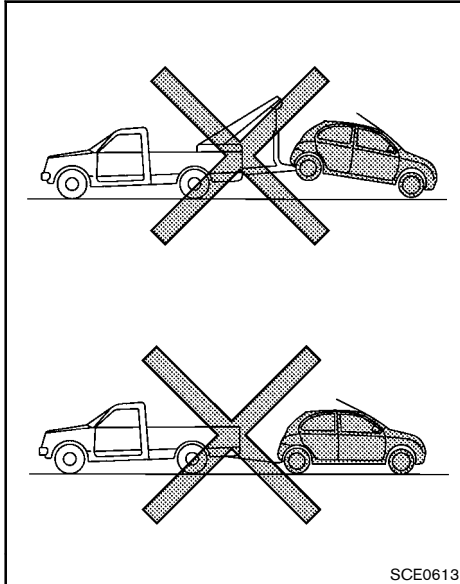

NISSAN recommends that towing dollies be used under the front wheels when towing your vehicle or the vehicle be placed on a flatbed tow truck as illustrated.

#### Front wheels on the ground:



#### CAUTION:

**Never tow Automatic Transmission (AT)/Continuously Variable Transmission (CVT) model with the front wheels on the ground. Doing so will cause serious and expensive damage to the drivetrain.**

Manual Transmission (MT) model:

1. Place the ignition switch in the "OFF" position.
2. Secure the steering wheel in a straight-ahead position with rope or a similar device.
3. Move the shift lever to the "N" (Neutral) position.
4. Release the parking brake.
5. Attach safety chains whenever towing.

#### Rear wheels on the ground:

1. Place the ignition switch to the "OFF" position.
2. Secure the steering wheel in a straight-ahead position with rope or a similar device.
3. Move the shift lever to the "N" (Neutral) position.
4. Release the parking brake.
5. Attach safety chains whenever towing.

#### All four wheels on the ground:



#### CAUTION:

**Never tow AT/CVT model with all four wheels on the ground. Doing so will cause serious and expensive damage to the transmission.**

Manual Transmission (MT) model:

1. Place the ignition switch in the "OFF" position.
2. Move the shift lever to the "N" (Neutral) position.
3. Release the parking brake.

## Freeing trapped vehicle

### **WARNING:**

- **Never allow anyone to stand near the towing line during the pulling operation.**
- **Never spin the tires at high speed. This could cause them to explode and result in serious injury. Parts of the vehicle could also overheat and be damaged.**
- **Do not pull the vehicle using the rear hook. The rear hook is not designed to pull the vehicle out in the event that the vehicle becomes trapped.**

In the event that your vehicle's tires become trapped in sand, snow, or mud, and the vehicle is unable to free itself without being pulled, use the recovery hooks.

- Use the recovery hooks only. Do not attach the pulling device to any other part of the vehicle body. Otherwise, the vehicle body may be damaged.
- Use the recovery hooks to free a vehicle only. Never tow a vehicle using only the recovery hooks.
- The recovery hooks are under tremendous stress when used to free a trapped vehicle. Always pull the pulling device straight out from the vehicle. Never pull on the recovery hooks at an angle.

Front:

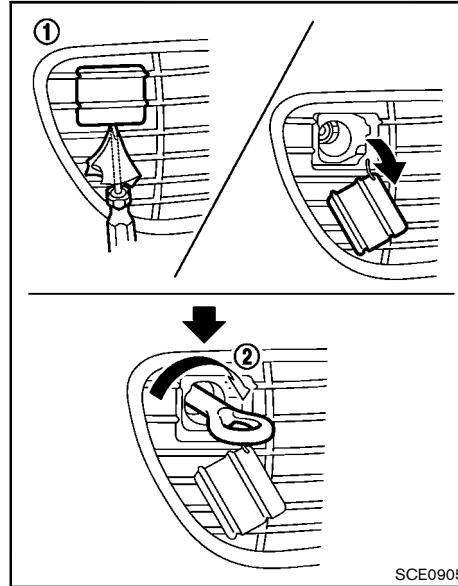

**Type A (except for Sports version)**

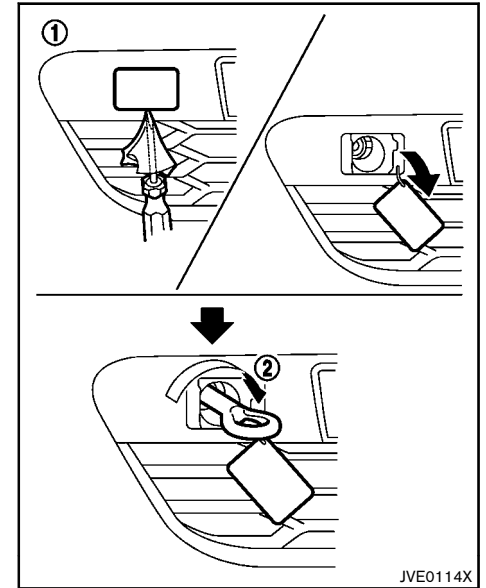

**Type B (except for Sports version)**

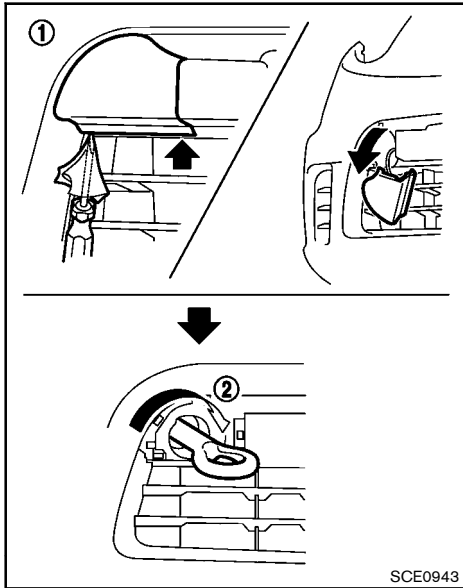

**Type C (for Sports version)**

- ① Remove the hook cover from the bumper with a suitable tool.
- ② Securely install the recovery hook as illustrated. (The hook is stored with the jacking tools.)

Make sure that the recovery hook is properly secured in its storage area after use.

**Rear:**

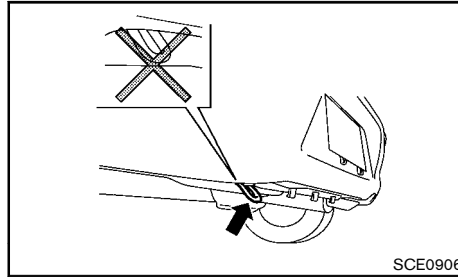

**Rear**

Do not use the hook to tow the vehicle.

# 7 Appearance and care

Cleaning exterior .....	7-2	Cleaning interior .....	7-3
Washing .....	7-2	Air fresheners .....	7-4
Removing spots .....	7-2	Floor mats .....	7-4
Waxing .....	7-2	Glass .....	7-4
Glass .....	7-2	Seat belts .....	7-4
Underbody .....	7-3	Corrosion protection .....	7-5
Wheels .....	7-3	Most common factors contributing to vehicle corrosion .....	7-5
Aluminum alloy wheels .....	7-3	Environmental factors influence rate of corrosion .....	7-5
Chrome parts .....	7-3	To protect your vehicle from corrosion .....	7-5



## CLEANING EXTERIOR

In order to maintain the appearance of your vehicle, it is important to take proper care of it.

Whenever possible, park your vehicle inside a garage or in a covered area to minimize the chances of damaging the paint surface of your vehicle.

When it is necessary to park outside, park in a shady area or protect the vehicle with a body cover. **Be careful not to scratch the paint surface when putting on or removing the body cover.**

### WASHING

In the following instances, wash your vehicle as soon as possible to protect the paint surface:

- After a rainfall, which may cause the paint surface damage from acid rain.
  - After driving on coastal roads, which may cause rusting from the sea breeze.
  - When contaminants such as soot, bird droppings, tree sap, metal particles or bugs get on the paint surface.
  - When dust or mud builds up on the paint surface.
1. Wash the vehicle surface with a wet sponge and plenty of water.
  2. Clean the vehicle surface gently and thoroughly using a mild soap, a special vehicle soap or a general purpose dishwashing liquid mixed with clean, lukewarm (never hot) water.



#### CAUTION:

- **Do not wash the vehicle with strong household soap, strong chemical detergents, gasoline or solvents.**
- **Do not wash the vehicle in direct sunlight or while the vehicle body is hot, as the paint surface may become water-spotted.**

- **Avoid using tight-napped or rough cloths, such as washing mitts. Care must be taken when removing caked-on dirt or other foreign substances so the paint surface is not scratched or damaged.**

3. Rinse the vehicle thoroughly with plenty of clean water.
4. Use a dampened chamois to dry the paint surface and avoid leaving water spots.

When washing the vehicle, take care of the following:

- Inside flanges, joints and folds on the doors, hatches and hood are particularly vulnerable to the effects of road salt. Therefore, these areas must be cleaned regularly.
- Be sure that the drain holes in the lower edge of the doors are not clogged.
- Spray water to the underbody and in the wheel wells to loosen the dirt and/or wash away road salt.

### REMOVING SPOTS

Remove tar and oil spots, industrial dust, insects, and tree sap as quickly as possible from the paint surface to avoid lasting damage or staining. Special cleaning products are available at a NISSAN dealer or any automotive accessory store.

## WAXING

Regular waxing protects the paint surface and helps maintain a new vehicle appearance.

After waxing, polishing is recommended to remove built-up residue and to avoid a weathered appearance.

A NISSAN dealer can assist you in choosing the appropriate waxing products.



#### CAUTION:

- **Wash your vehicle thoroughly and completely before applying wax to the paint surface.**
- **Always follow the manufacturer's instructions supplied with the wax.**
- **Do not use a wax containing any abrasives, cutting compounds or cleaners that may damage the vehicle finish.**

Machine compounding or aggressive polishing on a base coat/clear coat paint finish may dull the finish or leave swirl marks.

### GLASS

Use glass cleaner to remove smoke and dust film from the glass surfaces. It is normal for glass to become coated with a film after the vehicle is parked in the hot sun. Glass cleaner and a soft cloth will easily remove this film.

## UNDERBODY

In areas where road salt is used in the winter, it is necessary to clean the vehicle's underbody regularly in order to prevent dirt and salt from building up and causing the acceleration of corrosion on the underbody and suspension.

Before the winter and again in the spring, the underseal must be checked and, if necessary, re-treated.

## WHEELS

- Wash the wheels when washing the vehicle to maintain their appearance.
- Clean the inner side of the wheels when the wheel is changed or the underside of the vehicle is washed.
- Do not use abrasive cleaners when washing the wheels.
- Inspect wheel rims regularly for dents or corrosion. This may cause loss of pressure or damage the tire bead.
- NISSAN recommends that the road wheels be waxed to protect against road salt in areas where it is used during winter.

## ALUMINUM ALLOY WHEELS

Wash the wheels regularly with a sponge dampened in a mild solution, especially during winter in areas where road salt is used.

The salt residue from road salt could discolor the wheels if it is not washed off regularly.



### CAUTION:

**Follow the directions below to avoid staining or discoloring the wheels:**

- **Do not use a cleaner that uses strong acid or alkali contents to clean the wheels.**
- **Do not apply wheel cleaners to the wheels when they are hot. The wheel temperature should be the same as ambient temperature.**
- **Rinse the wheel to completely remove the cleaner within 15 minutes after the cleaner is applied.**

## CHROME PARTS

Clean all chrome parts regularly with a nonabrasive chrome polish to maintain the finish.

## CLEANING INTERIOR

Occasionally remove loose dust from the interior trim, plastic parts and seats using a vacuum cleaner or soft bristled brush. Wipe the vinyl and leather surfaces with a clean, soft cloth dampened in mild soap solution, then wipe clean with a dry, soft cloth.

Regular care and cleaning is required in order to maintain the appearance of the leather.

Before using any fabric protector, read the manufacturer's recommendations. Some fabric protectors contain chemicals that may stain or bleach the seat material.

Use a soft cloth dampened only with water to clean the meter and gauge lens covers.



### CAUTION:

- **Never use benzine, thinner or any similar material.**
- **Small dirt particles can be abrasive and damaging to leather surfaces and should be removed promptly. Do not use saddle soap, car waxes, polishes, oils, cleaning fluids, solvents, detergents or ammonia-based cleaners as they may damage the leather natural finish.**
- **Never use fabric protectors unless recommended by the manufacturer.**
- **Do not use glass or plastic cleaner on meter or gauge lens covers. It may damage the lens covers.**

## AIR FRESHENERS

Most air fresheners use a solvent that could affect the vehicle interior. If you use an air freshener, take the following precautions:

- Hanging-type air fresheners can cause permanent discoloration when they contact vehicle interior surfaces. Place the air freshener in a location that allows it to hang free and not contact an interior surface.
- Liquid-type air fresheners typically clip on the vents. These products can cause immediate damage and discoloration when spilled on interior surfaces.

Carefully read and follow the manufacturer's instructions before using air fresheners.

## FLOOR MATS

The use of genuine NISSAN floor mats (if equipped) can extend the life of your vehicle carpet and make it easier to clean the interior. Regardless of what mats are used, be sure they are fitted for your vehicle and are properly positioned in the foot well to prevent interference with pedal operation. Mats should be maintained with regular cleaning and replaced if they become excessively worn.

### Floor mat positioning aid (driver's side)

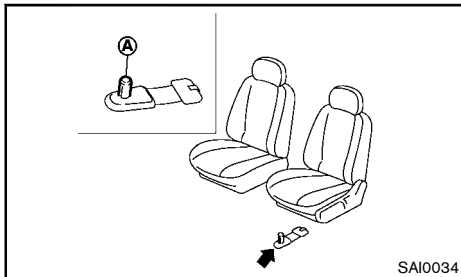

This vehicle includes a front floor mat bracket (A) to act as a floor mat positioning aid. NISSAN floor mats have been specially designed for your vehicle model. The driver's floor mat has a grommet hole incorporated in it.

Position the mat by placing the floor mat bracket hook through the floor mat grommet hole while centering the mat in the foot area.

Periodically check that the mats are properly positioned.

## GLASS

Use glass cleaner to remove smoke and dust film from the glass surfaces. It is normal for glass to become coated with a film after the vehicle is parked in the hot sun. Glass cleaner and a soft cloth will easily remove this film.



### CAUTION:

**When cleaning the inside of the windows, do not use sharp-edged tools, abrasive cleaners or chlorine-based disinfectant cleaners. They could damage the electrical conductors, such as rear**

**window defogger elements.**

## SEAT BELTS



### WARNING:

- **Do not allow wet seat belts to roll up in the retractor.**
- **Never use bleach, dye or chemical solvents to clean the seat belts, since these materials may severely weaken the seat belt webbing.**

The seat belts can be cleaned by wiping them with a sponge dampened in a mild soap solution.

Allow the belts to dry completely in the shade before using them. (See "Seat belts" (P.1-7).)

## CORROSION PROTECTION

### MOST COMMON FACTORS CONTRIBUTING TO VEHICLE CORROSION

- The accumulation of moisture-retaining dirt and debris in body panel sections, cavities, and other areas.
- Damage to the paint surface and other protective coatings caused by gravel and stone chips or minor traffic accidents.

### ENVIRONMENTAL FACTORS INFLUENCE RATE OF CORROSION

#### Moisture

The accumulation of sand, dirt and water on the inside floor of the vehicle can accelerate corrosion. Wet floor carpet/floor mats will not dry completely inside the vehicle. They should be removed and completely dried to avoid floor panel corrosion.

#### Relative humidity

Corrosion will be accelerated in areas of high relative humidity.

#### Temperature

High temperatures accelerate the rate of corrosion to those parts which are not well ventilated.

Corrosion will also be accelerated in areas where the temperatures stay above freezing.

#### Air pollution

Industrial pollution, the presence of salt in the air in coastal areas, or heavy road salt use accelerates the corrosion process. Road salt also accelerates the disintegration of paint surfaces.

### TO PROTECT YOUR VEHICLE FROM CORROSION

- Wash and wax your vehicle often to keep the vehicle clean.
- Always check for minor damage to the paint surface and if any exists, repair it as soon as possible.
- Keep the drain holes in the lower edge of the doors open to avoid water accumulation.
- Check the vehicle underbody for accumulation of sand, dirt or salt. If present, wash with water as soon as possible.



#### CAUTION:

- **Never remove dirt, sand or other debris from the passenger compartment by washing it out with a hose. Remove dirt with a vacuum cleaner or broom.**
- **Never allow water or other liquids to come in contact with electronic components inside the vehicle as this may damage them.**

Chemicals used for road surface deicing are extremely corrosive. They accelerate corrosion and deterioration of underbody components such as the exhaust system, fuel and brake lines, brake cables, floor pan and fenders.

#### **In the winter, the underbody must be cleaned periodically.**

For additional protection against rust and corrosion, which may be required in some areas, consult a NISSAN dealer.



**MEMO**

# 8 Maintenance and do-it-yourself

Maintenance requirements .....	8-3	Brake fluid .....	8-19
Scheduled maintenance .....	8-3	Clutch fluid (if equipped) .....	8-20
General maintenance .....	8-3	Automatic Transmission Fluid (ATF) (if equipped) .....	8-20
Where to go for service .....	8-3	Continuously Variable Transmission (CVT) fluid (if equipped) .....	8-21
General maintenance .....	8-3	Air cleaner filter .....	8-21
Explanation of general maintenance items .....	8-3	Wiper blades .....	8-21
Maintenance precautions .....	8-5	Windshield wiper blades .....	8-21
Engine compartment check locations .....	8-6	Rear window wiper blade (if equipped) .....	8-22
HR12DDR engine model .....	8-6	Window washer fluid .....	8-23
HR12DE engine model .....	8-7	Battery .....	8-24
HR15DE engine model .....	8-8	Vehicle battery .....	8-24
K9K engine model .....	8-9	Remote controller battery .....	8-25
Engine cooling system .....	8-9	Intelligent Key battery .....	8-26
Checking engine coolant level .....	8-10	Fuses .....	8-27
Changing engine coolant .....	8-10	Engine compartment .....	8-27
Engine oil .....	8-11	Passenger compartment .....	8-28
Checking engine oil level .....	8-11	Lights .....	8-29
Changing engine oil and oil filter .....	8-11	Headlights .....	8-29
Protect environment .....	8-15	Exterior lights .....	8-30
Fuel filter (diesel engine model) .....	8-16	Interior lights .....	8-31
Draining water .....	8-16	Light locations .....	8-32
Bleeding fuel system .....	8-16	Legal requirement to adjust headlight beam .....	8-39
Drive belts .....	8-16	Tires and wheels .....	8-42
Spark plugs (gasoline engine model) .....	8-17	Tire inflation pressure .....	8-42
Platinum-tipped spark plugs (if equipped) .....	8-17	Types of tires .....	8-42
Iridium-tipped spark plugs (if equipped) .....	8-18	Tire chains .....	8-42
Nickel-tipped spark plugs (if equipped) .....	8-18	Tire rotation .....	8-42
Brakes .....	8-18	Tire wear and damage .....	8-43
Checking parking brake .....	8-18	Tire age .....	8-43
Checking foot brake pedal .....	8-18	Changing tires and wheels .....	8-43
Brake booster .....	8-19	Wheel balance .....	8-43

Spare tire .....	8-43
Emergency tire puncture repair kit (if equipped) .....	8-44

## MAINTENANCE REQUIREMENTS

Some day-to-day and regular maintenance is essential to maintain your vehicle's good mechanical condition, as well as its emission and engine performance.

It is the owner's responsibility to make sure that the specified maintenance, as well as general maintenance, is performed.

As the vehicle owner, you are the only one who can ensure that your vehicle receives the proper maintenance care.

### SCHEDULED MAINTENANCE

For your convenience, the required scheduled maintenance items are described and listed in a separate Warranty Information and Maintenance booklet. You must refer to that booklet to ensure that necessary maintenance is performed on your vehicle at regular intervals.

### GENERAL MAINTENANCE

General maintenance includes those items which should be checked during normal day-to-day operation of the vehicle. They are essential if your vehicle is to continue to operate properly. It is your responsibility to perform these procedures regularly as prescribed.

Performing general maintenance checks requires minimal mechanical skill and a few general automotive tools.

These checks or inspections can be done by yourself, a qualified technician, or if you prefer, your NISSAN dealer.

### WHERE TO GO FOR SERVICE

If maintenance service is required or your vehicle appears to malfunction, have the systems checked and tuned by an authorised NISSAN dealer.

## GENERAL MAINTENANCE

During normal day-to-day operation of the vehicle, general maintenance should be performed regularly as prescribed in this section. If you detect any unusual sounds, vibrations or smells, be sure to check for the cause or have a NISSAN dealer do it promptly. In addition, you should notify a NISSAN dealer if you think that repairs are required.

When performing any checks or maintenance work, closely observe "Maintenance precautions" (P.8-5).

### EXPLANATION OF GENERAL MAINTENANCE ITEMS

**Additional information on the following items with "\*" is found later in this section.**

#### Outside vehicle

The maintenance items listed here should be performed from time to time, unless otherwise specified.

#### **Doors and engine hood:**

Check that all doors and the engine hood operate smoothly as well as the back door, trunk lid and hatch. Also make sure that all latches lock securely. Lubricate if necessary. Make sure that the secondary latch keeps the hood from opening when the primary latch is released. When driving in areas using road salt or other corrosive materials, check lubrication frequently.

#### **Lights\*:**

Clean the headlights on a regular basis. Make sure that the headlights, stop lights, tail lights, turn signal lights, and other lights are all operating properly and installed securely. Also check the aim of the headlights.

### **Tires\*:**

Check the pressure with a gauge often and always prior to long distance trips. Adjust the pressure in all tires, including the spare, to the pressure specified. Check carefully for damage, cuts or excessive wear.

### **Tire rotation\*:**

In the case that Two-Wheel Drive (2WD) and front & rear tires are same size; Tires should be rotated every 10,000 km (6,000 miles). Tires marked with directional indicators can only be rotated between front and rear. Make sure that the directional indicators point in the direction of wheel rotation after the tire rotation is completed.

In the case that Four-Wheel Drive (4WD) and front & rear tires are same size; Tires should be rotated every 5,000 km (3,000 miles). Tires marked with directional indicators can only be rotated between front and rear. Make sure that the directional indicators point in the direction of wheel rotation after the tire rotation is completed.

In the case that front tires are different size from rear tires; Tires cannot be rotated.

However, the timing for tire rotation may vary according to your driving habits and the road surface conditions.

### **Tire Pressure Monitoring System (TPMS) transmitter components (if equipped):**

Replace the TPMS transmitter grommet seal, valve core and cap when the tires are replaced due to wear or age.

### **Wheel alignment and balance:**

If the vehicle should pull to either side while driving on a straight and level road, or if you detect uneven or abnormal tire wear, there may be a need for wheel alignment. If the steering wheel or seat vibrates at normal highway speeds, wheel balancing may be

needed.

### **Windshield:**

Clean the windshield on a regular basis. Check the windshield at least every six months for cracks or other damage. Repair as necessary.

### **Wiper blades\*:**

Check for cracks or wear if not functioning correctly.

### **Inside vehicle**

The maintenance items listed here should be checked on a regular basis, such as when performing periodic maintenance, cleaning the vehicle, etc.

### **Accelerator pedal:**

Check the pedal for smooth operation and make sure that the pedal does not catch or require uneven effort. Keep the floor mats away from the pedal.

### **Brake pedal\*:**

Check the pedal for smooth operation and make sure that it attains the proper distance from the floor mat when depressed fully. Check the brake booster function. Be sure to keep the floor mats away from the pedal.

### **Parking brake\*:**

Check the parking brake operation regularly. Check that the lever (if equipped) or the pedal (if equipped) has the proper travel. Also make sure that the vehicle is held securely on a fairly steep hill when only the parking brake is applied.

### **Seat belts:**

Check that all parts of the seat belt system (for example, buckles, anchors, adjusters and retractors) operate properly and smoothly, and are installed securely. Check the belt webbing for cuts, fraying, wear or damage.

### **Steering wheel:**

Check for changes in the steering condition, such as excessive play, hard steering or strange noises.

### **Warning lights and chimes:**

Make sure that all warning lights and chimes are operating properly.

### **Windshield defogger:**

Check that the air comes out of the defogger outlets properly and in good quantity when operating the heater or air conditioner.

### **Windshield wiper and washer\*:**

Check that the wipers and washer operate properly and that the wipers do not streak.

### **Under hood and vehicle**

The maintenance items listed here should be checked periodically (for example, each time you check the engine oil or refuel).

### **Battery\*:**

Except for maintenance free battery, check the fluid level in each cell. It should be between the "UPPER" and "LOWER" lines. Vehicles operated in high temperatures or under severe conditions require frequent checks of the battery fluid level.

### **Brake (and clutch) fluid level(s)\*:**

For Manual Transmission (MT) model; make sure that the brake and clutch fluid levels are between the "MAX" and "MIN" lines on the reservoirs.

Except for Manual Transmission (MT) model; make sure that the brake fluid level is between the "MAX" and "MIN" lines on the reservoir.

### Engine coolant level\*:

Check the coolant level when the engine is cold. Make sure that the coolant level is between the "MAX" and "MIN" lines on the reservoir.

### Engine drive belt(s)\*:

Make sure that drive belt(s) is/are not frayed, worn, cracked or oily.

### Engine oil level\*:

Check the level after parking the vehicle (on a level ground) and turning off the engine.

### Fluid leaks:

Check under the vehicle for fuel, oil, water or other fluid leaks after the vehicle has been parked for a while. Water dripping from the air conditioner after use is normal. If you should notice any leaks or if fuel fumes are evident, check for cause and have it corrected immediately.

### Windshield washer fluid\*:

Check that there is adequate fluid in the reservoir.

## MAINTENANCE PRECAUTIONS

When performing any inspection or maintenance work on your vehicle, always take care to prevent serious accidental injury to yourself or damage to the vehicle. The following are general precautions which should be closely observed.



### WARNING:

- **Park the vehicle on a level surface, apply the parking brake securely and block the wheels to prevent the vehicle from moving. Move the shift lever to the "P" (Park) position (AT/CVT model) or the shift lever to the "N" (Neutral) position (MT model).**

- **Be sure the ignition switch is in the "OFF" or "LOCK" position when performing any parts replacement or repairs.**
- **Do not work under the hood while the engine is hot. Always turn off the engine and wait until it cools down.**
- **If you must work with the engine running, keep your hands, clothing, hair and tools away from moving fans, belts and any other moving parts.**
- **It is advisable to secure or remove any loose clothing and any jewelry, such as rings, watches, etc. before working on your vehicle.**
- **If you must run the engine in an enclosed space such as a garage, be sure there is proper ventilation for exhaust gases to escape.**
- **Never get under the vehicle while it is supported by a jack.**
- **Keep smoking materials, flame and sparks away from fuel and the battery.**
- **Never connect or disconnect either the battery or any transistorized component connector while the ignition switch is in the "ON" position.**
- **On gasoline engine models with the Multiport Fuel Injection (MFI) system, the fuel filter and fuel lines should be serviced by a NISSAN dealer because the fuel lines are under high pressure even when the engine is turned off.**
- **Your vehicle is equipped with an automatic engine cooling fan. It may come on at any time without warning, even if the ignition**

**switch is in the "OFF" position and the engine is not running. To avoid injury, always disconnect the negative battery cable before working near the fan.**

- **Always wear eye protection whenever you work on your vehicle.**
- **Never leave the engine or the transmission related component harness connector disconnected while the ignition switch is in the "ON" position.**
- **Avoid direct contact with used engine oil and coolant. Improperly disposed engine oil, engine coolant, and/or other vehicle fluids can hurt the environment. Always conform to local regulations for disposal of vehicle fluids.**

This "8. Maintenance and do-it-yourself" section provides instructions regarding only those items which are relatively easy for an owner to perform.

You should be aware that incomplete or improper servicing may result in operating difficulties or excessive emissions, and could affect your warranty coverage. **If in doubt about any servicing, have it done by a NISSAN dealer.**

# ENGINE COMPARTMENT CHECK LOCATIONS

## HR12DDR ENGINE MODEL

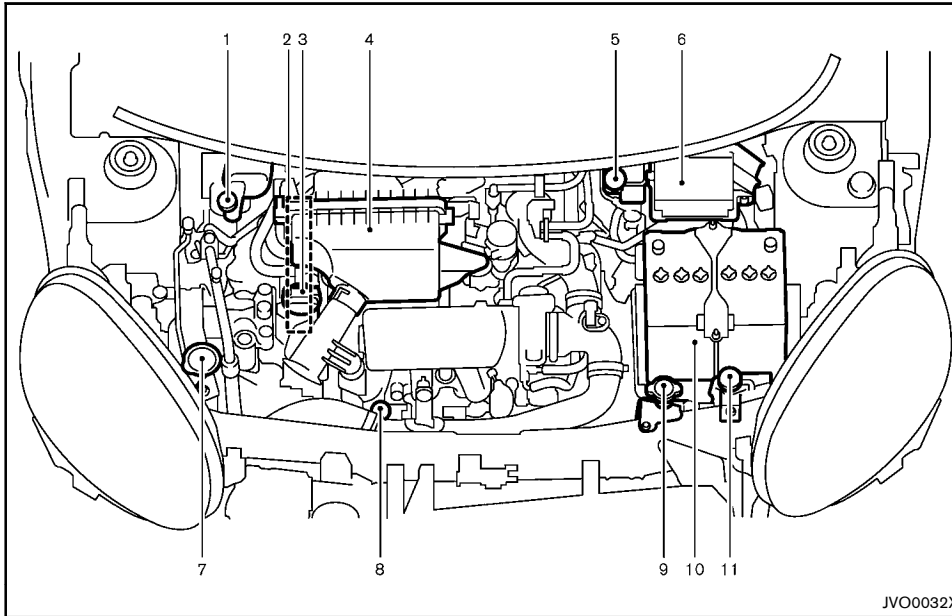

- |  |                                  |
|--|----------------------------------|
| 1. Brake and clutch* fluid reservoir<br>— Right-Hand Drive (RHD) model | 6. Fuse/fusible link box         |
| 2. Engine drive belts  | 7. Window washer fluid reservoir |
| 3. Engine oil filler cap   | 8. Engine oil dipstick           |
| 4. Air cleaner   | 9. Radiator cap                  |
| 5. Brake and clutch* fluid reservoir<br>— Left-Hand Drive (LHD) model  | 10. Battery                      |
|  | 11. Engine coolant reservoir     |

\*: For Manual Transmission (MT) Model

## HR12DE ENGINE MODEL

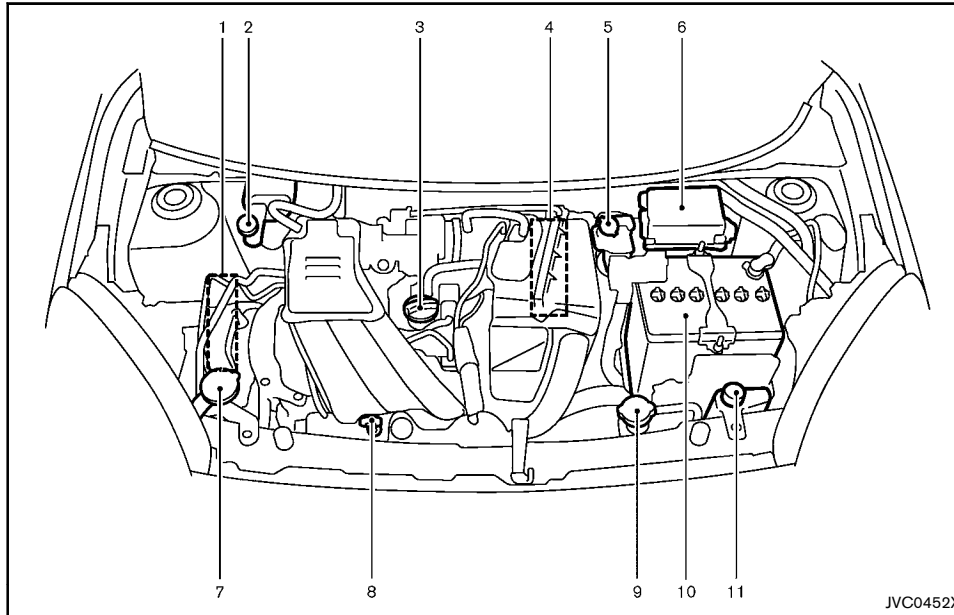

- |  |                                       |
|--|---------------------------------------|
| 1. Engine drive belts  | 7. Window washer fluid reservoir      |
| 2. Brake and clutch* fluid reservoir<br>— Right-Hand Drive (RHD) model | 8. Engine oil dipstick                |
| 3. Engine oil filler cap   | 9. Radiator cap                       |
| 4. Air cleaner   | 10. Battery                           |
| 5. Brake and clutch* fluid reservoir<br>— Left-Hand Drive (LHD) model  | 11. Engine coolant reservoir          |
| 6. Fuse/fusible link box   | *: For Manual Transmission (MT) Model |



## HR15DE ENGINE MODEL

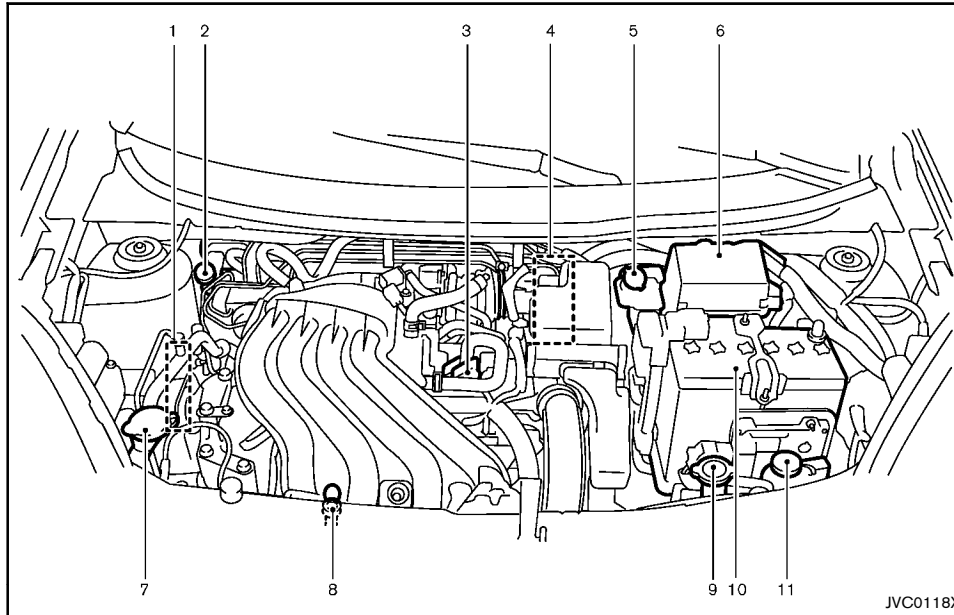

- |  |                                       |
|--|---------------------------------------|
| 1. Engine drive belts  | 7. Window washer fluid reservoir      |
| 2. Brake and clutch* fluid reservoir<br>— Right-Hand Drive (RHD) model | 8. Engine oil dipstick                |
| 3. Engine oil filler cap   | 9. Radiator cap                       |
| 4. Air cleaner   | 10. Battery                           |
| 5. Brake and clutch* fluid reservoir<br>— Left-Hand Drive (LHD) model  | 11. Engine coolant reservoir          |
| 6. Fuse/fusible link box   | *: For Manual Transmission (MT) Model |

## ENGINE COOLING SYSTEM

### K9K ENGINE MODEL

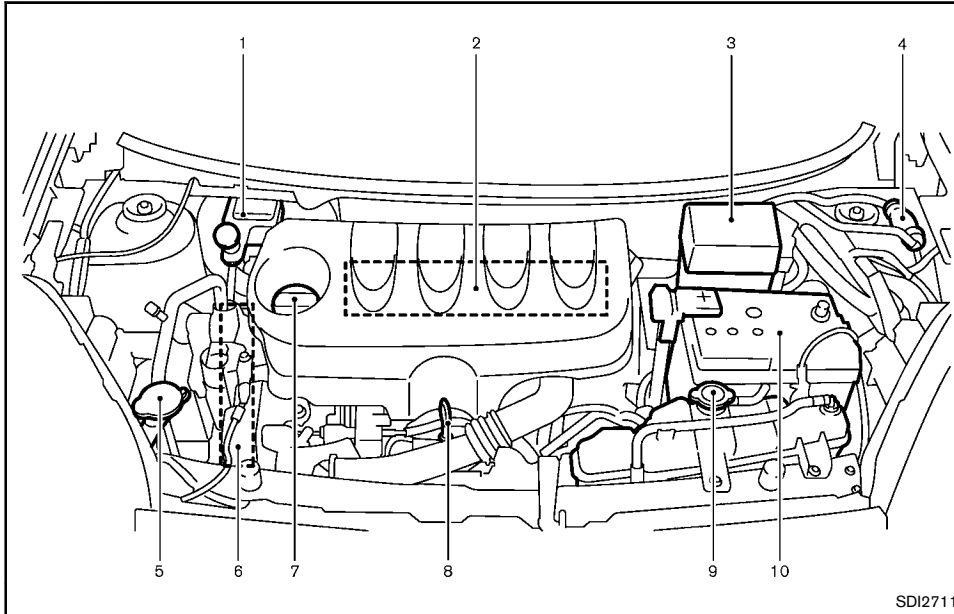

- |                                     |                             |
|-------------------------------------|-----------------------------|
| 1. Brake and clutch fluid reservoir | 9. Engine coolant reservoir |
| 2. Air cleaner                      | 10. Battery                 |
| 3. Fuse/Fusible link holders        |                             |
| 4. Priming pump                     |                             |
| 5. Window washer fluid reservoir    |                             |
| 6. Engine drive belts               |                             |
| 7. Engine oil filler cap            |                             |
| 8. Engine oil dipstick              |                             |



#### WARNING:

- **Never remove the radiator cap when the engine is hot. Serious burns could be caused by high-pressure fluid escaping from the radiator. Wait until the engine and radiator cool down.**
- **Engine coolant is poisonous and should be stored carefully in marked containers out of the reach of children.**

The engine cooling system is filled at the factory with a high-quality, year-round, anti-freeze coolant solution. The anti-freeze solution contains rust and corrosion inhibitors, therefore additional cooling system additives are not necessary.



#### CAUTION:

- **Never use any cooling system additives such as radiator sealer. Additives may clog the cooling system and cause damage to the engine, transmission and/or cooling system.**
- **When adding or replacing coolant, be sure to use only Genuine NISSAN Engine Coolant or equivalent in its quality with the proper mixture ratio. Examples of the mixture ratio are shown below:**

Outside temperature down to		Composition	
°C	°F	Engine coolant (concentrated)	Demineralized or distilled water
-15	5	30%	70%
-35	-30	50%	50%

Use Genuine NISSAN Engine Coolant or equivalent in its quality. Genuine NISSAN Engine Coolant is a pre-mixed (mixture ratio 50%) type coolant.

The use of other types of coolant solutions may damage the engine cooling system.

The radiator is equipped with a pressure cap. To prevent engine damage, use only a Genuine NISSAN radiator cap or its equivalent when replacement is required.

## CHECKING ENGINE COOLANT LEVEL

HR12DDR, HR12DE and HR15DE engine model

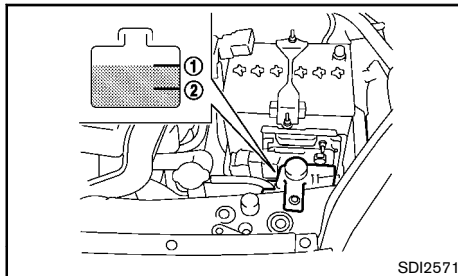

### HR12DDR, HR12DE and HR15DE engine

Check the coolant level in the reservoir when the engine is cold. If the coolant level is below the MIN level ②, add coolant up to the MAX level ①. If the reservoir is empty, check the coolant level in the radiator **when the engine is cold**. If there is insufficient coolant in the radiator, fill the radiator with coolant up to the filler opening and also add it to the reservoir up to the MAX level ①.

**If the cooling system frequently requires coolant, have it checked by a NISSAN dealer.**

K9K engine model

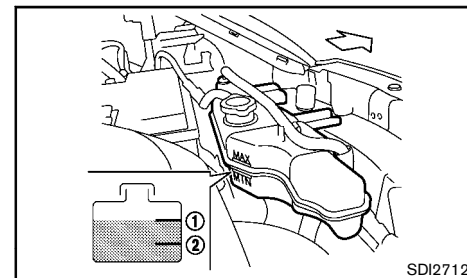

### K9K engine

Check the coolant level in the reservoir when the engine is cold. If the coolant level is below the MIN level ②, add coolant up to the MAX level ①.

**If the cooling system frequently requires coolant, have it checked by a NISSAN dealer.**

## CHANGING ENGINE COOLANT

Contact a NISSAN dealer if replacement is required.

Major engine cooling system repair should be performed by a NISSAN dealer. The service procedures can be found in the appropriate NISSAN Service Manual.

Improper servicing can result in reduced heater performance and engine overheating.



### WARNING:

- **To avoid being scalded, never change the coolant when the engine is hot.**
- **Never remove the radiator cap when the engine is hot. Serious burns could be caused by high pressure fluid escaping from the radiator.**

## ENGINE OIL

- **Avoid direct skin contact with used coolant. If skin contact is made, wash thoroughly with soap or hand cleaner as soon as possible.**
- **Keep coolant out of reach of children and pets.**

Engine coolant must be disposed of properly. Check your local regulations.

### CHECKING ENGINE OIL LEVEL

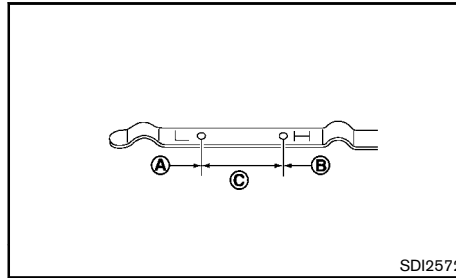

**HR12DDR, HR12DE and HR15DE engine**

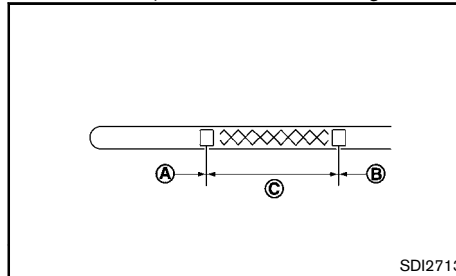

**K9K engine**

1. Park the vehicle on a level surface and apply the parking brake.
2. Start the engine and warm it up until the engine temperature reaches the normal operating temperature (approximately 5 minutes).
3. Stop the engine.
4. Wait at least 10 minutes for the engine oil to drain back to the oil pan.
5. Remove the dipstick and wipe it clean.

6. Reinsert the dipstick all the way.
7. Remove the dipstick and check the oil level. It should be within the range (C) .
8. If the oil level is below (A) , remove the oil filler cap and pour the recommended oil into the opening. Do not overfill (B) .

#### **For K9K engine model:**

**When filling the engine oil, do not remove the dipstick.**

9. Recheck the oil level with the dipstick.

**It is normal to add some oil between oil maintenance intervals or during the break-in period, depending on the severity of operating conditions.**



#### **CAUTION:**

**The oil level should be checked regularly. Operating your vehicle with an insufficient amount of oil can damage the engine, and such damage is not covered by warranty.**

### CHANGING ENGINE OIL AND OIL FILTER



#### **WARNING:**

- **Used oil must be disposed of properly. Never pour or dump oil into the ground, canals, rivers, etc. It should be disposed of at proper waste facilities. NISSAN recommends having your oil changed by a NISSAN dealer.**
- **Be careful not to burn yourself, as the engine oil may be hot.**
- **Prolonged and repeated contact with used engine oil may cause skin cancer.**

- Avoid direct skin contact with used oil. If contacted, wash thoroughly with soap or hand cleaner and plenty of water as soon as possible.
- Store used engine oil in marked containers out of the reach of children.



**CAUTION:**

Waste oil must be disposed of properly. Check your local regulations.

Engine oil replacement (HR12DDR, HR12DE and HR15DE engine models)

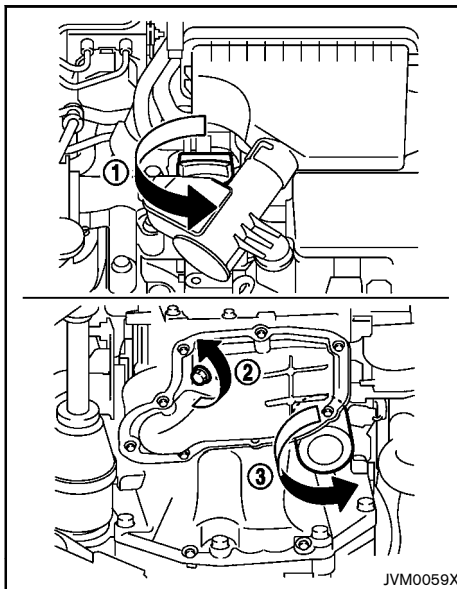

HR12DDR engine model

JVM0059X

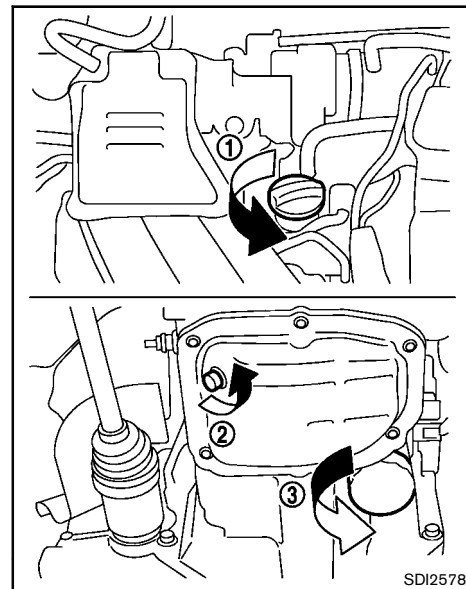

HR12DE engine model

SDI2578

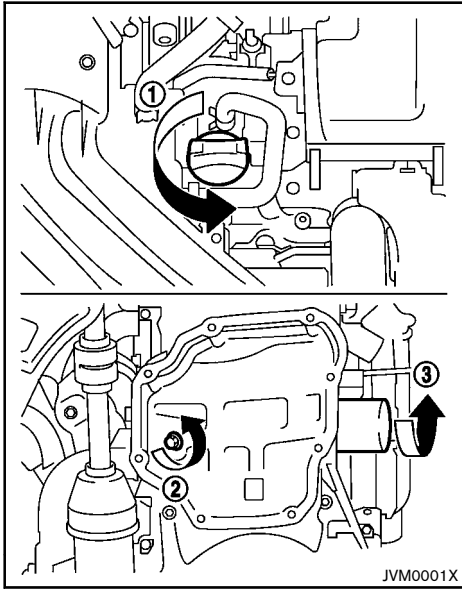

**HR15DE engine model**

JVM0001X

1. Oil filler cap
2. Oil drain plug
3. Oil filter

1. Park the vehicle on a level surface and apply the parking brake.
2. Start the engine and warm it up until the engine temperature reaches the normal operating temperature (approximately 5 minutes).
3. Stop the engine.
4. Wait at least 10 minutes for the engine oil to drain back to the oil pan.

5. Place a large drain pan under the drain plug.
6. Remove the drain plug with a wrench.
7. Remove the oil filler cap and completely drain the oil.

If the oil filter is to be changed, remove and replace it at this time. (See "Engine oil filter replacement (HR12DDR, HR12DE and HR15DE engine models)" (P.8-13).)

8. Clean and reinstall the drain plug and new washer. Securely tighten the drain plug with a wrench. Do not use excessive force.

**Drain plug tightening torque:**

**29 to 39 N·m  
(3.0 to 4.0 kg·m, 22 to 29 ft·lb)**

9. Refill the recommended engine oil and quantity. (See "Recommended fuel/lubricants and capacities" (P.9-2).)
10. Securely install the oil filler cap.
11. Start the engine.
12. Check the drain plug for any sign of leakage.
13. Check the engine oil level according to the proper procedure. (See "Checking engine oil level" (P.8-11).)

**Engine oil filter replacement (HR12DDR, HR12DE and HR15DE engine models)**

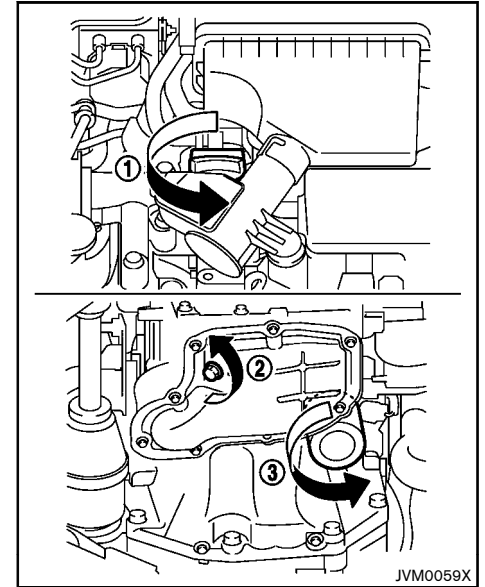

**HR12DDR engine model**

JVM0059X

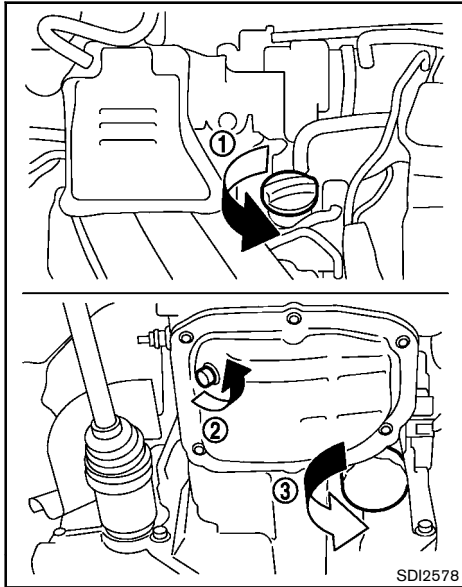

HR12DE engine model

SDI2578

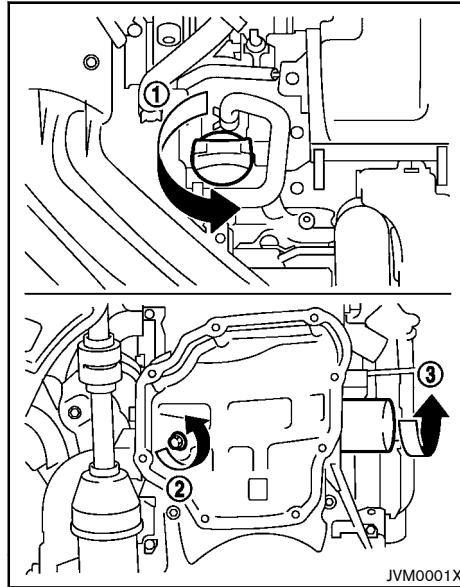

HR15DE engine model

JVM0001X

1. Oil filler cap
  2. Oil drain plug
  3. Oil filter
1. Park the vehicle on a level surface and apply the parking brake.
  2. Turn the engine off.
  3. Drain the engine oil according to the proper procedure. (See "Engine oil replacement (HR12DDR, HR12DE and HR15DE engine models)" (P.8-12).)

4. Loosen the oil filter with an oil filter wrench.  
Depending on the engine model, a special cap type wrench may be required. See a NISSAN dealer for more information.
5. Remove the oil filter by turning it by hand.
6. Wipe the engine oil filter mounting surface with a clean cloth.  
Be sure to remove any old gasket remaining on the mounting surface.
7. Apply the new engine oil to the gasket of the new oil filter.
8. Screw in the oil filter until a slight resistance is felt, and then tighten an additional 2/3 of turn to secure the oil filter.

**Oil filter tightening torque:  
15 to 20 N·m (11 to 14 ft·lb)**

9. Refill the engine oil. (See "Engine oil replacement (HR12DDR, HR12DE and HR15DE engine models)" (P.8-12).)
10. Start the engine and check for leakage around the oil filter. Correct as required.
11. Turn the engine off and wait several minutes.
12. Check the engine oil level according to the proper procedure. (See "Checking engine oil level" (P.8-11).)

## Engine oil and filter replacement (K9K engine model)

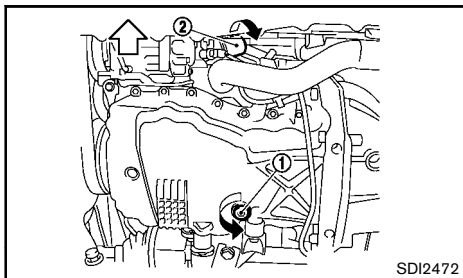

1. Oil drain plug
2. Oil filter

1. Place a large drain pan under the drain plug.
2. Remove the drain plug with a wrench.
3. Remove the oil filler cap and completely drain the oil.

If the oil filter is to be changed, remove and replace it at this time.



### CAUTION:

**Waste oil must be disposed of properly. Check your local regulations.**

4. Loosen the oil filter with an oil filter wrench.
5. Remove the oil filter by turning it by hand.
6. Wipe the entire oil filter mounting surface with a clean cloth.

Be sure to remove any old gasket remaining on the mounting surface.

7. Apply new engine oil to the gasket on the new oil filter.
8. Screw in the oil filter until a slight resistance is felt, and then tighten an additional 3/4 of a turn to secure the filter.

### Oil filter tightening torque:

**16 to 20 N·m (1.6 to 2.0 kg·m, 12 to 15 ft·lb)**

9. Clean and reinstall the drain plug and new washer. Securely tighten the drain plug with a wrench. Do not use excessive force.

### Drain plug tightening torque:

**16 to 24 N·m (1.6 to 2.4 kg·m, 12 to 18 ft·lb)**

10. Refill the recommended engine oil and quantity. (See "Recommended fuel/lubricants and capacities" (P.9-2).)
11. Securely install the oil filler cap.
12. Start the engine.
13. Check the drain plug and the oil filter for any sign of leakage.
14. Dispose of the used oil in the proper manner. Check your local regulations.
15. Check the engine oil level according to the proper procedure. (See "Checking engine oil level" (P.8-11).)

### After operation

1. Install the engine undercover (if removed) into position as the following steps.
  - a. Pull the center of each plastic clip out.
  - b. Hold the engine undercover into position.
  - c. Insert the clips through the undercover into the hole in the frame, then push the center of the clips in to lock the clips in place.

- d. Screw in the bolts, then tighten them.
2. Lower the vehicle carefully to the ground.

## PROTECT ENVIRONMENT

It is illegal to pollute drains, watercourses and soil. Use authorized waste collection facilities, including civil amenity sites and garages providing facilities for disposal of used oil and used oil filters. If in doubt, contact your local authority for advice on disposal.

**The regulations concerning the pollution of the environment will vary from country to country.**



## FUEL FILTER (diesel engine model)

### DRAINING WATER

Drain water in the fuel filter according to the maintenance log shown in a separate maintenance booklet.

If the water-in-fuel-filter warning light  illuminates while the engine is running, there might be water in the fuel filter.

The fuel filter can be accessed after removing the fuse box and the battery from the vehicle. Therefore, NISSAN recommends that you contact a NISSAN dealer for servicing.

### BLEEDING FUEL SYSTEM

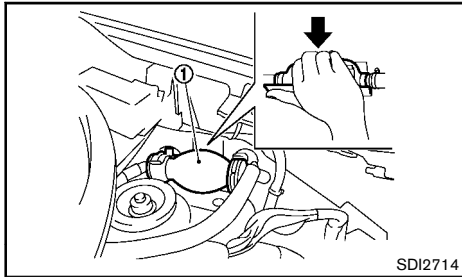

Bleed air out of the fuel system after refilling an empty fuel tank by the following action:

1. Squeeze the priming pump ① located in the engine compartment several times until there is a sudden resistance felt in the pressure, then stop.
2. Crank the engine until it starts. Do not crank the engine for more than 30 seconds.
3. If the engine does not start, stop cranking and repeat step 1 above.

4. If the engine does not operate smoothly after it has started, race it two or three times.

## DRIVE BELTS

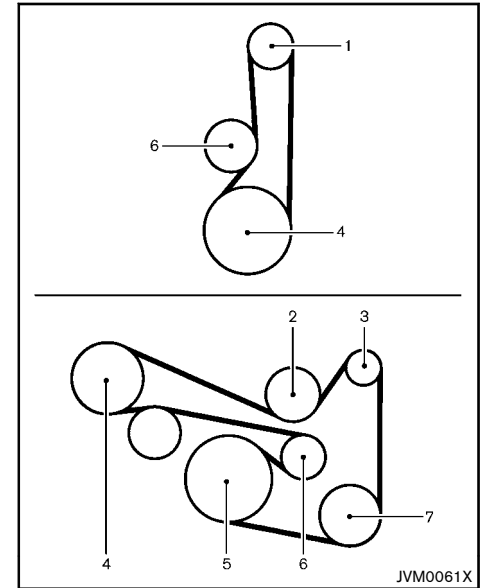

- HR12DDR engine**
1. Supercharger
  2. Water pump
  3. Alternator
  4. Electromagnetic clutch
  5. Crankshaft pulley
  6. Drive belt auto-tensioner
  7. Air conditioner compressor

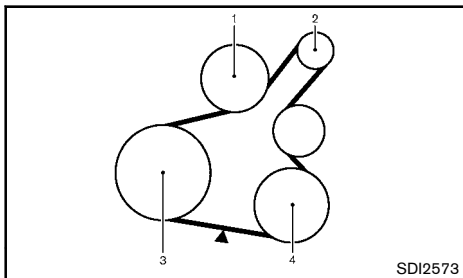

**HR 12DE engine or HR 15DE engine**

1. Water pump
  2. Alternator
  3. Crankshaft pulley
  4. Air conditioner compressor (with air compressor)  
Idler pulley (without air compressor)
- ▼: Tension checking point

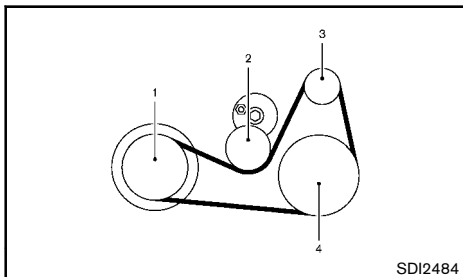

**K9K engine**

1. Crankshaft pulley
2. Drive belt auto-tensioner
3. Alternator
4. Air conditioner compressor

Be sure the ignition switch is in the "OFF" position.

Visually inspect each belt for signs of unusual wear, cuts, fraying or looseness. Check regularly for condition and tension. If the belt is in poor condition or loose, have it replaced or adjusted by a NISSAN dealer.

## SPARK PLUGS (gasoline engine model)



### WARNING:

**Be sure the engine and ignition switch are off and that the parking brake is applied.**

Replace the spark plugs according to the maintenance log shown in a separate maintenance booklet.

If replacement is required, contact a NISSAN dealer.

PLATINUM-TIPPED SPARK PLUGS (if equipped)

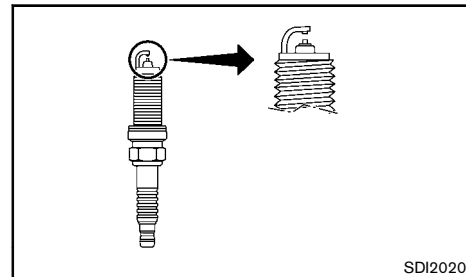

It is not necessary to replace the platinum-tipped spark plugs as frequently as the conventional type of spark plugs. These spark plugs are designed to last much longer than the conventional type of spark plugs.



### CAUTION:

- **Do not reuse the platinum-tipped spark plugs by cleaning or re-gapping.**
- **Always replace with the recommended platinum-tipped spark plugs.**

## BRAKES

### CHECKING PARKING BRAKE

#### Lever type

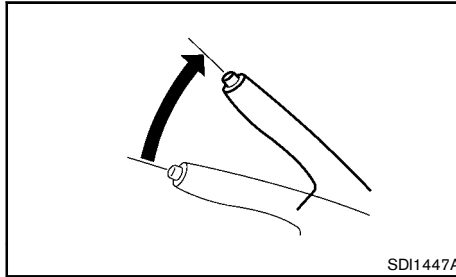

From the released position, pull the parking brake lever up slowly and firmly. If the number of clicks is out of the range listed, see a NISSAN dealer.

#### For Thailand, Indonesia, Singapore, Hong Kong, Brunei and Pakistan:

8 to 10 clicks  
Pulling force 196 N (20 kg, 44 lb)

#### For India:

8 to 9 clicks (for model with ABS or K9K engine model)  
9 to 10 clicks (for model without ABS)  
Pulling force 196 N (20 kg, 44 lb)

#### For Australia and New Zealand:

11 to 12 clicks  
Pulling force 196 N (20 kg, 44 lb)

### IRIDIUM-TIPPED SPARK PLUGS (if equipped)

It is not necessary to replace the iridium-tipped spark plugs as frequently as the conventional type of spark plugs. These spark plugs are designed to last much longer than the conventional type of spark plug.

#### ⚠ CAUTION:

- Do not reuse the iridium-tipped spark plugs by cleaning or re-gapping.
- Always replace with the recommended iridium-tipped spark plugs.

### NICKEL-TIPPED SPARK PLUGS (if equipped)

It is not necessary to replace the nickel-tipped spark plugs as frequently as the conventional type of spark plugs. These spark plugs are designed to last much longer than the conventional type of spark plug.

#### ⚠ CAUTION:

- Do not reuse the nickel-tipped spark plugs by cleaning or re-gapping.
- Always replace with the recommended nickel-tipped spark plugs.

Except for Thailand, Indonesia, Singapore, Hong Kong, Brunei, India, Australia, New Zealand and Pakistan:

8 to 9 clicks  
Pulling force 196 N (20 kg, 44 lb)

### CHECKING FOOT BRAKE PEDAL

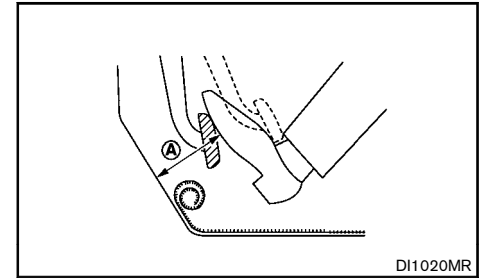

#### ⚠ WARNING:

See a NISSAN dealer for a brake system check if the foot brake pedal height does not return to normal.

With the engine running, check the distance (A) between the upper surface of the pedal and the metal floor. If it is out the range listed, see a NISSAN dealer.

(A) : Depressing force  
490 N (50 kg, 110 lb)  
For Right-Hand Drive (RHD) model:  
— 80 mm (3.15 in) or more  
For Left-Hand Drive (LHD) model:  
— 72 mm (2.83 in) or more

## Self-adjusting brakes

Your vehicle is equipped with self-adjusting brakes. The brakes are adjusted by the foot brake pedal operation.

## Brake pad wear indicator

The disc brake pads on your vehicle have audible wear indicators. When a brake pad requires replacement, it will make a high pitched scraping or screeching sound when the vehicle is in motion. The noise will be heard whether or not the foot brake pedal is depressed. Have the brakes checked as soon as possible if the wear indicator sound is heard.

Under some driving or climate conditions, occasional brake squeaks, squeals or other noises may be heard. Occasional brake noise during light to moderate stops is normal and does not affect the function or performance of the brake system.

The rear drum brakes do not have audible wear indicators. Should you ever hear an unusually loud noise from the rear drum brakes, have them checked as soon as possible by a NISSAN dealer.

Proper brake inspection intervals should be followed. For additional information, see a separate maintenance booklet.

## BRAKE BOOSTER

Check the brake booster function as follows:

1. With the engine off, depress and release the foot brake pedal several times. When the foot brake pedal movement (distance of travel) remains the same from one pedal application to the next, continue on to the next step.
2. While depressing the foot brake pedal, start the engine. The pedal height should drop a little.

3. With the foot brake pedal depressed, stop the engine. Keep the pedal depressed for about 30 seconds. The pedal height should not change.
4. Run the engine for 1 minute without depressing the foot brake pedal, then turn it off. Depress the foot brake pedal several times. The pedal travel distance will decrease gradually with each depression as the vacuum is released from the booster.

If the brakes do not operate properly, have the brakes checked by a NISSAN dealer.

## BRAKE FLUID



### WARNING:

- Use only new fluid from a sealed container. Old, inferior, or contaminated fluid may damage the brake system. The use of improper fluids can damage the brake system and affect the vehicle's stopping ability.
- Clean the filler cap before removing.
- Brake fluid is poisonous and should be stored carefully in marked containers out of the reach of children.



### CAUTION:

Do not spill the fluid on painted surfaces. This will damage the paint. If fluid is spilled, wash it off with plenty of water immediately.

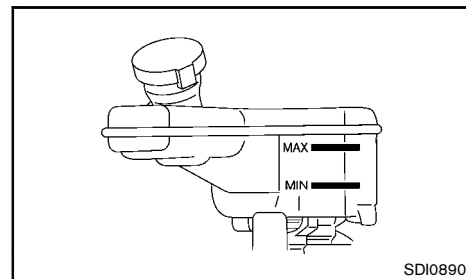

Check the fluid level in the reservoir. If the brake fluid is below the MIN line, the brake warning light will illuminate. Add brake fluid up to the MAX line. (For recommended types of brake fluid, see "Recommended fuel/lubricants and capacities" (P.9-2).)

If the brake fluid must be added frequently, the brake

system should be thoroughly checked by a NISSAN dealer.

## CLUTCH FLUID (if equipped)



### WARNING:

- Use only new fluid from a sealed container. Old, inferior, or contaminated fluid may damage the clutch system.
- Clean the filler cap before removing.
- Clutch fluid is poisonous and should be stored carefully in marked containers out of the reach of children.



### CAUTION:

Do not spill the clutch fluid on painted surfaces. This will damage the paint. If clutch fluid is spilled, wash it off with plenty of water immediately.

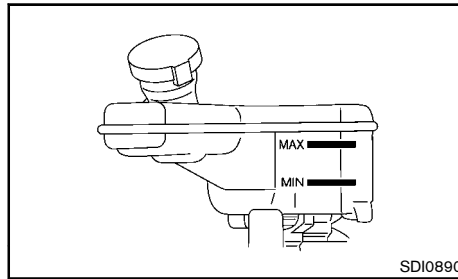

Check the fluid level in the reservoir. If the fluid is below the MIN line, add fluid up to the MAX line. (For recommended types of fluid, see "Recommended fuel/lubricants and capacities" (P.9-2).)

If the fluid must be added frequently, the clutch system should be thoroughly checked by a NISSAN dealer.

## AUTOMATIC TRANSMISSION FLUID (ATF) (if equipped)

Contact a NISSAN dealer if checking or replacement is required.



### CAUTION:

- Use only Genuine NISSAN Matic S ATF. Do not mix with other fluids.
- Using automatic transmission fluid other than Genuine NISSAN Matic S ATF will cause deterioration in driveability and transmission durability, and may damage the transmission, which is not covered by the warranty.

## CONTINUOUSLY VARIABLE TRANSMISSION (CVT) FLUID (if equipped)

Contact a NISSAN dealer if checking or replacement is required.



### CAUTION:

- **Use only the specified transmission fluid. Do not mix with other fluids. (See “Recommended fuel/lubricants and capacities” (P.9-2).)**
- **Using transmission fluid other than the specified ones will cause deterioration in driveability and transmission durability, and may damage the transmission, which is not covered by the warranty.**

## AIR CLEANER FILTER

The viscous paper type filter element should not be cleaned and reused.

The dry paper type filter element may be cleaned and reused.

Replace the air cleaner filter according to the maintenance log shown in a separate maintenance booklet.

Contact a NISSAN dealer if maintenance or replacement is required.



### WARNING:

**Operating the engine with the air cleaner filter off can cause you or others to be burned. The air cleaner filter not only cleans the intake air, it also stops flame if the engine backfires. If the air cleaner filter is not installed and the engine backfires, you could be burned. Never drive with the air cleaner filter off. Be cautious working on the engine when the air cleaner filter is off.**

## WIPER BLADES

### WINDSHIELD WIPER BLADES

#### Cleaning

If the windshield does not become clear after using the windshield washer or if the wiper blades chatter when operating the windshield wipers, wax or other materials may be on the windshield and/or wiper blades.

Clean the outside of the windshield surface with a washer solution or mild detergent. Your windshield is clean if beads do not form when rinsing with water.

Clean the blade by wiping it with a cloth soaked in a washer solution or a mild detergent. Rinse the blade with water. If your windshield is still not clear after cleaning the blades and using the wipers, replace the blades.

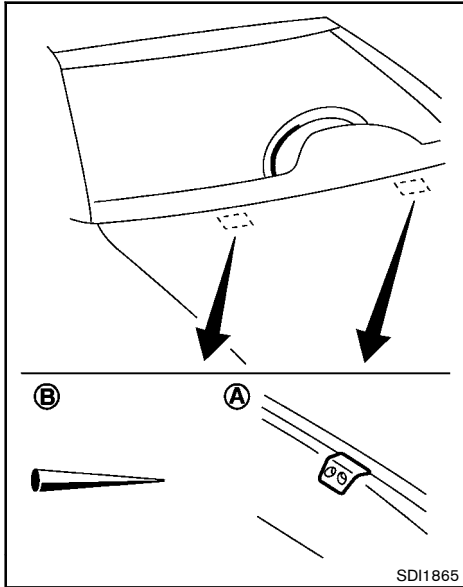

Be careful not to clog the washer nozzle (A). This may cause improper windshield washer operation. If the nozzle is clogged, remove any objects with a needle or small pin (B). Be careful not to damage the nozzle.

## Replacing

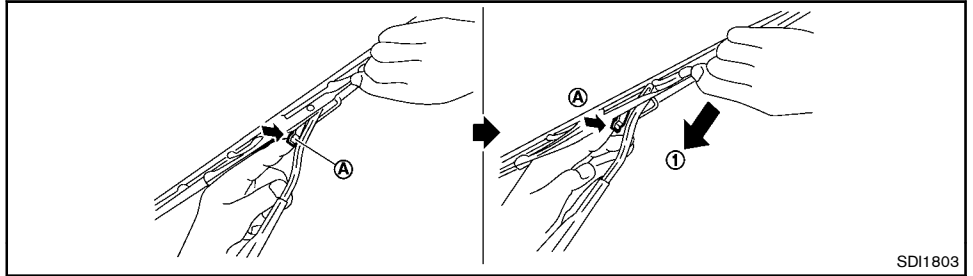

1. Lift the wiper arm away from the windshield.
2. Push and hold the release tab (A), and then move the wiper blade down the wiper arm to remove (1).
3. Remove the wiper blade.
4. Insert the new wiper blade onto the wiper arm until it clicks into place.

REAR WINDOW WIPER BLADE (if equipped)

Contact a NISSAN dealer if checking or replacement is required.



### CAUTION:

- **After wiper blade replacement, return the wiper arm to its original position. Otherwise the wiper arm or the engine hood may be scratched and may cause damage.**
- **Worn windshield wiper blades can damage the windshield and impair driver vision.**

## WINDOW WASHER FLUID

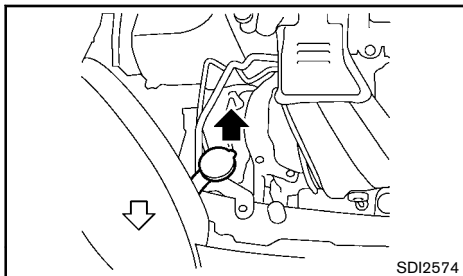

Type A

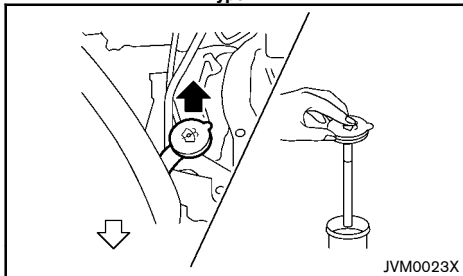

Type B



### WARNING:

**Anti-freeze is poisonous and should be stored carefully in marked containers out of the reach of children.**

Type A: Check the fluid level in the window washer reservoir. If the fluid level is low, add window washer fluid up to the MAX level.







Type B: To check the fluid level, use your finger to plug the center hole ① of the cap/tube assembly, then remove it from the reservoir. If there is no fluid in the tube, add fluid.

Add a washer solvent to the water for better cleaning. In the winter season, add a windshield washer anti-freeze. Follow the manufacturer's instructions for the mixture ratio.



## BATTERY

### VEHICLE BATTERY

Caution symbols for battery			 WARNING
①		No smoking, No exposed flames, No sparks	Never smoke around battery. Never expose battery to open flames or electrical sparks.
②		Shield eyes	Handle the battery cautiously. Always wear eye protection glasses to protect against explosion or battery acid.
③		Keep away from children	Never allow children to handle battery. Keep the battery out of the reach of children.
④		Battery acid	Do not allow battery fluid to contact your skin, eyes, fabrics, or painted surfaces. After handling the battery or battery cap, immediately wash your hands thoroughly. If the battery fluid gets into your eyes, or onto your skin or clothing, flush with water immediately for at least 15 minutes and seek medical attention. Battery fluid is acid. If the battery fluid gets into your eyes or onto your skin, it could cause loss of your eyesight or burns.
⑤		Note operating instructions	Before handling the battery, read this instruction carefully to ensure correct and safe handling.
⑥		Explosive gas	Hydrogen gas, generated by battery fluid, is explosive.

SDI1573



#### **WARNING:**

**Do not operate the vehicle if the fluid in the battery is low. Low battery fluid can cause a higher load on the battery which can generate heat, reduce battery life, and in some cases lead to an explosion.**

## Checking battery fluid level

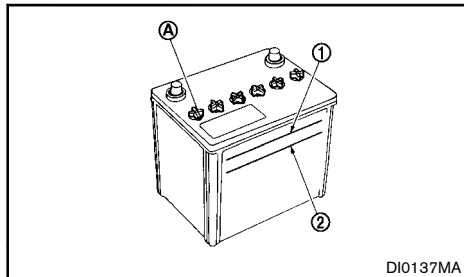

Type A

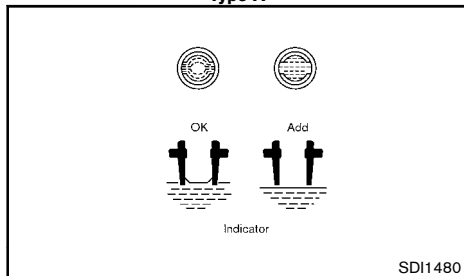

Type A

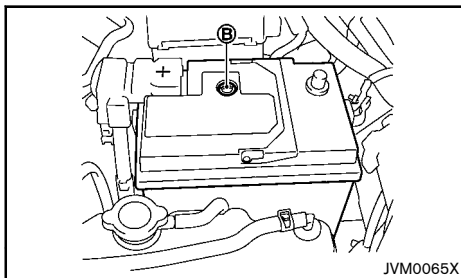

Type B

Check the fluid level in each cell. The battery fluid level should be between the UPPER LEVEL ① and LOWER LEVEL ② lines.

If it is necessary to add fluid, add only demineralized/distilled water to bring the level to the indicator in each filler opening. Do not overfill.

1. Remove the cell plugs (A), if equipped.
  2. Add demineralized/distilled water up to the UPPER LEVEL ① line.
  3. Replace and tighten the cell plugs.
- Vehicles operated in high temperatures or under severe conditions require frequent checks of the battery fluid level.
  - Keep the battery surface clean and dry. Clean the battery with a solution of baking soda and water.
  - Make certain the terminal connections are clean and securely tightened.
  - If the vehicle is not to be used for more than 30 days, disconnect the negative (-) battery terminal cable to prevent battery discharge.
  - For a maintenance free battery (for Type B) it is not required to check the fluid level. However, NISSAN recommends to visually check the green

indicator (B) status periodically. If the color of the indicator is changed, please contact a NISSAN dealer as soon as possible.

For model with Stop/Start (Idling Stop) System, see "Jump starting" (P.6-9).

## Jump starting

If jump starting is necessary, see "Jump starting" (P.6-9). If the engine does not start by jump starting or the battery does not charge, the battery may have to be replaced. Contact a NISSAN dealer for replacing the battery.

## REMOTE CONTROLLER BATTERY

### Battery replacement



### CAUTION:

- **Be careful not to allow children to swallow the battery and removed parts.**
- **An improperly disposed battery can harm the environment. Always confirm local regulations for battery disposal.**
- **When changing batteries, do not let dust or oil get on the components.**
- **There is danger of explosion if lithium battery is incorrectly replaced. Replace only with the same or equivalent type.**

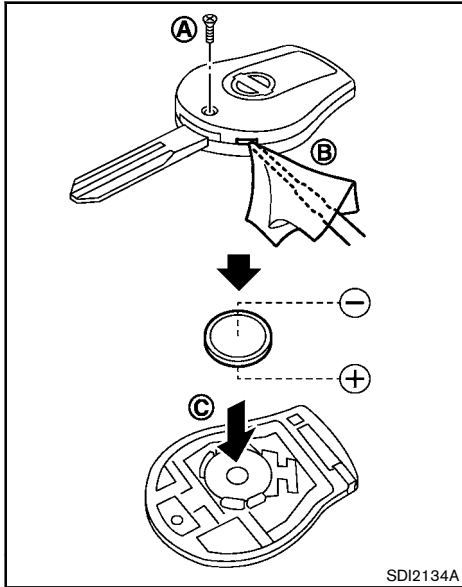

SDI2134A

To replace the battery:

1. Remove the screw (A).
2. Insert a small screwdriver into the slit of the corner (B) and twist it to separate the upper part from the lower part. Use a cloth to protect the casing.
3. Replace the battery with a new one.

Recommended battery: CR1620 or equivalent

- Do not touch the internal circuit and electric terminals as doing so could cause a malfunction.

- Make sure that the + side faces the bottom of the case (C).
4. Close the lid and install the screw securely.
  5. Operate the buttons to check its operation.

See a NISSAN dealer if you need assistance for replacement.

#### FCC WARNING:

Changes or modifications not expressly approved by the party responsible for compliance could void the user's authority to operate the equipment.

This device complies with Part 15 of the FCC Rules. Operation is subject to the following two conditions; (1) This device may not cause harmful interference, and (2) this device must accept any interference received, including interference that may cause undesired operation of the device.

#### INTELLIGENT KEY BATTERY

Battery replacement



#### CAUTION:

- **Be careful not to allow children to swallow the battery and removed parts.**
- **An improperly disposed battery can harm the environment. Always confirm local regulations for battery disposal.**
- **When changing batteries, do not let dust or oil get on the components.**
- **There is danger of explosion if lithium battery is incorrectly replaced. Replace only with the same or equivalent type.**

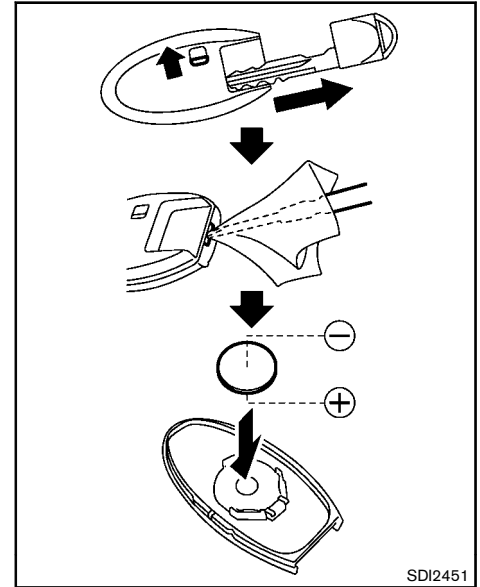

SDI2451

To replace the battery:

1. Release the lock knob at the back of the Intelligent Key and remove the mechanical key.
2. Insert a small screwdriver into the slit of the corner and twist it to separate the upper part from the lower part. Use a cloth to protect the casing.
3. Replace the battery with a new one.
  - Recommended battery: CR2025 or equivalent
  - Do not touch the internal circuit and electric terminals as doing so could cause a malfunction.

## FUSES

- Make sure that the ⊕ side faces the bottom of the case.

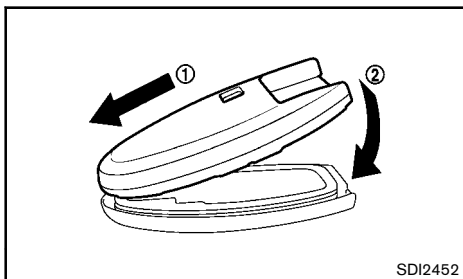

4. Align the tips of the upper and lower parts ①, and then push them together until it is securely closed ②.
  5. Operate the buttons to check its operation.
- See a NISSAN dealer if you need assistance for replacement.

### ENGINE COMPARTMENT

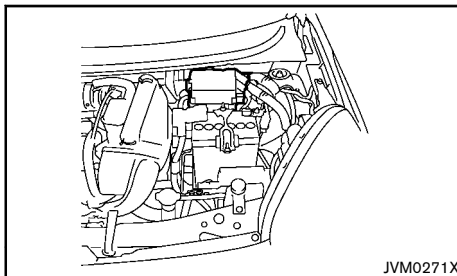

For checking and/or replacing, see a NISSAN dealer.

#### Fusible links

If any electrical equipment does not operate and the fuses are in good condition, check the fusible links. If any of these fusible links are melted, replace only with genuine NISSAN parts.

## PASSENGER COMPARTMENT

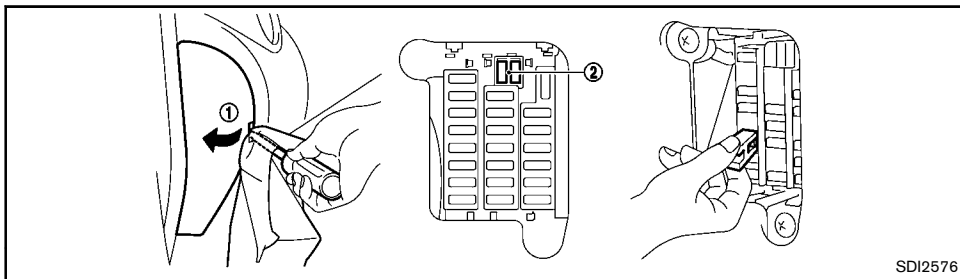

SDI2576

For all models

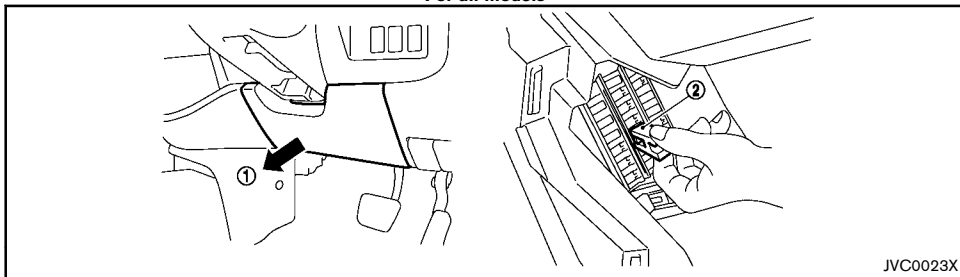

JVC0023X

For Stop/Start (Idling Stop) System (if equipped)



### CAUTION:

**Never use a fuse of a higher or lower amperage rating than that specified on the fuse box cover. This could damage the electrical system or cause a fire.**

If any electrical equipment does not operate, check for an open fuse.

1. Be sure the ignition switch is in the "OFF" position.
2. Be sure the headlight switch is in the "OFF" position.
3. Remove the fuse box cover (1) with a suitable tool.
4. Locate the fuse that needs to be replaced.
5. Remove the fuse using the fuse puller (2).

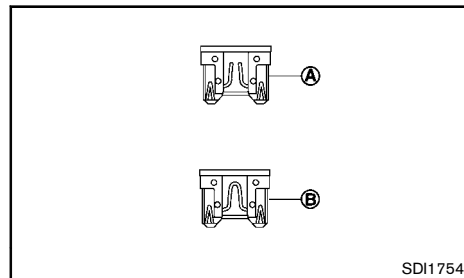

SDI1754

6. If the fuse is open (A), replace it with a new fuse (B).

If the new fuse also opens, after installing, have the electrical system checked, and if necessary repaired, by a NISSAN dealer.

Extended storage fuse switch (if equipped)

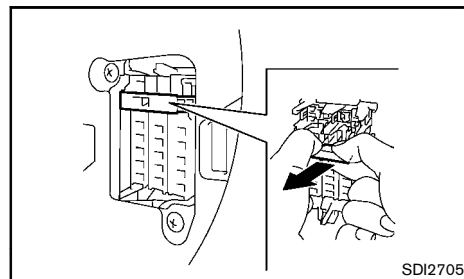

SDI2705

If any electrical equipment does not operate, remove the extended storage fuse switch and check for an open fuse.

## LIGHTS

### NOTE:

The extended storage fuse switch is used for long term vehicle storage. If the extended storage fuse switch is broken, it is not necessary to replace it. Remove the fuse from the switch then replace only the fuse to the fuse box.

**How to remove the extended storage fuse switch:**

1. To remove the extended storage fuse switch, be sure the ignition switch is in the "OFF" or "LOCK" position.
2. Be sure the headlight switch is in the "OFF" position.
3. Remove the fuse box cover.
4. Pinch the switch and pull it in the direction of the arrow.

### HEADLIGHTS

Fog may temporarily form inside the lens of the exterior lights in the rain or in a car wash. A temperature difference between the inside and the outside of the lens causes the fog. This is not a malfunction. If large drops of water collect inside the lens, contact a NISSAN dealer.

#### Replacing halogen headlight bulb

The halogen headlight is a semi-sealed beam type which uses replaceable headlight (halogen) bulbs. They can be replaced from inside the engine compartment without removing the headlight assembly.



#### CAUTION:

- High-pressure halogen gas is sealed inside the bulb. The bulb may break if the glass envelope is scratched or the bulb is dropped.

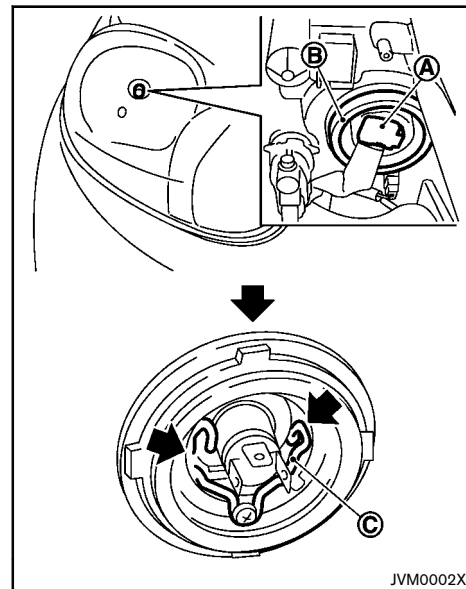

JVM0002X

Type A

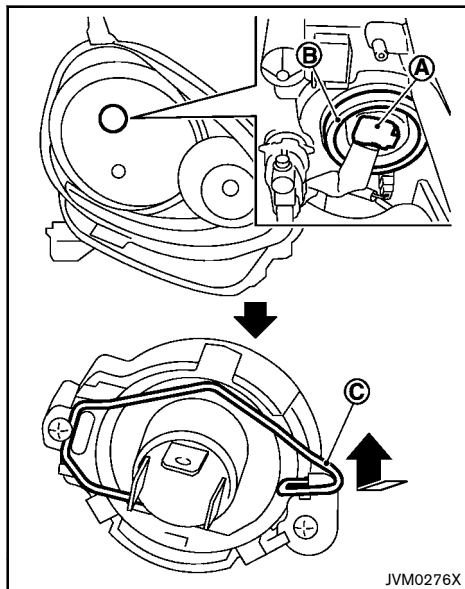

**Type B (example)**

1. Disconnect the battery negative cable.
2. Disconnect the electrical connector (A) from the rear end of the bulb.
3. Pull off the rubber cap (B).
4. Push and turn the retaining pin (C) to loosen it.
5. Remove the headlight bulb. Do not shake or rotate the bulb when removing it.
6. Install the new bulb in the reverse order of removal.

**⚠ CAUTION:**

- When handling the bulb, do not touch the glass envelope.
- Use the same number and wattage as originally installed:

**Halogen headlight model**

**High beam bulb: 60W (H4)**

**Low beam bulb: 55W (H4)**

- Do not leave the bulb out of the headlight reflector for a long period of time as dust, moisture and smoke may enter the headlight body and affect the performance of the headlight.

Aiming adjustment is not necessary if only the bulbs are replaced. When aiming adjustment is necessary, contact a NISSAN dealer.

**EXTERIOR LIGHTS**

Item	Wattage (W)
Front turn signal light	21
Front clearance light	5
Front fog light (if equipped)	55
Side turn signal light	5
Rear combination lights	
Turn signal light	21
Stop/Tail light	LED* or 21/5
Reverse light (for Thailand, Brunei, Hong Kong and Micra for India)	16
Reverse light (except for Thailand, Brunei, Hong Kong and Micra for India)	21
Rear fog light (if equipped)	21
High-mounted stop light	LED* or 16
License plate light	5

## INTERIOR LIGHTS

Item	Wattage (W)
Room light	5
Cargo light (if equipped)	5

\*: See a NISSAN dealer for replacement.



## LIGHT LOCATIONS

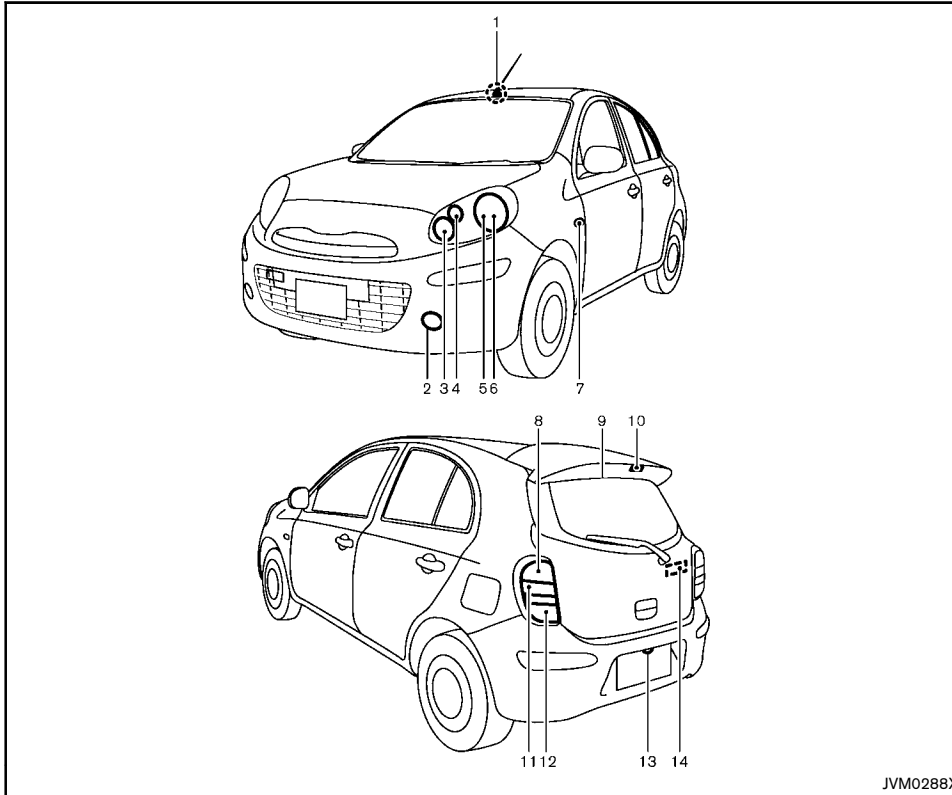

Type A

1. Interior light
2. Front fog light (if equipped)
3. Front turn signal light
4. Clearance light (for Micra Active)
5. Clearance light (except for Micra Active)
6. Headlight
7. Side turn signal light
8. Stop/tail light
9. High-mounted stop light (Model without rear spoiler)
10. High-mounted stop light (Model with rear spoiler)
11. Rear turn signal light
12. Reverse light or Rear fog light (if equipped)\*
13. License plate light
14. Cargo light (if equipped)

\*: For the Left-Hand Drive (LHD) model. On the Right-Hand Drive (RHD) model, the rear fog light is located on the opposite side.

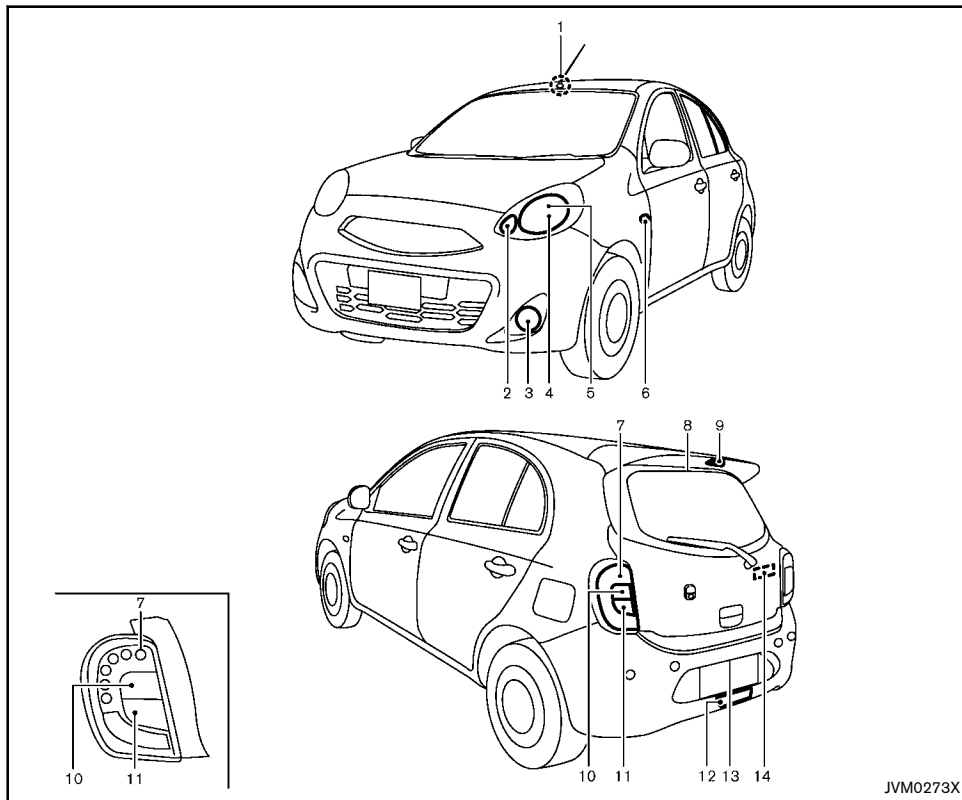

1. Interior light
2. Front turn signal light
3. Front fog light (if equipped)
4. Clearance light
5. Headlight
6. Side turn signal light
7. Stop/tail light
8. High-mounted stop light (Model without rear spoiler)
9. High-mounted stop light (Model with rear spoiler)
10. Rear turn signal light
11. Reverse light
12. Rear fog light (if equipped)
13. License plate light
14. Cargo light (if equipped)

**Type B**

JVM0273X

## Replacement procedures

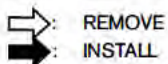
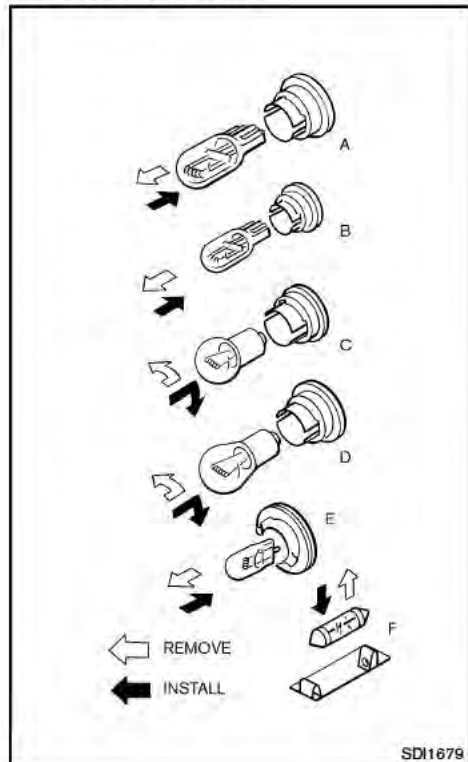

All other lights are either type A, B, C, D, E or F. When replacing a bulb, first remove the lens and/or cover.

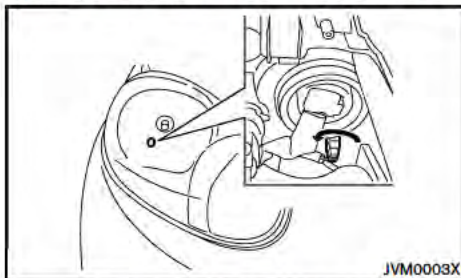

Clearance light (Type A) (example)

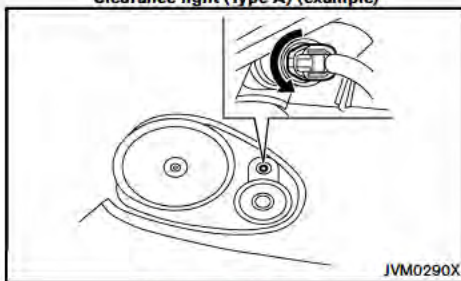

Clearance light (Type B)

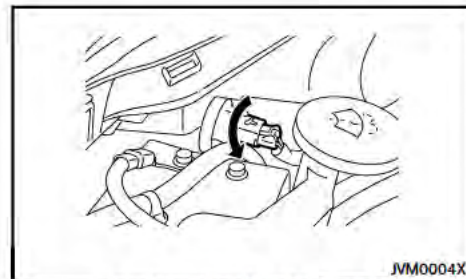

Front turn signal light (example)

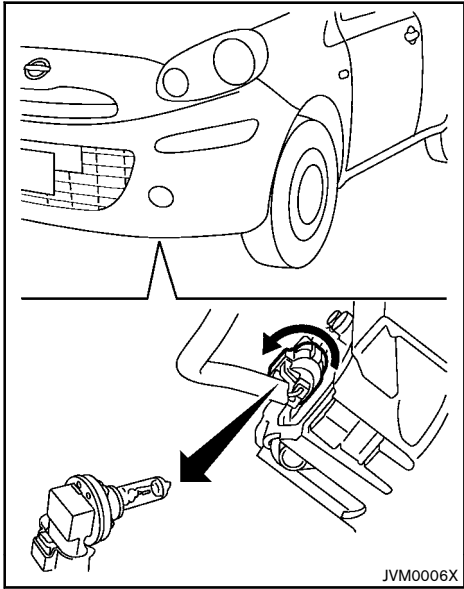

**Front fog light (if equipped) (Type A)**

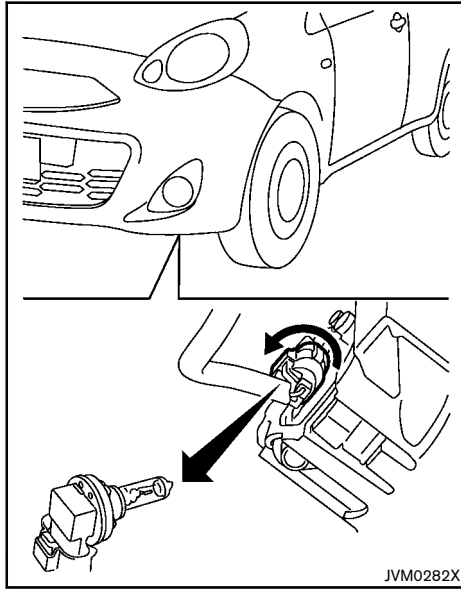

**Front fog light (if equipped) (Type B)**

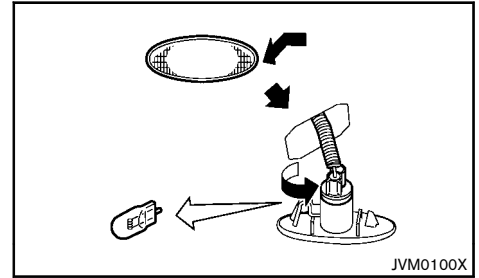

**Side turn signal light**

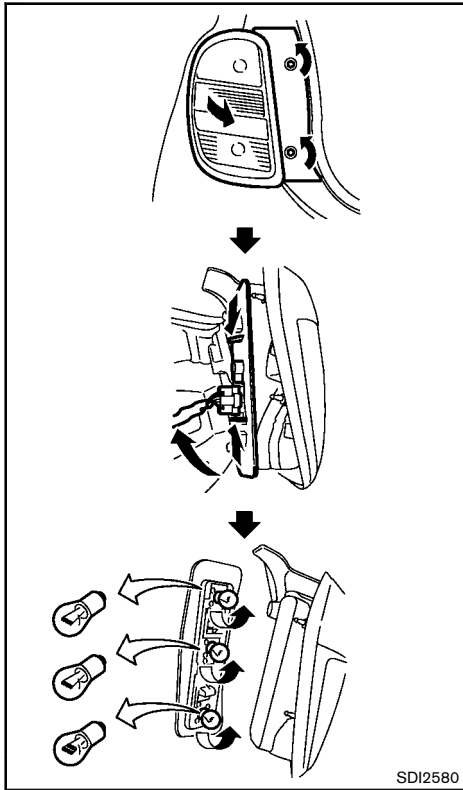

Rear combination light (Type A)

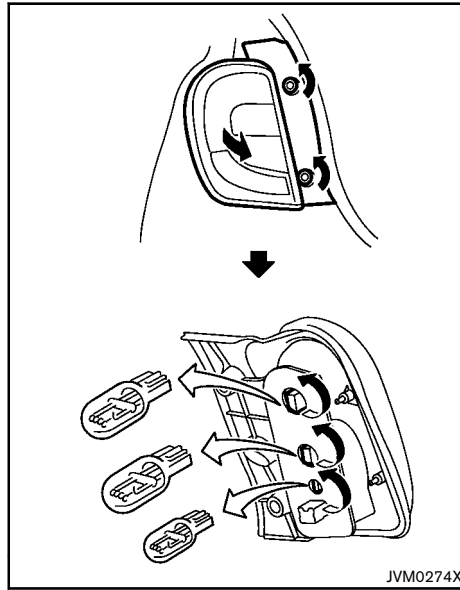

Rear combination light (Type B)

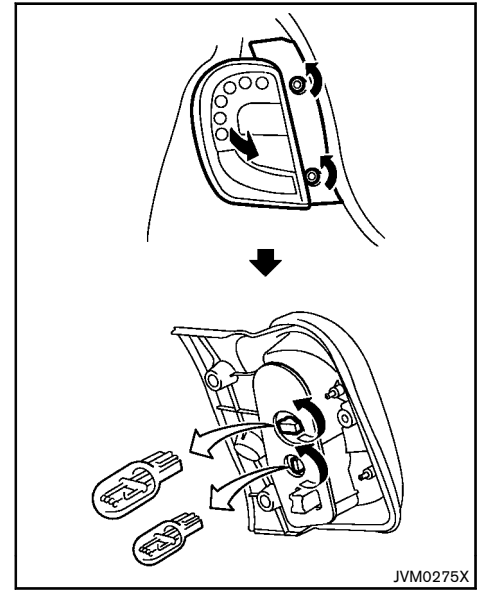

Rear combination light (Type C)

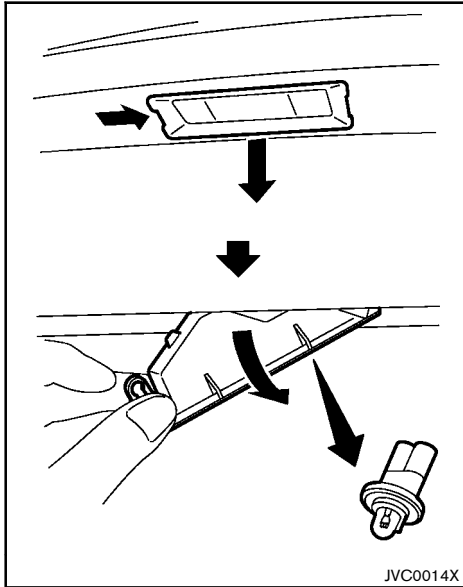

JVC0014X

License plate light (Type A)

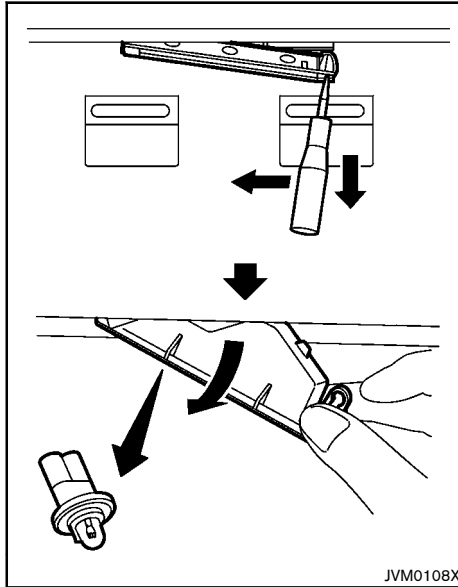

JVM0108X

License plate light (Type B)

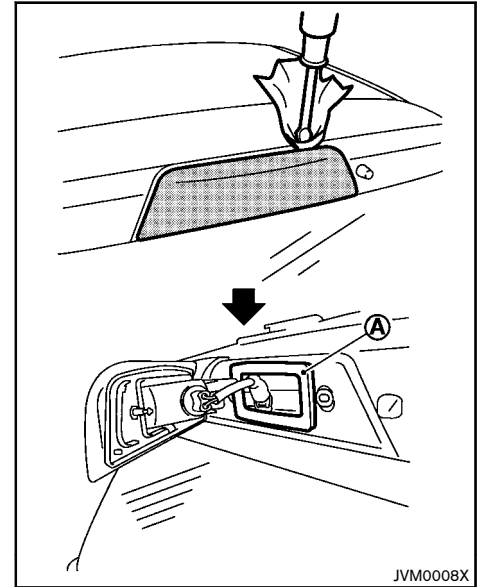

JVM0008X

High-mounted stop light (model with rear spoiler)



**CAUTION:**

**Do not reuse the packing on the back of the high-mounted stop light. When installing, the packing must be replaced with a new one.**

To replace the high-mounted stop light bulb:

1. Remove the light with a suitable tool.
2. Remove the bulb socket and then replace the bulb.

3. Replace the packing (A).
4. Install in the reverse order of removal.

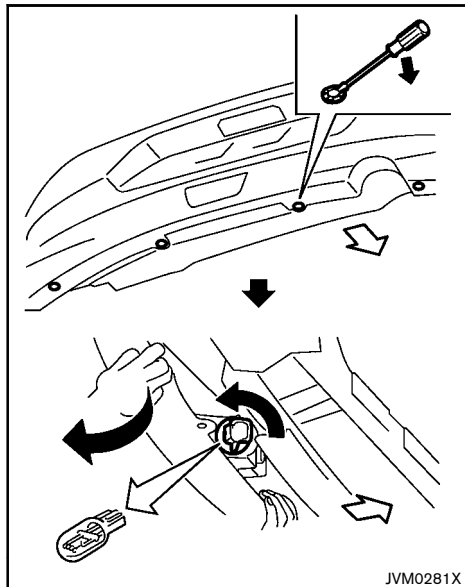

JVM0281X

**Rear fog light (if equipped)**

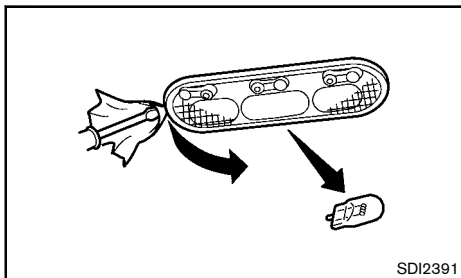

SDI2391

**Room light**

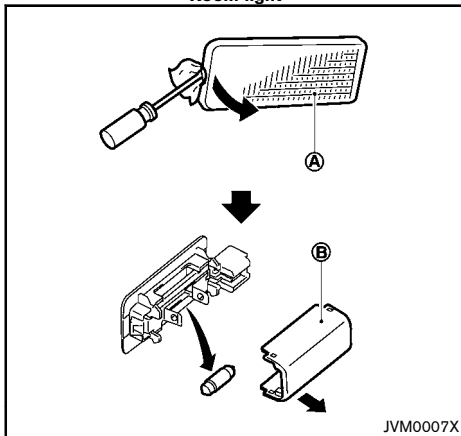

JVM0007X

**Cargo light (if equipped)**

To replace the cargo light bulb (if equipped):

1. Remove the light (A) with a suitable tool.
2. Remove the cover (B).
3. Replace the bulb.

## LEGAL REQUIREMENT TO ADJUST HEADLIGHT BEAM

For India (Micra Active)

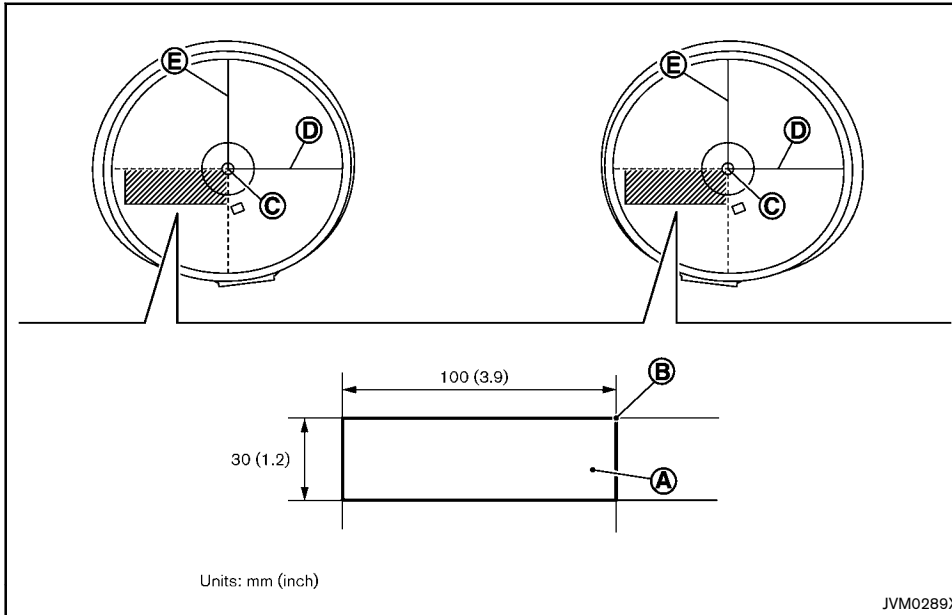

When the vehicle is driven in a country where the driving lane is different to your home country, affix an opaque sticker on the headlight.

1. Turn the ignition switch to the "OFF" position and wait until the headlights cool down.
2. Prepare the stickers referring to the figure. Make the stickers (A) that will be affixed to the surface

of the right side headlight and the left side headlight.

### NOTE:

- Use an opaque material that prevents the light from passing through it.
- Note that transparent materials do not work effectively.

3. Affix the sticker by aligning the corner (B) of the sticker with the position of the mark (C) that is located on the surface of the headlight seen from front.

Affix the sticker as illustrated by aligning the mark (C) with dividing lines (D) and (E).

### NOTE:

Align the mark (C) with the center mark (C) of the headlight bulb.



For India (except for Micra Active)

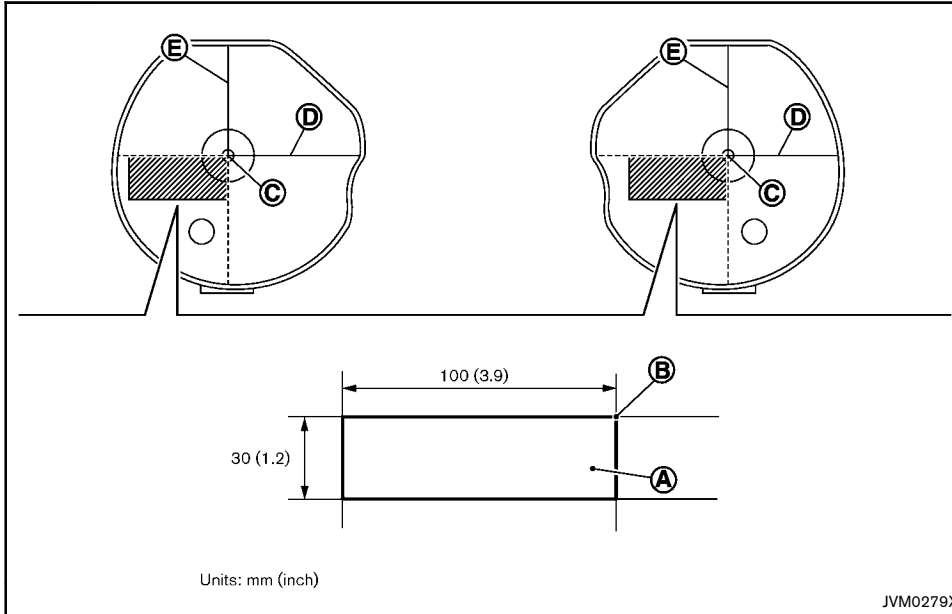

Affix the sticker as illustrated by aligning the mark **(C)** with dividing lines **(D)** and **(E)**.

**NOTE:**

**Align the mark (C) with the center mark of the headlight bulb.**

When the vehicle is driven in a country where the driving lane is different to your home country, affix an opaque sticker on the headlight.

1. Turn the ignition switch to the "OFF" position and wait until the headlights cool down.
2. Prepare the stickers referring to the figure. Make the stickers **(A)** that will be affixed to the surface of the right side headlight and the left side headlight.

**NOTE:**

- Use an opaque material that prevents the light from passing through it.
  - Note that transparent materials do not work effectively.
3. Affix the sticker by aligning the corner **(B)** of the sticker with the position of the mark **(C)** that is located on the surface of the headlight seen from front.

For Thailand, Brunei and Hong Kong

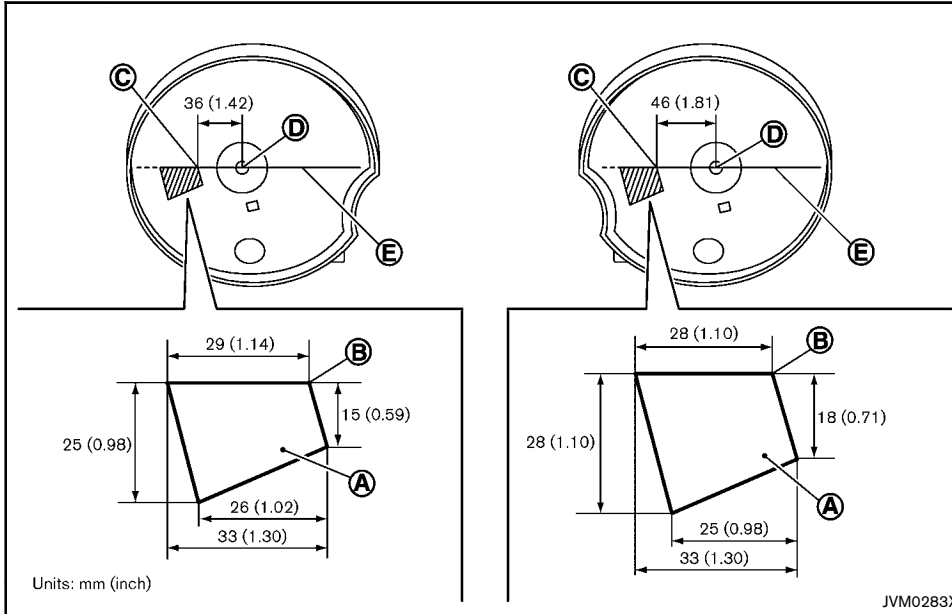

When the vehicle is driven in a country where the driving lane is different to your home country, affix an opaque sticker on the headlight.

1. Turn the ignition switch to the "OFF" position and wait until the headlights cool down.
2. Prepare the stickers referring to the figure. Make the stickers **(A)** that will be affixed to the surface of the right side headlight and the left side headlight.

**NOTE:**

- Use an opaque material that prevents the light from passing through it.
  - Note that transparent materials do not work effectively.
3. Using a marker pen or similar, put a mark **(C)** on the surface of the headlight that will be used as a guide for attaching the sticker **(A)** to the headlight. The mark **(C)** is placed 36 mm (1.42 inch) or

46 mm (1.81 inch) to the left of the mark **(D)** on the surface of the headlight seen from front.

4. Affix the sticker by aligning the corner **(B)** of the sticker with the position of the mark **(C)**. Affix the sticker as illustrated by aligning the mark **(C)** with dividing lines **(E)**.

**NOTE:**

Align the mark **(D)** with the center mark **(O)** of the headlight bulb.

## TIRES AND WHEELS

If you have a flat tire, see “Flat tire” (P.6-2).

### TIRE INFLATION PRESSURE

Periodically check the pressure of the tires, including the spare. An incorrect tire pressure may adversely affect tire life and vehicle handling. The tire pressure should be checked when tires are COLD. Tires are considered COLD after the vehicle has been parked for 3 or more hours, or driven less than 1.6 km (1 mile). COLD tire pressures are shown on the tire placard. (For the location of the tire placard, see “Vehicle identification” (P.9-9).)

Insufficient pressure can lead to an overheating of the tire and subsequent internal damage. At high speeds, this could result in tread separation and even bursting of the tire.

### TYPES OF TIRES



#### CAUTION:

**When changing or replacing tires, be sure all four tires are of the same type (that is, summer, all season or snow) and construction. A NISSAN dealer may be able to help you with information about tire type, size, speed rating and availability.**

Replacement tires may have a lower speed rating than the factory equipped tires, and they may not match the potential maximum vehicle speed. Never exceed the maximum speed rating of the tire.

### All season tires

NISSAN specifies all season tires on some models to provide good performance all year, including snowy and icy road conditions. All season tires are identified by ALL SEASON and/or M&S on the tire sidewall. Snow tires have better snow traction than all season tires and may be more appropriate in some areas.

### Summer tires

NISSAN specifies summer tires on some models to provide superior performance on dry roads. Summer tire performance is substantially reduced in snow and ice. Summer tires do not have the tire traction rating M&S on the tire sidewall.

If you plan to operate your vehicle in snowy or icy conditions, NISSAN recommends the use of snow or all season tires on all four wheels.

### Snow tires

If snow tires are needed, it is necessary to select tires equivalent in size and load rating to the original equipment tires. If you do not, it can adversely affect the safety and handling of your vehicle.

Generally, snow tires have lower speed ratings than factory equipped tires and may not match the potential maximum vehicle speed. Never exceed the maximum speed rating of the tire. If you install snow tires, they must be the same size, brand, construction and tread pattern on all four wheels.

For additional traction on icy roads, studded tires may be used. However, some states and provinces prohibit their use. Check local, state and provincial laws before installing studded tires. Skid and traction capabilities of studded snow tires on wet or dry surfaces may be poorer than that of non-studded snow tires.

### TIRE CHAINS

Use of tire chains may be prohibited according to location. Check the local laws before installing tire chains. When installing tire chains, make sure that they are of proper size for the tires on your vehicle and are installed according to the chain manufacturer's instructions.

Use chain tensioners when recommended by the tire chain manufacturer to ensure a tight fit. Loose end links of the tire chains must be secured or removed to prevent the possibility of whipping action damage to the fenders or underbody. If possible, avoid fully loading your vehicle when using tire chains. In addition, drive at a reduced speed. Otherwise, your vehicle may be damaged and/or vehicle handling and performance may be adversely affected.

Tire chains must be installed only on the front wheels and not on the rear wheels. Never install tire chains on a temporary-use spare tire (TEMPORARY USE ONLY). Do not use the chains on dry roads.

### TIRE ROTATION

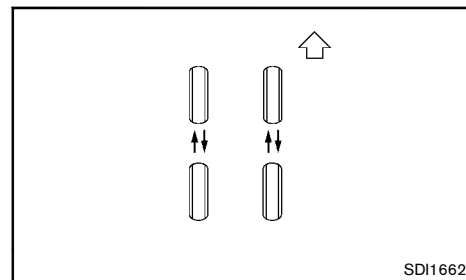

NISSAN recommends that tires be rotated every 10,000 km (6,000 miles). However, the timing for tire rotation may vary according to your driving habits and

the road surface conditions. (For the tire replacement, see "Flat tire" (P.6-2).)

**⚠ WARNING:**

- **After rotating the tires, adjust the tire pressure.**
- **Retighten the wheel nuts when the vehicle has been driven for 1,000 km (600 miles) (also in cases of a flat tire, etc.).**
- **Do not include the temporary-use spare tire in tire rotation.**
- **Incorrect tire selection, fitting, care or maintenance can affect vehicle safety with risk of accident and injury. If in doubt, consult a NISSAN dealer or the tire manufacturer.**

### TIRE WEAR AND DAMAGE

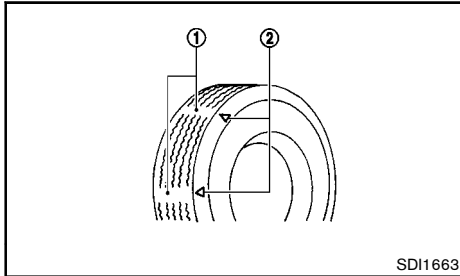

- ① Wear indicator
- ② Wear indicator location mark

Tires should be periodically inspected for wear, cracking, bulging or objects caught in the tread. If excessive wear, cracks, bulging or deep cuts are found, the tire should be replaced immediately.

The original tires have a built-in tread wear indicator.

When the wear indicator is visible, the tire should be replaced.

Improper service of a spare tire may result in serious personal injury. If it is necessary to repair the spare tire, contact a NISSAN dealer.

### TIRE AGE

Never use a tire over six years old, regardless of whether it has been used or not.

Tires degrade with age as well as with the vehicle usage. Have your tires checked and balanced often by a repair shop or, if you prefer, a NISSAN dealer.

### CHANGING TIRES AND WHEELS

**⚠ WARNING:**

**Do not install a deformed wheel or tire even if it has been repaired. Such wheels or tires could have structural damage and could fail without warning.**

When replacing a tire, use the same size, speed rating and load carrying capacity as originally equipped. (For recommended types and sizes of tires and wheels, see "Tires and wheels" (P.9-8).) The use of tires other than those recommended or the mixed use of tires of different brands, construction (bias, bias-belted, or radial), or tread patterns can adversely affect the ride, braking, handling, ground clearance, body-to-tire clearance, snow chain clearance, speedometer calibration, headlight aim and bumper height. Some of these effects may lead to accidents and could result in serious personal injury.

If the wheels are changed for any reason, always replace with wheels which have the same offset dimension. Wheels of a different offset could cause early tire wear, possibly degraded vehicle handling

characteristics and/or interference with the brake discs/drums. Such interference can lead to decreased braking efficiency and/or early brake pad/shoe wear.

### WHEEL BALANCE

Unbalanced wheels may affect vehicle handling and tire life. Even with regular use, wheels can get out of balance. Therefore, they should be balanced as required.

### SPARE TIRE

Conventional spare tire

A standard tire (the same size as the road wheels) is supplied with your vehicle.

Temporary-use spare tire (if equipped)

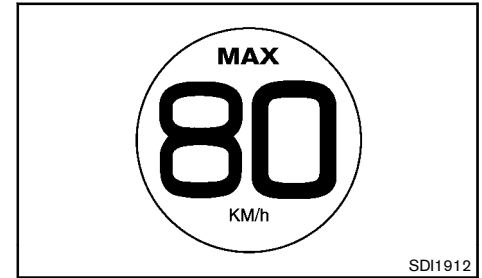

**Spare tire label (if equipped)**

Observe the following precautions if the spare tire must be used, otherwise your vehicle could be damaged or involved in an accident.

**⚠ CAUTION:**

- **The spare tire should be used only for emergency. It should be replaced by the standard tire at the first opportunity.**

- **Drive carefully while the spare tire is installed.**
- **Avoid sharp turns and abrupt braking while driving.**
- **Do not drive your vehicle at speeds faster than 80 km/h (50 MPH).**
- **Do not use tire chains on a spare tire. Tire chains will not fit properly on the spare tire and may cause damage to the vehicle.**
- **Tire tread of the spare tire will wear at a faster rate than the original tire. Replace the spare tire as soon as the tread wear indicators appear (except for India).**
- **Because the spare tire is smaller than the original tire, ground clearance is reduced. To avoid damage to the vehicle do not drive over obstacles. Also do not drive the vehicle through an automatic car wash since it may get caught.**
- **Do not use the spare tire on other vehicles.**
- **Do not use more than one spare tire at the same time.**
- **when the sealant has passed its expiration date**
- **when the cut or the puncture is approximately 6 mm (0.25 in) or longer**
- **when the side of the tire is damaged**
- **when the vehicle has been driven with a considerable loss of air from the tire**
- **when the tire is completely displaced inside or outside the rim**
- **when the tire rim is damaged**
- **when two or more tires are punctured**

See "Flat tire" (P.6-2).

## EMERGENCY TIRE PUNCTURE REPAIR KIT (if equipped)

The emergency tire repair kit is supplied to the vehicle instead of a spare tire. The kit must be used for temporarily fixing a minor tire puncture. After using the repair kit, see a NISSAN dealer as soon as possible for tire inspection and repair/replacement.



### **CAUTION:**

**Do not use the emergency tire repair kit under the following conditions. Call a NISSAN dealer or professional road assistance.**

**MEMO**

## **MEMO**

# 9 Technical information

Recommended fuel/lubricants and capacities .....	9-2	Uniform tire quality grading (if equipped) .....	9-11
Fuel recommendation .....	9-4	Treadwear .....	9-11
Recommended SAE viscosity number .....	9-4	Traction AA, A, B and C .....	9-11
Air conditioner system refrigerant and lubricant .....	9-5	Temperature A, B and C .....	9-11
Engine .....	9-6	Radio approval number and information .....	9-12
Tires and wheels .....	9-8	For Europe .....	9-12
Dimensions .....	9-8	For Croatia .....	9-12
When travelling or registering in another country .....	9-9	For Indonesia .....	9-14
Vehicle identification .....	9-9	For Thailand .....	9-14
Vehicle identification plate .....	9-9	For Morocco .....	9-15
Vehicle identification number (chassis number) .....	9-9	For Jordan .....	9-15
Vehicle identification number (VIN) plate (if equipped) .....	9-10	For South Africa .....	9-15
Engine serial number .....	9-10	For the United Arab Emirates .....	9-16
Certification label (if equipped) .....	9-10		
Tire placard .....	9-10		
Air conditioner specification label (if equipped) .....	9-11		



## RECOMMENDED FUEL/ LUBRICANTS AND CAPACITIES

The following are approximate capacities. The actual refill quantities may be slightly different. When refilling, follow the procedures instructed in the "8. Maintenance and do-it-yourself" section to determine the proper refill capacity.

Engine Type	Approximate Capacity		Recommended Fuel/Lubricants
	Metric Measure	Imperial Measure	
Fuel	41 L	9 gal	See "Fuel recommendation" (P.9-4).
Engine oil (*1)			
HR12DE HR15DE	including oil filter	3.0 L (except for Europe and CVT model for India) 3.4 L (for Europe and CVT model for India)	2-5/8 qt (except for Europe and CVT model for India) 3 qt (for Europe and CVT model for India)
	excluding oil filter	2.8 L (except for Europe and CVT model for India) 3.2 L (for Europe and CVT model for India)	2-1/2 qt (except for Europe and CVT model for India) 2-7/8 qt (for Europe and CVT model for India)
HR12DDR	including oil filter	3.9 L	3-3/8 qt
	excluding oil filter	3.7 L	3-1/4 qt
K9K	including oil filter	4.4 L	3-7/8 qt
	excluding oil filter	4.2 L	3-3/4 qt
Cooling system (including reservoir tank capacity 0.7 L)			
HR12DDR	MT model	5.4 L	4-3/4 qt
	CVT model	5.9 L	5-1/4 qt
HR12DE	MT model (for Thailand, Brunei, Singapore and Pakistan)	5.7 L	5 qt
	MT model (except for Thailand, Brunei, Singapore and Pakistan)	5.5 L	4-7/8 qt
	AT model	5.5 L	4-7/8 qt
	CVT model (for Thailand)	5.8 L	5-1/8 qt
HR15DE	CVT model (except for Thailand)	5.6 L	4-7/8 qt
	MT model	5.6 L	4-7/8 qt
	AT model	6.0 L	5-1/4 qt
Cooling system (including reservoir tank capacity 1.0 L)			
K9K	MT model	7.6 L	6-3/4 qt
Automatic Transmission Fluid (ATF)	—	—	Genuine NISSAN Matic S ATF (*5)
Continuously Variable Transmission (CVT) fluid	—	—	Except for Thailand, India, Brunei and Hong Kong: Genuine NISSAN CVT Fluid NS-2 (*6) For Thailand, India, Brunei and Hong Kong: Genuine NISSAN CVT Fluid NS-3 (*7)
Manual Transmission (MT) gear oil	—	—	Genuine NISSAN Manual Transmission Fluid (MTF) HQ Multi 75W-85 or equivalent (*8)
Brake and clutch fluid	—	(*9)	—
			Genuine NISSAN Brake Fluid or equivalent DOT 3 or DOT4 (*10)

### 9-2 Technical information

Multi-purpose grease	—	—	NLGI No. 2 (Lithium soap base)
Air conditioner system refrigerant	—	—	HFC-134a (R-134a)
Air conditioner system lubricants	—	—	NISSAN A/C System Oil Type R or equivalent

- \*1: The approximate capacities listed are for refilling during an engine oil change. For additional information, see "Changing engine oil and oil filter" (P.8-11).
- \*2: For additional information, see "Recommended SAE viscosity number" (P.9-4).
- \*3: NISSAN recommends Genuine NISSAN Ester oil available at a NISSAN dealer. Genuine NISSAN Ester oil is the best choice for optimum fuel economy.
- \*4: Use Genuine NISSAN Engine Coolant or equivalent in its quality, in order to avoid possible aluminum corrosion within the engine cooling system caused by the use of non-genuine engine coolant.  
**Note that any repairs for the incidents within the engine cooling system while using non-genuine engine coolant may not be covered by the warranty even if such incidents occurred during the warranty period.**
- \*5: **Using automatic transmission fluid other than Genuine NISSAN Matic S ATF will cause deterioration in driveability and automatic transmission durability, and may damage the automatic transmission, which is not covered by the warranty.**
- \*6: **Use only Genuine NISSAN CVT Fluid NS-2. Using transmission fluid other than Genuine NISSAN CVT Fluid NS-2 will damage the CVT, which is not covered by the warranty.**
- \*7: **Use only Genuine NISSAN CVT Fluid NS-3. Using transmission fluid other than Genuine NISSAN CVT Fluid NS-3 will damage the CVT, which is not covered by the warranty.**
- \*8: If Genuine NISSAN Manual Transmission Fluid (MTF) HQ Multi is not available, API GL-4, Viscosity SAE 75W-85 may be used as a temporary replacement. However, use Genuine NISSAN Manual Transmission Fluid (MTF) HQ Multi as soon as it is available.
- \*9: Refill to the proper fluid level according to the instructions in the "8. Maintenance and do-it-yourself" section.
- \*10: For details, see the brake fluid reservoir cap or the caution label attached to the brake fluid reservoir or the underside of the hood. Never mix different types of fluids (DOT3 and DOT4).

## FUEL RECOMMENDATION

Gasoline engine (model with three-way catalyst)



### CAUTION:

**Do not use leaded gasoline. Using leaded gasoline will damage the three-way catalyst.**

Except for Europe, Ukraine, Sri Lanka and Thailand: Use UNLEADED REGULAR gasoline with an octane rating of at least 91 (RON).

For Europe, Ukraine and Sri Lanka: Use UNLEADED PREMIUM gasoline with an octane rating of at least 95 (RON).

If unleaded premium gasoline is not used, UNLEADED REGULAR gasoline with an octane rating of at least 91 (RON) may be used at slightly reduced performance. However, for maximum vehicle performance and the best driveability, the use of unleaded premium gasoline is recommended.

For Thailand: Use UNLEADED REGULAR gasoline or gasohol (up to E20\*) of at least 91 octane (RON).

\*: Gasohol is alcohol blended gasoline. For example, "E20" is a mixture of approximately 20% fuel ethanol and 80% unleaded gasoline.

### Diesel engine\*

Use diesel fuel of at least 50 cetane.

\* If two types of diesel fuel are available, use summer or winter fuel properly according to the following temperature conditions.

- Above  $-7^{\circ}\text{C}$  ( $20^{\circ}\text{F}$ ) ... Summer type diesel fuel.
- Below  $-7^{\circ}\text{C}$  ( $20^{\circ}\text{F}$ ) ... Winter type diesel fuel.



### CAUTION:

- **Do not use home heating oil, gasoline or other alternate fuels in your diesel engine. The use of those or adding those to diesel fuel can cause engine damage.**
- **Do not use summer fuel at temperatures below  $-7^{\circ}\text{C}$  ( $20^{\circ}\text{F}$ ). The cold temperatures will cause wax to form in the fuel. As a result, it may prevent the engine from running smoothly.**

## RECOMMENDED SAE VISCOSITY NUMBER

Gasoline engine oil

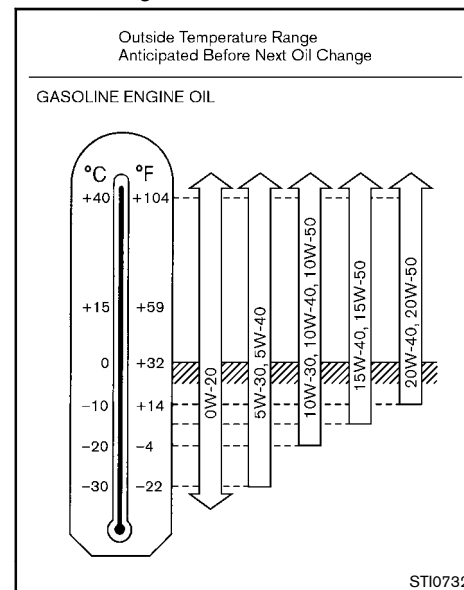

**For Europe, Ukraine and India (CVT model):**

**5W-30 is preferable.**

**If 5W-30 is not available, select the viscosity, from the chart, that is suitable for the outside temperature range.**

**For Hong Kong and Thailand:**

**0W-20 is preferable.**

**If 0W-20 is not available, select the viscosity, from the chart, that is suitable for the outside temperature range.**

**Except for Europe, Ukraine, Hong Kong, Thailand and India (CVT model):**

**10W-30 is preferable.**

**If 10W-30 is not available, select the viscosity, from the chart, that is suitable for the outside temperature range.**

**Diesel engine oil**

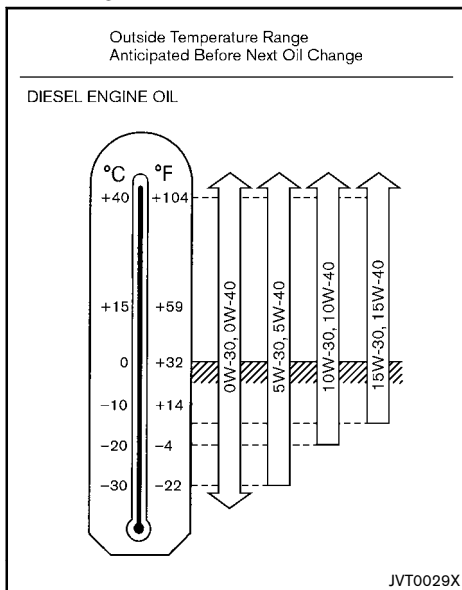

**5W-30 is preferable.**

**If 5W-30 is not available, select the viscosity, from the chart, that is suitable for the outside temperature range.**

## AIR CONDITIONER SYSTEM REFRIGERANT AND LUBRICANT

The air conditioner system of your vehicle must be charged with the refrigerant HFC-134a (R134a) and the lubricant NISSAN A/C System Oil Type R or equivalents. Use of any other refrigerants or lubricants will cause severe damage, and you may need to replace your vehicle's entire air conditioner system.

The release of refrigerants into the atmosphere is prohibited in many countries and regions. The refrigerant HFC-134a (R-134a) in your vehicle will not harm the Earth's ozone layer. However, it may contribute in a small part to the global warming effect. NISSAN recommends that the refrigerant be appropriately recovered and recycled. Contact a NISSAN dealer when servicing the air conditioner system.

## ENGINE

Engine Model		HR12DDR	HR12DE	HR15DE	K9K
Type		Gasoline, 4-cycle, DOHC	Gasoline, 4-cycle, DOHC	Gasoline, 4-cycle, DOHC	Diesel, 4-cycle
Cylinder arrangement		3-cylinder, in-line	3-cylinder, in-line	4-cylinder, in-line	4-cylinder, in-line
Bore × Stroke	mm (in)	78.0 × 83.6 (3.071 × 3.291)	78.0 × 83.6 (3.071 × 3.291)	78.0 × 78.4 (3.071 × 3.087)	76.0 × 80.5 (2.992 × 3.169)
Displacement	cm <sup>3</sup> (cu in)	1,198 (73.10)	1,198 (73.10)	1,498 (91.41)	1,461 (89.15)
Idle speed at the "N" (Neutral) position	rpm	CVT: 775±50	CVT: 750±50	MT: 650±50	MT: 800±50
		MT: 750±50	MT: 750±50 (*1) (*3) MT: 860±50 (*2)(*6)(*7) (*9) AT: 775±50 (*6)		
Ignition timing (B.T.D.C.)		CVT: 11°±2°	CVT: 9°±2°	MT: 5°±2°(*7) AT: 5°±2°	—
		MT: 11°±2°	MT: 12°±2° AT: 8°±2°		
Spark plugs	Standard	DILKAR7E11HS	FXE20HR11 (*1)	REA12WMB4	—
			REA12WMB4 (*3)(*8) REA12MC4 (*4)(*6)(*7) (*9) DILKAR6A11 (*5)		
Spark plug gap	mm (in)	1.1 (0.043)	1.1 (0.043)	1.1 (0.043)	—
Camshaft operation		Timing chain	Timing chain	Timing chain	Timing belt
Maximum vehicle speed (for Gulf standard models)*10					
	MT: km/h (MPH)	—	—	180 (112)	—
	AT: km/h (MPH)	—	—	170 (106)	—

\*1: For Thailand, Singapore (MT model), Indonesia (MT model) and Brunei

\*2: For India, Australia and New Zealand

\*3: For Europe

\*4: For India (MT model), Australia, New Zealand, Singapore (AT model) and Indonesia (AT model)

\*5: For Hong Kong

\*6: For Pakistan and Ukraine

\*7: For South Africa

\*8: For India (CVT model)

## 9-6 Technical information

- \*9: Except for Thailand, Singapore (MT model), Indonesia (MT model), Brunei, India, Australia, New Zealand, Europe, Hong Kong, Pakistan, Ukraine and South Africa
- \*10: Gulf Standard regulation requires automobile manufacturers to indicate the maximum vehicle speed for applicable models. The maximum vehicle speed, listed above, is the measured speed under certain testing conditions. The actual value may differ according to the vehicle usage and road and environmental conditions. NISSAN recommends you to ALWAYS observe posted speed limits and never drive too fast for conditions.

## TIRES AND WHEELS

		Standard	Spare*1
Tire size		155/80 R13 79S	155/80 R13 79S
		165/70 R14 81S	165/70 R14 81S T115/70 D14 88M T105/70 D14 83M
		175/60 R15 81H	165/70 R14 81S 175/60 R15 81H T115/70 D14 88M
		Size	Offset mm (in)
Road wheel	Steel	13 X 4-1/2B	40 (1.57)
		14X 4T	40 (1.57)
		14 X 5-1/2J	45 (1.77)
		15X 5-1/2J	50 (1.97)
	Aluminum alloy wheel	15X 5-1/2J	50 (1.97)

\*1: The tire puncture repair kit is supplied for Europe (if equipped).

For India:

Tires & tubes fitted in the vehicle, as per clause 3(c) & 3(e) meet the requirement of BIS and comply with the requirements under the Central Motor Vehicle Rules (CMVR), 1989.

## DIMENSIONS

		Unit: mm (in)
Overall length		3,780 (148.8)
		3,801 (149.6)*1
Overall width		1,665 (65.6)
		1,675 (65.9)*2*3
Overall height		1,489 (58.6)*1*4
		1,525 (60.0)*5
		1,520 (59.9)*2*6*7
		1,515 (59.6)*8
Front tread		1,470 (57.9)*9
		1,460(57.5)*10
		1,475 (58.1)*11
Rear tread		1,475 (58.1)*9
		1,465(57.7)*10
		1,485(58.5)*11
Wheelbase		2,435 (95.9)*12
		2,440 (96.1)*13
		2,450 (96.5)*14

\*1: For Micra Active (for Sports version)

\*2: For Europe (for model with side molding)

\*3: For the Middle East (for model with side molding)

\*4: For Micra Active (except for Sports version)

\*5: For the Middle East (for model with Manual Transmission and without side molding)

\*6: For South Africa and Thailand

\*7: For the Middle East (except for model with Manual Transmission and without side molding)

\*8: For Hong Kong

\*9: For 165/70R14 tire model

\*10: For 175/60R15 tire model

\*11: For 155/80R13 tire model

\*12: For Australia and New Zealand (for 175/60R15 tire model)

## WHEN TRAVELLING OR REGISTERING IN ANOTHER COUNTRY

\*13: For Europe, the Middle East, South Africa, Australia (except for 175/60R15 tire model) and New Zealand (except for 175/60R15 tire model)

\*14: Except for Europe, the Middle East, South Africa, Australia and New Zealand

**When planning to travel in another country or region**, find out whether the fuel required for your vehicle is available in that country or region. Using a low octane rated fuel may cause engine damage. Therefore, be sure that the required fuel is available wherever you go. For additional information regarding recommended fuel, see earlier in this section.

**When transferring the registration of your vehicle to another country, state, province or district**, contact the appropriate authorities to find out that the vehicle complies with the local legal requirements. In some cases, a vehicle cannot meet the legal requirements, and it may be necessary to modify the vehicle to meet local laws and regulations. In addition, there may be possibilities that a vehicle cannot be adapted in certain areas.

The laws and regulations for motor vehicle emission control and safety standards vary according to the country, state, province or district; therefore, the vehicle specification may differ.

**When any vehicles are to be taken into another country, state, province or district, its modification, transportation, registration, and any other expenses which may result, are the responsibility of the user. NISSAN is not responsible for any inconveniences that may result.**

## VEHICLE IDENTIFICATION

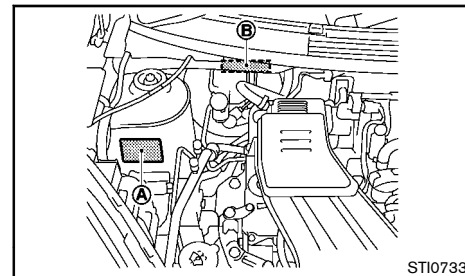

### VEHICLE IDENTIFICATION PLATE

The plate is affixed as shown (A) .

### Built date plate (for Australia and New Zealand)

Built date is stamped on the vehicle identification plate.

The built date means the calendar month and the year in which the body shell and power train subassemblies are conjoined and the vehicle is driven or moved from the production line.

### VEHICLE IDENTIFICATION NUMBER (chassis number)

The number is stamped as shown (B) .



VEHICLE IDENTIFICATION NUMBER (VIN)  
PLATE (if equipped)

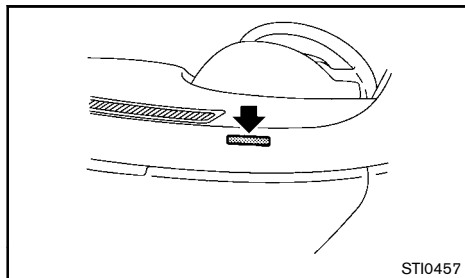

The plate is affixed as shown.

ENGINE SERIAL NUMBER

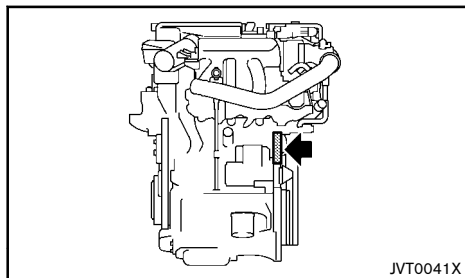

**HR12DDR engine**

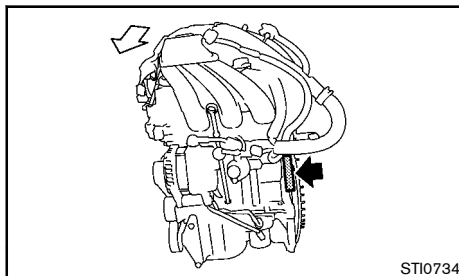

**HR12DE engine**

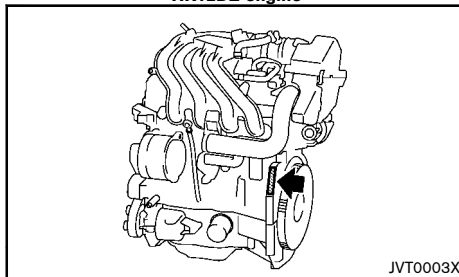

**HR15DE engine**

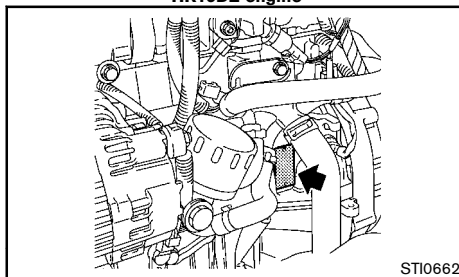

**K9K engine**

The engine serial number is stamped on the engine as

shown.

CERTIFICATION LABEL (if equipped)

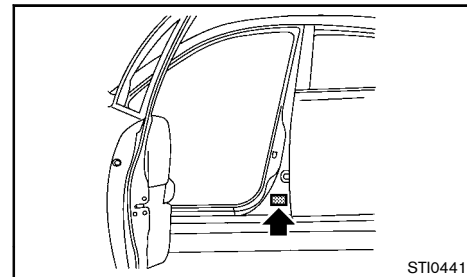

TIRE PLACARD

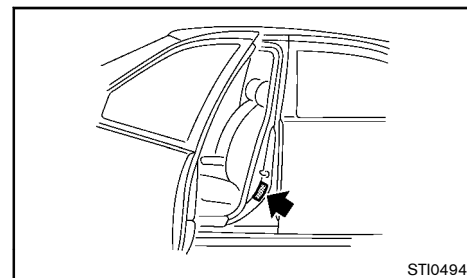

The cold tire pressures are shown on the tire placard affixed to the driver's side center pillar.

## AIR CONDITIONER SPECIFICATION LABEL (if equipped)

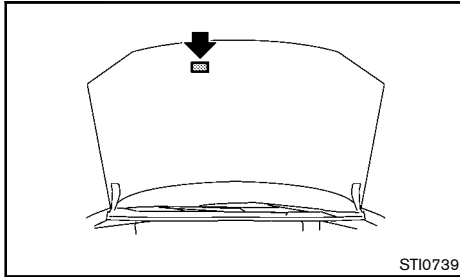

## UNIFORM TIRE QUALITY GRADING (if equipped)

Quality Grades: All passenger car tires must conform to local safety requirements in addition to these grades.

Quality grades can be found where applicable on the tire sidewall between tread shoulder and maximum section width. For example:

**Treadwear 200 Traction AA Temperature A**

### TREADWEAR

The treadwear grade is a comparative rating based on the wear rate of the tire when tested under controlled conditions on a specified government test course. For example, a tire graded 150 would wear one and one-half (1 1/2) times as well on the government course as a tire graded 100. The relative performance of tires depends upon the actual conditions of their use, however, and may depart significantly from the norm due to variations in driving habits, service practices and differences in road characteristics and climate.

### TRACTION AA, A, B AND C

The traction grades, from highest to lowest, are AA, A, B, and C. Those grades represent the tire's ability to stop on wet pavement as measured under controlled conditions on specified government test surfaces of asphalt and concrete. A tire marked C may have poor traction performance.



#### **WARNING:**

**The traction grade assigned to this tire is based on straight-ahead braking traction tests, and does not include acceleration, cornering, hydroplaning, or peak traction characteristics.**

### TEMPERATURE A, B AND C

The temperature grades are A (the highest), B, and C, representing the tire's resistance to the generation of heat and its ability to dissipate heat when tested under controlled conditions on a specified indoor laboratory test wheel. Sustained high temperature can cause the material of the tire to degenerate and reduce tire life, and excessive temperature can lead to sudden tire failure. The grade C corresponds to a level of performance which all passenger car tires must meet under the local regulations. Grades B and A represent higher levels of performance on the laboratory test wheel than the minimum required by law.



#### **WARNING:**

**The temperature grade for this tire is established for a tire that is properly inflated and not overloaded. Excessive speed, under-inflation, or excessive loading, either separately or in combination, can cause heat build-up and possible tire failure.**

## RADIO APPROVAL NUMBER AND INFORMATION

### FOR EUROPE

Remote keyless entry system (if equipped)

Hereby, ALPS ELECTRIC CO.,LTD. declares that these Keyless and TPMS TUNER; model TWC1G124 and Keyless Transmitter; model TWB1U761 are in compliance with the essential requirements and other relevant provisions of Directive 1999/5/EC.

 **CAUTION:**

**Do not exposed to excessive heat such as sunshine, fire or the like.**

 **CAUTION:**

**Danger of explosion if battery is incorrectly replaced. Replace only with the same or equivalent type.**



Intelligent Key system (if equipped)

Hereby, ALPS ELECTRIC CO.,LTD. declares that these Passive Entry System(Hand Unit);model TWB1G662, Passive Entry System(Tuner);model TWC1G135, ANT ASSY-IMMOBILISER;model TWK1A002 are in compliance with the essential requirements and other relevant provisions of Directive 1999/5/EC.

 **CAUTION:**

**Do not exposed to excessive heat such as sunshine, fire or the like.**

 **CAUTION:**

**Danger of explosion if battery is incorrectly replaced. Replace only with the same or equivalent type.**



NISSAN Anti-Theft System (NATS) immobilizer

Hereby, CalsonicKansei Corp. declares that this ANT ASSY-IMMOBILISER;model MW1014 is in compliance with the essential requirements and other relevant provisions of Directive 1999/5/EC.

 **CAUTION:**

**Do not exposed to excessive heat such as sunshine, fire or the like.**

 **CAUTION:**

**Danger of explosion if battery is incorrectly replaced. Replace only with the same or equivalent type.**



### FOR CROATIA

Remote keyless entry system (if equipped)

IZJAVA O SUKLADNOSTI	
<i>RENAULT NISSAN HRVATSKA d.o.o.</i>	
ADRESA:	Radnička cesta 47, 10000 Zagreb, Croatia
MATIČNI BROJ SUBJEKTA (MBS):	080005703
<i>Pod punom odgovornošću izjavljujemo da je radijska oprema i telekomunikacijska terminalna (RTT) oprema</i>	
OPIS OPREME:	TPMS/RF prijamnik
TIPSKA OZNAKA OPREME:	TWC1G124
MARKETINŠKI IME OPREME:	
PROIZVOĐAČ OPREME:	Alps Electric Co.,Ltd
<i>sukladna s bitnim zahtjevima iz članka 4. Pravilnika o radijskoj opremi i telekomunikacijskoj opremi ("Narodne Novine", br. 112/2009), odnorno primjenjenim normama:</i>	
EN 300 220-1 V2.1.1: 2006-04 / EN 300 220-2 V2.1.2: 2007-06 EN 301 459-1 V1.8.1: 2008-04 / EN 301 459-3 V1.4.1: 2002-08 EN 60955:2002 +Amd. 1: 2006, EN 60955:2002 +Amd 11: 2008	
NI NISSAN HRVATSKA Korisnička cesta 47 ZAGREB	
Zagreb, 27.11.2009.	<i>Mihailo Dinko</i>
Mjesto i datum	Zag i potpis odgovorne osobe

JVT0008X

## IZJAVA O SUKLADNOSTI

RENAULT NISSAN HRVATSKA d.o.o.

ADRESA: Radnička cesta 47, 10000 Zagreb  
MATIČNI BROJ SUBJEKTA (MBS): 080006703

Pod punom odgovornošću izjavljujemo da je radijska oprema i telekomunikacijska terminala (R&T) oprema

OPIS OPREME:	Održiva i sigurna za daljinsko upravljanje vozila
TIPIJSKA OZNAKA OPREME:	TWB1U761
MARKETINSKO IME OPREME:	
PROIZVOĐAČ OPREME:	Alps Electric Co., Ltd.

sukladna s bitnim zahtjevima iz članka 4. Pravilnika o radijskoj opremi i telekomunikacijskoj opremi ("Narodne Novine", br. 112/2008), odnosno primjenjenim normama:

EN 300 220-1 V2.1.1:2008-04/ EN 300 220-2 V2.1.2:2007-08  
EN301 489-1 V1.8.1:2008-04/ EN301 489-3 V1.4.1:2002-08  
IEC 60965-2001+Amd.1:2005/ EN 60065:2002+Amd. 1

RENAULT NISSAN HRVATSKA d.o.o.  
Radnička cesta 47  
ZAGREB

Zagreb, 16.10.2008  
Mjesto i datum

*Mihalo Dinkić*  
Zig i potpis odgovorne osobe

JVT0009X



## Intelligent Key system (if equipped)

### IZJAVA O SUKLADNOSTI

RENAULT NISSAN HRVATSKA d.o.o.

ADRESA: Radnička cesta 47, Zagreb  
MATIČNI BROJ SUBJEKTA (MBS): 080006703

Pod punom odgovornošću izjavljujemo da je radijska oprema i telekomunikacijska terminala (R&T) oprema

OPIS OPREME:	Sustav za daljinsko uključivanje/zatvaranje vožnje
TIPIJSKA OZNAKA OPREME:	TWB1G662 / TWG1G135
MARKETINSKO IME OPREME:	TWB1G262 / TWG1G135
PROIZVOĐAČ OPREME:	ALPS ELECTRIC CO. LTD.

sukladna s bitnim zahtjevima iz članka 4. Pravilnika o radijskoj opremi i telekomunikacijskoj opremi ("Narodne Novine", br. 112/2008), odnosno primjenjenim normama:

EN300 220-1 V2.1.1 / EN300 220-2 V2.1.2  
EN301 489-1 V1.8.1 / EN301 489-3 V1.4.1  
EN 60965:2002+Amd. 1

RENAULT NISSAN HRVATSKA d.o.o.  
Radnička cesta 47  
ZAGREB

Zagreb, 23.03.2008  
Mjesto i datum

*Mihalo Dinkić*  
Zig i potpis odgovorne osobe

JVT0010X

### IZJAVA O SUKLADNOSTI

(Declaration of Conformity)

U skladu s člankom 58. stavak 1. Zakona o elektromagnetskoj kompatibilnosti (EMC) (22/2004) i člankom 58. stavak 1. Zakona o telekomunikacijama (112/2008)

Renault Nissan Hrvatska

(IME/NAZIV OSOBE ODGOVORNE ZA STAVLJANJE NA TRŽIŠTE)  
(Name of the person responsible for placing on the market)

ADRESA (Address): Radnička cesta 47, 10000 Zagreb, Croatia  
MATIČNI BROJ SUBJEKTA (MBS): 88006103  
(MBS of the responsible person)

Pod punom odgovornošću izjavljujemo da je R&T oprema  
(Under full responsibility we declare that R&T equipment)

OPIS OPREME:	Inteligentni ključnik
TIPIJSKA OZNAKA OPREME:	TWB1A002
MARKETINSKO IME OPREME:	TWB1A002
PROIZVOĐAČ OPREME:	ALPS ELECTRIC CO., LTD.

sukladna s bitnim zahtjevima iz članka 98. stavak 3. Zakona o telekomunikacijama, odnosno primjenjenim normama:  
(in accordance with essential requirements of Article 98 paragraph 3 of the Law on Telecommunications, in applied standards)

EN300 330-1 V1.3.1:2001-06/ EN300 330-2 V1.3.1:2006-04  
EN201 489-1 V1.6.1:2006-09/ EN201 489-3 V1.4.1:2002-08  
EN 60965:2002+Amd. 1:2008

RENAULT NISSAN HRVATSKA d.o.o.  
Radnička cesta 47  
ZAGREB

Zagreb, 16.10.2008  
Mjesto i datum

*Mihalo Dinkić*  
Zig i potpis odgovorne osobe

080006703

JVT0011X



## NISSAN Anti-Theft System (NATS) immobilizer

**IZJAVA O SUKLADNOSTI**  
17. članka 4. stavak 25. Zakona 1. Zbornik 3. sveučilišnog lista (HR 132/2003)

RENAULT NISSAN HRVATSKA d.o.o.

ADRESA: Kraljevska 45, 10000 Zagreb  
MATIČNI BROJ / SUBJEKTA (MBS): 089906703

*Pod punom odgovornošću izjavujemo da je RITT oprema*

OPIS OPREME:	Sustav za imobilizaciju vozila
TIPSKA OZNAKA OPREME:	MW 1014
MARKETINŠKO IME OPREME:	MW 1014
PROIZVOĐAČ OPREME:	CalsonicKansei Corp.

*sukladna s bitnim zahtjevima iz članka 98, stavak 3. Zakona o telekomunikacijama, odnosno primjenjenim normama:*

EN 60959:2002;  
EN 301 493-1 V1.6.1:2004;  
EN 301 493-2 V1.6.1:2004;  
EN 300 335-1 V1.3.1:2004;  
EN 300 335-2 V1.3.1:2004.

RENAULT NISSAN HRVATSKA d.o.o.  
Radnička cesta 47  
Z A G R E B

Zagreb, 20.02.2008.  
Mjesto i datum

*Antonia Driks*  
Zig i potpis odgovorne osobe

Oprema J00028

JVT0012X



## FOR INDONESIA

Remote keyless entry system (if equipped)

14619/POSTEL/2010  
2425

JVT0013X

14854/POSTEL/2010  
2425

JVT0014X

## NISSAN Anti-Theft System (NATS) immobilizer

01737/POSTEL/2007  
1708

JVT0015X

## FOR THAILAND

This telecommunication equipment conforms to NTC technical requirement.

- Remote keyless entry system (if equipped)
- Intelligent Key system (if equipped)
- NISSAN Anti-Theft System (NATS) (if equipped)

## FOR MOROCCO

### Remote keyless entry system (if equipped)

AGREE PAR L'ANRT MAROC  
Numéro d'agrément : MR4382 ANRT 2008  
Date d'agrément : 18/08/2008

JVT0025X

AGREE PAR L'ANRT MAROC  
Numéro d'agrément : MR5084 ANRT 2009  
Date d'agrément : 19/10/2009

JVT0108X

## NISSAN Anti-Theft System (NATS) immobilizer

AGREE PAR L'ANRT MAROC  
Numéro d'agrément : MR4884 ANRT 2009  
Date d'agrément : 22/06/2009

JVT0026X

## FOR JORDAN

### Remote keyless entry system (if equipped)

Manufacturer:

ALPS ELECTRIC CO.,LTD.

Model:

TWC1G124

Type approval No.:

TRC/LPD/2008/125

## NISSAN Anti-Theft System (NATS) immobilizer

Manufacturer:

Calsonic Kansei Corporation

Model:

MW1014

Type approval No.:

TRC/LPD/2009/86

## FOR SOUTH AFRICA

### Remote keyless entry system (if equipped)



JVT0038X



JVT0039X

NISSAN Anti-Theft System (NATS) immobilizer

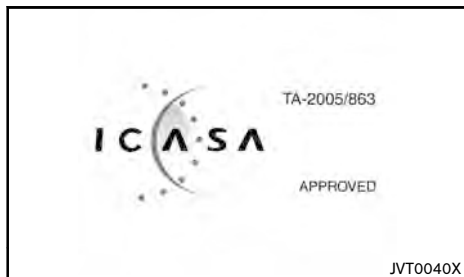

FOR THE UNITED ARAB EMIRATES

Remote keyless entry system (if equipped)

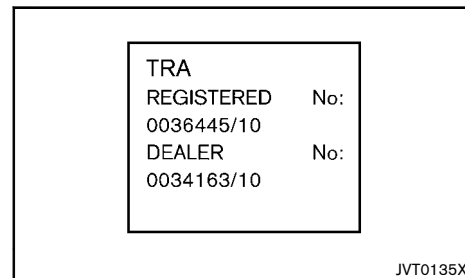
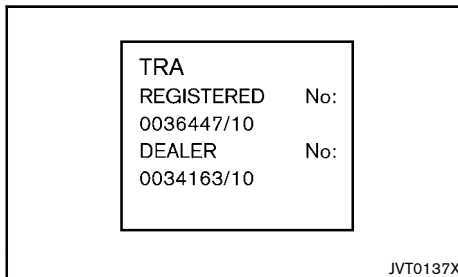

NISSAN Anti-Theft System (NATS) immobilizer

Intelligent Key system (if equipped)

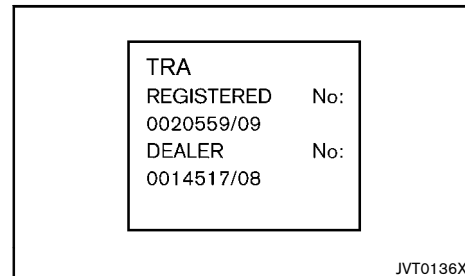
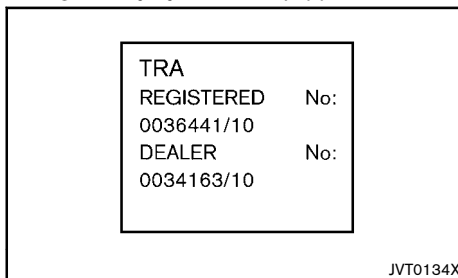

**MEMO**



## **MEMO**

# 10 Index

## A

Adjusting time.....	2-42
Air cleaner filter.....	8-21
Air conditioner	
Air conditioner specification label.....	9-11
Air conditioner system refrigerant and lubricant.....	9-5
Automatic air conditioner.....	4-9
Heater and air conditioner.....	4-6
Manual air conditioner.....	4-7
Monitor, Heater and air conditioner, and audio system.....	4-1
Servicing air conditioner.....	4-10
Antenna.....	4-19
Anti-lock Braking System (ABS).....	5-39
Anti-lock braking system (ABS) warning light.....	2-13
Anti-theft system.....	4-53, 4-58
Appearance care	
Exterior appearance care.....	7-2
Interior appearance care.....	7-3
Audible reminders.....	2-18
Audio operation precautions.....	4-11
Audio system.....	4-11
Steering wheel audio controls.....	4-63
Automatic	
Automatic transmission fluid (ATF).....	8-20
Automatic Transmission position indicator/Continuously Variable Transmission position indicator.....	2-10

## B

Back door.....	3-20
Battery.....	8-4, 8-24
Battery saver system.....	2-46
Intelligent Key.....	8-26
Intelligent Key battery discharge.....	5-8
Keyfob battery replacement.....	8-25, 8-26
Remote controller battery.....	8-25

Vehicle battery.....	8-24
Battery replacement	
Intelligent Key.....	8-26
Battery saver system.....	2-34
Before starting engine.....	5-3
Belts (See drive belts).....	8-16
Bleeding fuel system.....	8-16
Blocking wheels.....	6-3
Bluetooth® audio player operation.....	4-49
Bluetooth® Hands-Free Phone System.....	4-64
Board, Tonneau board.....	2-45
Brake	
Brake booster.....	8-19
Brake fluid.....	8-19
Brake precautions.....	5-38
Brake system.....	5-38
Brakes.....	8-18
Checking foot brake pedal.....	8-18
Checking parking brake.....	8-18
Parking brake.....	3-24
Parking brake operation.....	5-41
Warning light.....	2-13
Brake assist.....	5-39
Brake precautions.....	5-38
Brakes.....	8-18
Break-in schedule.....	5-3
Bulb replacement.....	8-3, 8-29

## C

Canceling cruising speed.....	5-32
Canceling speed limit.....	5-29
Car phone or CB radio.....	4-64
Card holder.....	2-44
Care when driving.....	5-5
Catalytic converter, Three way catalyst.....	5-4
CD changer operation.....	4-59
CD player operation.....	4-54
Center mark on seat belts.....	1-9
Center ventilators.....	4-5

Certification label.....	9-10
Changing	
Changing engine coolant.....	8-10
Changing engine oil and oil filter.....	8-11
Changing tires and wheels.....	8-43
Checking	
Checking bulbs.....	2-13
Checking engine coolant level.....	8-10
Checking engine oil level.....	8-11
Checking foot brake pedal.....	8-18
Checking parking brake.....	8-18
Child restraints.....	1-13
Child safety.....	1-8
Child safety rear door lock.....	3-7
Chimes, Audible reminders.....	2-18
Chrome parts.....	7-3
Circuit breaker, Fusible link.....	8-27
Cleaning exterior and interior.....	7-2, 7-3
Clock.....	2-42
Closing hood.....	3-19
Clutch fluid.....	8-20
Cold weather driving.....	5-40
Continuously Variable Transmission (CVT) fluid.....	8-21
Controls	
Steering wheel audio controls.....	4-63
Coolant	
Changing engine coolant.....	8-10
Checking engine coolant level.....	8-10
High temperature warning light.....	2-14
Corrosion protection.....	7-5
Cruise control.....	5-30
Cruise control display and indicators.....	5-31
Cruise control indicator (for Europe).....	2-21
Cup holders.....	2-44
Curtain side-impact air bag system.....	1-31
CVT	
Driving with CVT (Continuously Variable Transmission).....	5-5

**D**

Daytime light system.....	2-34
Defogger switch.....	2-39
Difference between predictive and actual distances.....	4-3
Dimensions.....	9-8
Door locks.....	3-5
Door open warning light.....	2-14
Draining water.....	8-16
Drive belts.....	8-16
Driving	
Care when driving.....	5-5
Cold weather driving.....	5-40
Driving in wet conditions.....	5-5
Driving in winter conditions.....	5-5
Driving with Continuously Variable Transmission (CVT).....	5-14
Driving with CVT (Continuously Variable Transmission).....	5-5
Driving with Manual Transmission (MT).....	5-17
Precautions when starting and driving.....	5-3
Driving vehicle.....	5-11

**E**

Elapsed time.....	2-28
Electric power steering system.....	5-37
Electric power steering warning light.....	2-14
Electronic Stability Program (ESP)	
OFF Switch.....	5-27
Electronic Stability Program (ESP) System.....	5-27
Emergency situations.....	3-5
Emergency tire puncture repair kit.....	6-6, 8-44
Engine	
Before starting engine.....	5-3
Break-in schedule.....	5-3
Changing engine coolant.....	8-10
Changing engine oil and oil filter.....	8-11
Checking engine coolant level.....	8-10
Checking engine oil level.....	8-11

Engine compartment check locations.....	8-6
Engine cooling system.....	8-9
Engine oil.....	8-11
Engine oil replacement indicator.....	2-25
Engine serial number.....	9-10
Engine specifications.....	9-6
Engine start operation indicator.....	2-20
High temperature warning light.....	2-14
If your vehicle overheats.....	6-11
Spark plugs.....	8-17
Engine cold start period.....	5-5
Engine start operation indicator (Manual Transmission models).....	2-21
Exhaust gas (carbon monoxide).....	5-3
Explanation of general maintenance items.....	8-3
Exterior lights.....	8-30

**F**

Fail-safe.....	5-14
Flat tire.....	6-2
Floor mat cleaning.....	7-4
Fluid	
Automatic transmission fluid (ATF).....	8-20
Brake fluid.....	8-19
Clutch fluid.....	8-20
Continuously Variable Transmission (CVT) fluid.....	8-21
Engine coolant.....	8-9
Engine oil.....	8-11
Window washer fluid.....	8-5, 8-23
FM-AM radio with Compact Disc (CD) player.....	4-20, 4-24, 4-29, 4-33, 4-38, 4-44
Fog light switch.....	2-36
Front fog lights.....	2-36
Front map lights.....	2-46
Front seats.....	1-2
Front-impact air bag system.....	1-30
Fuel	
Fuel filler cap.....	3-21
Fuel filler lid.....	3-20
Fuel gauge.....	2-10

Fuel octane rating.....	9-4
Fuel recommendation.....	9-4
Opening fuel filler lid.....	3-20
Recommended fuel/lubricants and capacities.....	9-2
Fuel filler cap.....	3-21
Fuel filler lid.....	3-20
Fuses.....	8-27
Fusible links.....	8-27

**G**

Gauge.....	2-6
Fuel gauge.....	2-10
Odometer.....	2-8
Speedometer.....	2-8
Tachometer.....	2-10
General maintenance.....	8-3
Glove box.....	2-44

**H**

Hazard indicator flasher switch.....	6-2
Head restraints.....	1-5
Headlight	
Headlight and turn signal switch.....	2-33
Headlights	
Bulb replacement.....	8-29
Headlight aiming control.....	2-34
Headlight switch.....	2-33
Heated seats.....	1-3
Heater and air conditioner.....	4-6
High temperature warning light.....	2-14
Hood release.....	3-19
Horn.....	2-40
How to read the displayed lines.....	4-2

**I**

Idling Stop OFF switch.....	5-21
Idling Stop System.....	5-19

Ignition switch	
Key positions.....	5-6
Ignition switch (model without intelligent	
Key system).....	5-5
Ignition switch positions.....	5-8
Indicator lights.....	2-16
Injured persons.....	1-9
Inside rearview mirror.....	3-21
Installing spare tire.....	6-5
Instrument panel.....	2-2
Intelligent Key.....	3-3
Intelligent Key battery.....	8-26
Intelligent Key battery discharge.....	5-8
Intelligent Key battery discharge indicator.....	2-21
Intelligent Key system.....	3-9, 5-6
Intelligent Key system warning light.....	2-14
Interior lights.....	2-46, 8-31

## J

Jump starting.....	6-9
--------------------	-----

## K

Key.....	3-2
Ignition switch (model without intelligent	
Key system).....	5-5
Ignition switch positions.....	5-8
Intelligent Key battery.....	8-26
Intelligent Key battery discharge.....	5-8
Intelligent Key system.....	3-9, 5-6
Keys.....	3-2
Locking with key.....	3-5
Mechanical key.....	3-4
NISSAN Anti-Theft System (NATS*) key.....	3-3
Push-button ignition switch (model with	
Intelligent Key system).....	5-6
Remote keyless entry system.....	3-7
Using intelligent Key system.....	3-8, 3-11
Using remote keyless entry function.....	3-16
Key positions.....	5-6

## L

Labels	
Air conditioner specification label.....	9-11
Engine serial number.....	9-10
Vehicle identification number (VIN).....	9-9
Legal requirement to adjust headlight beam.....	8-39
Light	
Bulb replacement.....	8-3, 8-29
Exterior lights.....	8-30
Fog light switch.....	2-36
Front fog lights.....	2-36
Front map lights.....	2-46
Headlight aiming control.....	2-34
Headlight and turn signal switch.....	2-33
Headlight switch.....	2-33
Headlights.....	8-29
Indicator lights.....	2-16
Interior lights.....	2-46, 8-31
Light locations.....	8-32
Replacement.....	8-3, 8-29
Room light.....	2-46
Warning lights.....	2-13
Lock	
Anti-lock Braking System (ABS).....	5-39
Child safety rear door lock.....	3-7
Door locks.....	3-5
Locking with inside lock knob.....	3-6
Locking with key.....	3-5
Locking with power door lock switch.....	3-6
Steering lock.....	5-6, 5-7
Vehicle speed sensing door	
lock mechanism.....	3-6
Lock, Back door lock.....	3-20
LW-MW-FM radio operation.....	4-54, 4-60
LW-MW-FM radio with compact disc	
(CD) changer.....	4-57
LW-MW-FM radio with compact disc	
(CD) player.....	4-52

## M

Maintenance	
Battery.....	8-4, 8-24
Explanation of general maintenance items.....	8-3
General maintenance.....	8-3
Indicators for maintenance (dot matrix).....	2-25
Maintenance precautions.....	8-5
Maintenance requirements.....	8-3
Scheduled maintenance.....	8-3
Seat belt maintenance.....	1-13
Malfunction indicator light (MIL).....	2-17
Manual air conditioner.....	4-7
Manual transmission.....	5-5
Mechanical key.....	3-4
Mechanical Key LOCK warning.....	2-21
Meter display model.....	2-42
Meters and gauges.....	2-6
Mirror	
Inside rearview mirror.....	3-21
Mirrors.....	3-21
Outside rearview mirrors.....	3-22
Vanity mirrors.....	3-24
Mirror display operation.....	4-4
Monitor	
Rearview monitor.....	4-2

## N

New vehicle break-in.....	5-3
NISSAN Anti-Theft System (NATS).....	3-18
NISSAN Anti-Theft System (NATS*) key.....	3-3
No key warning.....	2-21

## O

Odometer.....	2-8
Oil	
Changing engine oil and oil filter.....	8-11
Checking engine oil level.....	8-11
Engine oil.....	8-11

Engine oil replacement indicator.....	2-25
Oil filter replacement indicator.....	2-25
Opening fuel filler lid.....	3-20
Opening hood.....	3-19
Operation	
Indicators for operation (dot matrix).....	2-20
Outside rearview mirrors.....	3-22
Overdrive switch.....	5-13
Overheat, If your vehicle overheats.....	6-11

## P

Parking	
Parking brake.....	3-24
Parking Sensor Indicator.....	5-34
Parking space measurement operation.....	5-35
Parking, Parking brake operation.....	5-41
Passenger compartment.....	8-28
Phone	
Bluetooth® Hands-Free Phone System.....	4-64
Car phone or CB radio.....	4-64
Power	
Electric power steering system.....	5-37
Locking with power door lock switch.....	3-6
Power outlet.....	2-43
Power windows.....	2-40
Precautions	
Audio operation.....	4-11
Brake precautions.....	5-38
Maintenance.....	8-5
Precautions on child restraint usage.....	1-13
Precautions on push-button ignition switch operation.....	5-6
Precautions on Supplemental Restraint System (SRS).....	1-25
Precautions when starting and driving.....	5-3
Safety precautions.....	4-2
Seat belt usage.....	1-7
Towing precautions.....	6-11
Precautions on cruise control.....	5-30
Precautions on push-button ignition switch operation.....	5-6

Pregnant women.....	1-9
Preparing tools.....	6-2
Pre-tensioner seat belt system.....	1-31
Push starting.....	6-10
Push warning.....	2-21
Push-button ignition switch (model with Intelligent Key system).....	5-6

## R

Radio.....	4-11
Car phone or CB radio.....	4-64
FM-AM radio with Compact Disc (CD) player.....	4-20, 4-24, 4-29, 4-33, 4-38, 4-44
LW-MW-FM radio with Compact Disc (CD) player.....	4-52, 4-57
Steering wheel audio controls.....	4-63
Radio data system (RDS).....	4-55, 4-61
Rain-sensing auto wiper system.....	2-38
Rear center seat belt.....	1-11
Rear seats.....	1-4
Rear window wiper and washer switch.....	2-38
Rear window wiper blade.....	8-22
Rearview monitor.....	4-2
Recommended fuel/lubricants and capacities.....	9-2
Recommended SAE viscosity number.....	9-4
Remote controller battery.....	8-25
Remote keyless entry system.....	3-7
Removing spots.....	7-2
Repair and replacement procedure.....	1-32
Room light.....	2-46

## S

Safety	
Child safety.....	1-8
Child safety rear door lock.....	3-7
Safety precautions.....	4-2
Scheduled maintenance.....	8-3
Seat	
Center mark on seat belts.....	1-9

Front seats.....	1-2
Precautions on seat belt usage.....	1-7
Rear seats.....	1-4
Seat belt.....	7-4
Seat belts.....	1-7
Seats.....	1-2
Three-point type seat belts.....	1-9
Seat belt.....	1-9
Center mark on seat belts.....	1-9
Precautions on seat belt usage.....	1-7
Seat belt warning light.....	2-15
Seat belt(s)	
Child safety.....	1-8
Injured persons.....	1-9
Pregnant women.....	1-9
Pre-tensioner seat belt system.....	1-31
Rear center seat belt.....	1-11
Seat belt maintenance.....	1-13
Shoulder belt height adjustment.....	1-10
Seat belts	
Seat belts.....	7-4
Seats, seat belts and supplemental restraint system (SRS).....	0-2
Security system.....	3-17
Servicing air conditioner.....	4-10
Setting cruising speed.....	5-31
Setting speed limit.....	5-29
Shift lever	
Shift lock release.....	5-16
Shift lock release.....	5-13
Transmission.....	5-16
Shift "P" warning.....	2-21
Shifting	
CVT (Continuously Variable Transmission).....	5-5
Shoulder belt height adjustment.....	1-10
Side ventilators.....	4-5
Side-impact air bag system.....	1-31
Slip indicator light.....	2-17
Sonar (parking sensor) system.....	5-34
Spare tire.....	8-43
Spark plugs.....	8-17
Speed limiter.....	5-28

Speed limiter display and indicators.....	5-28
Speed limiter indicator (for Europe).....	2-21
Speed limiter malfunction.....	5-30
Speed limiter operations.....	5-28
Speedometer.....	2-8
Starting	
Before starting engine.....	5-3
Jump starting.....	6-9
Precautions when starting and driving.....	5-3
Push starting.....	6-10
Starting engine (model with Intelligent Key system).....	5-10
Starting engine (model without Intelligent Key system).....	5-9
Starting vehicle.....	5-12
Steering	
Electric power steering system.....	5-37
Steering lock.....	5-6, 5-7
Steering lock release malfunction indicator....	2-20
Steering wheel.....	3-21
Steering wheel switch for audio controls....	4-63
Stop/Start System.....	5-21
Stopping vehicle.....	6-2
Storages.....	2-44
Stowing damaged tire and tools.....	6-6
Sun visors.....	2-45
Sunshade.....	2-42
Super lock system.....	3-5
Supplemental air bag systems.....	1-29
Supplemental curtain side-impact air bag system.....	1-31
Supplemental front-impact air bag system.....	1-30
Supplemental Restraint System (SRS).....	1-25
Supplemental side-impact air bag system.....	1-31
Switch	
Audio control steering wheel switch.....	4-63
Defogger switch.....	2-39
Fog light switch.....	2-36
Front fog lights.....	2-36
Hazard indicator flasher switch.....	6-2
Headlight aiming control.....	2-34
Headlight and turn signal switch.....	2-33

Headlight switch.....	2-33
Ignition switch.....	5-5
Power door lock switch.....	3-6
Turn signal switch.....	2-35
Wiper and washer switch.....	2-37

## T

Tachometer.....	2-10
Theft warning system.....	3-17
Three-point type seat belts.....	1-9
Three-way catalyst.....	5-4
Tire	
Changing tires and wheels.....	8-43
Installing spare tire.....	6-5
Preparing tools.....	6-2
Spare tire.....	8-43
Stowing damaged tire and tools.....	6-6
Tire age.....	8-43
Tire equipment.....	5-41
Tire inflation pressure.....	8-42
Tire placard.....	9-10
Tire replacement indicator.....	2-25
Tire wear and damage.....	8-43
Tires and wheels.....	8-42, 9-8
Tire angle indicator.....	2-31
Tires	
Flat tire.....	6-2
Tire chains.....	8-42
Tire rotation.....	8-4, 8-42
Types of tires.....	8-42
Uniform tire quality grading.....	9-11
Tonneau board.....	2-45
Towing	
Towing precautions.....	6-11
Towing recommended by NISSAN.....	6-12
Towing your vehicle.....	6-11
Trailer towing.....	5-37
Trailer towing.....	5-37
Transmission	
Automatic transmission fluid (ATF).....	8-20

Continuously Variable Transmission (CVT) fluid.....	8-21
Driving with Continuously Variable Transmission (CVT).....	5-14
Driving with CVT (Continuously Variable Transmission).....	5-5
Driving with Manual Transmission (MT).....	5-17
Manual transmission (MT).....	5-5
Transmission shift lever lock release.....	5-16
Trip odometer.....	2-28
Trouble shooting guide.....	3-14
Turn signal switch.....	2-35
Turning on cruise control.....	5-31
Turning on speed limiter.....	5-29
Types of tires.....	8-42

## U

Underbody cleaning.....	7-3
Uniform tire quality grading.....	9-11
Upper instrument box.....	2-44
Using intelligent Key system.....	3-11
Using remote keyless entry function.....	3-16
Using remote keyless entry system.....	3-8

## V

Vanity mirrors.....	3-24
Vehicle	
Dimensions.....	9-8
Identification number (VIN).....	9-9
Information display.....	2-20
Speed sensing door lock mechanism.....	3-6
Vehicle battery.....	8-24
Vehicle Dynamic Control (VDC) OFF switch.....	5-25
Vehicle Dynamic Control (VDC) system....	5-24, 5-25
Vehicle security.....	5-40
Ventilators.....	4-5

## W

Warning	
Lights.....	2-13
Warning and audible reminders.....	3-13
Warning lights.....	2-13
Warning/indicator lights and audible reminders.....	2-12
Warnings and alerts (vehicle information display).....	2-22
Washer switch	
Rear window wiper and washer switch.....	2-38
Windshield wiper and washer switch.....	2-37
Washing.....	7-2
Waxing.....	7-2
Wheels and tires, Care of wheels.....	7-3
When travelling or registering in another country.....	9-9
Where to go for service.....	8-3
Window washer fluid.....	8-5, 8-23
Window(s)	
Cleaning.....	7-2, 7-4
Manual windows.....	2-40
Power windows.....	2-40
Windows.....	2-40
Windshield wiper and washer switch.....	2-37
Wiper	
Rain-sensing auto wiper system.....	2-38
Rear window wiper and washer switch.....	2-38
Rear window wiper blade.....	8-22
Windshield wiper and washer switch.....	2-37
Wiper and washer switch.....	2-37
Wiper blades.....	8-21

## GAS STATION INFORMATION

### RECOMMENDED FUEL

Gasoline engine (model with three-way catalyst)



#### CAUTION:

**Do not use leaded gasoline. Using leaded gasoline will damage the three-way catalyst.**

Except for Europe, Ukraine, Sri Lanka and Thailand: Use UNLEADED REGULAR gasoline with an octane rating of at least 91 (RON).

For Europe, Ukraine and Sri Lanka: Use UNLEADED PREMIUM gasoline with an octane rating of at least 95 (RON).

If unleaded premium gasoline is not used, UNLEADED REGULAR gasoline with an octane rating of at least 91 (RON) may be used at slightly reduced performance. However, for maximum vehicle performance and the best driveability, the use of unleaded premium gasoline is recommended.

For Thailand: Use UNLEADED REGULAR gasoline or gasohol (up to E20\*) of at least 91 octane (RON).

\*: Gasohol is alcohol blended gasoline. For example, "E20" is a mixture of approximately 20% fuel ethanol and 80% unleaded gasoline.

### Diesel engine\*

Use diesel fuel of at least 50 cetane.

\* If two types of diesel fuel are available, use summer or winter fuel properly according to the following temperature conditions.

- Above  $-7^{\circ}\text{C}$  ( $20^{\circ}\text{F}$ ) ... Summer type diesel fuel.
- Below  $-7^{\circ}\text{C}$  ( $20^{\circ}\text{F}$ ) ... Winter type diesel fuel.



#### CAUTION:

- **Do not use home heating oil, gasoline or other alternate fuels in your diesel engine. The use of those or adding those to diesel fuel can cause engine damage.**
- **Do not use summer fuel at temperatures below  $-7^{\circ}\text{C}$  ( $20^{\circ}\text{F}$ ). The cold temperatures will cause wax to form in the fuel. As a result, it may prevent the engine from running smoothly.**

### RECOMMENDED ENGINE OIL

See "Recommended fuel/lubricants and capacities" (P.9-2).

#### Gasoline engine

For Europe, Ukraine and South Africa:

- Genuine NISSAN engine oil
- API grade SL, SM or SN
- ILSAC grade GF-3, GF-4 or GF-5
- ACEA A1/B1, A3/B3, A3/B4, A5/B5, C2 or C3

Except for Europe, Ukraine and South Africa:

- Genuine NISSAN engine oil
- API grade SL, SM or SN

- ILSAC grade GF-3, GF-4 or GF-5

#### Diesel engine

- Genuine NISSAN engine oil
- ACEA B1/B5

### TIRE COLD PRESSURE

See the tire placard affixed to the driver's side center pillar.



## **QUICK REFERENCE**

- In case of emergency ... (P.6-1)  
(Flat tire, engine will not start, overheating, towing)
- How to start the engine ... (P.5-1)
- How to read the meters and gauges ... (P.2-1)
- Maintenance and do-it-yourself ... (P.8-1)
- Technical information ... (P.9-1)