

Foreword

Welcome to the growing family of new NISSAN owners. This vehicle has been delivered to you with confidence. It has been produced using the latest techniques and strict quality control.

This manual was prepared to help you understand the operation and maintenance of your vehicle so that you may enjoy many kilometers (miles) of driving pleasure. Please read through this manual before operating your vehicle.

A separate Warranty Information & Maintenance Booklet explains details about the warranties covering your vehicle.

Your NISSAN dealer knows your vehicle best. When you require any service or have any questions, we will be glad to assist you with the extensive resources available for you.

IMPORTANT SAFETY INFORMATION

Reminders for safety!

Follow these important driving rules to help ensure a safe and complete trip for you and your passengers!

- **NEVER drive under the influence of alcohol or drugs.**
- **ALWAYS observe posted speed limits and never drive too fast for conditions.**
- **ALWAYS use your seat belts and appropriate child restraint systems. Preteen children should be seated in the rear seat.**
- **ALWAYS provide information about the proper use of vehicle safety features to all occupants of the vehicle.**
- **ALWAYS review this Owner's Manual for important safety information.**

When reading the manual

This manual includes information for all options available on this model. Therefore, you may find some information that does not apply to your vehicle.

All information, specifications and illustrations in this manual are those in effect at the time of printing. NISSAN reserves the right to change specifications or designs without notice and without obligation.

MODIFICATION OF YOUR VEHICLE

This vehicle should not be modified. Modification could affect its performance, safety or durability, and may even violate governmental regulations. In addition, damage or performance problems resulting from modifications may not be covered under NISSAN warranties.

Read first — then drive safely

Before driving your vehicle, read this Owner's Manual carefully. This will ensure familiarity with controls and maintenance requirements, assisting you in the safe operation of your vehicle.

Throughout this manual we have used the symbol  followed by the word **WARNING**. This is used to indicate the presence of a hazard that could cause death or serious personal injury. To avoid or reduce the risk, the procedures must be followed precisely.

The symbol  followed by the word **CAUTION** is also used throughout this manual to indicate the presence of a hazard that could cause minor or moderate personal injury or damages to your vehicle. To avoid or reduce the risk, the procedures must be followed carefully.

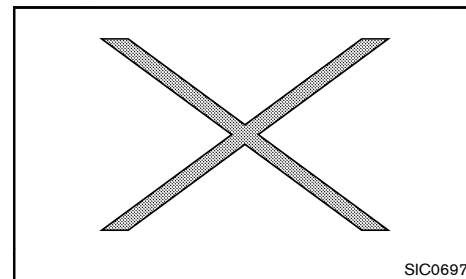

If you see this symbol, it means **“Do not do this”** or **“Do not let this happen”**.



If you see a symbol similar to these in an illustration, it means the arrow points to the front of the vehicle.



Arrows in an illustration that are similar to these indicate movement or action.



Arrows in an illustration that are similar to these call attention to an item in the illustration.

Table of Contents

Illustrated table of contents	0
Safety — seats, seat belts and supplemental restraint system	1
Instruments and controls	2
Pre-driving checks and adjustments	3
Heater and air conditioner, and audio system	4
Starting and driving	5
In case of emergency	6
Appearance and care	7
Maintenance and do-it-yourself	8
Technical information	9
Index	10

0 Illustrated table of contents

Seats, seat belts and supplemental restraint system	0-2	Cockpit	0-8
Two-row model	0-2	Instrument panel	0-9
Three-row model	0-3	Meters and gauges	0-10
Exterior front	0-4	Engine compartment	0-11
Exterior rear	0-5	HR15DE engine model	0-11
Passenger compartment	0-6	HR16DE engine model	0-12
Two-row model	0-6	MR18DE engine model	0-13
Three-row model	0-7		

SEATS, SEAT BELTS AND SUPPLEMENTAL RESTRAINT SYSTEM

TWO-ROW MODEL

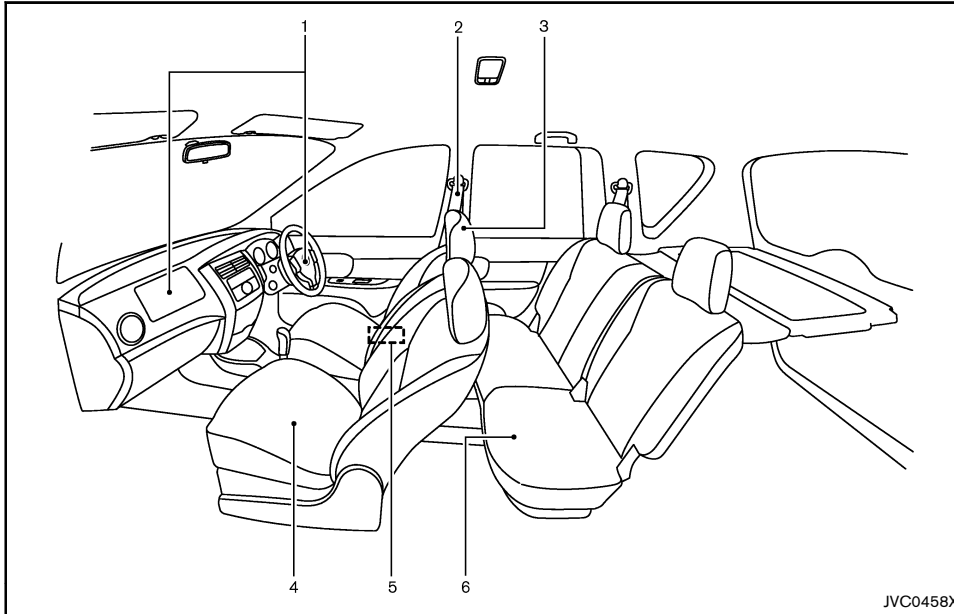

JVC0458X

1. Supplemental front-impact air bags* (Page 1-22)
 2. Seat belts (P.1-11)
 3. Head restraints* (P.1-9)
 4. Front seats (P.1-2)
 5. Pre-tensioner seat belt system* (P.1-27)
 6. Rear seats (P.1-4)
- *: if equipped

THREE-ROW MODEL

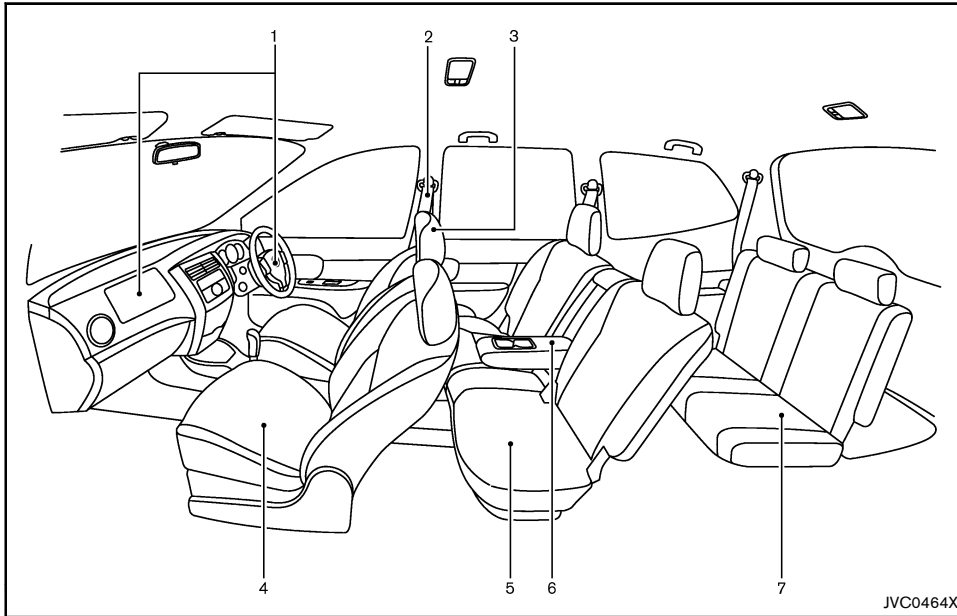

- | | |
|---|-----------------------------|
| 1. Supplemental front-impact air bags* (P.1-22) | 7. Third row seats |
| 2. Seat belts (P.1-11) | — Adjustment (P.1-4) |
| 3. Head restraints (P.1-9) | — Seat arrangements (P.1-4) |
| 4. Front seats (P.1-2) | *: if equipped |
| 5. Second row seats | |
| — Adjustment (P.1-3) | |
| — Seat arrangements (P.1-4) | |
| 6. Second row seat armrest (P.1-4) | |

EXTERIOR FRONT

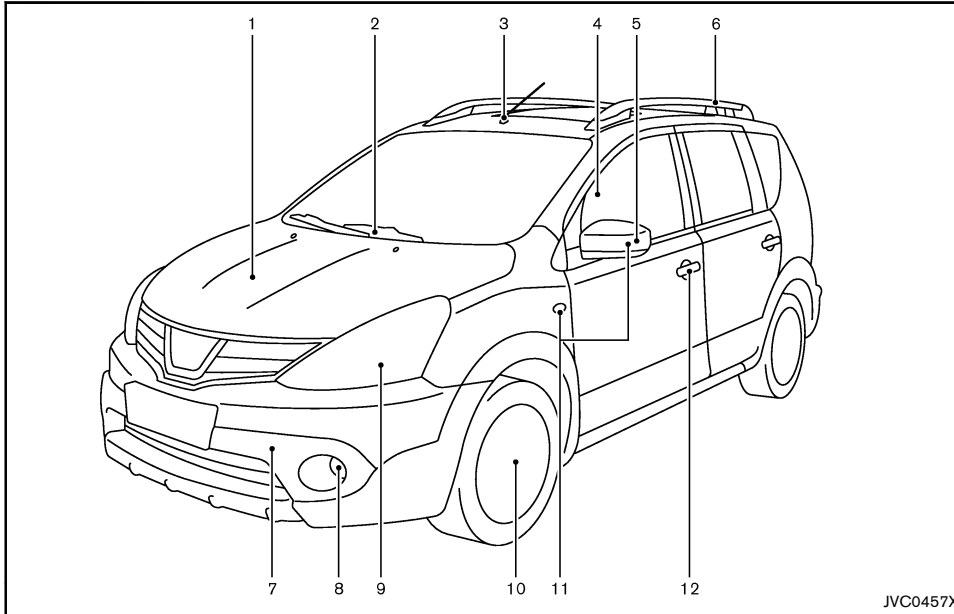

- | | |
|--|--|
| 1. Engine hood (P.3-14) | 7. Recovery hook cover (P.6-10) |
| 2. Windshield wiper and washer <ul style="list-style-type: none">— Wiper and washer switch (P.2-14)— Wiper maintenance (P.8-15)— Washer fluid (P.8-16) | 8. Fog lights* <ul style="list-style-type: none">— Fog light switch (P.2-14)— Bulb replacement (P.8-21) |
| 3. Antenna (P.4-5) | 9. Headlights and turn signals <ul style="list-style-type: none">— Headlight and turn signal switch (P.2-13)— Bulb replacement (P.8-21) |
| 4. Power windows (P.2-16) | 10. Tires <ul style="list-style-type: none">— Tires and wheels (P.8-24, P.9-5)— Flat tire (P.6-2) |
| 5. Outside rearview mirrors (P.3-18) | |
| 6. Roof rail* (P.2-20) | |

- Tire placard (P.9-7)
11. Side turn signal light (on the front fender or the outside rearview mirror)*
 - Switch operation (P.2-13)
 - Bulb replacement (P.8-21)
12. Doors
 - Keys (P.3-2)
 - Door locks (P.3-4)
 - Intelligent Key system* (P.3-6)
 - Remote keyless entry system* (P.3-5)
 - Security system* (P.3-13)
- *: if equipped

EXTERIOR REAR

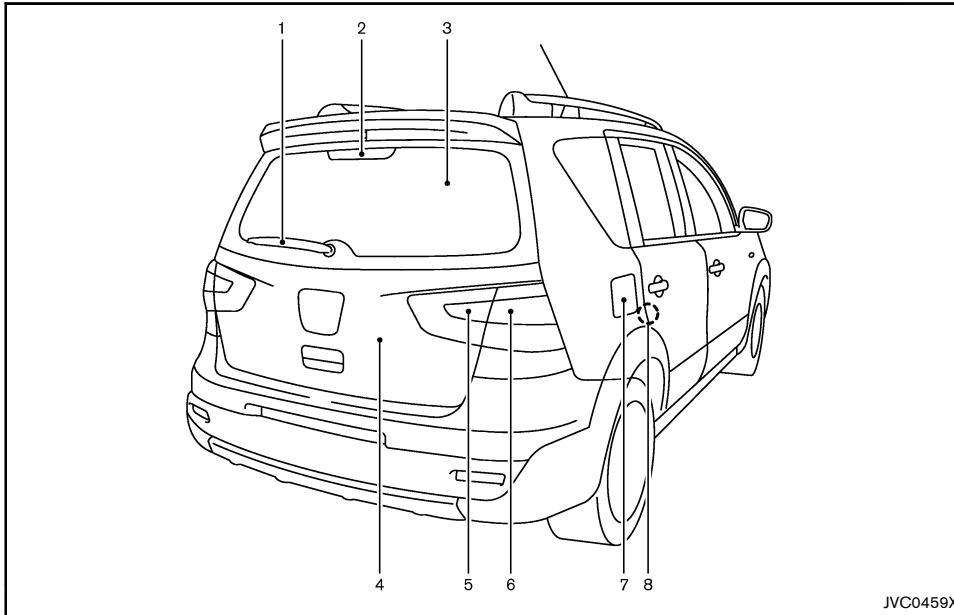

JVC0459X

- | | |
|--|---|
| 1. Rear window wiper and washer | |
| — Wiper and washer switch (P.2-14) | |
| — Wiper maintenance (P.8-15) | |
| — Washer fluid (P.8-16) | |
| 2. High-mounted stop light (Bulb replacement) (P.8-21) | |
| 3. Rear window defogger* (P.2-15) | |
| 4. Back door | |
| — Back door operation (P.3-15) | |
| — Back door request switch* (Intelligent Key | system) (P.3-8) |
| | 5. Reverse light (Bulb replacement) (P.8-21) |
| | 6. Rear combination light (Bulb replacement) (P.8-21) |
| | 7. Fuel filler lid |
| | — Operation (P.3-16) |
| | — Fuel information (P.9-3) |
| | 8. Child safety rear door locks (P.3-5) |
| | *: if equipped |

PASSENGER COMPARTMENT

TWO-ROW MODEL

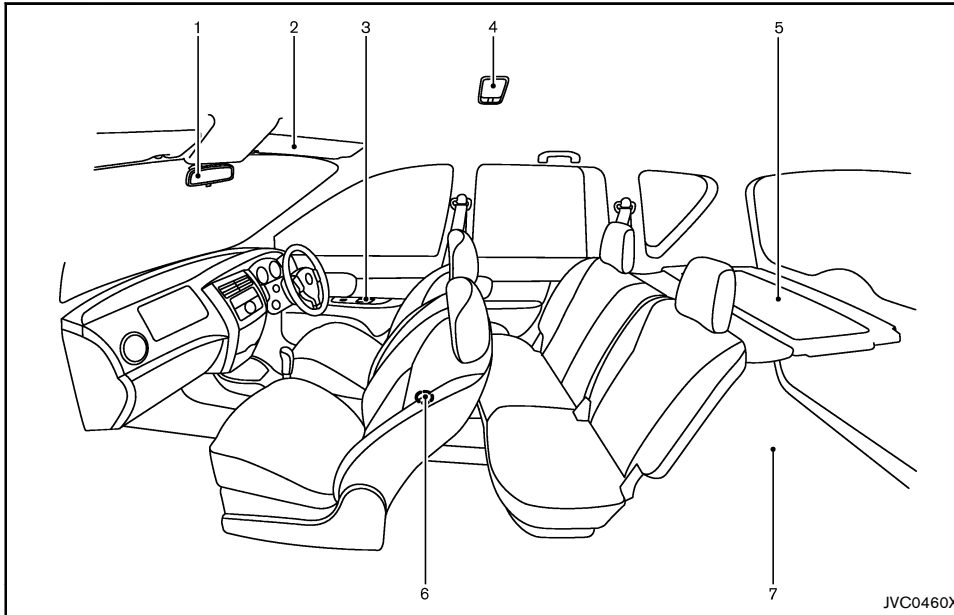

- | | |
|------------------------------------|--------------------------------|
| 1. Inside rearview mirror (P.3-17) | 6. Cup holders (P.2-18) |
| 2. Sun visor (P.2-21) | 7. Luggage room |
| 3. Doors | — Luggage room light* (P.8-21) |
| — Power window switch (P.2-16) | — Tools and spare tire (P.6-3) |
| — Power door lock switch (P.3-4) | |
| 4. Room light (P.2-21, P.8-21) | *: if equipped |
| 5. Cargo cover* (P.2-19) | |

THREE-ROW MODEL

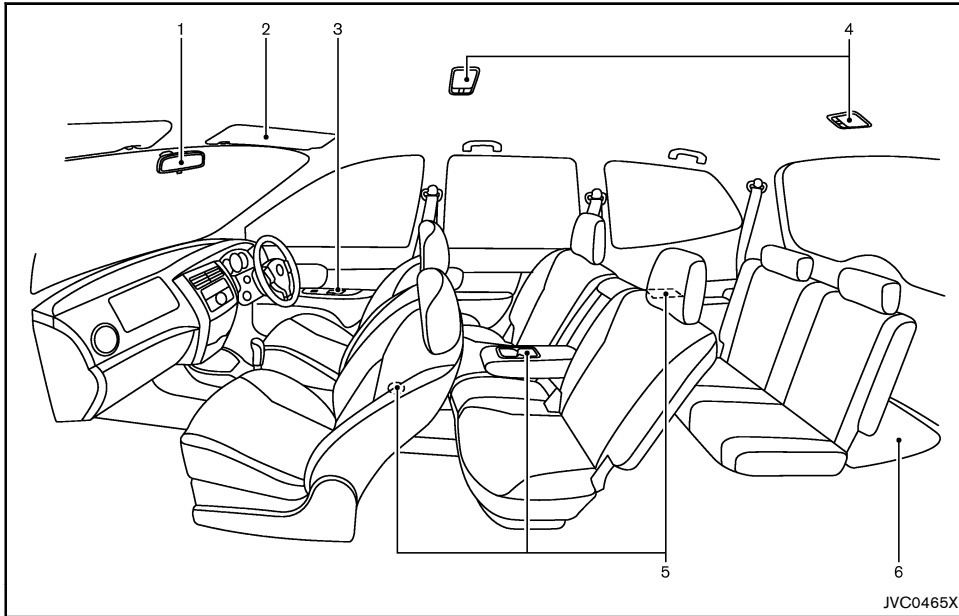

JVC0465X

1. Inside rearview mirror (P.3-17)
2. Sun visor (P.2-21)
3. Doors
 - Power window switch (P.2-16)
 - Power door lock switch (P.3-4)
4. Room light (P.2-21, P.8-21)
5. Cup holders (P.2-18)
6. Luggage area floor box (P.2-20)/Tools and spare tire (P.6-3)

COCKPIT

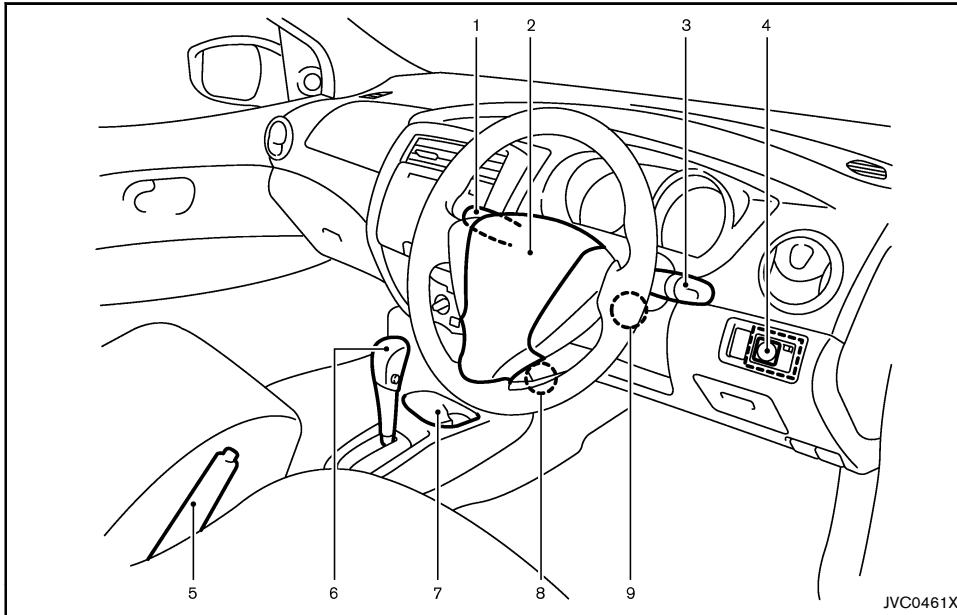

9. Ignition switch (P.5-4)
- Steering lock (P.5-6)
*: if equipped

- | | |
|--|---|
| 1. Wiper and washer switch (P.2-14) | 4. Outside rearview mirror control switch (P.3-18) |
| 2. Steering wheel | 5. Parking brake (P.3-19) |
| - Electric power steering system (P.5-16) | 6. Shift lever |
| - Horn (P.2-15) | - Automatic Transmission (AT) (P.5-7) |
| - Driver's supplemental front-impact air bag* (P.1-22) | - Continuously Variable Transmission (CVT) (P.5-10) |
| 3. Headlight, fog light and turn signal switch | - Manual Transmission (MT) (P.5-13) |
| - Headlight (P.2-13) | 7. Front cup holders (P.2-18) |
| - Turn signal (P.2-13) | 8. Tilting steering wheel lock lever (P.3-17) |
| - Fog light* (P.2-14) | |

INSTRUMENT PANEL

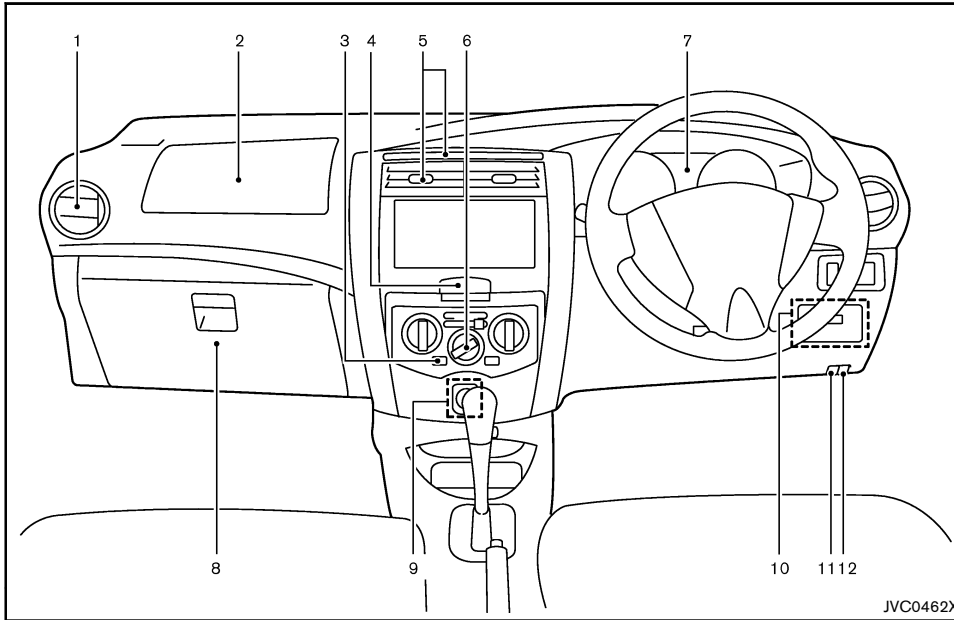

- | | |
|---|---|
| 1. Side ventilator (P.4-2) | 10. Fuse box cover (P.8-20) |
| 2. Passenger's front-impact air bag* (P.1-22) | 11. Hood release handle (P.3-14) |
| 3. Defogger switch* (P.2-15) | 12. Fuel filler lid release handle (P.3-16) |
| 4. Hazard indicator flasher switch (P.6-2) | *: if equipped |
| 5. Center ventilator (P.4-2) | |
| 6. Manual cooler (P.4-3) | |
| 7. Meters and gauges (P.2-4) | |
| 8. Glove box (P.2-18) | |
| 9. Cigarette lighter (P.2-17) | |

METERS AND GAUGES

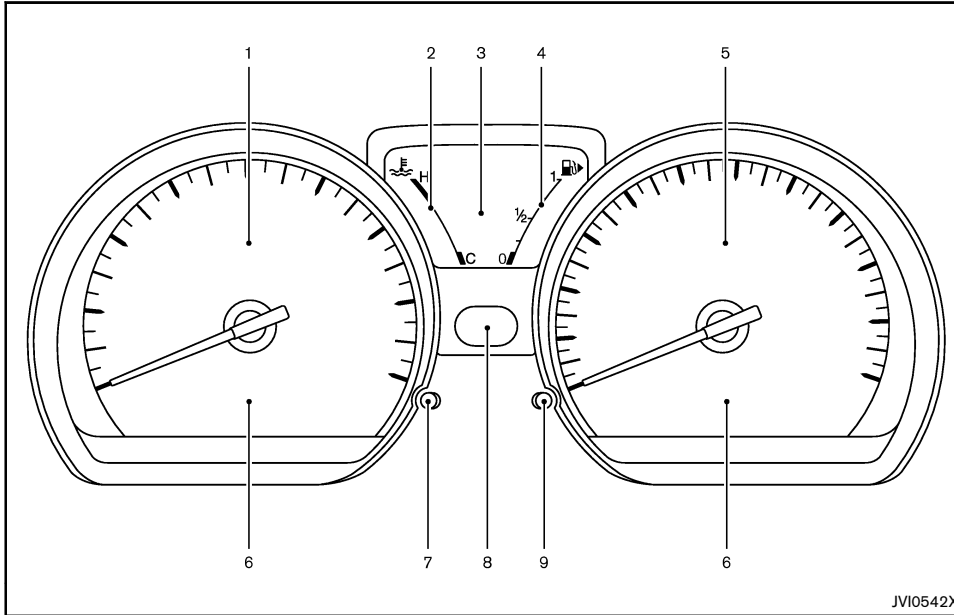

The needle indicators may move slightly after the ignition switch is turned the "OFF" or "LOCK" position. This is not a malfunction.

- | | |
|---|---|
| 1. Tachometer (P.2-6) | 6. Warning/indicator lights (P.2-8) |
| 2. Engine coolant temperature gauge (P.2-6) | 7. Instrument brightness control knob (P.2-7) |
| 3. Vehicle information display (P.2-4) | 8. Automatic Transmission (AT)/Continuously Variable Transmission (CVT) position indicator* (P.2-7) |
| — Odometer/twin trip odometer (P.2-5) | |
| — Trip computer (P.2-5) | |
| — Clock (P.2-17) | |
| — Instrument brightness control display (P.2-7) | 9. RESET switch for trip odometer (P.2-5)/Trip computer mode switch (P.2-5) |
| 4. Fuel gauge (P.2-6) | *: if equipped |
| 5. Speedometer (P.2-5) | |

ENGINE COMPARTMENT

HR15DE ENGINE MODEL

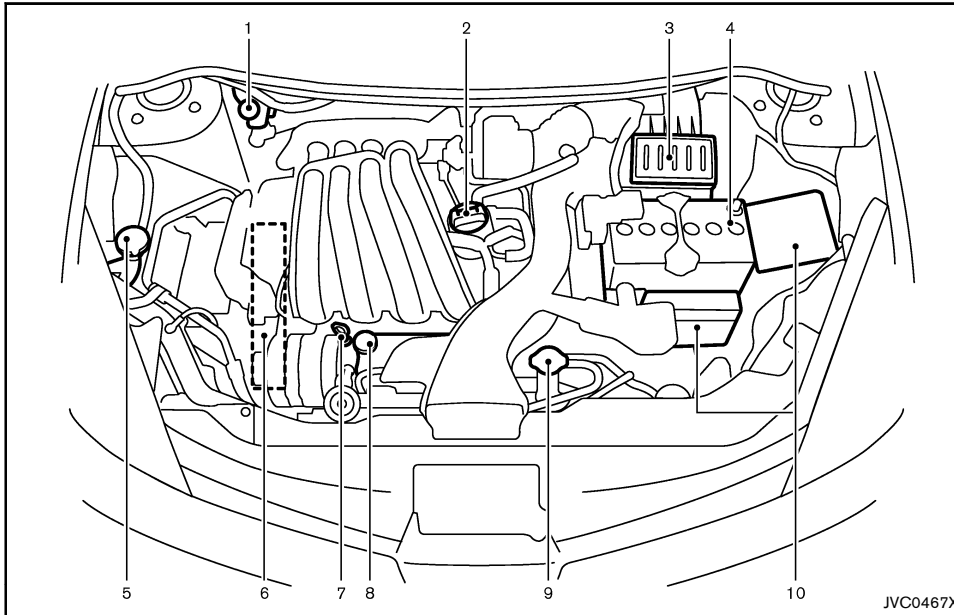

- | | |
|---|---------------------------------------|
| 1. Brake and clutch* fluid reservoir (P.8-12) | 8. Engine coolant reservoir (P.8-8) |
| 2. Engine oil filler cap (P.8-8) | 9. Radiator cap (P.8-7) |
| 3. Air cleaner (P.8-14) | 10. Fuse/fusible link box (P.8-20) |
| 4. Battery (P.8-17) | *: For Manual Transmission (MT) model |
| 5. Window washer fluid reservoir (P.8-16) | |
| 6. Engine drive belts (P.8-10) | |
| 7. Engine oil dipstick (P.8-8) | |

HR16DE ENGINE MODEL

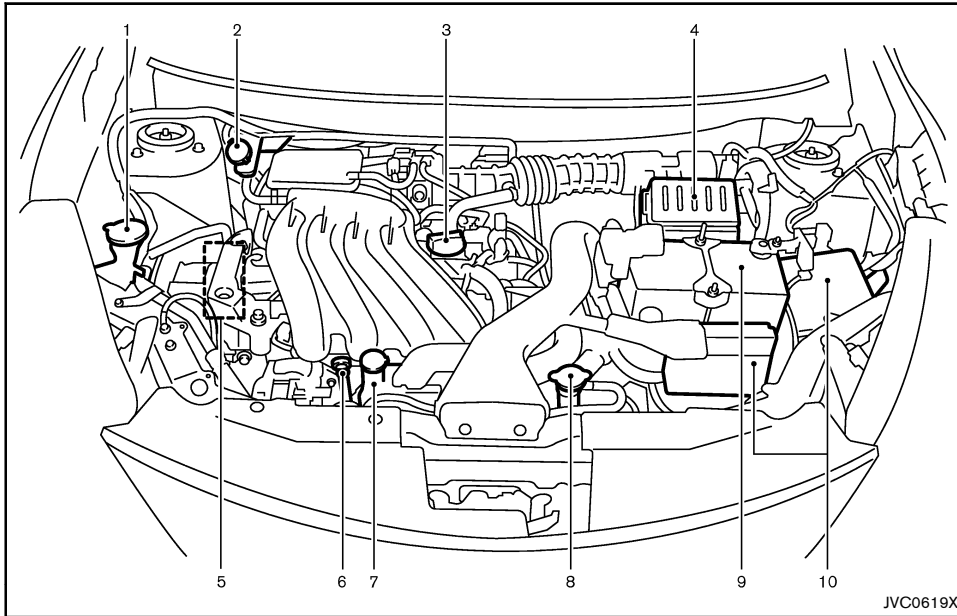

- | | |
|---|--|
| 1. Window washer fluid reservoir (P.8-16) | 9. Battery (P.8-17) |
| 2. Brake and clutch* fluid reservoir (P.8-12) | - Jump starting (P.6-6) |
| 3. Engine oil filler cap (P.8-8) | 10. Fuse/fusible link holders (P.8-20) |
| 4. Air cleaner (P.8-14) | *: For Manual Transmission (MT) model |
| 5. Engine drive belt location (P.8-10) | |
| 6. Engine oil dipstick (P.8-8) | |
| 7. Engine coolant reservoir (P.8-7) | |
| 8. Radiator cap (P.8-7) | |
| - Vehicle overheat (P.6-8) | |

MR18DE ENGINE MODEL

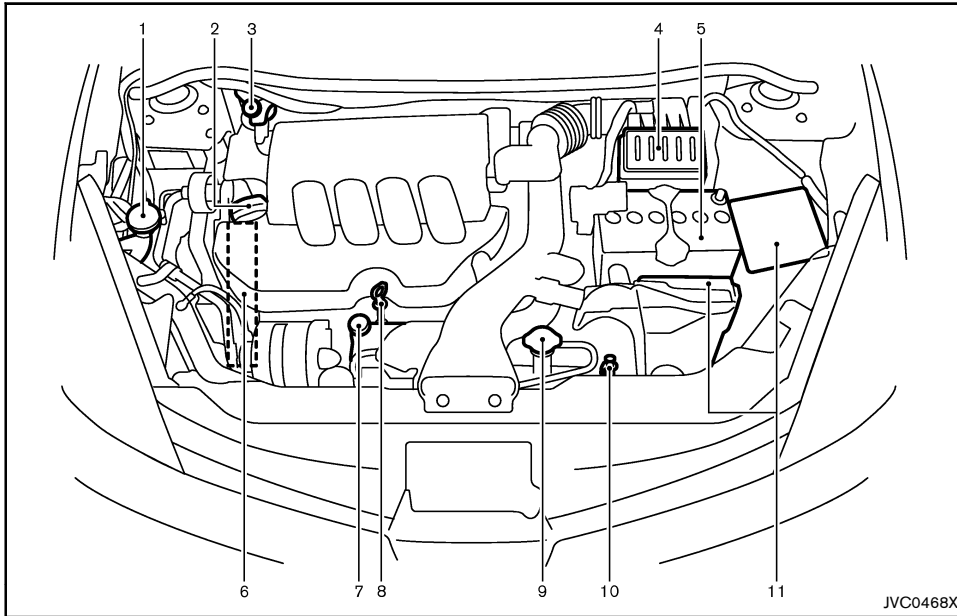

- | | |
|---|--|
| 1. Window washer fluid reservoir (P.8-16) | 9. Radiator cap (P.8-7) |
| 2. Engine oil filler cap (P.8-8) | 10. Automatic Transmission Fluid (ATF) dipstick (*2)
(P.8-13) |
| 3. Brake and clutch (*1) fluid reservoir (P.8-12) | 11. Fuse/fusible link box (P.8-20) |
| 4. Air cleaner (P.8-14) | (*1): For Manual Transmission (MT) model |
| 5. Battery (P.8-17) | (*2): For Automatic Transmission (AT) model |
| 6. Engine drive belts (P.8-10) | |
| 7. Engine coolant reservoir (P.8-8) | |
| 8. Engine oil dipstick (P.8-8) | |

MEMO

1 Safety — seats, seat belts and supplemental restraint system

Seats	1-2	Pregnant women	1-14
Front seats	1-2	Injured persons	1-14
Second row seats (Three-row model)	1-3	Three-point type seat belts	1-14
Third row seat (Three-row model)	1-4	Two-point type seat belts	1-15
Armrest (if equipped)	1-4	Center mark on seat belts	1-15
Seat arrangements	1-4	Seat belt maintenance	1-15
Head restraints (if equipped)	1-9	Child restraints	1-16
Adjustable head restraint components	1-9	Precautions on child restraints usage	1-16
Non-adjustable head restraint components	1-9	Installation of child restraint system	1-17
Remove	1-10	Supplemental Restraint System (SRS) (if equipped)	1-22
Install	1-10	Precautions on Supplemental Restraint System (SRS)	1-22
Adjust	1-10	Supplemental air bag systems	1-25
Seat belts	1-11	SRS air bag deployment conditions	1-26
Precautions on seat belt usage	1-11	Pre-tensioner seat belt system (if equipped)	1-27
Child safety	1-13	Repair and replacement procedure	1-28

SEATS

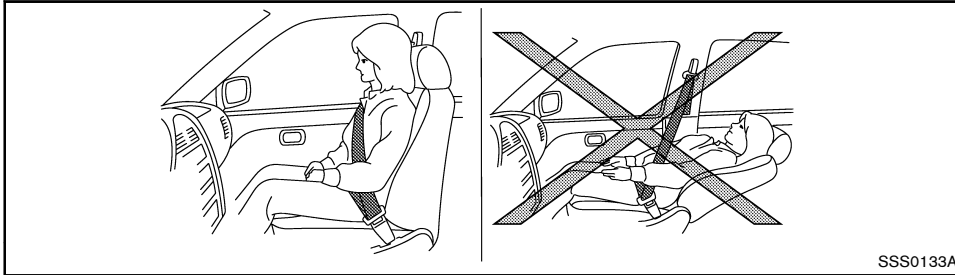

WARNING:

- Do not drive and/or ride in the vehicle with the seatback reclined. This can be dangerous. The shoulder belt will not be properly against the body. In an accident, you and your passengers could be thrown into the shoulder belt and receive neck or other serious injuries. You and your passengers could also slide under the lap belt and receive serious injuries.
- For the most effective protection while the vehicle is in motion, the seatback should be upright. Always sit well back in the seat and adjust the seat belt properly. (See "Seat belts" (P.1-11).)

CAUTION:

When adjusting the seat positions, be sure not to contact any moving parts to avoid possible injuries and/or damages.

FRONT SEATS

WARNING:

Do not adjust the driver's seat while driving so that full attention may be given to vehicle operation.

Manual seat adjustment

WARNING:

After adjusting a seat, gently shake the seat to confirm that the seat is locked securely. If the seat is not locked securely, it may move suddenly and could cause the loss of control of the vehicle.

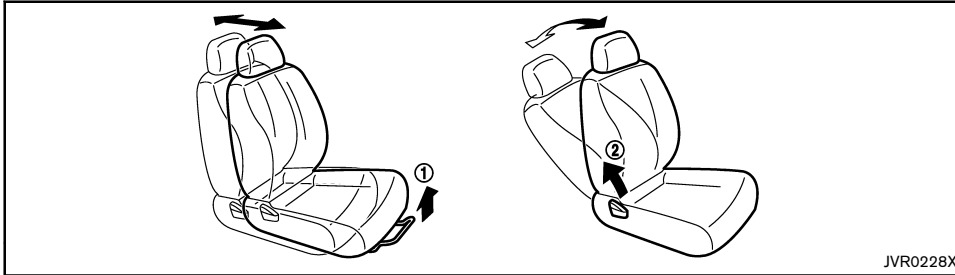

Forward and backward:

1. Pull up the adjusting lever ①.
2. Slide the seat to the desired position.
3. Release the adjusting lever to lock the seat in position.

Reclining:

1. Pull up the adjusting lever ②.
2. Tilt the seatback to the desired position.
3. Release the adjusting lever to lock the seatback in position.

The reclining feature allows the adjustment of the seatback for occupants of different sizes to help obtain the proper seat belt fit. (See "Seat belts" (P.1-11).)

The seatback may be reclined to allow occupants to rest when the vehicle is parked.

SECOND ROW SEATS (Three-row model)

Manual seat adjustment



WARNING:

- **After adjusting a seat, gently shake the seat to confirm that the seat is locked securely. If the seat is not locked securely, it may move suddenly and could cause the loss of control of the vehicle.**
- **Align the right and left second row seats straight with each other before the second row center seat is occupied. Otherwise, instability may cause injury to the second row center seat passenger.**

Forward and backward:

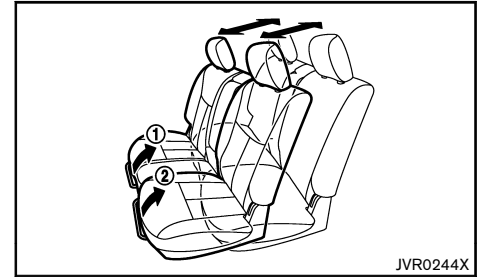

1. Pull up the adjusting lever ① for the right-side seat or the adjusting lever ② for the left-side seat.
2. Slide the seat to the desired position.
3. Release the adjusting lever to lock the seat in position.

Reclining:

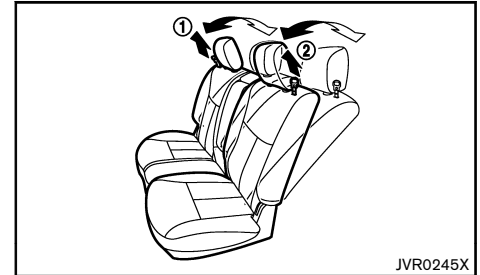

**CAUTION:**

Do not recline the rear seatback when you use the cup holders on the rear armrest. Doing so may cause the beverages to spill over, and if they are hot, they may scald the passengers.

1. Pull up the adjusting strap ① for the right-side seat or the adjusting strap ② for the left-side seat.
2. Tilt the seatback to the desired position.
3. Release the adjusting strap to lock the seatback in position.

The reclining feature allows the adjustment of the seatback for occupants of different sizes to help obtain the proper seat belt fit. (See "Seat belts" (P.1-11).)

The seatback may be reclined to allow occupants to rest when the vehicle is parked.

THIRD ROW SEAT (Three-row model)**CAUTION:**

Do not put your feet under the second row seats. Some parts of the seat frame may cause injuries.

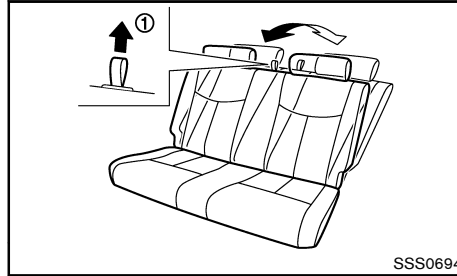
Manual seat adjustment**Reclining:**

1. Pull up the adjusting strap ①.
2. Tilt the seatback to the desired position.
3. Release the adjusting strap to lock the seatback in position.

The reclining feature allows the adjustment of the seatback for occupants of different sizes to help obtain the proper seat belt fit. (See "Seat belts" (P.1-11).)

The seatback may be reclined to allow occupants to rest when the vehicle is parked.

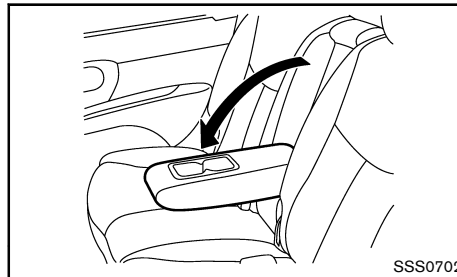
ARMREST (if equipped)

Pull the armrest forward until it is horizontal.

SEAT ARRANGEMENTS**WARNING:**

- **Never allow anyone to ride in the luggage area or on the rear seats when they are in the fold-down position. Use of these areas by passengers without proper restraints could result in serious injury in an accident or sudden stop.**
- **Do not fold down the rear seatbacks when occupants are in the rear seat area or any luggage is on the rear seats.**
- **Properly secure all luggage to help prevent it from sliding or shifting. Do not place luggage higher than the seatbacks.**
- **Securely store the removed head restraints to prevent them from being thrown around in case of a sudden stop or accident.**
- **Head restraints should be adjusted properly as they may provide significant protection against whiplash injury. Always replace and adjust them properly if they have been removed for any reason.**
- **When returning the seatbacks to the upright position, be certain they are completely secured in the latched position. If they are not completely secured, passengers may be injured in an accident or sudden stop.**

Stowing seat belt harnesses

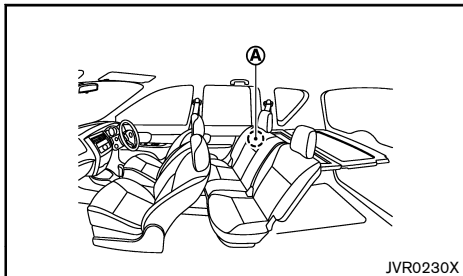

Two-row model

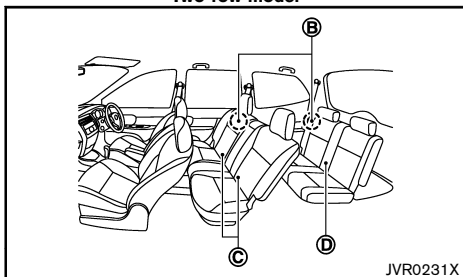

Three-row model

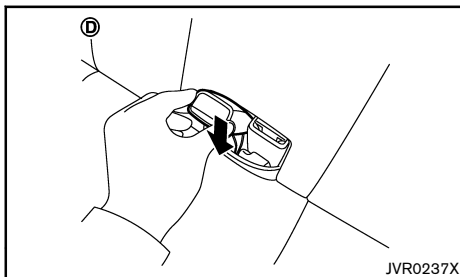
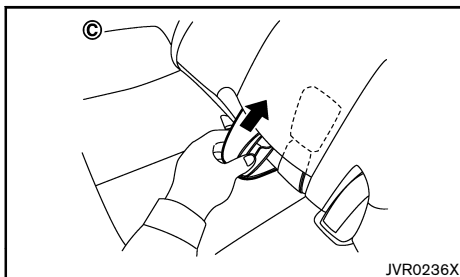
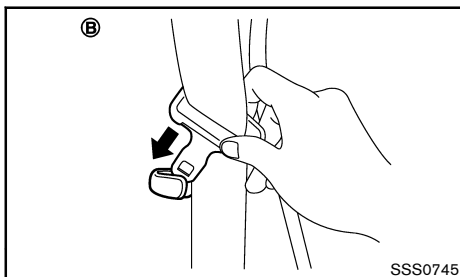
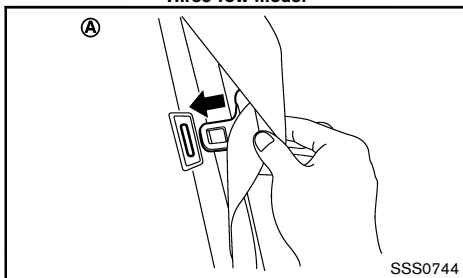

Before folding down the seatback, stow the seat belt harnesses as illustrated.

Two-row model

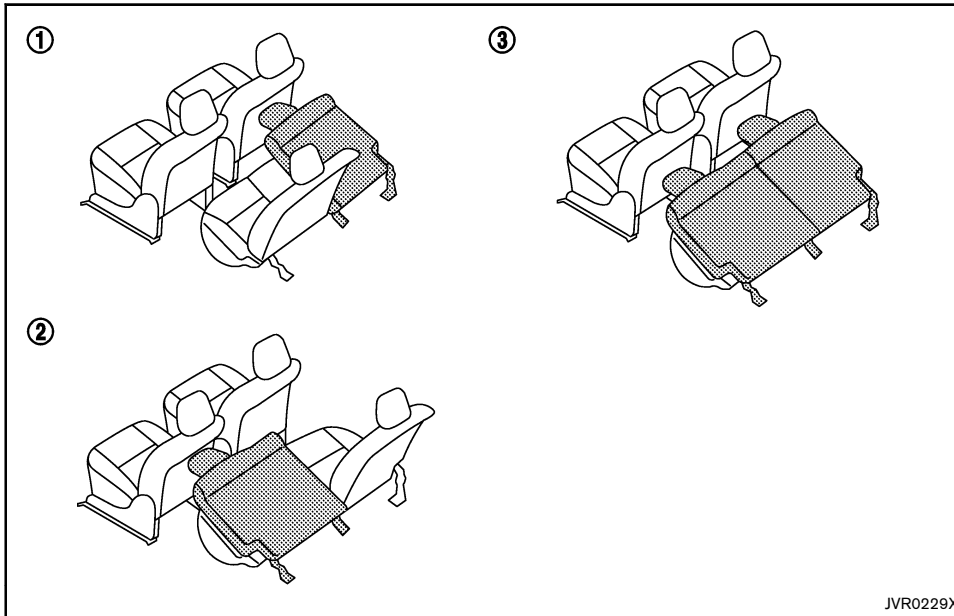

JVR0229X

1. Right-side rear split seat luggage mode (3 passengers and long luggage are available.)
2. Left-side rear split seat luggage mode (3 passengers and long, wide luggage are available.)
3. Rear split seat luggage mode (2 passengers and larger luggage are available.)

Folding rear split seat:

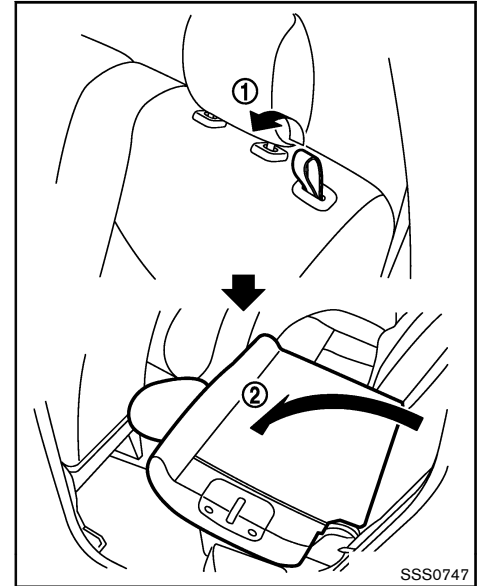

SSS0747

The rear split seat features a 60/40 split-fold function. The procedures below will apply for the left-side rear seat. If necessary, perform the same procedures for the right-side rear seat.

1. If the rear seatback is equipped with the head restraints, slide the front seat forward to make enough room behind the seat so that the rear seatback can be folded flat.
2. Pull the strap ① located on the seatback shoulder, and fold down the seatback ②.

To return the rear seatback, raise the seatback until it

latches.

When returning the seatback, make sure that the seat belt is not interfering with the seatback latch mechanism.

Three-row model

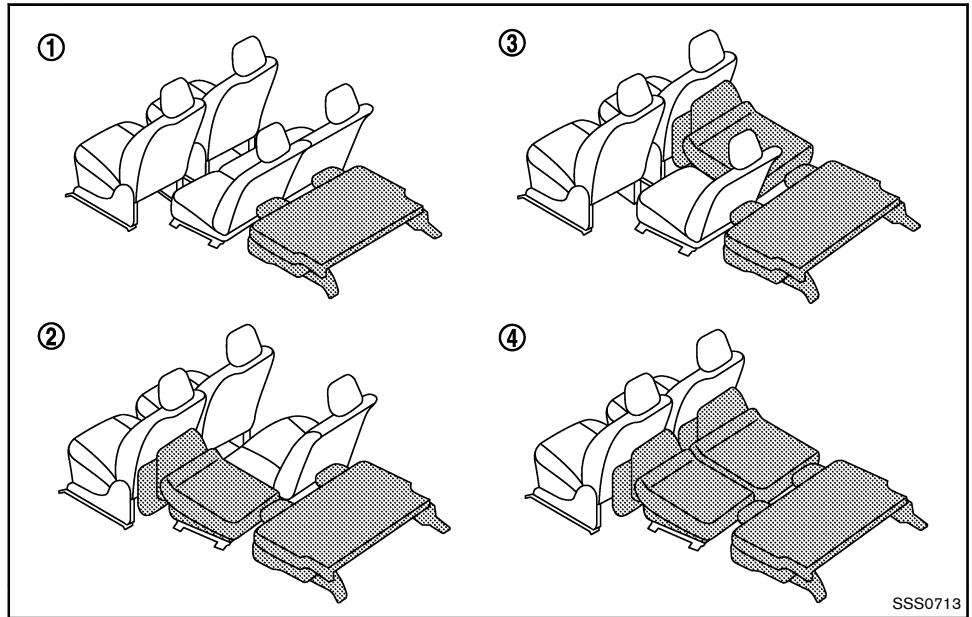

1. Third row seat luggage mode (5 passengers and luggage are available.)
2. Left-side second row and third row seat luggage mode (3 passengers and long luggage are available.)
3. Right-side second row and third row seat luggage mode (3 passengers and long, wide luggage are available.)
4. Second and third row seat luggage mode (2 passengers and larger luggage are available.)

Folding third row seat:

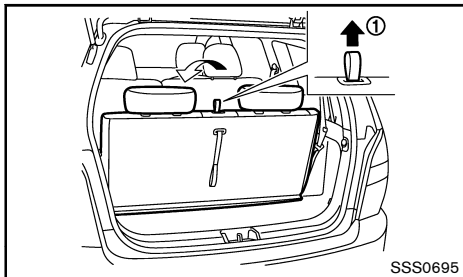

CAUTION:

When the third row seatback is folded down, its movable seat cushion also slides down to the floor. Be careful not to get your feet stuck between the seat cushion and the floor.

1. Move the third row seat head restraints (if equipped) to the lowest positions. (See “Head restraints” (P.1-9).)
2. Pull the strap ① and fold down the seatback.

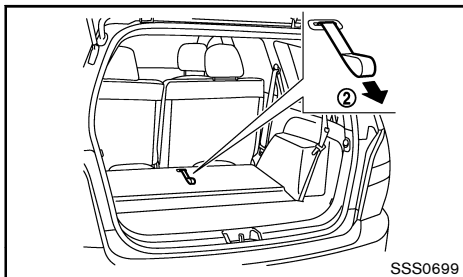

To return the seatback to the upright position, pull the

strap ② and raise the seatback until it latches.

Folding second row seat:

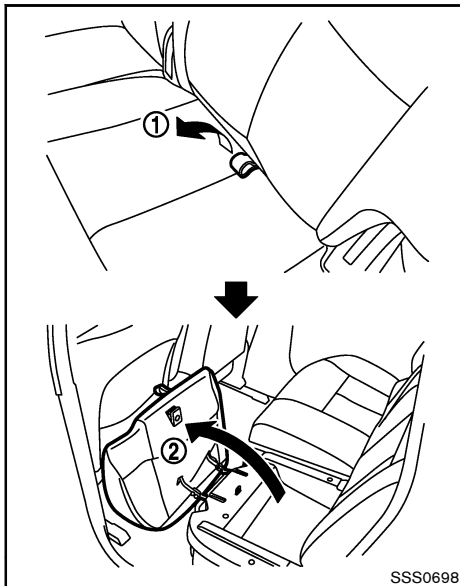

The second row seat features a 60/40 split-fold function. The procedures below will apply for the left-side second row seat. If necessary, perform the same procedures for the right-side second row seat.

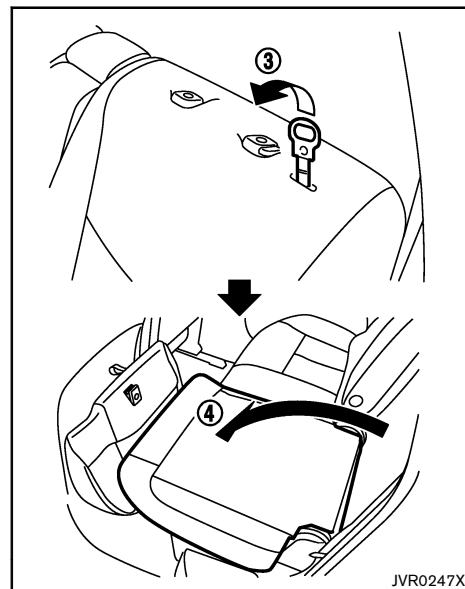

1. Remove the second row seat head restraint from the seatback. (See “Head restraints” (P.1-9).) Keep the head restraint secured in the luggage area floor box. (See “Luggage area floor box” (P.2-20).)
2. Slide the second row seat to the rearmost position. (See “Second row seats (Three-row model)” (P.1-3).)
3. Pull the strap ① located between the seatback and seat cushion, and raise the seat cushion forward ②.

HEAD RESTRAINTS (if equipped)

4. Pull the strap ③ located on the seatback shoulder, and fold down the seatback ④.

To return the second row seatback and seat cushion, raise the seatback and pull back the seat cushion until they latch.

When returning the seat cushion, make sure that the seat belt buckles do not fall under the seat cushion.



WARNING:

Head restraints supplement the other vehicle safety systems. They may provide additional protection against injury in certain rear end collisions. Adjustable head restraints must be adjusted properly, as specified in this section. Check the adjustment after someone else uses the seat. Do not attach anything to the head restraint stalks or remove the head restraint. Do not use the seat if the head restraint has been removed. If the head restraint was removed, reinstall and properly adjust the head restraint before an occupant uses the seating position. Failure to follow these instructions can reduce the effectiveness of the head restraint. This may increase the risk of serious injury or death in a collision.

- Your vehicle is equipped with a head restraint that may be integrated, adjustable or non-adjustable.
- Adjustable head restraints have multiple notches along the stalk to lock them in a desired adjustment position.
- The non-adjustable head restraints have single locking notch to secure them to the seat frame.
- Proper Adjustment:
 - For the adjustable type, align the head restraint so the center of your ear is approximately level with the center of the head restraint.
 - If your ear position is still higher than the recommended alignment, place the head restraint at the highest position.
- If the head restraint has been removed, ensure that it is reinstalled and locked in place before riding in that designated seating position.

ADJUSTABLE HEAD RESTRAINT COMPONENTS

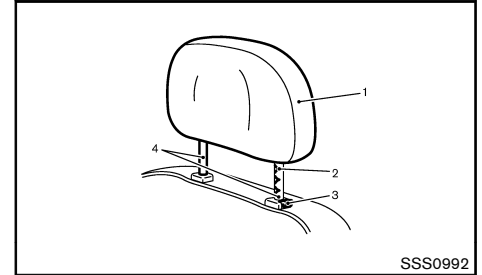

1. Removable head restraint
2. Multiple notches
3. Lock knob
4. Stalks

NON-ADJUSTABLE HEAD RESTRAINT COMPONENTS

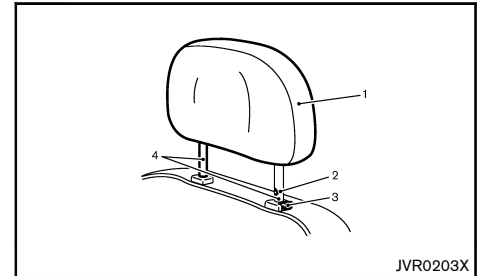

1. Removable head restraint

2. Single notch
3. Lock knob
4. Stalks

REMOVE

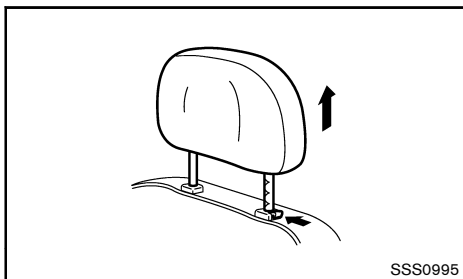

Use the following procedure to remove the adjustable head restraints.

1. Pull the head restraint up to the highest position.
2. Push and hold the lock knob.
3. Remove the head restraint from the seat.
4. Store the head restraint properly in a secure place so it is not loose in the vehicle.
5. Reinstall and properly adjust the head restraint before an occupant uses the seating position.

Before removing the rear head restraints, fold down the seatback. (See "Seat arrangements" (P.1-4).)

INSTALL

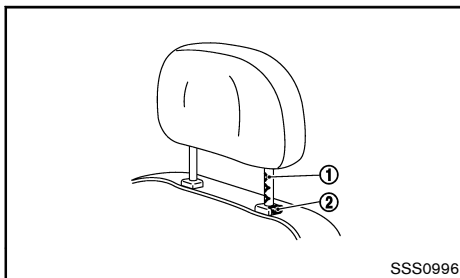

1. Align the head restraint stalks with the holes in the seat. Make sure that the head restraint is facing the correct direction. The stalk with the adjustment notch ① must be installed in the hole with the lock knob ②.
2. Push and hold the lock knob and push the head restraint down.
3. Properly adjust the head restraint before an occupant uses the seating position.

ADJUST

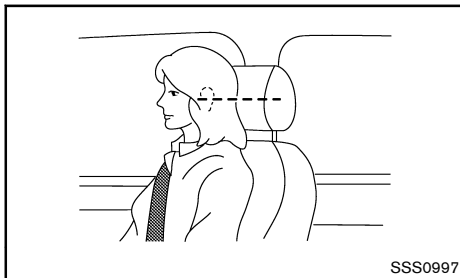

For adjustable head restraint

Adjust the head restraint so the center is level with the center of your ears. If your ear position is still higher than the recommended alignment, place the head restraint at the highest position.

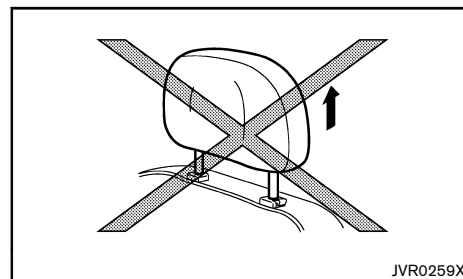

For non-adjustable head restraint

Make sure the head restraint is positioned from the stored position or any non-latch position so the lock knob is engaged in the notch before riding in that designated seating position.

Raise

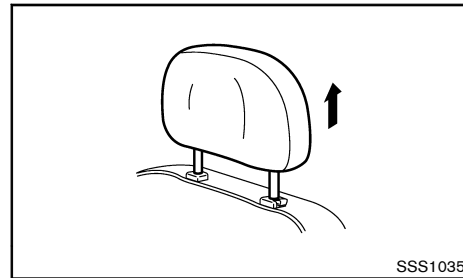

To raise the head restraint, pull it up.

SEAT BELTS

Make sure the head restraint is positioned from the stored position or any non-latch position so the lock knob is engaged in the notch before riding in that designated seating position.

Lower

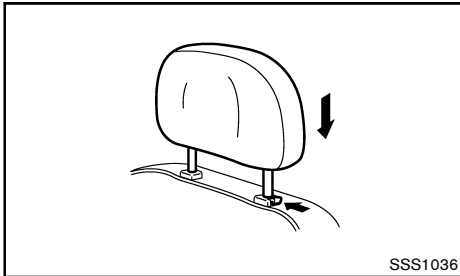

To lower, push and hold the lock knob and push the head restraint down.

Make sure the head restraint is positioned so the lock knob is engaged in the notch before riding in that designated seating position.

PRECAUTIONS ON SEAT BELT USAGE

If you are wearing the seat belt properly adjusted and sitting upright and well back in the seat, chances of being injured or killed in an accident and/or the severity of injury may be greatly reduced. NISSAN strongly encourages you and all of your passengers to buckle up every time you drive, even if your seating position includes the supplemental air bag systems.

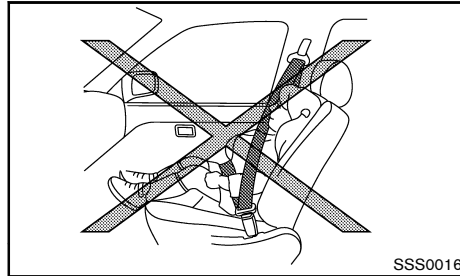
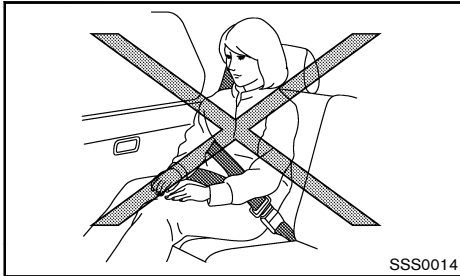
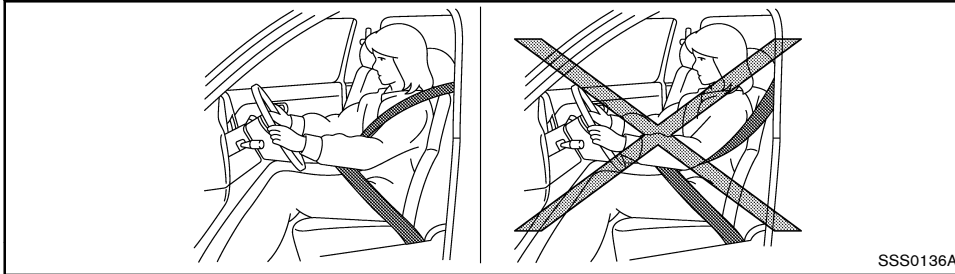
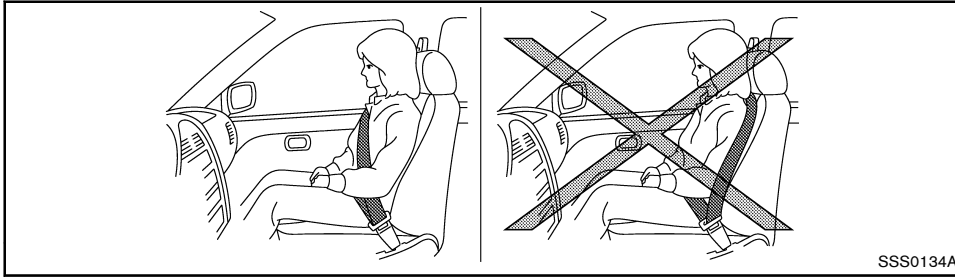

⚠ WARNING:

- Seatbelts are designed to bear upon the bony structure of the body, and should be worn low across the front of the pelvis or the pelvis, chest and shoulders, as applicable; wearing the lap section of the belt across the abdominal area must be avoided. Serious injury may occur if a seat belt is not worn properly.
- Position the lap belt as low and snug as possible around the hips, not the waist. A lap belt worn too high could increase the risk of internal injuries in an accident.
- Do not allow more than one person to use the same seat belt. Each belt assembly must only be used by one occupant; it is dangerous to put a belt around a child being carried on the occupant's lap.
- Never carry more people in the vehicle than there are seat belts.
- Never wear seat belts inside out. Belts should not be worn with straps twisted. Doing so may reduce their effectiveness.
- Seatbelts should be adjusted as firmly as possible, consistent with comfort, to provide the protection for which they have been designed. A slack belt will greatly reduce the protection afforded to the wearer.
- Every person who drives or rides in this vehicle should use a seat belt at all times. Children should be properly restrained in the rear seat and, if appropriate, in a child restraint system.

- Do not run the belt behind your back or under your arm. Always route the shoulder belt over your shoulder and across your chest. The belt should be away from your face and neck, but not falling off your shoulder. Serious injury may occur if a seat belt is not worn properly.
- No modifications or additions should be made by the user which will either prevent the seat belt adjusting devices from operating to remove slack, or prevent the seat belt assembly from being adjusted to remove slack.
- Care should be taken to avoid contamination of the webbing with polishes, oils and chemicals, and particularly battery acid. Cleaning may safely be carried out using mild soap and water. The belt should be replaced if webbing becomes frayed, contaminated or damaged.
- All seat belt assemblies including retractors and attaching hardware should be inspected after any collision by a NISSAN dealer. NISSAN recommends that all seat belt assemblies in use during a collision be replaced unless the collision was minor and the belts show no damage and continue to operate properly. Seat belt assemblies not in use during a collision should also be inspected and, when necessary, replaced if either damage or improper operation is noted.
- It is essential to replace the entire assembly after it has been worn in a severe impact even if damage to the assembly is not obvious.

- Once the pre-tensioner seat belt has activated, it cannot be reused. It must be replaced together with the retractor. Contact a NISSAN dealer.
- Removal and installation of the pre-tensioner seat belt system components should be done by a NISSAN dealer.

CHILD SAFETY



WARNING:

- Infants and children need special protection. The vehicle's seat belts may not fit them properly. The shoulder belt may come too close to the face or neck. The lap belt may not fit over their small hipbones. In an accident, an improperly fitted seat belt could cause serious or fatal injury.
- Always use an appropriate child restraint system.

Children need adults to help protect them. They need to be properly restrained. The proper restraint depends on the child's size.

Infants and small children

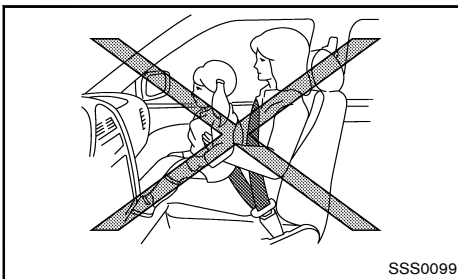

SSS0099

NISSAN recommends that infants and small children be seated in a child restraint system. You should choose a child restraint system that fits your vehicle and the child, and always follow the manufacturer's instructions for installation and use.

Large children



WARNING:

- Never allow children to stand or kneel on any seats.
- Never allow children in the luggage area while the vehicle is moving. A child could be seriously injured in an accident or sudden stop.

Children who are too large for a child restraint system should be seated and restrained by the seat belts that are provided.

If the child's seating position has a shoulder belt that fits close to the face or neck, the use of a booster seat (commercially available) may help overcome this. The booster seat should raise the child so that the shoulder belt is properly positioned across the top, middle portion of the shoulder and the lap belt is low on the hips. The booster seat should also fit the vehicle seat. Once the child has grown so that the shoulder belt is no longer on or near the face or neck of the child, use the shoulder belt without the booster seat. In addition, there are many types of child restraint systems available for larger children that should be used for maximum protection.

PREGNANT WOMEN

NISSAN recommends that pregnant women use seat belts. The seat belt should be worn snug, and always position the lap belt as low as possible around the hips, not the waist. Place the shoulder belt over your shoulder and across your chest. Never run the lap/shoulder belt over your abdominal area. Contact your doctor for specific recommendations.

INJURED PERSONS

NISSAN recommends that injured persons use seat belts. Contact your doctor for specific recommendations.

THREE-POINT TYPE SEAT BELTS

Fastening seat belts

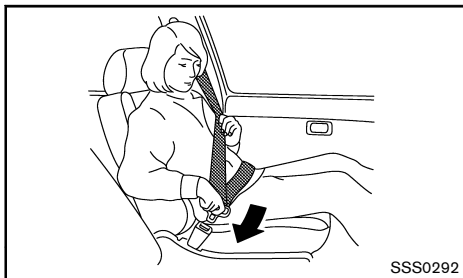

WARNING:

The seatback should not be in a reclined position any more than needed for comfort. Seat belts are most effective when the passenger sits well back and straight up in the seat.

1. Adjust the seat. (See “Seats” (P.1-2).)
2. Slowly pull the seat belt out of the retractor and insert the tongue into the buckle until you hear and feel the latch engage.
 - **The retractor is designed to lock during a sudden stop or on impact. A slow pulling motion permits the seat belt to move, and allows you some freedom of movement in the seat.**
 - **If the seat belt cannot be pulled from its fully retracted position, firmly pull the belt and release it. Then smoothly pull the belt out of the retractor.**

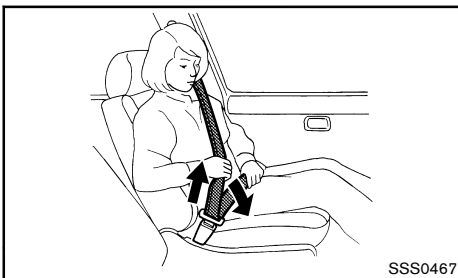

3. Position the lap belt portion low and snug on the hips as shown.
4. Pull the shoulder belt portion toward the retractor to take up extra slack. Be sure the shoulder belt is routed over your shoulder and is snug across your chest.

Unfastening seat belts

Push the button on the buckle. The seat belt automatically retracts.

Checking seat belt operation

Seat belt retractors are designed to lock seat belt movement:

- When the seat belt is pulled quickly from the retractor.
- When the vehicle slows down rapidly.

To increase your confidence in the seat belts, check the operation by grasping the shoulder belt and pulling forward quickly. The retractor should lock and restrict further belt movement. If the retractor does not lock during this check, contact a NISSAN dealer immediately.

TWO-POINT TYPE SEAT BELTS

Fastening seat belts

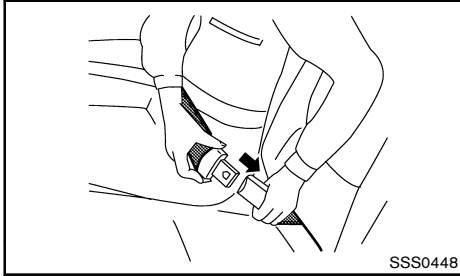

WARNING:

The seatback should not be in a reclined position any more than needed for comfort. Seat belts are most effective when the passenger sits well back and straight up in the seat.

1. Insert the tongue into the buckle marked CENTER until you hear and feel the latch engage.

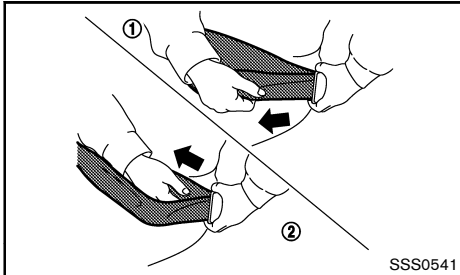

2. Adjust the seat belt length. To shorten, hold the tongue and pull the upper belt as illustrated ①. To lengthen, hold the tongue and pull the under belt as illustrated ②.

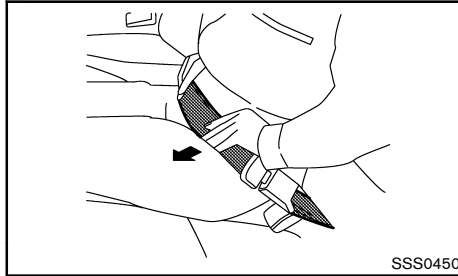

3. Position the lap belt portion low and snug on the hips as shown.

Unfastening seat belts

Push the button on the buckle.

CENTER MARK ON SEAT BELTS

Selecting correct set of seat belts

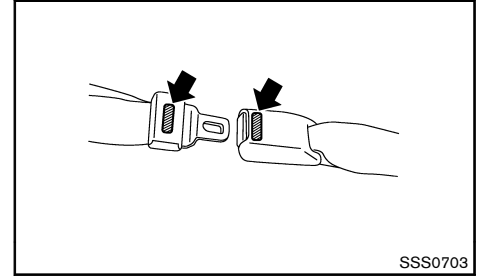

The center seat belt buckle and the tongue are identified by the CENTER mark. The center seat belt tongue can be fastened only into the center seat belt buckle.

SEAT BELT MAINTENANCE

Periodically check that the seat belt and all the metal components, such as buckles, tongues, retractors, flexible wires and anchors, work properly. If loose parts, deterioration, cuts or other damage on the seat belt webbing is found, the entire seat belt assembly should be replaced.

If dirt builds up in the shoulder belt guide of the seat belt anchors, the seat belts may retract slowly. Wipe the shoulder belt guide with a clean, dry cloth.

To clean the seat belt webbing, apply a mild soap solution or any solution recommended for cleaning upholstery or carpet. Then wipe with a cloth and allow the seat belts to dry in the shade. Do not allow the seat belts to retract until they are completely dry.

CHILD RESTRAINTS

PRECAUTIONS ON CHILD RESTRAINTS USAGE

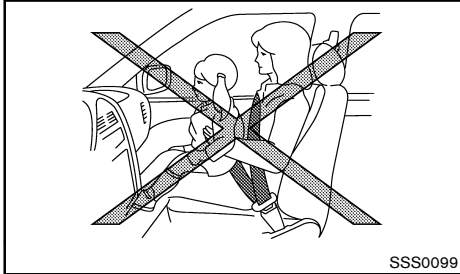

WARNING:

- Infants and small children should always be placed in an appropriate child restraint system while riding in the vehicle. Failure to use a child restraint system can result in serious injury or death.
- Infants and small children should never be carried on your lap. It is not possible for even the strongest adult to resist the forces of a severe accident. The child could be crushed between the adult and parts of the vehicle. Also, it is dangerous to put a seat belt around a child being carried on the occupant's lap.
- NISSAN recommends that the child restraint system be installed on the rear seat. According to accident statistics, children are safer when properly restrained in the rear seat rather than in the front seat.

- Improper use of a child restraint system can increase the risk or severity of injury for both the child and other occupants in the vehicle.
- Follow all of the child restraint system manufacturer's instructions for installation and use. When purchasing a child restraint system, be sure to select one which will fit your child and vehicle. It may not be possible to properly install some types of child restraint systems in your vehicle.
- Infants and children need special protection. The vehicle's seat belts may not fit them properly. The shoulder belt may come too close to the face or neck. The lap belt may not fit over their small hip bones. In an accident, an improperly fitting seat belt could cause serious or fatal injury.
- Child restraint systems specially designed for infants and small children are available from several manufacturers. When selecting any child restraint systems, place your child in the child restraint system and check the various adjustments to be sure that the child restraint system is compatible with your child. Always follow the manufacturer's instructions for installation and use.
- Adjustable seatbacks should be positioned to fit a child restraint system, but as upright as possible.
- After attaching a child restraint system, test it before you place the child in it. Tilt it from side to side. Try to tug it forward and check if it is held securely in place. The child restraint system should not move more than 25 mm (1 in). If the restraint is not secure, tighten the belt as necessary, or install the restraint in

another seat and test it again.

- Check the child restraint system in your vehicle to be sure that it is compatible with the vehicle's seat belt system.
- If a child restraint system is not anchored properly, the risk of a child being injured in a collision or a sudden stop greatly increases.
- Always use an appropriate child restraint system. An improperly installed child restraint system could lead to serious injury or death in an accident.
- When the child restraint is not in use, keep it secured with a seat belt to prevent it from being thrown around in case of a sudden stop or accident.
- Never install a rear-facing child restraint system in the front seat. An inflating supplemental front-impact air bag could seriously injure or kill your child. A rear-facing child restraint system must only be used in the rear seat.
- If the seat belt in the position where a child restraint system is installed requires a locking clip and if it is not used, injuries could result from a child restraint system tipping over during normal vehicle braking or cornering.
- For a front-facing child restraint system, make sure the shoulder belt does not fit close to child's face or neck. If it does, put the shoulder belt behind the child restraint system.

NISSAN recommends that infants and small children be seated in a child restraint system. You should choose a child restraint system that fits your vehicle

and always follow the manufacturer's instructions for installation and use. In addition, there are many types of child restraint systems available for larger children that should be used for maximum protection.

CAUTION:

Remember that a child restraint system left in a closed vehicle can become very hot. Check the seating surface and buckles before placing your child in a child restraint system.

INSTALLATION OF CHILD RESTRAINT SYSTEM

Installation on rear seat

WARNING:

- NISSAN recommends that the child restraint system be installed in a seat equipped with the three-point type seat belt.
- The direction of the child restraint system depends on the type of the child restraint system and the size of the child.

Front-facing:

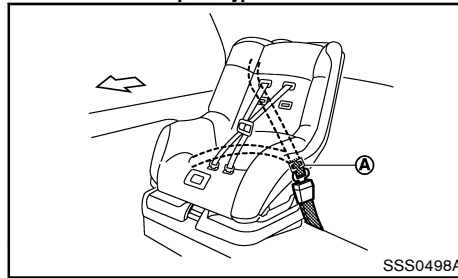
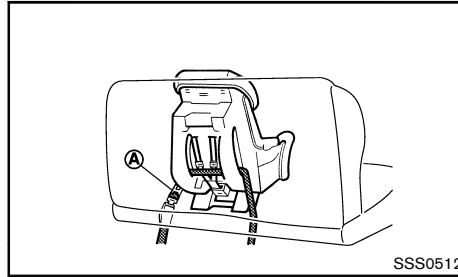

When you install a front-facing child restraint system on a rear seat, follow these steps:

1. Position the front-facing child restraint system on a rear seat.
Always follow the child restraint system manufacturer's instructions for installation and use.
2. Route the seat belt tongue through the child restraint system and insert it into the buckle until you hear and feel the latch engage.

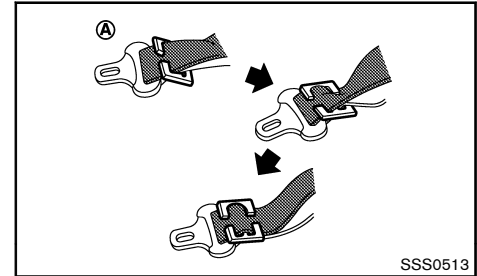

3. To prevent slack in the seat belt, it is necessary to secure the lap/shoulder belt in place with a locking clip (A). Use the locking clip attached to the child restraint system, or one which is equivalent in dimensions and strength.

Be sure to follow the child restraint system manufacturer's instructions for belt routing.

4. Test the child restraint system before you place the child in it. Tilt it from side to side. Try to tug it forward and check if it is held securely in place.
5. Make sure that the child restraint system is properly secured prior to each use.

Rear-facing:

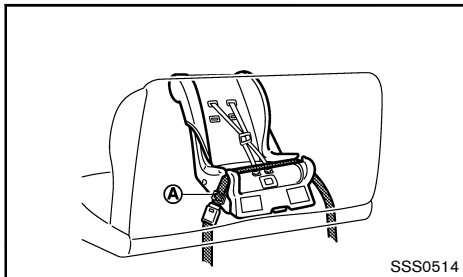

Two-point type seat belt

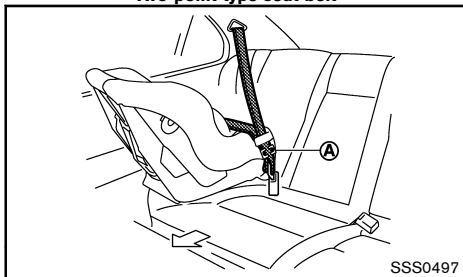

Three-point type seat belt

When you install a rear-facing child restraint system on a rear seat, follow these steps:

1. Position the rear-facing child restraint system on a rear seat.
Always follow the child restraint system manufacturer's instructions for installation and use.
2. Route the seat belt tongue through the child restraint system and insert it into the buckle until you hear and feel the latch engage.

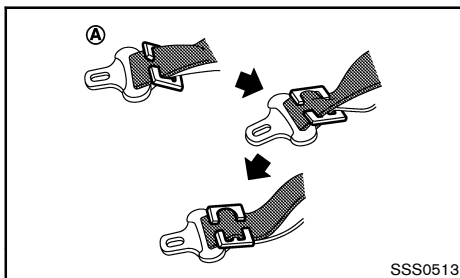

Locking clip

3. To prevent slack in the seat belt, it is necessary to secure the lap/shoulder belt in place with a locking clip (A). Use the locking clip attached to the child restraint system, or one which is equivalent in dimensions and strength.

Be sure to follow the child restraint system manufacturer's instructions for belt routing.

4. Test the child restraint system before you place the child in it. Tilt it from side to side. Try to tug it forward and check if it is held securely in place.
5. Make sure that the child restraint system is properly secured prior to each use.

Installation on front seat - with front passenger air bag

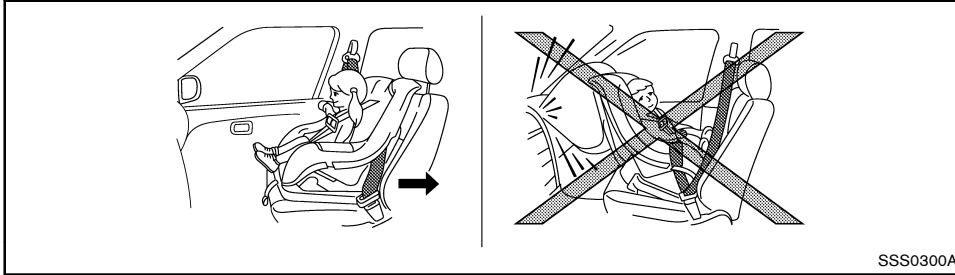

SSS0300A

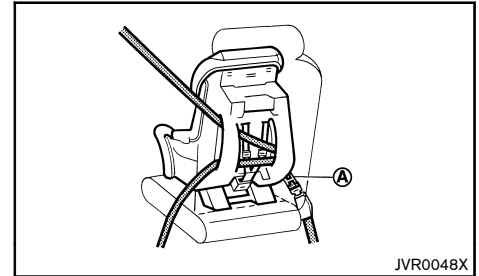

JVR0048X

4. Route the seat belt tongue through the child restraint system and insert it into the buckle until you hear and feel the latch engage.

WARNING:

- Never install a rear-facing child restraint on the front passenger's seat. Supplemental front-impact air bags inflate with great force. A rear-facing child restraint could be struck by the supplemental front-impact air bags in an accident and could seriously injure or kill your child.
- NISSAN recommends that a child restraint system be installed on the rear seat. However, if you must install a front-facing child restraint system on the front passenger's seat, move the passenger's seat to the rearmost position.
- Child restraint systems for infants must be used in the rear-facing direction and therefore must not be used on the front seat.

Front-facing:

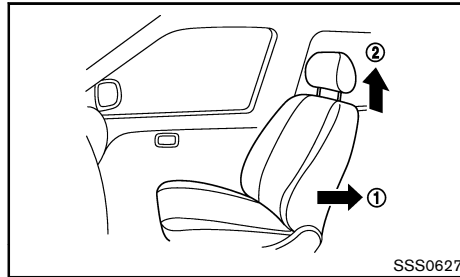

SSS0627

If you must install a front-facing child restraint system on the front seat, follow these steps:

1. Move the seat to the rearmost position ①.
2. Adjust the head restraint to its highest position ②.
3. Position the front-facing child restraint system on the front passenger's seat. It should be placed in the front-facing direction only.

Always follow the child restraint system manufacturer's instructions for installation and use.

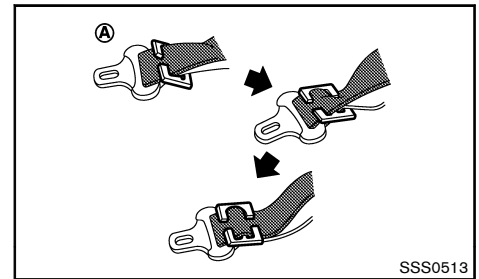

SSS0513

Locking clip

5. To prevent slack in the seat belt, it is necessary to secure the lap/shoulder belt in place with a locking clip A. Use the locking clip attached to the child restraint system, or one which is equivalent in dimensions and strength.

Be sure to follow the child restraint system manufacturer's instructions for belt routing.

6. Slide the seat forward so that the seat belt fully tightens the child restraint system.

7. Test the child restraint system before you place the child in it. Tilt it from side to side. Try to tug it forward and check if it is held securely in place.
8. Make sure that the child restraint system is properly secured prior to each use.

Installation on front seat - without front passenger air bag



WARNING:

NISSAN recommends that a child restraint system be installed on the rear seat. However, if you must install a child restraint system in the front passenger's seat, move the passenger's seat to the rearmost position.

Rear-facing:

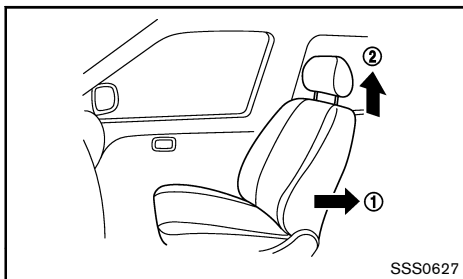

If you must install a rear-facing child restraint system on the front seat, follow these steps:

1. Move the seat to the rearmost position ①.
2. Adjust the head restraint to its highest position ②.
3. Position the rear-facing child restraint system on the front passenger's seat.

Always follow the child restraint system manufacturer's instructions for installation and use.

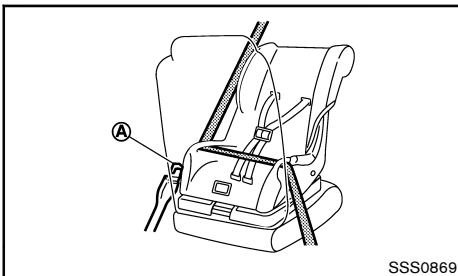

4. Route the seat belt tongue through the child restraint system and insert it into the buckle until you hear and feel the latch engage.

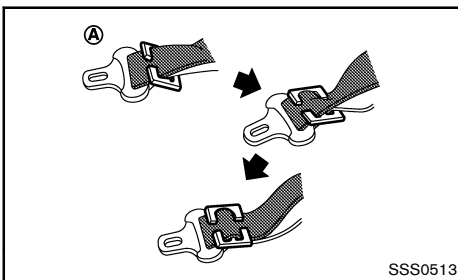

5. To prevent slack in the lap belt, it is necessary to secure the lap/shoulder belt in place with a locking clip (A). Use the locking clip attached to the child restraint system, or one which is equivalent in dimensions and strength.

Be sure to follow the child restraint system manufacturer's instructions for belt routing.

6. Slide the seat forward so that the seat belt fully tightens the child restraint system.
7. Test the child restraint system before you place the child in it. Tilt it from side to side. Try to tug it forward and check if it is held securely in place.
8. Make sure that the child restraint system is properly secured prior to each use.

Front-facing:

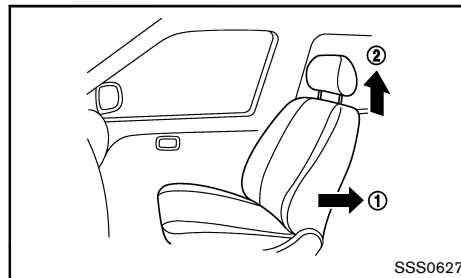

If you must install a front-facing child restraint system on the front seat, follow these steps:

1. Move the seat to the rearmost position ①.
2. Adjust the head restraint to its highest position ②.
3. Position the front-facing child restraint system on the front passenger's seat.

Always follow the child restraint system manufacturer's instructions for installation and use.

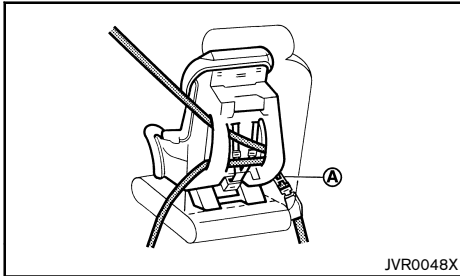

4. Route the seat belt tongue through the child restraint system and insert it into the buckle until you hear and feel the latch engage.

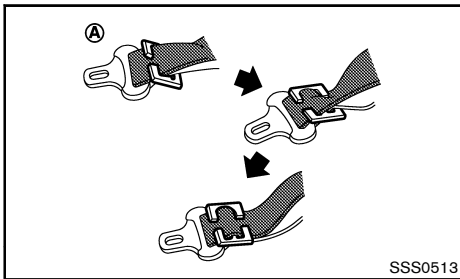

5. To prevent slack in the lap belt, it is necessary to secure the lap/shoulder belt in place with a locking clip (A). Use the locking clip attached to the child restraint system, or one which is equivalent in dimensions and strength.

Be sure to follow the child restraint system manufacturer's instructions for belt routing.

6. Slide the seat forward so that the seat belt fully tightens the child restraint system.

7. Test the child restraint system before you place the child in it. Tilt it from side to side. Try to tug it forward and check if it is held securely in place.
8. Make sure that the child restraint system is properly secured prior to each use.

SUPPLEMENTAL RESTRAINT SYSTEM (SRS) (if equipped)

PRECAUTIONS ON SUPPLEMENTAL RESTRAINT SYSTEM (SRS)

This Supplemental Restraint System (SRS) section contains important information concerning the driver's and passenger's supplemental front-impact air bags and pre-tensioner seat belts.

Supplemental front-impact air bag system

This system can help cushion the impact force to the head and chest area of the driver and/or front passenger in certain frontal collisions. The supplemental front-impact air bag is designed to inflate on the front where the vehicle is impacted.

The SRS is designed to **supplement** the accident protection provided by the driver's and passenger's seat belts and **is not** designed to **substitute** for them. The SRS can help save lives and reduce serious injuries. However, inflating air bags may cause abrasions or other injuries. Air bags do not provide protection to the lower body. Seat belts should always be correctly worn and the occupants should always be seated a suitable distance away from the steering wheel and instrument panel. (See "Seat belts" (P.1-11).) The air bags inflate quickly in order to help protect the occupants. The force of the air bags inflating can increase the risk of injury if the occupants are too close to, or are against, the air bag modules during inflation.

The air bags will deflate quickly after deployment.

The SRS operates only when the ignition switch is in the "ON" or "START" position.

When the ignition switch is in the "ON" position, the SRS air bag warning light illuminates for about 7 seconds and then turns off. This indicates that the SRS is operational. (See "Supplemental Restraint System (SRS) air bag

warning light" (P.2-11).)

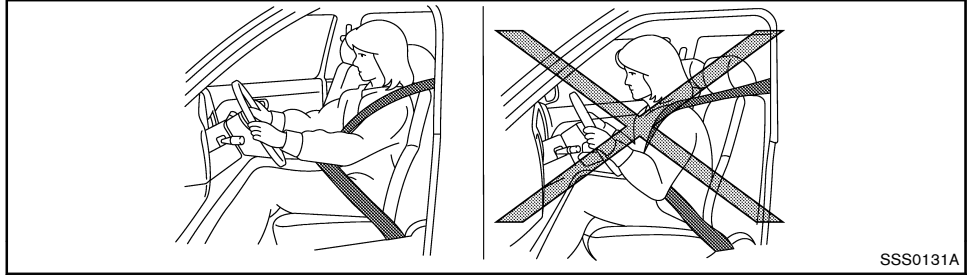

SSS0131A

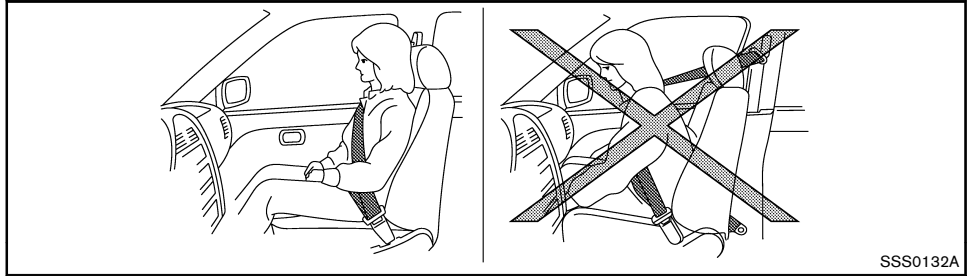

SSS0132A



WARNING:

- The supplemental front-impact air bags ordinarily will not inflate in the event of a side impact, rear impact, rollover, or lower severity frontal collision. Always wear the seat belts to help reduce the risk or severity of injury in accidents.
- The seat belts and the supplemental front-impact air bags are most effective when you are sitting well back and upright in the seat. The front-impact air bags inflate with great

force. If you and your passengers are unrestrained, leaning forward, sitting sideways, or out of position in any way, you and your passengers are at greater risk of injury or death in an accident. You and your passengers may also receive serious or fatal injuries from the supplemental front-impact air bag if you are up against it when it inflates. Always sit back against the seatback and as far away as practical from the steering wheel or instrument panel. Always use the seat belts.

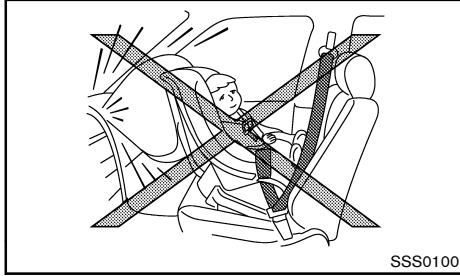
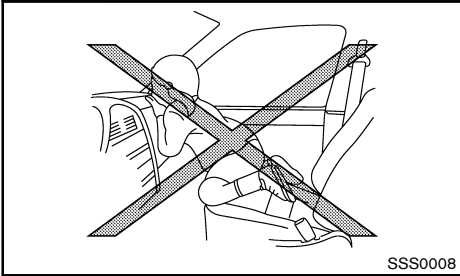
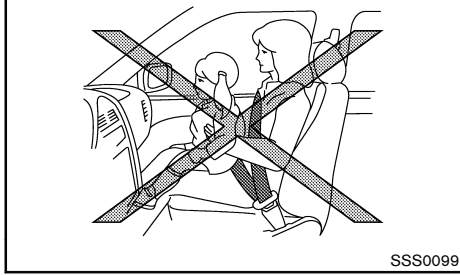
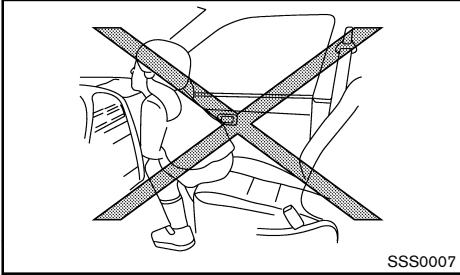
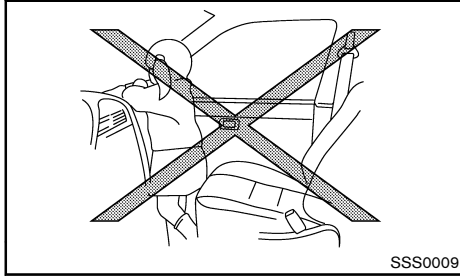
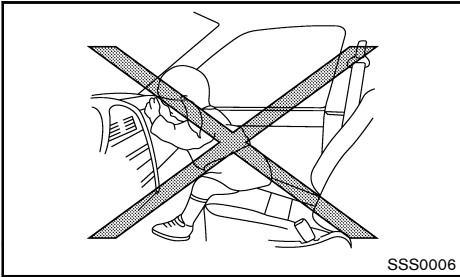

WARNING:

- Never let children ride unrestrained or extend their hands or face out of the window. Do not attempt to hold them in your lap or arms. Some examples of dangerous riding positions are shown in the illustrations.
- Children may be severely injured or killed when the air bags inflate if they are not properly restrained.
- Never install a rear-facing child restraint system on the front seat. An inflating supplemental front-impact air bag could seriously injure or kill your child. (See "Child restraints" (P.1-16).)

Pre-tensioner seat belt system (if equipped)
 The pre-tensioner system may activate with the supplemental air bag system in certain types of collisions. Working with the front seat belt retractors and anchor, it helps tighten the seat belt the instant the vehicle becomes involved in certain types of collisions, helping to restrain front seat occupants.

Air bag warning labels

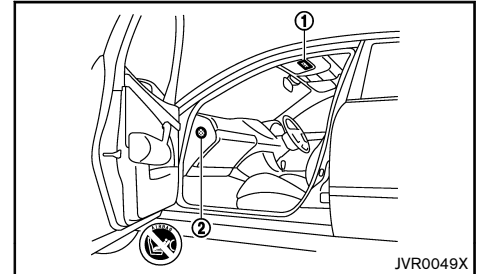

Warning labels about the supplemental air bag system are placed in the vehicle as shown in the illustration.

SRS air bag:

The warning label ① is located on the surface of the passenger's sun visor.

SRS front-impact passenger air bag (if equipped):

The warning label ② (if equipped) is located on the side of the passenger's side instrument panel.

This label warns you not to fit a rear-facing child restraint system on the front passenger seat as such a restraint system used in this position could cause serious injury to the infant in case of air bag deployment during a collision.

In vehicles equipped with a front-impact passenger air bag system, use a rear-facing child restraint system only on the rear seats. "Extreme Hazard! Do not use a rearward facing child restraint on a seat protected by an air bag in front of it!"

When installing a child restraint system in your vehicle, always follow the child restraint system manufacturer's instructions for installation. For additional information, see "Child restraints" (P.1-16).

SRS air bag warning light



The SRS air bag warning light, displaying  in the meter, monitors the circuits for the air bag systems, pre-tensioners and all related wiring.

When the ignition switch is in the "ON" position, the SRS air bag warning light illuminates for about 7 seconds and then turns off. This indicates that the SRS air bag systems are operational.

If any of the following conditions occur, the air bag and/or pre-tensioner seat belt systems need servicing:

- The SRS air bag warning light remains on after approximately 7 seconds.
- The SRS air bag warning light flashes intermittently.
- The SRS air bag warning light does not illuminate at all.

Under these conditions, the air bag and/or pre-tensioner seat belt systems may not operate properly. They must be checked and repaired. Contact a NISSAN dealer immediately.

SUPPLEMENTAL AIR BAG SYSTEMS

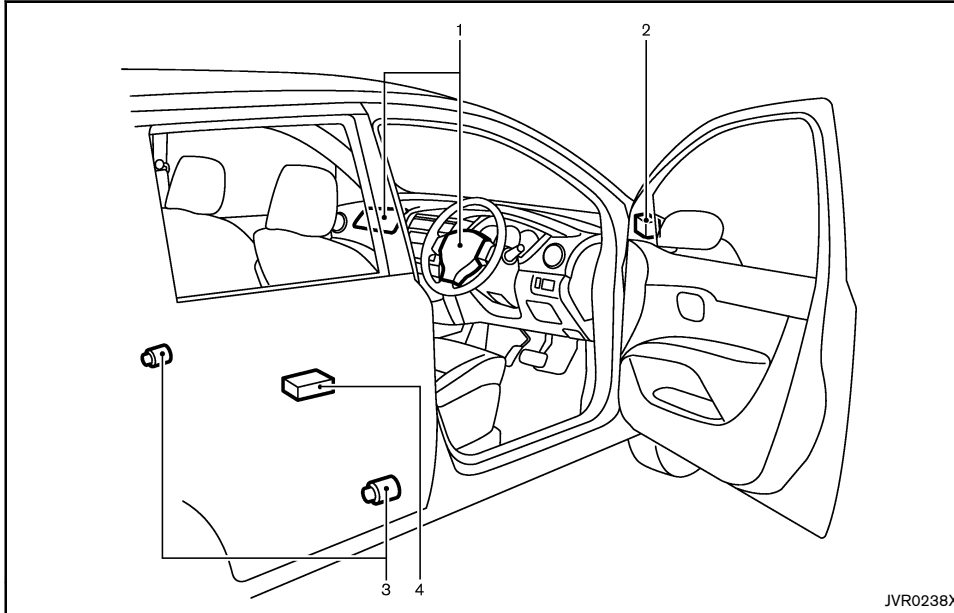

1. Supplemental front-impact air bag modules (Driver's and front passenger's) (if equipped)
2. Crash zone sensor
3. Pre-tensioner seat belt retractor (if equipped)
4. Diagnosis sensor unit



WARNING:

- Do not place any objects on the steering wheel pad and on the instrument panel. Do not place any objects between any occupants and the steering wheel pad and on the instrument panel. Such objects may become dangerous projectiles and cause injury if a supplemental air bag inflates.

- Immediately after inflation, several supplemental air bag system components will be hot. Do not touch them: you may severely burn yourself.
- No unauthorized changes should be made to any components or wiring of the supplemental air bag systems. This is to prevent accidental inflation of the supplemental air bags or damage to the supplemental air bag systems.
- Do not make unauthorized changes to your vehicle's electrical system, suspension system, front end structure, and side panels. This could affect proper operation of the supplemental air bag systems.
- Tampering with the supplemental air bag systems may result in serious personal injury. Tampering includes changes to the steering wheel and the instrument panel by placing materials over the steering wheel pad and above, around or on the instrument panel or by installing additional trim materials around the supplemental air bag systems.
- Work around and on the supplemental air bag systems should be done by a NISSAN dealer. The SRS wiring should not be modified or disconnected. Unauthorized electrical test equipment and probing devices should not be used on the supplemental air bag systems.
- The SRS wiring harness connectors are yellow and/or orange for easy identification.

When the air bags inflate, a fairly loud noise may be heard, followed by the release of smoke. This smoke is not harmful and does not indicate a fire. Care should

be taken not to inhale it, as it may cause irritation and choking. Those with a history of a breathing condition should get fresh air promptly.

Supplemental front-impact air bag system

The driver's supplemental front-impact air bag is located at the center of the steering wheel. The passenger's supplemental front-impact air bag (if equipped) is located at the instrument panel above the glove box.

The supplemental front-impact air bag system is designed to inflate in higher severity frontal collisions, although it may inflate if the forces in another type of collision are similar to those of a higher severity frontal impact. It may not inflate in certain frontal collisions. Vehicle damage (or lack of it) is not always an indication of proper supplemental front-impact air bag system operation.

SRS AIR BAG DEPLOYMENT CONDITIONS

The SRS air bags activate in the event of a front impact in which the vehicle occupants may be severely injured even if they are wearing the seat belts properly.

They may not activate when the crash energy is absorbed and/or distributed by the vehicle body. Vehicle damage (or lack of it) is not always an indication of proper SRS air bag system operation.

When the SRS air bag will deploy

Supplemental front-impact air bags:

The supplemental front-impact air bag system is designed to inflate in higher severity frontal collisions. Some examples are shown in the following illustrations.

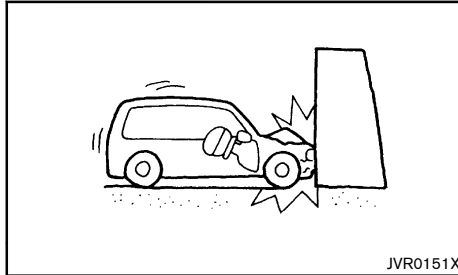

The supplemental front-impact air bag system will deploy in the event of an impact which exceeds a 25 km/h frontal collision with a solid wall that does not move or deform.

The supplemental front-impact air bag system may also deploy when the vehicle receives severe damage to the undercarriage.

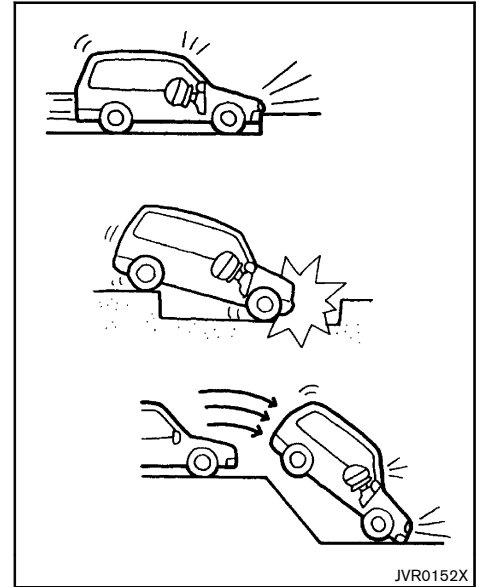

- Hitting a curb, pavement edge or hard surface at high speed
- Falling into a deep hole or ditch
- Landing hard on the ground after jumping

When the SRS air bag is unlikely to deploy

The SRS air bags may not deploy in cases where the impact is not forceful enough to inflate the SRS air bags.

For example, if the vehicle strikes an object, such as a parked vehicle or sign pole, which can move or deform on impact, the SRS air bags are unlikely to deploy.

Supplemental front-impact air bags:

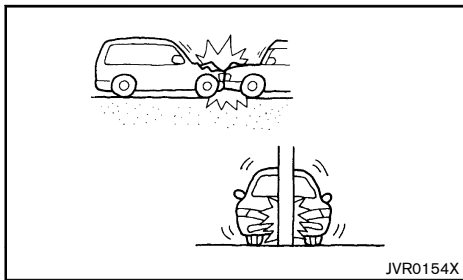

- Striking a vehicle of the same class that is parked
- Crashing into a solid utility pole

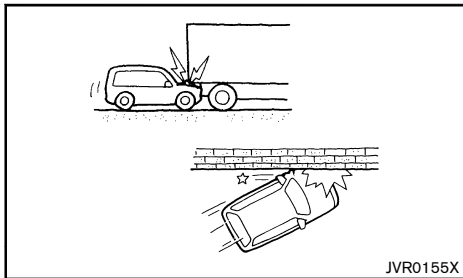

- Running under the tail gate of a truck
- A frontal offset impact to the guard rails

When the SRS air bag will not deploy

Once the SRS air bag has inflated, the air bag module will not function again if your vehicle collides with another vehicle or an object.

Other examples where the SRS air bag will not deploy are shown in the following illustrations.

Supplemental front-impact air bags:

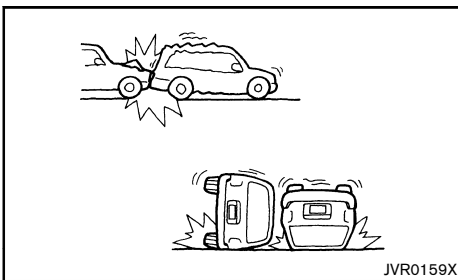

- A collision from the side or rear
- Vehicle rollover

PRE-TENSIONER SEAT BELT SYSTEM (if equipped)



WARNING:

- **The pre-tensioner seat belt cannot be re-used after activation. It must be replaced together with the retractor and buckle as a unit.**
- **If the vehicle becomes involved in a collision but the pre-tensioner is not activated, be sure to have the pre-tensioner system**

checked and, if necessary, replaced by a NISSAN dealer.

- **No unauthorized changes should be made to any components or wiring of the pre-tensioner seat belt system. This is to prevent accidental activation of the pre-tensioner seat belt or damage to the pre-tensioner seat belt system.**
- **Work around or on the pre-tensioner seat belt system should be done by a NISSAN dealer. The SRS wiring should not be modified or disconnected. Unauthorized electrical test equipment and probing devices should not be used on the pre-tensioner seat belt system.**
- **If you need to dispose of the pre-tensioner seat belt system, or scrap the vehicle, contact a NISSAN dealer. Correct pre-tensioner disposal procedures are set forth in the appropriate NISSAN Service Manual. Incorrect disposal procedures could cause personal injury.**

The pre-tensioner seat belt system may activate with the supplemental air bag system in certain types of collisions.

Working with the seat belt retractor, it helps tighten the seat belt when the vehicle becomes involved in certain types of collisions, helping to restrain front seat occupants.

The pre-tensioner is encased with the front seat belt's retractor and anchor. These seat belts are used the same as conventional seat belts.

When the pre-tensioner seat belt activates, a fairly loud noise may be heard, followed by the release of smoke. This smoke is not harmful and does not indicate a fire. Care should be taken not to inhale it, as it may cause

irritation and choking. Those with a history of a breathing condition should get fresh air promptly.

REPAIR AND REPLACEMENT PROCEDURE



WARNING:

- **Once the air bags have been inflated, the air bag modules will not function and must be replaced. The air bag modules must be replaced by a NISSAN dealer. The inflated air bag modules cannot be repaired.**
- **The air bag systems should be inspected by a NISSAN dealer if there is any damage to the front end or side portion of the vehicle.**
- **If you need to dispose of the SRS or scrap the vehicle, contact a NISSAN dealer. Correct disposal procedures are set forth in the appropriate NISSAN Service Manual. Incorrect disposal procedures could cause personal injury.**

The air bags and pre-tensioner seat belts are designed to activate on a one-time-only basis. As a reminder, unless the SRS air bag warning light is damaged, the SRS air bag warning light remains illuminated after inflation has occurred. The repair and replacement of the SRS should be done only by a NISSAN dealer.

When maintenance work is required on the vehicle, information about the air bags, pre-tensioner seat belts and related parts should be pointed out to the person performing the maintenance. The ignition switch should always be in the "LOCK" position when working under the hood or inside the vehicle.

2 Instruments and controls

Cockpit	2-2	Defogger switch (if equipped)	2-15
Instrument panel	2-3	Horn	2-15
Meters and gauges	2-4	Windows	2-16
Vehicle information display	2-4	Power windows	2-16
Speedometer and odometer	2-5	Clock	2-17
Trip computer	2-5	Adjusting time	2-17
Tachometer	2-6	Ashtrays and cigarette lighter (if equipped)	2-17
Engine coolant temperature gauge	2-6	Ashtray	2-17
Fuel gauge	2-6	Cigarette lighter	2-17
Instrument brightness control	2-7	Storages	2-18
Automatic Transmission (AT)/Continuously Variable Transmission (CVT) position indicator (if equipped)	2-7	Glove box	2-18
Warning/indicator lights and audible reminders	2-8	Card holder (if equipped)	2-18
Checking bulbs	2-9	Cup holders	2-18
Warning lights	2-9	Cargo cover (if equipped)	2-19
Indicator lights	2-11	Luggage area floor box (if equipped)	2-20
Audible reminders	2-12	Luggage hooks (if equipped)	2-20
Headlight and turn signal switch	2-13	Roof rail (if equipped)	2-20
Headlight switch	2-13	Sun visors	2-21
Turn signal switch	2-13	Interior lights	2-21
Fog light switch (if equipped)	2-14	Room light	2-21
Front fog lights	2-14	Battery saver system	2-22
Wiper and washer switch	2-14	Luggage room light (if equipped)	2-22
Windshield wiper and washer switch	2-14		
Rear window wiper and washer switch	2-14		

COCKPIT

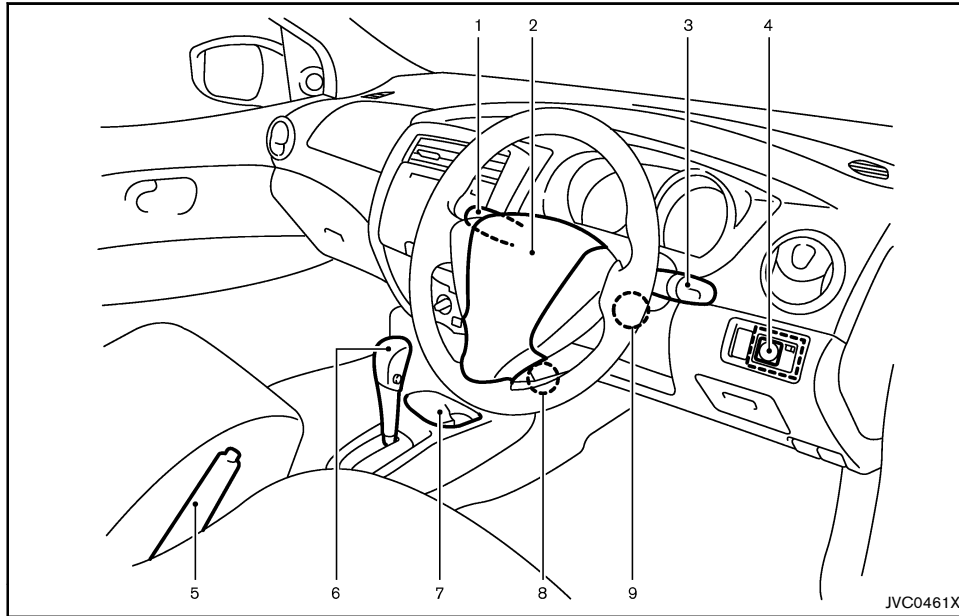

*: if equipped

- | | |
|--|--|
| 1. Wiper and washer switch | 4. Outside rearview mirror control switch |
| 2. Steering wheel | 5. Parking brake |
| - Electric power steering system | 6. Shift lever |
| - Horn | - Automatic Transmission (AT) |
| - Driver's supplemental front-impact air bag* | - Continuously Variable Transmission (CVT) |
| 3. Headlight, fog light and turn signal switch | - Manual Transmission (MT) |
| - Headlight | 7. Front cup holders |
| - Turn signal | 8. Tilting steering wheel lock lever |
| - Fog light* | 9. Ignition switch |
| | - Steering lock |

INSTRUMENT PANEL

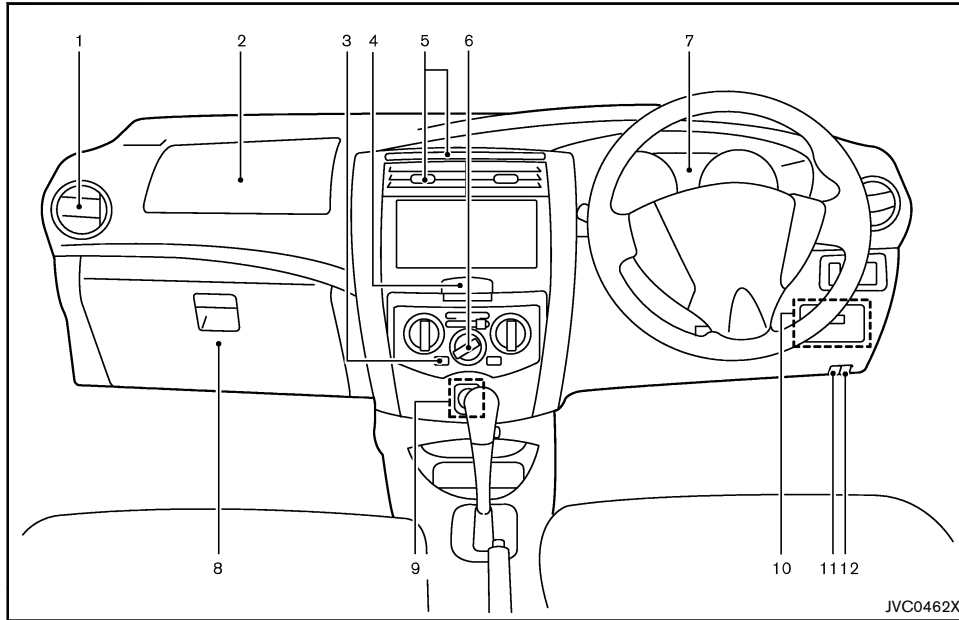

- | | |
|--------------------------------------|------------------------------------|
| 1. Side ventilator | 10. Fuse box cover |
| 2. Passenger's front-impact air bag* | 11. Hood release handle |
| 3. Defogger switch* | 12. Fuel filler lid release handle |
| 4. Hazard indicator flasher switch | *: if equipped |
| 5. Center ventilator | |
| 6. Manual cooler | |
| 7. Meters and gauges | |
| 8. Glove box | |
| 9. Cigarette lighter | |

METERS AND GAUGES

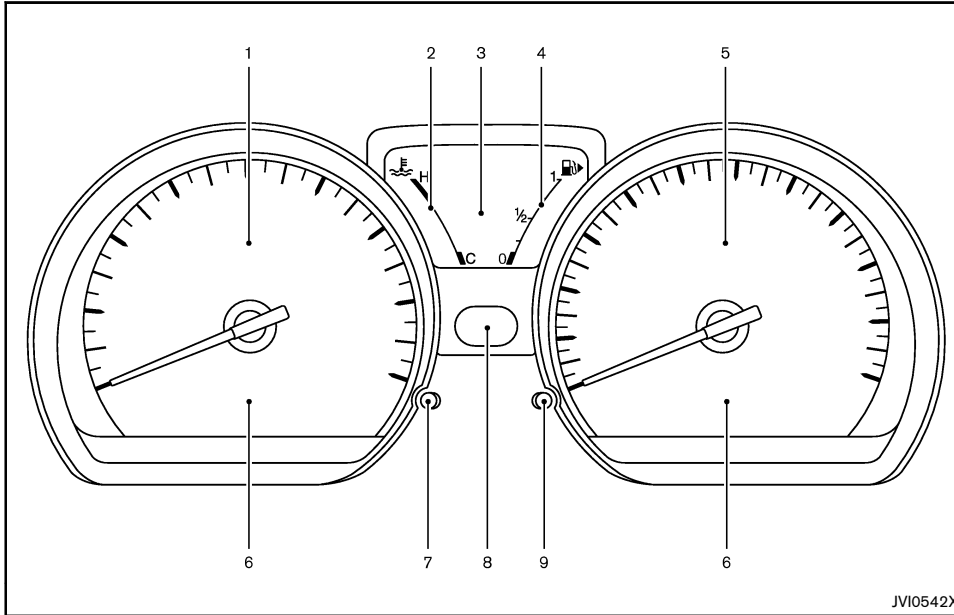

- | | |
|---|---|
| 1. Tachometer | 6. Warning/indicator lights |
| 2. Engine coolant temperature gauge | 7. Instrument brightness control knob |
| 3. Vehicle information display | 8. Automatic Transmission (AT)/Continuously Variable Transmission (CVT) position indicator* |
| — Odometer/twin trip odometer | 9. RESET switch for trip odometer/Trip computer mode switch |
| — Trip computer | |
| — Clock | *: if equipped |
| — Instrument brightness control display | |
| 4. Fuel gauge | |
| 5. Speedometer | |

The needle indicators may move slightly after the ignition switch is turned the "OFF" or "LOCK" position. This is not a malfunction.

VEHICLE INFORMATION DISPLAY

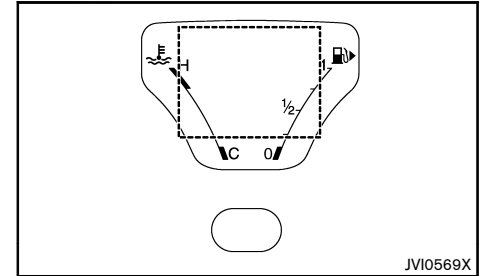

When the ignition switch is in the "ON" position, the vehicle information display shows the following information.

- Odometer/twin trip odometer
- Trip computer
- Clock
- Instrument brightness control display

SPEEDOMETER AND ODOMETER

Speedometer

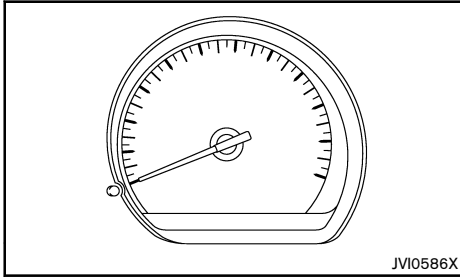

The speedometer indicates the vehicle speed.

Odometer/Twin trip odometer

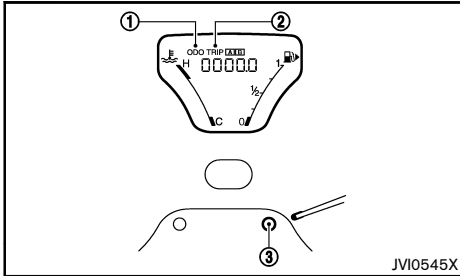

The odometer/twin trip odometer is displayed when the ignition switch is in the "ON" position.

The odometer ① displays the total distance the vehicle has been driven.

The twin trip odometer ② displays the distance of individual trips.

Changing twin trip odometer display:

Push the reset switch ③ to change the display as follows:

ODO → TRIP A → TRIP B → Trip computer mode → ODO

For trip computer information, see "Trip computer" (P.2-5).

Resetting twin trip odometer:

Push the reset switch ③ for more than 1 second to reset the trip odometer to zero.

TRIP COMPUTER

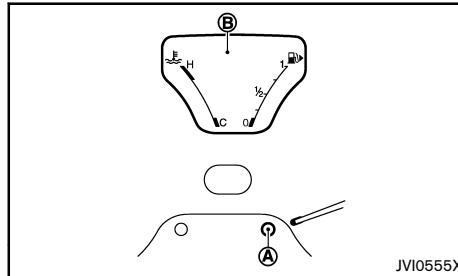

The switch for the trip computer is located on the meter panel ①.

Trip computer appears on the display ②.

When the ignition switch is placed in the "ON" position, the trip computer can be selected by pushing the switch ①.

Each time the switch ① is pushed, the display will change as follows:

ODO → TRIP A → TRIP B → Current fuel consumption → Average fuel consumption → Distance to empty (dte — km) → Clock settings mode → ODO

Current fuel consumption

The current fuel consumption mode shows the current fuel consumption.

Average fuel consumption (km/l(liter))

The average fuel consumption mode shows the average fuel consumption since the last reset. Resetting is done by pushing the switch ① for longer than 1 second.

The display is updated every 30 seconds. At about the first 500 m (1/3 miles) after a reset, the display shows "---".

Distance to empty (dte — km)

The distance to empty (dte) mode provides you with an estimation of the distance that can be driven before refueling. The dte is constantly being calculated, based on the amount of fuel in the fuel tank and the actual fuel consumption.

The display is updated every 30 seconds.

The dte mode includes a low range warning feature: when the fuel level is low, the dte mode is automatically selected and the digits blink in order to draw the driver's attention. Push the switch ① to return to the mode that was selected before the warning occurred.

When the fuel level drops even lower, the dte display will change to "----".

- If the amount of fuel added is small, the display just before the ignition switch is turned off may continue to be displayed.
- When driving uphill or rounding curves, the fuel in the tank shifts, which may momentarily change the display.

Clock settings mode

For clock adjustment, see "Clock" (P.2-17).

Resetting displays

When the average fuel consumption or TRIP B is displayed, push the switch **(A)** for longer than 3 seconds. The display of average fuel consumption and trip odometer (TRIP B only) will be reset at the same time.

TACHOMETER

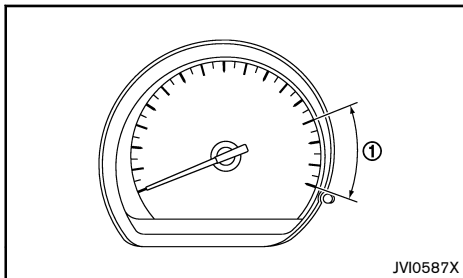

The tachometer indicates the engine speed in revolutions per minute (rpm).

Do not rev the engine into the red zone **(1).**

ENGINE COOLANT TEMPERATURE GAUGE

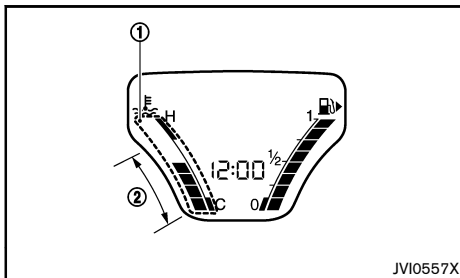

The engine coolant temperature gauge **(1)** indicates the engine coolant temperature.

The engine coolant temperature is normal when the gauge is within the zone **(2)** shown in the illustration.

The engine coolant temperature will vary with the outside air temperature and driving conditions.



CAUTION:

- **If the gauge indicates engine coolant temperature near the hot (H) end of the normal range, reduce vehicle speed to decrease temperature.**
- **If the gauge is over the normal range, stop the vehicle as soon as safely possible.**
- **If the engine is overheated, continued operation of the vehicle may seriously damage the engine. (See "If your vehicle overheats" (P.6-8) for immediate action required.)**

FUEL GAUGE

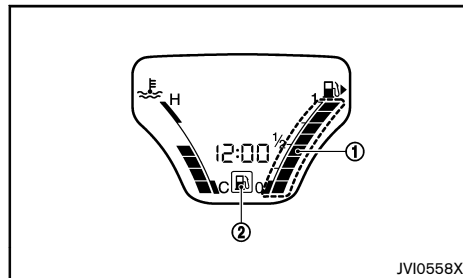

The fuel gauge **(1)** indicates the approximate fuel level in the tank when the ignition switch is in the "ON" position.

The gauge may move slightly during braking, turning, accelerating, or going up and down hills due to movement of fuel in the tank.

The low fuel warning light **(2)** illuminates when the fuel level in the tank is getting low. Refuel as soon as it is convenient, preferably before the gauge reads 0.

The arrow, , indicates the fuel filler lid is located on the right side of the vehicle.



CAUTION:

Refuel before the gauge reads 0 (empty).

There is a small reserve of fuel in the tank when the fuel gauge reads 0 (empty).

INSTRUMENT BRIGHTNESS CONTROL

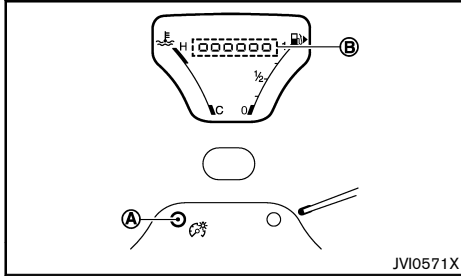

The instrument brightness control operates when the ignition switch is in the "ON" position.

Push the knob (A) to decrease the brightness of the meter panel lights. The brightness indicator (B) will be shown briefly in the display when the knob (A) is pushed.

If the brightness mode reaches the minimum level, the next time the switch is pressed, the brightness will return to the maximum level.





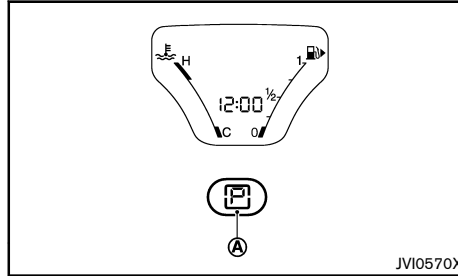













When the brightness level reaches the maximum or minimum, a beep will sound.

AUTOMATIC TRANSMISSION (AT)/CONTINUOUSLY VARIABLE TRANSMISSION (CVT) POSITION INDICATOR (if equipped)







The Automatic Transmission (AT)/Continuously Variable Transmission (CVT) position indicator (A) indicates the shift lever position when the ignition switch is in the "ON" position.





WARNING/INDICATOR LIGHTS AND AUDIBLE REMINDERS

	Anti-lock Braking System (ABS) warning light*		Intelligent Key system warning light*		Small light indicator light
	Brake warning light		Low fuel warning light		Sport mode indicator light*
	Charge warning light		Supplemental Restraint System (SRS) air bag warning light*		Security indicator light*
	Door open warning light		Front fog light indicator light*		Turn signal/hazard indicator lights
	Electric power steering warning light		High beam indicator light		
	Engine oil pressure warning light		Malfunction Indicator Light (MIL)		
	Intelligent Key lock warning light*		Overdrive off indicator light*		

*: if equipped

CHECKING BULBS

With all doors closed, apply the parking brake, fasten the seat belts and turn the ignition switch to the “ON” position without starting the engine. The following lights will illuminate: , , , , **PS**.

If equipped, the following lights will illuminate briefly and then turn off: , ,  **KEY**, , **SPORT**,  **OFF**.

If any lights fail to illuminate, it may indicate a burned-out bulb or an open circuit in the electrical system. Have the system checked, and if necessary repaired, by a NISSAN dealer promptly.

WARNING LIGHTS

 Anti-lock Braking System (ABS) warning light (if equipped)

When the ignition switch is in the “ON” position, the Anti-lock Braking System (ABS) warning light illuminates and then turns off. This indicates that the ABS is operational.

If the ABS warning light illuminates while the engine is running, or while driving, it may indicate that the ABS is not functioning properly. Have the system checked by a NISSAN dealer promptly.

If an ABS malfunction occurs, the anti-lock function is turned off. The brake system then operates normally, but without anti-lock assistance. (See “Brake system” (P.5-17).)

 Brake warning light



WARNING:

- **If the brake fluid level is below the minimum mark on the brake fluid reservoir, do not drive the vehicle until the brake system has been checked by a NISSAN dealer.**
- **Even if you judge it to be safe, have your vehicle towed because driving it could be dangerous.**
- **Depressing the foot brake pedal without the engine running and/or with a low brake fluid level could increase the stopping distance and require greater pedal travel distance and effort.**

The brake warning light indicates the parking brake system operation, a low brake fluid level of the brake system and an Anti-lock Braking System (ABS) malfunction.

Parking brake warning indicator:

When the ignition switch is turned to the “ON” position, the brake warning light illuminates. When the engine is started and the parking brake is released, the brake warning light turns off.

If the parking brake is not fully released, the brake warning light remains on. Be sure that the brake warning light has turned off before driving. (See “Parking brake” (P.3-19).)

Low brake fluid warning indicator:

If the brake warning light illuminates while the engine is running, or while driving, and the parking brake is released, it may indicate the brake fluid level is low.

When the brake warning light illuminates while driving, stop the vehicle safely as soon as possible. Stop the

engine and check the brake fluid level. If the brake fluid level is below the minimum mark on the reservoir, add brake fluid as necessary. (See “Brake and clutch fluid” (P.8-12).)

If the brake fluid level is sufficient, have the brake system checked by a NISSAN dealer promptly.

Anti-lock Braking System (ABS) warning indicator (if equipped):

When the parking brake is released and the brake fluid level is sufficient, if both the brake warning light and the Anti-lock Braking System (ABS) warning light illuminate, it may indicate the ABS is not functioning properly. Have the brake system checked, and if necessary repaired, by a NISSAN dealer promptly. (See “Anti-lock Braking System (ABS) warning light” (P.2-9).)

 Charge warning light

When the ignition switch is in the “ON” position, the charge warning light illuminates. After starting the engine, the charge warning light turns off. This indicates the charging system is operational.

If the charge warning light illuminates while the engine is running, or while driving, it may indicate the charging system is not functioning properly and may need servicing.

When the charge warning light illuminates while driving, stop the vehicle safely as soon as possible. Stop the engine and check the alternator belt. If the alternator belt is loose, broken or missing, the charging system needs repair. (See “Drive belts” (P.8-10).)

If the alternator belt appears to be functioning correctly but the charge warning light remains illuminated, have the charging system checked by a NISSAN dealer promptly.



CAUTION:

Do not continue driving if the alternator belt is loose, broken or missing.



Door open warning light

When the ignition switch is in the "ON" position, the door open warning light illuminates if any of the doors are open or not closed securely.



Electric power steering warning light

When the ignition switch is in the "ON" position, the electric power steering warning light illuminates. After starting the engine, the electric power steering warning light turns off. This indicates the electric power steering system is operational.

If the electric power steering warning light illuminates while the engine is running, it may indicate the electric power steering system is not functioning properly and may need servicing. Have the electric power steering system checked by a NISSAN dealer.

When the electric power steering warning light illuminates with the engine running, the power assist to the steering will cease operation but you will still have control of the vehicle. At this time, greater steering efforts are required to operate the steering wheel, especially in sharp turns and at low speeds.

(See "Electric power steering system" (P.5-16).)



Engine oil pressure warning light

When the ignition switch is in the "ON" position, the engine oil pressure warning light illuminates. After starting the engine, the engine oil pressure warning light turns off. This indicates that the oil pressure sensors in the engine are operational.

If the engine oil pressure warning light illuminates or blinks while the engine is running, it may indicate that the engine oil pressure is low.

Stop the vehicle safely as soon as possible. Stop the engine immediately and call a NISSAN dealer.



CAUTION:

- **Running the engine with the engine oil pressure warning light illuminated could cause serious damage to the engine.**
- **The engine oil pressure warning light is not designed to indicate a low oil level. The oil level should be checked using the dipstick. (See "Engine oil" (P.8-8).)**



Intelligent Key lock warning light (if equipped)

When the ignition switch is left in the "OFF" position instead of completely turning it to the "LOCK" position, the Intelligent Key lock warning light blinks in red and the Intelligent Key room buzzer will sound. The light will keep blinking until the ignition switch is returned to the "LOCK" or "ACC" position.

For Manual Transmission (MT) models, the light will blink for 5 minutes then turn off.

If the Intelligent Key lock warning light blinks and buzzer sounds:

- Make sure that the shift lever is in the "P" (Park) position (Automatic Transmission (AT)/Continuously Variable Transmission (CVT) Transmission model) and the ignition switch is returned to the "LOCK" position.
- Turn the ignition switch to the "ACC" position. (See "Intelligent Key system" (P.3-6).)



Intelligent Key system warning light (if equipped)

The Intelligent Key system warning light illuminates in green when the ignition switch can be turned. The Intelligent Key system warning light illuminates in red when the ignition switch cannot be turned even though the foot brake pedal is depressed.

The Intelligent Key system warning light blinks in red if the Intelligent Key is taken outside of the vehicle while the ignition switch is in the "ACC" or "ON" position.

- If the Intelligent Key system warning light blinks, make sure of the location of the Intelligent Key as soon as possible. The Intelligent Key should be carried by the driver while operating the vehicle.
- The Intelligent Key system warning light turns off about 10 seconds after the Intelligent Key is brought inside the vehicle.

The Intelligent Key system warning light blinks in green indicating that the Intelligent Key battery is almost discharged.

(See "Intelligent Key system" (P.3-6).)



Low fuel warning light

The low fuel warning light illuminates when the fuel level in the tank is getting low. Refuel as soon as it is convenient, preferably before the fuel gauge reaches 0 (empty).

There will be a small reserve of fuel remaining in the tank when the fuel gauge reaches 0 (empty).



Supplemental Restraint System (SRS) air bag warning light (if equipped)

When the ignition switch is in the "ON" position, the Supplemental Restraint System (SRS) air bag warning light illuminates for about 7 seconds and then turns off. This indicates that the SRS air bag system is operational.

If any of the following conditions occur, the SRS air bag system and pre-tensioner seat belt need servicing. Have the system checked, and if necessary repaired, by a NISSAN dealer promptly.

- The SRS air bag warning light remains illuminated after about 7 seconds.
- The SRS air bag warning light flashes intermittently.
- The SRS air bag warning light does not come on at all.

Unless checked and repaired, the SRS air bag system and/or pre-tensioner seat belt may not function properly. (See "Supplemental Restraint System (SRS)" (P.1-22).)

INDICATOR LIGHTS



Front fog light indicator light (if equipped)

The front fog lights indicator light illuminates when the front fog lights are "ON". (See "Fog light switch" (P.2-14).)



High beam indicator light

The high beam indicator light illuminates when the headlight high beam is "ON". The indicator turns off when the low beam is selected. (See "Headlight and turn signal switch" (P.2-13).)



Malfunction Indicator Light (MIL)



CAUTION:

- **Continuing vehicle operation without proper servicing of the engine control system and/or Continuously Variable Transmission (CVT) system (if equipped) could lead to poor driveability, reduced fuel economy, and damage to the engine control system and/or CVT system (if equipped), which may affect the vehicle's warranty coverage.**
- **Incorrect setting of the engine control system may lead to non-compliance of local and national emission laws and regulations.**

When the ignition switch is in the "ON" position, the Malfunction Indicator Light (MIL) illuminates. After starting the engine, the MIL turns off. This indicates that the engine control system and/or CVT system is operational.

For Thailand:

If the MIL illuminates while the engine is running, it may indicate that the engine control system is not functioning properly and may need servicing. Have the vehicle checked, and if necessary repaired, by a NISSAN dealer promptly.

If the MIL blinks while the engine is running, it may indicate a potential malfunction in the emission control system. In this case, the emission control system may not function properly and may need servicing. Have the system checked, and if necessary repaired, by a NISSAN dealer promptly.

Precautions:

To reduce or avoid possible damage to the engine control system when the MIL blinks:

- Avoid driving at speeds above 70 km/h (43 MPH).
- Avoid sudden acceleration or deceleration.
- Avoid going up steep uphill grades.
- Avoid carrying or towing unnecessary loads.

Except for Thailand:

If the MIL illuminates while the engine is running, it may indicate that the engine control system is not functioning properly and may need servicing. Have the vehicle checked, and if necessary repaired, by a NISSAN dealer promptly.



Overdrive off indicator light (if equipped)

The overdrive off indicator light illuminates when the overdrive is turned "OFF". (See "Driving with Automatic Transmission (AT)" (P.5-7) for the use of the overdrive off switch.)

Small light indicator light

The small light indicator light illuminates when the front clearance lights, instrument panel lights, rear combination lights and license plate lights are on. The indicator light turns off when the  is turned off.

Sport mode indicator light (if equipped)

The SPORT mode indicator light illuminates when the SPORT mode is turned "ON". (See "Driving with Continuously Variable Transmission (CVT)" (P.5-10) for the use of the SPORT mode switch.)

Security indicator light (if equipped)

The security indicator light blinks when the ignition switch is in the "LOCK", "OFF" or "ACC" position. This function indicates the security system equipped on the vehicle is operational.

If the security system is malfunctioning, this light will remain on while the ignition switch is in the "ON" position. (See "Security system" (P.3-13) for additional information.)

Turn signal/hazard indicator lights

The turn signals/hazard indicator lights blink when the turn signal switch lever or hazard indicator flasher switch is "ON". (See "Headlight and turn signal switch" (P.2-13) or "Hazard indicator flasher switch" (P.6-2).)

AUDIBLE REMINDERS

Brake pad wear warning

The disc brake pads have audible wear warnings. When a brake pad requires replacement, it will make a high pitched scraping sound when the vehicle is in motion. This scraping sound will first occur only when the brake pedal is depressed. After more wear of the brake pad, the sound will always be heard even if the brake pedal is not depressed. Have the brakes checked as soon as possible if the wear warning sound is heard.

Have the system checked, and if necessary repaired, by a NISSAN dealer promptly. (See "Brakes" (P.8-11).)

Intelligent Key buzzer (if equipped)

The Intelligent Key buzzer sounds if any one of the following improper operations is found.

- The ignition switch is not returned to the "LOCK" position when locking the doors.
- The Intelligent Key is left inside the vehicle when locking the doors.
- The Intelligent Key is taken outside the vehicle when operating the vehicle.
- Any doors are not closed securely when locking the doors.



When the buzzer sounds, be sure to check both the vehicle and the Intelligent Key. (See "Intelligent Key system" (P.3-6).)

Key reminder chime

The chime will sound if the driver's door is opened while the key is left in the ignition switch and the ignition switch is in the "ACC", "OFF" or "LOCK" position.

Be sure to remove the key and carry it with you when you leave the vehicle.

Light reminder chime

The chime will sound if the driver's door is opened while the headlight switch is in either the  or  position and the ignition switch is in the "ACC", "OFF" or "LOCK" position.

Be sure to turn the light switch to the "OFF" position when you leave the vehicle.

Parking brake reminder chime

The chime will sound if the vehicle is driven at more than 7 km/h (4 MPH) with the parking brake applied. Stop the vehicle and release the parking brake.

HEADLIGHT AND TURN SIGNAL SWITCH

HEADLIGHT SWITCH

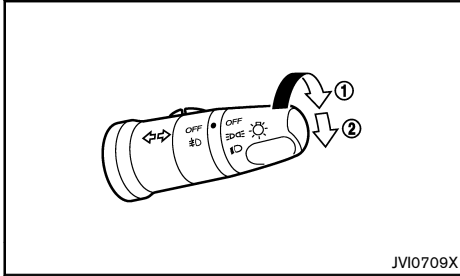

NISSAN recommends that you consult the local regulations concerning the use of lights.

☞☞ position

The ☞☞ position ① turns on the front clearance lights, instrument panel lights, rear combination lights and license plate lights.

☞☉ position

The ☞☉ position ② turns on the headlights in addition to the other lights.

Headlight beam

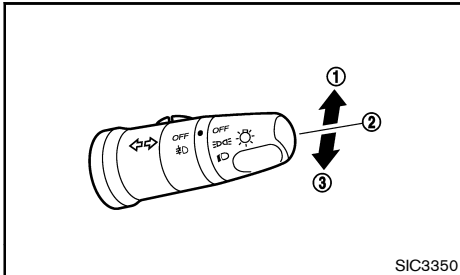

To turn on the high beam, push the lever towards the front position ①.

To turn off the high beam, return the lever to the neutral position ②.

To flash the headlights, pull the lever towards the rearmost position ③. The headlights can be flashed even when the headlights are not on.

Battery saver system (if equipped)

The light reminder chime will sound if the driver's door is opened while the headlight switch is in either the ☞☞ or ☞☉ position and the ignition switch is in the "ACC", "OFF" or "LOCK" position.

If the ignition switch is turned to the "OFF" or "LOCK" position while the headlight switch is in the ☞☞ or ☞☉ position, the battery saver function will turn off the lights after 5 minutes to prevent the battery from being discharged.



CAUTION:

Do not leave the lights on when the engine is not running for extended periods of time to prevent the battery from being discharged.

TURN SIGNAL SWITCH

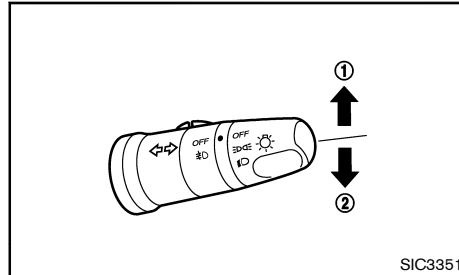

CAUTION:

The turn signal switch will not be cancelled automatically if the steering wheel turning angle does not exceed the preset amount. After the turn or lane change, make sure that the turn signal switch is returned to its original position.

Turn signal

To turn on the turn signals, move the lever up ① or down ② towards the desired direction. When the turn is completed, the turn signal cancels automatically.

Lane change signal

To turn on the lane change signals, move the lever up ① or down ② towards the desired direction.

To cancel the flashing, move the lever to the opposite direction.

FOG LIGHT SWITCH (if equipped)

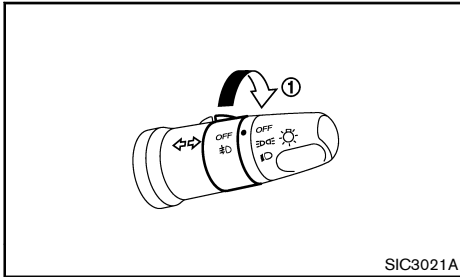

FRONT FOG LIGHTS

To turn on the fog lights, turn the headlight switch to the ⊞ or ⊞ position, then turn the fog light switch to the ⊞ position ①.

To turn off the fog lights, turn the fog light switch to the "OFF" position.

When the headlight switch is turned to the "OFF" position, the front fog lights will automatically turn off.

WIPER AND WASHER SWITCH

⚠ WARNING:

In freezing temperatures, the washer fluid may freeze on the windshield and obscure your vision. Warm the windshield with the defogger before you wash the windshield.

⚠ CAUTION:

- Do not operate the washer continuously for longer than 30 seconds.
- Do not operate the washer if the window washer fluid reservoir is empty.
- If the wiper operation is interrupted by snow or ice, the wiper may stop moving to protect its motor. If this occurs, turn the wiper switch to the "OFF" position and remove the snow or ice on and around the wiper arms. In approximately 1 minute, turn the switch on again to operate the wiper.

WINDSHIELD WIPER AND WASHER SWITCH

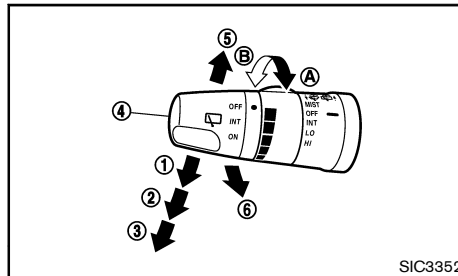

The windshield wiper and washer operate when the ignition switch is in the "ON" position.

Wiper operation

The lever position "INT" ① operates the wiper intermittently. The intermittent operation can be adjusted by turning the adjustment control knob, (longer) ④ or (shorter) ⑤. The speed of the intermittent operation varies depending on the vehicle speed.

The lever position "LO" ② operates the wiper at low speed.

The lever position "HI" ③ operates the wiper at high speed.

To stop the wiper operation, move the lever up to the "OFF" ④ position.

The lever position "MIST" ⑤ operates the wiper one sweep. The lever automatically returns to its original position.

Washer operation

To operate the washer, pull the lever toward the back of the vehicle ⑥ until the desired amount of washer fluid is spread on the windshield. The wiper will automatically operate several times.

REAR WINDOW WIPER AND WASHER SWITCH

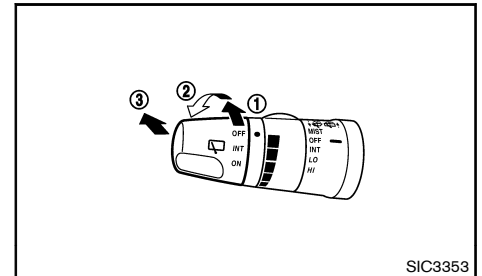

DEFOGGER SWITCH (if equipped)

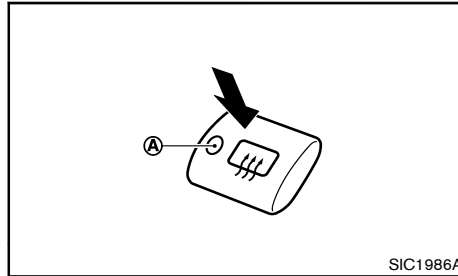

The rear window defogger switch operates when the ignition switch is in the "ON" position.

The defogger is used to reduce the moisture, fog or frost on the rear window surface to improve the side view.

When the defogger switch is pushed, the indicator light (A) illuminates and the defogger operates for approximately 15 minutes. After the preset time has passed, the defogger will turn off automatically.

To turn off the defogger manually, push the defogger switch again, and the indicator light turns off.



CAUTION:

- **When operating the defogger continuously, be sure to start the engine. Otherwise, it may cause the battery to discharge.**
- **When cleaning the inner side of the window, be careful not to scratch or damage the electrical conductors on the surface of the window.**

HORN

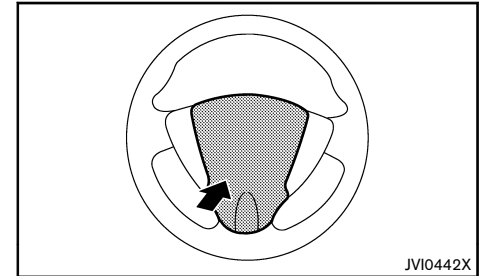

The horn switch operates with the ignition switch in any position except when the battery is discharged.

When the horn switch is pushed and held, the horn will sound. Releasing the horn switch will cease the horn sound.

The rear window wiper and washer operates when the ignition switch is in the "ON" position.

Wiper operation

The lever position "INT" ① operates the wiper intermittently.

The lever position "ON" ② operates the wiper continuously.

To stop the wiper operation, turn the lever to the "OFF" position.

Washer operation

To operate the washer, push the lever toward the front of the vehicle ③ until the desired amount of washer fluid is spread on the rear window. The wiper will automatically operate several times.

WINDOWS

POWER WINDOWS



WARNING:

- **Make sure that all passengers have their hands, etc. inside the vehicle before operating the power windows.**
- **Never leave children or adults who would normally require the support of others alone in the vehicle. They could unknowingly activate switches or controls and inadvertently become involved in an accident.**

The power windows operate when the ignition switch is in the "ON" position.

To open a window, push down the power window switch.

To close a window, pull up the power window switch.

Driver's window switch

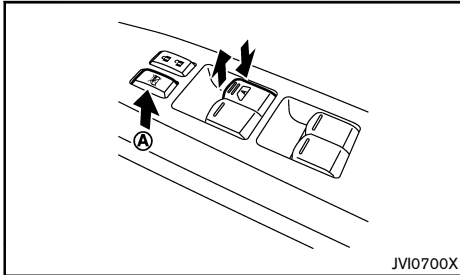

The driver's switch, which is the main switch, can control all windows.

Locking passengers' windows:

When the lock button (A) is pushed in, the passengers' window cannot be operated.

To cancel the passengers' window lock, push the lock button (A) again.

Passenger's window switch

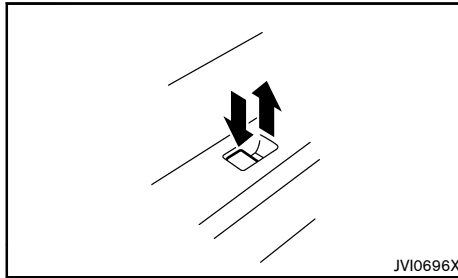

The passenger's switch can control its corresponding window.

When the passengers' window lock button on the driver's switch is pushed in, the passenger's switch cannot be operated.

Automatic function

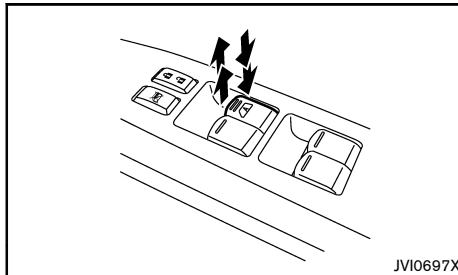

Automatic function is available for the switch that has an (A) mark on its surface.

The automatic function enables a window to fully open or close without holding the switch down or up.

To fully open the window, push the power window switch down to the second detent and release the switch. To fully close the window, pull the power window switch up to the second detent and release the switch. The switch does not have to be held during window operation.

To stop the window open/close operation during the automatic function, push down or pull up the switch in opposite directions.

Auto-reverse function:



WARNING:

There is a small distance just before the closed position which cannot be detected. Make sure that all passengers have their hands, etc. inside the vehicle before closing the windows.

The auto-reverse function enables a window to automatically reverse when something is caught in the window as it is closing by the automatic function. When the control unit detects an obstacle, the window will be lowered immediately.

Depending on the environment or driving conditions, the auto-reverse function may activate if an impact or load similar to something being caught in the window occurs.

CLOCK

When power window switch does not operate

Some power window functions (automatic close function, auto-reverse function) will not operate as described after the battery cable is disconnected and the electrical supply is interrupted. Perform the following procedure to initialize the power window functions.

1. Turn the ignition switch to the "ON" position.
2. If the driver's window is closed, open it completely by operating the driver's window switch.
3. Pull up and hold the driver's window switch to close the driver's window. Hold the switch for approximately 3 seconds after the window has been fully closed, and then release it.
4. Check if the power window functions operate properly.

If you open or close the power window continuously, it may cause the power window not to operate properly. Perform the above procedure.

If the power window functions do not operate properly after performing the above procedure, repeat the steps. See a NISSAN dealer, if necessary, for checking the power window system.

If the battery cable is disconnected, the clock will be reset and the correct time will not be indicated. Readjust the time.

ADJUSTING TIME

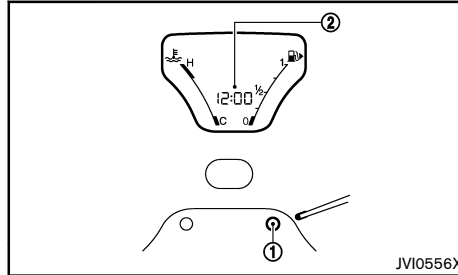

The digital clock (2) in the meter displays the time when the ignition switch is in the "ON" position. To adjust the time, perform the following procedure:

1. If the switch (1) is pushed while the distance to empty is displayed, the clock display will blink.
2. Push the switch (1) for 3 seconds. The hours display will start to flash.
3. Push the switch (1) to adjust the hour. To advance the time, hold down the switch (1).
4. Wait at least 5 seconds for the minute display to flash.
5. Push the switch (1) to adjust the minutes. To advance the time, hold down the switch (1).
6. Wait at least 5 seconds for the second display ":", to flash.
7. Push the switch (1) to reset the second counter.

If switch (1) is not pushed within 1 minute, the time adjusting mode will be over, and the clock display will blink.

ASHTRAYS AND CIGARETTE LIGHTER (if equipped)

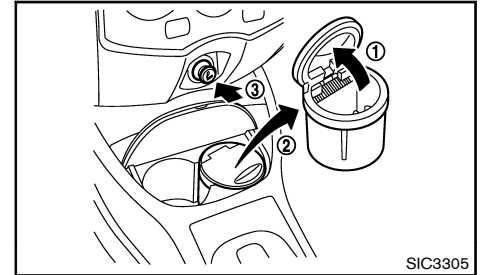

ASHTRAY

To open the ashtray, pull the lid (1).

To take out the ashtray, pull out (2). You can place the ashtray in every cup holder.

CIGARETTE LIGHTER



WARNING:

The cigarette lighter should not be used while driving so that full attention may be given to vehicle operation.



CAUTION:

- **The cigarette lighter socket is a power source for the cigarette lighter element only. The use of the cigarette lighter socket as a power source for any other accessory is not recommended.**
- **Do not use any other power outlet for an accessory lighter.**

The cigarette lighter operates when the ignition switch is in the "ACC" or "ON" position.

To heat the cigarette lighter, push in (3) until it latches.

STORAGES

When the lighter is heated, it will spring out automatically.

Return the cigarette lighter to its original position after use.



WARNING:

- **The storages should not be used while driving so that full attention may be given to vehicle operation.**
- **Keep the storage lids closed while driving to help prevent injury in an accident or a sudden stop.**

GLOVE BOX

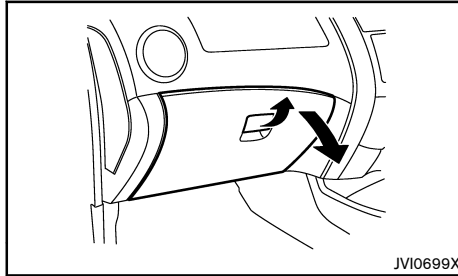

To open the glove box, pull the handle.

To close, push the lid in until the lock latches.

CARD HOLDER (if equipped)

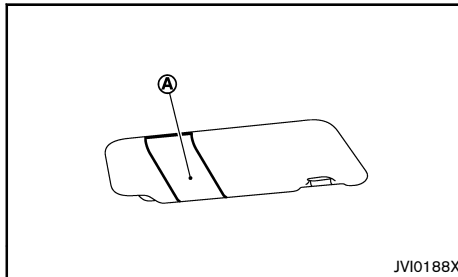

Slide a card in the card holder (A) .

CUP HOLDERS



CAUTION:

Avoid abrupt starting and braking especially when you use the cup holders. Doing so may cause the beverages to spill over, and if they are hot, they may scald you or your passengers.

Front

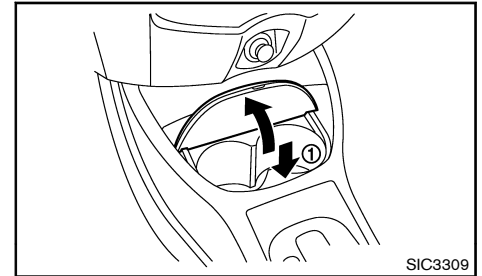

Front

To open the cup holder, push the lid (1) (if equipped).

Rear

Center console (Type A):



To hold two bottles or cans in the center console cup holders, pull up the cup holder inner case ①, turn it around 180 degrees ②, and then attach it as illustrated ③.

Center console (Type B):

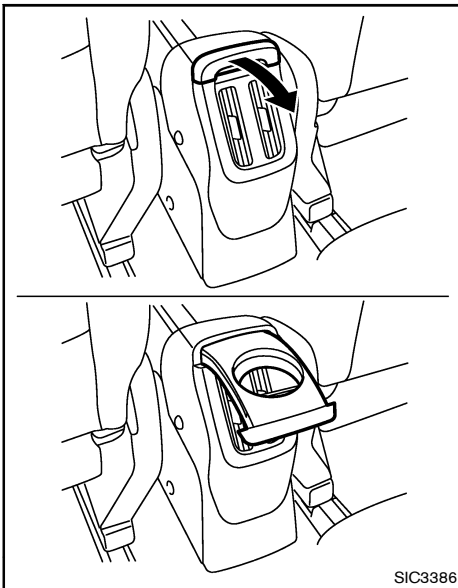

Pull out the cup holder from the center console as illustrated.

Second row seat armrest (if equipped):

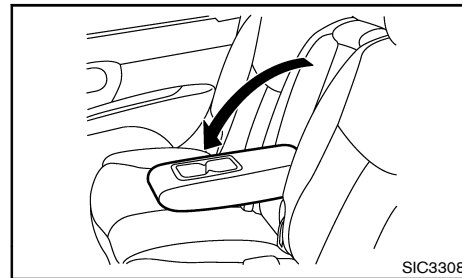

CAUTION:

Do not recline the rear seatback when you use the cup holders on the rear armrest. Doing so may cause the beverages to spill over, and if they are hot, they may scald the passengers.

To open the cup holder, pull the second row seat armrest.

CARGO COVER (if equipped)



WARNING:

- Never put anything on the cargo cover, no matter how small. Any object on it could cause an injury in an accident or sudden stop.
- Never allow children to ride on the cargo cover. Doing so may cause the cargo cover to be disengaged from the holder and cause an injury to a child.
- Do not leave the cargo cover in the vehicle with it disengaged from the holder.

The cargo cover keeps the luggage compartment

contents hidden from the outside.

Do not attach the hook and loop fastener to the rear seatback except the part of fastener.

Only attach the hook and loop fastener to the area where they are supposed to be attached. Otherwise, the seat surface could be damaged.

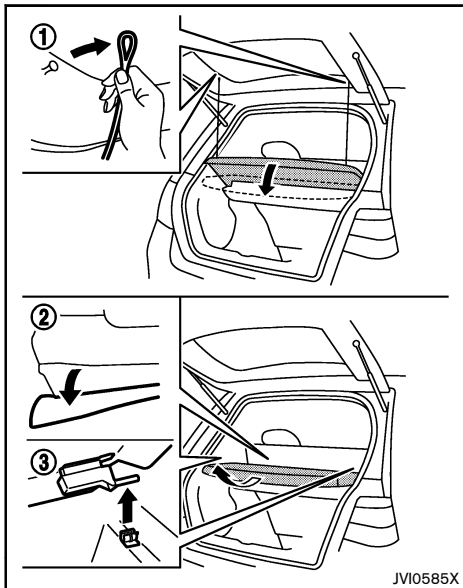

To remove the cargo cover:

1. Remove the straps (1) from the back door.
2. Remove the edge of the cargo cover (2) from the rear seatback.

3. Remove the cargo cover holders (3).

LUGGAGE AREA FLOOR BOX (if equipped)

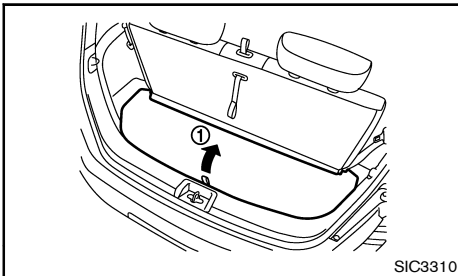

To open the luggage area floor box, pull up (1).



CAUTION:

Make sure that the luggage area floor box is closed when folding the third row seat or while driving.

LUGGAGE HOOKS (if equipped)

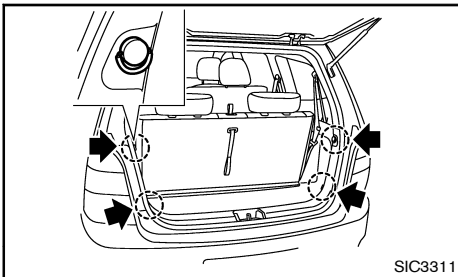

The hooks are located in the luggage room.



CAUTION:

Do not apply a total load of more than 3 kg (7 lb) to a single hook.

ROOF RAIL (if equipped)

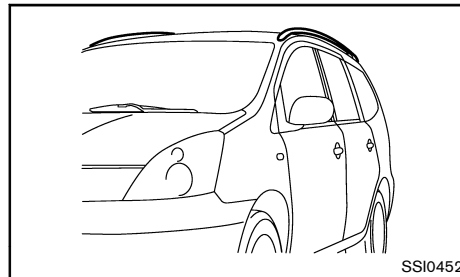

Always distribute the luggage evenly on the roof rack. Do not load more than 50 kg (110 lb) on the roof rails. Observe the maximum load limit shown on the crossbars or roof carries when you attach them on the roof rails. Contact a NISSAN dealer for crossbar or other equipment information.



WARNING:

- Drive extra carefully when the vehicle is loaded at or near the cargo carrying capacity, especially if the significant portion of that load is carried on the roof rack.
- Heavy loading of the roof rack has the potential to affect the vehicle stability and handling during sudden or unusual handling maneuvers.
- Roof rack load should be evenly distributed.

SUN VISORS

- Do not exceed maximum roof rack load weight capacity.
- Properly secure all cargo with ropes or straps to help prevent it from sliding or shifting. In a sudden stop or collision, unsecured cargo could cause personal injury.



CAUTION:

Use care when placing or removing items from the roof rack. If you cannot comfortably lift the items onto the roof rack from the ground, use a ladder or stool.

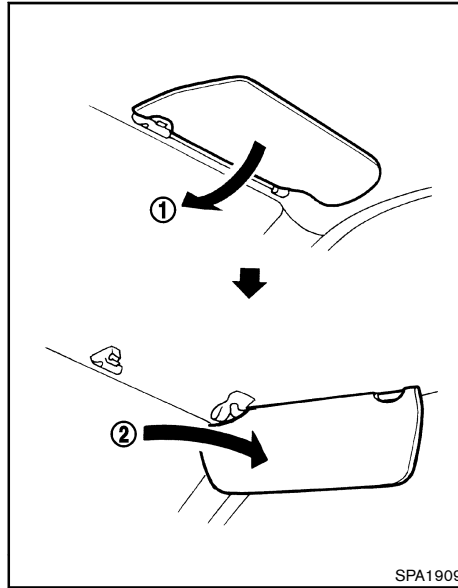

1. To block out glare from the front, swing down the sun visor ①.
2. To block glare from the side, remove the sun visor from the center mount and swing it to the side ②.

INTERIOR LIGHTS



CAUTION:

- Do not leave the light switch on when the engine is not running for extended periods of time to prevent the battery from being discharged.
- Turn off the lights when you leave the vehicle.

ROOM LIGHT

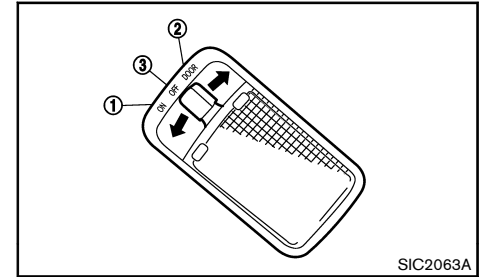

The room light has a three-position switch.

ON position

When the switch is in the "ON" position ①, the room light illuminates.

DOOR position

When the switch is in the "DOOR" position ②, the room light illuminates when a door is opened.

The interior light timer will keep the room light on for approximately 15 seconds when:

- The key is removed from the ignition switch with the driver's door closed.

- The ignition switch is turned to the “LOCK” position. (Intelligent Key system equipped model)
- The driver’s door is unlocked without the key in the ignition switch.
- Any door is opened and then closed without the key in the ignition switch.

The interior light timer will be cancelled when:

- The driver’s door is locked.
- The ignition switch is turned to the “ON” position.

OFF position

When the switch is in the “OFF” position ③, the room light does not illuminate, regardless of any condition.

BATTERY SAVER SYSTEM

When the interior light stays on, it will automatically turn off 30 minutes after the ignition switch has been turned to the “OFF” position. To turn on the light again, turn the ignition switch to the “ON” position.

LUGGAGE ROOM LIGHT (if equipped)

The light illuminates when the back door is opened. When the back door is closed, the light will turn off.

3 Pre-driving checks and adjustments

Keys	3-2	Security system (if equipped)	3-13
Key	3-2	Theft warning system	3-13
Intelligent Key (if equipped)	3-2	NISSAN Anti-Theft System (NATS)	3-13
Locking with key	3-3	Hood	3-14
Door locks	3-4	Opening hood	3-15
Locking with inside lock knob	3-4	Closing hood	3-15
Locking with power door lock switch	3-4	Back door	3-15
Vehicle speed sensing door lock mechanism (if equipped)	3-4	Opening back door	3-16
Auto door lock releasing mechanism	3-4	Closing back door	3-16
Impact sensing door lock releasing mechanism (if equipped)	3-5	Fuel filler lid	3-16
Child safety rear door lock	3-5	Opening fuel filler lid	3-16
Remote keyless entry system (if equipped)	3-5	Fuel filler cap	3-17
Using remote keyless entry system	3-5	Steering wheel	3-17
Intelligent Key system (if equipped)	3-6	Mirrors	3-17
Operating range	3-8	Inside rearview mirror	3-17
Using Intelligent Key system	3-8	Outside rearview mirrors	3-18
Using remote keyless entry function	3-10	Vanity mirrors (if equipped)	3-18
Warning lights and audible reminders	3-10	Parking brake	3-19
		Lever type	3-19

KEYS

Your vehicle can only be driven with the keys specific to your vehicle. A key number plate is supplied with your key. Record the key number and keep the key number plate in a safe place, except in the vehicle, in case of the need to duplicate the keys.

The key can only be duplicated using an original key or the original key number. The key number is required when you have lost all of the keys and do not have the original key to duplicate from. If the key is lost, or you need extra keys, provide an original key or the key number to a NISSAN dealer.



CAUTION:

Do not leave the keys inside the vehicle when leaving the vehicle.

KEY

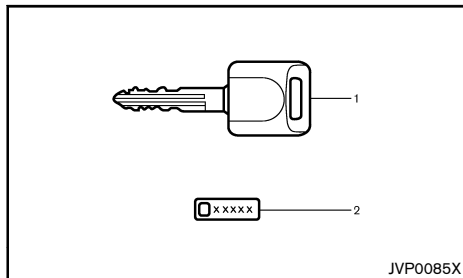

Your vehicle is equipped with the following set of keys:

- 1 Mechanical key (Molded) × 2
- 2 Key number plate × 1

INTELLIGENT KEY (if equipped)

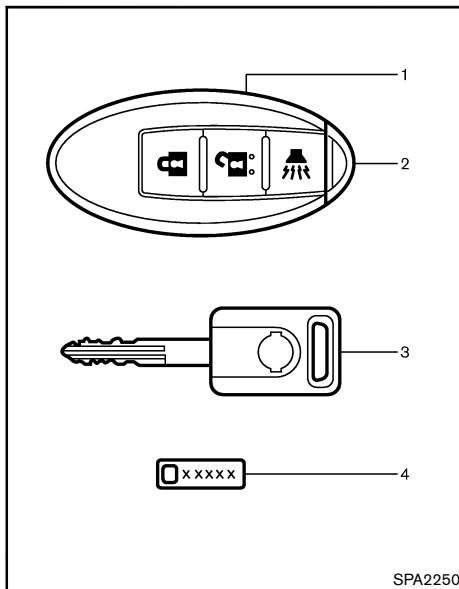

Your vehicle is equipped with the following set of keys:

- 1 Intelligent Key
- 2 Mechanical key (in the Intelligent Key)
- 3 NATS key
- 4 Key number plate

Your vehicle can only be driven with the Intelligent Keys, which are registered to your vehicle's Intelligent Key system components and NISSAN Anti-Theft System (NATS*) components. As many as 4 Intelligent Keys can be registered and used with one vehicle. The new keys must be registered by a NISSAN dealer prior

to use with the Intelligent Key system and NATS of your vehicle. Since the registration process requires erasing all memory in the Intelligent Key components when registering new keys, be sure to take all Intelligent Keys that you have to the NISSAN dealer.

* Immobilizer



CAUTION:

- **Be sure to carry the Intelligent Key with you. Do not leave the vehicle with the Intelligent Key inside.**
- **Be sure to carry the Intelligent Key with you when driving. The Intelligent Key is a precision device with a built-in transmitter. To avoid damaging it, please note the following.**
 - The Intelligent Key is water resistant; however, wetting may damage the Intelligent Key. If the Intelligent Key gets wet, immediately wipe until it is completely dry.
 - Do not bend, drop or strike it against another object.
 - If the outside temperature is below -10°C (14°F), the battery of the Intelligent Key may not function properly.
 - Do not place the Intelligent Key for an extended period in a place where temperatures exceed 60°C (140°F).
 - Do not change or modify the Intelligent Key.
 - Do not use a magnet key holder.

- Do not place the Intelligent Key near equipment that produces a magnetic field such as a TV, audio equipment and personal computers.
- Do not allow the Intelligent Key to come into contact with water or salt water, and do not wash it in a washing machine. This could affect the system function.
- If an Intelligent Key is lost or stolen, NISSAN recommends erasing the ID code of that Intelligent Key. This will prevent the Intelligent Key from unauthorized use to unlock the vehicle. For information regarding the erasing procedure, please contact a NISSAN dealer.

(See “Door locks” (P.3-4).)

Mechanical key

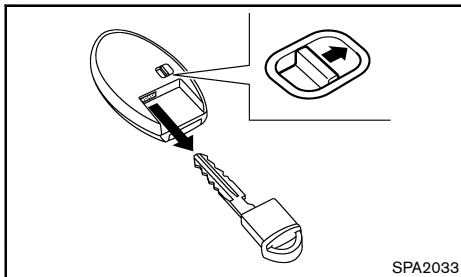

To remove the mechanical key, release the lock knob at the back of the Intelligent Key.

To install the mechanical key, firmly insert it into the Intelligent Key until the lock knob returns to the lock position.

Use the mechanical key to lock or unlock the doors.

LOCKING WITH KEY

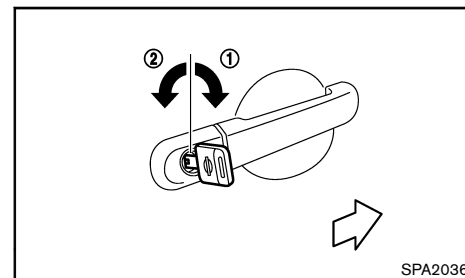

The door key cylinder is located on the driver's side door.

To lock the door, insert the key to the key cylinder and turn the key to the front side of the vehicle ①.

All the doors including the back door will lock.

To unlock the door, turn the key to the rear side of the vehicle ②.

All the doors including the back door will unlock.

DOOR LOCKS

WARNING:

- Always look before opening any doors, to avoid an accident with oncoming traffic.
- Never leave children or adults who would normally require the support of others alone in the vehicle. They could unknowingly activate switches or controls and inadvertently become involved in a serious accident.

LOCKING WITH INSIDE LOCK KNOB

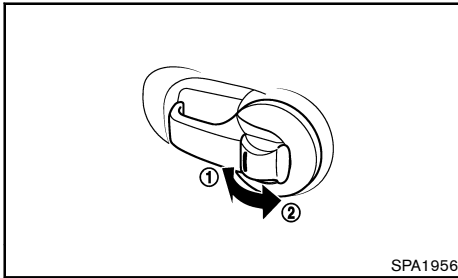

To lock the front door, push the inside lock knob to the lock position ①, and then close the door with the outside door handle pulled.

To lock the rear door, push the inside lock knob to the lock position ①, and then close the door.

CAUTION:

- When locking the doors using the inside lock knob, be sure not to leave the key in the vehicle.
- When the key is in the ignition switch and the driver's door is open, the inside lock

knob will not lock the door(s).

To unlock, pull the inside lock knob to the unlock position ②.

LOCKING WITH POWER DOOR LOCK SWITCH

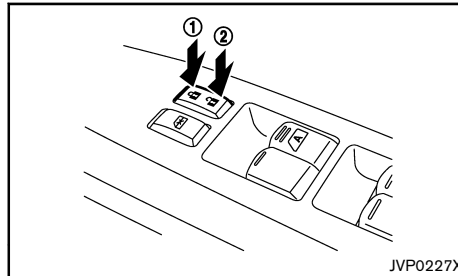

Operating the power door lock switch will lock or unlock all the doors.

To lock all the doors, push the power door lock switch to the lock position ① with all the doors except the driver's door closed, and then close the driver's door with the outside door handle pulled.

CAUTION:

When locking the doors using the power door lock switch, be sure not to leave the key in the vehicle.

To unlock, push the power door lock switch to the unlock position ②.

VEHICLE SPEED SENSING DOOR LOCK MECHANISM (if equipped)

All doors will be locked automatically when the vehicle speed reaches 10 km/h (6 MPH). Once the lock has been unlocked, while driving, the vehicle speed sensing door lock mechanism will not lock the door again unless one of the following is performed.

- Opening any doors.
- Placing the ignition switch in the "LOCK" position.

AUTO DOOR LOCK RELEASING MECHANISM

All doors will be unlocked automatically when the following conditions:

- When the ignition switch is placed from "ON" to "OFF" position (Model with Intelligent Key system).
- When the key is removed from the ignition switch (Model without Intelligent Key system).

To activate or deactivate auto door lock releasing mechanism

To activate or deactivate the auto door lock releasing mechanism, perform the following procedures.

1. Place the ignition switch to the "ON" position.
2. Within 20 seconds, push and hold the power door lock switch to the "UNLOCK" position for 5 seconds.
3. The hazard indicator light will flash as follows if the switching operation is successful:
 - Twice — activated
 - Once — deactivated

IMPACT SENSING DOOR LOCK RELEASE MECHANISM (if equipped)

All doors will be unlocked automatically when the impact sensors sense an impact while the ignition switch is in the "ON" position.

The impact sensing door lock releasing mechanism may not function depending on the force of the impact.

CHILD SAFETY REAR DOOR LOCK

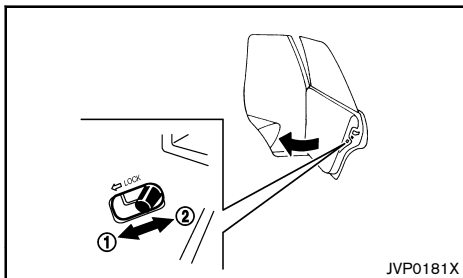

The child safety rear door locks help prevent rear doors from being opened accidentally, especially when small children are in the vehicle.

When the levers are in the lock position ①, the child safety rear door locks engage and the rear doors can only be opened by the outside door handles.

To disengage, move the levers to the unlock position ②.

REMOTE KEYLESS ENTRY SYSTEM (if equipped)

The remote keyless entry system can operate all door locks (including the back door) using the remote controller. It also provides the panic alarm. The remote controller can operate at a distance of approximately 1 m (3.3 ft) away from the vehicle. The operating distance depends upon the conditions around the vehicle.

As many as 5 remote controllers can be used with one vehicle. For information about the purchase and use of additional remote controllers, contact a NISSAN dealer.

The remote controller will not function under the following conditions:

- When the key is in the ignition switch.
- When the distance between the remote controller and vehicle is more than approximately 1 m (3.3 ft).
- When the doors are open. (The unlock function will operate.)
- When the remote controller battery is discharged.



CAUTION:

- **When locking the doors using the remote controller, be sure not to leave the key in the vehicle.**
- **Do not allow the remote controller, which contains electrical components, to come into contact with water or salt water. This could affect the system function.**
- **Do not drop the remote controller.**
- **Do not strike the remote controller sharply against another object.**
- **If the outside temperature is below -10°C (14°F), the battery of the remote controller may not function properly.**

- **Do not place the remote controller for an extended period in an area where temperatures exceed 60°C (140°F).**

If a remote controller is lost or stolen, NISSAN recommends erasing the ID code of that remote controller from the vehicle. This may prevent the unauthorized use of the remote controller to unlock the vehicle. For information regarding the erasing procedure, contact a NISSAN dealer.

For information regarding the replacement of a battery, see "Remote controller battery" (P.8-18).

USING REMOTE KEYLESS ENTRY SYSTEM

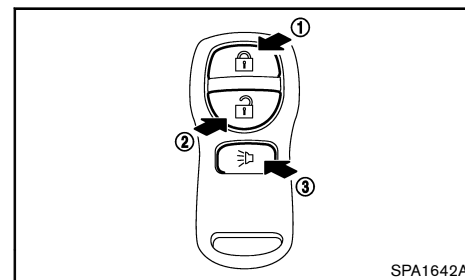

- ① LOCK button
- ② UNLOCK button
- ③ PANIC button

When you lock or unlock the doors, the hazard indicator will flash as a confirmation.

Locking doors

1. Remove the key from the ignition switch.
2. Close all doors.
3. Push the “LOCK”  button on the remote controller.
4. All doors will be locked.
5. Operate door handles to confirm that the doors have been securely locked.





CAUTION:

After locking the doors using the remote controller, be sure that the doors have been securely locked by operating the door handles.

Unlocking doors

1. Push the “UNLOCK”  button on the remote controller.
2. All doors will be unlocked.

All doors will be locked automatically unless one of the following operations is performed within 30 seconds after pushing the “UNLOCK”  button on the remote controller while the doors are locked. If during this 30-second time period, the “UNLOCK”  button on the remote controller is pushed, all doors will be locked automatically after another 30 seconds.

- Opening any doors.
- Inserting the key into the ignition switch.

Using panic alarm

If you are near your vehicle and feel threatened, you may activate the alarm to call attention as follows:

1. Push the “PANIC”  button on the remote controller for **more than 1 second**.
2. The theft warning alarm and headlights (if equipped) will stay on for 25 seconds.
3. The panic alarm stops when:
 - It has run for 25 seconds, or
 - Any of the buttons on the remote controller are pushed. (Note: Panic button should be pushed for more than 1 second.)

Hazard indicator operation

When you lock or unlock the doors, the hazard indicator will flash as a confirmation.

- “LOCK”: The hazard indicator flashes once.
- “UNLOCK”: The hazard indicator flashes twice.

INTELLIGENT KEY SYSTEM (if equipped)

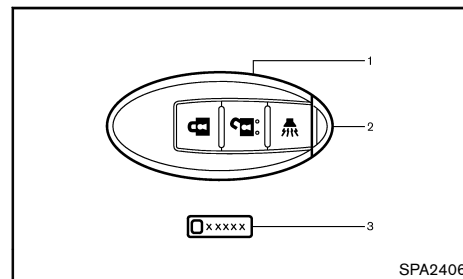

1. Intelligent Key
2. Mechanical key (inside the Intelligent Key)
3. Key number plate



WARNING:

- **Radio waves could adversely affect electric medical equipment. Those who use a pacemaker should contact the electric medical equipment manufacturer for the possible influences before use.**
- **The Intelligent Key transmits radio waves when the buttons are pushed. The radio waves may affect aircraft navigation and communication systems. Do not operate the Intelligent Key while on an airplane. Make sure the buttons are not operated unintentionally when the unit is stored during a flight.**

The Intelligent Key system can operate all the door locks using the remote controller function or pushing the request switch on the vehicle without taking the key out from a pocket or purse. The operating environment and/or conditions may affect the Intelligent Key system operation.

Be sure to read the following before using the Intelligent Key system.



CAUTION:

- **Be sure to carry the Intelligent Key with you when operating the vehicle.**
- **Never leave the Intelligent Key in the vehicle when you leave the vehicle.**
- **When the outside temperature is extremely low, the Intelligent Key system may not function properly.**

The Intelligent Key is always communicating with the vehicle as it receives radio waves. The Intelligent Key system transmits weak radio waves. Environmental conditions may interfere with the operation of the Intelligent Key system under the following operating conditions.

- When operating near a location where strong radio waves are transmitted, such as a TV tower, power station and broadcasting station.
- When in possession of wireless equipment, such as a cellular telephone, transceiver, and CB radio.
- When the Intelligent Key is in contact with or covered by metallic materials.
- When any type of radio wave remote control is used nearby.
- When the Intelligent Key is placed near an electric appliance such as a personal computer.

In such cases, correct the operating conditions before using the Intelligent Key function or use the mechanical key.

Although the life of the battery varies depending on the operating conditions, the battery's life is approximately 2 years. If the battery is discharged, replace it with a new one.

For information regarding replacement of a battery, see "Intelligent Key battery" (P.8-19).

Since the Intelligent Key is continuously receiving radio waves, if the key is left near equipment which transmits strong radio waves, such as signals from a TV and personal computer, the battery life may become shorter.

Because the steering wheel is locked electrically, unlocking the steering wheel with the ignition switch in the "LOCK" position is impossible when the vehicle battery is completely discharged. Pay special attention that the vehicle battery is not completely discharged.

As many as 4 Intelligent Keys can be registered and used with one vehicle. For information about the purchase and use of additional Intelligent Keys, contact a NISSAN dealer.



CAUTION:

- **Do not allow the Intelligent Key, which contains electrical components, to come into contact with water or salt water. This could affect the system function.**
- **Do not drop the Intelligent Key.**
- **Do not strike the Intelligent Key sharply against another object.**
- **Do not change or modify the Intelligent Key.**
- **Wetting may damage the Intelligent Key. If the Intelligent Key gets wet, immediately wipe until it is completely dry.**
- **If the outside temperature is below -10°C (14°F), the battery of the Intelligent Key may not function properly.**
- **Do not place the Intelligent Key for an extended period in an area where temperatures exceed 60°C (140°F).**

- **Do not attach the Intelligent Key with a key holder that contains a magnet.**
- **Do not place the Intelligent Key near equipment that produces a magnetic field, such as a TV, audio equipment and personal computers.**

If an Intelligent Key is lost or stolen, NISSAN recommends erasing the ID code of that Intelligent Key from the vehicle. This may prevent the unauthorized use of the Intelligent Key to operate the vehicle. For information regarding the erasing procedure, contact a NISSAN dealer.

For information regarding replacement of a battery, see "Intelligent Key battery" (P.8-19).

The Intelligent Key function can be disabled. For information about disabling the Intelligent Key function, contact a NISSAN dealer.

OPERATING RANGE

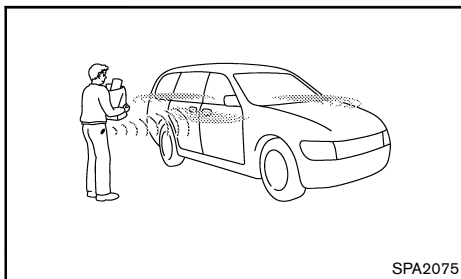
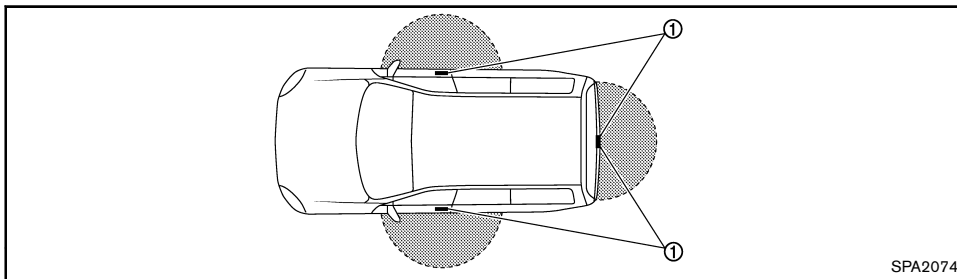

The Intelligent Key functions can only be used when the Intelligent Key is within the specified operating range from the request switch ①.

When the Intelligent Key battery is discharged or strong radio waves are present near the operating location, the Intelligent Key system's operating range becomes narrower, and the Intelligent Key may not function properly.

The operating range is within 80 cm (31.50 in) from each request switch ①.

If the Intelligent Key is too close to the door glass,

handle or rear bumper, the request switches may not function.

When the Intelligent Key is within the operating range, it is possible for anyone, even someone who does not carry the Intelligent Key, to push the request switch to lock/unlock the doors.

USING INTELLIGENT KEY SYSTEM

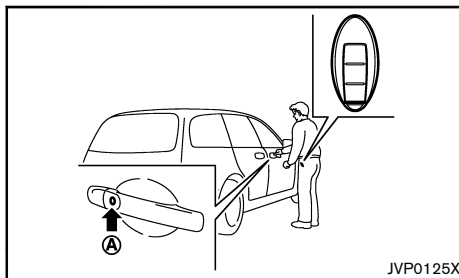

The request switch will not function under the following conditions:

- When the ignition switch is placed in (the "OFF", "ACC" or "ON" position).
- When the mechanical key is in the ignition switch.
- When another Intelligent Key is left inside the vehicle.
- When the Intelligent Key is not within the operational range.
- When the doors are open or not closed securely.
- When the Intelligent Key battery is discharged.

Locking doors

1. Carry the Intelligent Key.
2. Close all doors.
3. Push the door handle request switch (A).
4. The hazard indicator light flashes once and the outside buzzer sounds once.
5. All doors and the back door will be locked.
6. Operate door handles to confirm that the doors have been securely locked.



CAUTION:

- **After locking the doors using the request switch, make sure that the doors have been securely locked by operating the door handles.**
- **When locking the doors using the request switch, make sure to have the Intelligent Key in your possession before operating the request switch to prevent the Intelligent Key from being left in the vehicle.**
- **The door handle request switch is operational only when the Intelligent Key has been detected by the Intelligent Key system.**

Lockout protection:

To prevent the Intelligent Key from being accidentally locked in the vehicle, lockout protection is equipped with the Intelligent Key system.

When the driver's side door is open and the Intelligent Key is inside the vehicle, the doors cannot be locked using the inside lock knob or power door lock switch.

When a person carrying another Intelligent Key, which has been registered to the Intelligent Key system, enters the vehicle, the lockout protection will be activated and the lock function will not operate. To lock, use the remote keyless entry function or the mechanical key.



CAUTION:

- **The lockout protection may not function under the following conditions:**
 - When the Intelligent Key is placed on top of the instrument panel.
 - When the Intelligent Key is placed inside the glove box.
 - When the Intelligent Key is placed inside the door pockets.
 - When the Intelligent Key is placed on or under the spare tire area.
 - When the Intelligent Key is placed inside or near metallic materials.
- **The lockout protection may function when the Intelligent Key is outside the vehicle but is too close to the vehicle.**

Unlocking doors

1. Carry the Intelligent Key.
2. Push the door handle request switch **(A)**.
3. The hazard indicator light flashes twice and the outside buzzer sounds twice.
4. All doors and the back door will be unlocked.

If a door handle is pulled while unlocking the doors, that door may not be unlocked. Returning the door handle to its original position will unlock the door. If the door does not unlock, after returning the door handle, push the door handle request switch to unlock the door.

All doors will be locked automatically unless one of the following operations is performed within 30 seconds after pushing the request switch while the doors are locked. If during this 30-second time period, the "UNLOCK"  button on the Intelligent Key is pushed, all doors will be locked automatically after another 30 seconds.

- Opening any doors.
- Pushing in the ignition switch.
- Inserting the mechanical key into the ignition switch.

Opening back door

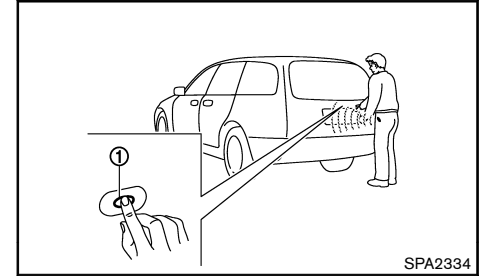

SPA2334

1. Carry the Intelligent Key.
2. Push the back door request switch **(1)**.
3. The hazard indicator light flashes twice and the outside buzzer sounds twice.
4. The back door will be unlocked.
5. Pull the back door handle to open it.

Closing back door

To close the back door, pull down the back door and then push it down securely.

To lock the back door, push the back door request switch **(1)**.

USING REMOTE KEYLESS ENTRY FUNCTION

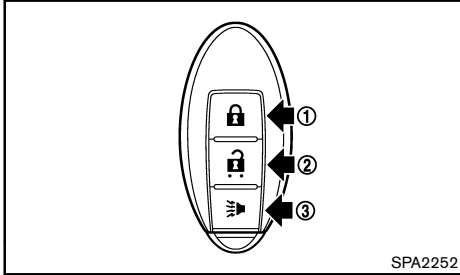

- ① LOCK button
- ② UNLOCK button
- ③ PANIC button

The remote keyless entry function can operate all door locks using the remote keyless function of the Intelligent Key. It also provides the panic alarm. The remote keyless function can operate at a distance of 1 m (3.3 ft) away from the vehicle. The operating distance depends upon the conditions around the vehicle.

The remote keyless entry function will not function under the following conditions:

- When the ignition switch is placed in (the “OFF”, “ACC” or “ON” position).
- When the mechanical key is in the ignition switch.
- When the Intelligent Key is not within the operational range.
- When the doors are open or not closed securely. (The door unlock function will operate.)
- When the Intelligent Key battery is discharged.

CAUTION:

When locking the doors using the Intelligent Key, be sure not to leave the key in the vehicle.

Locking doors

1. Turn the ignition switch to the “LOCK” position.
2. Close all doors.
3. Push the “LOCK” button on the Intelligent Key.
4. The hazard indicator light flashes once and the outside buzzer sounds once.
5. All doors and the back door will be locked.
6. Operate the door handles to confirm that the doors have been securely locked.

CAUTION:

After locking the doors using the Intelligent Key, be sure that the doors have been securely locked by operating the door handles.

Unlocking doors

1. Push the “UNLOCK” button on the Intelligent Key.
2. The hazard indicator light flashes twice and the outside buzzer sounds twice.
3. All doors and the back door will be unlocked.

All doors will be locked automatically unless one of the following operations is performed within 30 seconds after pushing the request switch while the doors are locked. If during this 30-second time period, the “UNLOCK” button on the Intelligent Key is pushed, all doors will be locked automatically after another 30 seconds.

- Opening any doors.
- Pushing in the ignition switch.
- Inserting the mechanical key into the ignition switch.

Using panic alarm

If you are near your vehicle and feel threatened, you may activate the alarm to call attention as follows:

1. Push the “PANIC” button on the Intelligent Key for **more than 0.5 second**.
2. The theft warning alarm and headlights (if equipped) will stay on for 25 seconds.
3. The panic alarm stops when:
 - It has run for 25 seconds,
 - Any of the buttons on the Intelligent Key is pushed, or
 - Any of the request switches on the vehicle is pushed while carrying the Intelligent Key.

WARNING LIGHTS AND AUDIBLE REMINDERS

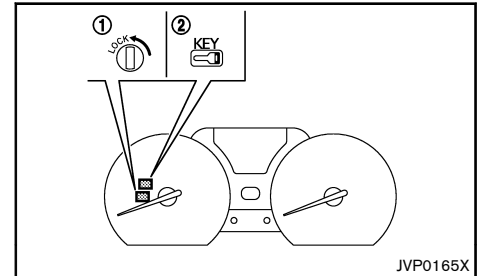

- ① Intelligent Key lock warning light
- ② Intelligent Key system warning light

The Intelligent Key system is equipped with a function

that is designed to minimize improper operations and to help prevent the vehicle from being stolen. The warning buzzer sounds and the warning light illuminates when improper operations are detected.



CAUTION:

When the buzzer sounds and the warning light illuminates, be sure to check both the vehicle and the Intelligent Key.

Troubleshooting guide

Warnings	What to check	What to do
The outside buzzer sounds short continuous beeps when operating the request switch.	Has the Intelligent Key been left inside the vehicle?	Take the Intelligent Key from inside the vehicle and securely close all the doors. Push the request switch while holding the Intelligent Key.
	Has the ignition switch returned to the "LOCK" position?	Return the ignition switch to the "LOCK" position and securely close all the doors. Push the door handle request switch while holding the Intelligent Key.
	Have all the doors closed securely?	Close all the doors securely. Push the request switch while holding the Intelligent Key.
	Are the doors closed completely before pushing the request switch?	Close all the doors completely first. Push the request switch while holding the Intelligent Key.
The outside buzzer sounds short continuous beeps and the Intelligent Key lock warning light blinks in red when closing the driver's door.	Has the ignition switch returned to the "LOCK" position?	Return the ignition switch to the "LOCK" position and securely close all the doors.
The outside buzzer sounds short continuous beeps and the Intelligent Key system warning light blinks in red when closing any door.	Has the Intelligent Key been brought outside the vehicle?	Check the location of the Intelligent Key. The Intelligent Key must be carried by the driver when operating the vehicle.
The inside buzzer sounds two short beeps and the Intelligent Key lock warning light blinks in red.	Has the shift lever returned to the "P" (Park) position? (Automatic Transmission and Continuously Variable Transmission models)	Return the shift lever to the "P" (Park) position. (Automatic Transmission and Continuously Variable Transmission models)
	Has the ignition switch returned to the "LOCK" position?	Return the ignition switch to the "LOCK" position.

Warnings	What to check	What to do
The inside buzzer sounds four short beeps when opening the driver's door.	Has the ignition switch returned to the "LOCK" position?	Return the ignition switch to the "LOCK" position.
	Is the mechanical key inserted into the ignition switch?	Remove the mechanical key from the ignition switch.
The Intelligent Key system warning light blinks in green.	Is the Intelligent Key battery good?	Replace the Intelligent Key battery with a new one. (See "Intelligent Key battery" (P.8-19).)
The Intelligent Key system warning light illuminates in red when pushing the ignition switch.	Are you carrying the Intelligent Key?	Carry the Intelligent Key. If the warning light stays on in red, replace the Intelligent Key battery with a new one. (See "Intelligent Key battery" (P.8-19).)

SECURITY SYSTEM (if equipped)

Your vehicle is equipped with either or both of the following security systems:

- Theft warning system
- NISSAN Anti-Theft System (NATS)

The security condition will be shown by the security indicator light.

THEFT WARNING SYSTEM

The theft warning system provides visual and audio alarm signals if parts of the vehicle are disturbed.

Security indicator light

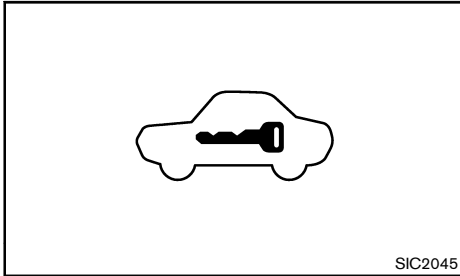

This security indicator light operates whenever the ignition switch is in the "LOCK", "OFF" or "ACC" position. This is normal.

How to activate the system

1. Turn the ignition switch to the "LOCK" position and close all windows.

The system can be activated even if the windows are open.

2. Carry the remote controller with you and get out of the vehicle.

3. Make sure the hood is closed. Close and lock all doors with the remote controller, power door lock switch or mechanical key. (If the door is locked using the inside lock knob, the system will not be activated.)
4. Confirm that the security indicator light comes on. The security indicator light glows for about 30 seconds and then blinks. The system is now activated.

If, during this 30-second time period, the door is unlocked or the ignition switch is turned to the "ACC" or "ON" position, the system will not activate.

Even when the driver and/or passengers are in the vehicle, the system will activate with all doors locked and ignition switch in the "LOCK" position. Turn the ignition switch to the "ACC" or "ON" position to turn the system off.

Theft warning system operation

The warning system will give the following alarm:

- The headlights blink and the horn sounds intermittently.
- The alarm automatically turns off after approximately 50 seconds. However, the alarm reactivates if the vehicle is tampered with again.

The alarm is activated by:

- Opening the door without using the remote controller or mechanical key.
- Opening the hood.

How to stop alarm

- The alarm will stop only by unlocking a door with the UNLOCK  button on the remote controller.
- The alarm will stop when the ignition switch is turned to the "ACC" or "ON" position.

If the system does not operate as described above, have it checked by a NISSAN dealer.

NISSAN ANTI-THEFT SYSTEM (NATS)

The NISSAN Anti-Theft System (NATS) will not allow the engine to start without the use of the registered NATS key.

If the engine does not start using the registered NATS key, it may be due to interference caused by:

- Another NATS key.
- Automated toll road device.
- Automated payment device.
- Other devices that transmit similar signals.

Start the engine using the following procedure:

1. Remove any items that may be causing the interference away from the NATS key.
2. Leave the ignition switch in the "ON" position for approximately 5 seconds.
3. Turn the ignition switch to the "OFF" or "LOCK" position, and wait approximately 10 seconds.
4. Repeat steps 2 and 3 again.
5. Start the engine.
6. Repeat the steps above until all possible interferences are eliminated.

If this procedure allows the engine to start, NISSAN recommends placing the registered NATS key separate from other devices to avoid interference.

HOOD

Security indicator light

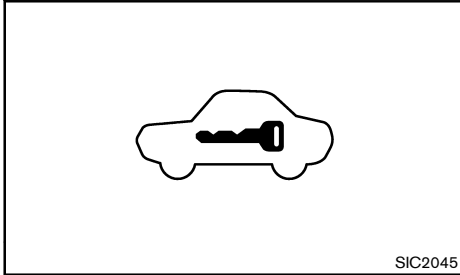

The security indicator light is located on the meter panel. It indicates the status of NATS.

The light blinks when the ignition switch is in the "LOCK" position.

The security indicator light indicates that the security systems on the vehicle are operational.

If NATS is malfunctioning, this light will remain on while the ignition switch is in the "ON" position.

If the light remains on and/or the engine does not start, contact a NISSAN dealer for NATS service as soon as possible. Be sure to bring all NATS keys that you have when visiting a NISSAN dealer for service.



WARNING:

- **The hood must be closed and latched securely before driving. Failure to do so could cause the hood to fly open and result in an accident.**
- **Never open the hood if steam or smoke is coming from the engine compartment to avoid injury.**

OPENING HOOD

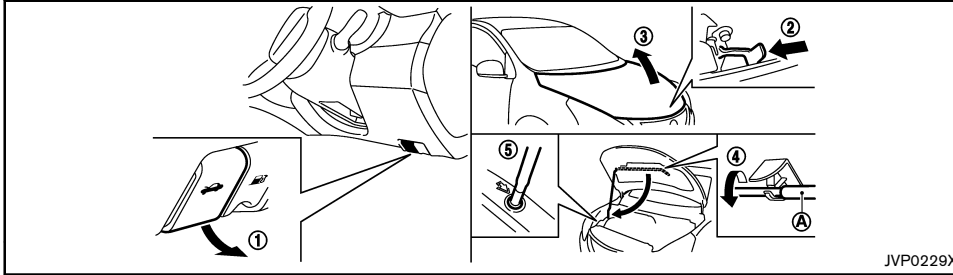

1. Pull the hood lock release handle ① located below the instrument panel until the hood springs up.
2. Locate the lever ② in between the hood and grille and push the lever sideways with your fingertip.
3. Raise the hood ③.
4. Remove the support rod ④ and insert it into the slot ⑤.

Hold the coated parts (A) when removing or resetting the support rod. Avoid direct contact with the metal parts, as they may be hot immediately after the engine has been stopped.

CLOSING HOOD

1. While supporting the hood, return the support rod to its original position.
2. Slowly lower the hood to about 20 to 30 cm (8 to 12 in) above the hood lock, then let it drop.
3. Make sure it is securely latched.

BACK DOOR



WARNING:

- Make sure the back door has been closed securely to prevent it from opening while driving.
- Do not drive with the back door open. This could allow dangerous exhaust gases to be drawn into the vehicle.



CAUTION:

- Before opening the back door, be sure to clear away snow, ice or dust that may be stuck to the back door. If the back door is opened while materials are still stuck to it, it may suddenly close again due to the weight of these materials.
- Always be sure to fully open the back door. If it is not fully opened, it may suddenly shut.
- Be especially careful when opening the back door in strong wind. The door could be caught by a gust of wind and may close suddenly.

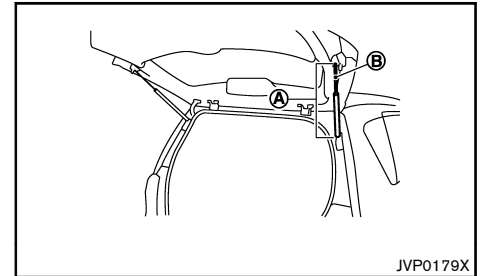

⚠ CAUTION:

- The back door gas stays **(A)** are installed in order to support the weight of the back door. In order to prevent the gas stays being damaged or not operating properly, be sure to observe the following points.
 - Do not insert hands or cords into the gas stays **(A)** or apply any force to them laterally.
 - Do not attach any adhesive foreign materials such as pieces of plastic or stickers to the rod **(B)** portion.
- Do not close the back door while holding the gas stays or hang anything on them. Doing so may lead to hands or arms becoming trapped in the back door and could result in an injury.

OPENING BACK DOOR

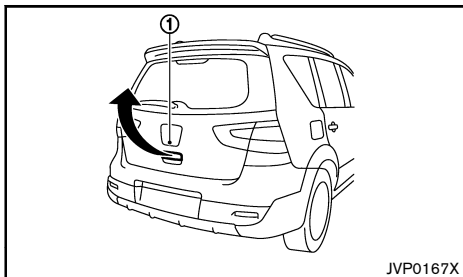

To open the back door, unlock it with one of the following operations, then pull the back door handle.

- Push the back door request switch **(1)** (if equipped). (See “Intelligent Key system” (P.3-6).)
- Push the “UNLOCK” button on the Intelligent Key (if equipped). (See “Intelligent Key system” (P.3-6).)
- Push the “UNLOCK” button on the remote controller (if equipped). (See “Remote keyless entry system” (P.3-5).)
- Push the power door lock switch to the UNLOCK position.

CLOSING BACK DOOR

To close the back door, push it down securely, then lock the back door with one of the following operations.

- Push the back door request switch **(1)** (if equipped). (See “Intelligent Key system” (P.3-6).)
- Push the “LOCK” button on the Intelligent Key (if equipped). (See “Intelligent Key system” (P.3-6).)
- Push the “LOCK” button on the remote controller (if equipped). (See “Remote keyless entry system” (P.3-5).)
- Push the power door lock switch to the LOCK position.

FUEL FILLER LID

⚠ WARNING:

- Fuel is extremely flammable and highly explosive under certain conditions. You could be burned or seriously injured if it is misused or mishandled. Always stop the engine and do not smoke or allow open flames or sparks near the vehicle when refueling.
- Fuel may be under pressure. Turn the cap a half of a turn, and wait for any “hissing” sound to stop to prevent fuel from spraying out and possibly causing personal injury. Then remove the cap.
- Use only an original equipment type fuel filler cap as a replacement. It has a built-in safety valve needed for proper operation of the fuel system and emission control system. An incorrect cap can result in a serious malfunction and possible injury.

OPENING FUEL FILLER LID

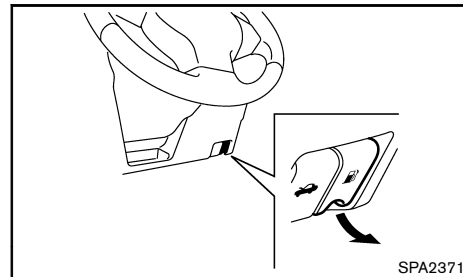

To open the fuel filler lid, pull the fuel filler lid release handle.

FUEL FILLER CAP

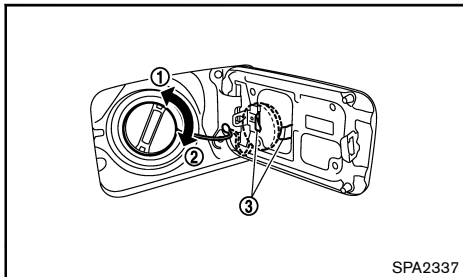

The fuel filler cap is a ratcheting type. Turn the cap counterclockwise ① to remove. Tighten the cap clockwise ② until ratchet clicks, more than twice, after refueling.

Put the fuel filler cap on the cap holder ③ while refueling.



CAUTION:

If fuel is spilled on the vehicle body, flush it away with water to avoid paint damage.

STEERING WHEEL

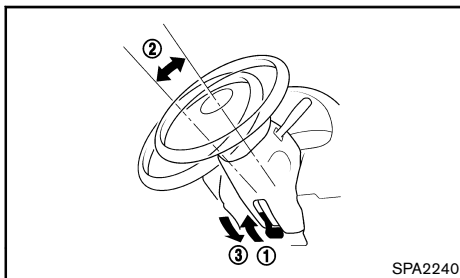

WARNING:

Never adjust the steering wheel while driving so that full attention may be given to vehicle operation.

While pulling the lock lever up ①, adjust the steering wheel up or down ② until the desired position is achieved.

Push the lock lever down ③ firmly to lock the steering wheel in place.

MIRRORS



WARNING:

Adjust the position of all mirrors before driving. Do not adjust the mirror positions while driving so that full attention may be given to vehicle operation.

INSIDE REARVIEW MIRROR

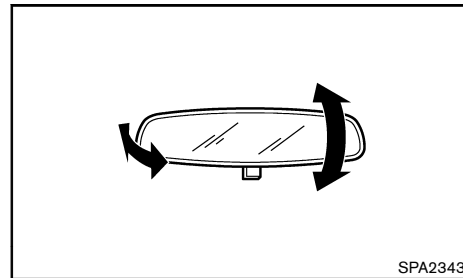

While holding the inside rearview mirror, adjust the mirror angles until the desired position is achieved.

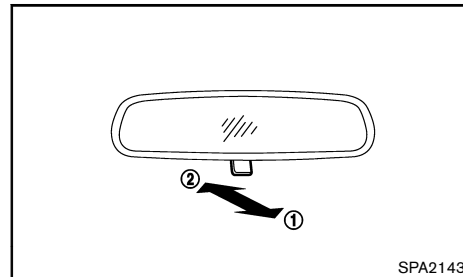

Pull the adjusting lever ① when the glare from the headlights of the vehicle behind you obstructs your vision at night.

Push the adjusting lever ② during the day for the best rearward visibility.

OUTSIDE REARVIEW MIRRORS



WARNING:

- **Never touch the outside rearview mirrors while they are in motion. Doing so may pinch your fingers or damage the mirror.**
- **Never drive the vehicle with the outside rearview mirrors folded. This reduces rear view visibility and may lead to an accident.**
- **Objects viewed in the outside mirror are closer than they appear (if equipped).**
- **The picture dimensions and distance in the outside mirrors are not real.**

Adjusting

Remote control type:

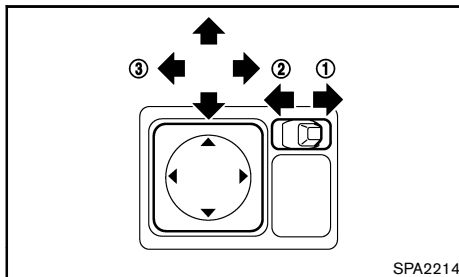

The outside rearview mirror remote control operates when the ignition switch is in the "ACC" or "ON" position.

1. Move the switch to select the right ① or left ② mirror.
2. Adjust each mirror until the desired position is achieved ③.

Folding

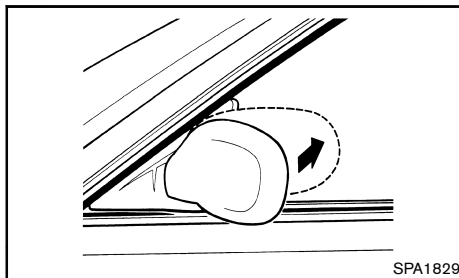

Fold the outside rearview mirror by pushing it toward

the rear of the vehicle.

VANITY MIRRORS (if equipped)

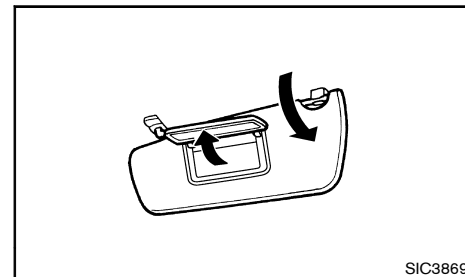

To access the vanity mirror, pull the sun visor down and pull the mirror cover open.

PARKING BRAKE



WARNING:

- **Never drive the vehicle with the parking brake applied. The brake will overheat and fail to operate and will lead to an accident.**
- **Never release the parking brake from outside the vehicle. If the vehicle moves, it will be impossible to push the foot brake pedal and will lead to an accident.**
- **Never use the shift lever in place of the parking brake. When parking, be sure the parking brake is fully applied.**
- **Never leave children or adults who would normally require the support of others alone in your vehicle. They could unknowingly release the parking brake and inadvertently become involved in a serious accident.**

completely ③.

Before driving, be sure that the brake warning light has turned off.

LEVER TYPE

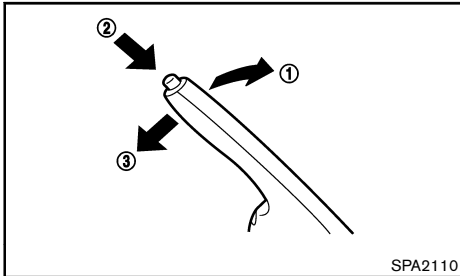

To apply the parking brake, pull the parking brake lever up ①.

To release the parking brake, firmly depress and hold the foot brake pedal. Pull up the parking brake lever slightly, push the button ② and lower the lever

MEMO

4 Heater and air conditioner, and audio system

Safety precautions	4-2	Cooling operation	4-4
Ventilators	4-2	Servicing air conditioner	4-4
Center ventilators	4-2	Audio system (if equipped)	4-4
Side ventilators	4-2	Audio operation precautions	4-4
Rear ventilators (if equipped)	4-2	Antenna	4-5
Cooler	4-3	Car phone or CB radio	4-6
Controls	4-3		



SAFETY PRECAUTIONS



WARNING:

- Do not adjust the heater and air conditioner controls or audio controls while driving so that full attention may be given to vehicle operation.
- If you noticed any foreign objects entering the system hardware, spilled liquid on the system, or noticed smoke or fumes coming out from the system, or any other unusual operation is observed, stop using the system immediately and contact the nearest NISSAN dealer. Ignoring such conditions may lead to an accident, fire or electric shock.
- Do not disassemble or modify this system. If you do, it may lead to an accident, fire, or electric shock.



CAUTION:

Do not use the system when the engine is not running for extended periods of time to prevent battery discharge.

VENTILATORS

CENTER VENTILATORS

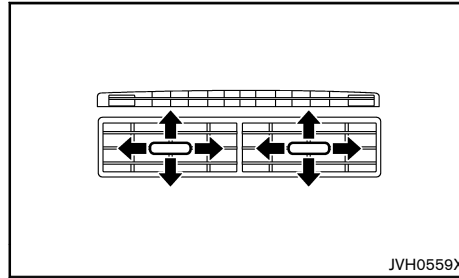

Adjust the air flow direction of the ventilators by moving the center knob (up/down, left/right) until the desired position is achieved.

SIDE VENTILATORS

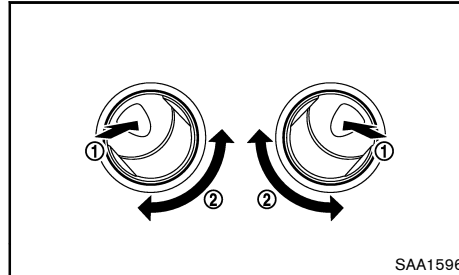

Adjust the air flow direction of the ventilators by opening ① and rotating ② as illustrated.

REAR VENTILATORS (if equipped)

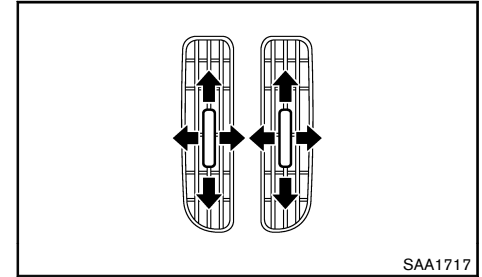

Adjust the air flow direction of the ventilators by moving the center knob (up/down, left/right) until the desired position is achieved.

COOLER



WARNING:

- The cooler operates only when the engine is running.
- Never leave children or adults who would normally require the support of others alone in the vehicle. Pets should not be left alone either. They could unknowingly activate switches or controls and inadvertently become involved in a serious accident and injure themselves. On hot, sunny days, temperatures in a closed vehicle could quickly become high enough to cause severe or possibly fatal injuries to people or animals.
- Do not use the recirculation mode for long periods as it may cause the interior air to become stale and the windows to fog up.
- Do not adjust the cooling control while driving so that full attention may be given to vehicle operation.

The air blower will operate even if the engine is turned off and the ignition switch is in the "ON" position.

NOTE:

- Odors from inside and outside the vehicle can build up in the cooler unit. Odor can enter the passenger compartment through the vents.
- When parking, set the cooler controls to turn off air recirculation to allow fresh air into the passenger compartment. This should help reduce odors inside the vehicle.

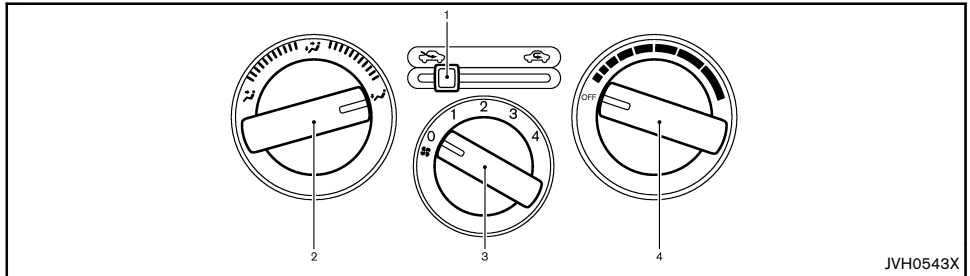

1. Air intake lever (Outside air circulation "☞"/Air recirculation "☞")
2. Air flow control dial
3. Fan speed control "☞" dial
4. Temperature control dial

To turn off the cooler, turn the fan speed control "☞" dial to the "0" (off) position.

CONTROLS

Outside air circulation

Move the air intake lever to the "☞" position. The air flow is drawn from outside the vehicle.

Air recirculation

Move the air intake lever to the "☞" position. The air flow is circulated inside the vehicle.

Air flow control

Turn the air flow control dial to change the air flow mode.

- ☞ — Air flows from the center and side ventilators.
- ☞ — Air flows from the center and side ventilators and foot outlets.
- ☞ — Air flows mainly from the foot outlets.

Fan speed control

Turn the fan speed control “” dial clockwise to increase the fan speed.

Turn the fan speed control “” dial counterclockwise to decrease the fan speed.

Temperature control

Turn the temperature control dial to set the desired temperature.

Ventilation

The ventilation will be operated by the following.

1. Move the air intake lever to the “” position.
2. Turn the temperature control dial to set “OFF”.
3. Turn the fan speed control dial to set the desired fan speed.

COOLING OPERATION

The cooler should be operated for approximately 10 minutes at least once a month. This helps prevent damage to the cooling function due to the lack of lubrication.

1. Turn the air flow control dial to the preferred position.
2. Turn the fan speed control “” dial to the desired position.
3. Turn the temperature control dial to the desired position.

A visible mist may be seen coming from the ventilators in hot, humid conditions as the air is cooled rapidly. This does not indicate a malfunction.

To turn off the cooling function, turn the temperature control dial to the “OFF” position.

SERVICING AIR CONDITIONER



WARNING:

The air conditioner system contains refrigerant under high pressure. To avoid personal injury, any air conditioner service should be done only by an experienced technician with the proper equipment.

The air conditioner system in your vehicle is charged with a refrigerant designed with the environment in mind.

This refrigerant will not harm the earth's ozone layer. However, it may contribute in a small part to global warming.

Special charging equipment and lubricant are required when servicing your vehicle's air conditioner. Using improper refrigerants or lubricants will cause severe damage to the air conditioner system. (See “Air conditioner system refrigerant and lubricant” (P.9-3).)

A NISSAN dealer will be able to service your environmentally friendly air conditioner system.

AUDIO SYSTEM (if equipped)

AUDIO OPERATION PRECAUTIONS



WARNING:

Do not adjust the audio system while driving so that full attention may be given to vehicle operation.

The audio system operates when the ignition switch is in the “ACC” or “ON” position.

Compact Disc (CD) player

- During cold weather or rainy days, the player may malfunction due to humidity. If this occurs, remove the CD from CD player and dehumidify or ventilate the player completely.
- The player may skip while driving on rough roads.
- The CD player sometimes may not function when the passenger compartment temperature is extremely high. Lower the temperature before use.
- Do not expose CDs to direct sunlight.
- CDs that are of poor quality, or are dirty, scratched, covered with fingerprints, or that have pin holes may not work properly.
- The following CDs may not work properly.
 - Copy control compact discs (CCCD)
 - Recordable compact discs (CD-R)
 - Rewritable compact discs (CD-RW)

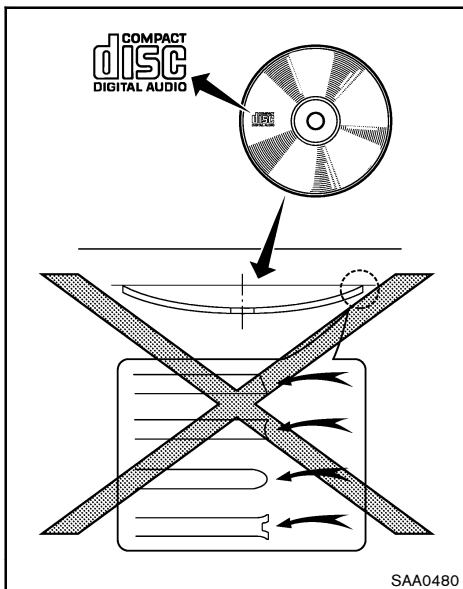

- Do not use the following CDs as they may cause the CD player to malfunction.
 - 8 cm (3.1 in) discs
 - CDs that are not round
 - CDs with a paper label
 - CDs that are warped, scratched or have unusual edges.

Radio

- Radio reception is affected by station signal strength, distance from radio transmitter, buildings, bridges, mountains and other external influences. Intermittent changes in reception quality normally are caused by these external influences.
- Using a cellular phone in or near the vehicle may influence radio reception quality.

ANTENNA

Adjust the antenna angle for the best reception.

Removing antenna

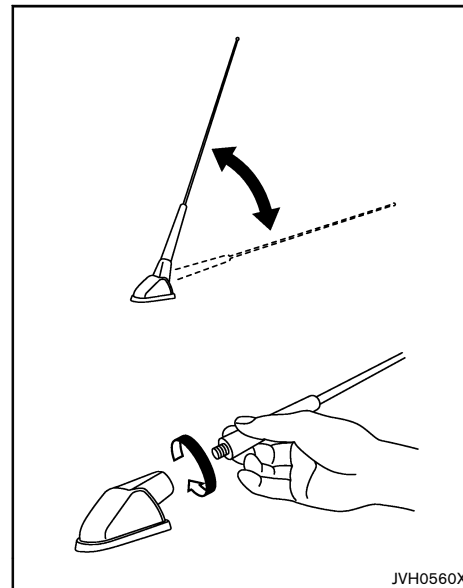

You can remove the antenna if necessary.

Hold the bottom of the antenna and remove it by turning counterclockwise.

To install the antenna, turn the antenna clockwise and tighten.



CAUTION:

- **Be sure to fold down the antenna before the vehicle enters a garage with a low ceiling.**

CAR PHONE OR CB RADIO

- **Be sure that antenna is removed before the vehicle enters an automatic car wash.**

When installing a car phone or a CB radio in your vehicle, be sure to observe the following cautions, otherwise the new equipment may adversely affect the Engine Control system and other electronic parts.



CAUTION:

- **Keep the antenna as far away as possible from the electronic control modules.**
- **Keep the antenna wire at least 20 cm (8 in) away from the electronic control system. Do not route the antenna wire next to any harnesses.**
- **Adjust the antenna standing-wave ratio as recommended by the manufacturer.**
- **Connect the ground wire from the radio chassis to the body.**
- **For details, consult a NISSAN dealer.**

5 Starting and driving

Break-in schedule	5-2	Driving vehicle	5-7
Before starting engine	5-2	Driving with Automatic Transmission (AT)	5-7
Precautions when starting and driving	5-2	Driving with Continuously Variable Transmission (CVT)	5-10
Exhaust gas (carbon monoxide)	5-3	Driving with Manual Transmission (MT)	5-13
Three-way catalyst	5-3	Parking	5-15
Care when driving	5-4	Trailer towing	5-16
Engine cold start period	5-4	Electric power steering system	5-16
Loading luggage	5-4	Brake system	5-17
Driving in wet conditions	5-4	Brake precautions	5-17
Driving in winter conditions	5-4	Brake assist (if equipped)	5-17
Ignition switch	5-4	Anti-lock Braking System (if equipped)	5-17
Intelligent Key system (if equipped)	5-4	Vehicle security	5-18
Automatic Transmission (AT)/Continuously Variable Transmission (CVT)	5-5	Cold weather driving	5-19
Manual Transmission (MT)	5-5	Battery	5-19
Steering lock	5-6	Engine coolant	5-19
Key positions	5-6	Tire equipment	5-19
Starting engine	5-6	Special winter equipment	5-19
		Parking brake	5-19
		Corrosion protection	5-19

BREAK-IN SCHEDULE

During the first 1,600 km (1,000 miles), follow these recommendations to obtain maximum engine performance and ensure the future reliability and economy of your new vehicle. Failure to follow these recommendations may result in shortened engine life and reduced engine performance.

- Do not drive at a constant speed, either fast or slow, for long periods of time.
- Do not run the engine over 4,000 rpm.
- Do not accelerate at full throttle in any gear.
- Do not start quickly.
- Do not brake hard as much as possible.

BEFORE STARTING ENGINE



WARNING:

The driving characteristics of your vehicle will change remarkably by any additional load and its distribution, as well as by adding optional equipment (trailer coupling, roof racks, etc.). Your driving style and speed must be adjusted according to the circumstances. Especially when carrying heavy loads, your speed must be reduced adequately.

- Make sure the area around the vehicle is clear.
- Visually inspect tires for their appearance and condition. Measure and check the tire pressure for proper inflation.
- Check that all windows and lights are clean.
- Adjust the seat and head restraint positions.
- Adjust the inside and outside rearview mirror positions.
- Fasten your seat belt and ask all passengers to do the same.
- Check that all doors are closed.
- Check the operation of the warning lights when the ignition switch is turned to the "ON" position.
- Maintenance items in the "8. Maintenance and do-it-yourself" section should be checked periodically.

PRECAUTIONS WHEN STARTING AND DRIVING



WARNING:

- **Never leave children or adults who would normally require the support of others alone in your vehicle. Pets should not be left alone either. They could unknowingly activate switches or controls and inadvertently become involved in a serious accident and injure themselves. On hot, sunny days, temperatures in a closed vehicle could quickly become high enough to cause severe or possibly fatal illness to people or animals.**
- **To prevent luggage or packages from sliding forward during braking, do not stack anything in the luggage area higher than the seatbacks.**

NOTE:

During the first few months after purchasing a new vehicle, if you smell strong odors of Volatile Organic Compounds (VOCs) inside the vehicle, ventilate the passenger compartment thoroughly. Open all the windows before entering or while in the vehicle. In addition, when the temperature in the passenger compartment rises, or when the vehicle is parked in direct sunlight for a period of time, turn off the air recirculation mode of the air conditioner and/or open the windows to allow sufficient fresh air into the passenger compartment.

EXHAUST GAS (carbon monoxide)



WARNING:

- Do not breathe exhaust gas; it contains colorless and odorless carbon monoxide. Carbon monoxide is dangerous. It can cause unconsciousness or death.
- If you suspect that exhaust fumes are entering the vehicle, drive with all windows fully open, and have the vehicle inspected immediately.
- Do not run the engine in closed spaces such as a garage.
- Do not park the vehicle with the engine running for an extended period of time.
- Keep the back door closed while driving, otherwise exhaust gas could be drawn into the passenger compartment. If you must drive with the back door open, follow these precautions:
 - Open all the windows.
 - Turn the air recirculation mode off and set the fan speed control to the highest level to circulate the air.
- If a special body or other equipment is added for recreational or other usage, follow the manufacturer's recommendation to prevent carbon monoxide entry into the vehicle. (Some recreational vehicle appliances such as stoves, refrigerators, heaters, etc. may also generate carbon monoxide.)
- The exhaust system and body should be inspected by a qualified mechanic whenever:

- Your vehicle is raised while being serviced.
- You suspect that exhaust fumes are entering into the passenger compartment.
- You notice a change in the sound of the exhaust system.
- You have had an accident involving damage to the exhaust system, underbody, or rear of the vehicle.

THREE-WAY CATALYST



WARNING:

- The exhaust gas and the exhaust system are very hot. Keep people, animals and flammable materials away from the exhaust system components.
- Do not stop or park the vehicle over flammable materials such as dry grass, wastepaper or rags. They may ignite and cause a fire.

The three-way catalyst is an emission control device installed in the exhaust system. Exhaust gas in the three-way catalyst is burned at high temperatures to help reduce pollutants.



CAUTION:

- Do not use leaded gasoline. (See "Recommended fuel/lubricants and capacities" (P.9-2).) Deposits from leaded gasoline seriously reduce the ability of the three-way catalyst to help reduce exhaust pollutants and/or damage the three-way catalyst.

- Keep your engine tuned up. Malfunctions in the ignition, fuel injection, or electrical systems may cause overrich fuel to flow into the three-way catalyst, causing it to overheat. Do not keep driving if the engine misfires, or if noticeable loss of performance or other unusual operating conditions are detected. Have the vehicle inspected promptly by a NISSAN dealer.
- Avoid driving with an extremely low fuel level. Running out of fuel could cause the engine to misfire, damaging the three-way catalyst.
- Do not race the engine while warming it up.
- Do not push or tow your vehicle to start the engine.

CARE WHEN DRIVING

Driving your vehicle to fit the circumstances is essential for your safety and comfort. As a driver, you should be the one who knows best how to drive in the given circumstances.

ENGINE COLD START PERIOD

Due to the higher engine speeds, when the engine is cold, extra caution must be exercised when selecting a gear during the engine warm-up period after starting the engine.

LOADING LUGGAGE

Loads and their distribution and the attachment of equipment (coupling devices, roof baggage carriers, etc.) will considerably change the driving characteristics of the vehicle. Your driving style and speed must be adjusted according to the circumstances.

DRIVING IN WET CONDITIONS

- Avoid accelerating or stopping suddenly.
- Avoid sharp turning or lane changing suddenly.
- Avoid following too close to the vehicle in front.

When water covers the road surface with water puddles, small water streams, etc., reduce speed to prevent hydroplaning which can cause skidding and loss of control. Worn tires will increase this risk.

DRIVING IN WINTER CONDITIONS

- Drive cautiously.
- Avoid accelerating or stopping suddenly.
- Avoid sharp turning or lane changing suddenly.
- Avoid sudden steering.
- Avoid following too close to the vehicle in front.

IGNITION SWITCH



WARNING:

Never remove the key or turn the ignition switch to the “LOCK” position while driving. The steering wheel will lock and could cause the driver to lose control of the vehicle. This could result in serious vehicle damage or personal injury.

INTELLIGENT KEY SYSTEM (if equipped)

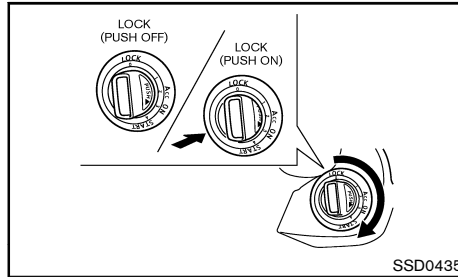

The Intelligent Key system can operate the ignition switch without taking the key out from your pocket or purse. The operating environment and/or conditions may affect the Intelligent Key system operation.



CAUTION:

- **Be sure to carry the Intelligent Key with you when operating the vehicle.**
- **Never leave the Intelligent Key inside the vehicle when you leave the vehicle.**
- **If the vehicle battery is discharged the ignition switch cannot be moved from the “LOCK” position and if the steering lock is engaged, the steering wheel cannot be moved. Charge the battery as soon as**

possible. (See “Jump starting” (P.6-6).)

Operating range

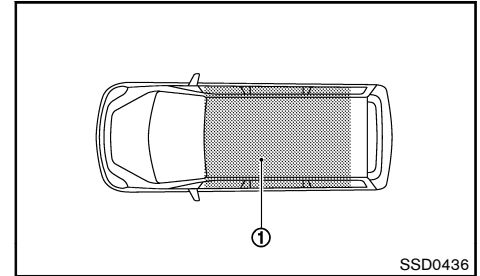

The Intelligent Key functions can only be used for starting the engine when the Intelligent Key is within the specified operating range ①.

When the Intelligent Key battery is almost discharged or strong radio waves are present near the operating location, the Intelligent Key system's operating range becomes narrower and may not function properly.

If the Intelligent Key is within the operating range, it is possible for anyone, even someone who does not carry the Intelligent Key, to turn the ignition switch to start the engine.

- The luggage area is not included in the operating range, but the Intelligent Key may function.
- If the Intelligent Key is placed on the instrument panel, inside the glove box or door pocket, the Intelligent Key may not function.
- If the Intelligent Key is placed near the door or window outside the vehicle, the Intelligent Key may function.

AUTOMATIC TRANSMISSION (AT)/CONTINUOUSLY VARIABLE TRANSMISSION (CVT)

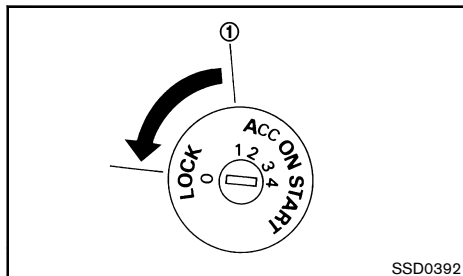

Without Intelligent Key system

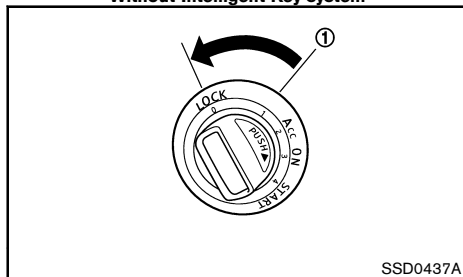

With Intelligent Key system

The ignition lock is designed so that the ignition switch cannot be turned to the “LOCK” position until the shift lever is moved to the “P” (Park) position. When moving the ignition switch to the “LOCK” position, to remove the key from the ignition switch, make sure the shift lever is in the “P” (Park) position.

When the ignition switch cannot be turned to the “LOCK” position:

The Intelligent Key LOCK warning light blinks on the meter and a chime sounds.

1. Move the shift lever to the “P” (Park) position.
2. Turn the ignition switch slightly in the “ON” direction.
3. Turn the ignition switch to the “LOCK” position.
4. Remove the key, if it is inserted in the ignition switch.

If the ignition switch is turned to the “LOCK” position, the shift lever cannot be moved from the “P” (Park) position. The shift lever can be moved if the ignition switch is in the “ON” position with the foot brake pedal depressed.

The “OFF” position ① is between the “LOCK” and “ACC” positions, although it is not labeled on the ignition switch.

MANUAL TRANSMISSION (MT)

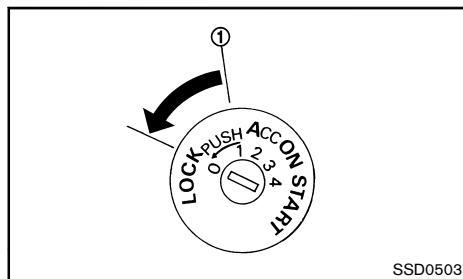

Without Intelligent Key system

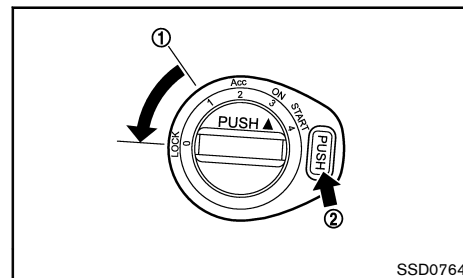

With Intelligent Key system

The ignition switch includes a device that helps prevent accidental removal of the key while driving.

The key can only be removed when the ignition switch is in the “LOCK” position.

Models without Intelligent Key system

To turn the ignition switch to the “LOCK” position from the “ACC” or “ON” position, turn the key to the “OFF” position, push the key in, then turn the key to the “LOCK” position.

The “OFF” position ① is between the “LOCK” and “ACC” positions, although it is not marked on the ignition switch.

Models with Intelligent Key system

To turn the ignition switch to the “LOCK” position from the “ACC” or “ON” position, turn the key to the “OFF” position, push the PUSH release button ②, then turn the key to the “LOCK” position.

The “OFF” position ① is between the “LOCK” and “ACC” positions, although it is not marked on the ignition switch.

- The Intelligent Key lock warning light  blinks and the buzzer sounds when the ignition switch is

not turned to the “LOCK” position completely without pushing the PUSH release button ②. For further details regarding the functionality of the Intelligent Key lock warning light, see “Intelligent Key lock warning light” (P.2-10).

- When the mechanical key is being used, the ignition PUSH release button has to be pushed in order to turn the ignition switch to the “LOCK” position although the Intelligent Key lock warning light  will not blink and the buzzer will not sound.

STEERING LOCK

To lock steering wheel

1. Turn the ignition switch to the “LOCK” position.
2. Remove the key, if it is inserted in the ignition switch.
3. Turn the steering wheel 1/6 of a turn clockwise from the straight up position.

To unlock steering wheel

1. Insert the key into the ignition switch, if necessary.
2. Gently turn the ignition switch while rotating the steering wheel slightly right and left.

KEY POSITIONS

LOCK (0)

The ignition key can only be removed at this position.

The steering lock can only be locked at this position.

Intelligent Key system:

PUSH OFF -

The steering lock can only be locked at this position.

PUSH ON -

The ignition switch will be unlocked while

carrying the Intelligent Key.

OFF (1)

The engine is turned off with the steering wheel unlocked.

ACC (2)

The electrical accessory power activates without the engine turned on.

ON (3)

The ignition system and the electrical accessory power activate without the engine turned on.

START (4)

The engine starter activates and the engine will start. The ignition switch, when released, will automatically turn to the “ON” position.



CAUTION:

As soon as the engine has started, release the ignition switch immediately.

STARTING ENGINE

1. Apply the parking brake.
2. Automatic Transmission (AT)/Continuously Variable Transmission (CVT) model: Move the shift lever to the “P” (Park) or “N” (Neutral) position.

The starter is designed to operate only when the shift lever is in the appropriate position.

Manual Transmission (MT) model: Move the shift lever to the “N” (Neutral) position, and depress the clutch and foot brake pedal to the floor while starting the engine.

Intelligent Key system: Slowly “PUSH ON” the ignition switch. When the Intelligent Key system warning light in the meter illuminates in green, the ignition switch can be turned.

The Intelligent Key must be carried when operating the ignition switch.

When the Intelligent Key lock warning light in the meter blinks in red and the inside warning buzzer emits a short beep, be sure that the shift lever is in the “P” (Park) position and the ignition switch is securely returned to the “LOCK” position.

The Intelligent Key lock warning light, blinking in red, turns off by performing the following operations:

- Return the ignition switch to the “LOCK” position.
- Turn the ignition switch to the “ACC” position.

When the buzzer beeps 4 times continuously, check for the following:

- The ignition switch is returned to the “LOCK” position.
- The mechanical key is not inserted into the ignition switch.

The inside warning buzzer stops when one of the following is performed:

- Return the ignition switch to the “LOCK” position.
 - Remove the mechanical key from the ignition switch.
 - Close the doors.
3. Crank the engine with your foot off the accelerator pedal by turning the ignition switch to the “START” position.
 4. Immediately release the ignition switch when the engine starts. If the engine starts, but fails to run, repeat the above procedures.
 - If the engine is very hard to start in extremely cold weather or when restarting, depress the accelerator pedal a little (approximately 1/3 to the floor) and hold it and then crank the engine. Release the accelerator pedal when the engine starts.
 - If the engine is very hard to start because it is flooded, depress the accelerator pedal all the way to the floor and hold it. Crank the engine for 5 - 6 seconds. After cranking the engine, release the accelerator pedal. Crank the engine with your foot off the accelerator pedal by turning the ignition switch to START. Release the ignition switch when the engine starts. If the engine starts, but fails to run, repeat the above procedure.



CAUTION:

- **Do not operate the starter for more than 15 seconds at a time. If the engine does not start, turn the ignition switch off and wait 10 seconds before cranking the engine again. Otherwise, the starter could be damaged.**

- **If it becomes necessary to start the engine with a booster battery and jumper cables, the instructions and cautions contained in the “6. In case of emergency” section should be carefully followed.**
5. Allow the engine to idle for at least 30 seconds after starting the engine to warm-up. Drive at moderate speeds for a short distance first, especially in cold weather.



CAUTION:

Do not leave the vehicle unattended while the engine is warming up.

DRIVING VEHICLE

DRIVING WITH AUTOMATIC TRANSMISSION (AT)

The Automatic Transmission (AT) in your vehicle is electronically controlled to produce maximum power and smooth operation.

The recommended operating procedures for this transmission are shown on the following pages. Follow these procedures for maximum vehicle performance and driving enjoyment.



WARNING:

Do not downshift abruptly on slippery roads. This may cause a loss of control.



CAUTION:

- **The cold engine idle speed is high, so use caution when shifting the transmission into a forward or reverse position before the engine has warmed up.**
- **Avoid revving up the engine while the vehicle is stopped. This could cause unexpected vehicle movement.**
- **Never shift to either the “P” (Park) or “R” (Reverse) position while the vehicle is moving. This could cause serious damage to the transmission.**
- **Except in an emergency, do not shift to the “N” (Neutral) position while driving. Coasting with the transmission in the “N” (Neutral) position may cause serious damage to the transmission.**
- **Start the engine in either the “P” (Park) or “N” (Neutral) position. The engine will not start in any other position. If it does, have**

your vehicle checked by a NISSAN dealer.

- Shift into the “P” (Park) position and apply the parking brake when at a standstill for longer than a short waiting period.
- Keep the engine at idling speed while shifting from the “N” (Neutral) position to any driving position.
- When stopping the vehicle on an uphill grade, do not hold the vehicle by depressing the accelerator pedal. The foot brake pedal should be depressed in this situation.

Starting vehicle

1. After starting the engine, fully depress the foot brake pedal before attempting to move the shift lever out of the “P” (Park) position.
2. Keep the foot brake pedal depressed and move the shift lever to a driving position.
3. Release the parking brake, the foot brake pedal, and then gradually start the vehicle in motion.

The AT is designed so the foot brake pedal MUST be depressed before shifting from the “P” (Park) position to any driving position while the ignition switch is in the “ON” position.

The shift lever cannot be moved out of the “P” (Park) position and into any of the other gear positions if the ignition switch is turned to the “LOCK”, “OFF” or “ACC” position or if the key is removed.



CAUTION:

- **DEPRESS THE FOOT BRAKE PEDAL** - Shifting the shift lever to “D”, “R”, “2” or “1” without depressing the foot brake pedal causes the vehicle to move slowly when

the engine is running. Make sure the foot brake pedal is depressed fully and the vehicle is stopped before shifting the shift lever.

- **MAKE SURE OF THE SHIFT LEVER POSITION** - Make sure the shift lever is in the desired position. “D”, “2” and “1” are used to move forward and “R” to back up.
- **WARM UP THE ENGINE** - Due to the higher idle speeds when the engine is cold, extra caution must be exercised when shifting the shift lever into the driving position immediately after starting the engine.

Shifting gear

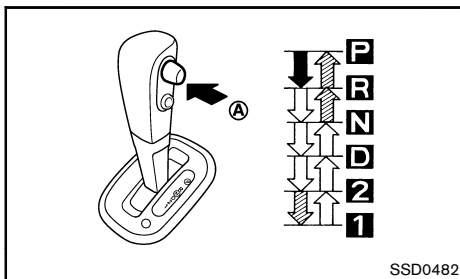

	Push the button (A) while depressing the foot brake pedal.
	Push the button (A) .
	Just move the shift lever.



WARNING:

- **Apply the parking brake if the shift lever is in any position while the engine is not running. Failure to do so could cause the vehicle to move unexpectedly or roll away and result in serious personal injury or property damage.**
- **If the shift lever cannot be moved from the “P” (Park) position while the engine is running and the foot brake pedal is depressed, the stop lights may not work. Malfunctioning stop lights could cause an accident injuring yourself and others.**

After starting the engine, fully depress the foot brake pedal, push the shift lever button and move the shift lever out of the “P” (Park) position.

If the ignition switch is turned to the “OFF” or “ACC” position for any reason while the shift lever is in any positions other than the “P” (Park) position, the ignition switch cannot be turned to the “LOCK” position.

If the ignition switch cannot be turned to the “LOCK” position, perform the following steps:

1. Apply the parking brake.
2. Turn the ignition switch to the “ON” position while depressing the foot brake pedal.
3. Move the shift lever to the “P” (Park) position.
4. Turn the ignition switch to the “LOCK” position.

P (Park):

Use this position when the vehicle is parked or when starting the engine. **Make sure that the vehicle is completely stopped and move the shift lever into the "P" (Park) position.** Apply the parking brake. When parking on a hill, apply the parking brake first, and then move the shift lever into the "P" (Park) position.

R (Reverse):

Use this position to back up. Make sure that the vehicle is completely stopped before selecting the "R" (Reverse) position.

N (Neutral):

Neither the forward nor reverse gear is engaged. The engine can be started in this position. You may shift to the "N" (Neutral) position and restart a stalled engine while the vehicle is moving.

D (Drive):

Use this position for all normal forward driving.

2 (Second gear):

Use this position for climbing hills or engine braking on downhill grades.

1 (Low gear):

Use this position when climbing steep hills slowly or driving slowly through deep snow, sand or mud, or for maximum engine braking on steep downhill grades.

Do not shift into the gears when the vehicle speed exceeds the following limits, otherwise the engine may over-rev and cause engine damage.

Engine model	Shift lever position	
	1	2
MR18DE	55 km (35 MPH)	100 km (62 MPH)

Overdrive switch

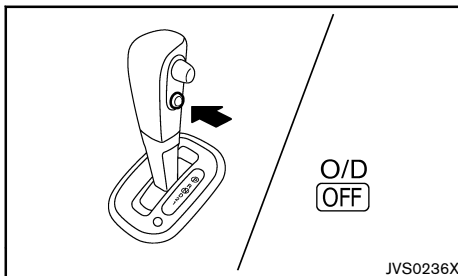

Each time the engine is started, the transmission is automatically reset to overdrive "ON".

"ON" position:

With the engine running and the shift lever in the "D" (Drive) position, the transmission upshifts into the overdrive as vehicle speed increases.

Overdrive does not engage until the engine has reached operating temperature.

"OFF" position:

For driving up and down long slopes where engine braking is necessary, push the overdrive switch. The overdrive off indicator light  in the meter panel illuminates.

When cruising at a low speed or climbing a gentle slope, you may feel uncomfortable shift shocks as the transmission shifts into and out of the overdrive repeatedly. In this case, push the overdrive switch to

turn the overdrive "OFF".

When driving conditions change, push the overdrive switch to turn the overdrive "ON". The overdrive off indicator light will turn off.

Remember not to drive at high speeds for extended periods of time with the overdrive "OFF". This reduces fuel economy.

The AT may shift to the overdrive automatically when the AT Fluid (ATF) temperature is high.

Accelerator downshift - in the "D" position -

For passing or climbing hills, depress the accelerator pedal to the floor. This shifts the transmission down into a lower gear, depending on the vehicle speed.

Shift lock release

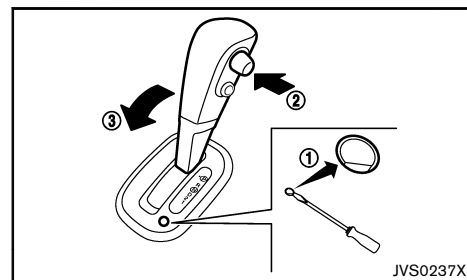

If the battery is discharged, the shift lever may not be moved from the "P" (Park) position even with the foot brake pedal depressed and shift lever button pushed.

To move the shift lever, perform the following procedure:

1. Turn the ignition switch to the "LOCK" position and remove the key.

2. Apply the parking brake.
3. Remove the shift lock release cover ① using a suitable tool.
4. Push down the shift lock release using a suitable tool.
5. Push the shift lever button ② and move the shift lever ③ to the “N” (Neutral) position while holding down the shift lock release.

Turn the ignition switch to the “ON” position to release the steering wheel lock.

The vehicle may be moved to the desired location.

Replace the removed shift lock release cover after the operation.

If the shift lever cannot be moved out of the “P” (Park) position, have a NISSAN dealer check the AT system as soon as possible.



WARNING:

If the shift lever cannot be moved from the “P” (Park) position while the engine is running and the brake pedal is depressed, the stop lights may not work. Malfunctioning stop lights could cause an accident injuring yourself and others.

Fail-safe

When the fail-safe operation occurs, the AT will be locked in third gear.

If the vehicle is driven under extreme conditions, such as excessive wheel spinning and subsequent hard braking, the fail-safe system may be activated. This will occur even if all electrical circuits are functioning properly. In this case, turn the ignition switch off and wait for 3 seconds. Then turn the ignition switch back to the “ON” position. The vehicle should return to

its normal operating condition. If it does not return to its normal operating condition, have a NISSAN dealer check the transmission and repair it if necessary.

DRIVING WITH CONTINUOUSLY VARIABLE TRANSMISSION (CVT)

The Continuously Variable Transmission (CVT) in your vehicle is electronically controlled to produce maximum power and smooth operation.

The recommended operating procedures for this transmission are shown on the following pages. Follow these procedures for maximum vehicle performance and driving enjoyment.



WARNING:

Do not downshift abruptly on slippery roads. This may cause a loss of control.



CAUTION:

- **The cold engine idle speed is high, so use caution when shifting the transmission into a forward or reverse position before the engine has warmed up.**
- **Avoid revving up the engine while the vehicle is stopped. This could cause unexpected vehicle movement.**
- **Except in an emergency, do not shift to the “N” (Neutral) position while driving. Coasting with the transmission in the “N” (Neutral) position may cause serious damage to the transmission.**
- **Never shift to either the “P” (Park) or “R” (Reverse) position while the vehicle is moving. This could cause serious damage to the**

transmission.

- **Start the engine in either the “P” (Park) or “N” (Neutral) position. The engine will not start in any other position. If it does, have your vehicle checked by a NISSAN dealer.**
- **Shift into the “P” (Park) position and apply the parking brake when at a standstill for longer than a short waiting period.**
- **Keep the engine at idling speed while shifting from the “N” (Neutral) position to any driving position.**
- **When stopping the vehicle on an uphill grade, do not hold the vehicle by depressing the accelerator pedal. The foot brake pedal should be depressed in this situation.**

Starting vehicle

1. After starting the engine, fully depress the foot brake pedal before moving the shift lever out of the “P” (Park) position.
2. Keep the foot brake pedal depressed and move the shift lever to a driving position.
3. Release the parking brake, the foot brake pedal, and then gradually start the vehicle in motion.

The CVT is designed so the foot brake pedal MUST be depressed before shifting from the “P” (Park) position to any driving position while the ignition switch is in the “ON” position.

The shift lever cannot be moved out of the “P” (Park) position and into any of the other positions if the ignition switch is turned to the “LOCK”, “OFF” or “ACC” position or if the key is removed.

CAUTION:

- **DEPRESS THE FOOT BRAKE PEDAL** - Shifting the shift lever to “D”, “R” or “L” without depressing the foot brake pedal causes the vehicle to move slowly when the engine is running. Make sure the foot brake pedal is depressed fully and the vehicle is stopped before shifting the shift lever.
- **MAKE SURE OF THE SHIFT LEVER POSITION** - Make sure the shift lever is in the desired position. “D” and “L” are used to move forward and “R” to back up.
- **WARM UP THE ENGINE** - Due to the higher idle speeds when the engine is cold, extra caution must be exercised when shifting the shift lever into the driving position immediately after starting the engine.

Shifting gear

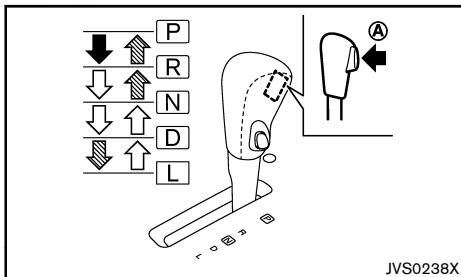

JVS0238X

➡: Push the button (A) while depressing the foot brake pedal.

▨: Push the button (A) .

➡: Just move the shift lever.

WARNING:

- **Apply the parking brake if the shift lever is in any position while the engine is not running. Failure to do so could cause the vehicle to move unexpectedly or roll away and result in serious personal injury or property damage.**
- **If the shift lever cannot be moved from the “P” (Park) position while the engine is running and the foot brake pedal is depressed, the stop lights may not work. Malfunctioning stop lights could cause an accident injuring yourself and others.**

After starting the engine, fully depress the foot brake pedal, push the shift lever button and move the shift lever out of the “P” (Park) position.

If the ignition switch is turned to the “OFF” or “ACC” position for any reason while the shift lever is in any positions other than the “P” (Park) position, the ignition switch cannot be turned to the “LOCK” position.

If the ignition switch cannot be turned to the “LOCK” position, perform the following steps:

1. Apply the parking brake.
2. Turn the ignition switch to the “ON” position while depressing the foot brake pedal.
3. Move the shift lever to the “P” (Park) position.
4. Turn the ignition switch to the “LOCK” position.

P (Park):

Use this position when the vehicle is parked or when starting the engine. **Make sure that the vehicle is completely stopped and move the shift lever into the “P” (Park) position.** Apply the parking brake. When parking on a hill, apply the parking brake first, and then move the shift lever into the “P” (Park) position.

R (Reverse):

Use this position to back up. Make sure that the vehicle is completely stopped before selecting the “R” (Reverse) position.

N (Neutral):

Neither the forward nor reverse gear is engaged. The engine can be started in this position. You may shift to the “N” (Neutral) position and restart a stalled engine while the vehicle is moving.

D (Drive):

Use this position for all normal forward driving.

L (Low):

Use this position when climbing steep hills slowly or driving slowly through deep snow, sand or mud, or for maximum engine braking on steep downhill grades.

SPORT mode switch

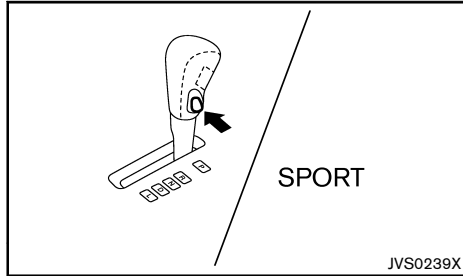

To select the SPORT mode, push the SPORT mode switch with the shift lever in the “D” (Drive) position. The SPORT mode indicator light **SPORT** in the meter panel illuminates. To turn off the SPORT mode, push the SPORT mode switch again. The SPORT mode indicator light will turn off. When the shift lever is shifted to any position other than “D”, the SPORT mode will be automatically turned off.

“OFF” position:

For normal driving and fuel economy, use the “OFF” position.

“ON” position:

For driving up or down long slopes where engine braking is necessary, or for powerful acceleration, use the “ON” position. The transmission will automatically select a different gear ratio, allowing the engine to turn the SPORT mode off.

When driving conditions change, push the switch to turn the SPORT mode off.

Remember not to drive at high speeds for extended periods of time with the SPORT mode in the “ON” position. This reduces fuel economy.

Accelerator downshift - in the “D” position -

For passing or climbing hills, depress the accelerator pedal to the floor. This shifts the transmission down into a lower gear, depending on the vehicle speed.

Shift lock release

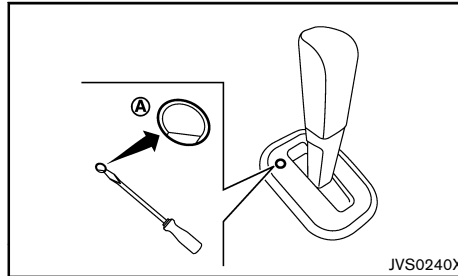

Type A

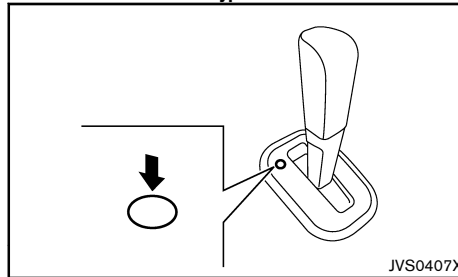

Type B

If the battery is discharged, the shift lever may not be moved from the “P” (Park) position even with the foot brake pedal depressed and shift lever button pushed.

To move the shift lever, perform the following procedure:

1. Turn the ignition switch to the “LOCK” position and remove the key.
2. Apply the parking brake.
3. **Type A:**
Remove the shift lock release cover (A) using a suitable tool and push down the shift lock release using a suitable tool.
Type B:
Depress the shift lock release button.
4. Push the shift lever button and move the shift lever to the “N” (Neutral) position while holding down the shift lock release.

Turn the ignition switch to the “ON” position to release the steering wheel lock.

The vehicle may be moved to the desired location.

Replace the removed shift lock release cover after the operation.

If the shift lever cannot be moved out of the “P” (Park) position, have a NISSAN dealer check the CVT system as soon as possible.



WARNING:

If the shift lever cannot be moved from the “P” (Park) position while the engine is running and the brake pedal is depressed, the stop lights may not work. Malfunctioning stop lights could cause an accident injuring yourself and others.

High fluid temperature protection mode

This transmission has a high fluid temperature protection mode. If the fluid temperature becomes too high (for example, when climbing steep grades in high temperature with heavy loads, such as when towing a trailer), engine power and, under some conditions, vehicle speed will be decreased automatically to reduce the chance of transmission damage. Vehicle speed can be controlled with the accelerator pedal, but engine and vehicle speed may be limited.

Fail-safe

When the fail-safe operation occurs, the CVT will not be shifted to the selected driving position.

If the vehicle is driven under extreme conditions, such as excessive wheel spinning and subsequent hard braking, the fail-safe system may be activated. This will occur even if all electrical circuits are functioning properly. In this case, turn the ignition switch off and wait for 3 seconds. Then turn the ignition switch back to the "ON" position. The vehicle should return to its normal operating condition. If it does not return to its normal operating condition, have a NISSAN dealer check the transmission and repair it if necessary.



WARNING:

When the fail-safe operation occurs, vehicle speed may be gradually reduced. The reduced speed may be lower than other traffic, which could increase the chance of a collision. Be especially careful when driving. If necessary, pull to the side of the road at a safe place and allow the transmission to return to normal operation, or have it repaired if necessary.

DRIVING WITH MANUAL TRANSMISSION (MT)



WARNING:

- **Do not downshift abruptly on slippery roads. This may cause a loss of control.**
- **Do not over-rev the engine when shifting to a lower gear. This may cause a loss of vehicle control or engine damage.**



CAUTION:

- **Do not rest your foot on the clutch pedal while driving. This may damage the clutch system.**
- **Fully depress the clutch pedal before shifting to help prevent transmission damage.**
- **Stop the vehicle completely before shifting into the "R" (Reverse) position.**
- **When the vehicle is stopped for a period of time, for example waiting at stoplights, shift to the "N" (Neutral) position and release the clutch pedal with the foot brake pedal depressed.**
- **Do not shift to the "N" (Neutral) position while driving. Doing so may result in an accident due to loss of engine braking.**

Starting vehicle

1. After starting the engine, depress the clutch pedal to the floor and move the shift lever to the "1" (1st) or "R" (Reverse) position.
2. Slowly depress the accelerator pedal, releasing the clutch pedal and parking brake at the same time.

Shifting gear

To change gears, or when upshifting or downshifting, fully depress the clutch pedal, shift into the appropriate gear, then slowly and smoothly release the clutch pedal.

To ensure smooth gear changes, fully depress the clutch pedal before operating the shift lever. If the clutch pedal is not fully depressed before the transmission is shifted, a gear noise may be heard. Transmission damage could occur.

Start the vehicle in the "1" (1st) position and shift to the "2" (2nd), "3" (3rd), "4" (4th), "5" (5th) and "6" (6th) (if equipped) gear in sequence according to the vehicle speed.

If it is difficult to move the shift lever into the "R" (Reverse) or "1" (1st) position, shift to the "N" (Neutral) position, and then release the clutch pedal once. Fully depress the clutch pedal again and shift into "R" or "1".

5-speed Manual Transmission (MT) model:

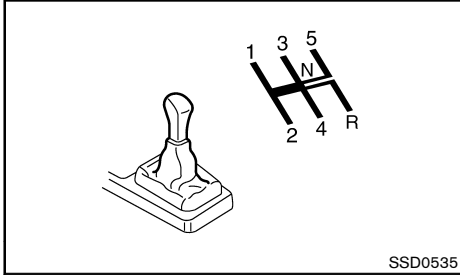

You cannot shift directly from the “5” (5th) position into the “R” (Reverse) position. First shift into the “N” (Neutral) position, then shift into the “R” (Reverse) position.

6-speed Manual Transmission (MT) model:

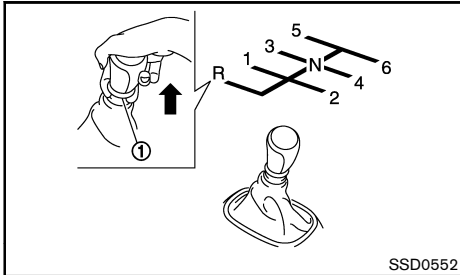

- To back up, stop the vehicle and move the shift lever into the “N” (Neutral) position, and then pull the shift lever ring ① upward to shift into the “R” (Reverse) position.
- The shift lever ring returns to its original position when the shift lever is moved to the “N” (Neutral) position.

Suggested maximum speed in each gear

Downshift to a lower gear if the engine is not running smoothly, or if you need to accelerate.

Do not exceed the maximum suggested speed (shown below) in any gear. For level road driving, use the highest gear suggested for that speed. Always observe posted speed limits, and drive according to the road conditions which will ensure safe operation. Do not over-rev the engine when shifting to a lower gear as it may cause engine damage or loss of vehicle control.

HR15DE engine model (5 MT):

	km/h (MPH)
1st	45 (28)
2nd	82 (51)
3rd	120 (75)
4th	— (—)
5th	— (—)

HR16DE engine model (5 MT):

	km/h (MPH)
1st	44 (27)
2nd	79 (49)
3rd	116 (72)
4th	— (—)
5th	— (—)

MR18DE engine model (6 MT):

	km/h (MPH)
1st	47 (29)
2nd	83 (52)
3rd	120 (75)
4th	— (—)
5th	— (—)
6th	— (—)

PARKING



WARNING:

- Do not stop or park the vehicle over flammable materials such as dry grass, waste paper or rags. They may ignite and cause a fire.
- Safe parking procedures require that both the parking brake be applied and the shift lever placed in the “P” (Park) position (Automatic Transmission (AT) model/Continuously Variable Transmission (CVT) model) or the shift lever placed in an appropriate gear (Manual Transmission model). Failure to do so could cause the vehicle to move unexpectedly or roll away and result in an accident.
- When parking the vehicle, make sure the shift lever is moved to the “P” (Park) position. The shift lever cannot be moved out of the “P” (Park) position without depressing the foot brake pedal. (Automatic Transmission (AT) model/Continuously Variable Transmission (CVT) model)
- Never leave the engine running while the vehicle is unattended.
- Never leave children or adults who would normally require the support of others alone in the vehicle. Pets should not be left alone either. They could unknowingly activate switches or controls and inadvertently become involved in a serious accident and injure themselves. On hot, sunny days, temperatures in a closed vehicle could quickly become high enough to cause severe or possibly fatal illness to people and animals.

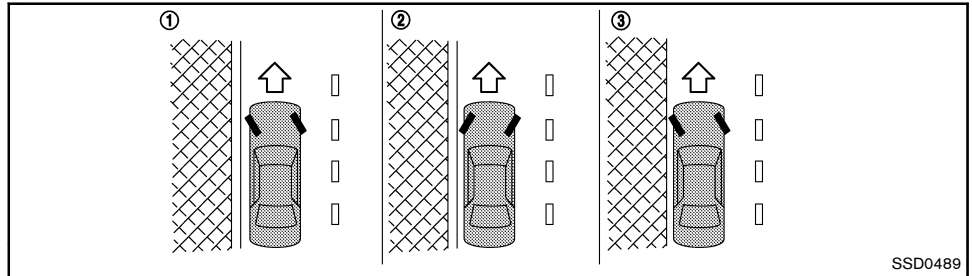

1. Firmly apply the parking brake.
2. Automatic Transmission (AT) model/Continuously Variable Transmission (CVT) model: Move the shift lever to the “P” (Park) position.
Manual Transmission (MT) model: Move the shift lever to the “R” (Reverse) position. When parking on an uphill grade, move the shift lever to the “1” (1st) position.
3. To help prevent the vehicle from moving into traffic when parked on an incline, it is a good practice to turn the wheels as illustrated.

HEADED DOWNHILL WITH CURB ①

Turn the wheels into the curb and move the vehicle forward until the curb side wheel gently touches the curb. Then apply the parking brake.

HEADED UPHILL WITH CURB ②

Turn the wheels away from the curb and allow the vehicle to move back until the curb side wheel gently touches the curb. Then apply the parking brake.

HEADED UPHILL OR DOWNHILL, WITHOUT CURB ③

Turn the wheels toward the side of the road so the

vehicle will move away from the center of the road if the vehicle moves. Then apply the parking brake.

4. Model with Intelligent Key system:

Turn the ignition switch in the “OFF” position.

Model without Intelligent Key system:

Turn the ignition switch in the “LOCK” position and remove the key.

TRAILER TOWING

Your vehicle was designed to be used to carry passengers and luggage. NISSAN does not recommend trailer towing, because it places additional loads on your vehicle's engine, drivetrain, steering, braking and other systems.



CAUTION:

Vehicle damage resulting from towing a trailer is not covered by the warranty.

ELECTRIC POWER STEERING SYSTEM



WARNING:

- **If the engine is not running or is turned off while driving, the power assist for the steering will not work. The steering will be harder to operate.**
- **When the electric power steering warning light illuminates with the engine running, the power assist for the steering will cease operation. You will still have control of the vehicle but the steering will be harder to operate.**

If the engine is not running or is turned off while driving, the power assist for the steering will not work. The steering will be harder to operate.

The electric power steering system is designed to provide power assist while driving to operate the steering wheel with light force.

When the steering wheel is operated repeatedly or continuously while parking or driving at a very low speed, the power assist for the steering wheel will be reduced. This is to prevent overheating of the electric power steering system and protect it from getting damaged. While the power assist is reduced, steering wheel operation will become heavy. When the temperature of the electric power steering system goes down, the power assist level will return to normal. Avoid repeating such steering wheel operations that could cause the electric power steering system to overheat.

You may hear a fricative sound when the steering wheel is operated quickly. However, this is not a malfunction.

If the electric power steering warning light **PS** illuminates while the engine is running, it may indicate the electric power steering system is not functioning

properly and may need servicing. Have the electric power steering system checked by a NISSAN dealer. (See "Electric power steering warning light" (P.2-10).)

When the electric power steering warning light illuminates with the engine running, the power assist for the steering will cease operation. You will still have control of the vehicle. However, greater steering effort is needed, especially in sharp turns and at low speeds.

BRAKE SYSTEM

The brake system has two separate hydraulic circuits. If one circuit malfunctions, you will still have braking ability at two wheels.

BRAKE PRECAUTIONS

Vacuum assisted brakes

The brake booster aids braking by using engine vacuum. If the engine stops, you can stop the vehicle by depressing the foot brake pedal. However, greater foot pressure on the foot brake pedal will be required to stop the vehicle. The stopping distance will be longer.

If the engine is not running or is turned off while driving, the power assisted brakes will not function. Braking will be harder.



WARNING:

Do not coast with the engine stopped.

When the brake pedal is depressed slowly and firmly, you may hear a clicking noise and feel a slight pulsation. This is normal and indicates that the Brake Assist System (if equipped) is operating.

Using brakes

Avoid resting your foot on the foot brake pedal while driving. This will overheat the brakes, wear out the brake linings/pads faster, and increase fuel consumption.

To help reduce brake wear and to prevent the brakes from overheating, reduce speed and downshift to a lower gear before going down a slope or long grade. Overheated brakes may reduce braking performance and could result in loss of vehicle control.

While driving on a slippery surface, be careful when braking, accelerating or downshifting. Abrupt braking

or acceleration could cause the wheels to skid and result in an accident.

Wet brakes

When the vehicle is washed or driven through water, the brakes may get wet. As a result, your braking distance will be longer and the vehicle may pull to one side during braking.

To dry the brakes, drive the vehicle at a safe speed while lightly depressing the foot brake pedal to heat up the brakes. Do this until the brakes return to normal. Avoid driving the vehicle at high speeds until the brakes function correctly.

Parking brake break-in

Break in the parking brake shoes whenever the stopping effect of the parking brake is weakened or whenever the parking brake shoes and/or drums/rotors are replaced, in order to assure the best braking performance.

This procedure is described in the vehicle service manual and can be performed by a NISSAN dealer.

Driving uphill

When starting on a steep grade, it is sometimes difficult to operate both the brake and clutch (for Manual Transmission model). Apply the parking brake to hold the vehicle. Do not slip the clutch. When ready to start, slowly release the parking brake while depressing the accelerator pedal and releasing the clutch pedal.

Driving downhill

The engine braking action is effective for controlling the vehicle while descending hills. For Manual Transmission (MT) model, the shift lever should be placed in the lower speed position prior to descending. For Automatic Transmission (AT) model, the "1" or "2" position should be selected. For Continuously Variable Transmission (CVT) model, the "L" position should be selected.

BRAKE ASSIST (if equipped)

When the force applied to the brake pedal exceeds a certain level, the Brake Assist is activated generating greater braking force than a conventional brake booster even with light pedal force.



WARNING:

The Brake Assist is only an aid to assist braking operation and is not a collision warning or avoidance device. It is the driver's responsibility to stay alert, drive safely and be in control of the vehicle at all times.

ANTI-LOCK BRAKING SYSTEM (if equipped)



WARNING:

- **The Anti-lock Braking System (ABS) is a sophisticated device, but it cannot prevent accidents resulting from careless or dangerous driving techniques. It can help maintain vehicle control during braking on slippery surfaces. Remember that stopping distances on slippery surfaces will be longer than on normal surfaces even with ABS. Stopping distances may also be longer on rough,**

VEHICLE SECURITY

When leaving your vehicle unoccupied:

- Always take the key with you - even when leaving the vehicle in your own garage.
- Close all windows completely and lock all doors.
- Always park your vehicle where it can be seen. Park in a well lit area during the night.
- If the security system is equipped, use it - even for a short period.
- Never leave children or pets in the vehicle unattended.
- Never leave valuables inside the vehicle. Always take valuables with you.
- Never leave the vehicle documents in the vehicle.
- Never leave articles on a roof rack. Remove them from the rack and keep and lock them inside the vehicle.
- Never leave the spare key in the vehicle.

gravel or snow covered roads, or if you are using tire chains. Always maintain a safe distance from the vehicle in front of you. Ultimately, the driver is responsible for safety.

- **Tire type and condition may also affect braking effectiveness.**
 - When replacing tires, install the specified size of tires on all four wheels.
 - When installing a spare tire, make sure that it is the proper size and type as specified on the tire placard. (See “Tire placard” (P.9-7).)
 - For detailed information, see “Tires and wheels” (P.9-5).

The Anti-lock Braking System (ABS) controls the brakes so the wheels do not lock during hard braking or when braking on slippery surfaces. The system detects the rotation speed at each wheel and varies the brake fluid pressure to prevent each wheel from locking and sliding. By preventing each wheel from locking, the system helps the driver maintain steering control and helps to minimize swerving and spinning on slippery surfaces.

Using system

Depress the brake pedal and hold it down. Depress the brake pedal with firm steady pressure, but do not pump the brakes. The ABS will operate to prevent the wheels from locking up. Steer the vehicle to avoid obstacles.



WARNING:

Do not pump the brake pedal. Doing so may result in increased stopping distances.

Self-test feature

The ABS includes electronic sensors, electric pumps, hydraulic solenoids and a computer. The computer has a built-in diagnostic feature that tests the system each time you start the engine and move the vehicle at a low speed in forward or reverse. When the self-test occurs, you may hear a “clunk” noise and/or feel a pulsation in the brake pedal. This is normal and does not indicate a malfunction. If the computer senses a malfunction, it switches the ABS off and illuminates the ABS warning light on the meter. The brake system then operates normally, but without anti-lock assistance.

If the ABS warning light illuminates during the self-test or while driving, have the vehicle checked by a NISSAN dealer.

Normal operation

The ABS operates at speeds above 5 to 10 km/h (3 to 6 MPH). The speed varies according to road conditions.

When the ABS senses that one or more wheels are close to locking up, the actuator rapidly applies and releases hydraulic pressure. This action is similar to pumping the brakes very quickly. You may feel a pulsation in the brake pedal and hear a noise from under the hood or feel a vibration from the actuator when it is operating. This is normal and indicates that the ABS is operating properly. However, the pulsation may indicate that road conditions are hazardous and extra care is required while driving.

COLD WEATHER DRIVING



WARNING:

- **Whatever the condition, drive with caution. Accelerate and decelerate with great care. If accelerating or decelerating too fast, the drive wheels will lose even more traction.**
- **Allow more stopping distance in cold weather driving. Braking should be started sooner than on dry pavement.**
- **Keep at a greater distance from the vehicle in front of you on slippery roads.**
- **Wet ice (0°C, 32°F and freezing rain), very cold snow and ice can be slick and very difficult to drive on. The vehicle will have a lot less traction or grip under these conditions. Try to avoid driving on wet ice until the road is salted or sanded.**
- **Watch for slippery spots (glaring ice). These may appear on an otherwise clear road in shaded areas. If a patch of ice is seen ahead, brake before reaching it. Try not to brake while actually on the ice, and avoid any sudden steering maneuvers.**
- **Snow can trap dangerous exhaust gas under your vehicle. Keep snow clear of the exhaust pipe and from around your vehicle.**

BATTERY

If the battery is not fully charged during extremely cold weather conditions, the battery fluid may freeze and damage the battery. To maintain maximum efficiency, the battery should be checked regularly. For details, see “Battery” (P.8-17) of this manual.

ENGINE COOLANT

If the vehicle is to be left outside without anti-freeze, drain the cooling system, including the engine block. Refill before operating the vehicle. For details, see “Changing engine coolant” (P.8-8) of this manual.

TIRE EQUIPMENT

1. If you have snow tires installed on the front/rear wheels of your vehicle, they should be of the same size, loading range, construction and type (bias, bias-belted or radial) as the rear/front tires.
2. If the vehicle is to be operated in severe winter conditions, snow tires should be installed on all four wheels.
3. For additional traction on icy roads, studded tires may be used. However, some countries, provinces and states prohibit their use. Check local, state and provincial laws before installing studded tires.

Skid and traction capabilities of studded snow tires, on wet or dry surfaces, may be poorer than that of non-studded snow tires.

4. Snow chains may be used if desired. Make sure they are the proper size for the tires on your vehicle and are installed according to the chain manufacturer’s instructions. Use chain tensioners when recommended by the tire chain manufacturer to ensure a tight fit. Loose end links of the tire chains must be secured or removed to prevent the possibility of whipping action damage to the

fenders or underbody. In addition, drive at a reduced speed, otherwise, your vehicle may be damaged and/or vehicle handling and performance may be adversely affected.

SPECIAL WINTER EQUIPMENT

It is recommended that the following items be carried in the vehicle during the winter:

- A scraper and stiff-bristled brush to remove ice and snow from the windows.
- A sturdy, flat board to be placed under the jack to give it firm support.
- A shovel to dig the vehicle out of snowdrifts.

PARKING BRAKE

When parking in the area where the outside temperature is below 0°C (32°F), do not apply the parking brake to prevent it from freezing. For safe parking:

- Place the shift lever in the “P” (Park) position (Automatic Transmission (AT)/Continuously Variable Transmission (CVT) model).
- Place the shift lever in the “1” (1st) or “R” (Reverse) position (Manual Transmission model).
- Securely block the wheels.

CORROSION PROTECTION

Chemicals used for road surface deicing are extremely corrosive and will accelerate corrosion and the deterioration of underbody components such as the exhaust system, fuel and brake lines, brake cables, floor pan and fenders.

In the winter, the underbody must be cleaned periodically. For additional information, see “Corrosion protection” (P.7-5) of this manual.

For additional protection against rust and corrosion, which may be required in some areas, consult a

NISSAN dealer.

6 In case of emergency

Hazard indicator flasher switch	6-2	Jump starting	6-6
Flat tire	6-2	Push starting	6-8
Stopping vehicle	6-2	If your vehicle overheats	6-8
Preparing tools and spare tire	6-3	Towing your vehicle	6-9
Blocking wheels	6-3	Towing precautions	6-9
Removing tire	6-4	Towing recommended by NISSAN	6-9
Installing spare tire	6-5	Freeing trapped vehicle	6-10
Stowing damaged tire and tools	6-6		

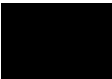

HAZARD INDICATOR FLASHER SWITCH

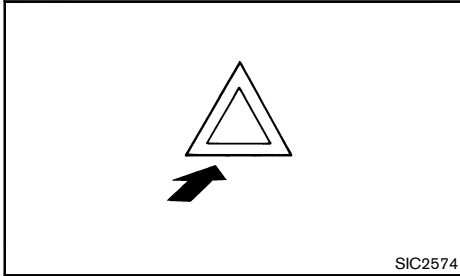

The hazard indicator flasher switch operates with the ignition switch in any position except when the battery is discharged.

The hazard indicator flasher is used to warn other drivers when you have to stop or park under emergency conditions.

When the hazard indicator flasher switch is pushed, all turn signal lights will flash. To turn off the hazard indicator flasher, push the hazard indicator flasher switch again.

FLAT TIRE

If you have a flat tire, follow the instructions as follows.

STOPPING VEHICLE



WARNING:

- **Be sure to apply the parking brake firmly.**
 - **Be sure to move the shift lever to the “P” (Park) position (Automatic Transmission (AT) model/Continuously Variable Transmission (CVT) model) or the shift lever to the “R” (Reverse) position (Manual Transmission model).**
 - **Never change tires when the vehicle is on a slope, ice or slippery area. This is hazardous.**
 - **Never change tires when the oncoming traffic is close to your vehicle. Call for professional road assistance.**
1. Safely move the vehicle off the road away from traffic.
 2. Turn on the hazard indicator flasher lights.
 3. Park on a level surface.
 4. Apply the parking brake.
 5. Automatic Transmission (AT) model/Continuously Variable Transmission (CVT) model: Move the shift lever to the “P” (Park) position.
Manual Transmission (MT) model: Move the shift lever to the “R” (Reverse) position.
 6. Turn off the engine.
 7. Open the hood:
 - To warn other traffic.
 - To signal professional road assistance personnel that you need assistance.

8. Have all passengers get out from the vehicle and stand in a safe place, away from other traffic and clear of the vehicle.

PREPARING TOOLS AND SPARE TIRE

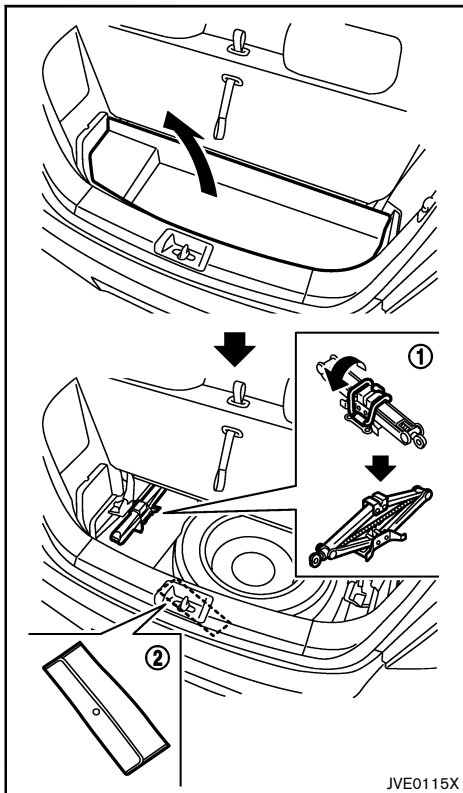

Three-row models

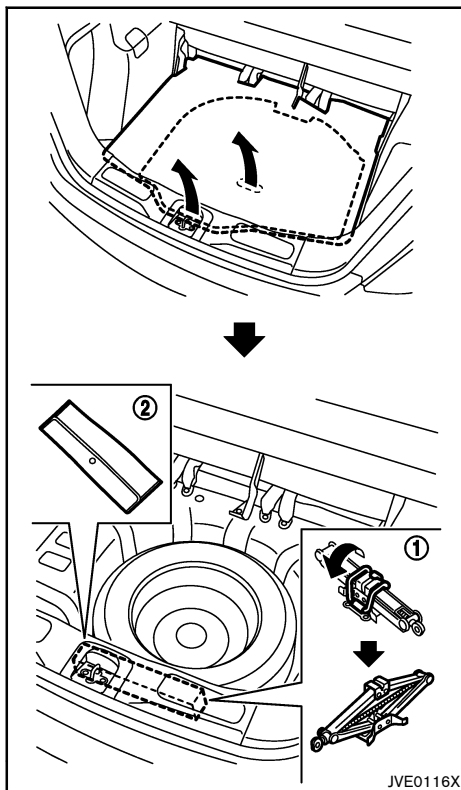

Two-row models

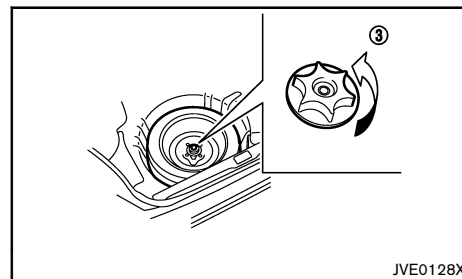

Three-row and two-row models

- ① Jack
- ② Tools
- ③ Clamp

Remove the jack, necessary tools and the spare tire from the storage area located in and under the luggage area floor box (Three-row model) or under the luggage floor mat and board (Two-row model).

To remove the jack, take off the strap. If spacers are equipped, remove them before removing the spare tire.

BLOCKING WHEELS

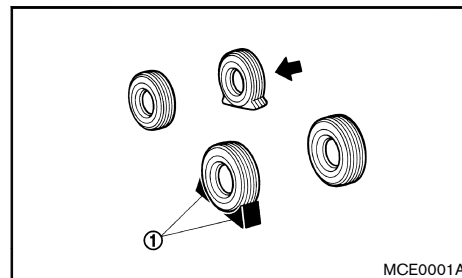



WARNING:

Be sure to block the appropriate wheel to prevent the vehicle from moving, which may cause personal injury.

Place suitable blocks ① at both the front and back of the wheel diagonally opposite the flat tire ← to prevent the vehicle from moving when it is jacked up.

REMOVING TIRE

Removing wheel cover (if equipped)

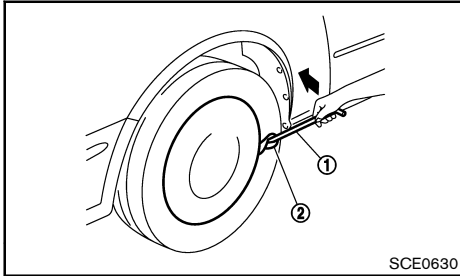

WARNING:

Never use your hands to remove the wheel cover. This may cause personal injury.

To remove the wheel cover, use the jack rod ① as illustrated.

Apply cloth ② between the wheel and jack rod to prevent damaging the wheel and wheel cover.

Jacking up vehicle

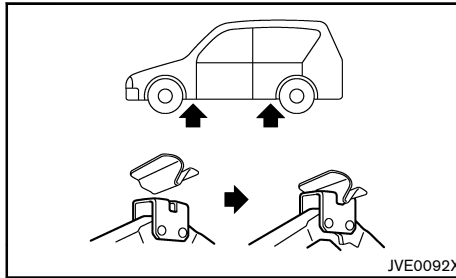

Jack-up points

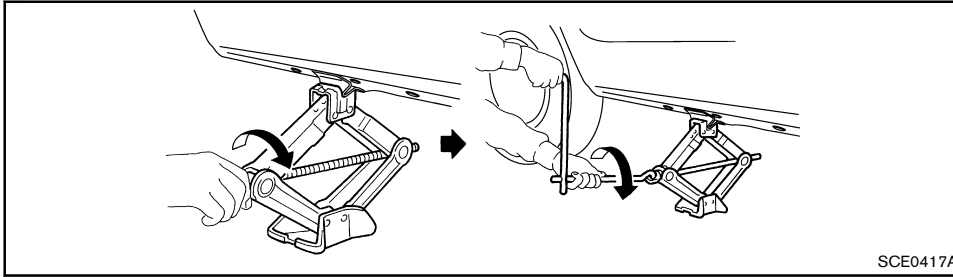

SCE0417A

WARNING:

- Be sure to read and follow the instructions in this section.
- **DO NOT GET UNDER A VEHICLE THAT IS SUPPORTED BY A JACK.**
- Never use a jack which was not provided with your vehicle.
- The jack, which is provided with your vehicle, is designed only to lift your vehicle during a tire change. Do not use the jack provided with your vehicle on other vehicles.
- Never jack up the vehicle at a location other than the jack-up point that is specified.
- Never lift the vehicle more than necessary.
- Never use blocks on or under the jack.
- Never start or run the engine while the vehicle is on the jack. The vehicle may move suddenly, and this may cause an accident.
- Never allow passengers to remain in the vehicle while the tire is off the ground.

- Be sure to read the caution label attached to the jack body before using.
- When jacking up the vehicle, be sure to apply the parking brake.

1. Place the jack directly under the jack-up point as illustrated so that the top of the jack contacts the vehicle at the jack-up point.

The jack should be placed on firm level ground.

2. Align the jack head at the jack-up point of either the front or the rear section.
3. Fit the groove of the jack head into the jack-up point as shown.
4. Loosen each wheel nut, counterclockwise, one or two turns with the wheel nut wrench.

Do not remove the wheel nuts until the tire is off the ground.

5. Carefully raise the vehicle until the clearance between the tire and ground is achieved.
6. To lift the vehicle, securely hold the jack lever and rod with both hands and turn the jack lever.

Removing tire

1. Remove the wheel nuts.
2. Remove the damaged tire.



CAUTION:

The tire is heavy. Be sure that your feet are clear from the tire and use gloves as necessary to avoid injury.

INSTALLING SPARE TIRE

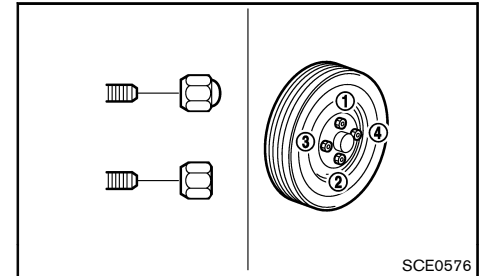

SCE0576



WARNING:

- Never use wheel nuts which are not provided with your vehicle. Incorrect wheel nuts or improperly tightened wheel nuts may cause the wheel to become loose or come off. This could cause an accident.
- Never use oil or grease on the wheel studs or nuts. This may cause the wheel nuts to become loose.

1. Clean any mud or dirt from the surface between the wheel and hub.

2. Carefully put the spare tire on and tighten the wheel nuts with your fingers. Check that all the wheel nuts contact the wheel surface horizontally.
3. Tighten the wheel nuts alternately and evenly in the sequence illustrated (①, ②, ③, ④), more than 2 times with the wheel nut wrench, until they are tight.
4. Lower the vehicle slowly until the tire touches the ground.
5. Tighten the wheel nuts securely, with the wheel nut wrench in the sequence illustrated.
6. Lower the vehicle completely.

Tighten the wheel nuts to the specified torque with a torque wrench as soon as possible.

**Wheel nut tightening torque:
113 N·m (11.5 kg·m, 83 ft·lb)**

The wheel nuts must be kept tightened to specification at all times. It is recommended that the wheel nuts be tightened to specification at each lubrication interval.



WARNING:

Retighten the wheel nuts when the vehicle has been driven for 1,000 km (600 miles). (also in cases of a flat tire, etc.)

STOWING DAMAGED TIRE AND TOOLS



WARNING:

- **Be sure that the tire, jack and tools used are properly stored after use. Such items can become dangerous projectiles in an accident or sudden stop.**
1. Securely store the damaged tire, jack and tools used in the storage area.
 2. Replace the luggage floor mat and board.
 3. Close the back door.

JUMP STARTING



WARNING:

- **Incorrect jump starting can lead to a battery explosion. The battery explosion may result in severe injury or death. It may also result in damage to the vehicle. Be sure to follow the instructions in this section.**
- **Explosive hydrogen gas is always present in the vicinity of the battery. Keep all sparks and flames away from the battery.**
- **Always wear suitable eye protection and remove rings, bracelets, and any other jewelry whenever working on or near a battery.**
- **Never lean over the battery while jump starting.**
- **Never allow battery fluid to come into contact with eyes, skin, clothes or the vehicle's painted surfaces. Battery fluid is a corrosive sulfuric acid which can cause severe burns. If the fluid comes into contact with anything, immediately flush the contacted area with plenty of water.**
- **Keep the battery out of the reach of children.**
- **The booster battery must be rated at 12 volts. Use of an incorrectly rated battery will damage your vehicle.**
- **Never attempt to jump start a frozen battery. It could explode and cause serious injury.**

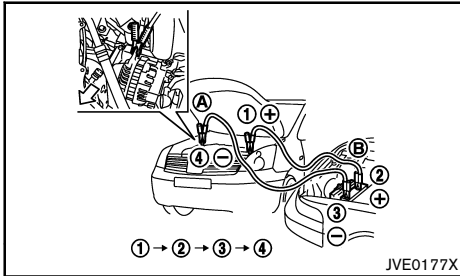

HR15DE engine

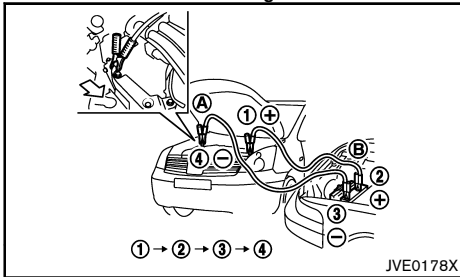

HR16DE engine

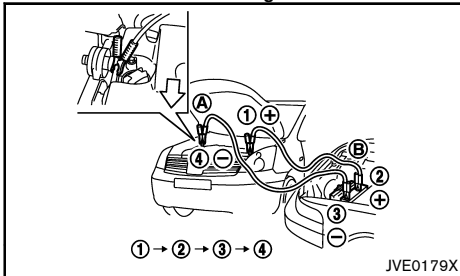

MR18DE engine

1. If the booster battery is in another vehicle (B), position the two vehicles (A) and (B) to bring the batteries into close proximity to each other.



CAUTION:

If the battery of vehicle (A) equipped with the Intelligent Key system is discharged, the ignition switch cannot be moved from the "LOCK" position and, if the steering lock is engaged, the steering wheel cannot be moved. Connect the jumper cables to the booster vehicle (B) before turning the ignition switch and disengaging the steering lock.

2. Apply the parking brake.
3. Automatic Transmission (AT) model/Continuously Variable Transmission (CVT) model: Move the shift lever to the "P" (Park) position.
Manual Transmission (MT) model: Move the shift lever to the "N" (Neutral) position.
4. Switch off all unnecessary electrical systems (headlights, heater, air conditioner, etc.).
5. Turn the ignition switch to the "LOCK" position.
6. Remove the vent caps, if equipped, on the battery.
7. Cover the battery with a firmly wrung out moist cloth to reduce the hazard of an explosion.
8. Connect the jumper cables in the sequence as illustrated (1, 2, 3, 4).



CAUTION:

- Always connect positive ⊕ to positive ⊕ and negative ⊖ to body ground, NOT to the battery's negative ⊖.

- Be sure that the jumper cables do not touch moving parts in the engine compartment.
- Be sure that the jumper cable's clamps do not contact any other metal.

9. Start the engine of the booster vehicle (B) and let it run for a few minutes.
10. Depress the accelerator pedal of the booster vehicle (B) at about 2,000 rpm.
11. Start the engine of the jumped vehicle (A) in the normal manner.

For Intelligent Key system equipped models, use the mechanical key to start the engine.



CAUTION:

Never keep the starter motor engaged for more than 10 seconds. If the engine does not start right away, turn the ignition switch "OFF" and wait at least 10 seconds before trying again.

12. After the engine is started, carefully disconnect the jumper cables in the opposite sequence from that illustrated (4, 3, 2, 1).
13. Remove and dispose of the cloth as it may be contaminated with corrosive acid.
14. Replace the vent caps, if removed.

PUSH STARTING

Do not attempt to start the engine by pushing the vehicle.



CAUTION:

- **Automatic Transmission (AT)/Continuously Variable Transmission (CVT) model/Manual Transmission (MT) model cannot be started by pushing. Attempting to do so may cause damage to the transmission.**
- **Three-way catalyst equipped model should not be started by pushing. Attempting to do so may cause damage to the three-way catalyst.**
- **Never try to start the engine by towing. When the engine starts, the forward surge could cause the vehicle to collide with the towing vehicle.**

IF YOUR VEHICLE OVERHEATS



WARNING:

- **Never continue driving if your vehicle overheats. Doing so could cause a vehicle fire.**
- **Never open the hood if steam is coming out.**
- **Never remove the radiator cap while the engine is hot. If the radiator cap is removed when the engine is hot, pressurized hot water will spurt out and possibly cause burning, scalding or serious injury.**
- **If steam or coolant is coming from the engine, stand clear of the vehicle to prevent getting burned.**
- **The engine cooling fan will start at anytime when the coolant temperature exceeds pre-set degrees.**
- **Be careful not to allow your hands, hair, jewelry or clothing to come into contact with, or to get caught in the cooling fan or drive belts.**

If your vehicle is overheating (indicated by the high temperature indicator), or if you feel a lack of engine power, detect unusual noise, etc., take the following steps:

1. Safely move the vehicle off the road away from traffic.
2. Turn on the hazard indicator flasher lights.
3. Apply the parking brake.
4. Automatic Transmission (AT)/Continuously Variable Transmission (CVT) model: Move the shift lever to the "P" (Park) position.
Manual Transmission (MT) model: Move the shift lever to the "N" (Neutral) position.

DO NOT STOP THE ENGINE.

5. Open all windows.
6. Turn off the air conditioner. Set the temperature control to maximum hot and fan control to maximum speed.
7. Get out from the vehicle.
8. Visually inspect and listen for steam or coolant escaping from the radiator before opening the hood. Wait until no steam or coolant can be seen before proceeding.
9. Open the engine hood.
10. Visually inspect if the cooling fan is running.
11. Visually inspect the radiator and radiator hoses for leakage. If the cooling fan is not running or the coolant is leaking, stop the engine.
12. After the engine cools down, check the coolant level in the reservoir with the engine running. **Do not open the radiator cap.**
13. Add coolant to the reservoir if necessary.

Have your vehicle inspected/repared at a NISSAN dealer.

TOWING YOUR VEHICLE

When towing your vehicle, local regulations for towing must be followed. Incorrect towing equipment could damage your vehicle. To assure proper towing and to prevent accidental damage to your vehicle, NISSAN recommends that you have professional road assistance personnel tow your vehicle. It is advisable to have the professional road assistant carefully read the following precautions.

TOWING PRECAUTIONS

- Be sure that the transmission, steering system and powertrain are in working condition before towing. If any units are damaged, the vehicle must be towed using a dolly or flatbed tow truck.
- NISSAN recommends that your vehicle be towed with the driving wheels off the ground.
- Always attach safety chains before towing.

TOWING RECOMMENDED BY NISSAN

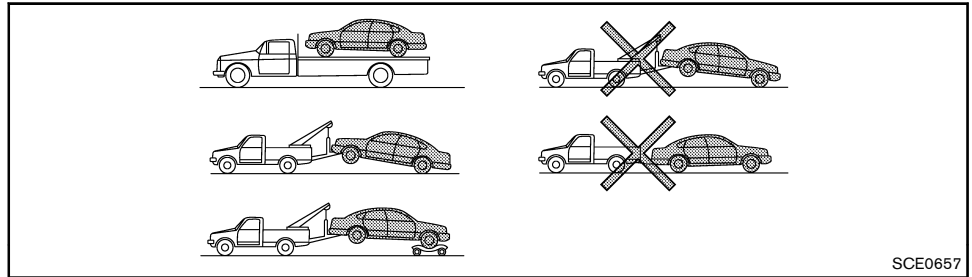

NISSAN recommends that towing dollies be used under the front wheels when towing your vehicle or the vehicle be placed on a flatbed tow truck as illustrated.

Front wheels on the ground



CAUTION:

Never tow Automatic Transmission (AT)/Continuously Variable Transmission (CVT) model with the front wheels on the ground. Doing so will cause serious and expensive damage to the drivetrain.

Manual Transmission (MT) model:

1. Turn the ignition switch to the "OFF" position.
2. Secure the steering wheel in a straight-ahead position with rope or a similar device.
3. Move the shift lever to the "N" (Neutral) position.
4. Release the parking brake.
5. Attach the safety chains whenever towing.

Rear wheels on the ground

1. Turn the ignition switch to the "OFF" position.
2. Secure the steering wheel in a straight-ahead position with rope or a similar device.
3. Move the shift lever to the "N" (Neutral) position.
4. Release the parking brake.
5. Attach safety chains whenever towing.

All four wheels on the ground



CAUTION:

Never tow Automatic Transmission (AT)/Continuously Variable Transmission (CVT) model with all four wheels on the ground. Doing so will cause serious and expensive damage to the transmission.

Manual Transmission (MT) model:

1. Turn the ignition switch to the "OFF" position.
2. Move the shift lever to the "N" (Neutral) position.

3. Release the parking brake.

FREEING TRAPPED VEHICLE

WARNING:

- Never allow anyone to stand near the towing line during the pulling operation.
- Never spin the tires at high speed. This could cause them to explode and result in serious injury. Parts of the vehicle could also over-heat and be damaged.
- Except for Indonesia: Do not pull the vehicle using the rear hook. The rear hook is not designed to pull the vehicle out in the event that the vehicle becomes trapped.

In the event that your vehicle's tires become trapped in sand, snow, or mud, and the vehicle is unable to free itself without being pulled, use the recovery hooks.

- Use the recovery hooks only. Do not attach the pulling device to any other part of the vehicle body. Otherwise, the vehicle body may be damaged.
- Use the recovery hooks to free a vehicle only.
- The recovery hooks are under tremendous stress when used to free a trapped vehicle. Always pull the pulling device straight out from the vehicle. Never pull on the recovery hooks at an angle.

Front

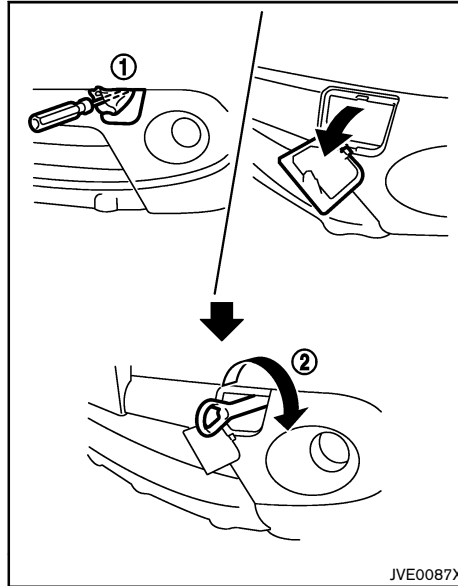

Type A

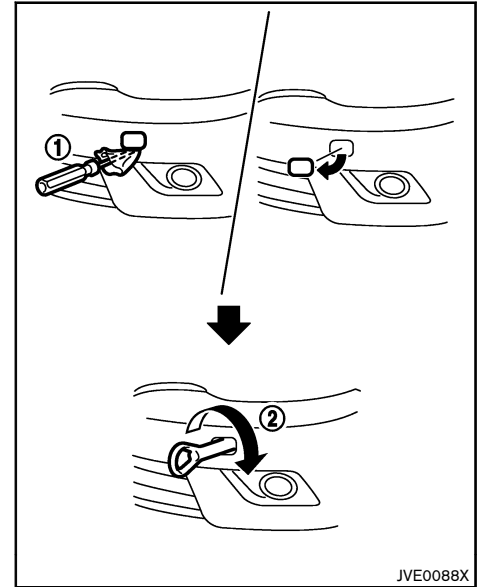

Type B

- ① Remove the hook cover from the bumper using a suitable tool wrapped with a cloth.
- ② Securely install the recovery hook as illustrated. (The hook is stored with the jacking tools.)

Make sure that the recovery hook is properly secured in its storage area after use.

Rear (except for indonesia)

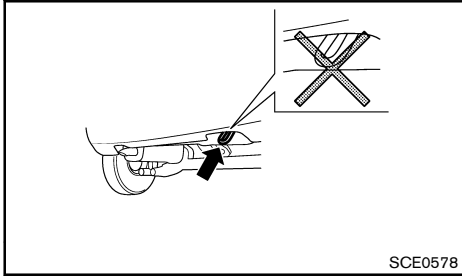

Do not use the hook to tow the vehicle.

MEMO

7 Appearance and care

Cleaning exterior	7-2	Cleaning interior	7-3
Washing	7-2	Air fresheners	7-4
Removing spots	7-2	Floor mats	7-4
Waxing	7-2	Glass	7-4
Glass	7-2	Seat belts	7-4
Underbody	7-3	Corrosion protection	7-5
Wheels	7-3	Most common factors contributing to vehicle corrosion	7-5
Aluminum alloy wheels	7-3	Environmental factors influence rate of corrosion	7-5
Chrome parts	7-3	To protect your vehicle from corrosion	7-5



CLEANING EXTERIOR

In order to maintain the appearance of your vehicle, it is important to take proper care of it.

Whenever possible, park your vehicle inside a garage or in a covered area to minimize the chances of damaging the paint surface of your vehicle.

When it is necessary to park outside, park in a shady area or protect the vehicle with a body cover. **Be careful not to scratch the paint surface when putting on or removing the body cover.**

WASHING

In the following instances, wash your vehicle as soon as possible to protect the paint surface:

- After a rainfall, which may cause the paint surface damage from acid rain.
 - After driving on coastal roads, which may cause rusting from the sea breeze.
 - When contaminants such as soot, bird droppings, tree sap, metal particles or bugs get on the paint surface.
 - When dust or mud builds up on the paint surface.
1. Wash the vehicle surface with a wet sponge and plenty of water.
 2. Clean the vehicle surface gently and thoroughly using a mild soap, a special vehicle soap or a general purpose dishwashing liquid mixed with clean, lukewarm (never hot) water.



CAUTION:

- **Do not wash the vehicle with strong household soap, strong chemical detergents, gasoline or solvents.**
- **Do not wash the vehicle in direct sunlight or while the vehicle body is hot, as the paint surface may become water-spotted.**

- **Avoid using tight-napped or rough cloths, such as washing mitts. Care must be taken when removing caked-on dirt or other foreign substances so the paint surface is not scratched or damaged.**
3. Rinse the vehicle thoroughly with plenty of clean water.
 4. Use a dampened chamois to dry the paint surface and avoid leaving water spots.

When washing the vehicle, take care of the following:

- Inside flanges, joints and folds on the doors, hatches and hood are particularly vulnerable to the effects of road salt. Therefore, these areas must be cleaned regularly.
- Be sure that the drain holes in the lower edge of the doors are not clogged.
- Spray water to the underbody and in the wheel wells to loosen the dirt and/or wash away road salt.

REMOVING SPOTS

Remove tar and oil spots, industrial dust, insects, and tree sap as quickly as possible from the paint surface to avoid lasting damage or staining. Special cleaning products are available at a NISSAN dealer or any automotive accessory store.

WAXING

Regular waxing protects the paint surface and helps maintain a new vehicle appearance.

After waxing, polishing is recommended to remove built-up residue and to avoid a weathered appearance.

A NISSAN dealer can assist you in choosing the appropriate waxing products.



CAUTION:

- **Wash your vehicle thoroughly and completely before applying wax to the paint surface.**
- **Always follow the manufacturer's instructions supplied with the wax.**
- **Do not use a wax containing any abrasives, cutting compounds or cleaners that may damage the vehicle finish.**

Machine compounding or aggressive polishing on a base coat/clear coat paint finish may dull the finish or leave swirl marks.

GLASS

Use glass cleaner to remove smoke and dust film from the glass surfaces. It is normal for glass to become coated with a film after the vehicle is parked in the hot sun. Glass cleaner and a soft cloth will easily remove this film.

UNDERBODY

In areas where road salt is used in the winter, it is necessary to clean the vehicle's underbody regularly in order to prevent dirt and salt from building up and causing the acceleration of corrosion on the underbody and suspension.

Before the winter and again in the spring, the underseal must be checked and, if necessary, re-treated.

WHEELS

- Wash the wheels when washing the vehicle to maintain their appearance.
- Clean the inner side of the wheels when the wheel is changed or the underside of the vehicle is washed.
- Do not use abrasive cleaners when washing the wheels.
- Inspect wheel rims regularly for dents or corrosion. This may cause loss of pressure or damage the tire bead.
- NISSAN recommends that the road wheels be waxed to protect against road salt in areas where it is used during winter.

ALUMINUM ALLOY WHEELS

Wash the wheels regularly with a sponge dampened in a mild soap solution, especially during winter in areas where road salt is used. The salt residue from road salt could discolor the wheels if it is not washed off regularly.



CAUTION:

Follow the directions below to avoid staining or discoloring the wheels:

- **Do not use a cleaner that uses strong acid or alkali contents to clean the wheels.**
- **Do not apply wheel cleaners to the wheels when they are hot. The wheel temperature should be the same as ambient temperature.**
- **Rinse the wheel to completely remove the cleaner within 15 minutes after the cleaner is applied.**

CHROME PARTS

Clean all chrome parts regularly with a nonabrasive chrome polish to maintain the finish.

CLEANING INTERIOR

Occasionally remove loose dust from the interior trim, plastic parts and seats using a vacuum cleaner or soft bristled brush. Wipe the vinyl and leather surfaces with a clean, soft cloth dampened in mild soap solution, then wipe clean with a dry, soft cloth.

Regular care and cleaning is required in order to maintain the appearance of the leather.

Before using any fabric protector, read the manufacturer's recommendations. Some fabric protectors contain chemicals that may stain or bleach the seat material.

Use a soft cloth dampened only with water to clean the meter and gauge lens covers.



CAUTION:

- **Never use benzine, thinner or any similar material.**
- **Small dirt particles can be abrasive and damaging to leather surfaces and should be removed promptly. Do not use saddle soap, car waxes, polishes, oils, cleaning fluids, solvents, detergents or ammonia-based cleaners as they may damage the leather natural finish.**
- **Never use fabric protectors unless recommended by the manufacturer.**
- **Do not use glass or plastic cleaner on meter or gauge lens covers. It may damage the lens covers.**

AIR FRESHENERS

Most air fresheners use a solvent that could affect the vehicle interior. If you use an air freshener, take the following precautions:

- Hanging-type air fresheners can cause permanent discoloration when they contact vehicle interior surfaces. Place the air freshener in a location that allows it to hang free and not contact an interior surface.
- Liquid-type air fresheners typically clip on the vents. These products can cause immediate damage and discoloration when spilled on interior surfaces.

Carefully read and follow the manufacturer's instructions before using air fresheners.

FLOOR MATS

The use of genuine NISSAN floor mats (if equipped) can extend the life of your vehicle carpet and make it easier to clean the interior. Regardless of what mats are used, be sure they are fitted for your vehicle and are properly positioned in the foot well to prevent interference with pedal operation. Mats should be maintained with regular cleaning and replaced if they become excessively worn.

Floor mat positioning aid (driver's side)

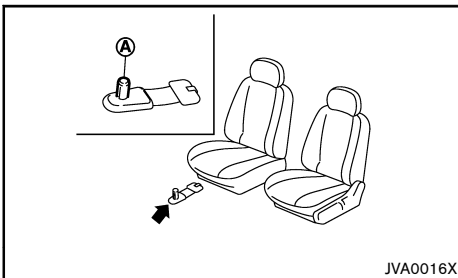

This vehicle includes a front floor mat bracket (A) to act as a floor mat positioning aid. NISSAN floor mats have been specially designed for your vehicle model. The driver's floor mat has a grommet hole incorporated in it.

Position the mat by placing the floor mat bracket hook through the floor mat grommet hole while centering the mat in the foot area.

Periodically check that the mats are properly positioned.

GLASS

Use glass cleaner to remove smoke and dust film from the glass surfaces. It is normal for glass to become coated with a film after the vehicle is parked in the hot sun. Glass cleaner and a soft cloth will easily remove this film.



CAUTION:

When cleaning the inside of the windows, do not use sharp-edged tools, abrasive cleaners or chlorine-based disinfectant cleaners. They could damage the electrical conductors, such as rear

window defogger elements.

SEAT BELTS



WARNING:

- **Do not allow wet seat belts to roll up in the retractor.**
- **Never use bleach, dye or chemical solvents to clean the seat belts, since these materials may severely weaken the seat belt webbing.**

The seat belts can be cleaned by wiping them with a sponge dampened in a mild soap solution.

Allow the belts to dry completely in the shade before using them. (See "Seat belts" (P.1-11).)

CORROSION PROTECTION

MOST COMMON FACTORS CONTRIBUTING TO VEHICLE CORROSION

- The accumulation of moisture-retaining dirt and debris in body panel sections, cavities, and other areas.
- Damage to the paint surface and other protective coatings caused by gravel and stone chips or minor traffic accidents.

ENVIRONMENTAL FACTORS INFLUENCE RATE OF CORROSION

Moisture

The accumulation of sand, dirt and water on the inside floor of the vehicle can accelerate corrosion. Wet floor carpet/floor mats will not dry completely inside the vehicle. They should be removed and completely dried to avoid floor panel corrosion.

Relative humidity

Corrosion will be accelerated in areas of high relative humidity.

Temperature

High temperatures accelerate the rate of corrosion to those parts which are not well ventilated.

Corrosion will also be accelerated in areas where the temperatures stay above freezing.

Air pollution

Industrial pollution, the presence of salt in the air in coastal areas, or heavy road salt use accelerates the corrosion process. Road salt also accelerates the disintegration of paint surfaces.

TO PROTECT YOUR VEHICLE FROM CORROSION

- Wash and wax your vehicle often to keep the vehicle clean.
- Always check for minor damage to the paint surface and if any exists, repair it as soon as possible.
- Keep the drain holes in the lower edge of the doors open to avoid water accumulation.
- Check the vehicle underbody for accumulation of sand, dirt or salt. If present, wash with water as soon as possible.



CAUTION:

- **Never remove dirt, sand or other debris from the passenger compartment by washing it out with a hose. Remove dirt with a vacuum cleaner or broom.**
- **Never allow water or other liquids to come in contact with electronic components inside the vehicle as this may damage them.**

Chemicals used for road surface deicing are extremely corrosive. They accelerate corrosion and deterioration of underbody components such as the exhaust system, fuel and brake lines, brake cables, floor pan and fenders.

In the winter, the underbody must be cleaned periodically.

For additional protection against rust and corrosion, which may be required in some areas, consult a NISSAN dealer.

MEMO

8 Maintenance and do-it-yourself

Maintenance requirements	8-2	Continuously Variable Transmission (CVT) fluid (if equipped)	8-14
Scheduled maintenance	8-2	Air cleaner filter	8-14
General maintenance	8-2	Wiper blades	8-15
Where to go for service	8-2	Windshield wiper blades	8-15
General maintenance	8-2	Rear window wiper blade	8-16
Explanation of general maintenance items	8-2	Window washer fluid	8-16
Maintenance precautions	8-4	Battery	8-17
Engine compartment check locations	8-5	Vehicle battery	8-17
HR15DE engine model	8-5	Remote controller battery	8-18
HR16DE engine model	8-6	Intelligent Key battery	8-19
MR18DE engine model	8-7	Fuses	8-20
Engine cooling system	8-7	Engine compartment	8-20
Checking engine coolant level	8-8	Passenger compartment	8-21
Changing engine coolant	8-8	Lights	8-21
Engine oil	8-8	Headlights	8-21
Checking engine oil level	8-8	Exterior lights	8-22
Changing engine oil and oil filter	8-9	Interior lights	8-22
Protect environment	8-10	Light locations	8-23
Drive belts	8-10	Tires and wheels	8-24
Spark plugs	8-11	Tire inflation pressure	8-24
Platinum-tipped spark plugs	8-11	Types of tires	8-24
Brakes	8-11	Tire chains	8-25
Checking parking brake	8-11	Tire rotation	8-25
Checking foot brake pedal	8-11	Tire wear and damage	8-25
Brake booster	8-12	Tire age	8-26
Brake and clutch (if equipped) fluid	8-12	Changing tires and wheels	8-26
Automatic Transmission Fluid (ATF) (if equipped)	8-13	Wheel balance	8-26
Checking fluid level	8-13	Spare tire	8-26

MAINTENANCE REQUIREMENTS

Some day-to-day and regular maintenance is essential to maintain your vehicle's good mechanical condition, as well as its emission and engine performance.

It is the owner's responsibility to make sure that the specified maintenance, as well as general maintenance, is performed.

As the vehicle owner, you are the only one who can ensure that your vehicle receives the proper maintenance care.

SCHEDULED MAINTENANCE

For your convenience, the required scheduled maintenance items are described and listed in a separate Warranty Information and Maintenance Booklet. You must refer to that booklet to ensure that necessary maintenance is performed on your vehicle at regular intervals.

GENERAL MAINTENANCE

General maintenance includes those items which should be checked during normal day-to-day operation of the vehicle. They are essential if your vehicle is to continue to operate properly. It is your responsibility to perform these procedures regularly as prescribed.

Performing general maintenance checks requires minimal mechanical skill and a few general automotive tools.

These checks or inspections can be done by yourself, a qualified technician, or if you prefer, a NISSAN dealer.

WHERE TO GO FOR SERVICE

If maintenance service is required or your vehicle appears to malfunction, have the systems checked and tuned by an authorised NISSAN dealer.

GENERAL MAINTENANCE

During normal day-to-day operation of the vehicle, general maintenance should be performed regularly as prescribed in this section. If you detect any unusual sounds, vibrations or smells, be sure to check for the cause or have a NISSAN dealer do it promptly. In addition, you should notify a NISSAN dealer if you think that repairs are required.

When performing any checks or maintenance work, closely observe "Maintenance precautions" (P.8-4).

EXPLANATION OF GENERAL MAINTENANCE ITEMS

Additional information on the following items with "*" is found later in this section.

Outside vehicle

The maintenance items listed here should be performed from time to time, unless otherwise specified.

Doors and hood:

Check that all doors and the hood operate smoothly as well as the back door, trunk lid and hatch. Also make sure that all latches lock securely. Lubricate if necessary. Make sure that the secondary latch keeps the hood from opening when the primary latch is released. When driving in areas using road salt or other corrosive materials, check lubrication frequently.

Lights*:

Clean the headlights on a regular basis. Make sure that the headlights, stop lights, tail lights, turn signal lights, and other lights are all operating properly and installed securely. Also check the aim of the headlights.

Tires*:

Check the pressure with a gauge often and always prior to long distance trips. Adjust the pressure in all tires, including the spare, to the pressure specified. Check carefully for damage, cuts or excessive wear.

Tire rotation*:

In the case that Two-Wheel Drive (2WD) and front & rear tires are same size; Tires should be rotated every 10,000 km (6,000 miles). Tires marked with directional indicators can only be rotated between front and rear. Make sure that the directional indicators point in the direction of wheel rotation after the tire rotation is completed.

In the case that Four-Wheel Drive (4WD) and front & rear tires are same size; Tires should be rotated every 5,000 km (3,000 miles). Tires marked with directional indicators can only be rotated between front and rear. Make sure that the directional indicators point in the direction of wheel rotation after the tire rotation is completed.

In the case that front tires are different size from rear tires; Tires cannot be rotated.

However, the timing for tire rotation may vary according to your driving habits and the road surface conditions.

Tire Pressure Monitoring System (TPMS) transmitter components (if equipped):

Replace the TPMS transmitter grommet seal, valve core and cap when the tires are replaced due to wear or age.

Wheel alignment and balance:

If the vehicle should pull to either side while driving on a straight and level road, or if you detect uneven or abnormal tire wear, there may be a need for wheel alignment. If the steering wheel or seat vibrates at normal highway speeds, wheel balancing may be

needed.

Windshield:

Clean the windshield on a regular basis. Check the windshield at least every six months for cracks or other damage. Repair as necessary.

Wiper blades*:

Check for cracks or wear if not functioning correctly.

Inside vehicle

The maintenance items listed here should be checked on a regular basis, such as when performing periodic maintenance, cleaning the vehicle, etc.

Accelerator pedal:

Check the pedal for smooth operation and make sure that the pedal does not catch or require uneven effort. Keep the floor mats away from the pedal.

Brake pedal*:

Check the pedal for smooth operation and make sure that it is the proper distance from the floor mat when depressed fully. Check the brake booster function. Be sure to keep the floor mats away from the pedal.

Parking brake*:

Check the parking brake operation regularly. Check that the lever (if equipped) or the pedal (if equipped) has the proper travel. Also make sure that the vehicle is held securely on a fairly steep hill when only the parking brake is applied.

Seat belts:

Check that all parts of the seat belt system (for example, buckles, anchors, adjusters and retractors) operate properly and smoothly, and are installed securely. Check the belt webbing for cuts, fraying, wear or damage.

Steering wheel:

Check for changes in the steering condition, such as excessive play, hard steering or strange noises.

Warning lights and chimes:

Make sure that all warning lights and chimes are operating properly.

Windshield defogger:

Check that the air comes out of the defogger outlets properly and in good quantity when operating the heater or air conditioner.

Windshield wiper and washer*:

Check that the wipers and washer operate properly and that the wipers do not streak.

Under hood and vehicle

The maintenance items listed here should be checked periodically (for example, each time you check the engine oil or refuel).

Battery*:

Except for maintenance free battery, check the fluid level in each cell. It should be between the "UPPER" and "LOWER" lines. Vehicles operated in high temperatures or under severe conditions require frequent checks of the battery fluid level.

Brake (and clutch) fluid level(s)*:

For Manual Transmission (MT) model; make sure that the brake and clutch fluid levels are between the "MAX" and "MIN" lines on the reservoirs.

Except for Manual Transmission (MT) model; make sure that the brake fluid level is between the "MAX" and "MIN" lines on the reservoir.

Coolant level*:

Check the coolant level when the coolant is cold. Make sure that the coolant level is between the “MAX” and “MIN” lines on the reservoir.

Engine drive belt(s)*:

Make sure that drive belt(s) is/are not frayed, worn, cracked or oily.

Engine oil level*:

Check the level after parking the vehicle (on a level ground) and turning off the engine.

Fluid leaks:

Check under the vehicle for fuel, oil, water or other fluid leaks after the vehicle has been parked for a while. Water dripping from the air conditioner after use is normal. If you should notice any leaks or if fuel fumes are evident, check for cause and have it corrected immediately.

Windshield washer fluid*:

Check that there is adequate fluid in the reservoir.

MAINTENANCE PRECAUTIONS

When performing any inspection or maintenance work on your vehicle, always take care to prevent serious accidental injury to yourself or damage to the vehicle. The following are general precautions which should be closely observed.



WARNING:

- **Park the vehicle on a level surface, apply the parking brake securely and block the wheels to prevent the vehicle from moving. Move the shift lever to the “P” (Park) position. (Automatic Transmission model/Continuously variable transmission model) or the**

shift lever to the “N” (Neutral) position (Manual transmission model).

- **Be sure the ignition switch is in the “OFF” or “LOCK” position when performing any parts replacement or repairs.**
- **Do not work under the hood while the engine is hot. Always turn off the engine and wait until it cools down.**
- **If you must work with the engine running, keep your hands, clothing, hair and tools away from moving fans, belts and any other moving parts.**
- **It is advisable to secure or remove any loose clothing and any jewelry, such as rings, watches, etc. before working on your vehicle.**
- **If you must run the engine in an enclosed space such as a garage, be sure there is proper ventilation for exhaust gases to escape.**
- **Never get under the vehicle while it is supported by a jack.**
- **Keep smoking materials, flame and sparks away from fuel and the battery.**
- **Never connect or disconnect either the battery or any transistorized component connector while the ignition switch is in the “ON” position.**
- **On gasoline engine models with the Multiport Fuel Injection (MFI) system, the fuel filter and fuel lines should be serviced by a NISSAN dealer because the fuel lines are under high pressure even when the engine is turned off.**

- **Your vehicle is equipped with an automatic engine cooling fan. It may come on at any time without warning, even if the ignition switch is in the “OFF” position and the engine is not running. To avoid injury, always disconnect the negative battery cable before working near the fan.**
- **Always wear eye protection whenever you work on your vehicle.**
- **Never leave the engine or the transmission related component harness connector disconnected while the ignition switch is in the “ON” position.**
- **Avoid direct contact with used engine oil and coolant. Improperly disposed engine oil, engine coolant, and/or other vehicle fluids can hurt the environment. Always conform to local regulations for disposal of vehicle fluids.**

This “8. Maintenance and do-it-yourself” section provides instructions regarding only those items which are relatively easy for an owner to perform.

You should be aware that incomplete or improper servicing may result in operating difficulties or excessive emissions, and could affect your warranty coverage. **If in doubt about any servicing, have it done by a NISSAN dealer.**

ENGINE COMPARTMENT CHECK LOCATIONS

HR15DE ENGINE MODEL

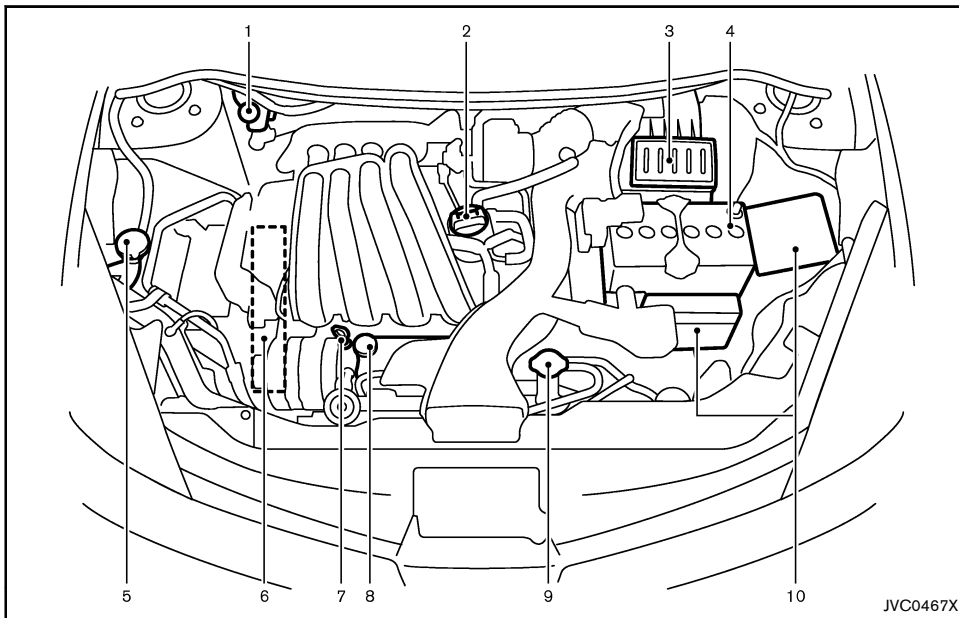

- | | |
|--------------------------------------|---------------------------------------|
| 1. Brake and clutch* fluid reservoir | 8. Engine coolant reservoir |
| 2. Engine oil filler cap | 9. Radiator cap |
| 3. Air cleaner | 10. Fuse/fusible link box |
| 4. Battery | *: For Manual Transmission (MT) model |
| 5. Window washer fluid reservoir | |
| 6. Engine drive belts | |
| 7. Engine oil dipstick | |

HR16DE ENGINE MODEL

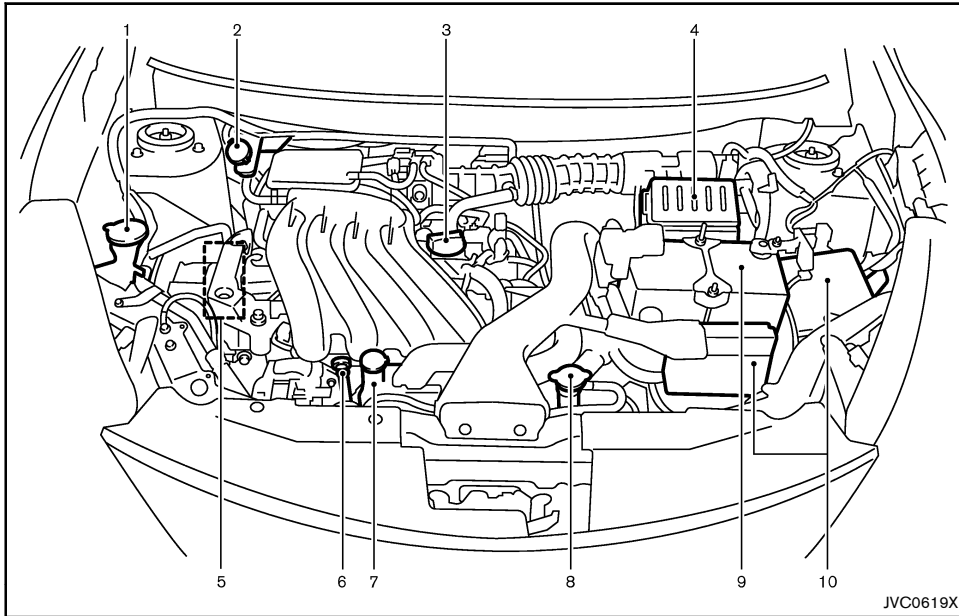

- | | |
|--------------------------------------|---------------------------------------|
| 1. Window washer fluid reservoir | 9. Battery |
| 2. Brake and clutch fluid* reservoir | 10. Fuse/fusible link holder |
| 3. Engine oil filler cap | |
| 4. Air cleaner | *: For Manual Transmission (MT) model |
| 5. Engine drive belt location | |
| 6. Engine oil dipstick | |
| 7. Engine coolant reservoir | |
| 8. Radiator cap | |

ENGINE COOLING SYSTEM

MR18DE ENGINE MODEL

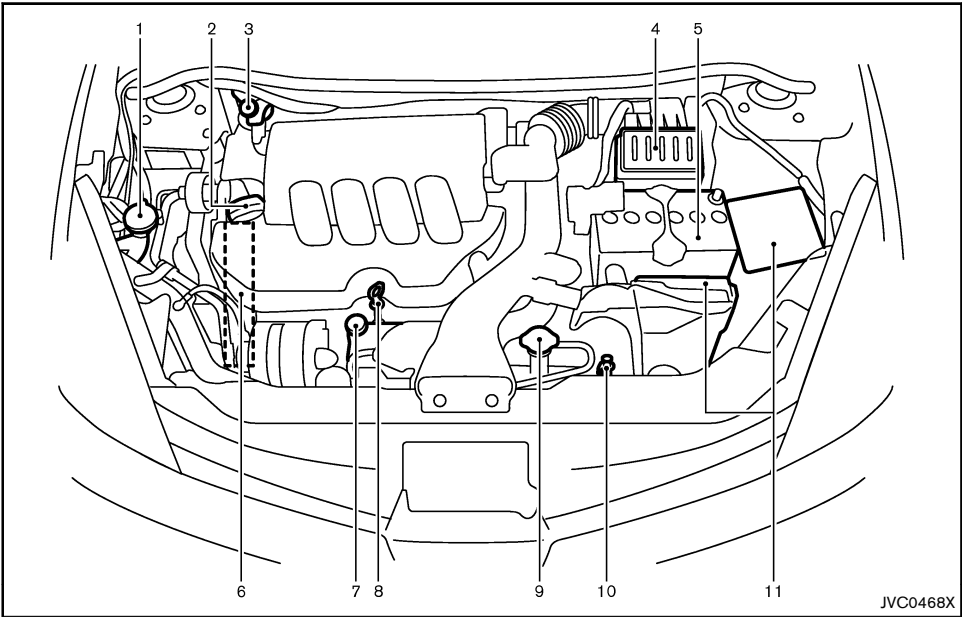

- | | |
|---|---|
| 1. Window washer fluid reservoir | 9. Radiator cap |
| 2. Engine oil filler cap | 10. Automatic Transmission Fluid (ATF) dipstick(*2) |
| 3. Brake and clutch(*1) fluid reservoir | 11. Fuse/fusible link box |
| 4. Air cleaner | (*1): For Manual Transmission (MT) model |
| 5. Battery | (*2): For Automatic Transmission (AT) model |
| 6. Engine drive belts | |
| 7. Engine coolant reservoir | |
| 8. Engine oil dipstick | |



WARNING:

- Never remove the radiator cap when the engine is hot. Serious burns could be caused by high-pressure fluid escaping from the radiator. Wait until the engine and radiator cool down.
- Engine coolant is poisonous and should be stored carefully in marked containers out of the reach of children.

The engine cooling system is filled at the factory with a high-quality, year-round, anti-freeze coolant solution. The anti-freeze solution contains rust and corrosion inhibitors, therefore additional cooling system additives are not necessary.



CAUTION:

- Never use any cooling system additives such as radiator sealer. Additives may clog the cooling system and cause damage to the engine, transmission and/or cooling system.
- When adding or replacing coolant, be sure to use only Genuine NISSAN Engine Coolant or equivalent in its quality with the proper mixture ratio. Examples of the mixture ratio of coolant and water are shown in the following table:

Outside temperature down to		Engine coolant	Demineralized or distilled water
°C	°F		
-15	5	30%	70%
-35	-30	50%	50%

The use of other types of coolant solutions may damage the engine cooling system.

The radiator is equipped with a pressure cap. To prevent engine damage, use only a Genuine NISSAN radiator cap or its equivalent when replacement is required.

CHECKING ENGINE COOLANT LEVEL

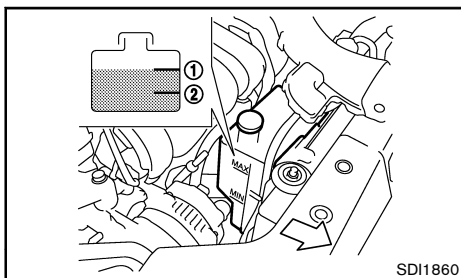

SDI1860

Check the coolant level in the reservoir when the engine is cold. If the coolant level is below the MIN level ②, add coolant up to the MAX level ①. If the reservoir is empty, check the coolant level in the radiator **when the engine is cold**. If there is insufficient coolant in the radiator, fill the radiator with coolant up to the filler opening and also add it to the reservoir up to the MAX level ①.

If the cooling system frequently requires coolant, have it checked by a NISSAN dealer.

CHANGING ENGINE COOLANT

Contact a NISSAN dealer if replacement is required.

Major engine cooling system repair should be performed by a NISSAN dealer. The service procedures can be found in the appropriate NISSAN Service Manual.

Improper servicing can result in reduced heater performance and engine overheating.



WARNING:

- **To avoid being scalded, never change the coolant when the engine is hot.**
- **Never remove the radiator cap when the engine is hot. Serious burns could be caused by high pressure fluid escaping from the radiator.**
- **Avoid direct skin contact with used coolant. If skin contact is made, wash thoroughly with soap or hand cleaner as soon as possible.**
- **Keep coolant out of reach of children and pets.**

Engine coolant must be disposed of properly. Check your local regulations.

ENGINE OIL

CHECKING ENGINE OIL LEVEL

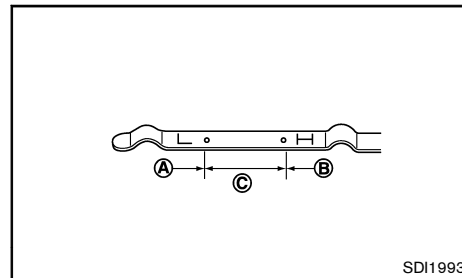

SDI1993

1. Park the vehicle on a level surface and apply the parking brake.
2. Start the engine and warm it up until the engine temperature reaches the normal operating temperature (approximately 5 minutes).
3. Stop the engine.
4. Wait at least 10 minutes for the engine oil to drain back to the oil pan.
5. Remove the dipstick and wipe it clean.
6. Reinsert the dipstick all the way.
7. Remove the dipstick and check the oil level. It should be within the range ③.
8. If the oil level is below ①, remove the oil filler cap and pour the recommended oil into the opening. Do not overfill ②.

When filling the engine oil, do not remove the dipstick.

9. Recheck the oil level with the dipstick.

It is normal to add some oil between oil maintenance intervals or during the break-in period, depending on the severity of operat-

ing conditions.



CAUTION:

The oil level should be checked regularly. Operating your vehicle with an insufficient amount of oil can damage the engine, and such damage is not covered by warranty.

CHANGING ENGINE OIL AND OIL FILTER

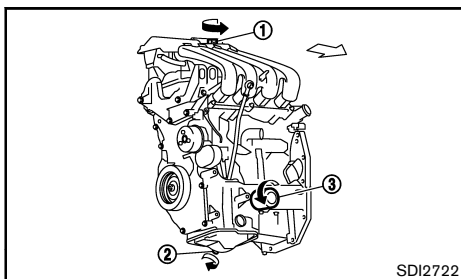

SDI2722

HR15DE and HR16DE engine models

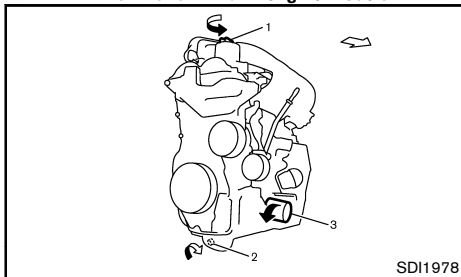

SDI1978

MR18DE engine model

1. Oil filler cap
2. Oil drain plug

3. Oil filter



WARNING:

- Used oil must be disposed of properly. Never pour or dump oil into the ground, canals, rivers, etc. It should be disposed of at proper waste facilities. NISSAN recommends having your oil changed by a NISSAN dealer.
- Be careful not to burn yourself, as the engine oil may be hot.
- Prolonged and repeated contact with used engine oil may cause skin cancer.
- Avoid direct skin contact with used oil. If contacted, wash thoroughly with soap or hand cleaner and plenty of water as soon as possible.
- Store used engine oil in marked containers out of the reach of children.



CAUTION:

Waste oil must be disposed of properly. Check your local regulations.

Engine oil replacement

1. Park the vehicle on a level surface and apply the parking brake.
2. Start the engine and warm it up until the engine temperature reaches the normal operating temperature (approximately 5 minutes).
3. Stop the engine.
4. Wait at least 10 minutes for the engine oil to drain back to the oil pan.

5. Place a large drain pan under the drain plug.
6. Remove the drain plug with a wrench.
7. Remove the oil filler cap and completely drain the oil.

If the oil filter is to be changed, remove and replace it at this time. (See "Engine oil filter replacement" (P.8-9).)

8. Clean and reinstall the drain plug and new washer. Securely tighten the drain plug with a wrench. Do not use excessive force.

Drain plug tightening torque:

29 to 39 N·m
(3.0 to 4.0 kg·m, 22 to 29 ft·lb)

9. Refill the recommended engine oil and quantity. (See "Recommended fuel/lubricants and capacities" (P.9-2).)

When filling the engine oil, do not remove the dipstick.

10. Securely install the oil filler cap.
11. Start the engine.
12. Check the drain plug for any sign of leakage.
13. Check the engine oil level according to the proper procedure. (See "Checking engine oil level" (P.8-8).)

Engine oil filter replacement

1. Park the vehicle on a level surface and apply the parking brake.
2. Stop the engine.
3. Drain the engine oil according to the proper procedure. (See "Engine oil replacement" (P.8-9).)

4. Loosen the oil filter with an oil filter wrench.
Depending on the engine model, a special cap type wrench may be required. See a NISSAN dealer for more information.
5. Remove the oil filter by turning it by hand.
6. Wipe the engine oil filter mounting surface with a clean cloth.
Be sure to remove any old gasket remaining on the mounting surface.
7. Apply the new engine oil to the gasket of the new oil filter.
8. Screw in the oil filter until a slight resistance is felt, and then tighten an additional 2/3 of turn to secure the oil filter.
Oil filter tightening torque:
15 to 20 N·m
(1.5 to 2.0 kg·m, 11 to 15 ft·lb)
9. Refill the recommended engine oil and quantity. (See "Engine oil replacement" (P.8-9).)
10. Start the engine and check for leakage around the oil filter. Correct as required.
11. Stop the engine and wait several minutes.
12. Check the engine oil level according to the proper procedure. (See "Checking engine oil level" (P.8-8).)

PROTECT ENVIRONMENT

It is illegal to pollute drains, watercourses and soil. Use authorized waste collection facilities, including civil amenity sites and garages providing facilities for disposal of used oil and used oil filters. If in doubt, contact your local authority for advice on disposal.

The regulations concerning the pollution of the environment will vary from country to country.

DRIVE BELTS

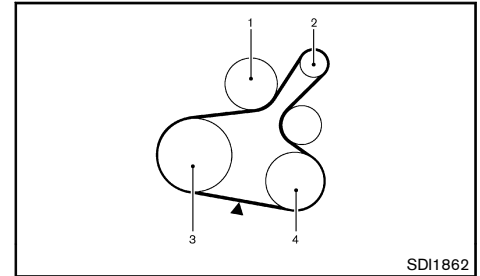

HR15DE and HR16DE engine models

1. Water pump
 2. Alternator
 3. Crankshaft pulley
 4. Air conditioner compressor
- ▼: Tension checking point

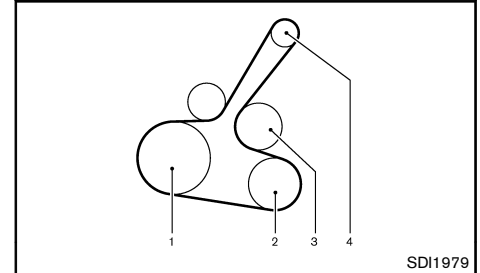

MR18DE engine model

1. Crankshaft pulley
2. Air conditioner compressor
3. Water pump
4. Alternator

Be sure the ignition switch is in the "OFF" position.
Visually inspect the belt for signs of unusual wear, cuts, fraying or looseness. Check regularly for condition and

tension (HR engine). If the belt is in poor condition or loose, have it replaced or adjusted by a NISSAN dealer.

SPARK PLUGS



WARNING:

Be sure the engine and ignition switch are off and that the parking brake is applied.

Replace the spark plugs according to the maintenance log shown in a separate maintenance booklet.

If replacement is required, contact a NISSAN dealer.

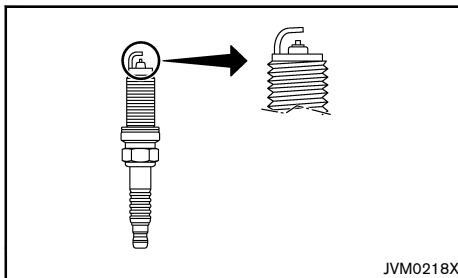

PLATINUM-TIPPED SPARK PLUGS

It is not necessary to replace the platinum-tipped spark plugs as frequently as the conventional type of spark plugs. These spark plugs are designed to last much longer than the conventional type of spark plugs.



CAUTION:

- **Do not reuse the platinum-tipped spark plugs by cleaning or re-gapping.**
- **Always replace with the recommended platinum-tipped spark plugs.**

BRAKES

CHECKING PARKING BRAKE

Lever type

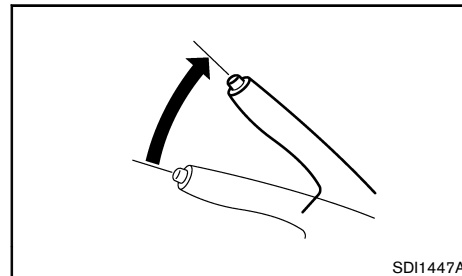

From the released position, pull the parking brake lever slowly and firmly. If the number of clicks is out of the range listed, see a NISSAN dealer.

**8 to 9 clicks under the pulling force
196 N (20 kg, 44 lb)**

CHECKING FOOT BRAKE PEDAL

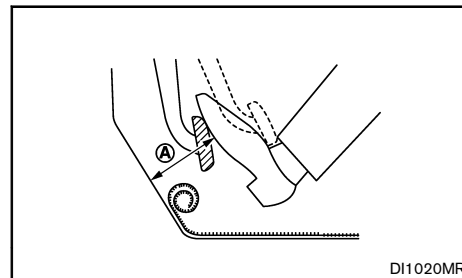



WARNING:

See a NISSAN dealer for a brake system check if the foot brake pedal height does not return to normal.

With the engine running, check the distance (A) between the upper surface of the pedal and the metal floor. If it is out the range listed, see a NISSAN dealer.

Distance (A) under the depressing force 490 N (50 kg, 110 lb):

Automatic Transmission (AT)/Continuously Variable Transmission (CVT) model:

90 mm (3.54 in) or more

Manual Transmission (MT) model:

80 mm (3.15 in) or more

Self-adjusting brakes

Your vehicle is equipped with self-adjusting brakes. The brakes are adjusted by the foot brake pedal operation.

Brake pad wear warning

The disc brake pads have audible wear warnings. When a brake pad requires replacement, it will make a high pitched scraping sound when the vehicle is in motion. This scraping sound will first occur only when the brake pedal is depressed. After more wear of the brake pad, the sound will always be heard even if the brake pedal is not depressed. Have the brakes checked as soon as possible if the wear warning sound is heard.

Have the system checked, and if necessary repaired, by a NISSAN dealer promptly.

Under some driving or climate conditions, occasional brake squeaks, squeals or other noises may be heard. Occasional brake noise during light to moderate stops

is normal and does not affect the function or performance of the brake system.

The rear drum brakes do not have audible wear indicators. Should you ever hear an unusually loud noise from the rear drum brakes, have them checked as soon as possible by a NISSAN dealer.

Proper brake inspection intervals should be followed. For additional information, see a separate maintenance booklet.

BRAKE BOOSTER

Check the brake booster function as follows:

1. With the engine off, depress and release the foot brake pedal several times. When the foot brake pedal movement (distance of travel) remains the same from one pedal application to the next, continue on to the next step.
2. While depressing the foot brake pedal, start the engine. The pedal height should drop a little.
3. With the foot brake pedal depressed, stop the engine. Keep the pedal depressed for about 30 seconds. The pedal height should not change.
4. Run the engine for 1 minute without depressing the foot brake pedal, then turn it off. Depress the foot brake pedal several times. The pedal travel distance will decrease gradually with each depression as the vacuum is released from the booster.

If the brakes do not operate properly, have the brakes checked by a NISSAN dealer.

BRAKE AND CLUTCH (if equipped) FLUID



WARNING:

- Use only new fluid from a sealed container. Old, inferior, or contaminated fluid may damage the brake and clutch system. The use of improper fluids can damage the brake and clutch system and affect the vehicle's stopping ability.
- Clean the filter cap before cleaning.
- Brake and clutch fluid is poisonous and should be stored carefully in marked containers out of the reach of children.



CAUTION:

Do not spill the fluid on painted surfaces. This will damage the paint. If fluid is spilled, wash it off with plenty of water immediately.

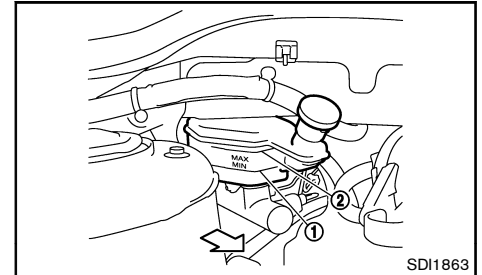

Check the fluid level in the reservoir. If the brake fluid is below the MIN line (1), the brake warning light will illuminate. Add fluid up to the MAX line (2). (See "Recommended fuel/lubricants and capacities" (P.9-2) for recommended types of fluid.)

If the fluid must be added frequently, the system should

AUTOMATIC TRANSMISSION FLUID (ATF) (if equipped)

be thoroughly checked by a NISSAN dealer.



CAUTION:

- **Genuine NISSAN Matic D ATF recommended.**
- **Using fluid other than Genuine NISSAN Matic D ATF will cause deterioration in driveability and automatic transmission durability, and may damage the automatic transmission, which is not covered by the warranty.**

CHECKING FLUID LEVEL



WARNING:

- **When the engine is running, keep hands, jewelry and clothing away from any moving parts such as the cooling fan and drive belts.**
- **Automatic Transmission Fluid (ATF) is poisonous and should be stored carefully in marked containers out of the reach of children.**

The ATF level should be checked in the HOT range using the dipstick.

The vehicle must be in a certain condition prior to performing the check. Make sure that the vehicle is ready by fulfilling one of the following conditions.

- The engine has warmed up to the operating temperature.
- The vehicle has been driven for at least 5 minutes.
- The ATF temperature becomes between 50 to 80°C (122 to 176°F).

The ATF level can be checked in the COLD range when the ATF temperature is between 30 to 50°C (86 to 122°F) before driving. However, the fluid level should be rechecked in the HOT range.

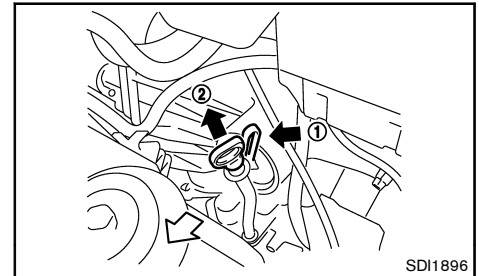

SDI1896

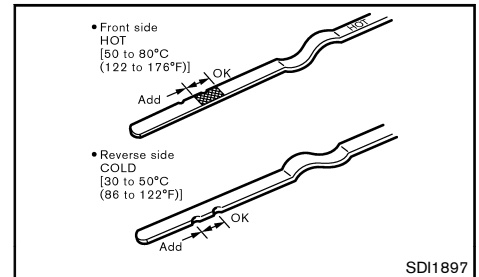

SDI1897

1. Park the vehicle on a level surface and apply the parking brake.
2. Start the engine.
3. Depress the foot brake pedal.
4. Move the shift lever through each gear range.
5. Move the shift lever to the "P" (Park) position.
6. Open the hood.
7. Check the fluid level with the engine at idle.
8. Remove the dipstick by pushing ① and pulling out ②.

CONTINUOUSLY VARIABLE TRANSMISSION (CVT) FLUID (if equipped)

Contact a NISSAN dealer if checking or replacement is required.

CAUTION:

- Use only Genuine NISSAN CVT Fluid NS-3. Do not mix with other fluids.
- Using transmission fluid other than Genuine NISSAN CVT Fluid NS-3 will damage the CVT, which is not covered by the warranty.

9. Wipe the dipstick clean.
10. Reinsert the dipstick all the way.
11. Remove the dipstick and check the fluid level. If the level is at the low side of either range, add fluid to the charging pipe. **Do not overfill.**

If the vehicle has been driven for a long time at high speeds or in city traffic in hot weather the accurate fluid level cannot be read. You should wait until the fluid has cooled down (approximately 30 minutes).

AIR CLEANER FILTER

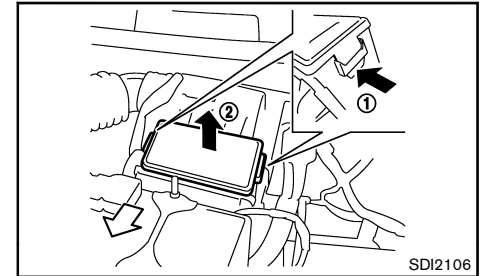

WARNING:

Operating the engine with the air cleaner filter off can cause you or others to be burned. The air cleaner filter not only cleans the intake air, it also stops flame if the engine backfires. If the air cleaner filter is not installed and the engine backfires, you could be burned. Never drive with the air cleaner filter off. Be cautious working on the engine when the air cleaner filter is off.

To remove the filter from the air cleaner, push the tabs **①** and pull the unit upward **②**.

The viscous paper type filter element should not be cleaned and reused. The dry paper type filter element may be cleaned and reused. Replace the air filter according to the maintenance log shown in a separate maintenance booklet.

When replacing the air filter, wipe the inside of the air cleaner housing and the cover with a damp cloth.

WIPER BLADES

WINDSHIELD WIPER BLADES

Cleaning

If the windshield does not become clear after using the windshield washer or if the wiper blades chatter when operating the windshield wipers, wax or other materials may be on the windshield and/or wiper blades.

Clean the outside of the windshield surface with a washer solution or mild detergent. Your windshield is clean if beads do not form when rinsing with water.

Clean the blade by wiping it with a cloth soaked in a washer solution or a mild detergent. Rinse the blade with water. If your windshield is still not clear after cleaning the blades and using the wipers, replace the blades.

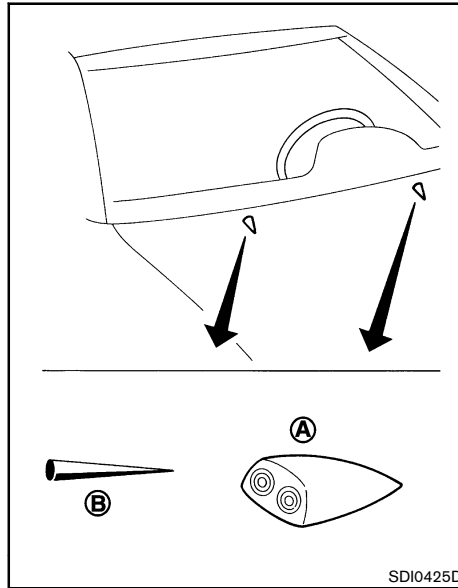

Be careful not to clog the washer nozzle (A). This may cause improper windshield washer operation. If the nozzle is clogged, remove any objects with a needle or small pin (B). Be careful not to damage the nozzle.

Replacing

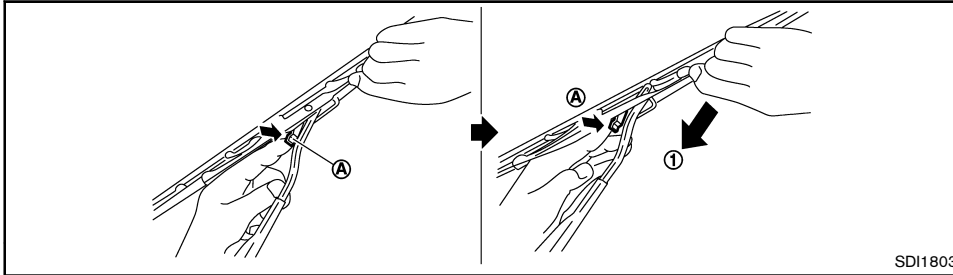

1. Lift the wiper arm away from the windshield.
2. Push and hold the release tab (A), and then move the wiper blade down (1) the wiper arm to remove.
3. Remove the wiper blade.
4. Insert the new wiper blade onto the wiper arm until it clicks into place.



CAUTION:

- **After wiper blade replacement, return the wiper arm to its original position. Otherwise the wiper arm or the engine hood may be scratched and may cause damage.**
- **Worn windshield wiper blades can damage the windshield and impair driver vision.**

REAR WINDOW WIPER BLADE

Contact a NISSAN dealer if checking or replacement is required.

WINDOW WASHER FLUID

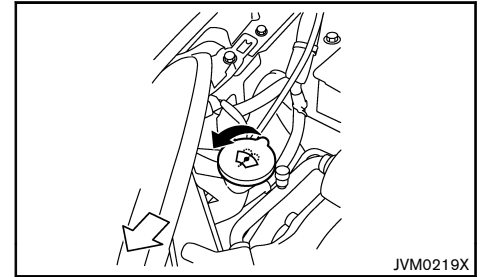

WARNING:







Anti-freeze is poisonous and should be stored carefully in marked containers out of the reach of children.

Check the fluid level in the reservoir and add fluid if necessary.

Add a washer solvent to the water for better cleaning. In the winter season, add a windshield washer anti-freeze. Follow the manufacturer's instructions for the mixture ratio.

BATTERY

VEHICLE BATTERY

Caution symbols for battery			⚠ WARNING
①		No smoking, No exposed flames, No sparks	Never smoke around battery. Never expose battery to open flames or electrical sparks.
②		Shield eyes	Handle the battery cautiously. Always wear eye protection glasses to protect against explosion or battery acid.
③		Keep away from children	Never allow children to handle battery. Keep the battery out of the reach of children.
④		Battery acid	Do not allow battery fluid to contact your skin, eyes, fabrics, or painted surfaces. After handling the battery or battery cap, immediately wash your hands thoroughly. If the battery fluid gets into your eyes, or onto your skin or clothing, flush with water immediately for at least 15 minutes and seek medical attention. Battery fluid is acid. If the battery fluid gets into your eyes or onto your skin, it could cause loss of your eyesight or burns.
⑤		Note operating instructions	Before handling the battery, read this instruction carefully to ensure correct and safe handling.
⑥		Explosive gas	Hydrogen gas, generated by battery fluid, is explosive.

SDI1573



WARNING:

Do not operate the vehicle if the fluid in the battery is low. Low battery fluid can cause a higher load on the battery which can generate heat, reduce battery life, and in some cases lead to an explosion.

Checking battery fluid level

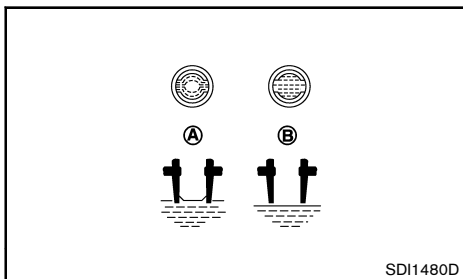
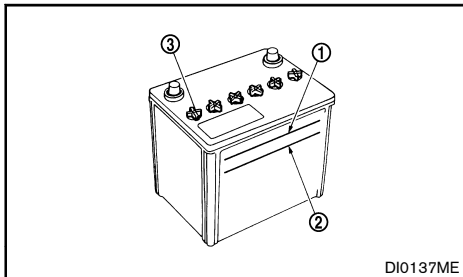

Check the fluid level in each cell. The battery fluid level should be between the UPPER LEVEL ① and LOWER LEVEL ② lines.

If it is necessary to add fluid, add only demineralized/distilled water to bring the level to the indicator in each filler opening. Do not overfill.

1. Remove the cell plugs ③, if equipped.
2. Add demineralized/distilled water up to the UPPER LEVEL ① line.

If the side of the battery is not clear, check the distilled water level by looking directly above the

cell; the condition ① indicates OK and the condition ② needs more to be added.

3. Replace and tighten the cell plugs.
 - Vehicles operated in high temperatures or under severe conditions require frequent checks of the battery fluid level.
 - Keep the battery surface clean and dry. Any corrosion should be washed off with a solution of baking soda and water.
 - Make certain the terminal connections are clean and securely tightened.
 - If the vehicle is not to be used for more than 30 days, disconnect the negative (-) battery terminal cable to prevent battery discharge.

Jump starting

If jump starting is necessary, see "Jump starting" (P.6-6). If the engine does not start by jump starting or the battery does not charge, the battery may have to be replaced. Contact a NISSAN dealer for replacing the battery.

REMOTE CONTROLLER BATTERY

Battery replacement

CAUTION:

- **Be careful not to allow children to swallow the battery and removed parts.**
- **An improperly disposed battery can harm the environment. Always confirm local regulations for battery disposal.**
- **When changing batteries, do not let dust or oil get on the components.**

- **There is danger of explosion if lithium battery is incorrectly replaced. Replace only with the same or equivalent type.**
- **Do not expose the battery to excessive heat such as sunshine, fire, etc.**

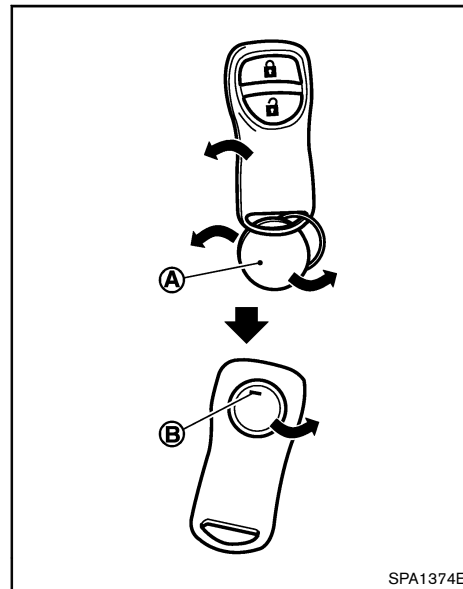

To replace the battery:

1. Use an appropriate tool ① to remove the lid.
2. Replace the battery with a new one.

Recommended battery: CR2025 or equivalent

- Do not touch the internal circuit and electric terminals as doing so could cause a malfunction.
 - Make sure that the + side faces the bottom of the case (B).
3. Close the lid securely.
 4. Operate the buttons to check its operation.

See a NISSAN dealer if you need assistance for replacement.

INTELLIGENT KEY BATTERY

Battery replacement



CAUTION:

- **Be careful not to allow children to swallow the battery and removed parts.**
- **An improperly disposed battery can harm the environment. Always confirm local regulations for battery disposal.**
- **When changing batteries, do not let dust or oil get on the components.**
- **There is danger of explosion if lithium battery is incorrectly replaced. Replace only with the same or equivalent type.**
- **Do not expose the battery to excessive heat such as sunshine, fire, etc.**

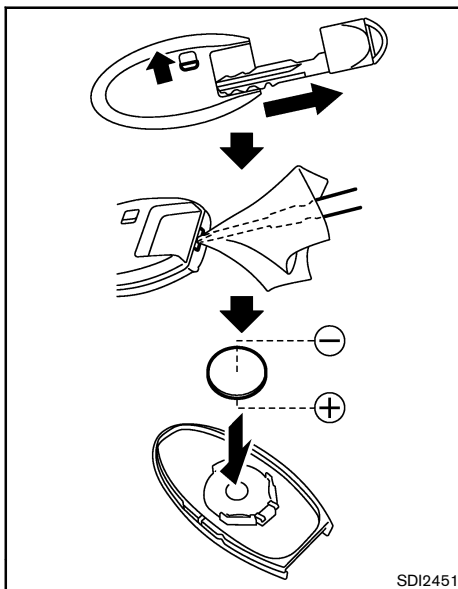

To replace the battery:

1. Release the lock knob at the back of the Intelligent Key and remove the mechanical key.
2. Insert a small screwdriver into the slit of the corner and twist it to separate the upper part from the lower part. Use a cloth to protect the casing.
3. Replace the battery with a new one.
 - Recommended battery: CR2025 or equivalent
 - Do not touch the internal circuit and electric terminals as doing so could cause a malfunction.

- Make sure that the ⊕ side faces the bottom of the case.

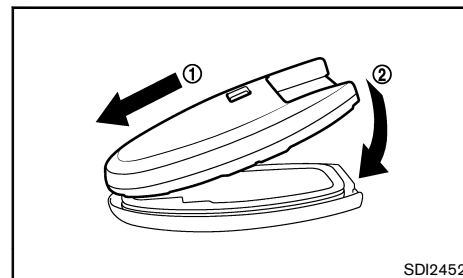

4. Align the tips of the upper and lower parts (1), and then push them together until it is securely closed (2).
 5. Operate the buttons to check its operation.
- See a NISSAN dealer if you need assistance for replacement.

FUSES

ENGINE COMPARTMENT

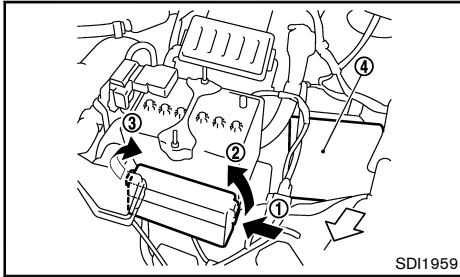

SDI1959



CAUTION:

Never use a fuse of a higher or lower amperage rating than that specified on the fuse box cover. This could damage the electrical system or cause a fire.

If any electrical equipment does not operate, check for an open fuse.

1. Be sure the ignition switch is in the "OFF" position.
2. Be sure the headlight switch is in the "OFF" position.
3. Open the engine hood.
4. Remove the fuse/fusible link holder cover by pushing the tab ① and lifting the cover from the right side ②, then the left side ③.
5. Locate the fuse that needs to be replaced.
6. Remove the fuse using the fuse puller located in the passenger compartment fuse box.

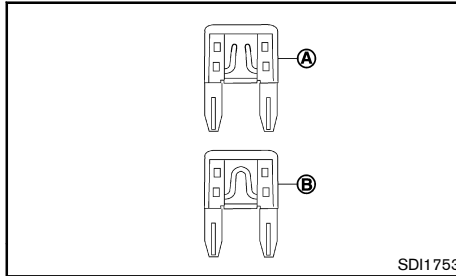

7. If the fuse is open ①, replace it with a new fuse ②.

If the new fuse also opens, after installing, have the electrical system checked, and if necessary repaired, by a NISSAN dealer.

The holder ④ also contains the fuses. For checking and/or replacing, see a NISSAN dealer.

Fusible links

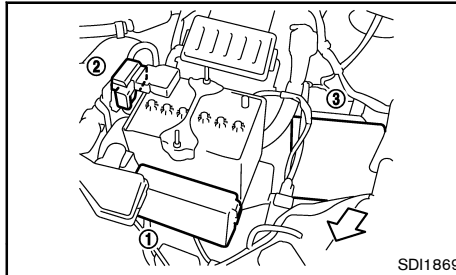

SDI1869

If any electrical equipment does not operate and the fuses are in good condition, check the fusible links in the holders ①, ② and ③. If any of these fusible links are melted, replace only with genuine NISSAN

parts.

For checking and replacing the fusible links in holders ② and ③, see a NISSAN dealer.

PASSENGER COMPARTMENT

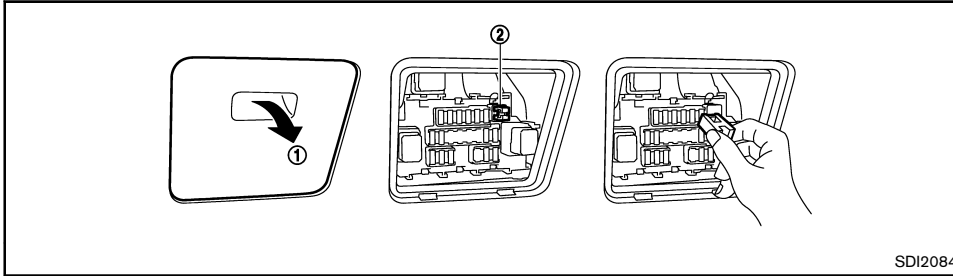

CAUTION:

Never use a fuse of a higher or lower amperage rating than that specified on the fuse box cover. This could damage the electrical system or cause a fire.

If any electrical equipment does not operate, check for an open fuse.

1. Be sure the ignition switch is in the "OFF" position.
2. Be sure the headlight switch is in the "OFF" position.
3. Remove the fuse box cover ①.
4. Locate the fuse that needs to be replaced.
5. Remove the fuse using the fuse puller ②.

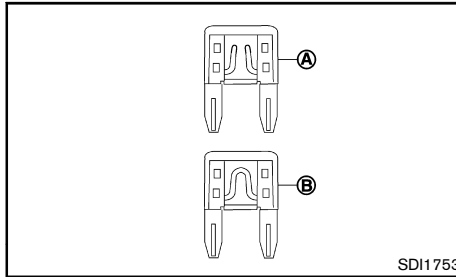

6. If the fuse is open ①, replace it with a new fuse ②.

If the new fuse also opens, after installing, have the electrical system checked, and if necessary repaired, by a NISSAN dealer.

LIGHTS

HEADLIGHTS

Replacing halogen headlight bulb

The halogen headlight is a semi-sealed beam type which uses replaceable headlight (halogen) bulbs. They can be replaced from inside the engine compartment without removing the headlight assembly.

See a NISSAN dealer for replacing the headlights.



CAUTION:

- High-pressure halogen gas is sealed inside the bulb. The bulb may break if the glass envelope is scratched or the bulb is dropped.
- When handling the bulb, do not touch the glass envelope.
- Use the same number and wattage as originally installed:

Halogen headlight model

High beam bulb : 65W (H9)

Low beam bulb : 55W (H11)

- Do not leave the bulb out of the headlight reflector for a long period of time as dust, moisture and smoke may enter the headlight body and affect the performance of the headlight.

Aiming adjustment is not necessary if only the bulbs are replaced. When aiming adjustment is necessary, contact a NISSAN dealer.

Fog may temporarily form inside the lens of the exterior lights in the rain or in a car wash. A temperature difference between the inside and the outside of the lens causes the fog. This is not a malfunction. If large drops of water collect inside the lens, contact a NISSAN dealer.

EXTERIOR LIGHTS

Item	Wattage (W)
Front turn signal light*1	21
Front clearance light*1	5
Front fog light (if equipped)*1	55 or 35*2
Side turn signal light (front fender type)*1	5
Side turn signal light (outside rearview mirror type)*1	LED
Rear combination lights*1	
Turn signal	21
Stop/Tail	21/5
Reverse	16
High-mounted stop light*1	LED
License plate light*1	5

*1: See a NISSAN dealer for replacement.

*2: Model with roof rail

INTERIOR LIGHTS

Item	Wattage (W)
Room light	8
Luggage room light (if equipped)*	5

*: See a NISSAN dealer for replacement.

LIGHT LOCATIONS

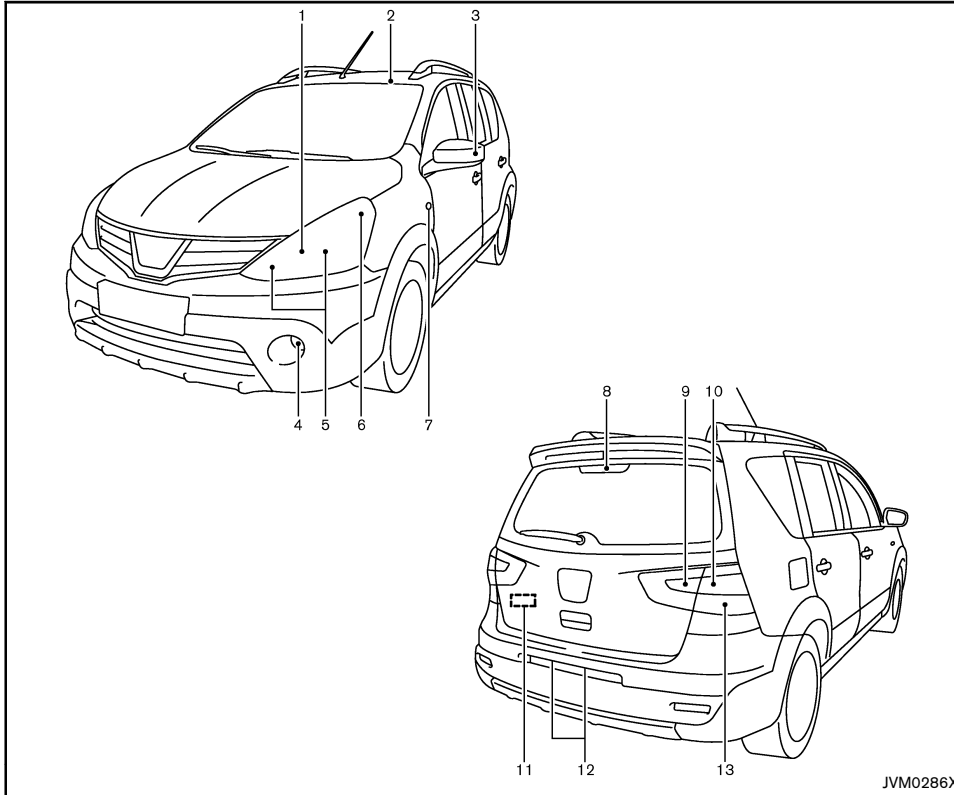

1. Clearance light
 2. Room light
 3. Side turn signal light (outside rearview mirror type)*
 4. Front fog light*
 5. Headlight
 6. Front turn signal light
 7. Side turn signal light (front fender type)
 8. High-mounted stop light
 9. Reverse light
 10. Rear turn signal light
 11. Luggage room light*
 12. License plate lights
 13. Stop/tail light
- *: if equipped

Replacement procedures

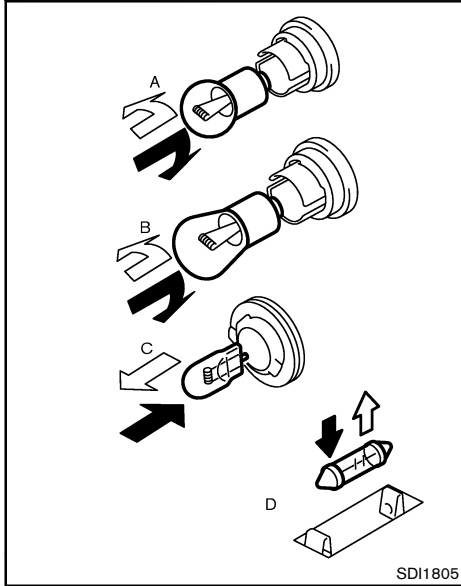

→: REMOVE
→: INSTALL

All other lights are either type A, B, C or D. When replacing a bulb, first remove the lens and/or cover.

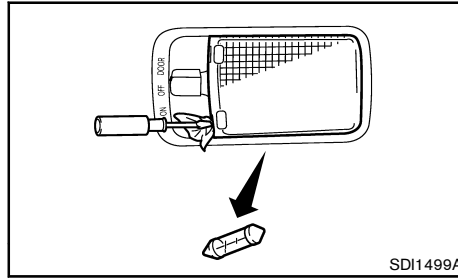

Room light

TIRES AND WHEELS

If you have a flat tire, see "Flat tire" (P.6-2).

TIRE INFLATION PRESSURE

Periodically check the pressure of the tires, including the spare. An incorrect tire pressure may adversely affect tire life and vehicle handling. The tire pressure should be checked when tires are COLD. Tires are considered COLD after the vehicle has been parked for 3 or more hours, or driven less than 1.6 km (1 mile). COLD tire pressures are shown on the tire placard. (See "Vehicle identification" (P.9-6) for the location of the tire placard.)

Insufficient pressure can lead to an overheating of the tire and subsequent internal damage. At high speeds, this could result in tread separation and even bursting of the tire.

TYPES OF TIRES



CAUTION:

When changing or replacing tires, be sure all four tires are of the same type (that is, summer, all season or snow) and construction. A NISSAN dealer may be able to help you with information about tire type, size, speed rating and availability.

Replacement tires may have a lower speed rating than the factory equipped tires, and they may not match the potential maximum vehicle speed. Never exceed the maximum speed rating of the tire.

All season tires

NISSAN specifies all season tires on some models to provide good performance all year, including snowy and icy road conditions. All season tires are identified by ALL SEASON and/or M&S on the tire sidewall. Snow tires have better snow traction than all season tires and may be more appropriate in some areas.

Summer tires

NISSAN specifies summer tires on some models to provide superior performance on dry roads. Summer tire performance is substantially reduced in snow and ice. Summer tires do not have the tire traction rating M&S on the tire sidewall.

If you plan to operate your vehicle in snowy or icy conditions, NISSAN recommends the use of snow or all season tires on all four wheels.

Snow tires

If snow tires are needed, it is necessary to select tires equivalent in size and load rating to the original equipment tires. If you do not, it can adversely affect the safety and handling of your vehicle.

Generally, snow tires have lower speed ratings than factory equipped tires and may not match the potential maximum vehicle speed. Never exceed the maximum speed rating of the tire. If you install snow tires, they must be the same size, brand, construction and tread pattern on all four wheels.

For additional traction on icy roads, studded tires may be used. However, some states and provinces prohibit their use. Check local, state and provincial laws before installing studded tires. Skid and traction capabilities of studded snow tires on wet or dry surfaces may be poorer than that of non-studded snow tires.

TIRE CHAINS

Use of tire chains may be prohibited according to location. Check the local laws before installing tire chains. When installing tire chains, make sure that they are of proper size for the tires on your vehicle and are installed according to the chain manufacturer's instructions.

Use chain tensioners when recommended by the tire chain manufacturer to ensure a tight fit. Loose end links of the tire chains must be secured or removed to prevent the possibility of whipping action damage to the fenders or underbody. If possible, avoid fully loading your vehicle when using tire chains. In addition, drive at a reduced speed. Otherwise, your vehicle may be damaged and/or vehicle handling and performance may be adversely affected.

Tire chains must be installed only on the front wheels and not on the rear wheels.

Do not drive with tire chains on paved roads which are clear of snow. Driving with chains in such conditions can cause damage to the various mechanisms of the vehicle due to some oversteer.

TIRE ROTATION

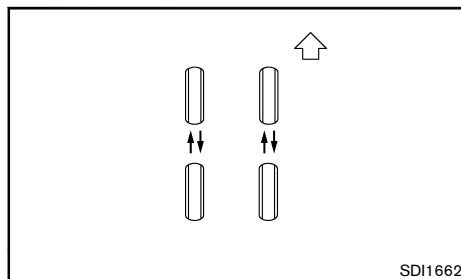

NISSAN recommends that tires be rotated every

10,000 km (6,000 miles). However, the timing for tire rotation may vary according to your driving habits and the road surface conditions. (See "Flat tire" (P.6-2) for the tire replacement.)



WARNING:

- **After rotating the tires, adjust the tire pressure.**
- **Retighten the wheel nuts when the vehicle has been driven for 1,000 km (600 miles) (also in cases of a flat tire, etc.).**
- **Do not include the spare tire in tire rotation.**
- **Incorrect tire selection, fitting, care or maintenance can affect vehicle safety with risk of accident and injury. If in doubt, consult a NISSAN dealer or the tire manufacturer.**

TIRE WEAR AND DAMAGE

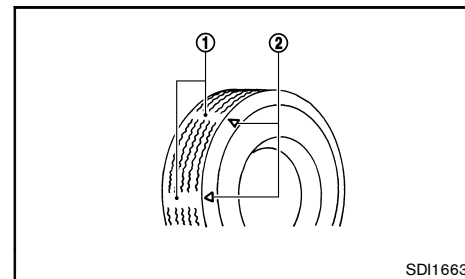

- ① Wear indicator
- ② Wear indicator location mark

Tires should be periodically inspected for wear, cracking, bulging or objects caught in the tread. If excessive wear, cracks, bulging or deep cuts are found, the tire should be replaced immediately.

The original tires have a built-in tread wear indicator. When the wear indicator is visible, the tire should be replaced.

Improper service of a spare tire may result in serious personal injury. If it is necessary to repair the spare tire, contact a NISSAN dealer.

TIRE AGE

Never use a tire over six years old, regardless of whether it has been used or not.

Tires degrade with age as well as with the vehicle usage. Have your tires checked and balanced often by a repair shop or, if you prefer, a NISSAN dealer.

CHANGING TIRES AND WHEELS



WARNING:

Do not install a deformed wheel or tire even if it has been repaired. Such wheels or tires could have structural damage and could fail without warning.

When replacing a tire, use the same size, speed rating and load carrying capacity as originally equipped. (See "Tires and wheels" (P.9-5) for recommended types and sizes of tires and wheels.) The use of tires other than those recommended or the mixed use of tires of different brands, construction (bias, bias-belted, or radial), or tread patterns can adversely affect the ride, braking, handling, ground clearance, body-to-tire clearance, snow chain clearance, speedometer calibration, headlight aim and bumper height. Some of these effects may lead to accidents and could result in serious personal injury.

If the wheels are changed for any reason, always replace with wheels which have the same offset dimension. Wheels of a different offset could cause

early tire wear, possibly degraded vehicle handling characteristics and/or interference with the brake discs/drums. Such interference can lead to decreased braking efficiency and/or early brake pad/shoe wear.

WHEEL BALANCE

Unbalanced wheels may affect vehicle handling and tire life. Even with regular use, wheels can get out of balance. Therefore, they should be balanced as required.

SPARE TIRE

Temporary-use spare tire (if equipped)

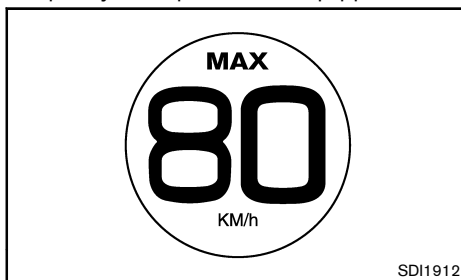

Spare tire label (if equipped)

Observe the following precautions if the spare tire must be used, otherwise your vehicle could be damaged or involved in an accident.



CAUTION:

- **The spare tire should be used only for emergency. It should be replaced by the standard tire at the first opportunity.**
- **Drive carefully while the spare tire is installed.**

- **Avoid sharp turns and abrupt braking while driving.**
- **Do not drive your vehicle at speeds faster than 80 km/h (50 MPH).**
- **Do not use tire chains on a spare tire. Tire chains will not fit properly on the spare tire and may cause damage to the vehicle.**
- **Because the spare tire is smaller than the original tire, ground clearance is reduced. To avoid damage to the vehicle do not drive over obstacles. Also do not drive the vehicle through an automatic car wash since it may get caught.**
- **Do not use the spare tire on other vehicles.**
- **Do not use more than one spare tire at the same time.**
- **See the tire placard on your vehicle for more details.**

Conventional spare tire (if equipped)

A standard tire (the same size as the road wheels) is supplied with your vehicle.

9 Technical information

Recommended fuel/lubricants and capacities	9-2	Vehicle identification	9-6
Fuel information	9-3	Vehicle identification plate	9-6
Recommended SAE viscosity number	9-3	Vehicle identification number (chassis number)	9-6
Air conditioner system refrigerant and lubricant	9-3	Engine serial number	9-6
Engine	9-4	Tire placard	9-7
Tires and wheels	9-5	Air conditioner specification label	9-7
Dimensions	9-5	Radio approval number and information	9-7
When travelling or registering in another country	9-6	For Indonesia	9-7
		For Thailand	9-8



RECOMMENDED FUEL/ LUBRICANTS AND CAPACITIES

The following are approximate capacities. The actual refill quantities may be slightly different. When refilling, follow the procedures instructed in the “8. Maintenance and do-it-yourself” section to determine the proper refill capacity.

Engine Type			Approximate Capacity		Recommended Fuel/Lubricants
			Metric Measure	Imperial Measure	
Fuel			52 L	11-1/2 gal	See “Fuel information” (P.9-3).
Engine oil	HR15DE	including oil filter	3.0 L	2-5/8 qt	<p>The approximate capacities listed are for refilling during an engine oil change. For additional information, see “Engine oil” (P.8-8).</p> <ul style="list-style-type: none"> • Genuine NISSAN engine oil • API grade: SL, SM or SN • ILSAC grade: GF-3, GF-4 or GF-5 <p>For additional information, see “Recommended SAE viscosity number” (P.9-3).</p>
	HR16DE	excluding oil filter	2.8 L	2-1/2 qt	
	MR18DE	including oil filter	4.6 L	4 qt	
		excluding oil filter	4.4 L	3-7/8 qt	
Cooling system (with reservoir)	HR15DE	total	5.8 L	5-1/8 qt	<ul style="list-style-type: none"> • Genuine NISSAN Engine Coolant or equivalent in its quality • Use Genuine NISSAN Engine Coolant, or equivalent in its quality, in order to avoid possible aluminum corrosion within the engine cooling system caused by the use of non-genuine engine coolant. • Note that any repairs for incidents within the engine cooling system while using non-genuine engine coolant may not be covered by the warranty even if such incidents occurred during the warranty period.
		Reservoir	0.7 L	5/8 qt	
	HR16DE	total	6.6 L	5-7/8 qt	
		Reservoir	0.6 L	1/2 qt	
	MR18DE	total	6.3 L	5-1/2 qt	
		Reservoir	0.7 L	5/8 qt	
Continuously Variable Transmission (CVT) fluid			Refill to the proper fluid level according to the instructions in the “8. Maintenance and do-it-yourself” section.		<ul style="list-style-type: none"> • Genuine NISSAN CVT Fluid NS-3 • Use only Genuine NISSAN CVT Fluid NS-3. Using transmission fluid other than Genuine NISSAN CVT Fluid NS-3 will damage the CVT, which is not covered by the warranty.
Automatic Transmission (AT) fluid (ATF)					<ul style="list-style-type: none"> • Genuine NISSAN Matic D ATF recommended • Using fluid other than Genuine NISSAN Matic D ATF will cause deterioration in driveability and automatic transmission durability, and may damage the automatic transmission, which is not covered by the warranty.
Brake and clutch fluid					Genuine NISSAN Brake Fluid, or equivalent DOT3
Manual Transmission (MT) gear oil			—	—	<p>For 5MT:</p> <ul style="list-style-type: none"> • Genuine NISSAN Manual Transmission Fluid (MTF) HQ Multi 75W-85 or equivalent • If Genuine NISSAN Manual Transmission Fluid (MTF) HQ Multi is not available, API GL-4, Viscosity SAE 75W-85 may be used as a temporary replacement. However, use Genuine NISSAN Manual Transmission Fluid (MTF) HQ Multi as soon as it is available. <p>For 6MT:</p> <ul style="list-style-type: none"> • Genuine NISSAN Manual Transmission Fluid (MTF) Chevron Texaco ETL8997B 75W-80 or equivalent • If Genuine NISSAN Manual Transmission Fluid Chevron Texaco ETL8997B is not available, API GL-4, Viscosity SAE 75W-80 may be used as a temporary replacement. However, use Genuine NISSAN Manual Transmission Fluid (MTF) Chevron Texaco ETL8997B as soon as it is available.
Multi-purpose grease			—	—	NLG1 No. 2 (Lithium soap base)
Air conditioner system refrigerant			—	—	HFC-134a (R-134a)
Air conditioner system lubricant			—	—	NISSAN A/C System Oil Type R or equivalent

FUEL INFORMATION

Model with three-way catalyst



CAUTION:

Do not use leaded gasoline. Using leaded gasoline will damage the three-way catalyst.

Except for Thailand:

Use UNLEADED REGULAR gasoline with an octane rating of at least 91 (RON).

For Thailand:

Use UNLEADED PREMIUM gasoline or gasohol (up to E20*) with an octane rating of at least 95 (RON).

If unleaded premium gasoline is not used, UNLEADED REGULAR gasoline with an octane rating of at least 91 (RON) may be used at slightly reduced performance. However, for maximum vehicle performance and the best driveability, the use of unleaded premium gasoline is recommended.

*: Gasohol is alcohol blended gasoline. For example, "E20" is a mixture of approximately 20% fuel ethanol and 80% unleaded gasoline.

RECOMMENDED SAE VISCOSITY NUMBER

Gasoline engine oil

10W-30 is preferable.

If 10W-30 is not available, select the viscosity, from the chart below, that is suitable for the outside temperature range.

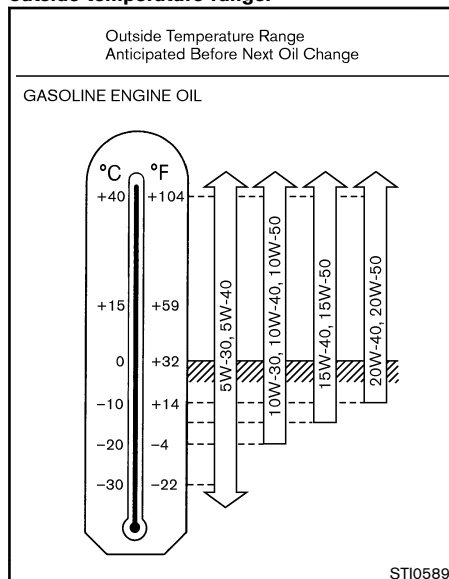

AIR CONDITIONER SYSTEM REFRIGERANT AND LUBRICANT

The air conditioner system of your vehicle must be charged with the refrigerant HFC-134a (R134a) and the lubricant NISSAN A/C System Oil Type R or equivalents. Use of any other refrigerants or lubricants will cause severe damage, and you may need to replace your vehicle's entire air conditioner system.

The release of refrigerants into the atmosphere is prohibited in many countries and regions. The refrigerant HFC-134a (R-134a) in your vehicle will not harm the Earth's ozone layer. However, it may contribute in a small part to the global warming effect. NISSAN recommends that the refrigerant be appropriately recovered and recycled. Contact a NISSAN dealer when servicing the air conditioner system.

ENGINE

Engine Model		HR15DE	HR16DE	MR18DE
Type		Gasoline, 4-cycle, DOHC	Gasoline, 4-cycle, DOHC	Gasoline, 4-cycle, DOHC
Cylinder arrangement		4-cylinder, in-line	4-cylinder, in-line	4-cylinder, in-line
Bore × Stroke	mm (in)	78.0 × 78.4 (3.071 × 3.087)	78.0 × 83.6 (3.071 × 3.291)	84.0 × 81.1 (3.307 × 3.193)
Displacement	cm ³ (cu in)	1,498 (91.41)	1,598 (97.51)	1,798 (109.71)
Idle speed at the "N" (Neutral) position	rpm	650±50	650±50	700±50
Ignition timing (B.T.D.C.)		CVT: 7°±2° MT: 10°±2°	CVT: 9°±2° MT: 10°±2°	13°±2°
Spark plugs				
	Standard	LZKAR6AP-11	PLZKAR6A-11D	LZKAR6AP-11
With catalyzer	Service option	LZKAR6AP-11	PLZKAR6A-11D	LZKAR5AP-11 LZKAR7AP-11
Spark plug gap	mm (in)	1.1 (0.043)	1.1 (0.043)	1.1 (0.043)
Camshaft operation		Timing chain	Timing chain	Timing chain

TIRES AND WHEELS

	Standard*1	Spare	
Tire size	185/65R15 88H	Conventional	
	195/55R16 87V	185/65R15 88H*2 or Conventional	
	Size	Offset	
Road wheel	Aluminum	16 × 6.0J 15 × 5.5J	42 45
	Steel	15 × 5.5JJ	40

*1: See the tire placard on your vehicle for more details.

*2: Temporary use only

DIMENSIONS

Unit: mm (in)

Overall length	4,485 (176.6)*1
	4,540 (178.7)*2
	4,310 (169.7)*3
Overall width	1,695 (66.7)*4
	1,700 (66.9)*5
	1,735 (68.3)*2*3
Overall height	1,595 (66.7)*6
	1,650 (65.0)*2*7
	1,635 (64.4)*3
Front tread	1,470 (57.9)*8
	1,475 (58.1)*9
Rear tread	1,475 (58.1)*8
	1,480 (58.3)*9
Wheelbase	2,590 (102.0)*10
	2,600 (102.4)*11

*1: Three-row model (Models with 15 inch aluminum wheels)

*2: Three-row model (Models with 16 inch aluminum wheels)

*3: Two-row model

*4: Three-row model (Models without side molding)

*5: Three-row model (Models with side molding)

*6: Three-row model (Models without roof rail)

*7: Three-row model (Models with roof rail)

*8: Models with 15 inch wheels

*9: Models with 16 inch wheels

*10: For Thailand

*11: Except for Thailand

WHEN TRAVELLING OR REGISTERING IN ANOTHER COUNTRY

When planning to travel in another country or region, find out whether the fuel required for your vehicle is available in that country or region. Using a low octane rated fuel may cause engine damage. Therefore, be sure that the required fuel is available wherever you go. For additional information regarding recommended fuel, see earlier in this section.

When transferring the registration of your vehicle to another country, state, province or district, contact the appropriate authorities to find out that the vehicle complies with the local legal requirements. In some cases, a vehicle cannot meet the legal requirements, and it may be necessary to modify the vehicle to meet local laws and regulations. In addition, there may be possibilities that a vehicle cannot be adapted in certain areas.

The laws and regulations for motor vehicle emission control and safety standards vary according to the country, state, province or district; therefore, the vehicle specification may differ.

When any vehicles are to be taken into another country, state, province or district, its modification, transportation, registration, and any other expenses which may result, are the responsibility of the user. NISSAN is not responsible for any inconveniences that may result.

VEHICLE IDENTIFICATION

It is prohibited to cover, paint, weld, cut, drill, alter or remove Vehicle Identification Number (VIN).

VEHICLE IDENTIFICATION PLATE

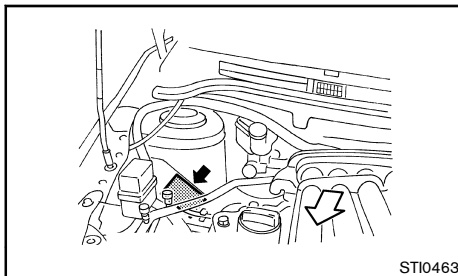

HR engine model

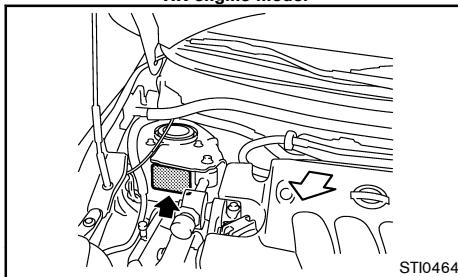

MR engine model

The plate is affixed to the engine compartment as shown.

VEHICLE IDENTIFICATION NUMBER (chassis number)

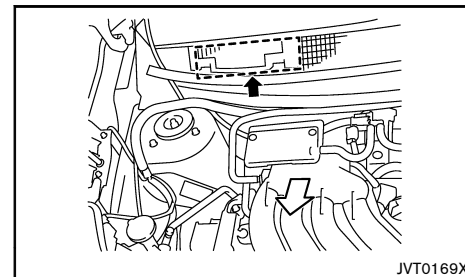

The number is stamped in the engine compartment. Remove the cover to access the number.

ENGINE SERIAL NUMBER

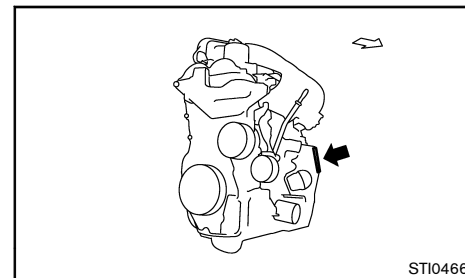

HR/MR engine

TIRE PLACARD

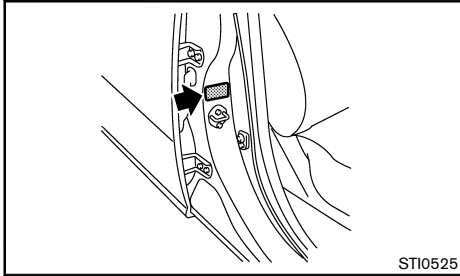

The cold tire pressures are shown on the tire placard affixed to the driver's side center pillar.

AIR CONDITIONER SPECIFICATION LABEL

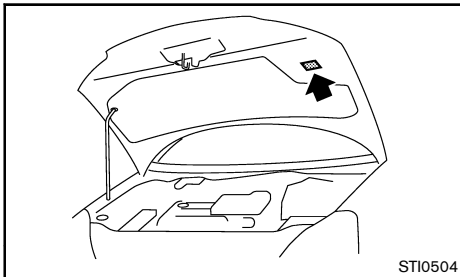

RADIO APPROVAL NUMBER AND INFORMATION

FOR INDONESIA

NISSAN Anti-Theft System (NATS) immobilizer (if equipped)



DEPARTEMEN KOMUNIKASI DAN INFORMATIKA DIREKTORAT JENDERAL POS DAN TELEKOMUNIKASI REPUBLIK INDONESIA		MINISTRY OF COMMUNICATIONS AND INFORMATION TECHNOLOGY DIRECTORATE GENERAL OF POSTS AND TELECOMMUNICATIONS REPUBLIC OF INDONESIA	
SERTIFIKAT CERTIFICATE No. 071378/POSTEL/2009			
Referensi / Reference:	PERKULIAHAN PORTTEL NOMOR : 2340/KULIAH/2009	PLG. ID :	1708
Jenis Alat/Peralatan / Name of Equipment:	Remote Control	Dijukan oleh / Presented by:	CalsonicKansai, Corp.
Buatan / Made in:	France	Alamat / Address:	2-887 Minato-ku, Kitaku, Saitama-shi, Saitama-ken 330-8501, Japan
Merah / Product of:	NISSAN	Tanggal Terbit / Date of Issue:	09 OCT 2009
MODEL/TYPE:	Immobilizer System for Vehicles / MB 054		
Keterangan / Note:	Frekuensi Radio : 433.92 MHz - 433.92 MHz Daya Transmisi : $\leq 10\text{ mW}$ Daya Puncak : $\leq 10\text{ mW}$ Sifat Radiasi : Radiasi Medan Elektromagnetik Frekuensi Radio Untuk Keperluan Sistem Kendali Remotif (RCS)		
A. N. DIREKTUR JENDERAL POS DAN TELEKOMUNIKASI DIRECTOR GENERAL OF POST AND TELECOMMUNICATIONS REPUBLIK INDONESIA REPUBLIC OF INDONESIA			
			FR.PK.1

JVT0203X

Remote keyless entry system (if equipped)

KEMENTERIAN KOMUNIKASI DAN INFORMATIKA DIREKTORAT JENDERAL POS DAN TELEKOMUNIKASI REPUBLIK INDONESIA		THE MINISTRY OF COMMUNICATIONS AND INFORMATION TECHNOLOGY DIRECTORATE GENERAL OF POST AND TELECOMMUNICATIONS THE REPUBLIC OF INDONESIA	
SERTIFIKAT CERTIFICATE No. 14854/R/POSTEL/2010			
Referensi / Reference:	PERKULIAHAN PORTTEL NOMOR : 2340/KULIAH/2009	PLG. ID / Client's ID:	3620
Jenis Alat/Peralatan / Name of Equipment:	Perangkat Daya Rendah	Dijukan oleh / Presented by:	ALPS ELECTRIC CO., LTD. Automotive Product Division
Buatan / Made in:	JAPAN	Alamat / Address:	6-3-36 Nakazato, Funakoshi, Osaka-city, Miyagi-pref Japan
Model / Trade Mark:	NISSAN	Tanggal Terbit / Date of Issue:	23 Agustus 2010
MODEL/TYPE:	Remote Keyless Entry / TRIMUTER	Masa Berlaku / Valid Until:	23 April 2013
Referensi / Reference:	0.003 MHz - 4.000 MHz	Daya Transmisi / Output Power:	$\leq 10\text{ mW}$
A. N. DIREKTUR JENDERAL POS DAN TELEKOMUNIKASI DIRECTOR GENERAL OF POST AND TELECOMMUNICATIONS REPUBLIK INDONESIA REPUBLIC OF INDONESIA			
			JVT0204X

Intelligent Key system (if equipped)



KEMENTERIAN KOMUNIKASI DAN INFORMATIKA
DIREKTORAT JENDERAL SUMBER DAYA DAN PERANGKAT POS DAN INFORMATIKA
PERANGKAT POS DAN INFORMATIKA
THE REPUBLIC OF INDONESIA

THE MINISTRY OF COMMUNICATIONS AND INFORMATION TECHNOLOGY
DIRECTORATE GENERAL OF RESOURCES AND EQUIPMENT
FOR POST AND INFORMATION TECHNOLOGY
THE REPUBLIC OF INDONESIA

SERTIFIKAT | CERTIFICATE

No. 20796SDPP12011

Referensi / Reference	PERANGKAT POSTEL NEMAKAL_2348KUNEN006	PLG ID / Client ID	2425
Nama Perangkat / Name of Equipment	Passive Entry System	Dipakai oleh / Proposed by	ALPS ELECTRIC CO., LTD. Automotive Product Division
Buat / Made in	JAPAN	Alamat / Address	8-2-10 Sakurazaki, Fukuoka, Daikoku-city, Minami-ku, Fukuoka, Fukuoka, 815-0811, Jepang
Model / Model	NISSAN	Tanggal Terbit / Date of Issue	15 September 2011
MODEL/TYPE	TMB02770	Masa Berlaku / Validity	15 September 2014
Frekuensi Operasi / Operating Frequency	270 MHz - 960 MHz		
Daya Rata-rata / Average Power	< 10 mWatt		

A.N. DIREKTUR, JENDERAL SUMBER DAYA DAN PERANGKAT POS DAN INFORMATIKA
DIREKTUR STANDARISASI
FOR DIRECTOR GENERAL OF RESOURCES AND EQUIPMENT FOR POST AND INFORMATION TECHNOLOGY
DIRECTOR OF STANDARDIZATION



MALIK ABULLAH

JVT0205X

FOR THAILAND

This telecommunication equipment conforms to NTC technical requirement.

- Remote keyless entry system (if equipped)
- Intelligent Key system (if equipped)
- NISSAN Anti-Theft System (NATS) (if equipped)

MEMO

MEMO

10 Index

A

ABS (Anti-lock Braking System)	5-17
Adjusting time	2-17
Air bag system	
Supplemental front-impact air bag system	1-22, 1-26
Air bag warning label	1-23
Air cleaner filter	8-14
Air conditioner	
Air conditioner service	4-4
Air conditioner specification label	9-7
Air conditioner system refrigerant and lubricant	9-3
Air conditioning system refrigerant and lubricant recommendations	4-4
Aluminum alloy wheels	7-3
Antenna	4-5
Anti-lock Braking System (ABS)	5-17
Anti-lock Braking System (ABS) warning light	2-9
Appearance care	
Exterior appearance care	7-2
Interior appearance care	7-3
Armrest	1-4
Ashtray	2-17
Ashtrays and cigarette lighter	2-17
Audible reminders	2-12
Audio operation precautions	4-4
Automatic	
Automatic Transmission Fluid	8-13
Driving with Automatic Transmission	5-7
Automatic Transmission (AT)/Continuously Variable Transmission (CVT)	5-5
Automatic Transmission position indicator/Continuously Variable Transmission position indicator	2-7

B

Back door	3-15
Battery	
Battery	5-19, 8-3, 8-17
Battery saver system	2-13, 2-22
Intelligent Key battery	8-19
Remote controller battery	8-18
Vehicle battery	8-17
Before starting engine	5-2
Belts (See drive belts)	8-10
Blocking wheels	6-3
Brake	
Brake and clutch fluid	8-12
Brake booster	8-12
Brake precautions	5-17
Brake system	5-17
Brakes	8-11
Checking foot brake pedal	8-11
Checking parking brake	8-11
Parking brake	3-19, 5-19
Warning light	2-9
Brake assist	5-17
Break-in schedule	5-2
Bulb replacement	8-2, 8-21

C

Car phone or CB radio	4-6
Card holder	2-18
Care when driving	5-4
Cargo cover	2-19
Catalytic converter, Three way catalyst	5-3
Center mark on seat belts	1-15
Center ventilators	4-2
Changing	
Changing engine coolant	8-8
Changing engine oil and oil filter	8-9
Changing tires and wheels	8-26
Charge warning light	2-9

Checking	
Checking bulbs	2-9
Checking engine coolant level	8-8
Checking engine oil level	8-8
Checking fluid level	8-13
Checking foot brake pedal	8-11
Checking parking brake	8-11
Child restraints	1-16
Child safety	1-13
Child safety rear door lock	3-5
Chimes, Audible reminders	2-12
Chrome parts	7-3
Cigarette lighter	2-17
Circuit breaker, Fusible link	8-20
Cleaning exterior	7-2
Cleaning interior	7-3
Clock	2-17
Closing back door	3-16
Closing hood	3-15
Clutch fluid	8-12
Cockpit	2-2
Cold weather driving	5-19
Continuously Variable Transmission (CVT) fluid	8-14
Coolant	
Changing engine coolant	8-8
Checking engine coolant level	8-8
Cooler operation	4-3
Corrosion protection	5-19, 7-5
Cover, Cargo cover	2-19
Cup holders	2-18
CVT	
Continuously Variable Transmission (CVT)	5-10

D

Defogger switch	2-15
Dimensions	9-5
Door locks	3-4
Door open warning light	2-10

Drive belts.....	8-10
Driving	
Care when driving.....	5-4
Cold weather driving.....	5-19
Driving in wet conditions.....	5-4
Driving in winter conditions.....	5-4
Driving vehicle.....	5-7
Driving with Automatic Transmission.....	5-7
Driving with Continuously Variable Transmission (CVT).....	5-10
Driving with Manual Transmission (MT).....	5-13
Precautions when starting and driving.....	5-2

E

Electric power steering system.....	5-16
Electric power steering warning light.....	2-10
Engine.....	9-4
Before starting engine.....	5-2
Break-in schedule.....	5-2
Changing engine coolant.....	8-8
Changing engine oil and oil filter.....	8-9
Checking engine coolant level.....	8-8
Checking engine oil level.....	8-8
Engine cold start period.....	5-4
Engine compartment.....	8-20
Engine compartment check locations.....	8-5
Engine cooling system.....	8-7
Engine oil.....	8-8
Engine serial number.....	9-6
Engine specifications.....	9-4
HR15DE engine model.....	8-5
HR16DE engine model.....	8-6
If your vehicle overheats.....	6-8
MR18DE engine model.....	8-7
Spark plugs.....	8-11
Starting engine.....	5-6
Engine coolant temperature gauge.....	2-6
Engine oil pressure warning light.....	2-10
Environmental factors influence rate of corrosion.....	7-5
Exhaust gas (carbon monoxide).....	5-3

Explanation of general maintenance items.....	8-2
Exterior lights.....	8-22

F

Fail-safe.....	5-13
Flat tire.....	6-2
Floor mats.....	7-4
Fluid	
Automatic Transmission Fluid.....	8-13
Brake and clutch fluid.....	8-12
Checking fluid level.....	8-13
Continuously Variable Transmission (CVT) fluid.....	8-14
Engine coolant.....	8-7
Engine oil.....	8-8
Window washer fluid.....	8-4, 8-16
Fog light switch.....	2-14
Freeing trapped vehicle.....	6-10
Front fog lights.....	2-14
Front seats.....	1-2
Fuel	
Fuel filler cap.....	3-17
Fuel filler lid.....	3-16
Fuel gauge.....	2-6
Fuel information.....	9-3
Fuel octane rating.....	9-3
Opening fuel filler lid.....	3-16
Recommended fuel/lubricants and capacities.....	9-2
Fuses.....	8-20
Fusible links.....	8-20

G

Gauge	
Fuel gauge.....	2-6
Meters and gauges.....	2-4
Odometer.....	2-5
Speedometer.....	2-5
Tachometer.....	2-6

General maintenance.....	8-2
Glass.....	7-2, 7-4
Glove box.....	2-18

H

Hazard indicator flasher switch.....	6-2
Head restraints.....	1-9
Headlight	
Bulb replacement.....	8-21
Headlight switch.....	2-13
Headlights.....	8-21
Hood release.....	3-14
Hook, Luggage hook.....	2-20
Horn.....	2-15
HR15DE engine model.....	8-5
HR16DE engine model.....	8-6

I

If your vehicle overheats.....	6-8
Ignition switch	
Ignition switch.....	5-4
Key positions.....	5-6
Impact sensing door lock releasing mechanism.....	3-5
Indicator lights.....	2-11
Injured persons.....	1-14
Inside rearview mirror.....	3-17
Installation of child restraint system.....	1-17
Installing spare tire.....	6-5
Instrument brightness control.....	2-7
Intelligent Key.....	3-2
Intelligent Key battery.....	8-19
Intelligent Key lock warning light.....	2-10
Intelligent Key system.....	3-6, 5-4
Intelligent Key system warning light.....	2-10
Interior lights.....	2-21, 8-22

J

Jump starting..... 6-6

K

Key..... 3-2
 Intelligent Key..... 3-2
 Intelligent Key battery..... 8-19
 Intelligent Key system..... 3-6, 5-4
 Key positions..... 5-6
 Keys..... 3-2
 Locking with key..... 3-3
 Mechanical key..... 3-3
 Remote keyless entry system..... 3-5
 Using Intelligent Key system..... 3-8
 Using remote keyless entry function..... 3-10
 Using remote keyless entry system..... 3-5

L

Labels
 Air conditioner specification label..... 9-7
 Engine serial number..... 9-6
 Vehicle identification number (VIN)..... 9-6

Light
 Ashtrays and cigarette lighter..... 2-17
 Bulb replacement..... 8-2, 8-21
 Exterior lights..... 8-22
 Fog light switch..... 2-14
 Front fog lights..... 2-14
 Headlight switch..... 2-13
 Headlights..... 8-21
 Indicator lights..... 2-11
 Interior lights..... 2-21, 8-22
 Light locations..... 8-23
 Lights..... 8-21
 Replacement..... 8-2, 8-21
 Room light..... 2-21
 Warning lights..... 2-9
 Warning lights and audible reminders..... 3-10

Warning/indicator lights and audible reminders..... 2-8
 Loading luggage..... 5-4
 Lock
 Anti-lock Braking System (ABS)..... 5-17
 Back door..... 3-15
 Child safety rear door lock..... 3-5
 Door locks..... 3-4
 Locking with inside lock knob..... 3-4
 Locking with key..... 3-3
 Locking with power door lock switch..... 3-4
 Steering lock..... 5-6
 Vehicle speed sensing door lock mechanism..... 3-4
 Low fuel warning light..... 2-11
 Luggage area floor box..... 2-20
 Luggage hooks..... 2-20

M

Maintenance
 Battery..... 8-3, 8-17
 Explanation of general maintenance items..... 8-2
 General maintenance..... 8-2
 Maintenance precautions..... 8-4
 Maintenance requirements..... 8-2
 Scheduled maintenance..... 8-2
 Seat belt maintenance..... 1-15
 Malfunction indicator light (MIL)..... 2-11
 Manual Transmission (MT)..... 5-13
 Mechanical key..... 3-3
 Meters and gauges..... 2-4
 Mirror
 Inside rearview mirror..... 3-17
 Mirrors..... 3-17
 Outside rearview mirrors..... 3-18
 Vanity mirrors..... 3-18
 Most common factors contributing to vehicle corrosion..... 7-5
 MR18DE engine model..... 8-7

N

New vehicle break-in..... 5-2
 NISSAN Anti-Theft System (NATS)..... 3-13

O

Odometer..... 2-5
 Oil
 Changing engine oil and oil filter..... 8-9
 Checking engine oil level..... 8-8
 Engine oil..... 8-8
 Opening back door..... 3-16
 Opening fuel filler lid..... 3-16
 Opening hood..... 3-15
 Operating range..... 3-8
 Outside rearview mirrors..... 3-18
 Overdrive switch..... 5-9
 Overheat
 If your vehicle overheats..... 6-8

P

Panic alarm..... 3-6, 3-10
 Parking
 Brake break-in..... 5-17
 Checking parking brake..... 8-11
 Parking..... 5-15
 Parking brake..... 3-19, 5-19
 Passenger compartment..... 8-21
 Phone
 Car phone or CB radio..... 4-6
 Platinum-tipped spark plugs..... 8-11
 Power
 Electric power steering system..... 5-16
 Locking with power door lock switch..... 3-4
 Power windows..... 2-16
 Precautions
 Audio operation..... 4-4
 Brake precautions..... 5-17
 Maintenance precautions..... 8-4

Precautions on child restraints usage.....	1-16
Precautions on seat belt usage.....	1-11
Precautions on Supplemental Restraint System.....	1-22
Precautions when starting and driving.....	5-2
Safety precautions.....	4-2
Seat belt usage.....	1-11
Towing precautions.....	6-9
When starting and driving.....	5-2
Pregnant women.....	1-14
Preparing tools and spare tire.....	6-3
Pre-tensioner seat belt system.....	1-23, 1-27
Protect environment.....	8-10
Push starting.....	6-8

R

Radio	
Car phone or CB radio.....	4-6
Radio approval number and information.....	9-7
Rear window wiper and washer switch.....	2-14
Rear window wiper blade.....	8-16
Recommended fuel/lubricants and capacities.....	9-2
Recommended SAE viscosity number.....	9-3
Remote controller battery.....	8-18
Remote keyless entry system.....	3-5
Removing spots.....	7-2
Removing tire.....	6-4
Repair and replacement procedure.....	1-28
Roof rail.....	2-20
Room light.....	2-21

S

Safety	
Child safety.....	1-13
Child safety rear door lock.....	3-5
Safety precautions.....	4-2
Scheduled maintenance.....	8-2
Seat	
Center mark on seat belts.....	1-15

Front seats.....	1-2
Precautions on seat belt usage.....	1-11
Pre-tensioner seat belt system.....	1-27
Seat arrangements.....	1-4
Seat belt maintenance.....	1-15
Seat belts.....	1-11, 7-4
Seats.....	1-2
Second row seats.....	1-3
Third row seat.....	1-4
Three-point type seat belts.....	1-14
Two-point type seat belts.....	1-15
Seat belt	
Center mark on seat belts.....	1-15
Child safety.....	1-13
Injured persons.....	1-14
Precautions on seat belt usage.....	1-11
Pregnant women.....	1-14
Pre-tensioner seat belt system.....	1-23, 1-27
Seat belt cleaning.....	7-4
Seat belt maintenance.....	1-15
Seat belts.....	1-11, 7-4
Three-point type seat belts.....	1-14
Two-point type seat belts.....	1-15
Second row seats.....	1-3
Security system.....	3-13
Servicing air conditioner.....	4-4
shift lever	
Shift lock release.....	5-9
Shift lock release.....	5-12
Shift lock release, Transmission.....	5-9
Side ventilators.....	4-2
Small light indicator light.....	2-12
Spare tire.....	8-26
Spark plugs.....	8-11
Special winter equipment.....	5-19
Speedometer.....	2-5
SPORT mode switch.....	5-12
Starting	
Before starting engine.....	5-2
Jump starting.....	6-6
Precautions when starting and driving.....	5-2
Push starting.....	6-8

Starting engine.....	5-6
Steering	
Electric power steering system.....	5-16
Steering lock.....	5-6
Steering wheel.....	3-17
Stopping vehicle.....	6-2
Storages.....	2-18
Stowing damaged tire and tools.....	6-6
Sun visors.....	2-21
Supplemental air bag systems.....	1-25
Supplemental front-impact air bag system.....	1-22, 1-26
Supplemental Restraint System (SRS).....	1-22
Supplemental Restraint System (SRS) air bag warning light.....	2-11
Switch	
Defogger switch.....	2-15
Fog light switch.....	2-14
Hazard indicator flasher switch.....	6-2
Headlight switch.....	2-13
Ignition switch.....	5-4
Locking with power door lock switch.....	3-4
Overdrive switch.....	5-9
Power door lock switch.....	3-4
Rear window wiper and washer switch.....	2-14
SPORT mode switch.....	5-12
Turn signal switch.....	2-13
Windshield wiper and washer switch.....	2-14

T

Tachometer.....system.....	2-6
Theft warning system.....	3-13
Third row seat.....	1-4
Three-point type seat belts.....	1-14
Three-way catalyst.....	5-3
Tilting steering wheel.....	3-17
Tire	
Changing tires and wheels.....	8-26
Flat tire.....	6-2
Installing spare tire.....	6-5
Preparing tools and spare tire.....	6-3

Removing tire.....	6-4
Spare tire.....	8-26
Stowing damaged tire and tools.....	6-6
Tire age.....	8-26
Tire chains.....	8-25
Tire equipment.....	5-19
Tire inflation pressure.....	8-24
Tire placard.....	9-7
Tire rotation.....	8-3, 8-25
Tire wear and damage.....	8-25
Tires and wheels.....	8-24, 9-5
Types of tires.....	8-24
To protect your vehicle from corrosion.....	7-5
Towing	
Towing precautions.....	6-9
Towing your vehicle.....	6-9
Trailer towing.....	5-16
Transmission	
Automatic Transmission Fluid.....	8-13
Continuously Variable Transmission (CVT) fluid.....	8-14
Driving with Automatic Transmission.....	5-7
Driving with Continuously Variable Transmission (CVT).....	5-10
Driving with Manual Transmission (MT).....	5-13
Transmission shift lever lock release.....	5-9
Trip computer.....	2-5
Turn signal switch.....	2-13
Two-point type seat belts.....	1-15
Types of tires.....	8-24

U

Underbody.....	7-3
Using Intelligent Key system.....	3-8
Using remote keyless entry function.....	3-10
Using remote keyless entry system.....	3-5

V

Vanity mirrors.....	3-18
Vehicle	
Dimensions.....	9-5
Identification number (VIN).....	9-6
Speed sensing door lock mechanism.....	3-4
Vehicle battery.....	8-17
Vehicle identification	
Vehicle identification.....	9-6
Vehicle identification number.....	9-6
Vehicle identification plate.....	9-6
Vehicle information display.....	2-4
Vehicle security.....	5-18
Ventilators.....	4-2

W

Warning	
Theft warning system.....	3-13
Warning lights.....	2-9
Warning lights and audible reminders.....	3-10
Warning/indicator lights and audible reminders.....	2-8
Warning light	
Anti-lock Braking System (ABS) warning light.....	2-9
Brake warning light.....	2-9
Charge warning light.....	2-9
Door open warning light.....	2-10
Electric power steering warning light.....	2-10
Engine oil pressure warning light.....	2-10
Intelligent Key lock warning light.....	2-10
Intelligent Key system warning light.....	2-10
Low fuel warning light.....	2-11
Supplemental Restraint System (SRS) air bag warning light.....	2-11
Washer switch	
Rear window wiper and washer switch.....	2-14
Windshield wiper and washer switch.....	2-14
Washing.....	7-2

Waxing.....	7-2
Wheel	
Aluminum alloy wheels.....	7-3
Changing tires and wheels.....	8-26
Tires and wheels.....	8-24, 9-5
Wheel balance.....	8-26
Wheels.....	7-3
When travelling or registering in another country.....	9-6
Where to go for service.....	8-2
Window	
Cleaning.....	7-2, 7-4
Power windows.....	2-16
Windows.....	2-16
Window washer fluid.....	8-4, 8-16
Windshield wiper and washer switch.....	2-14
Windshield wiper blades.....	8-15
Wiper	
Rear window wiper and washer switch.....	2-14
Rear window wiper blade.....	8-16
Windshield wiper and washer switch.....	2-14
Windshield wiper blades.....	8-15
Wiper blades.....	8-15

GAS STATION INFORMATION

FUEL INFORMATION

Model with three-way catalyst



CAUTION:

Do not use leaded gasoline. Using leaded gasoline will damage the three-way catalyst.

Except for Thailand:

Use UNLEADED REGULAR gasoline with an octane rating of at least 91 (RON).

For Thailand:

Use UNLEADED PREMIUM gasoline or gasohol (up to E20*) with an octane rating of at least 95 (RON).

If unleaded premium gasoline is not used, UNLEADED REGULAR gasoline with an octane rating of at least 91 (RON) may be used at slightly reduced performance. However, for maximum vehicle performance and the best driveability, the use of unleaded premium gasoline is recommended.

*: Gasohol is alcohol blended gasoline. For example, "E20" is a mixture of approximately 20% fuel ethanol and 80% unleaded gasoline.

RECOMMENDED ENGINE OIL

See "Recommended fuel/lubricants and capacities" (P.9-2).

- Genuine NISSAN engine oil
- API grade: SL, SM or SN
- ILSAC grade: GF-3, GF-4 or GF-5

QUICK REFERENCE

TIRE COLD PRESSURE

See the tire placard affixed to the driver's side center pillar.

- In case of emergency ... (P.6-1)
(Flat tire, engine will not start, overheating, towing)
- How to start the engine ... (P.5-1)
- How to read the meters and gauges ... (P.2-1)
- Maintenance and do-it-yourself ... (P.8-1)
- Technical information ... (P.9-1)